

Panasonic

Cordless Phone with Answering System

KX-T4310-B/KX-T4310-W

Model No. KX-T4310D-B/KX-T4310D-W

Pulse-or-tone dialing capability

Operating Instructions



KX-T4310D-W

PLEASE READ BEFORE USE AND SAVE.

Charge the battery for 10 hours before initial use.

Getting Started

Cordless Telephone

Answering System

Useful Information

Before Initial Use

Please read **IMPORTANT SAFETY INSTRUCTIONS** on pages 52–53 before use. Read and understand all instructions.

Thank you for purchasing the Panasonic cordless telephone with answering system.

Attach your purchase receipt here.

Serial No.

(found on the bottom of the unit)

Date of purchase

Name of dealer

Dealer's address

Accessories

AC Adaptor (p. 10)

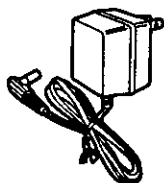

one

Telephone Line Cord (p. 10)



one

Wall Mounting Adaptor (p. 19)

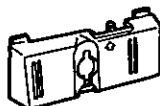

one

Incoming Message Tape (MC-30) (p. 9)

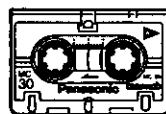

one

•To order accessories, call 1-800-332-5368.

For Best Performance

Battery Charge

To power the handset, charge the battery for **10 hours** before initial use (p. 11).

The battery is beneath this cover.

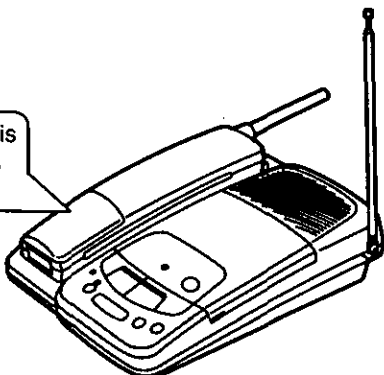

Operating Distance/Noise

Calls are transmitted between the base unit and the handset using wireless radio waves. **For maximum distance and noise free operation**, the recommended base unit placement is:

Away from electrical appliances such as a TV, radio, or personal computer.

In a **HIGH and CENTRAL** location with no obstructions such as walls.

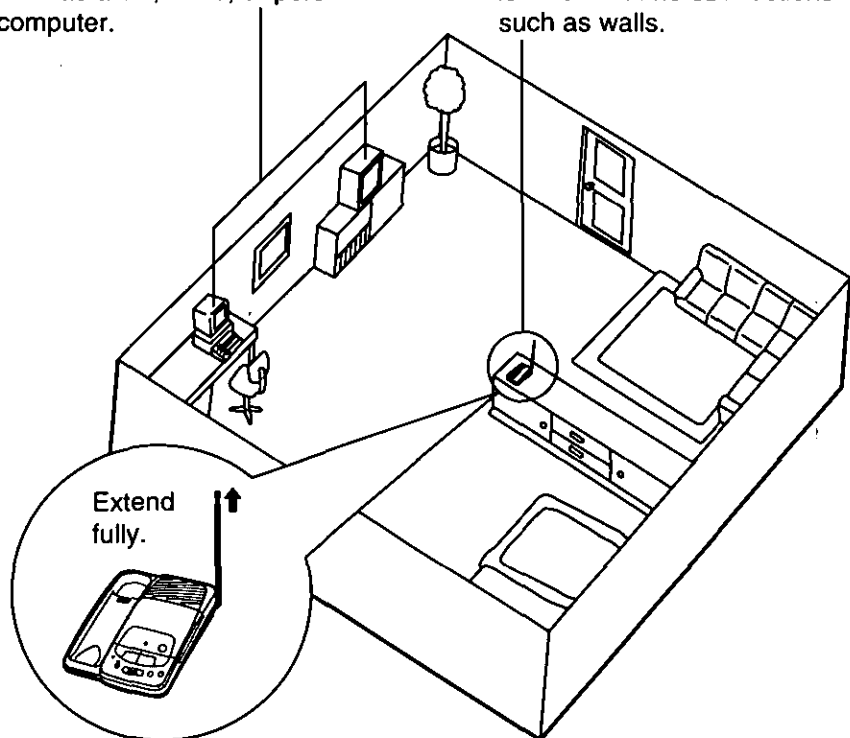

Contents

Getting Started

Location of Controls	6
Setting Up	9
Inserting the Incoming Message Tape	9
Connection	10
Battery Charge	11
Recording a Greeting Message	12
Programmable Preparations	14
Selecting the Number of Rings	15
Selecting the Caller's Recording Time	16
Setting the CPC (Calling Party Control) Function	17
Setting the Greeting Monitor Function	18
Wall Mounting	19

Cordless Telephone

Making Calls	20
Answering Calls	21
Automatic Dialing	22
Storing Phone Numbers in Memory	22
Dialing a Stored Number	23
Intercom	24
Special Features	26
Automatic Security Code Setting	26
For Call Waiting Service Users	26
Temporary Tone Dialing	26
If Your Unit is Connected to a PBX	26

Answering System

Automatic Answering Operation	27
Setting the Unit to Answer Calls	27
Listening to the Recorded Messages	28
Listening to New Messages	29
Listening to All the (saved) Messages	29
Resetting the Tape	30
Erasing All the Incoming Messages	30
Saving the Specific Messages	30
Recording a Memo Message	31
Pager Call	32
Storing the Pager Number	32
Setting the Unit to Call the Pager	33
Remote Operation from a Touch Tone Phone	34
Setting the Remote Code Number	34
Remote Operation	36
Remote Operation from the Handset	40
Remote Operation	40

Useful Information

Battery Replacement	45
Maintenance of Cassette Tape and Deck	46
Adding Another Phone	48
Before Requesting Help	49
Important Safety Instructions	52
FCC and Other Information	54

Location of Controls

Base unit

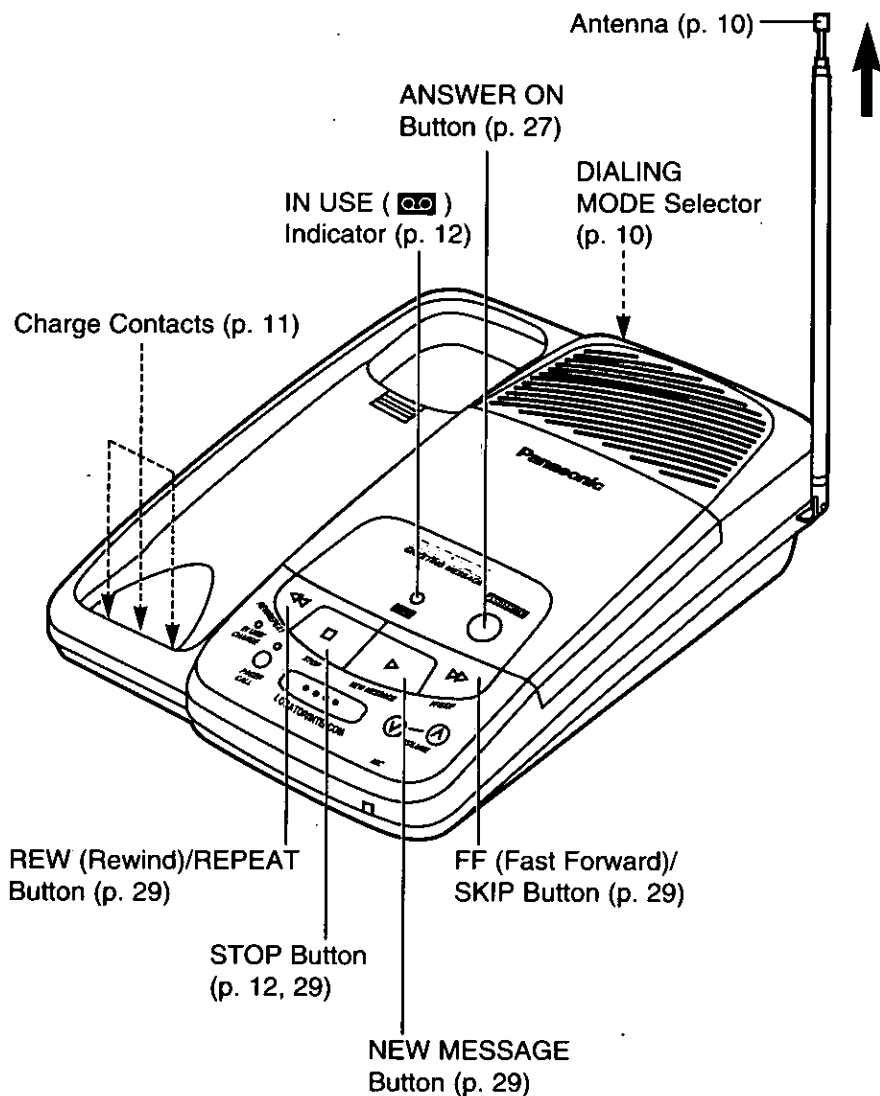

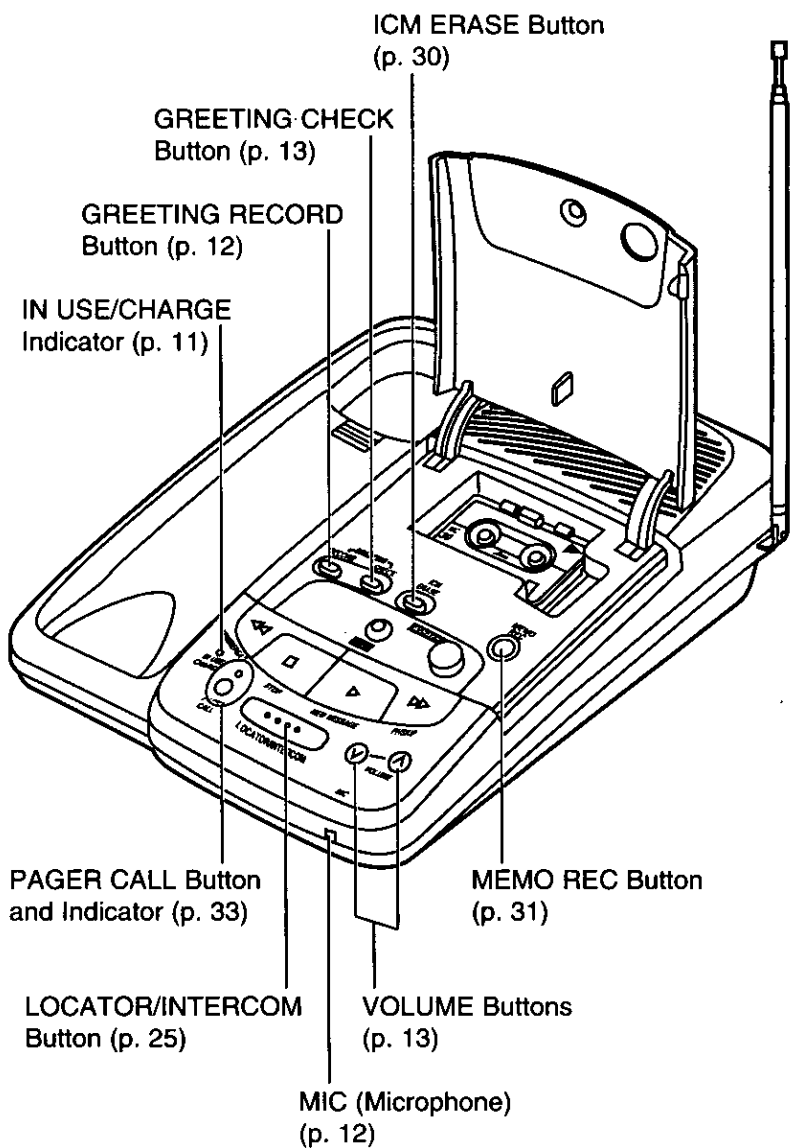



Inserting the Incoming Message Tape

1 Remove the stopper.

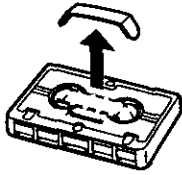

2 Open the cassette panel.

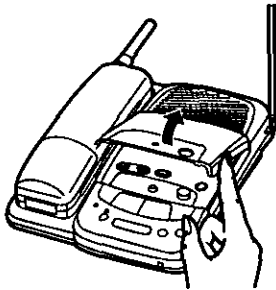

3 Insert the tape with the full reel to the right and the exposed tape facing you.

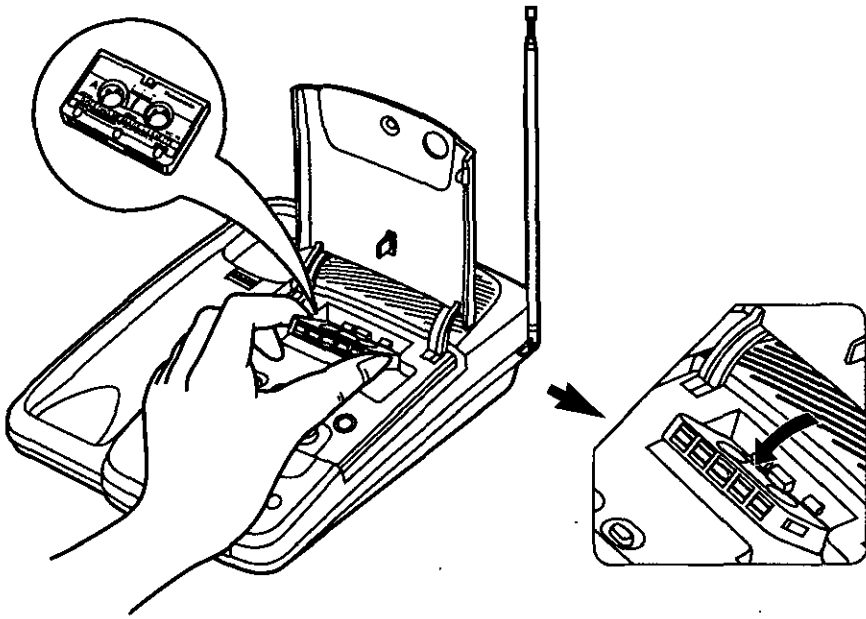

► Setting Up

Connection

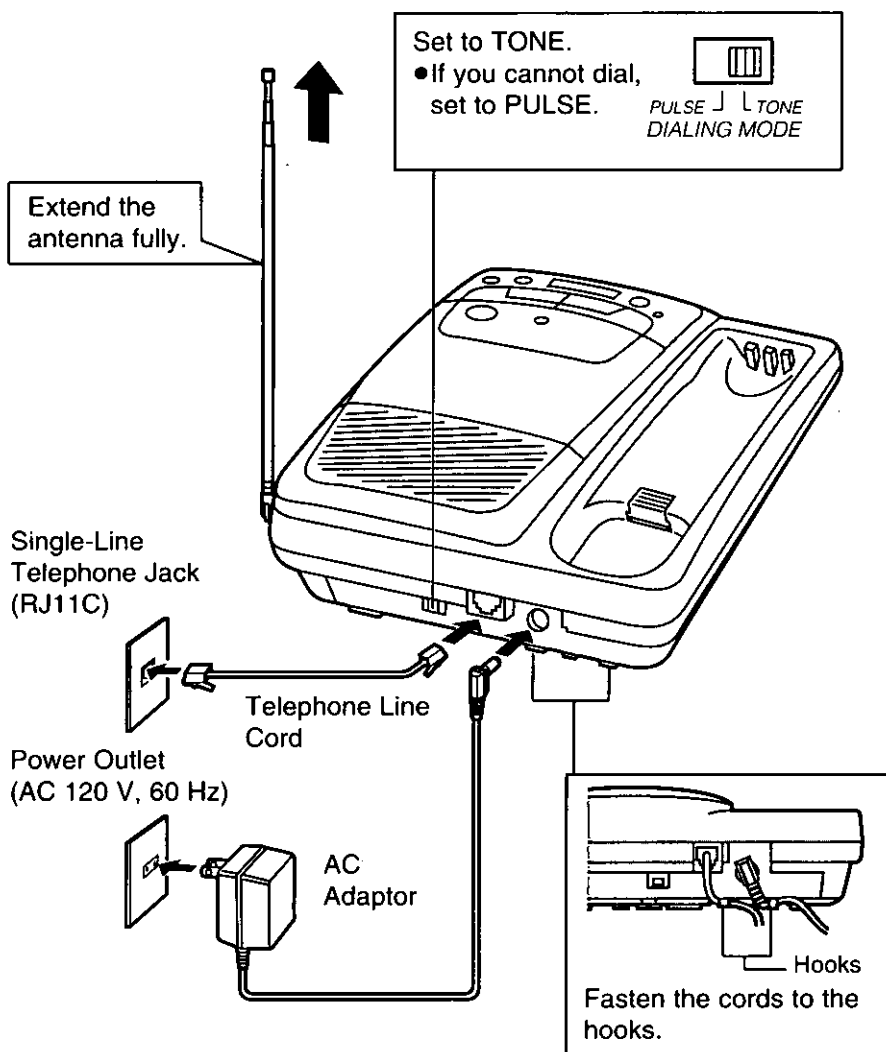

- USE ONLY Panasonic AC ADAPTOR KX-A11.
- The AC adaptor must remain connected at all times.
(It may feel warm during use. This is normal.)

Battery Charge

Place the handset on the base unit for **10 hours**.

- The IN USE/CHARGE indicator lights.

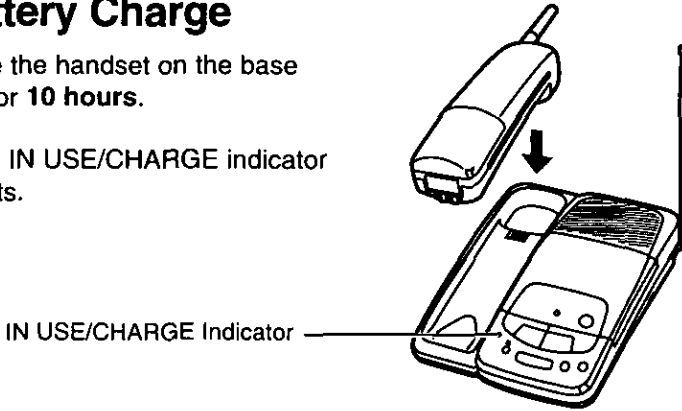

Recharge

When the BATT LOW/PROG indicator flashes or beeps intermittently, recharge the battery.

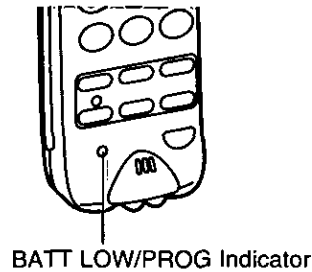

Standard battery life

If your Panasonic battery is fully charged;

While in use (TALK)	Up to about 8 hours
While not in use (Stand-By)	Up to about 30 days

- Battery life may vary depending on usage conditions and ambient temperature.
- The battery cannot be overcharged.
- Clean the charge contacts with a soft cloth once a month**, or the battery may not charge properly.
- Once the battery is fully charged, you do not have to place the handset on the base unit until the BATT LOW/PROG indicator flashes.

► Setting Up

Recording a Greeting Message

- 1 Press **(GREETING RECORD)**, then release it.
 - A long beep sounds.
- 2 Immediately after the long beep speak clearly **up to 16 seconds** and about 20 cm (8") away from **MIC** (microphone).
 - The **IN USE ()** indicator flashes slowly. It flashes quickly after 13 seconds.

- 3 When finished recording, press **(STOP)**.
 - To change the greeting message, repeat from step 1.

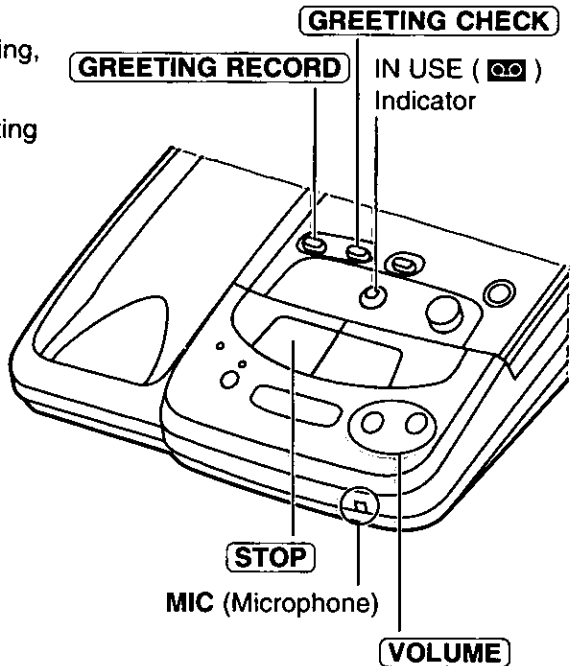

- The greeting message can never be cleared even if a power failure occurs.

To check the greeting message

Press **GREETING CHECK**.

- The recorded greeting is played.
- Adjust the speaker volume using **VOLUME**.
To increase, press \wedge .
To decrease, press \vee .

Sample of a greeting message

"Hello, this is (your name and/or number). Sorry, I cannot take your call. Please leave your message after the long beep. Thank you."

Programmable Preparations

Summary of programming procedures

See the pages indicated each for detailed procedure.

Make sure that the TALK indicator light is off before programming.

Lift the handset, then press **PROGRAM/2WAY REC**.

Press **SCREEN/PLAYBACK**.

● If an alarm tone sounds, move toward the base unit, then try again.

- **The remote code**, press "1". (page 34)
- **The number of rings**, press "2". (page 15)
- **The CPC function**, press "3". (page 17)
- **The greeting monitor function**, press "4". (page 18)
- **The caller's recording time**, press "5". (page 16)
- **The pager number**, press "#". (page 32)

● If 6 beeps sound, you pressed a wrong key. Try again.

When finished, press **PROGRAM/2WAY REC**.
The confirmation tone sounds.*

● To cancel the programming halfway, press **PROGRAM/2WAY REC**, then restart from the beginning.

*What the confirmation tone means

1 beep: The number is newly stored.

2 beeps: The number is the same as a previously stored one.

To confirm the current setting, repeat the same steps above and listen for the confirmation tone.

Selecting the Number of Rings

You can select the number of rings before your answering system answers a call to "1" through "7" or "AUTO (preset)". (See below.)

- 1 Lift the handset, then press **PROGRAM/2WAY REC**.
 - The BATT LOW/PROG indicator lights.
- 2 Press **SCREEN/PLAYBACK**.
 - The SCREEN/PLAYBACK indicator lights.
- 3 Press "2".
- 4 Press one of "0" through "7" to set the number of rings.
 - 0: "AUTO" is selected. (Toll Saver)
 - 1-7: The unit will answer on the selected number of rings.
- 5 When finished, press **PROGRAM/2WAY REC**.
 - The indicator lights go out.

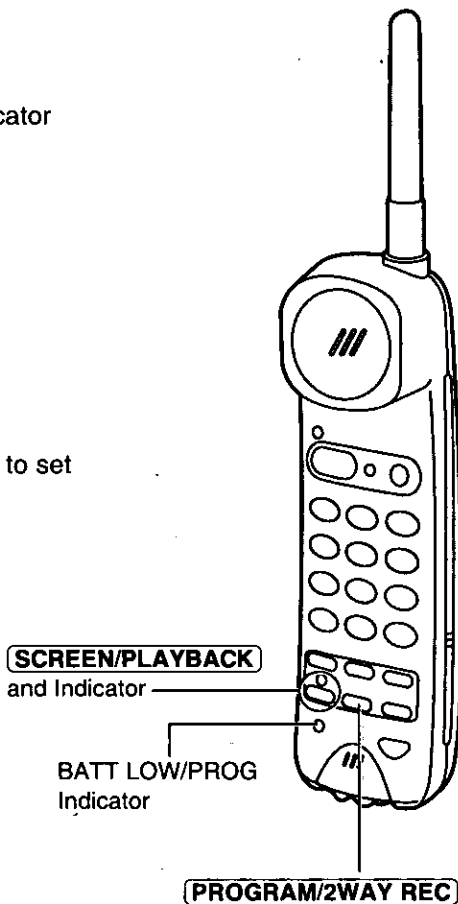

Toll Saver (When set to "AUTO"):

When you call the unit from a touch tone telephone,

- If the unit answers on the 2nd ring: There is at least one new message.
- If the unit answers on the 4th ring: There are no new messages.

Hang up immediately when you hear the 3rd ring, and you can save on the toll charge.

► Programmable Preparations

Selecting the Caller's Recording Time

You may select the recording time of incoming calls to "unlimited (up to the tape end)" or "1 minute". The factory preset is "unlimited".

1 Lift the handset, then press **PROGRAM/2WAY REC**.

- The BATT LOW/PROG indicator lights.

2 Press **SCREEN/PLAYBACK**.

- The SCREEN/PLAYBACK indicator lights.

3 Press "5".

4 Press "1" or "2" to select the recording time.

- 2: "unlimited" is selected.
- 1: "1 minute" is selected.

5 When finished, press **PROGRAM/2WAY REC**.

- The indicator lights go out.

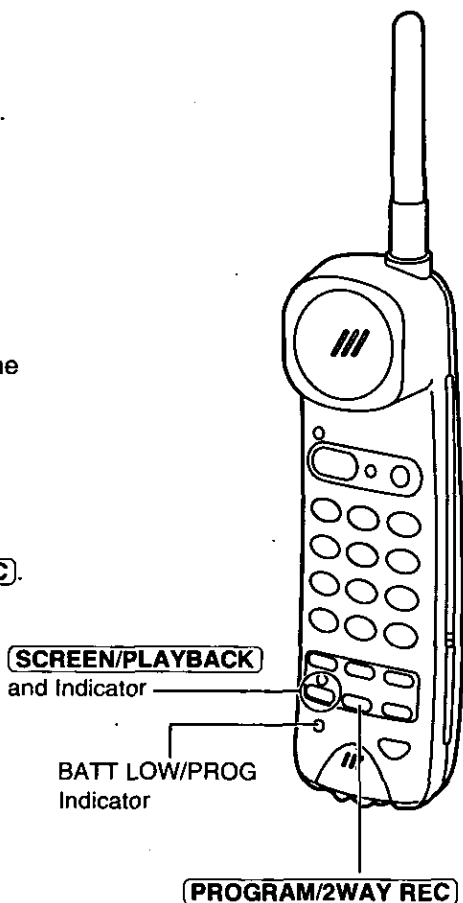

Setting the CPC (Calling Party Control) Function

The CPC function is preset to "A" If you use a call waiting service, set to "B" If set to "A", the call waiting tone will disconnect someone leaving a message

- 1 Lift the handset, then press **PROGRAM/2WAY REC**
 - The BATT LOW/PROG indicator lights
- 2 Press **SCREEN/PLAYBACK**
 - The SCREEN/PLAYBACK indicator lights
- 3 Press "3"
- 4 To select "B", press "2"
OR
To select "A", press "1"
- 5 When finished, press **PROGRAM/2WAY REC**.
 - The indicator lights go out

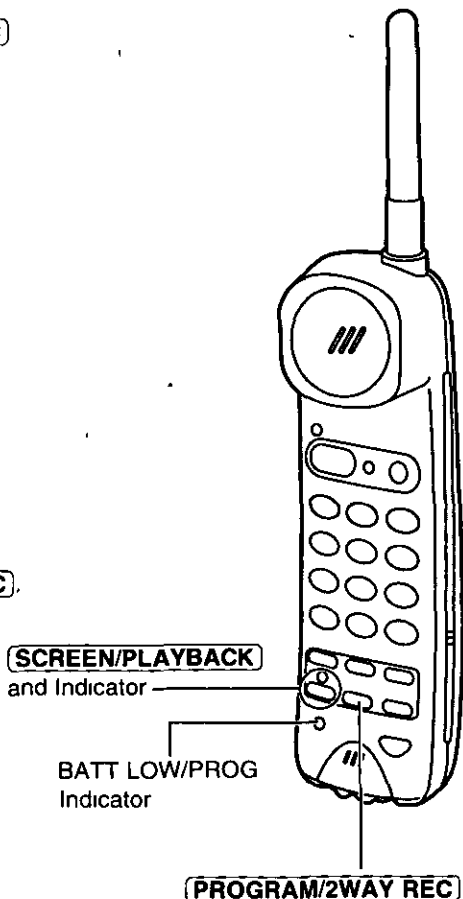

► Programmable Preparations

Setting the Greeting Monitor Function

When the greeting message is played back to the caller, you can also hear it through the speaker. If you want to hear, set to "2 (ON)". The factory preset is "1 (OFF)".

1 Lift the handset, then press **PROGRAM/2WAY REC**.

- The BATT LOW/PROG indicator lights.

2 Press **SCREEN/PLAYBACK**.

- The SCREEN/PLAYBACK indicator lights.

3 Press "4".

4 To set to "2 (ON)", press "2".
OR
To set to "1 (OFF)", press "1".

5 When finished, press **PROGRAM/2WAY REC**.

- The indicator lights go out.

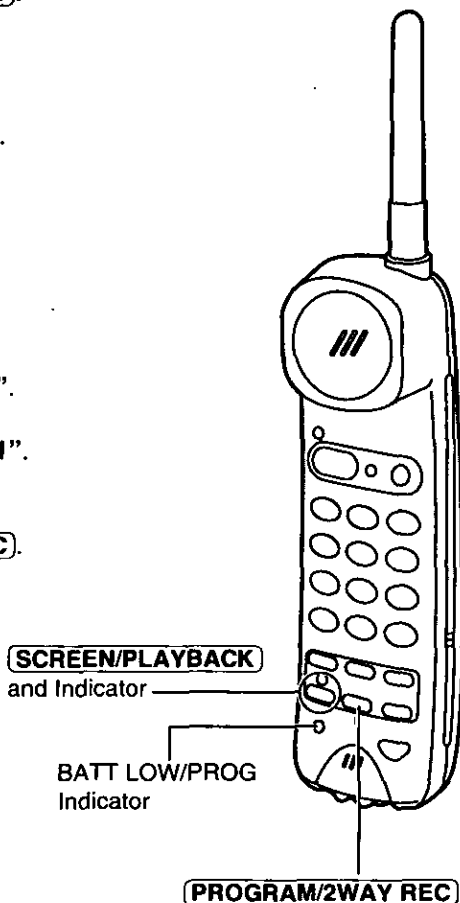

Wall Mounting

This unit can be mounted on a wall phone plate.

- 1** Reverse the handset hook in the cradle so the tab holds the handset.

- ① Push to remove.
- ② Rotate 180°.
- ③ Replace it with the tab upward.

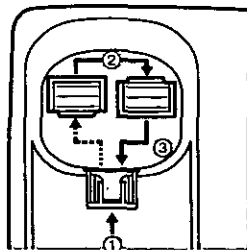

- 2** Connect the AC adaptor. Tuck the telephone line cord inside the wall mounting adaptor, then push it in the direction of the arrow.

- The word "UP" should face upward.

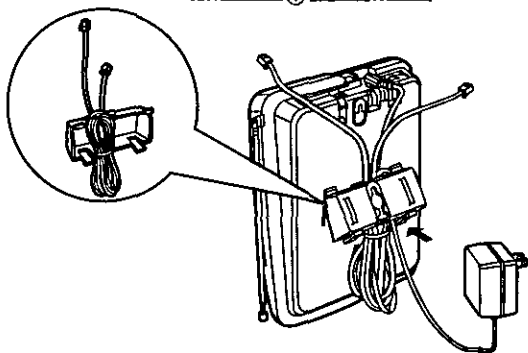

- 3** Connect the telephone line cord. Mount the unit, then slide down.

- Extend the antenna fully.

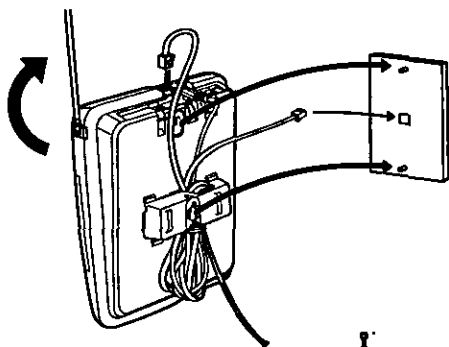

- 4** To charge the battery: Place the handset on the handset hook as shown.

- The IN USE/CHARGE indicator lights.

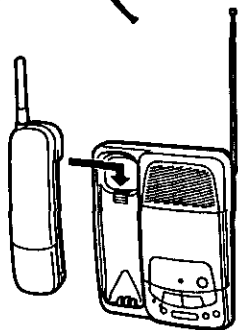

Making Calls

- 1 Press **TALK**.
 - The indicator lights.
- 2 Dial a telephone number.
 - If you misdial, press **FLASH** firmly then dial again.
- 3 To hang up, press **TALK** or place the handset on the base unit.
 - The indicator light goes out.

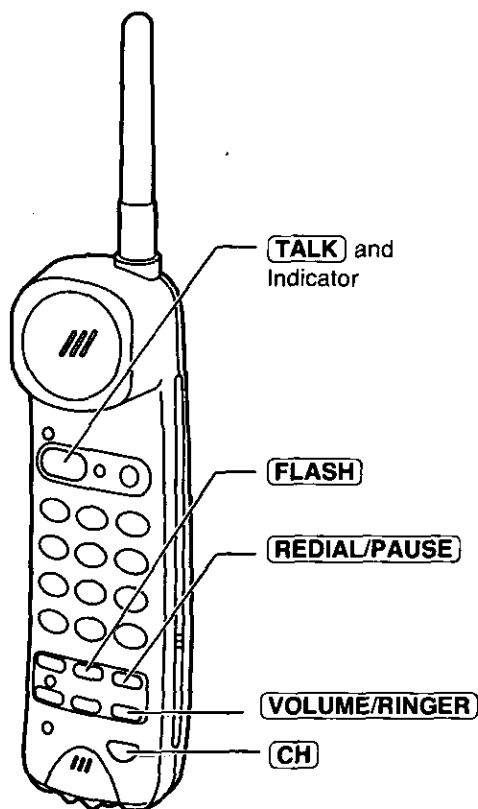

- If alarm tone sounds on step 1, move toward the base unit or place the handset on the base unit. Then try again.

To redial the last number

Press **TALK** ➔ **REDIAL/PAUSE**.

If noise interferes with the conversation

Press **CH** to select a clear channel or move closer to the base unit.

To select the receiver volume HIGH or NORMAL (preset)

Press **VOLUME/RINGER** while speaking.

- Each time you press, the volume level will change.

Answering Calls

If the handset is off the base unit,
press **TALK**.

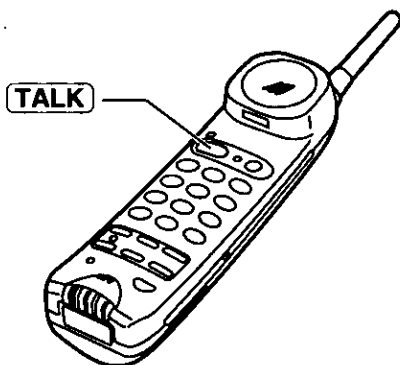

OR

If on the base unit, just lift it.



Any Key Talk

You can also answer the call by pressing any dialing button
(0 to 9, *, or #).

Ringer Volume

Be sure the TALK and INTERCOM indicator lights are off.

To select **HIGH (preset) or LOW**, press **VOLUME/RINGER**.

•Each time you press, the bell sounds and the ringer volume will change.

To turn the ringer **OFF**, while pressing **VOLUME/RINGER** press **0** until
2 beeps sound.

To turn the ringer **ON**, press **VOLUME/RINGER**.

•The ringer sounds at the HIGH level.

Automatic Dialing

Storing Phone Numbers in Memory

The dialing buttons of the handset (0 to 9) function as memory stations. The TALK indicator light must be off.

1 Press **PROGRAM/2WAY REC**.

- The BATT LOW/PROG indicator lights.

2 Enter a phone number up to 16 digits.

- If you misdial, press **PROGRAM/2WAY REC** to end storing, then restart from step 1.

3 Press **AUTO**.

4 Press a memory station number (0 to 9).

- Confirmation tone sounds. (See below.)
- To store other numbers, repeat steps 1 through 4.

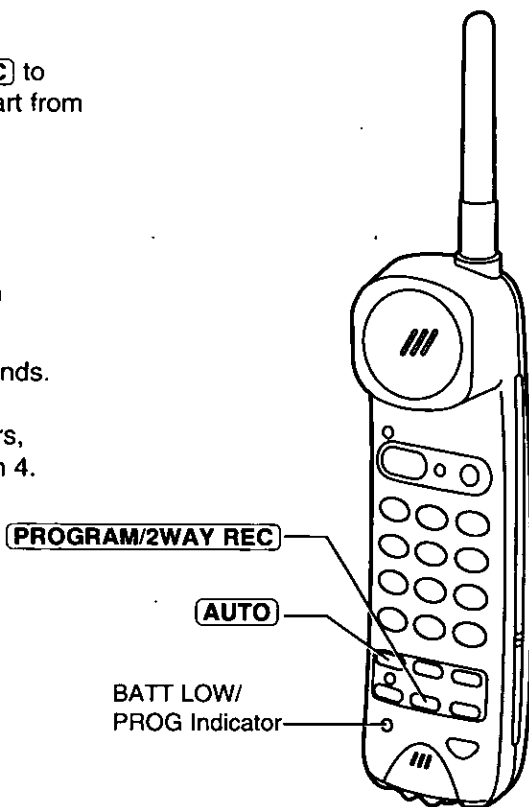

What the confirmation tone means

1 beep: The number is newly stored.

2 beeps: The number is the same as a previously stored one.

To erase a stored number

Press **PROGRAM/2WAY REC** ➡ **AUTO** ➡ the memory station number to be erased.

Memory sticker

You may use an included memory sticker as memorandum for automatic dialing. Write down the names or phone numbers, then attach it to the unit or at a convenient place.

Dialing a Stored Number

- 1 Press **TALK**.
- 2 Press **AUTO**.
- 3 Press the memory station number (0 to 9).
 - The stored number is dialed.

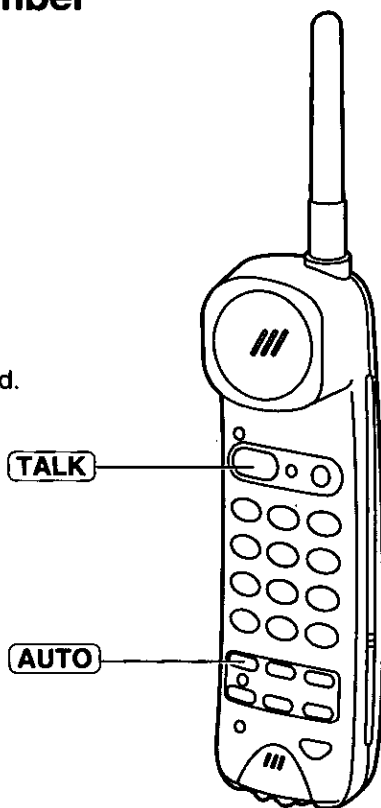

Intercom

2-way intercom is available between the handset and the base unit.

Paging the Base unit from the handset

Handset:

Press **INTERCOM**, then speak.

- To end the intercom, press **INTERCOM**.



Base unit:

When the other party's voice is heard, answer through **MIC**.

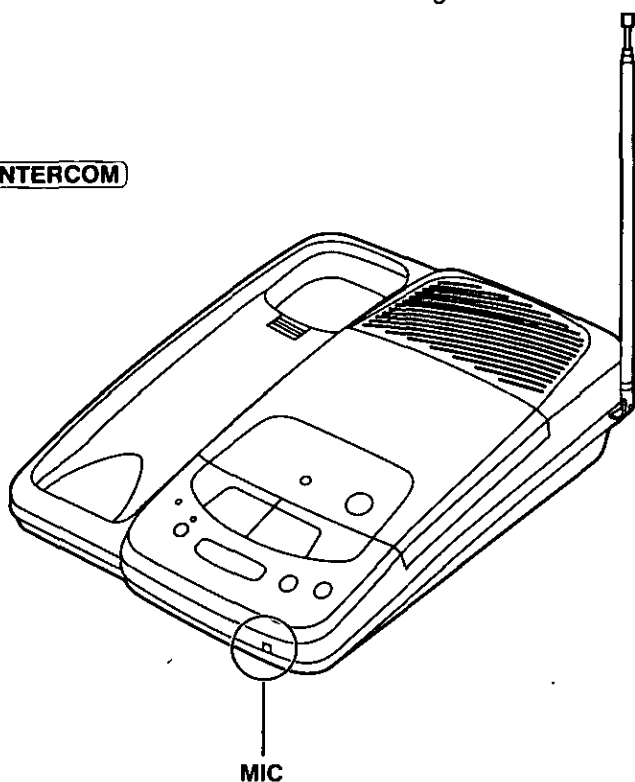

Paging the handset from the base unit (Handset locator)

Using this feature, you can locate the handset if you misplace it.

Base unit:

Press **LOCATOR/INTERCOM**.

- The handset beeps for 1 minute.
- To stop paging, press again.

Speak into **MIC**.

Handset:

Press **INTERCOM** to answer.

- To end the intercom, press **INTERCOM**.

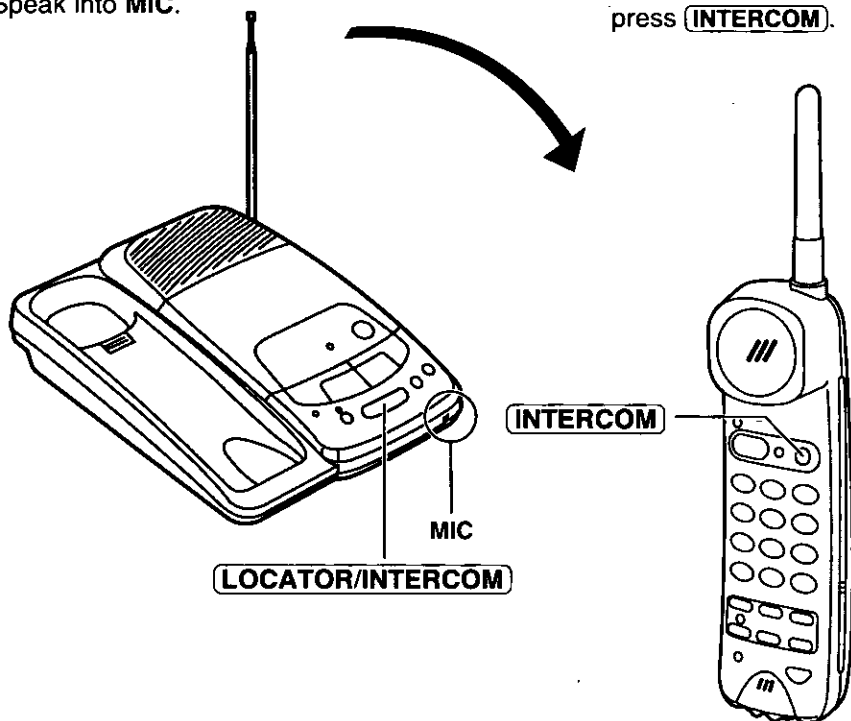

When using the intercom:

- Intercom calls can only be ended with the handset.
- If the handset user has difficulty hearing the base unit user, decrease the speaker volume by pressing **∨**.
- If two tones sound, it means a call is received. To answer it, press **TALK**. The intercom is ended.

Special Features

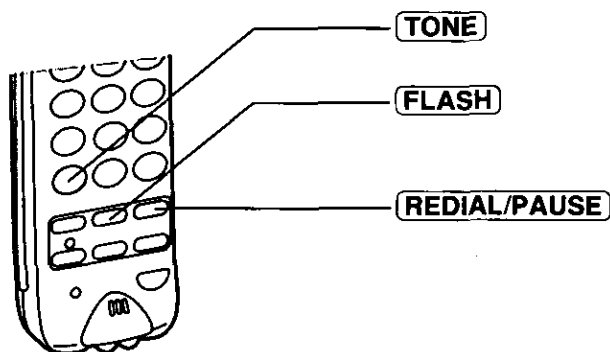

Automatic Security Code Setting

Whenever you place the handset on the base unit, the unit automatically selects one of 65,000 security codes. These codes help to avoid unauthorized use of your telephone line by another cordless telephone.

For Call Waiting Service Users

Press **FLASH** lightly if you hear a call-waiting tone while speaking.

- The first call is put on hold and you can answer the second call.
- To return to the first caller, press **FLASH** again.

Temporary Tone Dialing (For Rotary Service Users)

Press **TONE** before dialing.

- The dialing mode changes to tone. You can enter numbers to access the answering system or electronic banking services, etc. When you hang up, the mode returns to pulse.

If Your Unit is Connected to a PBX

We recommend you press **REDIAL/PAUSE** between the access number for an outside line and the phone number.

- Pressing **REDIAL/PAUSE** once makes a 3.5-second pause and prevents misdialing when you redial or dial a stored number.

Automatic Answering Operation

When a call is received, the unit plays back your greeting message and records the caller's message.

Setting the Unit to Answer Calls

Press **ANSWER ON** to turn on the answering system.

- The button lights.
- To turn off, press **ANSWER ON** again. The button's light goes out.

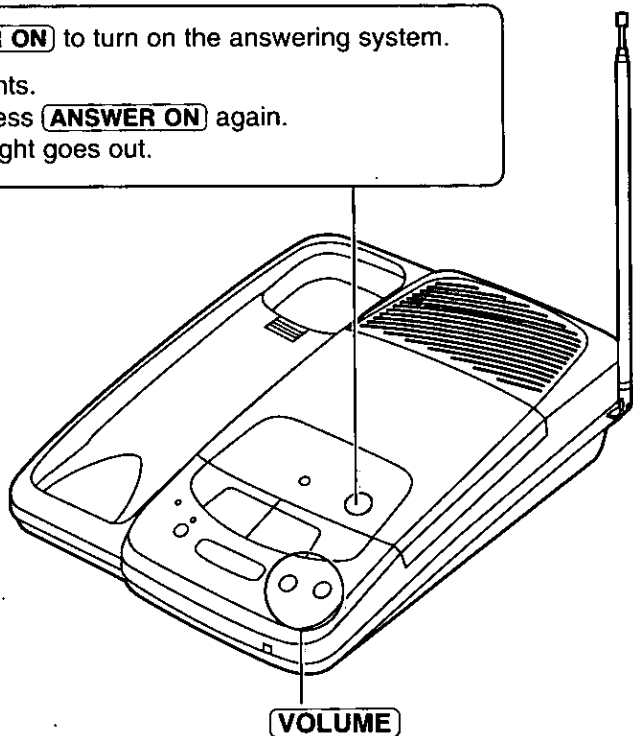

- You can also turn it on remotely with a handset or a touch tone phone. (p. 39, 42)

Monitoring incoming calls

While an incoming call is being recorded, you can monitor it through the speaker. Adjust the volume with **VOLUME**.

To answer the call while monitoring, press **TALK** of the handset.

Listening to the Recorded Messages

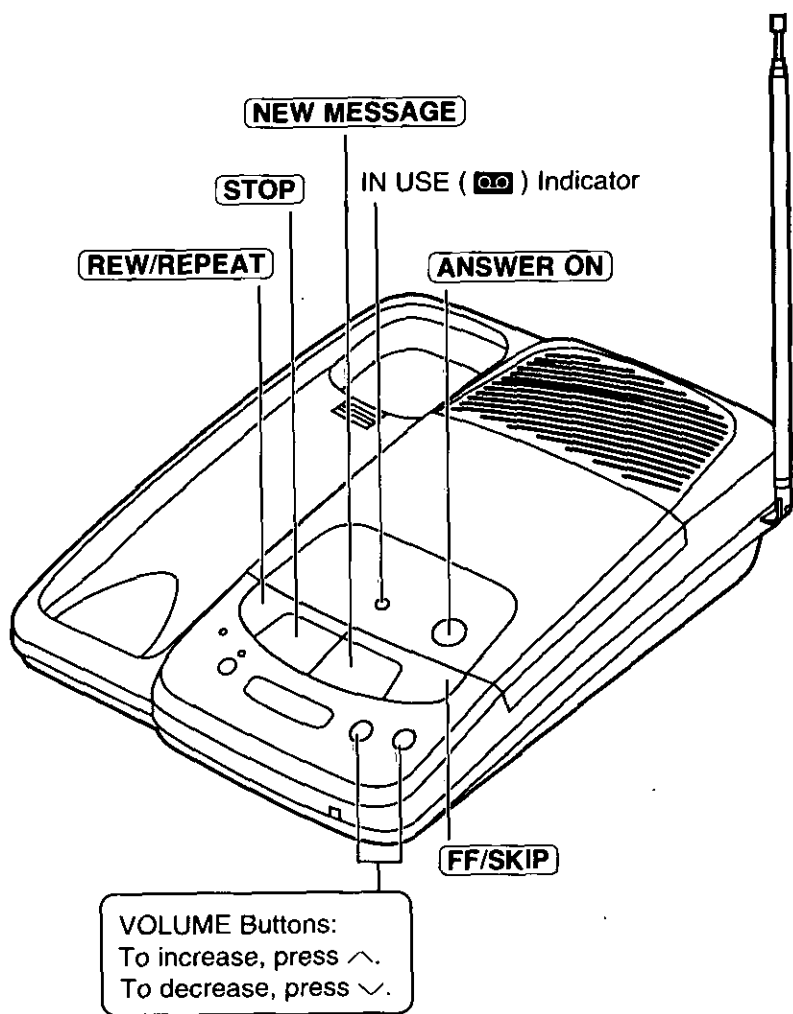

- When the tape becomes full, the IN USE ([]) indicator flashes rapidly. Use the opposite side of the tape or reset the tape (p. 30).
- When new incoming messages have been recorded, **ANSWER ON** flashes up to 15 times indicating the number of new messages.



Listening to New Messages

Only the new messages you have not listened to will be played back.

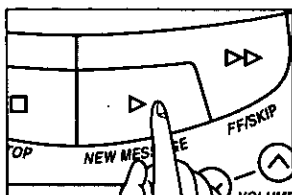

Press **NEW MESSAGE** lightly.

- At the end, 3 beeps sound and the tape stops.

Listening to All the (saved) Messages

All the recorded messages including the reviewed ones can be played back.

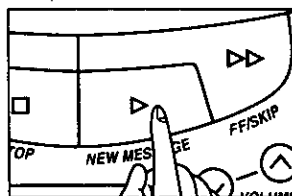

Press **NEW MESSAGE** firmly for more than 1 second.

- At the end, 3 beeps sound and the tape stops.

To repeat the message	Press REW/REPEAT during playback. (If you press within 5 seconds of the playback, the previous message is played.)
To skip the message	Press FF/SKIP during playback. The next message is played.
To stop the operation	Press STOP .

▶ Listening to the Recorded Messages

Resetting the Tape

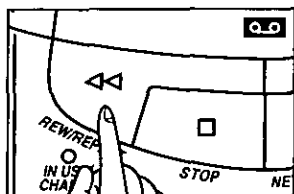

Press **REW/REPEAT** while not in playback.

- The tape is rewound to the beginning and new messages will be recorded over the old ones.

Erasing All the Incoming Messages

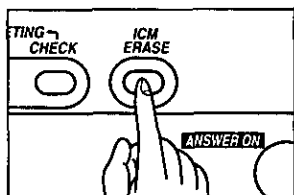

Press **ICM ERASE** after listening to all the recorded messages.

- The unit erases all the recorded messages while the tape rewinds.

Saving the Specific Messages

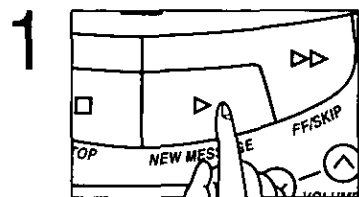

Play back the recorded messages till the end of the message(s) you want to save.

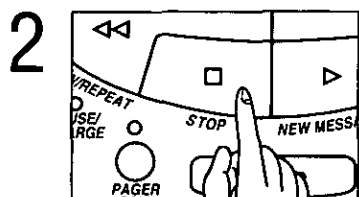

Press **STOP**.

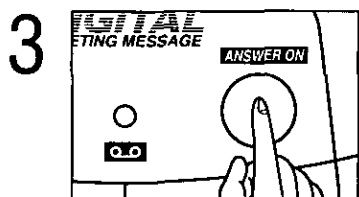

Press **ANSWER ON** to turn the answering system on.

- The button lights and the new messages will be recorded after the saved message(s).

Recording a Memo Message

You may record a personal message.

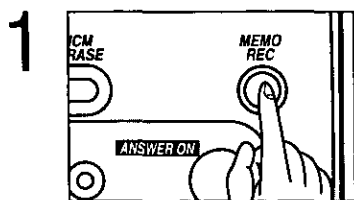

Press **MEMO REC**.

- A long beep sounds.

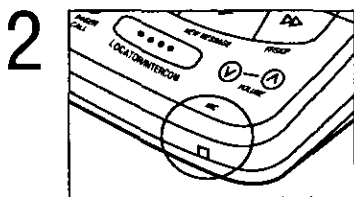

After the beep, speak clearly into **MIC** (microphone).

- The IN USE () indicator flashes.

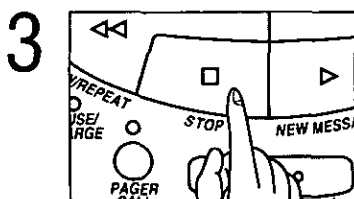

When finished, press **STOP**.

Pager Call

Using this feature the unit informs you that you have received messages by calling your pager. Then you can retrieve the messages by using any touch tone telephone.

Storing the Pager Number

Make sure that the TALK indicator light is off.

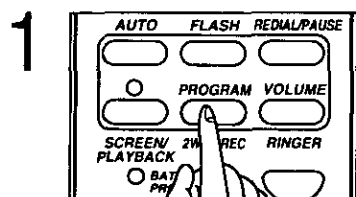

Lift the handset and press **PROGRAM/2WAY REC**.

- The BATT LOW/PROG indicator lights.

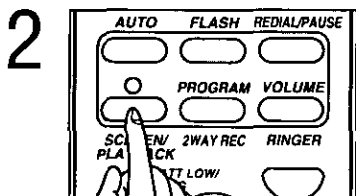

Press **SCREEN/PLAYBACK**.

- The SCREEN/PLAYBACK indicator lights.

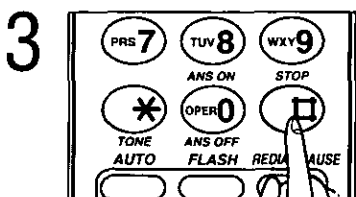

Press "#".

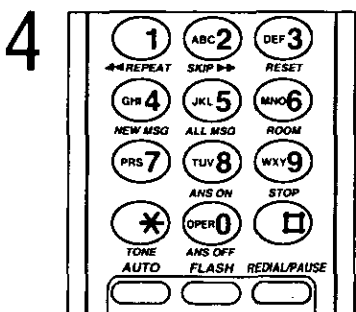

Enter your pager number up to 30 digits.

- If necessary, press **REDIAL/PAUSE** twice*.
- If you misdial, press **PROGRAM/2WAY REC**, then restart from step 1.

* Your pager company may require a delay after the pager number is dialed. Contact the pager company regarding the pause time needed. Each time you press **REDIAL/PAUSE**, it creates a 3.5-second delay.

5

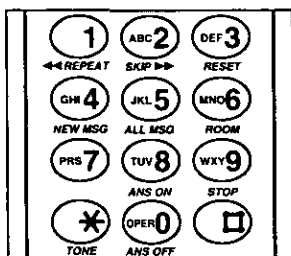

Enter the call back number you want to display on your pager.

(Press # if required by your pager company. Please confirm with your pager company.)

6

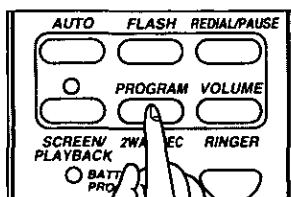

When finished,

press **PROGRAM/2WAY REC**.

To confirm the stored number

Press **TALK** ♦ **AUTO** ♦ **#**.

- The unit dials the stored number and the pager beeps.
- If the pager does not beep, start from step 1.

To erase the pager number

Press **PROGRAM/2WAY REC** ♦ **SCREEN/PLAYBACK** ♦ **#**
♦ **PROGRAM/2WAY REC**.

Setting the Unit to Call the Pager

Make sure that the pager number has already been stored.

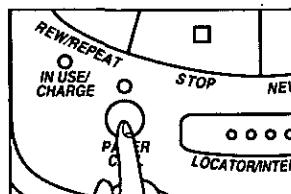

Press **PAGER CALL** to turn on the pager call mode.

- The PAGER CALL indicator lights.
- 6 beeps are heard if the pager number is not stored.
- The unit will call your pager once after about 30 seconds of recording the message.
- To turn off, press **PAGER CALL** again.

Remote Operation from a Touch Tone Phone

You can operate the answering system from a remote touch tone phone.

Setting the Remote Code Number

The remote code prevents unauthorized persons from listening to your messages.

Make sure that the TALK indicator light is off.

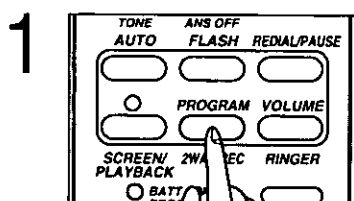

Press **PROGRAM/2WAY REC**.

- The BATT LOW/PROG indicator lights.

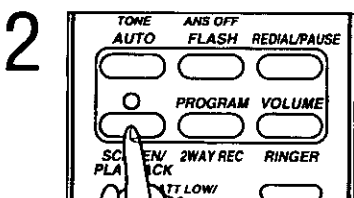

Press **SCREEN/PLAYBACK**.

- The SCREEN/PLAYBACK indicator lights.

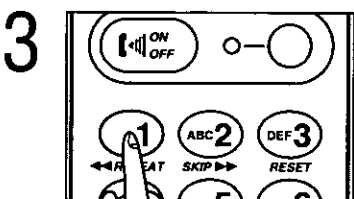

Press "1".

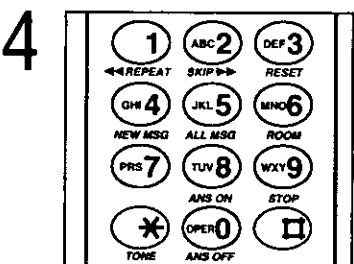

Enter a 2-digit number (00–99) for remote code number.

5

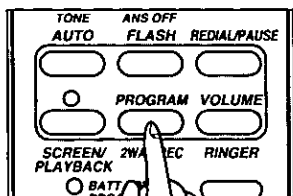

When finished,
press **PROGRAM/2WAY REC**.

- The indicator lights go out.
- Confirmation tone sounds.
(See below.)

What the confirmation tone means

1 beep: The number is newly stored.

2 beeps: The number is same as previously stored one.

To confirm the current setting, repeat the same steps and hear the confirmation tone.

► Remote Operation from a Touch Tone Phone

Remote Operation

- 1 Call your unit from a touch tone telephone.

- 2 Press **the Remote Code Number** during greeting message playback.

 - Short beeps sound up to 8 times, to indicate the number of new messages.
- 3 Enter **the Remote Access Key**.
Refer to the Remote Access Key List on pages 37 and 38.

(Example)
To listen to the new messages, press .
- 4 Hang up. The messages are saved.



Remote Access Key List

NEW MESSAGE
PLAYBACK

4

- Only new messages are played back.
- 3 beeps sound at the end of playback. If you hear 6 long beeps, the incoming message tape is full. Reset the tape.

ALL MESSAGE
PLAYBACK

5

- All the messages are played back.
- 3 beeps sound at the end of playback.
- If you hear 6 long beeps, the incoming message tape is full. Reset the tape.

REPEAT

1

- The current message is repeated from the beginning.

SKIP

2

- The current message is skipped. Playback starts from the next message.

STOP

9

- Playback is stopped temporarily. To resume press **9** again within 15 seconds, or the call will be disconnected.

RESET

3

- Press within 10 seconds after hearing the last message.
- If pressed after all message playback, the tape will rewind to the beginning of the tape.
- If pressed after new message playback, it will rewind to the beginning of the new messages. To rewind to the beginning of the tape press **3** again after the beep.
- To cancel the reset to save the messages, press **2**.

► Remote Operation from a Touch Tone Phone

ROOM SOUND
MONITOR

6

- The sound around the base unit is monitored for 30 seconds.
 - At the end of monitoring a beep sounds. To continue, press **6** again within 10 seconds.
-

GREETING
MESSAGE
RECORDING

7

- A long beep sounds.



RECORD

- Speak immediately after the long beep up to 16 seconds.



9

- The new recorded message is played back.
-

PAGER CALL ON

*

- Pager call feature is turned on.
- If you hear 6 beeps, the pager number is not stored. Store the number using the handset. (p. 32)



7

PAGER CALL OFF

*

- Pager call feature is turned off.



8

ANSWERING
SYSTEM OFF

0

- The answering system is turned off.
-

Skipping the greeting message

Callers can record messages without listening to the greeting.

After calling your unit press **[*]** during the greeting message playback.

- The unit skips the rest of the greeting and starts recording.

Recording your own message (Marker message)

You can record your own message on the tape after listening to the last message.

1. Wait for 3 beeps indicating the end of the last message and another 10 seconds for 2 more beeps. Then leave your message.
2. When finished, hang up.

Turning on the answering system

Call your unit and wait for 15 rings.

- The unit will answer and the greeting message is played.
- Hang up or enter the remote code number for more options.

Remote Operation from the Handset

You can operate your answering system from the handset.

Remote Operation

1 Press **SCREEN/PLAYBACK**.

- The indicator lights.
- Short beeps sound up to 8 times, indicating the number of new messages.

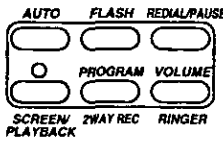

The diagram shows a grid of handset buttons. The top row contains three buttons labeled 'AUTO', 'FLASH', and 'REDIAL/PAUSE'. The middle row contains a small circle icon, a button labeled 'PROGRAM', and a button labeled 'VOLUME'. The bottom row contains three buttons labeled 'SCREEN/PLAYBACK', 'ZWAY REC', and 'RINGER'.



- If the SCREEN/PLAYBACK indicator flashes, the answering system is off. To turn on, see page 42.

2 Enter **the Remote Access Key**.
Refer to the Remote Access Key List on pages 41 and 42.

(Example)
To listen to new messages, press **4**.



3 Press **SCREEN/PLAYBACK** to end the operation.

- The indicator light goes out.

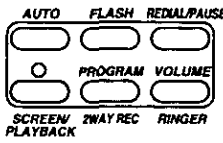

The diagram shows a grid of handset buttons. The top row contains three buttons labeled 'AUTO', 'FLASH', and 'REDIAL/PAUSE'. The middle row contains a small circle icon, a button labeled 'PROGRAM', and a button labeled 'VOLUME'. The bottom row contains three buttons labeled 'SCREEN/PLAYBACK', 'ZWAY REC', and 'RINGER'.

- When an incoming message has been recorded, 4 short beeps sound twice on the handset.



Remote Access Key List

NEW MESSAGE
PLAYBACK

4

- Only new messages are played back.
- 3 beeps sound at the end of playback. If you hear 6 long beeps, the incoming message tape is full. Reset the tape.

ALL MESSAGE
PLAYBACK

5

- All of the messages are played back.
- 3 beeps sound at the end of playback.
- If you hear 6 long beeps, the incoming message tape is full. Reset the tape.

REPEAT

1

- The current message is repeated from the beginning.

SKIP

2

- The current message is skipped. Playback starts from the next message.

STOP

9

- Playback is stopped temporarily. To resume press **9** again within 15 seconds or the remote operation will be terminated.

RESET

3

- Press within 10 seconds after hearing the last message.
- If pressed after all message playback, the tape will rewind to the beginning.
- If pressed after new message playback, it will rewind to the beginning of the new messages. To rewind to the beginning of the tape press **3** again after the beep.
- To cancel the reset to save the message, press **2**.

ROOM SOUND
MONITOR

6

- The sound around the base unit is monitored for 30 seconds.
- At the end of monitoring a beep sounds. To continue, press **6** again within 10 seconds.

► Remote Operation from the Handset

ANSWERING
SYSTEM ON

8

- The answering system is turned on. The SCREEN/PLAYBACK indicator lights.

ANSWERING
SYSTEM OFF

0

- The SCREEN/PLAYBACK indicator light flashes and the answering system is turned off.

PAGER CALL ON

*

- Pager call feature is turned on.
- If you hear 6 beeps, the pager number is not stored. Store the number. (p. 32)

7

PAGER CALL OFF

*

- Pager call feature is turned off.

8

Monitoring incoming calls

When the SCREEN/PLAYBACK indicator flashes slowly, an incoming message is being recorded.

1. Press **SCREEN/PLAYBACK**.
 - The indicator turns to a steady light and you can listen to the incoming call.
 - To answer the call, press **TALK**. The recording is ended.
2. When finished, press **SCREEN/PLAYBACK**.

Recording your telephone conversation

1. During a conversation, press **PROGRAM/2WAY REC**.
 - The SCREEN/PLAYBACK indicator lights.
2. Continue your conversation.
3. When finished, press **PROGRAM/2WAY REC**.
 - The SCREEN/PLAYBACK indicator light goes out.

Many states have imposed regulations on the manner in which 2-way telephone conversations may be recorded, so you should inform the other party that the conversation is being recorded. Consult your local telephone company for further information.

OPERATION FROM HANDSET

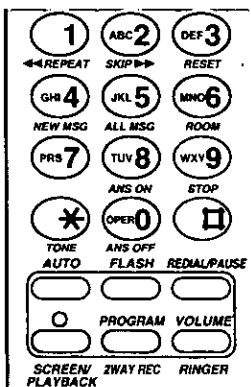

If the SCREEN/PLAYBACK indicator flashes when you press **SCREEN/PLAYBACK**, the answering system is off. To set the unit to answer calls, press "8".

Press **SCREEN/PLAYBACK**:

- To play back all messages, press "5".
- To play back new messages, press "4".
- To repeat, press "1".
- To skip, press "2".
- To reset the tape after playback, press "3".

Press **SCREEN/PLAYBACK** to end the operation.

OPERATION FROM TONE PHONE

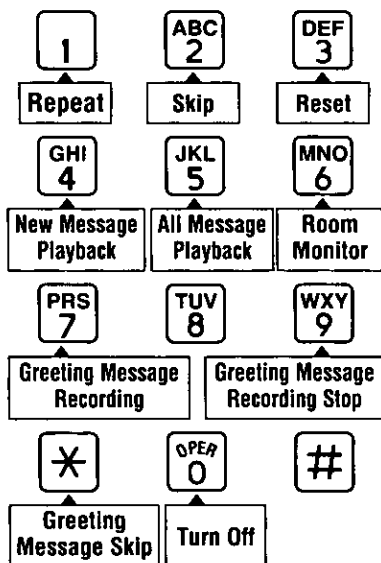

Call your unit.

Press remote code no. _____

- To play back all messages, press **5**.
- To play back new messages, press **4**.
- To repeat, press **1**.
- To skip, press **2**.
- To reset the tape after playback, press **3**.
- To record your message, Speak after 2 beeps following the 3 beeps at the end of playback.
- To save the messages, hang up after playback.

When you press a button, press firmly.

Press **SCREEN/PLAYBACK**.

- To monitor the room sound, press "6".
- To turn off the answering system, press "0".
- To turn on the pager call feature, press "*7".
- To turn off the pager call feature, press "*8".

Press **SCREEN/PLAYBACK** to end the operation.

To monitor incoming calls:

When the **SCREEN/PLAYBACK** indicator flashes slowly, press **SCREEN/PLAYBACK**. When finished, press the button again.

To answer the call, press **TALK**.

To record your telephone conversation:

1. During a conversation, press **PROGRAM/2WAY REC**.
2. Continue your conversation.
3. When finished, press **PROGRAM/2WAY REC**.

Call your unit.

To skip greeting message, press *****.

Press remote code no. _____

To turn off the answering system, press **0**, then hang up.

To re-record the greeting message,

1. Press **7** to re-record the greeting message.
2. Speak after a long beep.
-The recording time is up to 16 seconds.
3. When finished, press **9**.

To monitor room sound, press **6**.

To turn on the pager call feature, press *** 7**.

To turn off the pager call feature, press *** 8**.

To turn on the answering system, call your unit and wait for 15 rings. The unit will answer, then hang up.

Battery Replacement

If the BATT LOW/PROG indicator flashes after being fully charged, replace with a new Panasonic KX-A36A battery. (To order, call 1-800-332-5368.) To prevent memory loss, replace within 5 minutes.

- 1 Remove the cover.

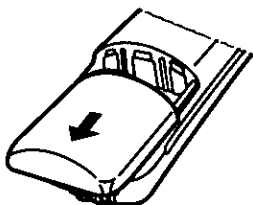

- 2 Replace the battery, then close the cover.

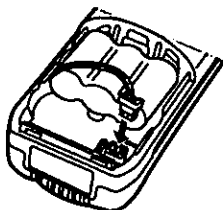

- 3 Charge the new battery for 10 hours.

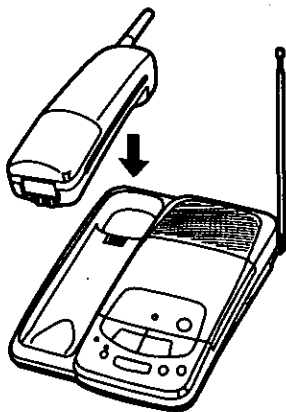

Attention:

The product that you have purchased contains a rechargeable battery. The battery is recyclable. At the end of its useful life, under various state and local laws, it may be illegal to dispose of this battery into the municipal waste stream. Check with your local solid waste officials for details in your area for recycling options or proper disposal.



Maintenance of Cassette Tape and Deck

Cassette tape

- For optimum sound quality and performance, we recommend you use the opposite side of the cassette tape after six months and replace the tape with a new one every year, assuming that the unit answers about ten calls a day.
- Never place a cassette tape near a magnetic source, such as a magnet or a TV set; because it may erase or distort the recorded message(s) on the tape.
- Slack in the tape can be tightened by rotating the tape reel with an instrument like a pencil, as shown.

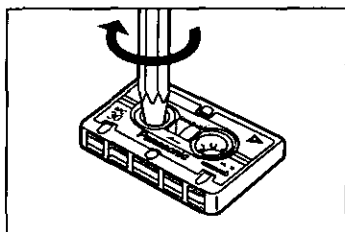

Tape deck

Since the head and capstan assemblies are in contact with the tape, dirt and residue from the tape may easily adhere to these parts, causing distortion. These parts should be cleaned periodically in the manner described below. Clean the head surface, pinch roller, and capstan with a cotton swab. If these surfaces are extremely dirty, wipe them with the cotton swab dampened with alcohol, then wipe them with a dry soft cloth.

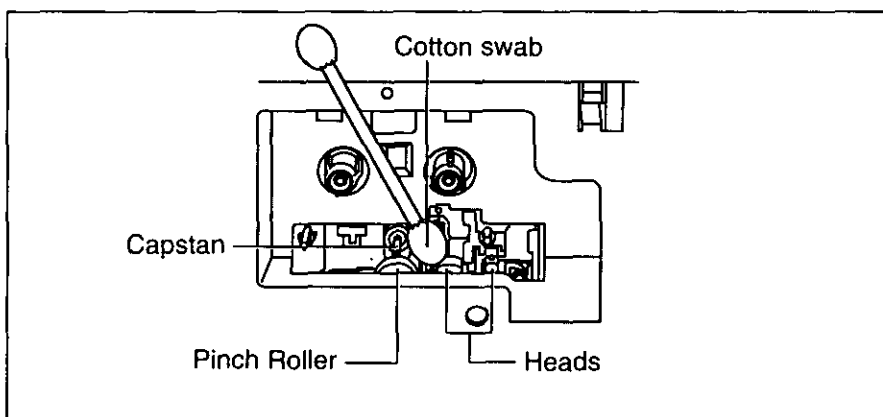

- Do not bring magnetic or metal objects, such as a screwdriver, near the head assemblies, as such objects could magnetize the heads.
- Do not oil any part of the unit.

Cassette panel installation

If the panel comes off, replace it by pushing as shown

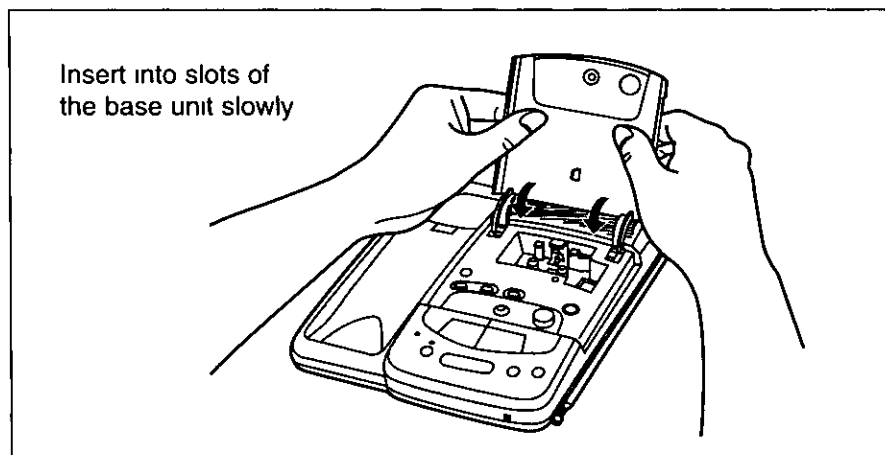

Adding Another Phone

This unit will not function during a power failure. To connect a standard telephone on the same line, use a Panasonic T-adaptor KX-J66 (To order, call 1-800-332-5368)

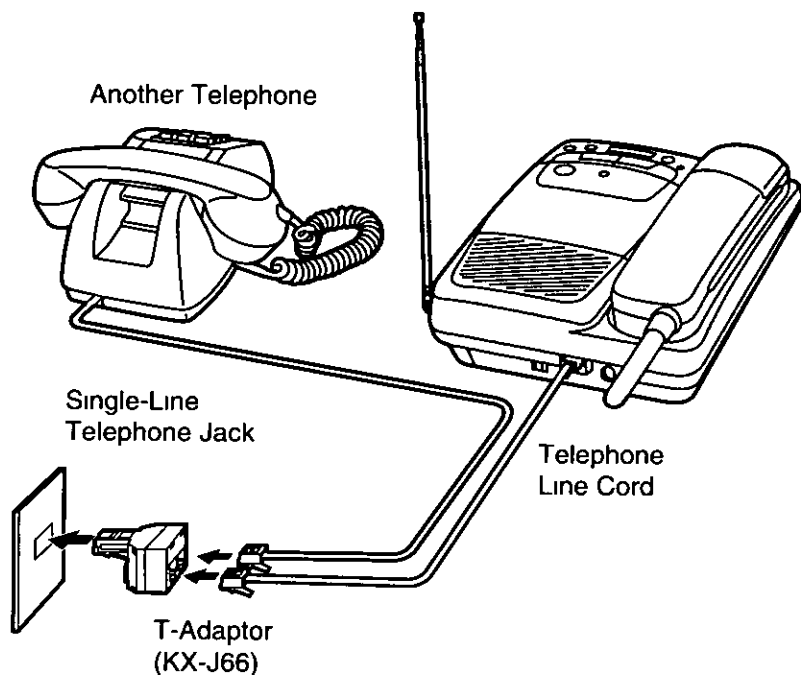

Before Requesting Help



Cordless Telephone

Problem	Remedy
Static, sound cuts in/out, fades Interference from other units	<ul style="list-style-type: none">● Set the handset and base unit away from electrical appliances● Move closer to the base unit● Extend the base unit antenna● Press (CH) to change the channel
Alarm tone sounds when you press (TALK) , (SCREEN/PLAYBACK) or (INTERCOM)	<ul style="list-style-type: none">● Move toward the base unit and try again● Place the handset on the base unit and try again● Plug in the AC adaptor● Clean the charge contacts and charge again
The handset does not ring	<ul style="list-style-type: none">● The ringer volume is "OFF" Press (VOLUME/RINGER) when the TALK and INTERCOM indicator lights are off
You cannot store a phone number	<ul style="list-style-type: none">● You can not store while the unit is in the talk or intercom mode● Do not pause for over 30 seconds while storing
While storing a phone number, the unit starts to ring	<ul style="list-style-type: none">● Press (TALK) to answer Later store the number again
During intercom two tones are heard	<ul style="list-style-type: none">● An outside call is received To answer, press (TALK)
(REDIAL/PAUSE) does not function properly	<ul style="list-style-type: none">● The button has a double function as redial before dialing (p 20) or pause during dialing (p 26)
(VOLUME/RINGER) does not function properly	<ul style="list-style-type: none">● The button has a double function as receiver volume selector during a conversation (p 20) or a ringer selector when the TALK and INTERCOM indicator lights are off (p 21)
(LOCATOR/INTERCOM) does not function properly	<ul style="list-style-type: none">● The handset is too far from the base unit or having an outside call

► Before Requesting Help

Answering System

Problem	Remedy
The answering system is on, but incoming messages cannot be recorded	<ul style="list-style-type: none">●The incoming message tape is full Use the opposite side or reset it
You cannot operate the answering system from a touch tone phone	<ul style="list-style-type: none">●Turn the answering system on (p 39)●Press your correct remote code number●Press each button firmly to produce a long tone●In some areas, a remote touch tone phone may not function due to telephone line conditions
You cannot operate the answering system at the base unit	<ul style="list-style-type: none">●The handset user is operating it Wait till the IN USE/CHARGE indicator goes out
Some incoming messages are not recorded to the end	<ul style="list-style-type: none">●Set the CPC function to "B" (p 17)
I cannot operate the answering system with the handset	<ul style="list-style-type: none">●Move toward the base unit●Someone is operating it
The VOLUME does not function fully	<ul style="list-style-type: none">●Clean the heads
4 short beeps are heard twice from the handset	<ul style="list-style-type: none">●A new message has just been recorded
While operating the answering system from the handset, two tones are heard	<ul style="list-style-type: none">●Someone is calling you from outside Press TALK to answer The remote operation is ended
The PROGRAM/2WAY REC does not function properly	<ul style="list-style-type: none">●The button has a double function If pressed during a conversation, the unit records the conversation If pressed when the TALK indicator light is off, the unit enters to the programming mode

General

Problem	Remedy
The BATT LOW/PROG indicator flashes Beeps sound intermittently	<ul style="list-style-type: none">● Charge the battery fully (p 11)
You charged the battery fully, but the BATT LOW/PROG indicator flashes after a few telephone calls	<ul style="list-style-type: none">● Clean the charge contacts and charge again● Replace with a new battery (p 45)
You cannot set the programmable preparation such as selecting the number of rings	<ul style="list-style-type: none">● Programming is not available while the unit is in the talk or intercom mode
While setting the programmable preparation, the unit starts to ring	<ul style="list-style-type: none">● Press TALK to answer Later program again
The unit does not work	<ul style="list-style-type: none">● Check the setting up (p 10)● Clean the charge contacts and charge the battery fully● Place the handset on the base unit for security code's identity
While operating the unit, the AC adaptor feels warm The IN USE/CHARGE indicator lights while the handset is on the base unit	<ul style="list-style-type: none">● These are normal conditions
I cannot use the unit during a power failure	<ul style="list-style-type: none">● The unit will not function during a power failure● You may connect a reserve telephone (p 48)
The unit stops working during operation	<ul style="list-style-type: none">● Place the handset on the base unit and unplug the AC adaptor to reset Plug in then try again

Important Safety Instructions

When using this unit, basic safety precautions as below should always be followed to reduce the risk of fire, electric shock, or personal injury

- 1 Read and understand all instructions
- 2 Follow all warnings and instructions marked on this unit
- 3 Unplug this unit from wall outlets before cleaning. Do not use liquid or aerosol cleaners. Use a damp cloth for cleaning.
- 4 Do not use this unit near water, for example, near a bath tub, wash bowl, kitchen sink, or the like.
- 5 Install this unit securely on a stable surface. Serious damage may result if the unit falls.
- 6 Do not cover slots and openings of the unit, for they are provided for ventilation and protection against overheating. Never place the unit near radiators, in/or a place where proper ventilation is not provided.
- 7 Use only the power source as marked on the unit. If you are not sure of the type of the power supply to your home, consult your dealer or local power company.
- 8 Do not place objects on the power cord. Install the unit where no one can step on the cord.
- 9 Do not overload wall outlets and extension cords as this can result in the risk of fire or electric shock.
- 10 Never push any objects into this unit through slots as they may result in risk of fire or electric shock. Never spill any liquid on the unit.
- 11 To reduce the risk of electric shock, do not disassemble this unit, but take it to a qualified serviceman when some service or repair work is required. Opening or removing covers may expose you to dangerous voltages or other risks. Incorrect reassembly can cause electric shock when the appliances is subsequently used.
- 12 Unplug this unit from the wall outlet and refer servicing to qualified service personnel under the following conditions:
 - A When the power supply cord or plug is damaged or frayed
 - B If liquid has been spilled into the unit
 - C If the unit has been exposed to rain or water
 - D If the unit does not work normally by following the operating instructions. Adjust only controls covered by the operating instructions, for improper adjustment may require extensive work by a qualified technician
 - E If the unit has been dropped or damaged
 - F If the unit exhibits a distinct change in performance
- 13 During thunderstorms, avoid using telephones except cordless types. There may be a remote risk of electric shock from lightning.
- 14 Do not use this unit to report a gas leak in the vicinity of it.

SAVE THESE INSTRUCTIONS

CAUTION:

To reduce the risk of fire or injury to persons, read and follow these instructions

- 1 Use only the battery(ies) instructed
- 2 Do not dispose of the battery(ies) in a fire. The cell may explode. Check with local codes for possible special disposal instructions
- 3 Do not open or mutilate the battery(ies). Released electrolyte is corrosive and may cause damage to the eyes or skin. It may be toxic if swallowed
- 4 Exercise care in handling batteries in order not to short the battery with conduction materials such as ring, bracelets, and keys. The battery or conductor may overheat and cause burns
- 5 Charge the battery(ies) provided with or identified for use with this product only in accordance with the instructions and limitations specified in this manual

WARNING:

TO PREVENT FIRE OR SHOCK HAZARD, DO NOT EXPOSE THIS PRODUCT TO RAIN OR ANY TYPE OF MOISTURE

FCC and Other Information

If requested by the telephone company, inform them as follows:

FCC registration No.(found on the bottom of the unit)
Ringer Equivalence0.2B

The particular telephone line to which the equipment is connected.

This unit must not be connected to a coin operated line.

If you are on a party line, check with your local telephone company.

Ringer Equivalence No.(REN):

The REN is useful in determining the quantity of devices you may connect to your telephone line and still have all of those devices ring when your telephone number is called. In most, but not all areas, the sum of the REN's of all devices connected to one line should not exceed five (5.0). To be certain of the number of devices you may connect to your line, as determined by the REN, you should contact your local telephone company to determine the maximum REN for your calling area.

In the event terminal equipment causes harm to the telephone network, the telephone company should notify the customer, if possible, that service may be stopped.

However, where prior notice is impractical, the company may temporarily cease service providing that they:

- (a) Promptly notify the customer.
- (b) Give the customer an opportunity to correct the problem with their equipment.
- (c) Inform the customer of the right to bring a complaint to the Federal Communication Commission pursuant to procedures set out in FCC Rules and Regulations Subpart E of Part 68.

The Telephone Company may make changes in its communications facilities, equipment, operations or procedures, where such action is reasonably required in the operation of its business and is not inconsistent with the rules and regulations in FCC Part 68.

If such changes can be reasonably expected to render any customer terminal equipment incompatible with telephone company communications facilities, or require modification or alteration of such terminal equipment, or otherwise materially affect its use or performance, the customer shall be given adequate notice in writing, to allow the customer an opportunity to maintain uninterrupted service.

CAUTION:

Any changes or modifications not expressly approved by the party responsible for compliance could void the user's authority to operate this device.

When programming emergency numbers and/or making test calls to emergency numbers:

1. Remain on the line and briefly explain to the dispatcher the reason for the call before hanging up.
2. Perform such activities in the off-peak hours, such as early morning hours or late evenings.

Note:

This equipment has been tested and found to comply with the limits for a Class B digital device, pursuant to Part 15 of the FCC Rules. These limits are designed to provide reasonable protection against harmful interference in a residential installation. This equipment generates, uses, and can radiate radio frequency energy and, if not installed and used in accordance with the instructions, may cause harmful interference to radio communications. However, there is no guarantee that interference will not occur in a particular installation. If this equipment does cause harmful interference to radio or television reception, which can be determined by turning the equipment off and on, the user is encouraged to try to correct the interference by one or more of the following measures:

- Reorient or relocate the receiving antenna.
- Increase the separation between the equipment and receiver.
- Connect the equipment into an outlet on a circuit different from that to which the receiver is connected.
- Consult the dealer or an experienced radio/TV technician for help.

- **Environment**—do not place the unit in room where the temperature is less than 5°C (41°F) or greater than 40°C (104°F). Allow 10 cm (4") clearance around the unit for proper ventilation. Avoid excessive smoke, dust, mechanical vibration, shock, or direct sunlight.
- **Routine care**—wipe the unit with a soft cloth. Do not use benzine, thinner, or any abrasive powder. When you leave the unit unused for long time, unplug the AC adaptor from the outlet.
- **if there is any trouble**—disconnect the unit from the telephone line and connect a known working phone. If the known working phone operates properly, have your unit repaired by one of the authorized Panasonic Factory Service Centers. If the known working phone does not operate properly, consult with your telephone company.

This device complies with Part 15 of the FCC Rules. Operation is subject to the following two conditions:

- (1) This device may not cause harmful interference, and (2) this device must accept any interference received, including interference that may cause undesired operation.

Privacy of communications may not be ensured when using this phone.

For product service

- Panasonic Servicenters are listed in the servicenter directory.
- Call 1-800-545-2672 for the location of an authorized servicenter.

When you ship the product

- Carefully pack your unit, preferably in the original carton.
- Attach a letter, detailing the symptom, to the outside of the carton.

Symptom

- Send the unit to an authorized servicenter, prepaid and adequately insured.
- Do not send your unit to the Matsushita Consumer Electronics Company listed below or to executive or regional sales offices. These locations do not repair consumer products.

- This cordless telephone is designed for use in the United States of America. Sale or use of this product in other countries may violate local laws.
- Ce téléphone sans fil est conçu pour être utilisé aux États-Unis d'Amérique. La vente ou l'emploi de cet appareil dans certains autres pays peut constituer une infraction à la législation locale.
- Este teléfono sin cordón fue elaborado para uso en los Estados Unidos de América. La venta o el empleo de este producto en ciertos países puede constituir violación de la legislación local.
- このコードレス電話機は、日本国外での使用を目的として設計されており、日本国内での使用は法律違反となります。従って、当社では日本国内においては原則として修理などのサービスは致しかねます。

Matsushita Consumer Electronics Company,
Division of Matsushita Electric Corporation of America
One Panasonic Way, Secaucus, New Jersey 07094

Panasonic Sales Company ("PSC"),
Division of Matsushita Electric of Puerto Rico, Inc.
Ave. 65 de Infantería, Km. 9.5, San Gabriel Industrial Park
Carolina, Puerto Rico 00985

Free Manuals Download Website

<http://myh66.com>

<http://usermanuals.us>

<http://www.somanuals.com>

<http://www.4manuals.cc>

<http://www.manual-lib.com>

<http://www.404manual.com>

<http://www.luxmanual.com>

<http://aubethermostatmanual.com>

Golf course search by state

<http://golfingnear.com>

Email search by domain

<http://emailbydomain.com>

Auto manuals search

<http://auto.somanuals.com>

TV manuals search

<http://tv.somanuals.com>