

Panasonic

Cordless Answering System

Model No. **KX-TC1230ALW**
KX-TC1230NZW

Operating Instructions

Preparation

Cordless Telephone

Answering System

Useful Information

Caller ID Compatible

PLEASE READ BEFORE USE AND SAVE.

Charge the battery for about 10 hours before initial use.

Before Initial Use

Thank you for purchasing your new Panasonic cordless telephone.

For Australia

When you subscribe to Caller ID services from your telephone operator, this telephone will display the caller's phone number. When available from your telephone operator, this telephone will also display the number of the second call or call waiting.

For New Zealand

Caller ID, where available, is telephone company service. After subscribing to Caller ID, this phone will display a caller's phone number.

For your future reference

Serial No. _____
(found on the bottom of the unit)

Date of purchase _____

Name and address of dealer _____

Attach or keep original receipt to assist with any repair under warranty.

Accessories (included)

AC Adaptor (p. 13)

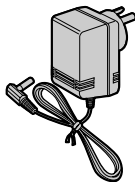

one

Telephone Line Cord (p. 13)

For Australia

For New Zealand

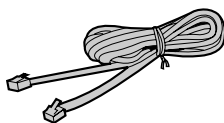

one



one

Battery (p. 14)

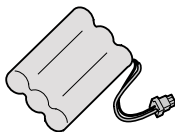

one

Handset Cover (p. 14)

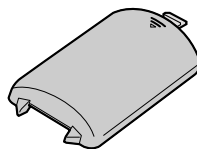

one

For Australia only

Telephone Plug (p. 13)

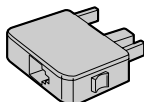

one

Wall Mounting Adaptor (p. 73)

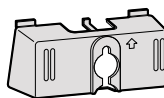

one

For Best Performance

Battery Charge

A rechargeable Nickel Cadmium (Ni-Cd) battery powers the handset. Charge the battery for about **10 hours** before initial use (p. 14).

- **Clean the handset and the base unit charge contacts with a soft, dry cloth once a month. Clean more often if the unit is subject to grease, dust or high humidity.** Otherwise the battery may not charge properly.



Base Unit Location/Noise

Calls are transmitted between the base unit and the handset using wireless radio waves. **For maximum distance and noise-free operation**, the recommended base unit location is:

Away from electrical appliances such as a TV, personal computer, cellular phone, charging units or another cordless phone.

In a **HIGH and CENTRAL** location with no obstructions such as walls.

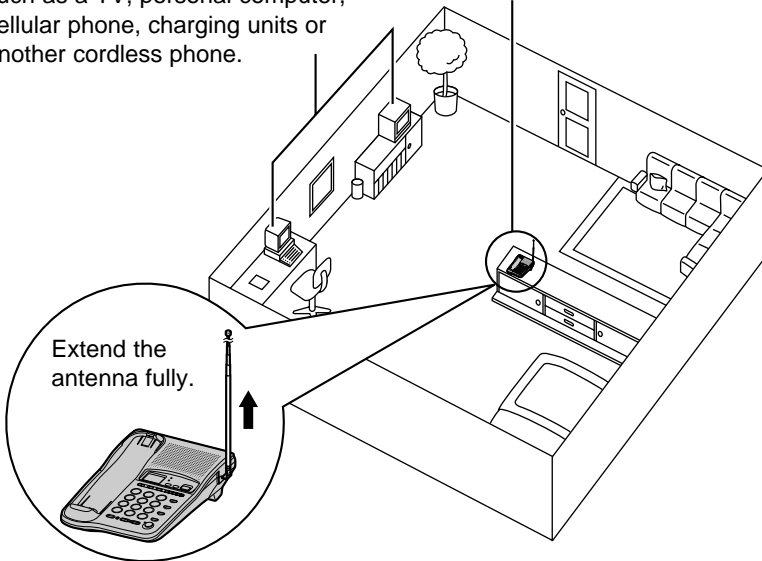

Contents

Preparation

| | |
|----------------------------------------------------|----|
| Location of Controls | 6 |
| Displays | 9 |
| Settings | 13 |
| Connections | 13 |
| Installing the Battery in the Handset | 14 |
| Battery Charge | 14 |
| Time and Date Adjustment | 16 |
| Programmable Functions | 18 |
| Setting the Auto Talk Feature | 19 |
| Selecting the Ringer Volume | 20 |
| Setting the LCD Contrast | 21 |
| Storing Your Area Code | 22 |
| Preparing the Answering System | 23 |
| Greeting Message | 23 |
| Programming Summary for the Answering System | 25 |
| Selecting the Caller's Recording Time | 26 |
| Selecting the Number of Rings | 27 |

Cordless Telephone

| | |
|--------------------------------------------------------|----|
| Making Calls | 28 |
| With the Handset | 28 |
| With the Base Unit (Digital Duplex Speakerphone) | 30 |
| Simultaneous Keypad Dialling | 32 |
| Answering Calls | 33 |
| With the Handset | 33 |
| With the Base Unit (Digital Duplex Speakerphone) | 33 |
| Caller ID Service | 34 |
| Using the Caller List | 36 |
| Viewing the Caller List | 36 |
| Calling Back from the Caller List | 38 |
| Editing the Caller's Phone Number | 39 |
| Storing Caller List Information in the Directory | 40 |
| Erasing Caller List Information | 41 |
| Speed Dialler | 43 |
| Storing Phone Numbers in Memory | 43 |
| Dialling a Stored Number | 43 |

| | |
|----------------------------------------------------------------------------------------|----|
| Using the Directory | 44 |
| Storing Names and Numbers in the Directory | 44 |
| Selecting Characters to Enter Names | 46 |
| Finding Items in the Directory | 48 |
| Dialling from the Directory | 49 |
| Editing an Item in the Directory | 50 |
| Erasing an Item from the Directory | 51 |
| Intercom | 52 |
| Transferring a Call Using the Intercom | 53 |
| Special Features | 54 |
| How to Use the PAUSE Button (For Analog PBX Line/Long Distance Service Users) | 54 |
| Automatic Security Code Setting | 55 |
| Call Waiting and Caller ID Compatible (For Australia only) | 55 |
| RECALL Button | 55 |

Answering System

| | |
|-------------------------------------------------------|----|
| Automatic Answering Operation | 57 |
| Setting the Unit to Answer Calls | 57 |
| Listening to Messages | 58 |
| From the Handset | 60 |
| Erasing Messages | 61 |
| Pager Call | 62 |
| Storing a Pager Number | 62 |
| Setting the Unit to Call a Pager | 63 |
| Remote Operation from a Touch Tone Phone | 64 |
| Setting the Remote Code | 65 |
| Voice Menu | 66 |
| Direct Remote Operation | 68 |
| Remote Operation with the Handset | 70 |

Useful Information

| | |
|---------------------------------------------------------|----|
| Wall Mounting | 72 |
| Battery Replacement | 74 |
| Adding Another Phone | 75 |
| Before Requesting Help | 76 |
| Safety Instructions | 81 |
| Important Information (For Australia only) | 81 |

Location of Controls

Base unit

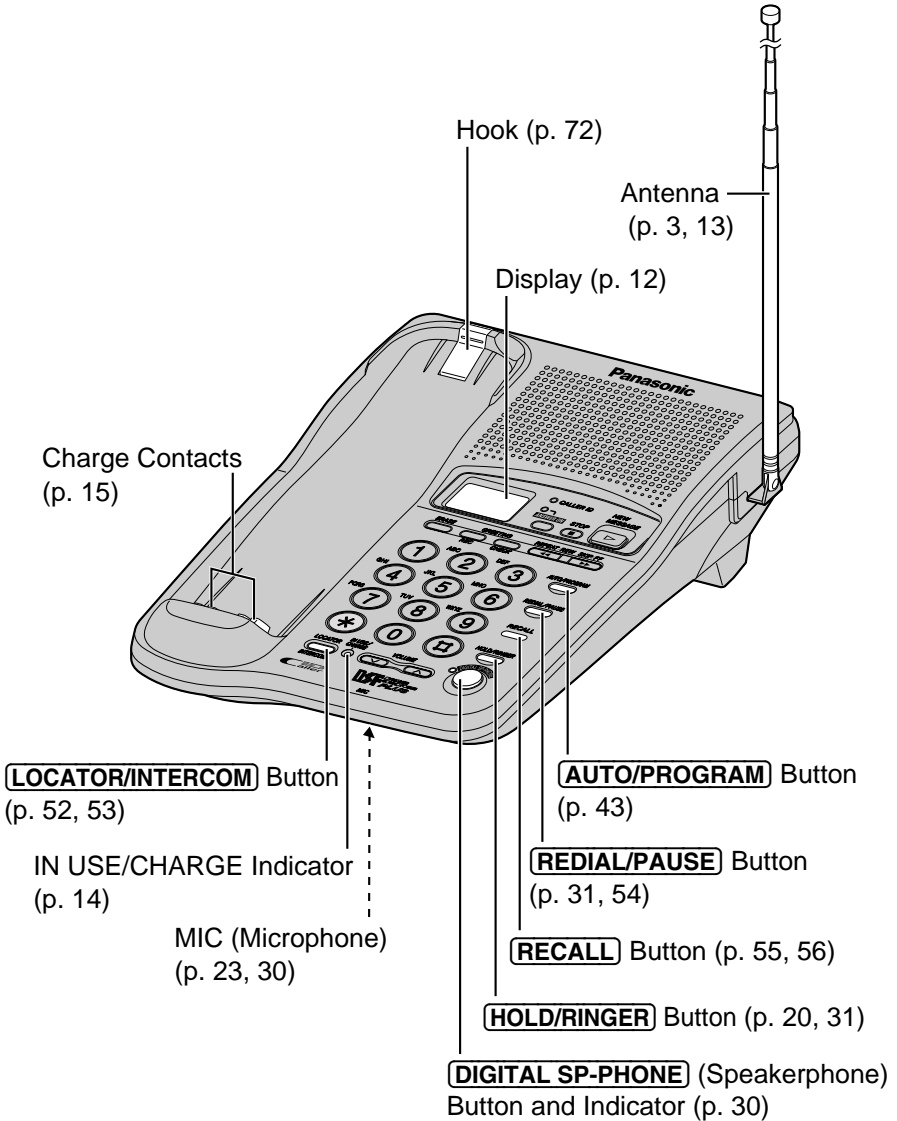

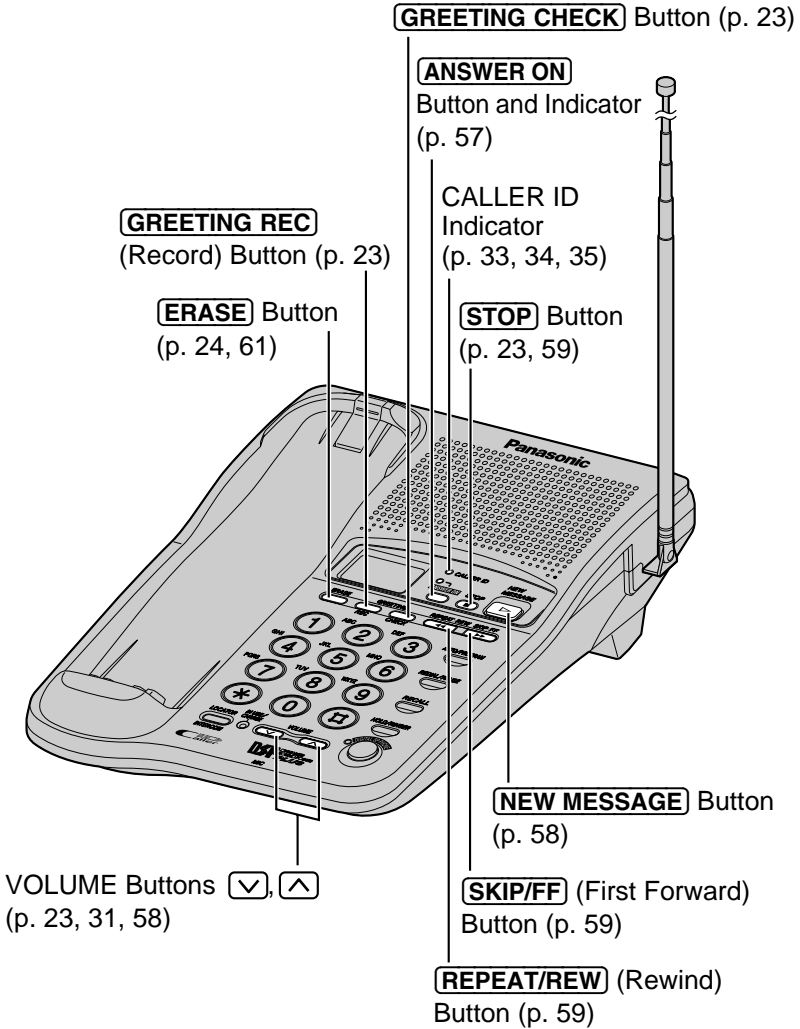

➔ Location of Controls

Handset

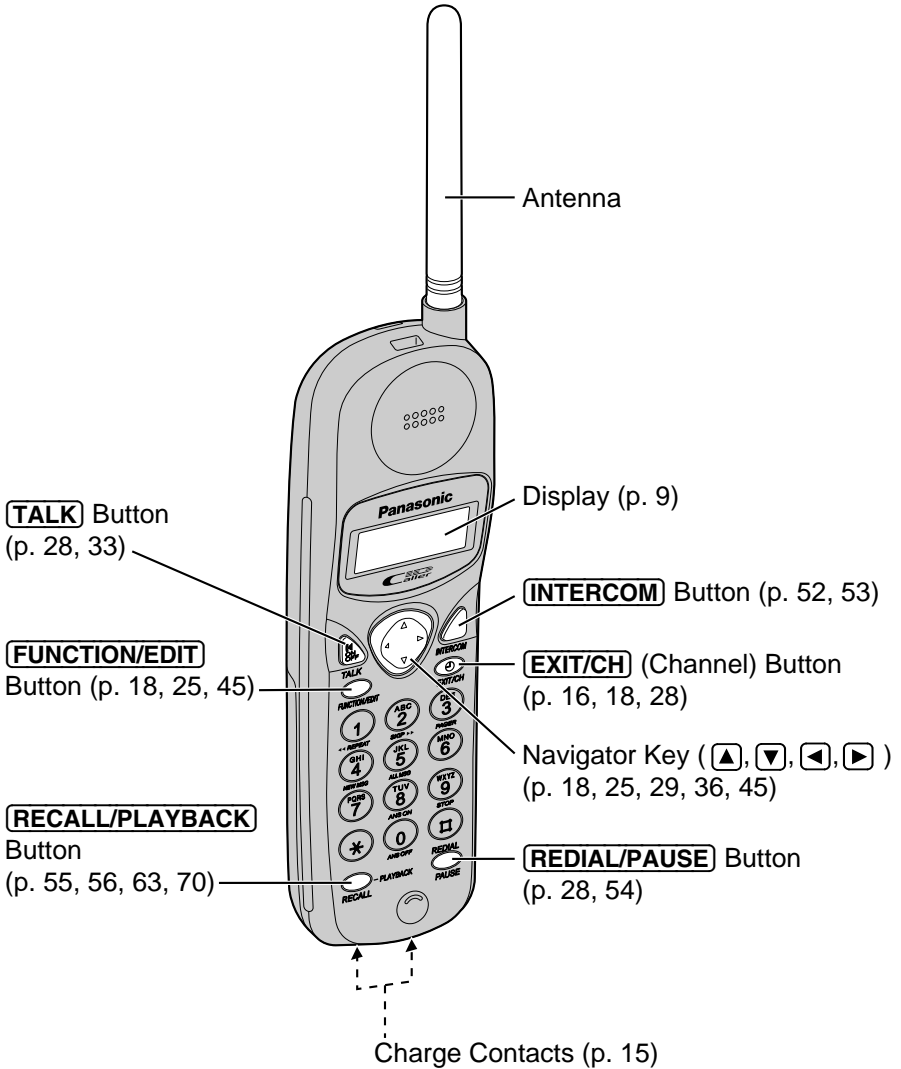

Displays



Both the handset and the base unit show you information and instructions on their displays. These display prompts are shown below.

Handset display

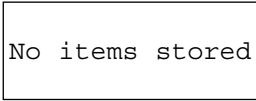

The Caller List is empty or there are no stored items in the directory. This is displayed while the handset is on the base unit.

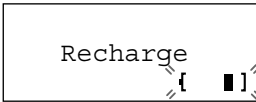

The battery needs to be charged. Place the handset on the base unit to charge the battery (p. 15).

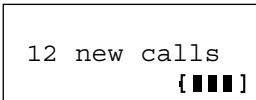

The display shows the number of new calls and the battery strength while the handset is on the base unit.

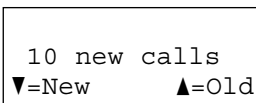

When lifting the handset off the base unit, the display shows the number of new calls for 10 seconds.

To search from the most recent call, press . To search from the oldest call, press (p. 36).

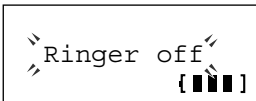

When the handset ringer volume is set to OFF (p. 21), "Ringer off" will flash for about 45 seconds before the handset returns to the standby mode (p. 15).

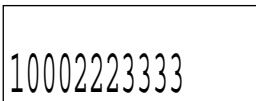

When a call is received, the display shows the caller's phone number after the first ring.

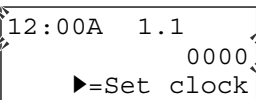

The clock needs adjusting (p. 16).

➔ Displays

Talk
01-06-35 [■■■■]

During a conversation, the display shows the length of the call (ex. 1 hour, 6 minutes and 35 seconds). The battery strength is also displayed (p. 14).

No link to base
Place on cradle
and try again.

The handset has lost communication with the base unit. Place the handset on the base unit and try again.

12223334444
11:20A 20.12 X3

This is an information from the Caller List.

The display shows:

- the caller's phone number,
- the time and date of the last call (ex. Dec. 20, 11:20 AM), and
- the number of times called (ex. 3 times).

Ann
1234567890

This is a name from the directory. The stored name and phone number are displayed.

Press INTERCOM

The base unit is paging the handset (p. 52).

Intercom
00-00-07 [■■■■]

The handset and the base unit are in the intercom mode (p. 52).

Intercom hold
00-01-12 [■■■■]

An outside call has been put on hold by the handset user in the intercom mode. To release the hold, press **TALK** or **DIGITAL SP-PHONE** (p. 53).

Hold
00-01-12 [■■■■]

An outside call using the handset has been put on hold by pressing **HOLD/RINGER**. To release the hold, press **TALK** or **DIGITAL SP-PHONE** (p. 31).



Not available

◀, ▶, **RECALL/PLAYBACK** or **INTERCOM**
was pressed, while the base unit was in use.

Caller's list
No item stored

When trying to enter the Caller List while the handset is off the base unit, the Caller List is empty.

Directory list
No item stored

When trying to enter the directory list while the handset is off the base unit, the directory is empty.

Memory is full

When trying to store an item or Caller List information in the directory, the directory memory is full (p. 40, 45).

Save error

While storing items in the directory, the handset has lost communication with the base unit. Move closer to the base unit and try again.

Answering
system setting
{■■■■}

The unit is in answering system programming mode (p. 25).

Remote
operation
{■■■■}

The handset is operating the answering system remotely (p. 70).

➔ Displays

Base unit display



The clock needs adjusting (p. 16).

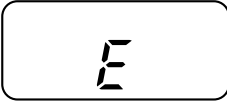

Your greeting message was not recorded correctly. Record it again (p. 23).



The unit is in the answering system programming mode.



The speaker volume level is set to "5".

You can select:

- 9 levels (0–8) while using the answering system (p. 23, 58).
- 8 levels (1–8) while using the speakerphone (p. 32).



12 messages have been recorded.



Memory is full. Erase some or all of the messages (p. 61).



The recording time is set to "greeting only" (p. 26). (The display is blank.)



The base unit ringer volume is set to OFF (p. 20).



The pager call mode is set to ON (p. 63).



Connections

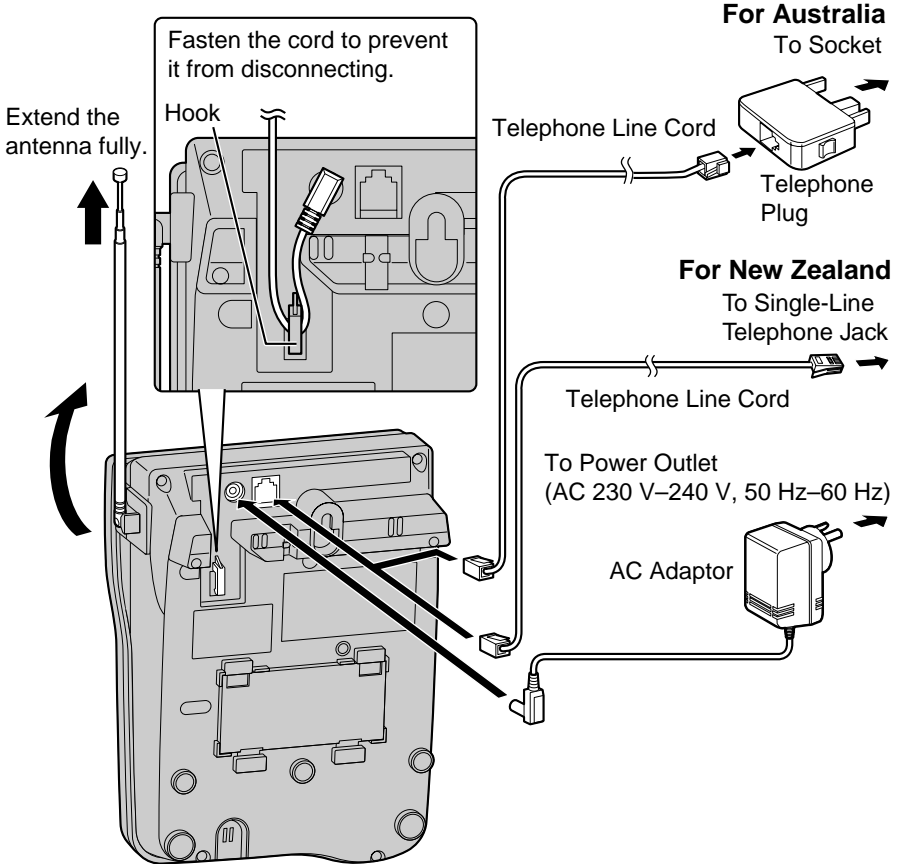

- USE ONLY WITH Panasonic AC ADAPTOR PQLV10AL.
- The AC adaptor must remain connected at all times. (It is normal for the adaptor to feel warm during use.)
- To connect a standard telephone on the same line, see page 75.
- If your unit is connected to a PBX which does not support Caller ID services, you cannot access those services.
- When more than one unit is used, the units may interfere with each other. To prevent or reduce interference, please leave ample space between the base units.
- KX-TC1230NZW will not answer incoming calls on your FaxAbility number.

Installing the Battery in the Handset

Install the battery in the handset and close the handset cover, locking it into place.

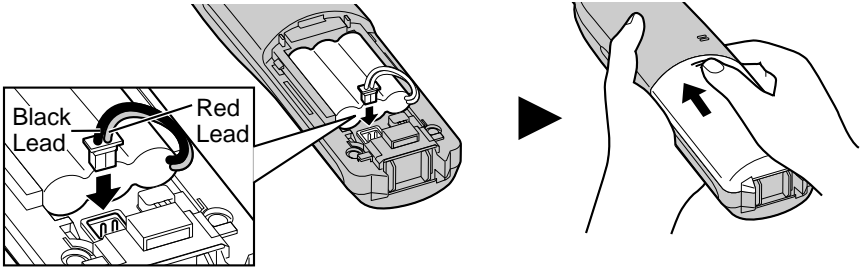

Battery Charge

Place the handset on the base unit and charge for about **10 hours** before initial use.

- The IN USE/CHARGE indicator lights and a beep sounds.

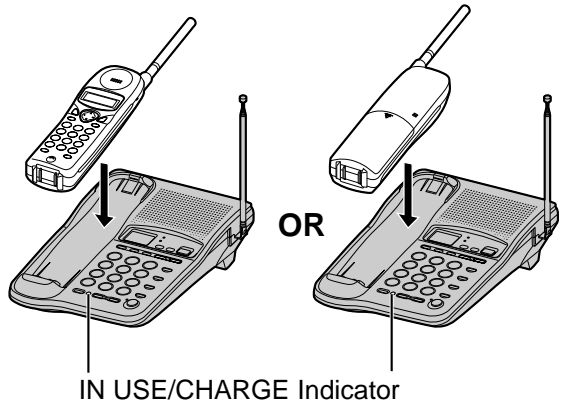

Battery strength

You can check the battery strength on the handset display while the handset is on the base unit, while it is in use (making/answering a call etc.), or after viewing the Caller List or directory items, programming etc. The battery strength will remain for a few seconds after using the handset, then the display will return to the standby mode (p. 15).

The battery strength is as shown in the chart below.

| Display prompt | Battery strength |
|------------------|------------------------|
| { ■■■ } | Fully charged |
| { ■■ } | Medium |
| { ■ } | Low |
| { ■ } (flashing) | Needs to be recharged. |



Recharge

Recharge the battery when:

- “Recharge” is displayed on the handset,
- “{ ■}” flashes on the display, or
- the handset beeps intermittently while it is in use.

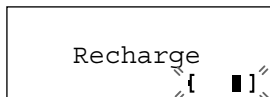

- If you DO NOT recharge the handset battery for more than 30 minutes, the display will keep indicating “Recharge” and/or “{ ■}” will continue to flash.
- To fully recharge the battery, the handset should be left on the base unit for 10 hours.

Battery information

After your Panasonic battery is fully charged (p. 14):

| Operation | Operating time |
|----------------------------|---------------------|
| While in use (TALK) | Up to about 6 hours |
| While not in use (Standby) | Up to about 20 days |

- The battery operating time may be shortened depending on usage conditions, such as viewing the Caller ID Caller List or directory list, and ambient temperature.
- Clean the handset and the base unit charge contacts with a soft, dry cloth once a month. Clean more often if the unit is subject to grease, dust or high humidity.** Otherwise the battery may not charge properly.
- If the battery is fully charged, you do not have to place the handset on the base unit until “Recharge” is displayed and/or “{ ■}” flashes. This will maximize the battery life.
- The battery cannot be overcharged.

Standby mode (While the handset is off the base unit)

The handset goes into the standby mode after you finish using the handset (making/answering a call, viewing the Caller List or directory list etc.). The display is blank, but the handset can receive calls. The battery operating time is conserved in this mode.

Time and Date Adjustment

You can select AM/PM or 24-hour clock by programming.

Make sure the unit is in the standby mode initially.

- 1 Lift the handset off the base unit and press \ominus / **EXIT/CH** twice.
OR
When the handset is off the base unit, press \ominus / **EXIT/CH** once.
 - If previously adjusted, "Adjust" will be displayed on the third line.
- 2 Press \blacktriangleright (Set clock key).
 - You may press \blacktriangleright (Adjust key) instead.
- 3 Enter the current year by using a 4-digit number.
(Ex. To set the year 2001, enter "2001".)
- 4 Press \blacktriangleright (Next key).
- 5 Enter the current time (hour and minute) by using a 4-digit number.
(Ex. To set 9:30, enter "0930".)
 - For AM/PM setting: Enter numbers between 0100 and 1259.
 - For 24-hour clock: Enter numbers between 0000 and 2359.
- 6 Press \blacktriangleright (Next key).
 - If numbers between 0000 and 0059, or 1300 and 2359 are entered, the time will automatically be set using the 24-hour clock. Skip the steps 7 and 8 and go to the step 9.
- 7 Press \ast to select "AM" or "PM" or 24-hour clock. (Ex. You select "PM".)

```
12:00A 1.1
                                0000
                                ▶=Set clock
```

```
12:00A 01.01
Enter year 0000
                                ▶=Next
```

```
12:00A 01.01
Enter year 2001
                                ▶=Next
```

```
12:00A 01.01
Enter time
                                ▶=Next
```

```
09:30A 01.01
Enter time
                                ▶=Next
```

```
09:30A 01.01
* =AM/PM
                                ▶=Next
```

```
09:30P 01.01
* =AM/PM
                                ▶=Next
```

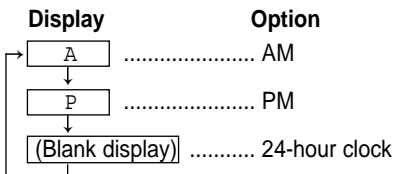

- Each time you press \ast , the selection will change on the display.

8 Press  (Next key).

09:30P 01.01
Enter day.month
▶=Save

9 Enter the current date by using a 4-digit number.
(Ex. To set Dec. 27, enter "2712".)

09:30P 27.12
Enter day.month
▶=Save

10 Press  (Save key).
•A beep sounds.
•The clock starts working.

09:30P 27.12
2001

- You can go back to the previous display by pressing , when setting the time and date.
- If 3 beeps sound when entering the time and date, a wrong number was entered. Enter the correct time and date.

To check the time and date

You can check the current time and date in the standby mode.

Lift the handset off the base unit and press  (EXIT/CH) twice.

OR

When the handset is off the base unit, press  (EXIT/CH) once.



- The current time and date is displayed for 30 seconds. To return to the standby mode, press  (EXIT/CH).

 (EXIT/CH)

If a power failure occurs, "Ⓟ" will flash on the base unit display. Readjust the time and date. If you use the handset for making/answering calls or remote operation without adjusting the time and date, the display in step 1 appears for 5 seconds after "Off" is displayed.

Voice Time/Day Stamp: During playback, a synthesized voice will announce the day and time that each message was recorded.

For Caller ID service users (p. 34)

If a time display service is available with the Caller ID service:

- The Caller ID information will re-set the clock after the first ring if the adjusted time and/or date is incorrect. However, if the time has not previously been set, the Caller ID information will not adjust the clock.

Programmable Functions

You can program the following function items **using the handset near the base unit**. The display shows the programming instructions. See the corresponding pages for function details.

Make sure the unit is in the standby mode initially.

Lift the handset, and press **FUNCTION/EDIT**.



<Function menu>*

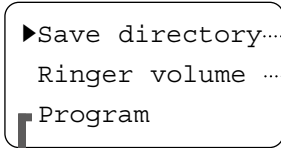

▶Save directory..... To store an item in the directory (p. 45).
Ringer volume To select the ringer volume (p. 20).

Press .

<Function menu>*

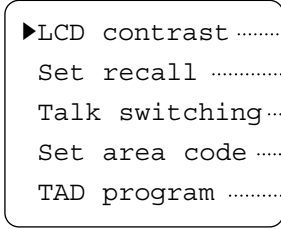

▶LCD contrast To select the LCD contrast (p. 21).
Set recall To select the recall time (p. 56).
Talk switching..... To set the auto talk feature (p. 19).
Set area code To set your area code (p. 22).
TAD program To program answering system functions (p. 25).

During programming:

- *To select a desired function item, press or repeatedly until the arrow points to the item. Then press to go to the next step.
- You can exit the programming mode any time by pressing **EXIT/CH**.
- If you do not press any buttons for 60 seconds, the unit will return to the standby mode.
- If the handset has lost communication with the base unit, 3 beeps sound and “No link to base Place on cradle and try again.” is displayed.



Setting the Auto Talk Feature

The Auto Talk feature allows you to answer a call by lifting the handset of the base unit without pressing **TALK**. If you want to use this feature, turn the feature ON by programming. Your phone comes from the factory set to OFF.

Make sure the unit is in the standby mode initially.

1 Press **FUNCTION/EDIT**.

2 Press or repeatedly until the arrow points to "Program".

```

▶Program
▼▲                               ▶=Yes
  
```

3 Press (Yes key).

4 Press or repeatedly until the arrow points to "Talk switching".

```

▶Talk switching
Set area codeq
▼▲                               ▶=Yes
  
```

5 Press (Yes key).

```

Auto talk
:Off
▼▲                               ▶=Save
  
```

6 Press or to select "On" or "Off".

```

Auto talk
:On
▼▲                               ▶=Save
  
```

7 Press (Save key).

- A beep sounds.
- To return to the standby mode, press **EXIT/CH**.

```

Auto talk
:On
  
```

- You can exit the programming mode any time by pressing **EXIT/CH**.
- In order to view Caller ID information before answering a call, leave the Auto Talk feature OFF.

➔ Programmable Functions

Selecting the Ringer Volume

You can set the handset and base unit ringer volumes to HIGH, LOW or OFF. If set to OFF, the handset/base unit will not ring. Your phone comes from the factory set to HIGH.

With the handset

Make sure the unit is in the standby mode initially.

- 1 Press **FUNCTION/EDIT**.
- 2 Press **▼** or **▲** repeatedly until the arrow points to "Ringer volume" and press **►** (Yes key).
- 3 Press **▼** or **▲** to select the desired volume.
 - The selected volume is displayed and rings.
 - To turn the ringer OFF, press and hold **▼** until 2 beeps sound.

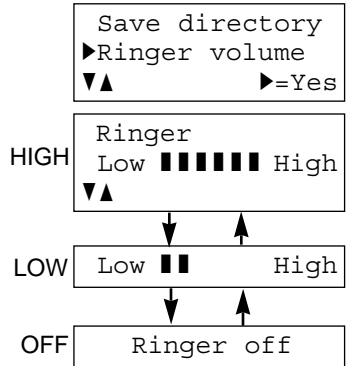

To turn the ringer ON, press **▲** or **▼** in step 3.

- The ringer will sound at the LOW level.
- You can also select the ringer volume while a call is being received. Press **▼** or **▲** while the unit is ringing.
- When set to OFF, "Ringer off" will flash for about 45 seconds before the handset returns to the standby mode.

With the base unit

Make sure the unit is in the standby mode initially. (You can also select the ringer volume while a call is being received.)

To select HIGH or LOW, press **HOLD/RINGER**.

- Each time you press the button, the ringer volume will change and the selected ringer volume will ring.

To turn the ringer OFF, press and hold **HOLD/RINGER** until 2 beeps sound.

- "RINGER OFF" will be displayed.

To turn the ringer ON, press **HOLD/RINGER**.

- The ringer will sound at the HIGH level.





Setting the LCD Contrast

You can program the handset LCD contrast (5 levels). To make the handset display clearer, set to high level. Your phone comes from the factory set to level 3.

Make sure the unit is in the standby mode initially.

1 Press **FUNCTION/EDIT**.

2 Press or repeatedly until the arrow points to "Program".

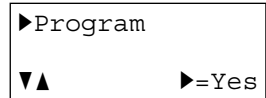

3 Press (Yes key).

4 While the arrow points to "LCD contrast", press (Yes key).

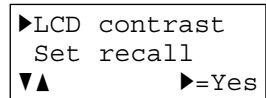

5 Press or to select the desired contrast.

- Each time you press or , the LCD contrast will change.



6 Press (Save key).

- A beep sounds.
- To return to the standby mode, press **EXIT/CH**.

- You can exit the programming mode any time by pressing **EXIT/CH**.

➡ Programmable Functions

Storing Your Area Code

We recommend you program your area code before using the Caller ID feature (p. 34). Incoming calls from the same area will be then recorded in the Caller List without the area code. You do not have to remove the code before calling back or storing.

Make sure the unit is in the standby mode initially.

To store your area code

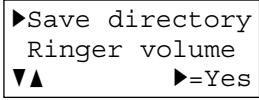
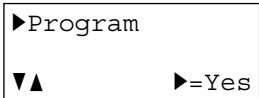
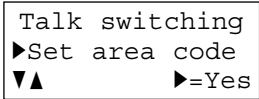
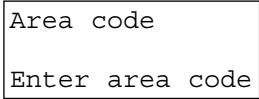
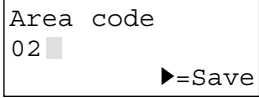
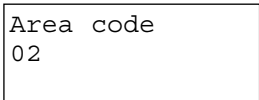
- 1 Press **FUNCTION/EDIT**.

- 2 Press **▼** or **▲** repeatedly until the arrow points to "Program", and press **▶** (Yes key).

- 3 Press **▼** or **▲** repeatedly until the arrow points to "Set area code".

- 4 Press **▶** (Yes key).

- 5 Enter your area code.
 - You can enter the number up to 8 digits
 - If you enter a wrong number, press **◀**. The digits are 1erased from the right.
- 6 Press **▶** (Save key).
 - A beep sounds.
 - To return to the standby mode, press **EXIT/CH**.

•You can exit the programming mode any time by pressing **EXIT/CH**.

To erase your area code, press **✳** in step 5.

For New Zealand Users:

Your telephone service provider may charge you for a local call when it is dialled with an area code prefix. If the charge for local call is unacceptable, store your area code as shown above before use, or only the 7-digits of the local number should be dialled from your telephone. Do not dial the "0" prefix or the area code digit.

Preparing the Answering System

Greeting Message

You can record a personal greeting message of **up to 2 minutes**. If a greeting message is not recorded, one of two pre-recorded greetings will be played when a call is received (p. 24).

All messages (greeting, incoming, etc.) are stored in digital memory (p. 24). The **total recording time is about 15 minutes**.

We recommend you record a **brief greeting message** (see sample on next page) in order to leave more time for recording new messages.

To record a greeting message

- 1 Press **GREETING REC** to start the recording mode.
 - “Press RECORD again to record greeting” is heard.
- 2 Within 5 seconds, press **GREETING REC** again to record your greeting.
 - A long beep sounds.
- 3 After the long beep, talk clearly, about 8 inches (20 cm) away from the **MIC** (microphone).
 - The base unit display shows the elapsed recording time.
 - If you record for over 2 minutes, the unit will automatically stop recording.
- 4 When finished, press **STOP**.
 - To **check** the recorded greeting, press **GREETING CHECK**.
 - To change the message, start again from step 1.

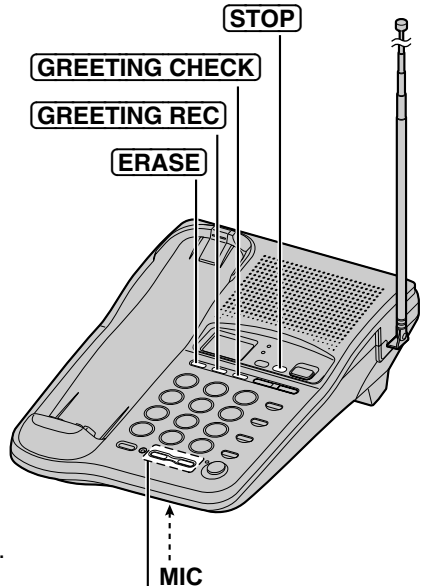

To increase the volume, press **VOLUME** .

To decrease, press **VOLUME** .

➡ Preparing the Answering System

Greeting message sample

“Hello, this is (your name and/or number). Sorry I cannot take your call. Please leave a message after the beep. Thank you.”

To erase the recorded greeting message

Press **[GREETING CHECK]** → press **[ERASE]** while the message is being played.

- The unit will answer a call with a pre-recorded greeting.

Pre-recorded greeting message

If you do not record a greeting message (p. 23), one of two messages will be played when a call is received, depending on the caller's recording time (p. 26).

To check the pre-recorded greeting, press **[GREETING CHECK].**

- A pre-recorded greeting will be played as follows:

■ When the recording time is set to “1 minute” or “3 minutes”:

“Hello, we are not available now. Please leave your name and phone number after the beep. We will return your call.”

■ When the recording time is set to “Greeting only”:

“Hello, we are not available now. Please call again. Thank you for your call.”

Flash Memory Message Backup

Messages are stored on a “flash memory” IC chip and will not be affected by power failures. All messages are saved until you erase them.

Programming Summary for the Answering System

You can program the following functions **using the handset near the base unit**. See the page numbers below for details.

Make sure the unit is in the standby mode initially.

Lift the handset, and press **FUNCTION/EDIT**.

Press **▼** or **▲** to select "Program", and press **▶** (Yes key).

Press **▼** or **▲** to select "TAD program", and press **▶** (Yes key).
 •"Answering system setting" is displayed on the handset.

To set **the remote code**, press **1**. (page 65)
 To select **the number of rings**, press **2**. (page 27)
 To select **the caller's recording time**, press **5**. (page 26)
 To store a **pager number**, press **#**. (pages 62, 63)
 •The base unit display shows numbers or characters related to the adjustment or settings.

Press **▶** (Save key).

- You can exit the programming mode any time by pressing **EXIT/CH**.
- If you do not press any buttons for 60 seconds, the unit will return to the standby mode.
- If 6 beeps sound on the base unit during programming, a wrong key was pressed. Enter the correct number.
- If the handset has lost communication with the base unit, 3 beeps sound and "No link to base Place on cradle and try again." is displayed on the handset.

➡ Preparing the Answering System

Selecting the Caller's Recording Time

You can select "1 minute", "3 minutes" or "Greeting only" for the caller's recording time. Your phone comes from the factory set to "3 minutes".

1 Press **FUNCTION/EDIT**.

▶Save directory
Ringer volume
▼▲ ▶=Yes

2 Press ▼ or ▲ repeatedly until the arrow points to "Program".

▶Program
▼▲ ▶=Yes

3 Press ▶ (Yes key).

▶LCD contrast
Set recall
▼▲ ▶=Yes

4 Press ▼ or ▲ repeatedly until the arrow points to "TAD program".

▶TAD program
▼▲ ▶=Yes

5 Press ▶ (Yes key).
•"P" is displayed on the base unit.

Answering
system setting
{■■■■}

6 Press **5**.
•The current setting is displayed on the base unit.
1: 1 minute
2: 3 minutes
3: Greeting only

7 Press **1**, **2** or **3** to select the recording time.
•The setting is displayed on the base unit.

8 Press ▶ (Save key).
•A beep sounds.
•To return to the standby mode, press **EXIT/CH**.

If you select "Greeting only", the unit will answer a call with the greeting message, and then hang up. The unit will not record any incoming messages.

Selecting the Number of Rings

You can select the number of times the unit rings before the answering system answers a call, from “2” to “7” or “AUTO (Toll saver*)”.

Your phone comes from the factory set to “AUTO”.

- 1 Press **FUNCTION/EDIT**.

▶Save directory
 Ringer volume
 ▼▲ ▶=Yes
- 2 Press ▼ or ▲ repeatedly until the arrow points to “Program”.

▶Program
 ▼▲ ▶=Yes
- 3 Press ► (Yes key).

▶LCD contrast
 Set recall
 ▼▲ ▶=Yes
- 4 Press ▼ or ▲ repeatedly until the arrow points to “TAD program”.

▶TAD program
 ▼▲ ▶=Yes
- 5 Press ► (Yes key).
 - “P” is displayed on the base unit.

Answering
 system setting
 {■■■■}
- 6 Press **2**.
 - The current setting is displayed on the base unit.
 - 0:** Selects “AUTO”. “A” is displayed on the base unit.
 - 2–7:** The unit will answer after the selected number of rings.
- 7 Press **0**, or **2** to **4** to set the number of rings.
 - The setting is displayed on the base unit.
- 8 Press ► (Save key).
 - A beep sounds.
 - To return to the standby mode, press **EXIT/CH**.

*Toll saver (when set to “AUTO”)

When you call the unit from a touch tone telephone:

If the unit answers on the 2nd ring, there is at least one new message.

If the unit answers on the 4th ring, there are no new messages.

Hang up when you hear the 3rd ring. This will save you the toll charge for the call.

Making Calls

With the Handset

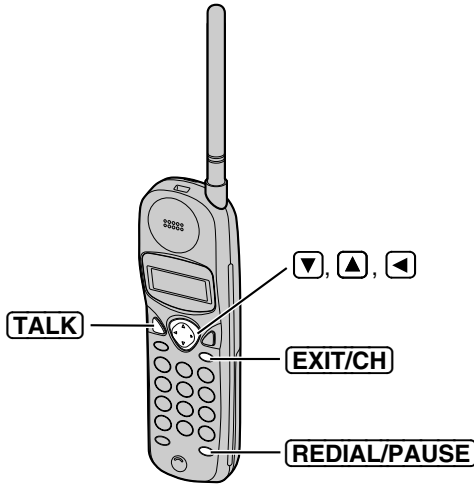

1 Press **TALK**.

Talk

2 Dial a phone number.

- The dialled number is displayed.
- After a few seconds, the display will show the length of the call and the battery strength.

Talk
01111112222

Talk
00-00-00 [■■■■]

3 To hang up, press **TALK** or place the handset on the base unit.

Off
00-01-08 [■■■■]

•If the handset has lost communication with the base unit, 3 beeps sound and “No link to base Place on cradle and try again.” is displayed.

If noise interferes with the conversation

Press **EXIT/CH** to select a clearer channel or move closer to the base unit.

To redial the last number dialled on the handset

Press **TALK** and press **REDIAL/PAUSE**.



To dial after confirming the entered number

- 1 Dial a phone number.
 - If you misdial, press and dial again.
- 2 Press **TALK**.
 - After a few seconds, the display will show the length of the call and the battery strength.
- 3 To hang up, press **TALK** or place the handset on the base unit.

0233334444

Talk
0233334444

Talk
00-00-00 [■■■■]

Off
00-01-08 [■■■■]

To redial after confirming the last number dialed

Press **REDIAL/PAUSE** and press **TALK**.

To adjust the receiver volume while talking

To increase, press .

To decrease press .

- Each time you press or , the volume level will change.
- The display will return to the length of the call.

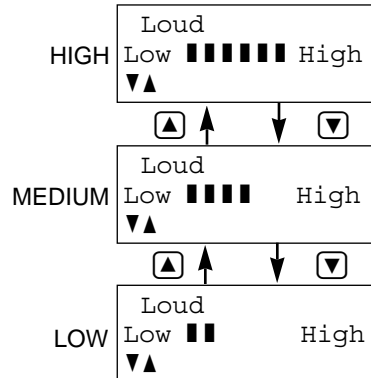

Backlit handset keypad

The handset dialling buttons will light when you press a button or lift the handset off the base unit, and flash when a call is received.

The lights will go out a few seconds after pressing a button, lifting the handset, answering a call, hanging up a call, leaving the programming mode or ending the intercom.

Backlit LCD display

The backlit handset display will stay on for a few seconds after pressing a handset button, lifting the handset off the base unit, hanging up a call, leaving the programming mode or ending the intercom.

➔ Making Calls

With the Base Unit (Digital Duplex Speakerphone)

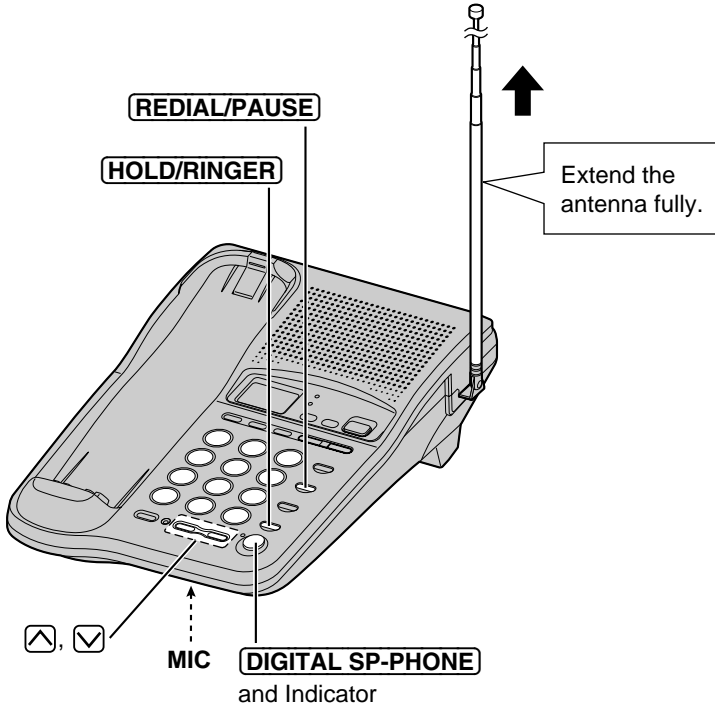

- 1 Press **DIGITAL SP-PHONE**.
 - The DIGITAL SP-PHONE indicator lights.
- 2 Dial a phone number.
- 3 When the other party answers, talk into the **MIC** (microphone).
- 4 To hang up, press **DIGITAL SP-PHONE**.
 - The indicator light goes out.

- To switch to the handset while using the base unit speakerphone:
 - If the handset is off the base unit, press **TALK**.
 - If on the base unit, just lift up.
- During a call using the handset, the call can be switched to the speakerphone by pressing **DIGITAL SP-PHONE**.



Hands-free Digital Duplex Speakerphone

For best performance, please note the following:

- Talk alternately with the caller in a quiet room.
- If the other party has difficulty hearing you, press **VOLUME** to decrease the speaker volume.
- If the other party's voice from the speaker cuts in/out during a conversation, press **VOLUME** to decrease the speaker volume.

To adjust the speaker volume (8 levels) while talking

To increase, press **VOLUME** .

To decrease, press **VOLUME** .

To redial the last number dialed on the base unit

Press **DIGITAL SP-PHONE** and press **REDIAL/PAUSE**.

To put a call on hold

Press **HOLD/RINGER**.

- The DIGITAL SP-PHONE indicator flashes.

To release the hold

From the base unit, press **DIGITAL SP-PHONE**.

From the handset, press **TALK** or lift the handset off the base unit.

- If another phone is connected on the same line (p. 75), you can also release the hold by lifting its handset.

➔ Making Calls

Simultaneous Keypad Dialling

You can use the base unit like a standard telephone. After pressing **TALK** to make a call with the handset near the base unit, you can also dial using the base unit keypad.

- 1 Handset:
Press **TALK**.
- 2 Base unit:
Dial a telephone number while hearing a dial tone on the handset.
 - When the other party answers, talk using the handset.
- 3 Handset:
To hang up, press **TALK** or place the handset on the base unit.



Simultaneous Keypad Dialling is only possible after pressing **TALK**.

Useful information

You can enter numbers using the base unit keypad during a call with the handset. For example, to access an answering service, electronic banking service, etc.

1. Handset:
Press **TALK**.
2. Handset:
Dial a telephone number.
 - You can also dial with the base unit keypad.
3. Base unit:
Enter the required numbers while listening to the pre-recorded instructions.
4. Handset:
To hang up, press **TALK** or place the handset on the base unit.

Answering Calls

When a call is received, the unit rings, "Incoming call" is displayed on the handset and the CALLER ID indicator flashes quickly. If you subscribe to a Caller ID service, the calling party information will be displayed after the first ring (p. 34). In order to view the Caller ID information, please wait until the second ring to answer a call.

With the Handset

If the handset is off the base unit, press **TALK**.

- You can also answer a call by pressing any dialling button **0** to **9**, ***** or **#** (—Any Key Talk).



Auto Talk

If you set the Auto Talk feature to ON (p. 19), you can answer a call by lifting the handset off the base unit without pressing **TALK**.



With the Base Unit (Digital Duplex Speakerphone)

- 1 Press **DIGITAL SP-PHONE**.
- 2 Talk into the **MIC**.
- 3 To hang up, press **DIGITAL SP-PHONE**.

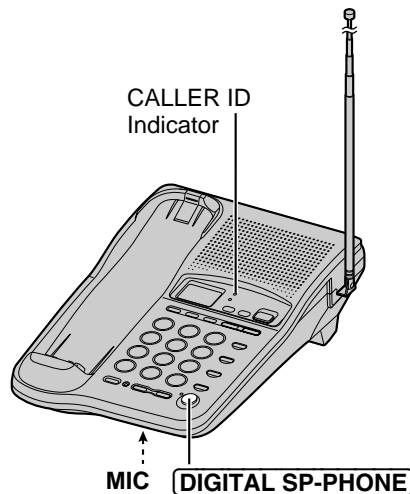

Caller ID Service

This unit is compatible with a Caller ID service offered by your telephone company. If you subscribe to a Caller ID service, the calling party's information will be shown on the handset display after the first ring.

The unit can record information of up to 50 different callers in the Caller List. The Caller List information is sorted by the most recent to the oldest call. When the 51st call is received, the first call is deleted.

Using the list, you can automatically call back a caller. You can store the callers' phone numbers from the Caller List into the directory.

When a second call is received while talking, the new caller's phone number will be displayed (**for Australia only**) (p. 55).

How caller information is displayed when a call is received

The handset display shows the caller's phone number after the first ring.*

- For Australia users, the caller's phone number will be displayed as 10 digits. For New Zealand users, the caller's phone number will be displayed as 9 digits.
- After you answer the call, the display will show the length of the call.

0244448888

The CALLER ID indicator light will flash quickly when a call is being received.

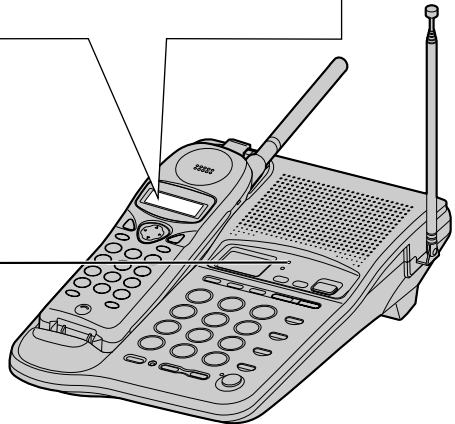

*Private name display

If you receive a call from one of the same phone numbers stored in the directory, the caller's name will be displayed.

- To use this function, names and phone numbers must be stored in the directory (p. 44).

TINA ROBINSON
0244448888

- Caller information cannot be displayed in the following cases:
 - If the caller dialed from an area which does not provide a Caller ID service, the display will show "Out of area".
 - If the caller has requested not to display his/her information, the display will show "Private caller".
- If your unit is connected to a PBX which does not support Caller ID services, you cannot access those services.
- If the name and the time/date display service is available in your area, the display will show callers' names and the time/date the calls were received. For further information, please contact your telephone company.

For New Zealand Users:

Your telephone company may not support the second caller display feature.

To check the number of new calls

When new calls have been received, the CALLER ID indicator flashes slowly on the base unit. The handset displays show the number of new calls.

While the handset is on the base unit:

If you have received 10 new calls, the display will show the following.

```
10 new calls
  [||||]
```

When you lift the handset, the display changes to the following.

```
10 new calls
▼=New    ▲=Old
```

- After 10 seconds, the display changes to the standby mode (p. 15).

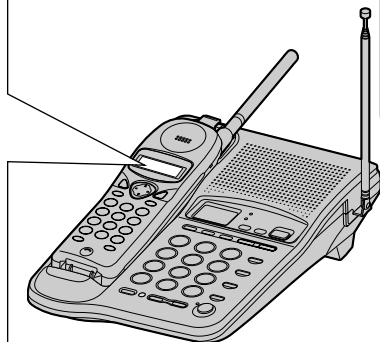

While the handset is off the base unit:

Press ◀ or ▶ to turn the display on. If you have received 10 new calls, the display will show the following:

```
10 new calls
▼=New    ▲=Old
```

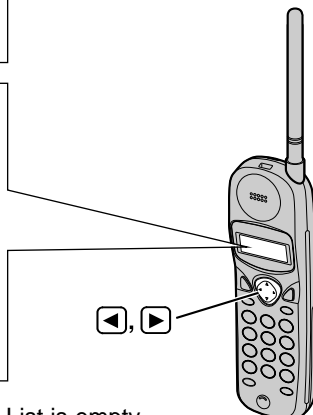



- If "No items stored" is displayed, the Caller List is empty.

Using the Caller List





Viewing the Caller List

To check who has called, follow the steps below.

Make sure the unit is in the standby mode initially.

- 1 Lift the handset off the base unit.
OR
If the handset is off the base unit, press  or  to enter the list.
 - The display will show, for example, the following.

| |
|-------------|
| 2 new calls |
| ▼=New ▲=Old |

- 2 To search from the most recent call, press .
To search from the oldest call, press .
 - To scroll between callers, press  or .
- 3 To exit the list, press **EXIT/CH**.
 - The handset will return to the standby mode.

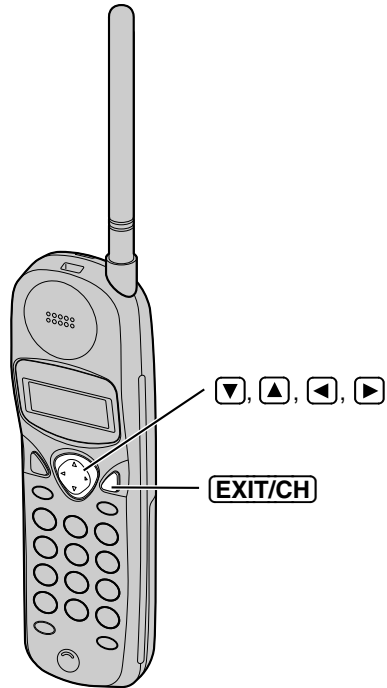

- Once new calls have been checked, “√” will be added.
- If “Caller's list No items stored” is displayed in step 1, the Caller List is empty.
- If more than one call is received from the same caller, the date and time of the last call will be recorded. If the same caller calls again, the call entry with “√” will be deleted.



Ex. When you search from the most recent call:

Lift the handset off the base unit.

OR

If the handset is off the base unit, press or .

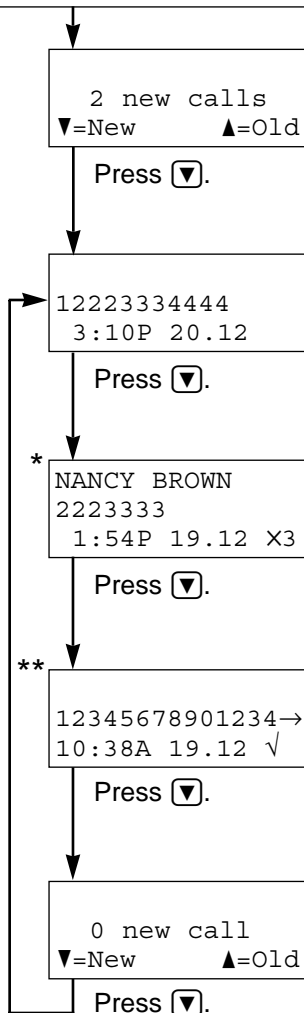

To return to the previous caller, press .

To exit the Caller List, press **EXIT/CH**.

•The handset will return to the standby mode.

*If you receive a call from one of the same phone numbers stored in the directory, the caller's name will be displayed (**Private name display**).

**If an arrow (→) is displayed after the number, the whole phone number has not been shown.

Press **#** (→) to see the remaining numbers or ***** (←) to return to the previous display.

Display meaning:

✓ : You have checked this caller information, answered the call, called back the caller or played back the message (p. 58).

X2 - X9 : The number of times the same caller called (up to 9).
After checking, "X2" - "X9" will be replaced with "✓".

➔ Using the Caller List

Calling Back from the Caller List

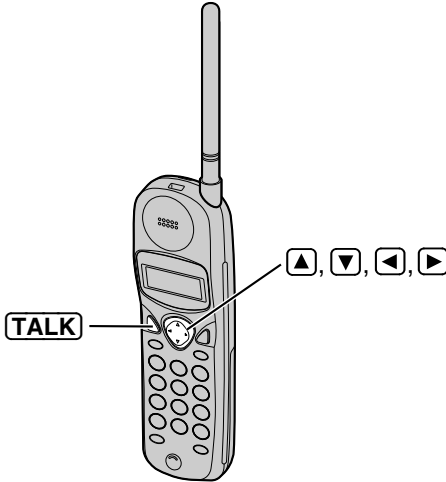

- 1 Lift the handset off the base unit.
OR
If the handset is off the base unit,
press ◀ or ▶ to enter the list.

```
3 new calls
▼=New      ▲=Old
```

- 2 Press ▼ or ▲ repeatedly to find the
desired caller.

```
0355566677
11:20A 20.12 X3
```

- 3 Press **TALK**.
•The displayed phone number is dialed
automatically.

```
Talk
0355566677
```

```
Talk
00-00-00 [■■■■]
```

- If a phone number is not displayed in the caller information, you cannot call back that caller.

For New Zealand Users:

Your telephone service provider may charge you for a local call when it is dialled with an area code prefix. If the charge for local call is unacceptable, only the 7-digits of the local number should be dialled from your telephone. Do not dial the "0" prefix or the area code digit.



Editing the Caller's Phone Number

You can edit a phone number in the Caller List. After editing the number, you can continue with calling back or directory storing procedures.

Make sure the unit is in the standby mode initially.

- 1 Lift the handset off the base unit.
OR

If the handset is off the base unit, press or to enter the list.

5 new calls
▼=New ▲=Old

- 2 Press or repeatedly to find the desired caller.

0355566677
11:20A 20.12 ✓

- 3 **To add a number**
Add a number to the current number.

•If you misdial, press and dial again.

To erase the number

Press **FUNCTION/EDIT**, then press to erase the digit.

•You can also add a number if required.

- 4 After editing the number, you can continue with calling back or storing procedures.

To call back, press **TALK** (p. 38).

To store the number in the directory, press and follow the instructions on the display (see page 40, from step 3).

- If the phone number does not include the area code (which is the same as your area code, p. 22), you can view the original number (area code + phone number) by pressing **FUNCTION/EDIT** again in step 3.
- The number edited in step 4 will not be maintained in the Caller List.

For New Zealand Users:

Your telephone service provider may charge you for a local call when it is dialled with an area code prefix. If the charge for local call is unacceptable, only the 7-digits of the local number should be dialled from your telephone. Do not dial the "0" prefix or the area code digit.

➡ Using the Caller List

Storing Caller List Information in the Directory

You can store names and phone numbers that are in the Caller List into the directory. **Storing must be carried out with the handset.**

Make sure the unit is in the standby mode initially.

- 1 Lift the handset off the base unit.
OR
If the handset is off the base unit,
press ◀ or ▶ to enter the list.

```
10 new calls
▼=New      ▲=Old
```

- 2 Press ▼ or ▲ repeatedly to find the
caller you want to store in the directory,
and press ▶.

```
0355566677
11:20A 20.12 X3
```

```
▶Save directory
Clear
▼▲          ▶=Yes
```

- 3 Press ▼ or ▲ to select "Save
directory", and press ▶ (Yes key).

```
Enter name
█
*#=←→     ▶=Save
```

When the caller's name is not displayed in the Caller List:

- a) If a name is not required,
press ▶ (Save key).
b) If a name is required, enter the
name (p. 46). When finished,
press ▶ (Save key).

```
Enter name
CINDY TURNER
*#=←→     ▶=Save
```

```
CINDY TURNER
0355566677
```

- A beep sounds.
- To continue storing other items, repeat from step 2.
- To return to the standby mode, press **EXIT/CH**.

- You can exit the programming mode any time by pressing **EXIT/CH**.
- If the display shows "Memory is full" in step 3, press **EXIT/CH** to exit the list. To erase other stored items from the directory, see page 51.
- After the maximum of 30 items has been stored, "Memory is full" is also displayed.
- You cannot store caller information in the directory if a phone number is not displayed.



For New Zealand Users:

Your telephone service provider may charge you for a local call when it is dialled with an area code prefix. If the charge for local call is unacceptable, only the 7-digits of the local number should be dialled from your telephone. Do not dial the "0" prefix or the area code digit.

Erasing Caller List Information

After checking the Caller List, you can erase some or all of the entries. **Make sure the unit is in the standby mode initially.**

To erase a specific caller from the Caller List

- 1 Lift the handset off the base unit.
OR
If the handset is off the base unit, press or to enter the list.

| |
|------------------|
| 10 new calls |
| ▼=New ▲=Old |

- 2 Press or repeatedly to find the caller you want to erase from the Caller List, and press .

| |
|----------------|
| 0246813579 |
| 12:20A 20.12 ✓ |

| |
|-----------------|
| ▶Save directory |
| Clear |
| ▼▲ ▶=Yes |

- 3 Press or to select "Clear", and press (Yes key).
 - A beep sounds and the information is erased.
 - To erase other items, repeat from step 2.
 - To return to the standby mode, press **EXIT/CH**.



| |
|----------------|
| Save directory |
| ▶Clear |
| ▼▲ ▶=Yes |

| |
|-------|
| Clear |
|-------|

➔ Using the Caller List

To erase all entries in the Caller List



Before erasing all entries, make sure that "0 new call" is displayed.

- 1 Lift the handset off the base unit.
OR
If the handset is off the base unit,
press  or  to enter the list.

```
Exit
▶All clear
▼▲                ▶=Yes
```

- 2 Press  (Yes key).

```
All clear
```

- 3 Press  or  to select "All clear".

```
0 new call
▼=New          ▲=Old
```

- 4 Press  (Yes key).
•A beep sounds and all entries are erased.

```
▶Exit
All clear
▼▲                ▶=Yes
```

Speed Dialler

Storing Phone Numbers in Memory

You can store up to 10 numbers in the base unit. The dialling buttons (0 to 9) function as memory stations.

Make sure the unit is in the standby mode initially.

- 1 Press **AUTO/PROGRAM**.
 - The IN USE/CHARGE indicator flashes.
 - 2 Enter a phone number up to 22 digits.
 - If you misdial, press **AUTO/PROGRAM** twice to end storing and start again from step 1.
 - 3 Press **AUTO/PROGRAM**.
 - 4 Press a memory station number (0 to 9).
 - A beep sounds.
 - To store other numbers, repeat steps 1 through 4.
- If a pause is required for dialling, press **REDIAL/PAUSE** where needed. Pressing **REDIAL/PAUSE** counts as one digit (p. 54).

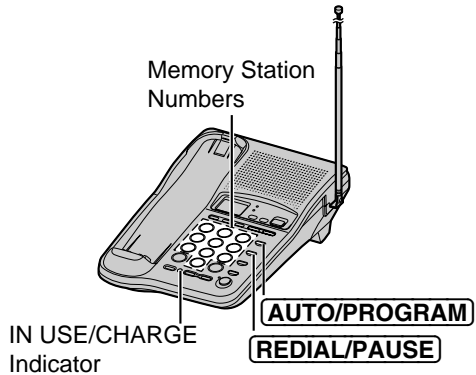

To erase a stored number

Press **AUTO/PROGRAM** twice ➔ the memory station number (0 to 9) for the phone number to be erased.

Dialling a Stored Number

- 1 Press **DIGITAL SP-PHONE**.
- 2 Press **AUTO/PROGRAM**.
- 3 Press the memory station number (0 to 9).
 - The stored number is dialled.

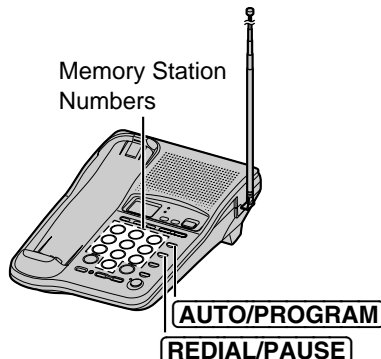

- Numbers stored can only be dialled by the base unit.

Using the Directory

You can store up to 30 names and phone numbers in the directory using the handset. All directory items are sorted by the first word in alphabetical order. Using the directory, you can make a call by selecting a name on the handset display. When you receive a caller ID call from a caller stored in the directory, the display will show the caller's name with the phone number (—**Private name display**) (p. 34).

Storing Names and Numbers in the Directory

Make sure the unit is in the standby mode initially.

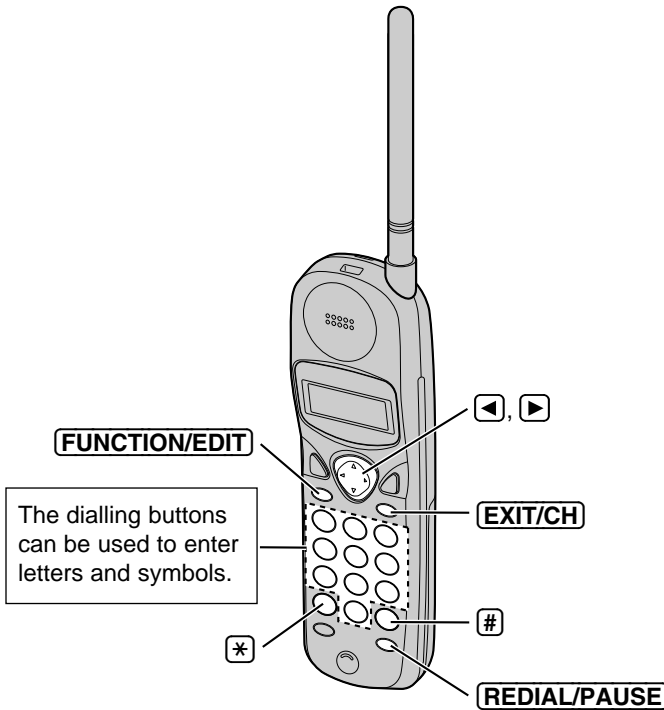



1 Press **FUNCTION/EDIT**.

```
▶Save directory
Ringer volume
▼▲           ▶=Yes
```

2 While the arrow points to "Save directory", press **▶** (Yes key).

- The display shows the number of stored items in the directory.

```
Directory=
20 items
```

3 Enter a name, up to 15 characters using the dialling buttons (p. 46).

- To move the cursor, press ***** (←) or **#** (→).
- If a name is not required, press **▶** (Next key) and go to step 5.

```
Enter name
█
*#=←→       ▶=Next
```

```
Enter name
Tom Jones █
*#=←→       ▶=Next
```

4 Press **▶** (Next key).

```
Enter phone no.
```

5 Enter a phone number, up to 22 digits.

- If you misdial, press **◀**. Digits are erased from the right.

```
03987654321 █
▶=Save
```

6 Press **▶** (Save key).

- A beep sounds.
- To continue storing other items, repeat from step 2.
- To return to the standby mode, press

EXIT/CH.

```
Tom Jones
0987654321
```

- If a pause is required for dialling, **REDIAL/PAUSE** can be stored in a phone number in step 5. This counts as one digit (p. 54).
- You can exit the programming mode any time by pressing **EXIT/CH**.
- If the display shows "Memory is full" in step 2, press **EXIT/CH**. To erase other stored items from the directory, see page 51.
- After the maximum of 30 items has been stored, "Memory is full" is also displayed.

For New Zealand Users:

Your telephone service provider may charge you for a local call when it is dialled with an area code prefix. If the charge for local call is unacceptable, only the 7-digits of the local number should be dialled from your telephone. Do not dial the "0" prefix or the area code digit.

➔ Using the Directory

Selecting Characters to Enter Names

The handset dialling buttons can be used to enter letters and symbols. The letters are printed on the dialling buttons.

Pressing each button selects a character as shown below.

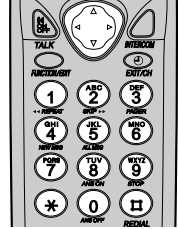

| Keys | Number of times key is pressed | | | | | | | | | | |
|------|---------------------------------|-------|---|---|---|---|---|---|---|----|----|
| | 1 | 2 | 3 | 4 | 5 | 6 | 7 | 8 | 9 | 10 | 11 |
| 1 | # | & | ' | (|) | * | , | - | . | / | 1 |
| 2 | A | B | C | a | b | c | 2 | | | | |
| 3 | D | E | F | d | e | f | 3 | | | | |
| 4 | G | H | I | g | h | i | 4 | | | | |
| 5 | J | K | L | j | k | l | 5 | | | | |
| 6 | M | N | O | m | n | o | 6 | | | | |
| 7 | P | Q | R | S | p | q | r | s | 7 | | |
| 8 | T | U | V | t | u | v | 8 | | | | |
| 9 | W | X | Y | Z | w | x | y | z | 9 | | |
| 0 | 0 | Blank | | | | | | | | | |
| * | To move the cursor to the left | | | | | | | | | | |
| # | To move the cursor to the right | | | | | | | | | | |







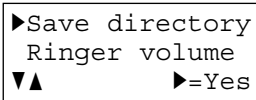
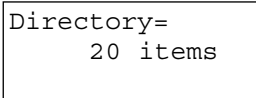
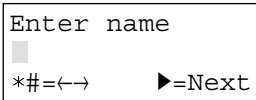

- To enter another character using the same dialling button, press **#** to move the cursor to the next space.

If you make a mistake while entering a name

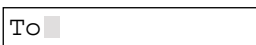
Use ***** (←) or **#** (→) to move the cursor to the incorrect character, press **◀** to delete and enter the correct character. Each time you press **◀**, a character is erased from the right.

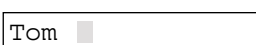
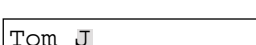

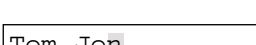
For example, to enter “Tom Jones”:

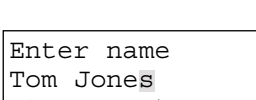
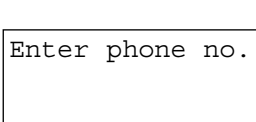

- 1 Press **FUNCTION/EDIT**.

- 2 While the arrow points to “Save directory”, press **▶** (Yes key).

- 3 Press **8**.

- 4 Press **6** six times, then press **#** to move the cursor to the right.

- 5 Press **6** four times.

- 6 Press **#** twice to enter a blank.

- 7 Press **5**.

- 8 Press **6** six times, then press **#** to move the cursor to the right.

- 9 Press **6** five times.

- 10 Press **3** five times.

- 11 Press **7** eight times.

- 12 When finished, press **▶** (Next key).
 - To enter a phone number and continue storing, see page 45, from step 5.

➔ Using the Directory

Finding Items in the Directory

You can search the directory using the handset.



Make sure the unit is in the standby mode initially.

1 Press  or  to enter the directory list.

- The first item is displayed.

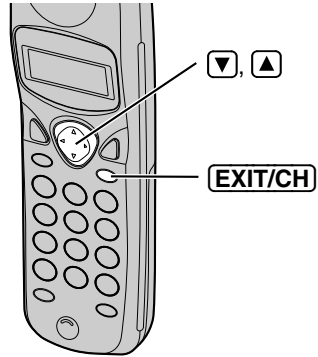
Ann
0312345678



2 Press  or  repeatedly until the desired item is displayed.

- All directory items are stored in the order shown on the right.

To search for a name by initial

① Press the dialling button for the first letter of the desired name until any name with the same initial is displayed (see the Index table on page 49).
Ex. To find "Frank", press  repeatedly until the first item under "F" is displayed.

② Press  repeatedly until the name is displayed.

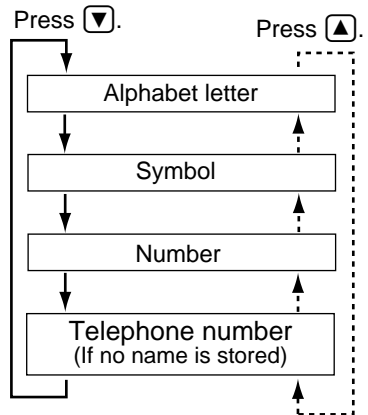

- You can leave the directory list any time by pressing **EXIT/CH**.

- If "Directory list No items stored" is displayed in step 1, the directory is empty.



Index table

| Keys | Index | Keys | Index |
|------|------------------|------|---------------|
| ① | Other symbols, 1 | ⑥ | M, N, O, 6 |
| ② | A, B, C, 2 | ⑦ | P, Q, R, S, 7 |
| ③ | D, E, F, 3 | ⑧ | T, U, V, 8 |
| ④ | G, H, I, 4 | ⑨ | W, X, Y, Z, 9 |
| ⑤ | J, K, L, 5 | ⑩ | 0 |

Dialling from the Directory

Make sure the unit is in the standby mode initially.

- 1 Press **▼** or **▲** repeatedly to find the directory item that you want to dial.
 - To search for the item by initial, see page 48.
 - To exit the directory, press **EXIT/CH**.

| |
|---------------------|
| Frank 0234567890 |
|---------------------|

- 2 Press **TALK**.
 - The number is dialled automatically.

| |
|--------------------|
| Talk 0234567890 |
|--------------------|

- 3 To hang up, press **TALK** or place the handset on the base unit.

- Numbers stored can only be dialled by the handset.

➔ Using the Directory

Editing an Item in the Directory

Make sure the unit is in the standby mode initially.

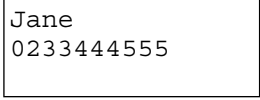
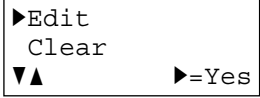
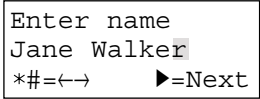
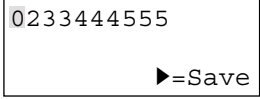
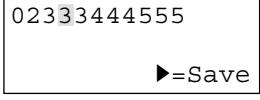
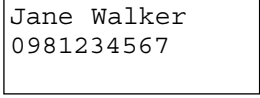
- 1 Press **▼** or **▲** repeatedly to find the directory item you want to change, and press **▶**.
•To search for the item by initial, see page 49.

- 2 While the arrow points to "Edit", press **▶** (Yes key).
•If you do not need to change the name, go to step 4.

- 3 Edit the name by using the dialling buttons, *** (←)** or **# (→)** (p. 46), up to 15 characters.

- 4 Press **▶** (Next key).
•If you do not need to change the number, go to step 6.

- 5 Add a number to the current number.
•Each time you press **◀** the digit to the left of the cursor is erased.

- 6 When finished, press **▶** (Save key).
•A beep sounds.
•To continue editing other items, repeat from step 1.
•To return to the standby mode, press **EXIT/CH**.

•You can exit the programming mode any time by pressing **EXIT/CH**.

Erasing an Item from the Directory

Make sure the unit is in the standby mode initially.



1 Press  or  repeatedly to find the directory item you want to erase.

- To search for the item by initial, see page 48.

```
Helen
0357924680
```

2 Press .

```
▶Edit
  Clear
▼▲                               ▶=Yes
```

3 Press  or  to select "Clear".

```
  Edit
▶Clear
▼▲                               ▶=Yes
```

4 Press  (Yes key).

- A beep sounds and the item is erased.
- To erase other items, repeat from step 1.
- To return to the standby mode, press

EXIT/CH.

```
Clear
```

- You can exit the programming mode any time by pressing **EXIT/CH**.

Intercom

A 2-way intercom is possible between the handset and the base unit.

Paging the base unit from the handset

- 1 Handset:
Press **INTERCOM**.
Talk to the paged party after the beeps.
 - “Intercom” is displayed.
- 2 Base unit:
When the other party's voice is heard, answer using the **MIC**.
- 3 Handset:
To end the intercom, press **INTERCOM**.

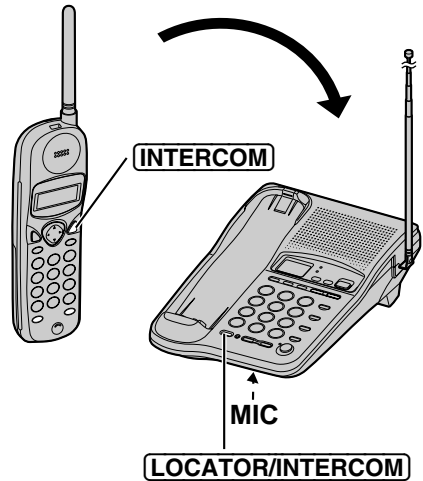

Paging the handset from the base unit (Handset locator)

Using this feature, you can locate a misplaced handset.

- 1 Base unit:
Press **LOCATOR/INTERCOM**.
 - The handset beeps for 1 minute and “Press INTERCOM” is displayed.
 - To stop paging, press **LOCATOR/INTERCOM** again.
- 2 Handset:
Press **INTERCOM** to answer.
 - “Intercom” is displayed.
- 3 Base unit:
Talk into the **MIC**.
- 4 Handset:
To end the intercom, press **INTERCOM**.

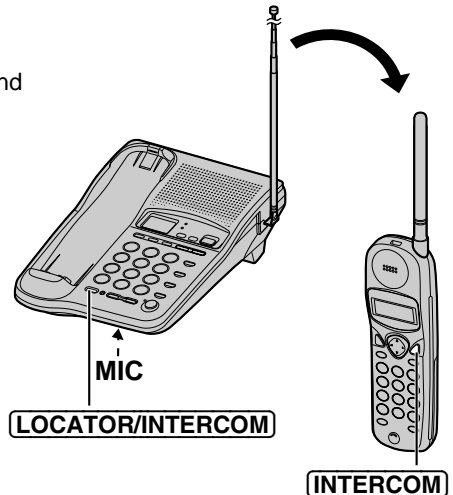

During an intercom call:

- Intercom calls can only be ended with the handset.
- If the handset user has difficulty hearing the base unit user, decrease the base unit speaker volume by pressing **VOLUME** .
- If an incoming call is received, the intercom call stops and the unit starts to ring. To answer, press **TALK** or **DIGITAL SP-PHONE**.

Transferring a Call Using the Intercom

The intercom can be used during a call. This feature enables you to transfer a call between the handset and the base unit.

From the handset to the base unit

- 1** Handset:
During a call, press **INTERCOM**. Talk to the paged party after the beeps.
 - The call is put on hold and “Intercom hold” is displayed.
 - If the base unit user does not answer, press **TALK**.
- 2** Base unit:
When the paging party’s voice is heard, answer using the **MIC**.
- 3** Base unit:
To answer the call, press **DIGITAL SP-PHONE**.
 - The transfer is complete.

From the base unit to the handset

- 1** Base unit:
During a call, press **LOCATOR/INTERCOM**.
 - The call is put on hold.
 - If the handset user does not answer, press **DIGITAL SP-PHONE**.
- 2** Handset:
Press **INTERCOM** to answer the page.
 - “Intercom hold” is displayed.
- 3** Handset:
To answer the call, press **TALK**.
 - The transfer is complete.

Special Features

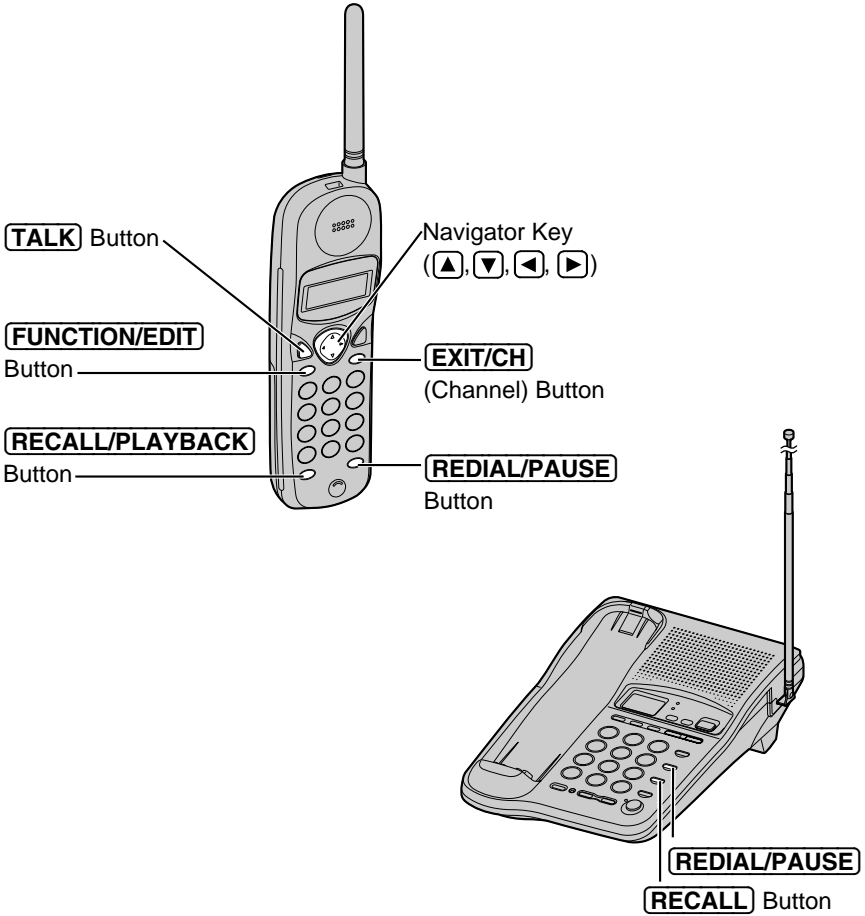

How to Use the PAUSE Button (For Analog PBX Line/Long Distance Service Users)

We recommend you press **REDIAL/PAUSE** if a pause is required for dialling with a PBX or to access a long distance service.

Ex. Line access number **9** (PBX)

9 → **REDIAL/PAUSE** → Phone number

- Pressing **REDIAL/PAUSE** once creates a 3.5 second pause. This prevents misdialling when you redial or dial a stored number.
- Pressing **REDIAL/PAUSE** more than once increases the length of the pause between numbers.



Automatic Security Code Setting

Each time you place the handset on the base unit, the unit automatically selects one of more than a million security codes. These codes help prevent the unauthorized use of your telephone line by another cordless telephone user.

Call Waiting and Caller ID Compatible (For Australia only)

If you subscribe to Caller ID services, your handset displays a second caller's information while talking. After you hear a call-waiting tone, the caller's phone number and "----Waiting-----" will be displayed.

| |
|--------------------------------|
| 0266667777 ----Waiting----- |
|--------------------------------|

You can answer the second call, keeping the first call on hold. Follow Telstra's instructions using **RECALL/PLAYBACK** or **RECALL**.

- If the phone number is stored in the directory, the caller's name will be displayed (p. 34).
- The second caller's information will not be displayed when:
 - the answering system is recording someone's message,
 - a parallel connected telephone is in use.
- Please contact Telstra for details and availability in your area.
- When you receive a second call during a conversation, you will hear a signal tone following the call waiting tone and the conversation will be interrupted for approximately a second. The tones are generated from the telephone company. This is not fault of the product as these events are normal.

For Call Waiting Service Users in New Zealand

Make sure the recall time is set to 600 msec for use with Telecom's Call Waiting Service. Press **RECALL/PLAYBACK** or **RECALL** if you hear a call-waiting tone while talking.

- The first call is put on hold and you can answer the second call.
- To return to the first caller, press **RECALL/PLAYBACK** or **RECALL** again.
- Your telephone company may not support the second caller display feature.

RECALL Button

Pressing **RECALL/PLAYBACK** or **RECALL** allows you to use special features of your host PBX such as transferring an extension call or accessing special telephone services (optional) such as call waiting.

➡ Special Features

Selecting the recall time

The recall time depends on your telephone exchange or host PBX. You can select the following recall times: “700, 600, 400, 300, 250, 110, 100 or 90 ms (milliseconds)”. KX-TC1230ALW comes from the factory set to “100 ms” and KX-TC1230NZW comes from the factory set to “600 ms”. **Make sure the unit is in the standby mode initially.**

1 Press **FUNCTION/EDIT**.

2 Press **▼** or **▲** repeatedly until the arrow points to “Program”.

| |
|----------|
| ▶Program |
| ▼▲ ▶=Yes |

3 Press **▶** (Yes key).

4 Press **▼** or **▲** repeatedly until the arrow points to “Set recall”.

| |
|--------------|
| LCD contrast |
| ▶Set recall |
| ▼▲ ▶=Yes |

5 Press **▶** (Yes key).

6 Press **▼** or **▲** repeatedly until the desired time is displayed.

7 Press **▶** (Save key).

- A beep sounds.
- To return to the standby mode, press **EXIT/CH**.

- You can exit the programming mode any time by pressing **EXIT/CH**.
- Users in Australia can access Telstra’s “EASY CALL” service by having the recall time set at 100 msec (this is the factory default setting), and then follow Telstra’s “EASY CALL” instructions to operate this service.
- If you are connected via a PBX, a longer recall time may be necessary to use PBX functions (transferring a call etc.). Consult your PBX supplier for the correct setting.

For Call Waiting Service Users in New Zealand

Make sure the recall time is set to 600 msec for use with Telecom’s Call Waiting Service. Press **RECALL/PLAYBACK** or **RECALL** if you hear a call-waiting tone while talking.

- The first call is put on hold and you can answer the second call.
- To return to the first caller, press **RECALL/PLAYBACK** or **RECALL** again.
- Your telephone company may not support the second caller display feature.

Automatic Answering Operation

When the unit answers a call, a greeting message is played and the caller's message is recorded.

- The total recording time (including greeting message) is **about 15 minutes**. If messages are recorded in noisy rooms, the time may be shortened by up to 3 minutes.
- A maximum of 64 messages (including greeting message) can be recorded.

Setting the Unit to Answer Calls

Press **ANSWER ON** to turn on the answering system.

- The indicator lights and "Answer set" is heard.
- The unit will announce the remaining recording time if it is less than 5 minutes.
- If you hear "Memory full", "**FULL**" is displayed on the base unit and the ANSWER ON indicator flashes rapidly, erase some, or all, of the messages (p. 61).



- If you do not want the unit to answer calls, press **ANSWER ON** again to turn off the answering system. The indicator light goes out and "Answer off" is heard.
- You can also turn on the answering system remotely using any other phone (p. 69).
- KX-TC1230NZW will not answer incoming calls on your FaxAbility number.

Monitoring incoming calls

While a call is being recorded, you can monitor it through the base unit speaker.

To answer the call with the base unit, press **DIGITAL SP-PHONE**.

For the handset, press **TALK**. The unit stops recording.

Listening to Messages

You can see the total number of recorded messages on the base unit display. If the ANSWER ON indicator flashes, new messages have been recorded.

Listening to only new messages

Press **NEW MESSAGE** briefly.

- The unit announces the number of new messages and plays them back.

Listening to all recorded messages

Press and hold **NEW MESSAGE** until playback starts.

- At the end of the last message, "End of final message" is heard. The unit will announce the remaining recording time if it is less than 5 minutes.

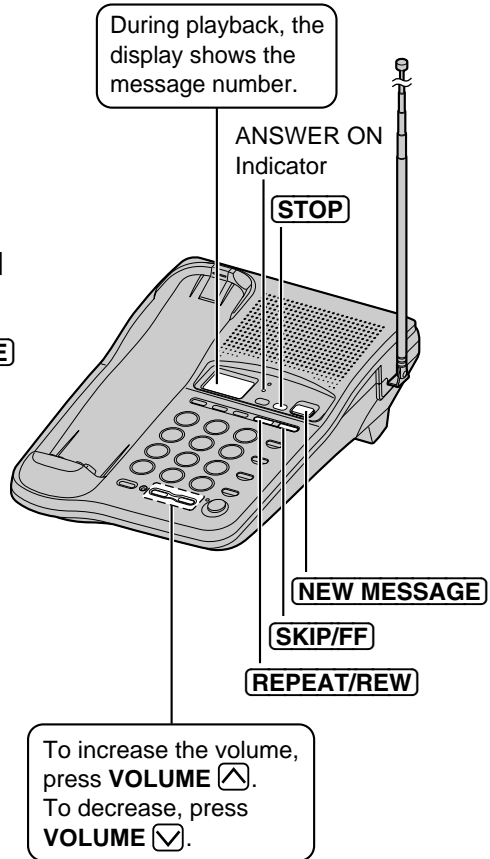



During playback

| | |
|------------------------------------------|--------------------------------------------------------------------------------------------------------------------------------------------------------------------------------------------------------------------------------------------------------------------------------------------------------------------------------------------------------|
| To repeat/ rewind message | To repeat from the beginning of the message Press [REPEAT/REW] briefly. •If you press within 5 seconds of playback, the previous message will be played. To rewind part of the message Press and hold [REPEAT/REW] until you reach the desired place. •At the beginning of the message, 3 beeps will sound. |
| To skip/cue message | To skip to the next message Press [SKIP/FF] briefly. To cue to part of the message Press and hold [SKIP/FF] until you reach the desired place. •The message will be heard at twice the normal speed. •At the end of the message, 3 beeps will sound. |
| To stop operation | Press [STOP] . •To resume playback, press [NEW MESSAGE] . •If you do not press any button for 60 seconds or if you press [STOP] again, the unit will return to the standby mode. |

For Caller ID service users (p. 34)

During playback, when the handset is on the base unit, the handset display will show the name and/or number of the caller whose message is being played.



To call back the displayed number:

During playback, lift the handset and press **[TALK]** within 10 seconds.

•The unit stops playback and automatically dials the displayed phone number.

•After listening to new incoming messages, “√” will be added to the call entries in the Caller ID Caller List (p. 37).

➔ Listening to Messages

From the Handset

If someone else is in the room and you want to listen to the recorded messages privately, you can use the handset.

- 1 Handset:
Press **RECALL/PLAYBACK**.
 - The number of new messages is heard on the handset.
- 2 Base unit:
To listen to new messages, press **NEW MESSAGE** briefly.
To listen to all messages, press and hold **NEW MESSAGE** until playback starts.
 - The messages will be heard on the handset.
 - REPEAT/REW**, **SKIP/FF** and **STOP** can also be used during playback (p. 59).
- 3 When finished, press **RECALL/PLAYBACK** or place the handset on the base unit.



•You can also listen to messages without using the base unit. See page 70.

Erasing Messages

The unit will announce the remaining recording time after playback, if it is less than 5 minutes. New messages cannot be recorded when:

- “Memory full” is heard.
- “**FULL**” is displayed on the base unit.
- the ANSWER ON indicator flashes rapidly.

Erase some, or all, of the messages. We recommend you erase unnecessary messages after each playback.

Erasing a specific message

Press **ERASE** while the message you want to erase is being played.

- The unit erases the message.
- A short beep will sound and the unit will continue to play the next message.

Erasing all messages

All recorded messages, except the greeting message, can be erased at one time.

- 1 Press **ERASE**.
 - “Press ERASE again to erase all messages” is heard.
- 2 Within 5 seconds, press **ERASE** again.
 - A beep sounds and “No messages” is heard.
 - The base unit display shows “0”.

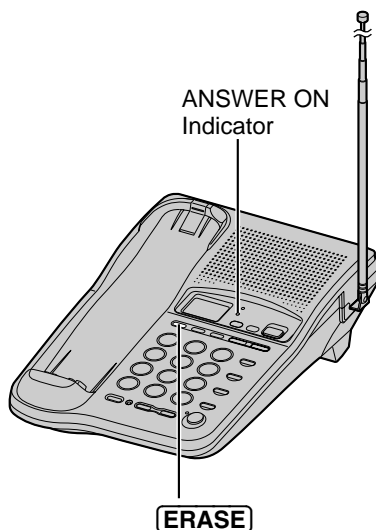

- The information in the Caller List will not be erased. To erase Caller List information, see page 41.

Pager Call

This feature allows you to alert your pager when the unit records an incoming message. You can retrieve the message from a touch tone telephone (p. 64).

First store the pager number, then set the unit to call the pager.

- Consult your pager company to check whether the service alerts your pager automatically or via an operator. If an operator is used, this feature cannot be used.

Make sure that the unit is in the standby mode initially.

Storing a Pager Number

1 Press **FUNCTION/EDIT**.

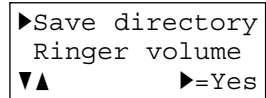

2 Press **▼** or **▲** repeatedly until the arrow points to "Program".

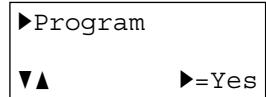

3 Press **▶** (Yes key).

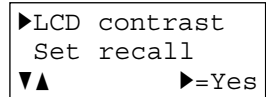

4 Press **▼** or **▲** repeatedly until the arrow points to "TAD program".

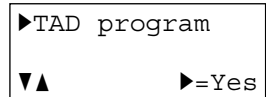

5 Press **▶** (Yes key).
•"P" is displayed on the base unit.

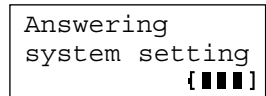

6 Press **#**.
•"-" is displayed on the base unit.

7 ①Enter your pager number, and press **REDIAL/PAUSE** twice.*
Enter the access code, if required by your pager company, and press **REDIAL/PAUSE** twice again.*
②Enter the call back number to be displayed on the pager (the telephone number where your unit is connected).
③Press **#** if required by your pager company.
•The entered number is displayed on the base unit.
•If you misdial, press **◀** and start again from step 5.
•You can enter a total of 48 digits.

8 Press **▶** (Save key).

- A beep sounds.
- To return to the standby mode, press **EXIT/CH**.

* Pager companies require a delay after the pager number and/or the access code is dialed. Contact your pager company regarding the required pause time. Pressing **REDIAL/PAUSE** once creates a 3.5 second delay and counts as one digit.

•If the line has rotary or pulse service, press ***** between the pager number and **REDIAL/PAUSE** in step 7.

To confirm the stored pager number

Press **DIGITAL SP-PHONE** ➔ **AUTO/PROGRAM** ➔ **#**.

- The unit dials the stored pager number.
- If the pager does not beep, check your pager by calling it manually to ensure it works. Store the pager number again.

To erase the stored pager number

Repeat steps 1 to 6 on page 62 ➔ press **▶** (Yes key) ➔ press **EXIT/CH**.

- The pager call mode will automatically return to OFF.

Setting the Unit to Call a Pager

1 Press **RECALL/PLAYBACK**.

- The number of new messages is heard on the handset.

2 Press **3**.

- “**PAGER**” is displayed on the base unit.
- If “**PAGER**” is not displayed, the pager number is not stored. Store the number (p. 62, 63), and try again.

3 Press **RECALL/PLAYBACK**.

To turn off the pager call mode, repeat steps 1 through 3.

- “**PAGER**” will disappear.
- Each time you press **3** in step 2, the mode will turn on or off.

RECALL/PLAYBACK



Remote Operation from a Touch Tone Phone

You can operate the answering system from any touch tone phone. A synthesized voice menu will guide you on how to operate the unit (p. 66).

- To skip the voice menu and operate the unit directly, see page 68.

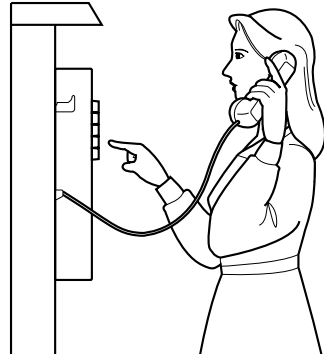

Summary of remote operation

Call your unit from a touch tone phone.



Enter your remote code (p. 65) during or after the greeting message.

- The number of new messages is heard.



After 3 seconds, the voice menu will start (p. 66).

Follow the menu or enter the direct commands (p. 68).



To end remote operation, hang up.

- The messages are saved.

- The unit will announce the remaining recording time after playback, if it is less than 5 minutes.



Setting the Remote Code

The remote code prevents unauthorized people from accessing your unit and listening to your messages. Choose any **2-digit number (00–99)**. The factory preset remote code is “11”. If you do not program your own remote code, you can use “11”.

Use the handset near the base unit. Make sure the unit is in the standby mode initially.

- 1 Press **FUNCTION/EDIT**.
- 2 Press **▼** or **▲** repeatedly until the arrow points to “Program”.
- 3 Press **▶** (Yes key).
- 4 Press **▼** or **▲** repeatedly until the arrow points to “TAD program”.
- 5 Press **▶** (Yes key).
 - “P” is displayed on the base unit.
- 6 Press **1**.
 - The current remote code is displayed on the base unit.
- 7 Enter a remote code using a **2-digit number (00–99)**.
- 8 Press **▶** (Save key).
 - A beep sounds.
 - To return to the standby mode, press **EXIT/CH**.

| |
|----------|
| ▶Program |
| ▼▲ ▶=Yes |

| |
|---------------|
| ▶LCD contrast |
| Set recall |
| ▼▲ ▶=Yes |

| |
|--------------|
| ▶TAD program |
| ▼▲ ▶=Yes |

| |
|-----------------------------|
| Answering system setting |
| {■■■■} |

•If 6 beeps sound during programming, a wrong key was pressed. Enter the correct number.

To check the remote code

Repeat steps 1 to 6.

- The current remote code is displayed on the base unit. When finished, press **EXIT/CH**.

➔ Remote Operation from a Touch Tone Phone

Voice Menu

The shaded boxes are voice prompts.

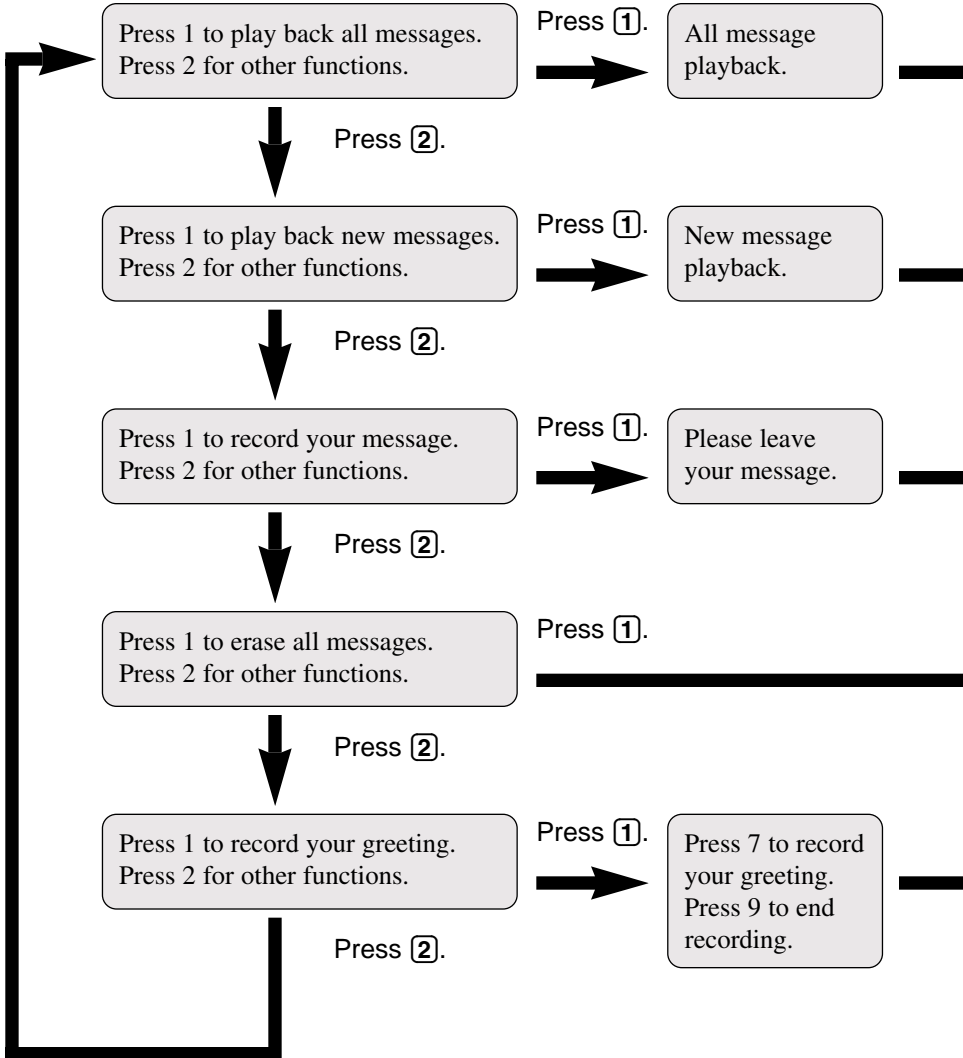



All Message Playback

All recorded messages are played back. At the end of the last message, "End of final message" is heard. The unit will announce the remaining recording time if it is less than 5 minutes.

New Message Playback

Only new messages are played back. At the end of the last message, "End of final message" is heard. The unit will announce the remaining recording time if it is less than 5 minutes.

Recording a Memo Message

You can leave a personal message.

1. Talk after you hear "Please leave your message".
2. When you finish recording, hang up.

Erasing All Messages

All recorded messages (except greeting message) are erased.

Recording a Greeting Message

You can re-record your greeting message.

1. Press **[7]**.
You will hear a voice prompt followed by a long beep.
2. After the beep, talk for up to 2 minutes.
3. When you finish recording, press **[9]**.
4. Your greeting will be played back for confirmation.

- 3 seconds after playback, the voice menu will start again from the beginning.
- If you hear "Memory full" after playback, erase some, or all, of the messages (p. 68).

➔ Remote Operation from a Touch Tone Phone

Direct Remote Operation

Once you have entered the remote code, you can also control your unit by direct commands instead of using the voice menu. To end the remote operation, hang up anytime.

Direct commands

NEW MESSAGE
PLAYBACK

4

- Only new messages are played back.
-

ALL MESSAGE
PLAYBACK

5

- All messages are played back.
-

REPEAT
(During playback)

1

- The current message is repeated.
-

SKIP
(During playback)

2

- The current message is skipped.
The next message is played.
-

STOP

9

- Operation is stopped temporarily.
 - To resume operation, enter a direct command within 15 seconds, or the voice menu will start.
-

GREETING
MESSAGE
RECORDING

7

- A long beep sounds.

↓
RECORD

- After the beep, talk immediately for up to 2 minutes.

↓
9

- The recording is stopped.
 - The recorded message is played.
-

ERASING A
SPECIFIC
MESSAGE
(During playback)

***** **4**

- The current message is erased.
 - A short beep will sound and the next message will be played.
-

ERASING ALL
MESSAGES

***** **5**

- All recorded messages are erased.
 - A long beep sounds and “No messages” is heard.
-

PAGER CALL
ON/OFF

3

- Each time you press **3**, "On/Off" is heard and the mode will turn on or off.
- If you have not stored a pager number, 6 beeps will sound and the mode will not turn on.

ANSWERING
SYSTEM OFF

0

- The unit hangs up and will not answer calls until turned on again.
-

Turning on the answering system

Call your unit and wait for 15 rings.

- The unit will answer and the greeting message will be played.
- The answering system will turn on. Hang up or enter the remote code for other options.
- When turning on the answering system using a rotary or pulse service telephone, you cannot enter the remote code for other options.

Skipping the greeting message

After calling your unit, press ***** during the greeting message.

- The unit skips the rest of the greeting message and you can start recording your message after the long beep.

Remote Operation with the Handset

You can operate your answering system with the handset.

The announcements and recorded messages can only be heard with the handset.

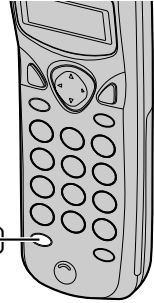

RECALL/PLAYBACK

Summary of remote operation

Press **RECALL/PLAYBACK**.

- The number of new messages is heard.
- “Remote operation” is displayed on the handset.



Enter the desired direct commands (p. 71).

- If you do not enter a command, the voice menu will start (see below).
- After the voice menu, all message playback will start.



To end remote operation, press **RECALL/PLAYBACK**.

- The messages are saved.

- The unit will announce the remaining recording time after playback, if it is less than 5 minutes.
- If the unit starts to ring during the remote operation, press **TALK** to answer the call. The remote operation is ended.
- If you hear “Memory full” after playback, erase some, or all, of the messages (p. 71).

Voice menu

If no commands are entered after you press **RECALL/PLAYBACK**, the unit will start the following voice menu.

“Press 4 to play back new messages. Press 5 to play back all messages.”

- You can enter direct commands even if the voice menu has started.

Direct commands

| | | |
|-------------------------------------------------------|------------|-------------------------------------------------------------------------------------------------------------------------------------------------------------------------------------------------------------------------------------------------------|
| NEW MESSAGE PLAYBACK | 4 | <ul style="list-style-type: none"> •Only new messages are played back. |
| ALL MESSAGE PLAYBACK | 5 | <ul style="list-style-type: none"> •All messages are played back. |
| REPEAT (During playback) | 1 | <ul style="list-style-type: none"> •The current message is repeated. •You can also press ◀ to repeat a message. |
| SKIP (During playback) | 2 | <ul style="list-style-type: none"> •The current message is skipped. The next message is played. •You can also press ▶ to skip a message. |
| STOP | 9 | <ul style="list-style-type: none"> •Operation is stopped temporarily. •To resume operation, enter a direct command within 15 seconds, or the voice menu will start (p. 70). |
| ERASING A SPECIFIC MESSAGE (During playback) | * 4 | <ul style="list-style-type: none"> •The current message is erased. •A short beep will sound and the next message will be played. |
| ERASING ALL MESSAGES | * 5 | <ul style="list-style-type: none"> •All recorded messages are erased. •A long beep sounds and "No messages" is heard. |
| PAGER CALL ON/OFF | 3 | <ul style="list-style-type: none"> •Each time you press 3, the mode will turn on or off. •If you have not stored a pager number, "PAGER" will not be displayed on the base unit, and the mode will not turn on. |
| ANSWERING SYSTEM OFF | 0 | <ul style="list-style-type: none"> •"Answer off" is heard and the answering system is turned off. |
| ANSWERING SYSTEM ON | 8 | <ul style="list-style-type: none"> •"Answer set" is heard and the answering system is turned on. |

Wall Mounting

This unit can be mounted on a wall.

- 1 Push the hook and turn it around. Turn the hook until a click is heard.

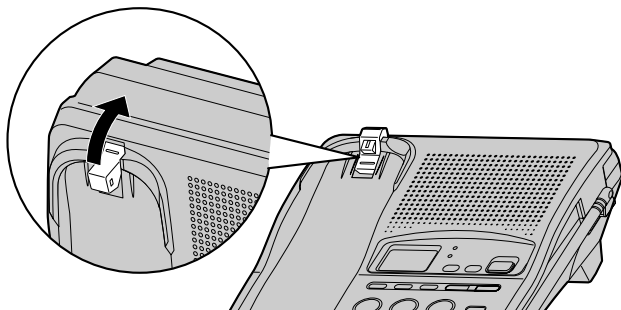

- 2 Connect the AC adaptor.

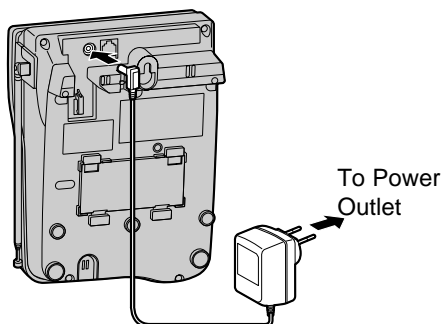

- 3 Tuck the telephone line cord inside the wall mounting adaptor, then push it in the direction of the arrow.

- The word "UP" should face upward.

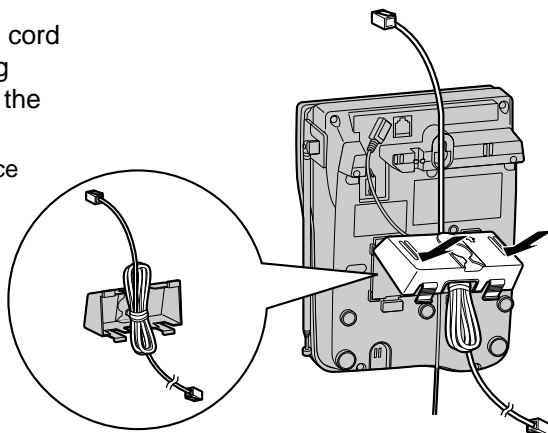

4 Install screws using the wall template below. Connect the telephone line cord. Mount the unit, then slide down.

- Extend the antenna.
- Fasten the telephone line cord to prevent it from being disconnected.

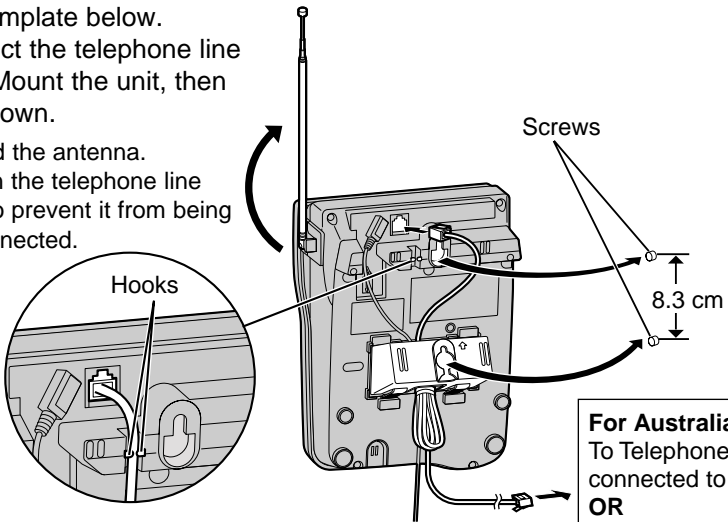

For Australia
To Telephone Plug
connected to Socket
OR
For New Zealand
To Single-Line
Telephone Jack

5 To charge the handset battery:
Fix the charge contacts (①) and insert the hook to the handset hole (②).

- The IN USE/CHARGE indicator lights.

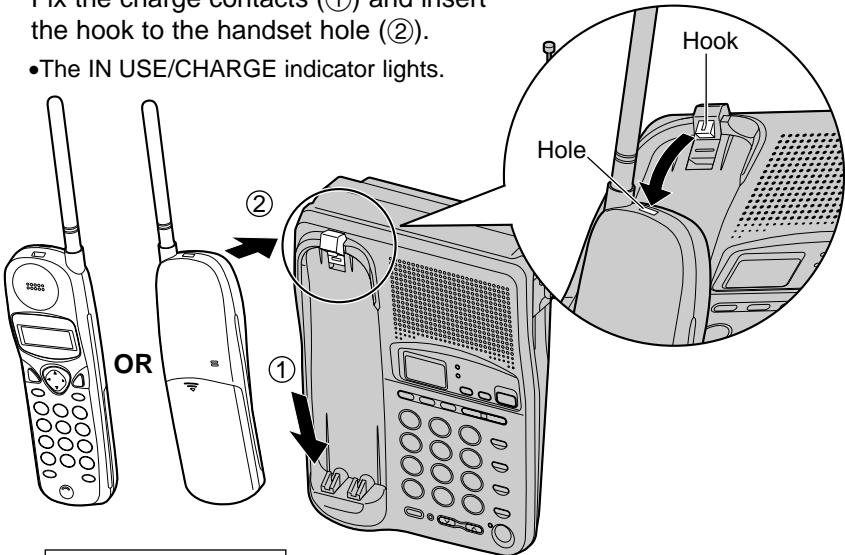

Wall Template

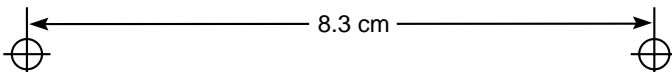

Battery Replacement

If "Recharge" is displayed and/or "[]" flashes after being fully charged, replace the battery with a new Panasonic P-P102 battery. To avoid memory loss, replace within 3 minutes.

- 1 Press the notch on the battery cover firmly and slide it as indicated by the arrow.

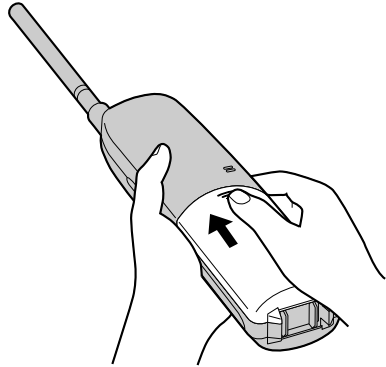

- 2 Remove the old battery. Then install the new one.
 - Insert the battery plug into the connector as shown.

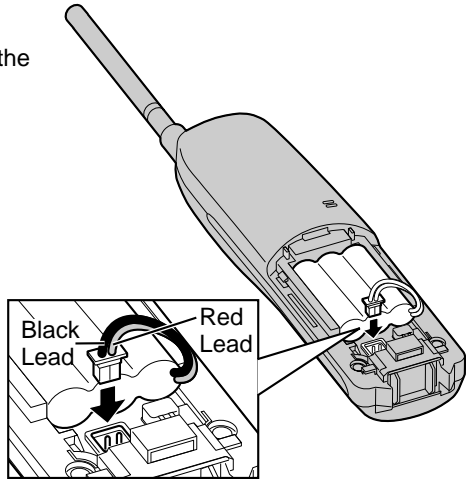

- 3 Close the cover. Make sure you charge the new battery for about 10 hours in order to display the battery strength prompt correctly (p. 14).

Adding Another Phone

This unit will not function during a power failure. To connect a standard telephone on the same line, use a telephone double adaptor (for Australia) or a T-adaptor (for New Zealand).

For Australia

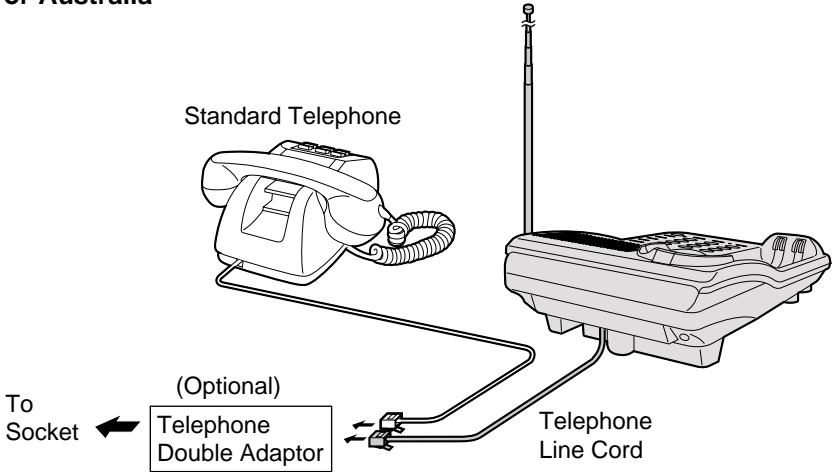

For New Zealand

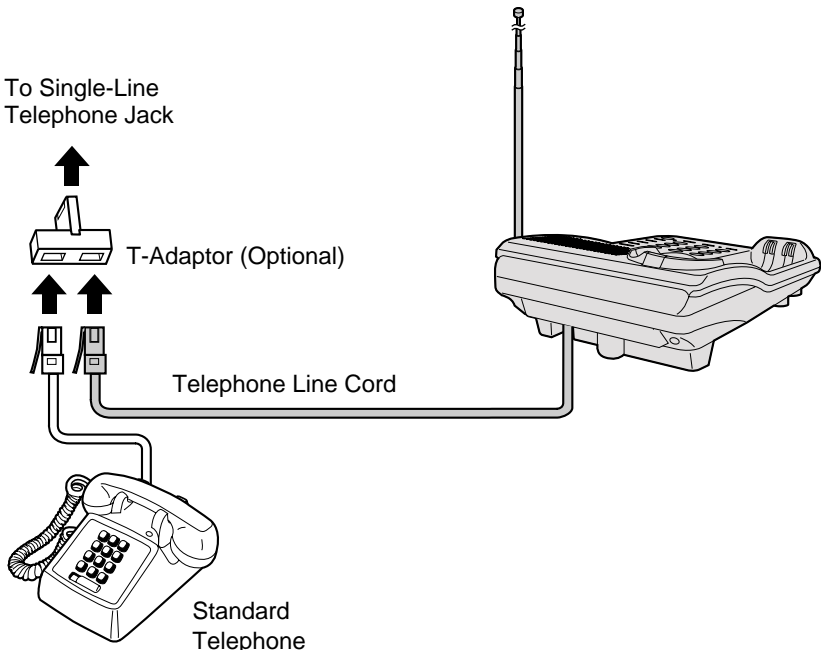

Before Requesting Help

Cordless Telephone

| Problem | Remedy |
|------------------------------------------------------------------------------------------------|--------------------------------------------------------------------------------------------------------------------------------------------------------------------------------------------------------------------------------------------------------------------------|
| "No link to base Place on cradle and try again." is displayed and an alarm tone sounds. | <ul style="list-style-type: none">•You are too far from the base unit. Move closer and try again.•Place the handset on the base unit and try again.•Plug in the AC adaptor.•Extend the antenna fully. |
| Static, sound cuts in/out, fades. Interference from other electrical units. | <ul style="list-style-type: none">•Locate the handset and the base unit away from other electrical appliances (p. 3).•Move closer to the base unit.•Extend the antenna fully.•Press EXIT/CH to select a clearer channel. |
| The handset and/or the base unit do not ring. | <ul style="list-style-type: none">•The ringer volume is set to OFF. Set to HIGH or LOW (p. 20). |
| The handset display is blank. | <ul style="list-style-type: none">•The handset is in the standby mode (p. 15). Press ▼, ▲, ◀ or ▶ to turn the display on. |
| The handset display is still blank after pressing ▼ , ▲ , ◀ or ▶ . | <ul style="list-style-type: none">•Charge the battery fully (p. 14). |
| You cannot store a name and phone number in the directory. | <ul style="list-style-type: none">•You cannot store an item in the directory while the unit is in the talk, speakerphone or intercom mode, or while the answering system is in use.•Do not pause for over 60 seconds while storing. |
| While programming or searching, the unit starts to ring and stops the program/search. | <ul style="list-style-type: none">•To answer the call, press TALK or DIGITAL SP-PHONE. Start again from the beginning after hanging up. |



| Problem | Remedy |
|-----------------------------------------------------------------------------|--------------------------------------------------------------------------------------------------------------------------------------------------------------------------------------------------------------------------------------------------------------------------------------------------------------------------------------------------------------------------------------------------------------------------------|
| The unit does not display the caller's phone number. | <ul style="list-style-type: none">• You need to subscribe to a Caller ID service from a telephone company.• Other telephone equipment may be interfering with your phone. Disconnect it and try again.• Other electrical appliances connected to the same outlet may be interfering with the Caller ID information.• Telephone line noise may be affecting the Caller ID information. |
| The handset display goes to the standby mode while viewing the Caller List. | <ul style="list-style-type: none">• Do not pause for over 60 seconds while searching. |
| LOCATOR/INTERCOM does not function. | <ul style="list-style-type: none">• The handset is too far from the base unit.• The handset is engaged in an outside call, viewing the Caller List/directory list or listening to messages. Wait until the IN USE/CHARGE indicator light goes out. |
| You cannot redial by pressing REDIAL/PAUSE . | <ul style="list-style-type: none">• If the last number dialled was more than 32 digits long, the number will not be redialled correctly.• The button has a double function as either redial or pause. It will redial the last number dialled if pressed at the outset of a call (p. 28, 29, 31). If another number has been dialled first, it will operate as a pause button (p. 54). |

➔ Before Requesting Help

Answering System

| Problem | Remedy |
|-------------------------------------------------------------------------------------------------------------|------------------------------------------------------------------------------------------------------------------------------------------------------------------------------------------------------------------------------------------------------------------------------------|
| The answering system is on, but incoming messages are not recorded. | <ul style="list-style-type: none">•The recording time is set to “Greeting only”. Select “1 minute” or “3 minutes” (p. 26).•Memory is full. Erase some, or all, of the messages (p. 61). |
| You cannot listen to the recorded messages. | <ul style="list-style-type: none">•Make sure that the unit is in the standby mode. |
| “ FULL ” is displayed and the ANSWER ON indicator flashes rapidly, and no new messages are recorded. | <ul style="list-style-type: none">•Memory is full. Erase some, or all, of the messages (p. 61). |
| You cannot operate the answering system at the base unit. | <ul style="list-style-type: none">•The handset user is operating the answering system, or is engaged in an outside call. Wait until the IN USE/CHARGE indicator light goes out. |
| You cannot operate the answering system from a touch tone phone. | <ul style="list-style-type: none">•Make sure you enter the correct remote code.•The answering system may not respond if the tones are too short to activate the unit. Press each button firmly.•The answering system is off. Turn it on (p. 57). |
| You cannot operate the answering system with the handset. | <ul style="list-style-type: none">•Someone is operating the answering system.•You are too far from the base unit. Move closer to the base unit.•The unit is recording a message. To answer the call, press TALK or DIGITAL SP-PHONE. |
| While recording a greeting message, the unit starts to ring and stops recording. | <ul style="list-style-type: none">•To answer the call, press DIGITAL SP-PHONE or press TALK. Start again from the beginning after hanging up. |



| Problem | Remedy |
|--------------------------------------------------------------------------------------------|------------------------------------------------------------------------------------------------------------------------------------------------------------------------------------------------------------------------|
| During playback, the unit starts to ring and stops playback. | <ul style="list-style-type: none">•To answer the call, press DIGITAL SP-PHONE or press TALK. To resume playback, press NEW MESSAGE after hanging up. |
| The handset does not display the phone number of the caller whose message is being played. | <ul style="list-style-type: none">•Place the handset on the base unit correctly (p. 59).•If the caller is not stored in the Caller List, the handset will not display the caller's information. |

General

| Problem | Remedy |
|----------------------------------------------------------------|-----------------------------------------------------------------------------------------------------------------------------------------------------------------------------------------------------------------------------------------------------------------------------------------------------------------------------------------------------------------------------------------------------------------------------------------------------------------------------------------------------------------------------------------------------|
| The unit does not work. | <ul style="list-style-type: none">•Check the settings (p. 13–17).•Charge the battery fully (p. 14).•Clean the charge contacts and charge again (p. 15).•Install the battery properly (p. 74).•Place the handset on the base unit and unplug the AC adaptor to reset. Plug in, and try again.•Re-install the battery and place the handset on the base unit (p. 74). Try again.•KX-TC1230ALW and KX-TC1230NZW are not designed to be used with rotary (pulse dialling) services. |
| You cannot program items, such as the day and time adjustment. | <ul style="list-style-type: none">•Programming is not possible while the unit is in the talk or speakerphone mode, when viewing the Caller List/directory list, or while the answering system is in use.•Do not pause for over 60 seconds while programming.•Move closer to the base unit.•Make sure that the unit is in the standby mode. |

➔ Before Requesting Help

| Problem | Remedy |
|---------------------------------------------------------------------------------------------------|----------------------------------------------------------------------------------------------------------------------------------------------|
| Previously programmed information is erased. | <ul style="list-style-type: none">•If a power failure occurs, programmed information may be erased. Reprogram if necessary. |
| “Recharge” is displayed on the handset, “[]” flashes or the unit beeps intermittently. | <ul style="list-style-type: none">•Charge the battery fully (p. 14). |
| You charged the battery fully, but “Recharge” is still displayed and/or “[]” continues to flash. | <ul style="list-style-type: none">•Clean the charge contacts and charge again (p. 15).•Install a new battery (p. 74). |
| The IN USE/CHARGE indicator light does not go out after the battery has been charged. | <ul style="list-style-type: none">•This is normal. |

For New Zealand Customers

Panasonic New Zealand operates a toll free Customer Support Centre.

Please phone 0800 Panasonic (0800 726276) for assistance.

Safety Instructions



Take special care to follow the safety suggestions listed below.

Safety

- 1) The unit should be connected to a power supply only of the type described in the operating instructions or as marked on the unit.
- 2) When left unused for a long period of time, the base unit should be unplugged from the household AC outlet.
- 3) To minimize the possibility of lightning damage when you know that a thunderstorm is coming, we recommend that you:
 - a) Unplug the telephone line cord from the phone jack.
 - b) Unplug the power supply cord from the AC power outlet.

Installations

Environment

- 1) Do not use this unit near liquids—for example, near a bathtub, washbowl, sink, etc. Damp environments should also be avoided.
- 2) The unit should be kept away from heat sources such as radiators, kitchen range, etc. It also should not be placed in rooms where the temperature is less than 5°C or greater than 40°C.
- 3) The AC adaptor is used as the main disconnect device, ensure that the AC outlet is located/installed near the unit and is easily accessible.

Placement

- 1) Do not place heavy objects on top of this unit.
- 2) Care should be taken so that objects do not fall onto, and liquids are not spilled into, the unit. Do not subject this unit to excessive smoke, dust, mechanical vibration or shock.
- 3) Place the unit on a flat surface.

For best performance

- 1) If noise prevents the conversation from being understood at the handset, approach the base unit to lessen the noise.
- 2) The handset should be used at the HIGH volume setting when the reception audio is difficult to hear.
- 3) The handset should be fully recharged on the base unit when “Recharge” is displayed and/or “[■]” flashes on the display.
- 4) The handset antenna should not be touched during use because of its high sensitivity.
- 5) The maximum calling distance may be shortened when the unit is used in the following places: Near obstacles such as hills, tunnels, undergrounds, near metal objects such as wire fences, etc.

Safety Instructions

WARNING:

TO PREVENT FIRE OR SHOCK HAZARD, DO NOT EXPOSE THIS PRODUCT TO RAIN OR ANY TYPE OF MOISTURE.

When a failure occurs which results in the internal parts becoming accessible, disconnect AC adaptor immediately and return this unit to the place of purchase or service centre.

If there is any trouble, disconnect the unit from the telephone line and connect a known working phone. If the known working phone operates properly, do not reconnect the unit to the telephone line until the trouble has been repaired. If the known working phone does not operate properly, consult your telephone company.

This equipment has been tested and found to comply with AS/NZS 3548: 1995 limits for electromagnetic interference. Any modifications to any part of the system or to any peripherals may void the EMC compliance of the system or the peripherals.

This equipment will be inoperable when mains power fails.

The earcap on the handset is magnetised and may retain metallic objects.

For New Zealand Users Only

The grant of a Telepermit for any item of terminal equipment indicates only that Telecom has accepted that the item complies with minimum conditions for connection to its network. It indicates no endorsement of the product by Telecom, nor does it provide any sort of warranty. Above all, it provides no assurance that any item will work correctly in all respects with another item of Telepermitted equipment of a different make or model, nor does it imply that any product is compatible with all of Telecom's network services.

This device only responds to Distinctive Alert cadence(s) DA1 & DA3.

WARNING NOTICE:

No "111" or other calls can be made from this device during a mains power failure.

This equipment shall not be set to make automatic calls to the Telecom "111" Emergency Service.

- We recommend that a standard phone which can be used in the case of a power failure be connected to the telephone line at all times.

Important Information (For Australia only) ➔

Instructions to customer

Installation

Attached to this apparatus is an approval label. This label is evidence that it is a "Permitted Attachment" which has been authorised to be connected to your telephone service.

Conditions relating to connection and operation of this Permitted Attachment are contained in Telecommunications General By-Law 220 (5).

You are authorised to install this Permitted Attachment yourself by plugging it into the line socket of any regular telephone. You may connect it in place of your existing telephone or to any spare telephone socket installed in your premises.

To disconnect your existing telephone you must first remove its plug from the line socket. You can then insert the plug of your Permitted Attachment into the socket and use your equipment.

If the plug of your existing telephone cannot be readily removed, you will have to remove the screw securing it. To do this proceed as follows:

1. Loosen screw "A" sufficiently to remove the socket cover. (See Fig. 1.)
2. Remove screw "B" and withdraw the plug. (See Fig. 2.)
3. Replace screw "B". (See Fig. 3.) Ensure that it screws completely into the socket recess. (If the screw is too long, increase the hole depth or replace the screw with one 5 mm shorter.)
4. Replace socket cover and tighten screw "A". (See Fig. 4.)

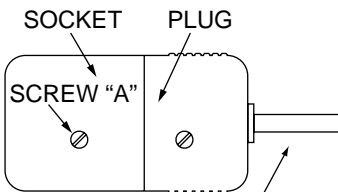

Fig. 1

TELEPHONE CORD
(Connect to the PLUG
as shown in Fig. 1.)

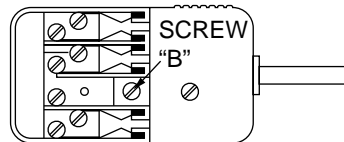

Fig. 2



Fig. 3



Fig. 4

If you are satisfied with the operation of your telephone service after plugging in your Permitted Attachment, your installation is completed.

You will be unable to connect this Permitted Attachment if your telephone service consists only of a wall phone or an old style telephone which is not connected by means of a modern plug and socket. In such cases a new socket will need to be installed.

Should the Permitted Attachment not operate when plugged into a socket, it is either faulty or unsuitable for operation with your telephone service. It should be returned to the store where purchased or the Authorised Service Centre.

Service difficulties

If at any time a fault occurs on your telephone service carry out the following checks before you call for service:

- Disconnect the Permitted Attachment and try using the service with the normal telephone.
- If the telephone service then operates satisfactorily, the fault is in your Permitted Attachment. Leave the Permitted Attachment disconnected and report the fault to its supplier or agent to arrange for repair.
- If when using the telephone the service is still faulty, report the fault to "Service Difficulties and Faults" for attention.

You are required to keep this Permitted Attachment in good working order while it is connected to your telephone service. Its construction or internal circuit must not be modified in any way without permission.

WARNING

This cordless telephone system does not incorporate provision for secrecy of conversations. Appropriately tuned radio equipment and other cordless telephone systems in close proximity may be used by a third party to monitor and possibly interrupt conversations in progress when this system is on radio operation.

Kyushu Matsushita Electric Co., Ltd.

1-62, 4-chome, Minoshima, Hakata-ku, Fukuoka 812-8531, Japan

PQQX13218ZA-BM SM0901SA0

Free Manuals Download Website

<http://myh66.com>

<http://usermanuals.us>

<http://www.somanuals.com>

<http://www.4manuals.cc>

<http://www.manual-lib.com>

<http://www.404manual.com>

<http://www.luxmanual.com>

<http://aubethermostatmanual.com>

Golf course search by state

<http://golfingnear.com>

Email search by domain

<http://emailbydomain.com>

Auto manuals search

<http://auto.somanuals.com>

TV manuals search

<http://tv.somanuals.com>