

# Panasonic®

## Operating Instructions

Link-to-Cell Cellular Convergence Solution

Model No. **KX-TG7731**

**KX-TG7732**

**KX-TG7733**

**KX-TG254SK**

**KX-TG7741**

**KX-TG7742**

**KX-TG7743**

**KX-TG7745**

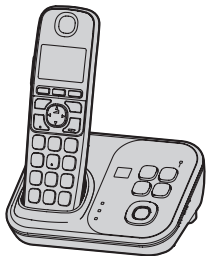

DECT

**6.0**

 **Bluetooth®**

Model shown is KX-TG7731.

*Before initial use, see “Getting Started”  
on page 11.*

**Thank you for purchasing a Panasonic product.**

Please read these operating instructions before using the unit and save them for future reference.

**Consulte “Guía Rápida Española”, página 73.**

For assistance, visit our Web site: <http://www.panasonic.com/help> for customers in the U.S.A. or Puerto Rico.

**Please register your product: <http://www.panasonic.com/prodreg>**

## Introduction

Model composition .....	3
Accessory information .....	4

## Important Information

For your safety .....	7
Important safety instructions .....	8
For best performance .....	8
Other information .....	9
Specifications .....	10

## Getting Started

Setting up .....	11
Note when setting up .....	12
Intelligent eco mode .....	13
Controls .....	13
Belt clip .....	15
Display/Indicators .....	15
Initial settings .....	17

## Link to Cell

Link to cell feature .....	18
Registering a cellular phone .....	18
Link to cell settings .....	19

## Making/Answering Calls Using the Handset

Making cellular calls .....	22
Making landline calls .....	22
Answering calls .....	23
Useful features during a call .....	23

## Making/Answering Calls Using the Base Unit

Making cellular calls .....	27
Making landline calls .....	27
Answering calls .....	27
Useful features during a call .....	28

## Shared Phonebook

Shared phonebook .....	30
------------------------	----

## Programming

Programmable settings .....	33
Special programming .....	40
Registering a unit .....	42

## Caller ID Service

Using Caller ID service .....	43
-------------------------------	----

Caller list .....	44
-------------------	----

## Using Bluetooth Devices

Copying phonebook from a cellular phone (phonebook transfer) .....	46
Using a Bluetooth wireless headset (optional) for landline calls .....	47

## Answering System for Landline

Answering system for landline .....	49
Turning the answering system on/off .....	49
Greeting message .....	50
Listening to messages using the base unit .....	50
Listening to messages using the handset .....	50
Remote operation .....	51
Answering system settings .....	53

## Voice Mail Service for Landline

Voice mail service for landline .....	55
---------------------------------------	----

## Intercom/Locator

Intercom .....	57
Handset locator .....	57
Transferring calls, conference calls .....	58

## Useful Information

Wall mounting .....	59
Error messages .....	61
Troubleshooting .....	62
FCC and other information .....	70

## Guía Rápida Española

Guía Rápida Española .....	73
----------------------------	----

## Appendix

Customer services .....	82
Warranty (For United States and Puerto Rico) .....	83

## Index

Index .....	85
-------------	----

## Model composition

### ■ KX-TG7731 series



- Model shown is KX-TG7732.

### ■ KX-TG7741 series

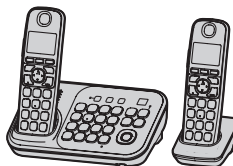

- Model shown is KX-TG7742.

Series	Model No.	Base unit	Handset	
		Part No.	Part No.	Quantity
KX-TG7731 series	KX-TG7731	KX-TG7731	KX-TGA470	1
	KX-TG7732	KX-TG7731	KX-TGA470	2
	KX-TG7733	KX-TG7731	KX-TGA470	3
	KX-TG254SK	KX-TG7731	KX-TGA470	4
KX-TG7741 series	KX-TG7741	KX-TG7741	KX-TGA470	1
	KX-TG7742	KX-TG7741	KX-TGA470	2
	KX-TG7743	KX-TG7741	KX-TGA470	3
	KX-TG7745	KX-TG7741	KX-TGA470	5

## Feature differences

Series	Base unit keypad/sp-phone	Intercom*1
		 *2
KX-TG7731 series	—	—
KX-TG7741 series	●	●

\*1 Single handset models: Intercom calls can be made between handsets by purchasing and registering one or more optional handsets (page 5).

\*2 Intercom calls can be made between the base unit and handset.

## Accessory information

### Supplied accessories

No.	Supplied handset qty.	1 unit*1	2 units*2	3 units*3	4 units*4	5 units*5
	Accessory item/ Order number	Accessory quantity				
①	AC adaptor/PNLV226Z	1	2	3	4	5
②	Telephone line cord/ PQJA10075Z	1	1	1	1	1
③	Wall mounting adaptor/ PNKL1001Y1	1	1	1	1	1
④	Rechargeable batteries/ HHR-4DPA	2	4	6	8	10
⑤	Handset cover*6/ PNYNTGA470BR	1	2	3	4	5
⑥	Belt clip/PNKE1132Z1	1	2	3	4	5
⑦	Charger/PNLC1029ZS	–	1	2	3	4

\*1 KX-TG7731/KX-TG7741

\*2 KX-TG7732/KX-TG7742

\*3 KX-TG7733/KX-TG7743

\*4 KX-TG254SK

\*5 KX-TG7745

\*6 The handset cover comes attached to the handset.

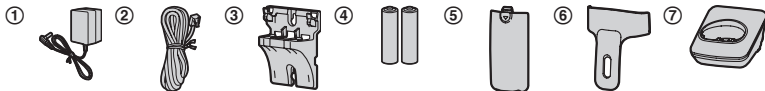

## Additional/replacement accessories

Please contact your nearest Panasonic dealer for sales information (page 82).

Accessory item	Order number
Rechargeable batteries	HHR-4DPA*1 <ul style="list-style-type: none"> <li>To order, please call 1-800-332-5368 or visit <a href="http://www.panasonic.com/batterystore">http://www.panasonic.com/batterystore</a></li> </ul>
	Battery type: – Nickel metal hydride (Ni-MH) – 2 x AAA (R03) size for each handset
Headset	KX-TCA60, KX-TCA93, KX-TCA400, KX-TCA430
T-adaptor	KX-J66
Range extender	KX-TGA405*2

\*1 Replacement batteries may have a different capacity from that of the supplied batteries.

\*2 By installing this unit, you can extend the range of your phone system to include areas where reception was previously not available. This product can be purchased online. Please visit our Web site:  
<http://www.panasonic.com/RangeExtender>

## Expanding your phone system

### Optional handset feature overview



Handset (optional): KX-TGA470	
You can expand your phone system by registering optional handsets (6 max.) to a single base unit. <ul style="list-style-type: none"> <li>Optional handsets may be a different color from that of the supplied handsets.</li> </ul>	

## Introduction

---

### Bluetooth® devices

You can expand your phone system by registering the following units to a single base unit.

<b>Your Bluetooth cellular phone*1:</b> 2 max. (for cellular calls: page 18)	
<b>Your Bluetooth headset*1:</b> 1 max. (for a wireless hands-free conversation: page 47)	

\*1 Your cellular phone and headset must be Bluetooth wireless technology compatible. For more details and the list of compatible cellular phones, please visit our Web site:  
<http://www.panasonic.com/link2cell>

### For your safety

To prevent severe injury and loss of life/property, read this section carefully before using the product to ensure proper and safe operation of your product.

### WARNING

#### Power connection

- Use only the power source marked on the product.
- Do not overload power outlets and extension cords. This can result in the risk of fire or electric shock.
- Completely insert the AC adaptor/power plug into the power outlet. Failure to do so may cause electric shock and/or excessive heat resulting in a fire.
- Regularly remove any dust, etc. from the AC adaptor/power plug by pulling it from the power outlet, then wiping with a dry cloth. Accumulated dust may cause an insulation defect from moisture, etc. resulting in a fire.
- Unplug the product from power outlets if it emits smoke, an abnormal smell, or makes an unusual noise. These conditions can cause fire or electric shock. Confirm that smoke has stopped emitting and contact the Panasonic Call Center at 1-800-211-PANA (1-800-211-7262).
- Unplug from power outlets and never touch the inside of the product if its casing has been broken open.
- Never touch the plug with wet hands. Danger of electric shock exists.

#### Installation

- To prevent the risk of fire or electrical shock, do not expose the product to rain or any type of moisture.
- Do not place or use this product near automatically controlled devices such as automatic doors and fire alarms. Radio waves emitted from this product may cause such devices to malfunction resulting in an accident.

- Do not allow the AC adaptor or telephone line cord to be excessively pulled, bent or placed under heavy objects.

#### Operating safeguards

- Unplug the product from power outlets before cleaning. Do not use liquid or aerosol cleaners.
- Do not disassemble the product.
- Do not spill liquids (detergents, cleansers, etc.) onto the telephone line cord plug, or allow it to become wet at all. This may cause a fire. If the telephone line cord plug becomes wet, immediately pull it from the telephone wall jack, and do not use.

#### Medical

- Consult the manufacturer of any personal medical devices, such as pacemakers or hearing aids, to determine if they are adequately shielded from external RF (radio frequency) energy. (The product operates in the frequency range of 1.92 GHz to 1.93 GHz, and the RF transmission power is 115 mW (max.))
- Do not use the product in health care facilities if any regulations posted in the area instruct you not to do so. Hospitals or health care facilities may be using equipment that could be sensitive to external RF energy.

#### CAUTION

#### Installation and location

- Never install telephone wiring during an electrical storm.
- Never install telephone line jacks in wet locations unless the jack is specifically designed for wet locations.
- Never touch uninsulated telephone wires or terminals unless the telephone line has been disconnected at the network interface.
- Use caution when installing or modifying telephone lines.
- The AC adaptor is used as the main disconnect device. Ensure that the AC outlet is installed near the product and is easily accessible.
- This product is unable to make calls when:

## Important Information

- the handset batteries need recharging or have failed.
- there is a power failure.

### Battery

- We recommend using the batteries noted on page 5. **USE ONLY rechargeable Ni-MH batteries AAA (R03) size.**
- Do not mix old and new batteries.
- Do not open or mutilate the batteries. Released electrolyte from the batteries is corrosive and may cause burns or injury to the eyes or skin. The electrolyte is toxic and may be harmful if swallowed.
- Exercise care when handling the batteries. Do not allow conductive materials such as rings, bracelets, or keys to touch the batteries, otherwise a short circuit may cause the batteries and/or the conductive material to overheat and cause burns.
- Charge the batteries provided with or identified for use with this product only, in accordance with the instructions and limitations specified in this manual.
- Only use a compatible base unit (or charger) to charge the batteries. Do not tamper with the base unit (or charger). Failure to follow these instructions may cause the batteries to swell or explode.

#### Attention:



A nickel metal hydride battery that is recyclable powers the product you have purchased.

Please call 1-800-8-BATTERY (1-800-822-8837) for information on how to recycle this battery.

## Important safety instructions

When using your product, basic safety precautions should always be followed to reduce the risk of fire, electric shock, and injury to persons, including the following:

1. Do not use this product near water for example, near a bathtub, washbowl, kitchen sink, or laundry tub, in a wet basement or near a swimming pool.
2. Avoid using a telephone (other than a cordless type) during an electrical storm. There may be a remote risk of electric shock from lightning.
3. Do not use the telephone to report a gas leak in the vicinity of the leak.
4. Use only the power cord and batteries indicated in this manual. Do not dispose of batteries in a fire. They may explode. Check with local codes for possible special disposal instructions.

### SAVE THESE INSTRUCTIONS

## For best performance

### Base unit location/avoiding noise

The base unit and other compatible Panasonic units use radio waves to communicate with each other.

- For maximum coverage and noise-free communications, place your base unit:
  - at a convenient, high, and central location with no obstructions between the handset and base unit in an indoor environment.
  - away from electronic appliances such as TVs, radios, personal computers, wireless devices, or other phones.
  - facing away from radio frequency transmitters, such as external antennas of mobile phone cell stations. (Avoid putting the base unit on a bay window or near a window.)
- Coverage and voice quality depends on the local environmental conditions.



- If the reception for a base unit location is not satisfactory, move the base unit to another location for better reception.

### Environment

- Keep the product away from electrical noise generating devices, such as fluorescent lamps and motors.
- The product should be kept free from excessive smoke, dust, high temperature, and vibration.
- The product should not be exposed to direct sunlight.
- Do not place heavy objects on top of the product.
- When you leave the product unused for a long period of time, unplug the product from the power outlet.
- The product should be kept away from heat sources such as heaters, kitchen stoves, etc. It should not be placed in rooms where the temperature is less than 0 °C (32 °F) or greater than 40 °C (104 °F). Damp basements should also be avoided.
- The maximum calling distance may be shortened when the product is used in the following places: Near obstacles such as hills, tunnels, underground, near metal objects such as wire fences, etc.
- Operating the product near electrical appliances may cause interference. Move away from the electrical appliances.

### Routine care

- **Wipe the outer surface of the product with a soft moist cloth.**
- Do not use benzine, thinner, or any abrasive powder.

### Other information

**CAUTION:** Risk of explosion if battery is replaced by an incorrect type. Dispose of used batteries according to the instructions.

### Notice for product disposal, transfer, or return

- This product can store your private/confidential information. To protect your privacy/confidentiality, we recommend that you erase information such as phonebook or caller list entries from the memory before you dispose of, transfer, or return the product.

### Notice

- This product is designed for use in the United States of America. Sale or use of this product in other countries may violate local laws.
- Cet appareil est conçu pour être utilisé aux États-Unis d'Amérique. La vente ou l'emploi de cet appareil dans certains autres pays peut constituer une infraction à la législation locale.
- Este producto está diseñado para usarse en los Estados Unidos de América. La venta o el empleo de este producto en ciertos países puede constituir violación de la legislación local.
- 本產品專為美國使用而設。若在其他國家銷售或使用，可能會違反當地法例。
- この製品は、日本国外での使用を目的として設計されており、日本国内での使用は法律違反となります。従って、当社では日本国内においては原則として修理などのサービスは致しかねます。

### ENERGY STAR

As an ENERGY STAR® Partner, Panasonic has determined that this product meets the ENERGY STAR guidelines for energy efficiency. ENERGY STAR is a U.S. registered mark.



### Specifications

- **Standard:**  
DECT 6.0 (Digital Enhanced Cordless Telecommunications 6.0)  
Bluetooth wireless technology 2.0
- **Frequency range:**  
1.92 GHz to 1.93 GHz (DECT)  
2.402 GHz to 2.48 GHz (Bluetooth)
- **RF transmission power:**  
115 mW (max.)
- **Power source:**  
120 V AC, 60 Hz
- **Power consumption:**  
**Base unit:**  
Standby: Approx. 1.2 W  
Maximum: Approx. 4.5 W  
**Charger:**  
Standby: Approx. 0.1 W  
Maximum: Approx. 2.0 W
- **Operating conditions:**  
0 °C – 40 °C (32 °F – 104 °F), 20 % – 80 %  
relative air humidity (dry)

**Note:**

- Design and specifications are subject to change without notice.
- The illustrations in these instructions may vary slightly from the actual product.

## Setting up

### Connections

- Use only the supplied Panasonic AC adaptor PNLV226.
- If you do not connect the telephone line cord and use only cellular lines, set the cellular line only mode to use this unit more conveniently (page 20).

#### ■ Base unit

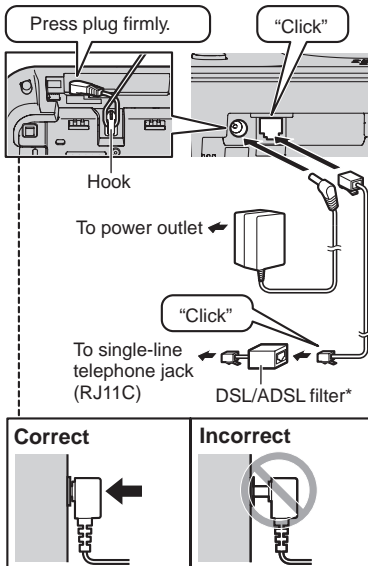

\*DSL/ADSL filter (not supplied) is required if you have DSL/ADSL service.

#### ■ Charger

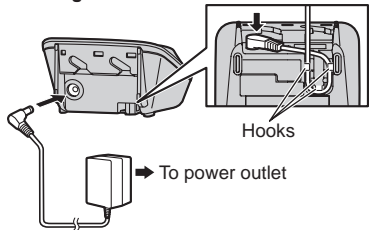

### Battery installation

- USE ONLY Ni-MH batteries AAA (R03) size.
- Do NOT use Alkaline/Manganese/Ni-Cd batteries.
- Confirm correct polarities (+, -).

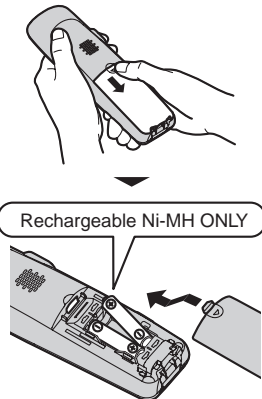

- When the date and time setting is displayed, see page 17.

## Battery charging

Charge for about 7 hours.

- When the batteries are fully charged, "Fully charged" is displayed.

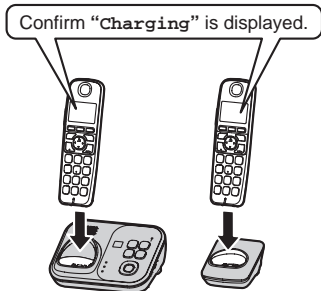

## Note when setting up

### Note for connections

- The AC adaptor must remain connected at all times. (It is normal for the adaptor to feel warm during use.)
- The AC adaptor should be connected to a vertically oriented or floor-mounted AC outlet. Do not connect the AC adaptor to a ceiling-mounted AC outlet, as the weight of the adaptor may cause it to become disconnected.

### During a power failure

- The unit will not work during a power failure. We recommend connecting a corded-type telephone (without AC adaptor) to the same telephone line or to the same telephone line jack using a Panasonic T-adaptor (page 5).

### Note for battery installation

- Use the supplied rechargeable batteries. For replacement, we recommend using the Panasonic rechargeable batteries noted on page 5, 8.
- Wipe the battery ends (+, -) with a dry cloth.

- Avoid touching the battery ends (+, -) or the unit contacts.

### Note for battery charging

- It is normal for the handset to feel warm during charging.
- Clean the charge contacts of the handset, base unit, and charger with a soft and dry cloth once a month. Before cleaning the unit, disconnect from power outlets and any telephone line cords. Clean more often if the unit is exposed to grease, dust, or high humidity.

### Battery level

Icon	Battery level
	High
	Medium
	Low
	Needs charging.
	Empty

### Panasonic Ni-MH battery performance (supplied batteries)

Operation	Operating time
In continuous use	13 hours max.*1
Not in use (standby)	11 days max.*1

\*1 If Eco mode is on.

### Note:

- Actual battery performance depends on usage and ambient environment.
- Even after the batteries are fully charged, the handset can be left on the base unit or charger without any ill effect on the batteries.
- The battery level may not be displayed correctly after you replace the batteries. In this case, place the handset on the base unit or charger and let it charge for at least 7 hours.

## Intelligent eco mode

This feature automatically reduces handset power consumption by suppressing handset transmission power when the handset is close to the base unit.

- When this feature is activated, **ECO** is displayed. However, during a cellular call, **ECO** is not displayed even though this feature is activated.
- Eco mode is turned off when the clarity booster is activated (page 24).

## Controls

### Base unit

#### ■ KX-TG7731 series (page 3)

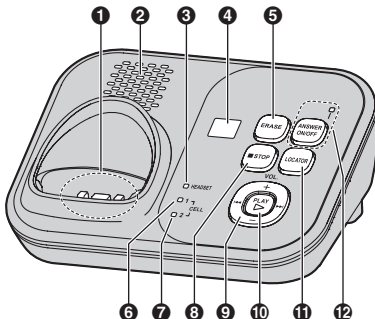

- ❶ Charge contacts
- ❷ Speaker
- ❸ HEADSET indicator
- ❹ Message counter
- ❺ [ERASE]
- ❻ CELL 1 indicator
- ❼ CELL 2 indicator
- ❽ [■] (STOP)
- ❾ [ + ]/[ - ] (VOL.: Volume up/down)  
[ << ]/[ >> ] (Repeat/Skip)
- ❿ [ ▶ ] (PLAY)  
Message indicator
- ⓫ [LOCATOR]
- ⓬ [ANSWER ON/OFF]  
ANSWER ON/OFF indicator

## ■ KX-TG7741 series (page 3)

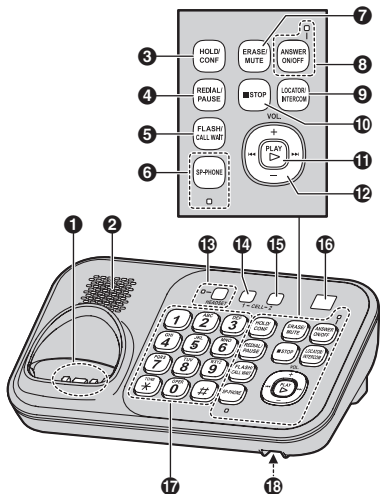

- 1 Charge contacts
- 2 Speaker
- 3 [HOLD] [CONF] (Conference)
- 4 [REDIAL] [PAUSE]
- 5 [FLASH] [CALL WAIT]
- 6 [SP-PHONE] (Speakerphone)  
SP-PHONE indicator
- 7 [ERASE] [MUTE]
- 8 [ANSWER ON/OFF]  
ANSWER ON/OFF indicator
- 9 [LOCATOR] [INTERCOM]
- 10 [■] (STOP)
- 11 [▶] (PLAY)  
Message indicator
- 12 [⊕]/[⊖] (VOL.: Volume up/down)  
[◀]/[▶] (Repeat/Skip)
- 13 [HEADSET]  
HEADSET indicator
- 14 [CELL 1]  
CELL 1 indicator

- 15 [CELL 2]  
CELL 2 indicator
- 16 Message counter
- 17 Dial keypad (☒: TONE)
- 18 Microphone

## Handset

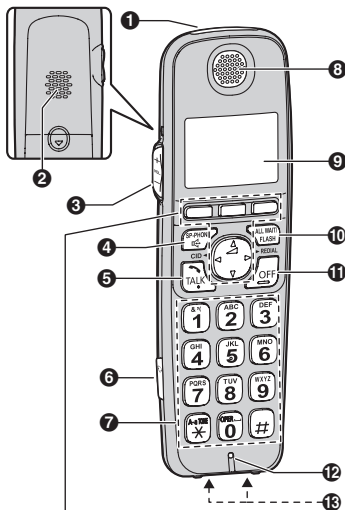

- 1 Ringer indicator  
Message indicator
- 2 Speaker
- 3 [⊕]/[⊖] (VOL.: Volume up/down)
- 4 [☒] (SP-PHONE: Speakerphone)
- 5 [☎] (TALK)
- 6 Headset jack

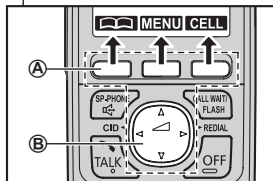

- 7 Dial keypad (☒): TONE
- 8 Receiver
- 9 Display
- 10 [CALL WAIT] [FLASH]
- 11 [OFF]
- 12 Microphone
- 13 Charge contacts

#### ■ Control type

##### Ⓐ Soft keys

The handset features 3 soft keys. By pressing a soft key, you can select the feature shown directly above it on the display.

##### Ⓑ Navigator key

- [▲], [▼], [◀], or [▶]: Scroll through various lists and items.
- ◀ (Volume: [▲] or [▼]): Adjust the receiver or speaker volume while talking.
- [◀] CID (Caller ID): View the caller list.
- [▶] REDIAL: View the redial list.

## Belt clip

■ To attach

■ To remove

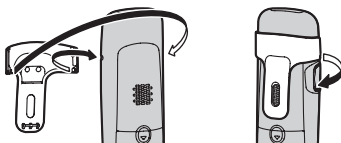

## Display/Indicators

### Handset display items

Item	Meaning
	Within base unit range
	Out of base unit range
	The landline is in use. <ul style="list-style-type: none"> <li>● When flashing: The call is put on hold.</li> <li>● When flashing rapidly: An incoming call is now being received.</li> </ul>
	A cellular line is in use. <ul style="list-style-type: none"> <li>● When flashing: The cellular call is put on hold.</li> <li>● When flashing rapidly: A cellular call is being received.</li> </ul>
	A cellular phone is connected.*1 Ready to make/receive cellular calls. <ul style="list-style-type: none"> <li>● When turned off: A cellular phone is not connected to the base unit (page 20).</li> </ul>
<b>C1</b> <b>C2</b>	<ul style="list-style-type: none"> <li>– The cellular line is selected for the ringer setting.</li> <li>– A cellular call is being received on that line.</li> </ul>
<b>ECO</b>	Eco mode is on.*2 (page 13)
<b>EQ</b>	Equalizer is set. (page 24)
	Speakerphone is on. (page 22)
	Ringer volume is off.*3 (page 35, 37)
<b>Zz</b>	Silent mode is on. (page 40)
<b>PRIV</b>	Call sharing mode is off. (page 38)
	Alarm is on. (page 40)
<b>1</b>	Handset number
	Battery level

Item	Meaning
	Blocked call (page 41)
<b>BOOST</b>	Clarity booster is on.*2 (page 24)
In use	Answering system is being used by another handset or the base unit.
Cell1 in use	Someone is using the cellular line.
Cell2 in use	
Line in use	Someone is using the landline.

- \*1 Corresponding cellular line(s) is indicated next to the item.
- \*2 During a cellular call, the item is not displayed even though the feature is activated.
- \*3 Corresponding lines (1, 2: cellular line, L: landline) are indicated next to the item. If all lines are turned off, no line is indicated.

## Base unit display item

Item	Meaning
	"Greeting only" is selected as the caller's recording time. In this case, the answering system answers calls with a greeting message and caller messages are not recorded. (page 53)

## CELL 1/CELL 2 indicators on the base unit

The CELL 1/CELL 2 indicators show each cellular line status.

Status	Meaning
Green (On)	A cellular phone is connected. Ready to make/receive cellular calls.
Green (Flashing)	<ul style="list-style-type: none"> <li>– The cellular line is in use.</li> <li>– Phonebook entries are being copied from a cellular phone (page 46).</li> </ul>

Status	Meaning
Green (Flashing rapidly)	A cellular call is being received.
Amber (On)	A cellular phone is not connected to the base unit (page 20).
Amber (Flashing rapidly)	The base unit is searching for the registered cellular phone.
Red (Flashing)	<ul style="list-style-type: none"> <li>– The base unit is registering a cellular phone.</li> <li>– A cellular call is put on hold.</li> </ul>
Light off	A cellular phone is not registered to the base unit.

## HEADSET indicator on the base unit

The HEADSET indicator shows the Bluetooth headset status.

Status	Meaning
Green (On)	A Bluetooth headset is connected to the base unit. Ready to use it.
Green (Flashing)	A Bluetooth headset is in use.
Green (Flashing rapidly)	A landline call is being received.
Amber (On)	The Bluetooth headset is not connected to the base unit.
Amber (Flashing rapidly)	The base unit is searching for the registered Bluetooth headset.
Red (Flashing)	<ul style="list-style-type: none"> <li>– The base unit is registering a headset.</li> <li>– Mute is turned on.</li> </ul>
Light off	A Bluetooth headset is not registered to the base unit.



## Initial settings

### ■ Direct command code:

Programmable settings can be accessed by pressing **[MENU]**, **[#]** and then the corresponding code on the dial keypad (page 33).

**Example:** Press **[MENU][#][1][0][1]**.

### ■ Symbol meaning:

Symbol	Meaning
<b>Example:</b> <b>[↕]:</b> "£€£"	Press <b>[▼]</b> or <b>[▲]</b> to select the words in quotations.

## Date and time

### Important:

- When you install the batteries for the first time, the handset may prompt you to set date and time. First press **[SELECT]**, then proceed to step 2.

1 **[MENU][#][1][0][1]**

2 Enter the current month, date, and year by selecting 2 digits for each.

**Example:** July 15, 2012

**[0][7][1][5][1][2]**

3 **[OK]**

4 Enter the current hour and minute (12-hour clock format) by selecting 2 digits for each.

**Example:** 9:30

**[0][9][3][0]**

5 **[AM/PM]:** Select **"AM"** or **"PM"**.

6 **[SAVE] → [OFF]**

### Note:

- When English is selected as the display language, 12-hour clock format is used. When Spanish is selected, 24-hour clock format is used.
- The date and time may be incorrect after a power failure. In this case, set the date and time again.

## Display language

You can select either **"English"** or **"Español"** as the display language. The default setting is **"English"**.

1 **[MENU][#][1][1][0]**

2 **[↕]:** Select the desired setting. → **[SAVE]**

3 **[OFF]**

## Voice guidance language

You can select either **"English"** or **"Español"** as the voice guidance language of the answering system. The default setting is **"English"**.

1 **[MENU][#][1][1][2]**

2 **[↕]:** Select the desired setting. → **[SAVE]**

3 **[OFF]**

## Dialing mode

If you cannot make calls, change this setting according to your telephone line service. The default setting is **"Tone"**.

**"Tone"**: For tone dial service.

**"Pulse"**: For rotary/pulse dial service.

1 **[MENU][#][1][2][0]**

2 **[↕]:** Select the desired setting.

3 **[SAVE] → [OFF]**

## Link to cell feature

To use this feature, you must first register and connect your cellular phones to the base unit (page 18).

Your cellular phones must have Bluetooth wireless technology that is compatible with this product.

This feature allows you to:

- make or answer cellular calls using your home phone (handset or base unit) with better reception.
- maximize the benefits of cellular services (such as free night and weekend calls, or cellular to cellular call plans) by utilizing unused peak minutes with your home phone.
- conserve the battery power of your cellular phone while the unit is on a cellular call. (We recommend charging your cellular phone during the cellular call as your cellular phone battery is being consumed.)

### Important:

- Up to 2 cellular phones can be registered. However, only one Bluetooth device (cellular phone or headset) can be connected to the base unit at a time.
- Locate your cellular phone near the base unit. If the cellular phone is too close to the base unit during a cellular call, you may hear noise. For best performance, we recommend placing the cellular phone between 0.6 m to 3 m (2 feet to 10 feet) away from the base unit.

### Trademarks

- The Bluetooth® word mark and logos are owned by the Bluetooth SIG, Inc. and any use of such marks by Panasonic Corporation is under license. All other trademarks identified herein are the property of their respective owners.

## Registering a cellular phone

### Important:

- For more details and the list of compatible cellular phones, please visit our Web site:

<http://www.panasonic.com/link2cell>

- Before registering a Bluetooth enabled cellular phone to the base unit:
  - we recommend you change the PIN (page 21).
  - make sure that no Bluetooth device such as a Bluetooth headset is connected to your cellular phone.

### 1 Handset:

#### [MENU]

For CELL 1: **[#][6][2][4][1]**

For CELL 2: **[#][6][2][4][2]**

- After the CELL 1 or CELL 2 indicator on the base unit starts flashing red, the rest of the procedure must be completed within 5 minutes.

### 2 Your cellular phone:

While the CELL 1 or CELL 2 indicator is flashing red, follow the instructions of your cellular phone to enter the registration mode.

- Depending on your cellular phone, it may ask you to enter the base unit PIN (default: "0000").

### 3 Handset:

Wait until a long beep sounds.

- It may take more than 10 seconds to complete registration.
- When the CELL 1 or CELL 2 indicator lights green, the cellular phone is connected to the base unit. You are ready to make cellular calls.

### 4 To select which unit receives calls for the cellular line, press [OK] then continue from step 3, "Selecting which unit receives cellular calls", page 19.

- If not required, go to step 5.

### 5 [OFF]

#### Note:

- Make sure that your cellular phone is set to connect to this product automatically. Refer to your cellular phone's operating instructions.
- Make sure you cancel your cellular phone's current registration if you want to register it to the other line (page 21).

## Link to cell settings

### Selecting which unit receives cellular calls

You can select which unit rings and receives calls for a cellular line. When “**All**” is selected, all handsets and the base unit ring.

- 1 **[MENU]**
- 2 For CELL 1: **#6271**  
For CELL 2: **#6272**
- 3 **[↕]**: Select the desired handset or “**All**”.
- 4 **[SAVE] → [OFF]**

#### Note:

- When you select a specific handset to receive calls for a cellular line:
  - other handsets cannot answer the calls.
  - the base unit can answer the calls even though it does not ring. However, you can make the base unit ring by adjusting the base unit ringer volume (page 35). (KX-TG7741 series: page 3)
- When you change the setting to “**All**”, the base unit ringer volume also returns to the lowest level even if the ringer volume has been changed.

### Ring as cell mode

Once this feature is turned on, the handset and base unit ring using the same ringer tone as your cellular phone.

The following settings are available:

- “**off**”: Turn this feature off to use the ringer tones of the handset and base unit. Caller information is announced depending on the Talking Caller ID setting (page 37).
- “**On (with Talking CID)**” (default): The handset and base unit use your cellular phone’s ringer tone. Caller information is announced even if the Talking Caller ID is turned off.
- “**On (without Talking CID)**”: The handset and base unit use your cellular phone’s ringer tone. Caller information is not announced even if the Talking Caller ID is turned on.

#### Important:

- To use this feature, your cellular phone must support Bluetooth in-band ringtone. Refer to your cellular phone’s operating instructions.

- 1 **[MENU]**
- 2 For CELL 1: **#6141**  
For CELL 2: **#6142**
- 3 **[↕]**: Select the desired setting.
- 4 **[SAVE] → [OFF]**

#### Note:

- The units use the preset ringer tones (page 37) instead of your cellular phone’s ringer tone when a cellular call is being received if:
  - your cellular phone is in silent mode (depending on your cellular phone).
  - the base unit is in use.
  - 2 handsets are sharing a landline call.
- If your cellular phone is in silent mode with “**On (with Talking CID)**” set, the unit announces caller information even when Talking Caller ID is turned off (page 37).

### To use the handset ringer tone instead of your cellular phone’s ringer tone

Select “**off**” in step 3, “Ring as cell mode”, page 19.

To change the handset ringer tone for a cellular line, see page 35.

### Auto connection to the cellular phone

After registration, your cellular phone is connected to the base unit. If you move the cellular phone out of base unit range, the cellular phone is disconnected from the base unit. This feature allows the base unit to try to reconnect the cellular phone at regular intervals when it returns within base unit range. You can set the interval. The default setting is “**1 min**”.

### Important:

- When you are using a cellular line or a Bluetooth headset, the base unit loses its connection from other Bluetooth devices (cellular phone or headset). To automatically resume the connection to cellular phones, leave the auto connection on.
- Some cellular phones lose connection after usage, please check the specification of your cellular phone for more details.

1 [MENU] # 6 3 2

2 [↕]: Select the desired setting.

3 [SAVE] → [OFF]

### Note:

- Some cellular phone may ask you if you accept the connection requirement from the base unit. In that case, select "oFf" in step 2. Check the specification of your cellular phone.

## Connecting/disconnecting the cellular phone manually

When you make or answer calls with your cellular phone, we recommend disconnecting it from the base unit, otherwise received audio may not be heard on your cellular phone. You can also manually reconnect the cellular phone to the base unit without waiting for the auto connection feature to resume the connection.

1 [MENU]

2 To connect/disconnect:

For CELL 1: # 6 2 5 1

For CELL 2: # 6 2 5 2

- A long beep sounds.

3 [OFF]

## Cellular line only mode (If you do not use the landline)

If you do not use the landline, we recommend setting the unit to the cellular line only mode.

1 [MENU] # 1 5 7

2 To turn on:

[↕]: "On" → [SELECT] →

[↕]: "Yes" → [SELECT]

To turn off:

[↕]: "oFf" → [SELECT]

### Note:

- Once you set this mode, you can use the following buttons to make cellular calls:
  - for the handset, press [↩] or [↔] instead of [CELL] (page 22).
  - for the base unit, press [SP-PHONE] instead of the line button ([CELL 1] or [CELL 2]) set for the cellular line selection (page 20, 27). (KX-TG7741 series: page 3)
- Once you set this mode, the following features cannot be used:
  - Landline features (page 38)
  - Answering system (page 49)  
Messages cannot be received.
  - Voice mail features (page 55)
- After this mode is turned on or off, the base unit reboots.
  - Bluetooth connections from cellular phones or headset are disconnected. If the auto connection is turned on (page 19), the cellular phones are reconnected.
  - ☒ will be displayed on the handset momentarily. The handset can be used once ☒ is displayed.

## When you use the landline again

Before connecting the telephone line to the base unit, select "oFf" in step 2, "Cellular line only mode (If you do not use the landline)", page 20.

## Cellular line selection

This feature determines which cellular line is selected to make cellular calls when:

- you press [CELL] on the handset.
- you press [↩] or [↔] on the handset while the cellular line only mode is turned on.
- you press [SP-PHONE] on the base unit while the cellular line only mode is turned on. (KX-TG7741 series: page 3)

The following settings are available:

- "Manual" (handset only; default): You can select the desired cellular line when making a call.
- "Cellular phone 1" (base unit default): CELL 1 is selected.
- "Cellular phone 2": CELL 2 is selected.

**1 [MENU]**

- 2** For handset: **# [6] [3] [4]**  
For base unit<sup>1</sup>: **# [\*] [6] [3] [4]**

**3 [↕]:** Select the desired setting.

**4 [SAVE] → [OFF]**

<sup>1</sup> KX-TG7741 series: page 3

## Storing your area code (for dialing only a 7-digit phone number to make a local call)

You need to add your area code when making cellular calls to a phone number in your area. Once you store your area code, it is automatically added to the beginning of the 7-digit phone number when making cellular calls.

**1 [MENU] # [6] [3] [3]**

- 2** Enter the 3-digit area code.  
• To correct a digit, press **[CLEAR]**.

**3 [SAVE] → [OFF]**

## Changing the Bluetooth PIN (Personal Identification Number)

The PIN is used to register cellular phones to the base unit. The default PIN is "0000". To prevent unauthorized access to this product, we recommend that you change the PIN, and keep it confidential.

### Important:

- Please make note of your new PIN. The unit does not reveal the PIN to you. If you forget your PIN, see page 68.

**1 [MENU] # [6] [1] [9]**

**2** Enter the new 4-digit PIN. → **[OK]**

**3** Enter the new 4-digit PIN again. → **[SAVE]**

**4 [OFF]**

## Changing the PIN for the second time



Follow step 1, "Changing the Bluetooth PIN (Personal Identification Number)", page 21. Enter the current 4-digit PIN, then continue from step 2.

## Deregistering Bluetooth devices

A handset can cancel the registration of another Bluetooth device (cellular phone or headset) that is stored to the base unit.

**1 [MENU] # [1] [3] [4]**

**2 [↕]:** Select the desired device. → **[SELECT]**

-  indicates a cellular phone, and  indicates a headset.

**3 [↕]:** "Yes" → **[SELECT]**

- When the cellular phone is deregistered, the CELL 1 or CELL 2 indicator is turned off.
- When the headset is deregistered, the HEADSET indicator is turned off.

**4 [OFF]**

## Making cellular calls

### Important:

- Only 1 cellular line can be used at a time.
- Before making calls, confirm that the CELL 1 or CELL 2 indicator lights green (page 16).

- 1 Lift the handset and dial the phone number.
  - To correct a digit, press **[CLEAR]**.
- 2 **[CELL]**
  - The unit starts dialing when:
    - only 1 cellular phone is registered.
    - a specific line is set to make cellular calls (page 20).Go to step 4.
- 3 **[ $\blacktriangle$ ]**: Select the desired cellular phone. → **[SELECT]**
- 4 When you finish talking, press **[OFF]** or place the handset on the base unit or charger.

### Note:

- To switch to the speaker, press **[ $\blacktriangle$ ]**.
- To switch back to the receiver, press **[ $\blacktriangle$ ]/**[ $\curvearrowright$ ]**.**

## Adjusting the receiver or speaker volume

Press **[+]** or **[-]** repeatedly while talking.

### Note:

- There are 5 volume levels (1 to 5) for the receiver. When you change the receiver volume to level 5 (maximum level), the volume returns to level 4 (default) after you hang up.

## Making a cellular call using the redial list

The last 5 phone numbers dialed are stored in the redial list (each 48 digits max.).

- 1 **[ $\blacktriangleright$ ]** REDIAL
- 2 **[ $\blacktriangle$ ]**: Select the desired phone number.
- 3 **[CELL]**
  - The unit starts dialing when:
    - only 1 cellular phone is registered.

- a specific line is set to make cellular calls (page 20).

- 4 **[ $\blacktriangle$ ]**: Select the desired cellular phone. → **[SELECT]**

## Erasing a number in the redial list

- 1 **[ $\blacktriangleright$ ]** REDIAL
- 2 **[ $\blacktriangle$ ]**: Select the desired phone number. → **[ERASE]**
- 3 **[ $\blacktriangle$ ]**: “Yes” → **[SELECT]**
- 4 **[OFF]**

## Making landline calls

- 1 Lift the handset and dial the phone number.
  - To correct a digit, press **[CLEAR]**.
- 2 **[ $\curvearrowright$ ]**
- 3 When you finish talking, press **[OFF]** or place the handset on the base unit or charger.

## Using the speakerphone

- 1 Dial the phone number and press **[ $\blacktriangle$ ]**.
  - Speak alternately with the other party.
- 2 When you finish talking, press **[OFF]**.

### Note:

- For best performance, use the speakerphone in a quiet environment.
- To switch back to the receiver, press **[ $\blacktriangle$ ]/**[ $\curvearrowright$ ]**.**

## Making a call using the redial list

- 1 **[ $\blacktriangleright$ ]** REDIAL
- 2 **[ $\blacktriangle$ ]**: Select the desired phone number.
- 3 **[ $\curvearrowright$ ]**

## Pause (for PBX/long distance service users)

A pause is sometimes required when making calls using a PBX or long distance service. When storing a calling card access number

and/or PIN in the phonebook, a pause is also needed (page 32).

**Example:** If you need to dial the line access number "9" when making outside calls with a PBX:

- 1 **[9]** → **[PAUSE]**
- 2 Dial the phone number. → **[☎]**

**Note:**

- A 3.5 second pause is inserted each time **[PAUSE]** is pressed.

## Answering calls

When a call is being received, the ringer indicator flashes rapidly.

- 1 Lift the handset and press **[☎]** or **[📞]** when the unit rings.
  - To answer a cellular call, you can also press **[CELL]**.
  - You can also answer the call by pressing any dial key from **[0]** to **[9]**, **[\*]**, or **#[#]**. (**Any key answer feature**)
- 2 When you finish talking, press **[OFF]** or place the handset on the base unit or charger.

## Auto talk

You can answer calls simply by lifting the handset off the base unit or charger. You do not need to press **[☎]**. To turn this feature on, see page 38.

## Adjusting the handset ringer volume

### ■ While the handset is ringing for an incoming call:

Press **[+]** or **[-]** repeatedly to select the desired volume.

### ■ Programming the volume beforehand:

- 1 **To change the cellular line ringer volume:**

For CELL 1: **[MENU]#[6]2[8]1**

For CELL 2: **[MENU]#[6]2[8]2**

**To change the landline ringer volume:**

**[MENU]#[1]6[0]**

- 2 **[↕]**: Select the desired volume.

- 3 **[SAVE]** → **[OFF]**

## Temporary handset ringer off

While the handset is ringing for a call, you can turn the ringer off temporarily by pressing **[⏏]**.

## Useful features during a call

### Hold

This feature allows you to put an outside call on hold.

- 1 Press **[MENU]** during an outside call.
  - 2 **[↕]**: "Ho1d" → **[SELECT]**
  - 3 **To release hold on the cellular line:** Press **[CELL]**.
    - Another handset user can take the call: **[CELL]\*1** → **[SELECT]**
      - \*1 The call is taken when:
        - only 1 cellular phone is registered.
        - the line is set to make cellular calls (page 20).
    - The base unit user can take the call by pressing **[CELL 1]** or **[CELL 2]**. (KX-TG7741 series: page 3)
- To release hold on the landline:**  
Press **[☎]**.
- Another handset user can take the call by pressing **[☎]**.
  - The base unit user can take the call by pressing **[SP-PHONE]**. (KX-TG7741 series: page 3)

**Note:**

- If a call is kept on hold for more than 9 minutes, an alarm tone starts to sound and the ringer indicator flashes rapidly. After 1 additional minute on hold, the call is disconnected.
- If another phone is connected to the same line, you can also take the call by lifting its handset.

### Mute

While mute is turned on, you can hear the other party, but the other party cannot hear you.

- 1 Press **[MUTE]** during conversation.
  - **[MUTE]** flashes.
- 2 To return to the conversation, press **[MUTE]** again.

#### Note:

- **[MUTE]** is a soft key visible on the handset display during a call.

---

### Flash for landline calls

**[FLASH]** allows you to use the special features of your host PBX such as transferring an extension call, or accessing optional telephone services.

#### Note:

- To change the flash time, see page 38.

---

### For call waiting or Call Waiting Caller ID service users

To use call waiting or Call Waiting Caller ID, you must first subscribe with your service provider/telephone company.

This feature allows you to receive calls while you are already talking on the phone. If you receive a call while on the phone, you will hear a call waiting tone.

**If you subscribe to both Caller ID and Call Waiting with Caller ID services**, the 2nd caller's information is displayed after you hear the call waiting tone on the handset.

- 1 Press **[CALL WAIT]** to answer the 2nd call.
- 2 To switch between calls, press **[CALL WAIT]**.

#### Note:

- Please contact your service provider/telephone company for details and availability of this service in your area.

---

### Temporary tone dialing for landline calls (for rotary/pulse service users)

You can temporarily switch the dialing mode to tone when you need to access touch-tone services (for example, answering services, telephone banking services, etc.). Press **[TONE]** (TONE) before entering access numbers which require tone dialing.

---

### Handset clarity booster

This feature can improve sound clarity when the handset is used in an area where there may be interference. During an outside call, this feature is turned on automatically when necessary.

- When this feature is turned on, **[BOOST]** is displayed. However, during a cellular call, **[BOOST]** is not displayed even though the feature is activated.

---

### Handset equalizer

This feature clarifies the voice of the person you are talking to, producing a more natural-sounding voice that is easier to hear and understand.

- 1 Press **[MENU]** while talking.
- 2 **[↕]**: "Equalizer" → **[SELECT]**
- 3 **[↕]**: Select the desired setting.
- 4 Press **[OK]** to exit.

#### Note:

- When this feature is activated, **[EQ]** is displayed while talking.
- Depending on the condition and quality of your telephone line, this feature may emphasize existing line noise. If it becomes difficult to hear, turn this feature off.
- This feature is not available while using the speakerphone.

---

### Call share

You can join an existing outside call.



## ■ While another unit is on a cellular call:

- 1 To join the conversation, press **[CELL]**.
  - You can join the conversation when:
    - only 1 cellular phone is registered.
    - the line is set to make cellular calls (page 20).
- 2 **[↕]**: Select the desired cellular phone. → **[SELECT]**

## ■ While another unit is on a landline call:

To join the conversation, press **[↩]**.

### Note:

- A maximum of 3 parties (including 1 outside party) can join a conversation using 2 extensions. (**3-way conference**)
- To prevent other users from joining your conversations with outside callers, turn call sharing mode off (page 38).

## Transferring a cellular call between the handset and a cellular phone

### Transferring a cellular call from the handset to a cellular phone

- 1 Press **[MENU]** during a cellular call.
- 2 **[↕]**: “Transfer to cell” → **[SELECT]**
  - The cellular call is transferred to the cellular phone.

### Note:

- Depending on your cellular phone type, you may need to set the cellular phone to be ready to talk before transferring. For example, if your cellular phone has a top cover, open it beforehand.

### Transferring a cellular call from a cellular phone to the handset

During a conversation using a cellular phone, the call cannot be transferred to the handset by the cellular phone. Perform the following with the handset.

- 1 During a conversation using a cellular phone, press **[CELL]**.
  - The call is transferred to the handset when:
    - only 1 cellular phone is registered.
    - the line is set to make cellular calls (page 20).
- 2 **[↕]**: Select the desired cellular phone. → **[SELECT]**
  - The call is transferred to the handset.

## Using the other line during a conversation

You can handle a cellular call and a landline call at the same time. When another call is being received during a conversation, the interrupt tone sounds (page 37), and the 2nd caller's information is displayed if you subscribe to Caller ID (page 43). You can answer the 2nd call while holding the 1st call.

## Making/answering a cellular call during a conversation on the landline

- 1 Press **[MENU]** during a landline call.
- 2 **[↕]**: “Hold” → **[SELECT]**
- 3 **To make a 2nd call:**  
Dial the phone number. → **[CELL]**\*1 → **[↕]**: Select the desired cellular phone. → **[SELECT]**

- \*1 The unit starts dialing when:
- only 1 cellular phone is registered.
  - a specific line is set to make cellular calls (page 20).

### To answer a 2nd call: **[CELL]**

- To hold the 2nd call: **[MENU]** → **[↕]**: “Hold” → **[SELECT]**
- 4 To hang up the 2nd call and return to the 1st call (landline call), press **[OFF]**, then press **[↩]**.

## Making/answering a landline call during a conversation on a cellular line

- 1 Press **[MENU]** during a cellular call.

## Making/Answering Calls Using the Handset

---

- 2 **[⇅]**: "Hold" → **[SELECT]**
- 3 **To make a 2nd call:**  
Dial the phone number. → **[↶]**  
**To answer a 2nd call:**  
**[↶]**
  - To hold the 2nd call: **[MENU]** → **[⇅]**:  
"Hold" → **[SELECT]**
- 4 To hang up the 2nd call and return to the 1st call (cellular call), press **[OFF]**, then press **[CELL]**.

## Making cellular calls

### Available for:

KX-TG7741 series (page 3)

- 1 Press **[CELL 1]** or **[CELL 2]**.
- 2 Dial the phone number.
- 3 When the other party answers, speak into the microphone.
  - Speak alternately with the other party.
- 4 When you finish talking, press **[SP-PHONE]**.

### Note:

- For best performance, use the speakerphone in a quiet environment.
- While on a call, you can switch from the base unit to the handset:
 

With the call sharing mode on (page 29), press **[CELL]** on the handset. → **[↕]**:  
Select the desired cellular phone. → **[SELECT]** → Press **[SP-PHONE]** on the base unit.

  - When only 1 cellular phone is registered or the line is set to make cellular calls (page 20), press **[CELL]** on the handset, then press **[SP-PHONE]** on the base unit.

If the handset is on the base unit, simply lift it.

## Adjusting the speaker volume

Press **[+]** or **[-]** repeatedly while talking.

## Redialing the last number dialed

- 1 Press **[CELL 1]** or **[CELL 2]**.
- 2 **[REDIAL]**

## Making landline calls

- 1 **[SP-PHONE]**
- 2 Dial the phone number.
- 3 When the other party answers, speak into the microphone.

- 4 When you finish talking, press **[SP-PHONE]**.

### Note:

- While on a call, you can switch from the base unit to the handset:
 

Press **[↔]** on the handset, then press **[SP-PHONE]** on the base unit with the call sharing mode on (page 29).

If the handset is on the base unit, simply lift it.

## Redialing the last number dialed

**[SP-PHONE]** → **[REDIAL]**

## Pause (for PBX/long distance service users)

A pause is sometimes required when making calls using a PBX or long distance service. When storing a calling card access number and/or PIN in the phonebook, a pause is also needed (page 32).

**Example:** If you need to dial the line access number "9" when making outside calls with a PBX:

- 1 **[SP-PHONE]**
- 2 **[9]** → **[PAUSE]**
- 3 Dial the phone number.

### Note:

- A 3.5 second pause is inserted each time **[PAUSE]** is pressed.

## Answering calls

When a call is being received, the SP-PHONE indicator flashes rapidly.

When a cellular call is being received, the CELL 1 or CELL 2 indicator and SP-PHONE indicator flash rapidly.

- 1 Press **[SP-PHONE]** when the unit rings.
  - You can also answer the cellular call by pressing **[CELL 1]** or **[CELL 2]**.
- 2 Speak into the microphone.
- 3 When you finish talking, press **[SP-PHONE]**.

## Adjusting the base unit ringer volume

### ■ While the base unit is ringing for an incoming call:

Press **[+]** or **[-]** repeatedly to select the desired volume.

- To turn the ringer off, press and hold **[-]** until the unit beeps.

### ■ Programming the volume beforehand:

#### 1 To change the cellular line ringer volume:

For CELL 1: **[MENU]#\*6281**

For CELL 2: **[MENU]#\*6282**

#### To change the landline ringer volume:

**[MENU]#\*160**

- 2 **[↕]**: Select the desired volume.
- 3 **[SAVE] → [OFF]**

## Useful features during a call

### Hold

This feature allows you to put an outside call on hold.

#### 1 Press **[HOLD]** during an outside call.

#### 2 To release hold on the cellular line: Press **[CELL 1]** or **[CELL 2]**.

- A handset user can take the call:  
**[CELL]<sup>\*1</sup> → [SELECT]**

- <sup>\*1</sup> The call is taken when:
- only 1 cellular phone is registered.
  - the line is set to make cellular calls (page 20).

#### To release hold on the landline:

Press **[SP-PHONE]**.

- A handset user can take the landline call by pressing **[↶]**.

### Note:

- While a cellular line is on hold, the CELL 1 or CELL 2 indicator flashes red. While a landline call is on hold, the SP-PHONE indicator flashes.

- If a call is kept on hold for more than 9 minutes, an alarm tone starts to sound. After 1 additional minute on hold, the call is disconnected.
- If another phone is connected to the same line, you can also take the call by lifting its handset.

## Mute

While mute is turned on, you can hear the other party, but the other party cannot hear you.

- 1 Press **[MUTE]** during conversation.
  - The SP-PHONE indicator on the base unit flashes.
- 2 To return to the conversation, press **[MUTE]** again.

## Flash for landline calls

**[FLASH]** allows you to use the special features of your host PBX such as transferring an extension call, or accessing optional telephone services.

### Note:

- To change the flash time, see page 38.

## For call waiting service users

To use call waiting, you must first subscribe with your service provider/telephone company. This feature allows you to receive calls while you are already talking on the phone. If you receive a call while on the phone, you will hear a call waiting tone.

- 1 Press **[CALL WAIT]** to answer the 2nd call.
- 2 To switch between calls, press **[CALL WAIT]**.

### Note:

- Please contact your service provider/telephone company for details and availability of this service in your area.

## Temporary tone dialing for landline calls (for rotary/pulse service users)

You can temporarily switch the dialing mode to tone when you need to access touch-tone services (for example, answering services, telephone banking services, etc.). Press **[TONE]** before entering access numbers which require tone dialing.

## Call share

You can join an existing outside call. To select the line that is being used for the call:

- for a cellular line press **[CELL 1]** or **[CELL 2]**.
- for the landline press **[SP-PHONE]**.

### Note:

- A maximum of 3 parties (including 1 outside party) can join a conversation using 2 extensions. **(3-way conference)**
- To prevent other users from joining your conversations with outside callers, turn call sharing mode off (page 38).

## Transferring a cellular call between the base unit and a cellular phone

### Transferring a cellular call from the base unit to a cellular phone

During a cellular call, press and hold **[CELL 1]** or **[CELL 2]** until the SP-PHONE indicator goes out.

- The cellular call is transferred to the cellular phone.

### Transferring a cellular call from a cellular phone to the base unit

During a conversation using a cellular phone, press **[CELL 1]** or **[CELL 2]**.

- The cellular call is transferred to the base unit.

## Using the other line during a conversation

You can handle a cellular call and a landline call at the same time. When another call is being received during a conversation, the interrupt tone sounds (page 37). You can answer the 2nd call while holding the 1st call.

## Making/answering a cellular call during a conversation on the landline

- 1 Press **[HOLD]** during a landline call.
- 2 **To make a 2nd call:**  
Press **[CELL 1]** or **[CELL 2]**. → Dial the phone number.  
**To answer a 2nd call:**  
Press **[CELL 1]** or **[CELL 2]**.
  - To hold the 2nd call, press **[HOLD]**.
- 3 To hang up the 2nd call and return to the 1st call (landline call), press **[SP-PHONE]** 2 times.

## Making/answering a landline call during a conversation on a cellular line

- 1 Press **[HOLD]** during a cellular call.
- 2 **To make a 2nd call:**  
**[SP-PHONE]** → Dial the phone number.  
**To answer a 2nd call:**  
**[SP-PHONE]**
  - To hold the 2nd call, press **[HOLD]**.
- 3 To hang up the 2nd call and return to the 1st call (cellular call), press **[SP-PHONE]**, then press **[CELL 1]** or **[CELL 2]**.

## Shared phonebook

The shared phonebook allows you to make calls without having to dial manually. Any handset registered to the base unit can use the shared phonebook. You can add 3,050 names and phone numbers to the shared phonebook, and assign each phonebook entry to the desired group ("Home", "Cell 1", "Cell 2").

### Important:

- Only 1 person can access the shared phonebook at a time.
- Caller ID subscribers can use group ringer tone features (page 43).
- You can copy phonebook entries from a Bluetooth cellular phone to the unit's shared phonebook (page 46).

## Adding entries

- 1 **[📖]** → **[ADD]**
- 2 Enter the party's name (16 characters max.). → **[OK]**
- 3 Enter the party's phone number (24 digits max.). → **[OK]**
- 4 **[↕]**: Select the desired group. → **[SELECT]** 2 times
  - To add other entries, repeat from step 2.
- 5 **[OFF]**

## Character table for entering names

While entering characters, you can switch between uppercase and lowercase by pressing **[A→a]**.

Key	Character
<b>[1]</b>	& ' ( ) * , - . / 1
<b>[2]</b>	A B C 2
	a b c 2
<b>[3]</b>	D E F 3
	d e f 3

Key	Character
<b>[4]</b>	G H I 4
	g h i 4
<b>[5]</b>	J K L 5
	j k l 5
<b>[6]</b>	M N O 6
	m n o 6
<b>[7]</b>	P Q R S 7
	p q r s 7
<b>[8]</b>	T U V 8
	t u v 8
<b>[9]</b>	W X Y Z 9
	w x y z 9
<b>[0]</b>	_ 0
<b>[#]</b>	#

- To enter another character that is located on the same dial key, first press **[▶]** to move the cursor to the next space.
- If you do not press any dial key within 5 seconds after entering a character, the character is fixed and the cursor moves to the next space.
- \_ in the above table represents a single space.

## Erasing the character or number

Press **[◀]** or **[▶]**. → **[CLEAR]**

- Press and hold **[CLEAR]** to erase all characters or numbers.

## Groups

Groups can help you find entries in the phonebook quickly and easily. When adding an entry to the phonebook, you can assign it to one of 3 groups. You can search for phonebook entries by group. The group ringer tone feature is available for Caller ID subscribers (page 43).

## Finding and calling from a phonebook entry

### Scrolling through all entries

#### ■ Using a cellular line

- 1 [OK]
- 2 : Select the desired entry.
- 3 [CELL]
  - The unit starts dialing when:
    - only 1 cellular phone is registered.
    - a specific line is set to make cellular calls (page 20).
- 4 : Select the desired cellular phone. → [SELECT]

#### ■ Using the landline

- 1
- 2 : Select the desired entry.
- 3

### Searching by first character

- 1
- 2 Press the dial key ( – or ) which contains the character you are searching for (page 30).
  - Press the same dial key repeatedly to display the first entry corresponding to each character located on that dial key.
  - If there is no entry corresponding to the character you selected, the next entry is displayed.
- 3 : Scroll through the phonebook if necessary.
- 4 To make a cellular/landline call, continue from step 3, “Scrolling through all entries”, page 31.

### Searching by query

You can narrow down the search to enter the first characters of a name.

- 1 →

- 2 To search for the name, enter the first characters (up to 4) in uppercase (page 30).
  - Characters cannot be entered in lowercase.
  - If there is no entry corresponding to the characters you selected, the next entry is displayed.
- 3 [OK]
- 4 : Scroll through the phonebook if necessary.
- 5 To make a cellular/landline call, continue from step 3, “Scrolling through all entries”, page 31.

### Searching by group

- 1 → [GROUP]
- 2 : Select the group you want to search. → [SELECT]
  - If you select “A11”, the unit ends the group search.
- 3 : Select the desired entry.
- 4 To make a cellular/landline call, continue from step 3, “Scrolling through all entries”, page 31.

### Editing entries

- 1 Find the desired entry (page 31). → [MENU]
- 2 : “Edit” → [SELECT]
- 3 Edit the name if necessary (16 characters max.; page 30). → [OK]
- 4 Edit the phone number if necessary (24 digits max.). → [OK]
- 5 : Select the desired group (page 30). → [SELECT] 2 times
- 6 [OFF]

### Erasing entries

#### Erasing an entry

- 1 Find the desired entry (page 31). → [ERASE]

2 [↕]: “Yes” → [SELECT]

3 [OFF]

---

### Erasing all entries in a group

1 [📖] → [MENU]

2 [↕]: “Erase all” → [SELECT]

3 [↕]: Select the desired group. →  
[SELECT]

4 [↕]: “Yes” → [SELECT]

5 [↕]: “Yes” → [SELECT]

6 [OFF]

---

### Chain dial

This feature allows you to dial phone numbers in the phonebook while you are on a call. This feature can be used, for example, to dial a calling card access number or bank account PIN that you have stored in the phonebook, without having to dial manually.

1 During an outside call: [MENU] →  
[↕]: “Phonebook” → [SELECT]

2 [↕]: Select the desired entry.

3 Press [CALL] to dial the number.

#### Note:

- When storing a calling card access number and your PIN in the phonebook as one phonebook entry, press [PAUSE] to add pauses after the number and PIN as necessary (page 22).
- If you have rotary/pulse service, you need to press [☒] (TONE) before pressing [MENU] on the handset in step 1 to change the dialing mode temporarily to tone. When adding entries to the phonebook, we recommend adding [☒] (TONE) to the beginning of phone numbers you wish to chain dial (page 30).



## Programmable settings

You can customize the unit by programming the following features using the handset.  
To access the features, there are 2 methods:

### ■ Scrolling through the display menus

- 1 **[MENU]**
- 2 Press **[▼]** or **[▲]** to select the desired main menu. → **[SELECT]**
- 3 Press **[▼]** or **[▲]** to select the desired item from the next sub-menus. → **[SELECT]**
- 4 Press **[▼]** or **[▲]** to select the desired setting. → **[SAVE]**
  - This step may vary depending on the feature being programmed.
  - To exit the operation, press **[OFF]**.

### ■ Using the direct command code

- 1 **[MENU]** → Enter the desired code.  
**Example:** Press **[MENU][#][1][0][1]**.
- 2 Select the desired setting. → **[SAVE]**
  - This step may vary depending on the feature being programmed.
  - To exit the operation, press **[OFF]**.

#### Note:

- In the following table, < > indicates the default settings.
- In the following table,  indicates the reference page number.
- Display menu order and sub-menu may vary depending on your model.

## Display the menu tree and direct command code table

Main menu:  "Caller list"

Operation	Code	
Viewing the caller list.	#213	44

Main menu:  "Answering device"

Sub-menu 1	Sub-menu 2	Settings	Code	
Play new msg. (msg.: message)	–	–	#323	51
Play all msg.	–	–	#324	51
Erase all msg.*1	–	–	#325	51
Greeting	Record greeting*1	–	#302	50
	Check greeting	–	#303	50
	Pre-recorded*1 (Reset to pre-recorded greeting)	–	#304	50

## Programming

Sub-menu 1	Sub-menu 2	Settings	Code	
Settings	Ring count* <sup>1</sup>	2-7: 2-7 rings <4 rings> 0: Toll saver	#211	53
	Recording time* <sup>1</sup>	1: 1 min 3: <3 min> 0: Greeting only* <sup>2</sup>	#305	53
	Remote code* <sup>1</sup>	<111>	#306	51
	Screen call	1: <On> 0: Off	#310	49
Answer on* <sup>1</sup>	-	-	#327	49
Answer off* <sup>1</sup>	-	-	#328	49

Main menu:  "V.M. access"\*<sup>3</sup> (V.M.: Voice mail)

Operation	Code	
Listening to voice mail messages.	#330	56

Main menu:  "Intercom"

Operation	Code	
Paging the desired unit.	#274	57

Main menu:  "Bluetooth"

Sub-menu 1	Sub-menu 2	Settings	Code	
Link to cell - 1: Add new device <sup>4</sup> (for CELL 1) - 2: Add new device <sup>4</sup> (for CELL 2)	Connect <sup>*1</sup> / Disconnect <sup>*1</sup>	-	#6251 <sup>*5</sup>	20
			#6252 <sup>*6</sup>	
	Ringer volume - Handset	0-6: Off-6 <6>	#6281 <sup>*5</sup>	23
			#6282 <sup>*6</sup>	
	Ringer volume - Base unit <sup>*1</sup>	0-6: Off-6 <1>	#*6281 <sup>*5</sup>	28
			#*6282 <sup>*6</sup>	
	Ringer tone <sup>*7, *8</sup>	1-5: Tone 1-5 <Tone 2> <sup>*5</sup> <Tone 4> <sup>*6</sup> 6-0: Melody 1-5	#6291 <sup>*5</sup>	-
			#6292 <sup>*6</sup>	
Select unit to ring <sup>*1</sup>	1-6: Handset 1-6 *: <All>	#6271 <sup>*5</sup>	19	
		#6272 <sup>*6</sup>		
Ring as cell (limited) <sup>*1</sup>	1: <On (with Talking CID)> 2: On (without Talking CID) 0: Off	#6141 <sup>*5</sup>	19	
		#6142 <sup>*6</sup>		
Registration	-	#6241 <sup>*5</sup>	18	
		#6242 <sup>*6</sup>		
Phonebook transfer	-	-	#618	46
Headset	Add new device <sup>*4</sup>	-	#621	47
	Connect <sup>*1</sup> / Disconnect <sup>*1</sup>	-	#622	47
	Registration	-	#621	47

## Programming

Sub-menu 1	Sub-menu 2	Settings	Code	
Settings	Auto connect* <sup>1</sup>	1: <1 min> 2: 3 min 3: 5 min 4: 10 min 0: Off	#632	19
	Cell area code* <sup>1</sup>	–	#633	21
	Cell line only mode* <sup>1</sup>	1: On 0: <Off>	#157	20
	Cell line select – Handset	1: Cellphone 1* <sup>4</sup> 2: Cellphone 2* <sup>4</sup> 0: <Manual>	#634	20
	Cell line select – Base unit* <sup>1,9</sup>	1: Cellphone 1* <sup>4</sup> 2: Cellphone 2* <sup>4</sup>	# <del>X</del> 634	
	Set PIN* <sup>1</sup>	<0000>	#619	21
Deregistration* <sup>2</sup>	–	–	#134	21

Main menu:  "Set date & time"

Sub-menu 1	Sub-menu 2	Settings	Code	
Date and time* <sup>1</sup>	–	–	#101	17
Alarm	–	1: Once 2: Daily 0: <Off>	#720	40
Time adjustment* <sup>1,10</sup>	–	1: <Caller ID auto> 0: Manual	#226	–

Main menu:  "Initial setting"

Sub-menu 1	Sub-menu 2	Settings	Code	
Ringer setting	Ringer volume – Handset <sup>*3</sup>	0-7: Off-7 <6>	#160	23
	Ringer volume – Base unit <sup>*1, *3</sup>	0-6: Off-6 <1>	#*160	28
	Ringer tone <sup>*3, *7, *8, *11</sup> (Handset)	1-5: Tone 1-5 <Tone 1> 6-0: Melody 1-5	#161	–
	Interrupt tone – Handset <sup>*12</sup>	1: <On> 0: Off	#201	25
	Interrupt tone – Base unit <sup>*1, *9, *12</sup>	1: <On> 0: Off	#*201	29
	Silent mode – On/Off	1: On 0: <Off>	#238	40
	Silent mode – Start/End	<11:00 PM/06:00 AM>	#237	40
Set date & time	Date and time <sup>*1</sup>	–	#101	17
	Alarm	1: Once 2: Daily 0: <Off>	#720	40
	Time adjustment <sup>*1, *10</sup>	1: <Caller ID auto> 0: Manual	#226	–
Talking Caller ID	Handset	1: <On> 0: Off	#162	43
	Base unit <sup>*1</sup>	1: On 0: <Off>	#*162	
Handset name	–	–	#104	40
Call block <sup>*1</sup>	–	–	#217	41
	Block w/o num <sup>*1, *2</sup> (Block calls without phone number)	1: On 0: <Off>	#240	41
Voice mail <sup>*3</sup>	Store VM access# <sup>*1</sup> (VM: Voice mail)	–	#331	55
	VM tone detect <sup>*1</sup>	1: <On> 0: Off	#332	55
Message alert	–	1: <On> 0: Off	#340	53
LCD contrast (Display contrast)	–	1-6: Level 1-6 <3>	#145	–
Key tone <sup>*13</sup>	–	1: <On> 0: Off	#165	–

Sub-menu 1	Sub-menu 2	Settings	Code	
Caller ID edit (Caller ID number auto edit)	–	1: <On> 0: Off	#214	44
Auto talk <sup>*14</sup>	–	1: On 0: <Off>	#200	23
Set tel line <sup>*3</sup>	Set dial mode <sup>*1</sup>	1: Pulse 2: <Tone>	#120	17
	Set flash time <sup>*1, *15</sup>	0: 900 ms 1: <700 ms> 2: 600 ms 3: 400 ms 4: 300 ms 5: 250 ms *: 200 ms #: 160 ms 6: 110 ms 7: 100 ms 8: 90 ms 9: 80 ms	#121	24
	Set line mode <sup>*1, *16</sup>	1: A 2: <B>	#122	–
Call sharing <sup>*1</sup>	–	1: <On> 0: Off	#194	24, 29
Registration	Register handset	–	#130	42
	Deregistration <sup>*2</sup>	–	#131	42
Change language	Display	1: <English> 2: Español	#110	17
	Voice prompt <sup>*1</sup>	1: <English> 2: Español	#112	17

## Main menu: “Customer support”

Operation	Code	
Displaying customer support Web address.	#680	–

<sup>\*1</sup> If you program these settings using one of the handsets, you do not need to program the same item using another handset.

<sup>\*2</sup> This menu is not displayed when scrolling through the display menus. It is only available in direct command code.

<sup>\*3</sup> When the cellular line only mode is turned on, these menus are not displayed (page 20).

<sup>\*4</sup> After the Bluetooth device is registered, the device name is displayed.

<sup>\*5</sup> For CELL 1

<sup>\*6</sup> For CELL 2

<sup>\*7</sup> If you select one of the melody ringer tones, the ringer tone continues to play for several seconds even if the caller has already hung up. You may either hear a dial tone or no one on the line when you answer the call.

- \*8 The preset melodies in this product are used with permission of © 2009 Copyrights Vision Inc.
- \*9 KX-TG7741 series: page 3
- \*10 This feature allows the unit to automatically adjust the date and time each time caller information including date and time is received.  
To turn this feature on, select “**Caller ID auto**”. To turn this feature off, select “**Manual**”. (Caller ID subscribers only)  
To use this feature, set the date and time first (page 17).
- \*11 If you subscribe to a distinctive ring service (such as IDENT-A-RING), select a tone (tone 1 to 5). If you select a melody, you cannot distinguish lines by their ringers.
- \*12 This tone lets you know when you receive an outside call while you are on another line or an intercom call. If you select “**On**”, the tone sounds 2 times.
- \*13 Turn this feature off if you prefer not to hear key tones while you are dialing or pressing any keys, including confirmation tones and error tones.
- \*14 If you subscribe to a Caller ID service and want to view the caller’s information after lifting up the handset to answer a call, turn off this feature.
- \*15 The flash time depends on your telephone exchange or host PBX. Contact your PBX supplier if necessary. The setting should stay at “**700 ms**” unless pressing [**FLASH**] fails to pick up the waiting call.
- \*16 Generally, the line mode setting should not be changed. This setting automatically maintains receiver volume at the proper level depending on the current telephone line condition. Set the line mode to “**A**” if telephone line condition is not good.

## Special programming

### Alarm

An alarm sounds at the set time for 3 minutes once or daily. Alarm can be set for each handset.

#### Important:

- Set the date and time beforehand (page 17).

1 **[MENU]** **#** **7** **2** **0**

2 **[ $\updownarrow$ ]**: Select the desired alarm option. → **[SELECT]**

Off	Turns alarm off. Go to step 7.
Once	An alarm sounds once at the set time.
Daily	An alarm sounds daily at the set time. Go to step 4.

3 Enter the desired month and date. → **[OK]**

4 Set the desired time.

5 **[AM/PM]**: Select “AM” or “PM”. → **[OK]**

6 **[ $\updownarrow$ ]**: Select the desired alarm tone. → **[SELECT]**

- We recommend selecting a different ringer tone from the one used for outside calls.

7 **[SELECT]** → **[OFF]**

- When the alarm is set, **⓪** is displayed.

#### Note:

- To stop the alarm, press **[OFF]** or place the handset on the base unit or charger.
- When the handset is in use, the alarm will not sound until the handset is in standby mode.

### Silent mode

Silent mode allows you to select a period of time during which the handset will not ring for outside calls. This feature is useful for time periods when you do not want to be disturbed,

for example, while sleeping. Silent mode can be set for each handset.

#### Important:

- Set the date and time beforehand (page 17).
- We recommend turning the base unit ringer off (page 35, 37) in addition to turning the silent mode on.
- If you have set the alarm, the alarm sounds even if the silent mode is turned on.

### Turning silent mode on/off

1 **[MENU]** **#** **2** **3** **8**

2 **[ $\updownarrow$ ]**: Select the desired setting. → **[SAVE]**

- If you select “OFF”, press **[OFF]** to exit.

3 Enter the desired hour and minute you wish to start this feature.

4 **[AM/PM]**: Select “AM” or “PM”. → **[OK]**

5 Enter the desired hour and minute you wish to end this feature.

6 **[AM/PM]**: Select “AM” or “PM”.

7 **[SAVE]** → **[OFF]**

- When the silent mode is set, **ZzZ** is displayed.

### Changing the start and end time

1 **[MENU]** **#** **2** **3** **7**

2 Continue from step 3, “Turning silent mode on/off”, page 40.

### Changing the handset name

Each handset can be given a customized name (“Bob”, “Kitchen”, etc.). This is useful when you make intercom calls between handsets. You can also select whether or not the handset name is displayed in standby mode. The default setting is “No”. If you select “Yes” without entering any handset name, “Handset 1” to “Handset 6” is displayed.

1 **[MENU]** **#** **1** **0** **4**



- 2 Enter the desired name (max. 10 characters; see the character table, page 30).
  - If not required, go to step 3.
- 3 **[SAVE]**
- 4 [**↕**]: Select the desired setting. → **[SELECT]** 2 times
- 5 **[OFF]**

## Call block (Caller ID subscribers only)

This feature allows the unit to reject calls when:

- the unit receives a call from a phone number stored in the call block list as unwanted (“Storing unwanted callers”, page 41).
- the unit receives a call without phone number (“Blocking incoming calls without phone number”, page 41).

When a call is received, the unit rings for a short time while the caller is being identified. If the phone number matches an entry in the call block list:

- cellular calls are rejected.
- landline calls are disconnected after the unit first sends out a busy tone to the caller.

### Important:

- When the unit receives a call from a number that is stored in the call block list or a call without a recognized phone number, the call is logged in the caller list (page 44) with **↔** after the call is disconnected.

## Storing unwanted callers

You can store up to 30 phone numbers in the call block list.

### Important:

- We recommend storing 10 digits (including an area code). If only 7 digits are stored, all numbers that have the same last 7 digits will be blocked.

### ■ From the caller list:

- 1 [**←**] CID

- 2 [**↕**]: Select the entry to be blocked.
  - To edit the number, press **[SELECT]**, then press **[EDIT]** repeatedly until the phone number is shown in the 10-digit format.

- 3 **[SAVE]**

- 4 [**↕**]: “Call block” → **[SELECT]**

- 5 [**↕**]: “Yes” → **[SELECT]**

- 6 Edit the phone number if necessary (24 digits max.).

- 7 **[SAVE]** → **[OFF]**

### ■ By entering phone numbers:

- 1 **[MENU]** **#** **2** **1** **7** → **[ADD]**

- 2 Enter the phone number (24 digits max.).
  - To erase a digit, press **[CLEAR]**.

- 3 **[SAVE]** → **[OFF]**

## Blocking incoming calls without phone number

You can reject a call when no phone number is provided, such as a call just showing “Out of area”.

- 1 **[MENU]** **#** **2** **4** **0**

- 2 [**↕**]: Select the desired setting. → **[SAVE]** → **[OFF]**

## Viewing/editing/erasing call block numbers

- 1 **[MENU]** **#** **2** **1** **7**

- 2 [**↕**]: Select the desired entry.
  - To exit, press **[OFF]**.

- 3 **To edit a number:**

**[EDIT]** → Edit the phone number. →

**[SAVE]** → **[OFF]**

**To erase a number:**

**[ERASE]** → [**↕**]: “Yes” → **[SELECT]** → **[OFF]**

### Note:

- When editing, press the desired dial key to add, **[CLEAR]** to erase.
- When viewing, “Block w/o num” is displayed if the blocking incoming calls without phone number feature is turned on.

To turn the feature off: **[ERASE]** → **[▼]**  
→ **[SAVE]** → **[OFF]**

---

## Registering a unit

---

### Operating additional units

#### Additional handsets

Up to 6 handsets can be registered to the base unit.

##### Important:

- See page 5 for information on the available model.

---

### Registering a handset to the base unit

The supplied handset and base unit are pre-registered. If for some reason the handset is not registered to the base unit, re-register the handset.

**1 Handset:**  
**[MENU]** **#** **1** **3** **0**

**2 Base unit:**  
Press and hold **[LOCATOR]** for about 5 seconds until the registration tone sounds.

- If all registered handsets start ringing, press **[LOCATOR]** again to stop, then repeat this step.
- The next step must be completed within 90 seconds.

**3 Handset:**  
Press **[OK]**, then wait until a long beep sounds.

##### Note:

- While registering, “**Base in registering**” is displayed on all registered handsets.
- When you purchase an additional handset, refer to the additional handset’s installation manual for registration.

---

### Deregistering a handset

A handset can cancel its own registration to the base unit, or other handsets registered to

the same base unit. This allows the handset to end its wireless connection with the system.

- 1 [MENU]** **#** **1** **3** **1**
  - All handsets registered to the base unit are displayed.
- 2 [↕]:** Select the handset you want to cancel. → **[SELECT]**
- 3 [↕]:** “Yes” → **[SELECT]**
- 4 [OFF]**

## Using Caller ID service

### Important:

- This unit is Caller ID compatible. To use Caller ID features, you must subscribe to a Caller ID service. Contact your service provider/telephone company for details.

## Caller ID features

When an outside call is being received, the caller's name and phone number are displayed.

Caller information for the last 50 callers is logged in the caller list from the most recent call to the oldest.

- If the unit cannot receive caller information, the following is displayed:
  - “**Out of area**”: The caller dials from an area which does not provide a Caller ID service.
  - “**Private caller**”: The caller requests not to send caller information.
  - “**Long distance**”: The caller makes a long distance call.
- If the unit is connected to a PBX system, caller information may not be properly received. Contact your PBX supplier.

## Missed calls

If a call is not answered, the unit treats it as a missed call. The display shows “**Missed call**”.

### Note:

- Even when there are unviewed missed calls, “**Missed call**” disappears from the standby display if the following operation is performed by one of the units:
  - A handset is replaced on the base unit or charger.
  - Pressing **[OFF]** on a handset.

## Phonebook name display

When caller information is received and it matches a phone number stored in the phonebook, the stored name in the phonebook is displayed and logged in the caller list.

## Talking Caller ID

### Handset / Base unit

This feature lets you know who is calling without looking at the display.

To use this feature, you must:

- subscribe to a Caller ID service of your service provider/telephone company.
- turn this feature on (page 37).

When caller information is received, the handsets and base unit announce the caller's name or phone number received from your service provider/telephone company following every ring.

The unit announces in English only.

- Name pronunciation may vary. This feature may not pronounce all names correctly.
- Caller ID service has a limit of how many characters can be displayed. If the caller's name is too long:
  - the handset may not be able to display or announce the entire name.
  - the base unit may not be able to announce the entire name.
- The announcement is heard at the same level as the ringer volume (page 23, 28).
- If you turn on the answering system and set the number of rings “**2 rings**” (page 53), the unit does not announce the caller information from the headline. If “**Toll saver**” is selected and there is a new message, the unit does not announce the caller information from the headline.
- When you receive a call while on the phone, the 2nd caller's name is not announced even if you subscribe to both Caller ID and Call Waiting with Caller ID services.

## Phonebook name announcement

When caller information is received and it matches a phone number stored in the phonebook, the stored name in the phonebook is announced.

## Ringer ID

You can select the desired ringer tone to a group that each phonebook entry is assigned

(page 30). When a call is received from a caller assigned to a group, the ringer tone you selected for that group rings instead of the called line's ringer tone (page 19, 35, 37) after caller information is displayed. If you select "Current ringer" (default), the unit uses the called line's ringer tone when calls from this group are received.

- 1 [ ] → [MENU]
- 2 [ ]: "Group" → [SELECT]
- 3 [ ]: Select the desired group. → [SELECT]
- 4 [ ]: Select the desired ringer tone. → [SAVE]
- 5 [OFF]

## Caller list

### Important:

- Only 1 person can access the caller list at a time.
- Make sure the unit's date and time setting is correct (page 17).

## Viewing the caller list and calling back

### ■ Using a cellular line

- 1 [ ] CID
- 2 Press [ ] to search from the most recent call, or [ ] to search from the oldest call.
- 3 To call back, press [SELECT].  
To exit, press [OFF].
- 4 [CELL]
  - The unit starts dialing when:
    - only 1 cellular phone is registered.
    - a specific line is set to make cellular calls (page 20).

- 5 [ ]: Select the desired cellular phone. → [SELECT]

### ■ Using the landline

- 1 [ ] CID
- 2 Press [ ] to search from the most recent call, or [ ] to search from the oldest call.

- 3 To call back, press [ ].  
To exit, press [OFF].

### Note:

- If the entry has already been viewed or answered, "✓" is displayed, even if it was viewed or answered using another unit.
- In step 2, if is displayed, not all of the information is shown. To see the remaining information, press [ ]. To return to the previous screen, press [ ].
- or indicates the caller information was received from the cellular line.

## Editing a caller's phone number before calling back

You can edit a phone number in the caller list by removing its area code and/or the long distance code "1".

- 1 [ ] CID
- 2 [ ]: Select the desired entry.
- 3 Press [SELECT], then press [EDIT] repeatedly until the phone number is shown in the desired format.

- ① Local phone number  
**Example:** 321-5555
- ② Area code – Local phone number  
**Example:** 555-321-5555
- ③ 1 – Area code – Local phone number  
**Example:** 1-555-321-5555

### 4 Using a cellular line:

To make a cellular call, continue from step 4, "Viewing the caller list and calling back", page 44.

### Using the landline:

[ ]

## Caller ID number auto edit feature

Once you call back an edited number, the unit which was used to call back remembers the area code and format of the edited number. The next time someone calls from the same area code, caller information is customized by the unit as follows:

- When the call is being received, the Caller ID number is displayed in the same format as the edited number.
- After the call has ended, the caller's phone number is displayed in the same format as the edited number, when reviewed from the caller list.

For example, you can use this feature to set the unit to ignore the area code of callers in your area, so that you can call these local numbers using caller information without dialing the area code.

To activate this feature, you must edit an entry in the caller list, then call that number. After that, phone numbers from that caller's area code are edited automatically.

This feature can be set for each handset (page 38). The default setting is "on".

**Note:**

- Phone numbers from the 4 most recently edited area codes are automatically edited.

**4** [↕]: "Phonebook" → [SELECT]

**5** Continue from step 3, "Editing entries", page 31.

---

### Erasing selected caller information

- 1** [←] CID
- 2** [↕]: Select the desired entry.
- 3** [ERASE] → [↕]: "Yes"
- 4** [SELECT] → [OFF]

---

### Erasing all caller information

- 1** [←] CID
- 2** [ERASE] → [↕]: "Yes"
- 3** [SELECT] → [OFF]

---

### Storing caller information to the phonebook

- 1** [←] CID
- 2** [↕]: Select the desired entry.
  - To edit the number, press [SELECT], then press [EDIT] repeatedly until the phone number is shown in the desired format.
- 3** [SAVE]

### Copying phonebook from a cellular phone (phonebook transfer)

You can copy phonebook entries from the registered cellular phones or other cellular phones (not registered) to the unit's shared phonebook. A cellular phone must be Bluetooth wireless technology compatible.

#### Important:

- If a copied entry has 2 or more phone numbers, each phone number (6 max.) is stored as a separate entry with the same name.
- If a phonebook entry includes additional data such as a picture, that entry may fail to copy to the base unit.

#### 1 Handset:

[MENU] [F] [6] [1] [8]

#### 2 Handset:

**To copy from registered cellular phones:**

[↕]: Select the desired cellular phone. → [SELECT]

- Copied items are stored to the group ("Cell 1" or "Cell 2") which the cellular phone is registered to.

**To copy from other cellular phones (not registered):**

[↕]: "Other cell" → [SELECT] →

[↕]: Select the group you want to copy to. → [SELECT]

#### 3 When "Transfer phonebook from cell." is displayed:

Go to step 4.

**When "Select mode" menu is displayed:**

[↕]: Select "Auto" or "Manual". →

[SELECT]

"Auto": Download all entries from the cellular phone automatically. Go to step 5.  
"Manual": Copy entries you selected.

- "Select mode" menu is displayed only when the cellular phone supports PBAP (Phone Book Access Profile) for Bluetooth connection.

#### 4 Cellular phone:

Follow the instructions of your cellular phone to copy phonebook entries.

- For other cellular phones (not registered), you need to search for and select the base unit. The base unit PIN (default: "0000") may be required.
- The entries being copied are displayed on the handset.

#### 5 Handset:

Wait until "Completed" is displayed.

- You can continue copying other entries if necessary.

#### 6 Handset: [OFF]

#### Note:

- Some copied entries may have characters which do not exist in the character table (page 30). These characters can be displayed but cannot be entered when editing an entry.
- The unit does not support some characters. If a copied entry includes those characters, they are replaced with other available characters or "\*".
- If you receive a call while copying phonebook entries, the copying procedure stops. Try again after finishing the call.

## Using a Bluetooth wireless headset (optional) for landline calls

By registering a Bluetooth headset to the base unit, you can have a hands-free conversation wirelessly for landline calls.

### Important:

- 1 headset can be registered to the base unit. However, only one Bluetooth device (cellular phone or headset) can be connected to the base unit at a time.
- For best performance, we recommend using a Bluetooth headset within 1 m (3.3 feet) of the base unit. A headset can communicate with the base unit within a range of approximately 10 m (33 feet).

## Registering a headset to the base unit

### Important:

- Make sure that the Bluetooth headset is not connected to any other Bluetooth device.

### 1 Your headset:

Set your headset to registration mode.

- Refer to the headset operating instructions.

### 2 Headset:

**[MENU]** **[#]** **[6]** **[2]** **[1]**

### 3 Enter your headset PIN.

- Typically, default PIN is "0000". Refer to the headset operating instructions.

### 4 Press **[OK]**, then wait until a long beep sounds.

### 5 **[OFF]**

- When the HEADSET indicator on the base unit lights green, you are ready to use the headset.

## Connecting/disconnecting a headset

If you cannot connect the headset and base unit using the headset, you can connect using the unit.

To use your headset with another Bluetooth device such as a cellular phone, you may need to disconnect it from the base unit.

### Important:

- Make sure that the headset is turned on.

### Base unit\*1

\*1 KX-TG7741 series: page 3

### To connect:

Press **[HEADSET]**.

### To disconnect:

Press and hold **[HEADSET]** until a long beep sounds.

### Headset

### 1 To connect/disconnect:

**[MENU]** **[#]** **[6]** **[2]** **[2]**

- A long beep sounds.

### 2 **[OFF]**

## Deregistering a headset

You can cancel a registration of the headset that is stored to the base unit. See "Deregistering Bluetooth devices", page 21.

## Operating a Bluetooth wireless headset using a landline

### Important:

- Refer to your headset operating instructions for headset operations.

## Answering landline calls with your headset

To answer a landline call, turn on your headset referring to your headset operating instructions.

When you finish talking, turn off your headset referring to your headset operating instructions.

### Note:

- If you cannot hang up the call using your headset;
  - press **[■]** (STOP) on the base unit. (KX-TG7731 series: page 3)

- press **[SP-PHONE]** on the base unit 2 times. (KX-TG7741 series: page 3)

### Switching between the base unit and your headset

You can switch between the base unit and your headset:

- during a landline call with the base unit speakerphone. (KX-TG7741 series: page 3)
- during an intercom call between the base unit and handset. (KX-TG7741 series: page 3)
- while listening to messages recorded on the base unit answering system.\*1

#### ■ KX-TG7741 series: page 3

##### To switch to your headset:

Press **[HEADSET]** on the base unit.

##### To switch to the base unit:

Press **[SP-PHONE]** on the base unit.

#### \*1 KX-TG7731 series: page 3

- You can only switch from the base unit to your headset. Turn on the headset referring to your headset operating instructions.

---

### Call sharing between your headset and the handset

#### Important:

- To activate this feature, you should set call sharing mode to on beforehand (page 38).
- **While the headset is on a landline call:**  
To join the conversation with your headset, turn on the headset referring to your headset operating instructions.
- **While your headset is on a landline call:**  
To join the conversation with the handset, press **[↶]**.

---

### Adjusting your headset receiver volume

#### Base unit

Press **[+]** or **[-]** repeatedly while using your headset.



## Answering system for landline

The answering system can answer and record calls for you when you are unavailable to answer the phone.

You can also set the unit to play a greeting message but not to record caller messages by selecting “**Greeting only**” as the recording time setting (page 53).

### Important:

- Only 1 person can access the answering system (listen to messages, record a greeting message, etc.) at a time.
- When callers leave messages, the unit records the day and time of each message. Make sure the date and time have been set correctly (page 17).
- When the cellular line only mode is set (page 20), the answering system cannot be used and any messages are not received.

## Memory capacity (including your greeting message)

The total recording capacity is about 18 minutes. A maximum of 64 messages can be recorded.

### Note:

- When message memory becomes full:
  - “**Messages full**” is shown on the handset display.
  - The ANSWER ON/OFF indicator on the base unit flashes rapidly if the answering system is turned on.
  - The message counter on the base unit flashes if the answering system is turned on.
  - If you use the pre-recorded greeting message, the unit automatically switches to another pre-recorded greeting message asking callers to call again later.
  - If you recorded your own greeting message, the same message is still announced to callers even though their messages are not recorded.

## Turning the answering system on/off

### Base unit

Press **[ANSWER ON/OFF]** to turn on/off the answering system.

### Handset

- To turn on:**  
**[MENU]#327**  
**To turn off:**  
**[MENU]#328**
- [OFF]**

### Note for base unit and handset:

- When the answering system is turned on:
  - The ANSWER ON/OFF indicator on the base unit lights up.
  - The message counter on the base unit displays the total number of messages (old and new).

## Call screening

While a caller is leaving a message, you can listen to the call through the unit’s speaker.

### Handset

To adjust the speaker volume, press **[+]** or **[-]** repeatedly. You can answer the call by pressing **[📞]**. Call screening can be set for each handset. The default setting is “on”.

- [MENU]#310**
- [↕]**: Select the desired setting. →  
**[SAVE] → [OFF]**

### Base unit\*1

\*1 KX-TG7741 series: page 3

To adjust the speaker volume, press **[+]** or **[-]** repeatedly. You can answer the call by pressing **[SP-PHONE]**.

To turn off while screening a call, press **[-]** repeatedly until the sounds goes off.

- If you adjust the speaker volume while listening to messages or having a conversation, the speaker volume for call screening is turned on again.

## Greeting message

When the unit answers a call, a greeting message is played to callers.

You can use either:

- your own greeting message
- a pre-recorded greeting message

## Recording your greeting message

- 1 [MENU]#302
- 2 [↕]: “yes” → [SELECT]
- 3 After a beep sounds, hold the handset about 20 cm (8 inches) away and speak clearly into the microphone (2 minutes max.).
- 4 Press [STOP] to stop recording.
- 5 [OFF]

## Using a pre-recorded greeting message

The unit provides 2 pre-recorded greeting messages:

- If you erase or do not record your own greeting message, the unit plays a pre-recorded greeting asking callers to leave a message.
- If the message recording time (page 53) is set to “**Greeting only**”, callers’ messages are not recorded and the unit plays a different pre-recorded greeting message asking callers to call again.

## Resetting to a pre-recorded greeting message

If you want to use a pre-recorded greeting message once you record your own greeting message, you need to erase your own greeting message.

- 1 [MENU]#304
- 2 [YES] → [OFF]

## Playing back the greeting message

- 1 [MENU]#303
- 2 To exit, press [OFF].

## Listening to messages using the base unit

When new messages have been recorded, [▶] on the base unit flashes.

Press [▶] (PLAY).

- If new messages have been recorded, the base unit plays back new messages.
- If there are no new messages, the base unit plays back all messages.

## Operating the answering system during playback

Key	Operation
[+] or [-]	Adjust the speaker volume
[◀◀]	Repeat message*1
[▶▶]	Skip message
[■] (STOP)	Stop playback
[ERASE]	Erase currently playing message

\*1 If pressed within the first 5 seconds of a message, the previous message is played.

## Erasing all messages

Press [ERASE] 2 times while the unit is not in use.

## Listening to messages using the handset

When new messages have been recorded: – “**New message**” is displayed.

- The message indicator on the handset flashes slowly if the message alert feature is turned on (page 53).

## 1 To listen to new messages:

**[MENU]#323**

To listen to all messages:

**[MENU]#324**

## 2 When finished, press **[OFF]**.

### Note:

- To switch to the receiver, press **[↶]**.

## Operating the answering system

**[MENU] → [↕]: "Answering device" → [SELECT]**

Key	Operation
<b>[+] or [-]</b>	Adjust the receiver/speaker volume (during playback)
<b>[1] or [↶]</b>	Repeat message (during playback) <sup>1</sup>
<b>[2] or [↷]</b>	Skip message (during playback)
<b>[3]</b>	Enter the "Settings" menu
<b>[4]</b>	Play new messages
<b>[5]</b>	Play all messages
<b>[6]</b>	Play greeting message
<b>[7][6]</b>	Record greeting message
<b>[8]</b>	Turn answering system on
<b>[PAUSE]</b>	Pause message <sup>2</sup>
<b>[9] or [STOP]</b>	Stop recording Stop playback
<b>[0]</b>	Turn answering system off
<b>[*][4]<sup>3</sup></b>	Erase currently playing message
<b>[*][5]</b>	Erase all messages
<b>[*][6]</b>	Reset to a pre-recorded greeting message

<sup>\*1</sup> If pressed within the first 5 seconds of a message, the previous message is played.

<sup>\*2</sup> To resume playback:

**[↕]: "Playback" → [SELECT]**

<sup>\*3</sup> You can also erase as follows:

**[ERASE] → [↕]: "Yes" → [SELECT]**

## Calling back (Caller ID subscribers only)

If caller information is received for the call, you can call the caller back while listening to a message.

- 1 Press **[PAUSE]** during playback.
- 2 **[↕]: "Call back" → [SELECT]**

## Editing the number before calling back

- 1 Press **[PAUSE]** during playback.
- 2 **[↕]: "Edit & Call" → [SELECT]**
- 3 Press **[EDIT]** repeatedly until the phone number is shown in the desired format (page 44). → **[↶]**
  - To call back using a cellular line, continue from step 2, "Making cellular calls", page 22.

## Erasing all messages

- 1 **[MENU]#325**
- 2 **[↕]: "Yes" → [SELECT] → [OFF]**

## Remote operation

Using a touch-tone phone, you can call your phone number from outside and access the unit to listen to messages or change answering system settings. The unit's voice guidance prompts you to press certain dial keys to perform different operations.

## Remote access code

A 3-digit remote access code must be entered when operating the answering system remotely. This code prevents unauthorized parties from listening to your messages remotely. The default setting is "111".

## Important:

- To prevent unauthorized access to this product, we recommend that you regularly change the remote code.

1 [MENU] [#] 3 0 6

2 Enter the desired 3-digit remote access code.

3 [SAVE] → [OFF]

## Deactivating remote operation

Press [X] in step 2 on "Remote access code", page 51.

- The entered remote access code is deleted.

## Using the answering system remotely

- Dial your landline phone number from a touch-tone phone.
- After the greeting message starts, enter your remote access code.
- Follow the voice guidance prompts as necessary or control the unit using remote commands (page 52).
- When finished, hang up.

## Voice guidance

### ■ When the English voice guidance is selected

During remote operation, the unit's voice guidance starts and prompts you to press [1] to perform a specific operation, or press [2] to listen to more available operations.

### ■ When the Spanish voice guidance is selected

To start the voice guidance, press [9]. The voice guidance announces the available remote commands (page 52).

### Note:

- If you do not press any dial keys within 10 seconds after a voice guidance prompt, the unit disconnects your call.

## Remote commands

You can press dial keys to access certain answering system functions without waiting for the voice guidance to prompt you.

Key	Operation
[1]	Repeat message (during playback)*1
[2]	Skip message (during playback)
[4]	Play new messages
[5]	Play all messages
[9]	Stop playback*2 Start voice guidance*3
[0]	Turn answering system off
[X] [4]	Erase currently playing message
[X] [5]	Erase all messages
[X] [#]	End remote operation (or hang up)

\*1 If pressed within the first 5 seconds of a message, the previous message is played.

\*2 For English voice guidance only

\*3 For Spanish voice guidance only

## Turning on the answering system remotely

If the answering system is off, you can turn it on remotely.

- Dial your phone number from a touch-tone phone.
- Let the phone ring 15 times.
  - A long beep is heard.
- Enter your remote access code within 10 seconds after the long beep.
  - The greeting message is played back.
  - You can either hang up, or enter your remote access code again and begin remote operation (page 51).

## Answering system settings

### Number of rings before the unit answers a call

You can change the number of times the phone rings “**Ring count**” before the unit answers calls. You can select 2 to 7 rings, or “**Toll saver**”.

The default setting is “**4 rings**”.

“**Toll saver**”: The unit’s answering system answers at the end of the 2nd ring when new messages have been recorded, or at the end of the 5th ring when there are no new messages. If you call your phone from outside to listen to new messages (page 51), you know that there are no new messages when the phone rings for the 3rd time. You can then hang up without being charged for the call.

1 **[MENU]#211**

2 **[↕]**: Select the desired setting. →  
**[SAVE] → [OFF]**

### For voice mail service subscribers

If you subscribe to a flat-rate service package that includes Caller ID, call waiting, voice mail, and unlimited local/regional/long distance calls, please note the following:

- To use the voice mail service provided by your service provider/telephone company rather than the unit’s answering system, turn off the answering system (page 49).
- To use this unit’s answering system rather than the voice mail service provided by your service provider/telephone company, please contact your service provider/telephone company to deactivate your voice mail service.

If your service provider/telephone company cannot do this:

- Set this unit’s “**Ring count**” setting so that this unit’s answering system answers calls before the voice mail service of your service provider/telephone company does. It is necessary to check the number of rings required to activate the voice mail service provided

by your service provider/telephone company before changing this setting.

- Change the number of rings of the voice mail service so that the answering system can answer the call first. To do so, contact your service provider/telephone company.

### Caller’s recording time

You can change the maximum message recording time allowed for each caller. The default setting is “**3 min**”.

1 **[MENU]#305**

2 **[↕]**: Select the desired setting. →  
**[SAVE] → [OFF]**

### Selecting “Greeting only”

You can select “**Greeting only**” which sets the unit to announce a greeting message to callers but not record messages.

Select “**Greeting only**” in step 2 on “**Caller’s recording time**”, page 53.

#### Note:

- When you select “**Greeting only**”:
  - If you do not record your own message, the unit will play the pre-recorded greeting-only message asking callers to call again later.
  - If you use your own message, record the greeting-only message asking callers to call again later (page 50).

### Message alert

You can select whether or not the message indicator on the handset flashes slowly when new messages are recorded. The default setting is “**On**”.

#### Important:

- If you stored the voice mail access number (page 55), the message indicator also flashes for newly recorded voice mail messages from the landline (page 56).

1 **[MENU]#340**

2 **[↕]**: Select the desired setting. →  
**[SAVE] → [OFF]**

## ***Answering System for Landline***

---

### **Note:**

- While message alert is on, battery operating time is shortened (page 12).

## Voice mail service for landline

Voice mail is an automatic answering service offered by your service provider/telephone company. After you subscribe to this service, your service provider/telephone company's voice mail system answers calls for you when you are unavailable to answer the phone or when your line is busy. Messages are recorded by your service provider/telephone company, not your telephone. Please contact your service provider/telephone company for details of this service.

### Important:

- To use the voice mail service provided by your service provider/telephone company rather than the unit's answering system, turn off the answering system (page 49). For details, see page 53.
- You need to store the voice mail access number to activate the message alert feature (page 53) for voice mail service.

## Storing the voice mail (VM) access number

In order to listen to your voice mail messages, you must dial your service provider/telephone company's voice mail access number. Once you have stored your voice mail access number, you can dial it automatically (page 56).

- 1 **[MENU]** **#** **3** **3** **1**
- 2 Enter your access number (24 digits max.). → **[SAVE]** → **[OFF]**

### Note:

- When storing your voice mail access number and your mailbox password, press **[PAUSE]** to add pauses (page 22) between the access number and the password as necessary. Contact your service provider/telephone company for the required pause time.

### Example:

1-222-333-4444	PPPP	8888
VM access	Pauses	Password
number		

## To erase the voice mail access number

- 1 **[MENU]** **#** **3** **3** **1**
- 2 Press and hold **[CLEAR]** until all digits are erased. → **[SAVE]** → **[OFF]**

## Voice mail (VM) tone detection

### Handset / Base unit\*1

\*1 KX-TG7741 series: page 3

Your service provider/telephone company sends special signals (sometimes called "voice mail tones" or "stutter tones") to the unit to let you know you have new voice mail messages. If you hear a series of dial tones followed by a continuous dial tone after you press **[MUTE]** on the handset or press **[SP-PHONE]** on the base unit, you have new voice mail messages. Soon after you hang up a call or after the phone stops ringing, your unit checks the phone line to see if new voice mail messages have been recorded.

Turn this feature off when:

- You do not subscribe to voice mail service.
  - Your service provider/telephone company does not send voice mail tones.
  - Your phone is connected to a PBX.
- If you are not sure which setting is required, contact your service provider/telephone company.

## Turning VM tone detection on/off

The default setting is "on".

- 1 **[MENU]** **#** **3** **3** **2**
- 2 **[↑]**: Select the desired setting. → **[SAVE]** → **[OFF]**

### Listening to voice mail messages

The unit lets you know that you have new voice mail messages in the following ways:

- “**New Voice Mail**” is displayed on the handset if message indication service is available.
- The message indicator on the handset flashes slowly if the message alert feature is turned on (“Message alert”, page 53).

#### Handset

- 1** **[MENU]#330**
  - The speakerphone turns on.
- 2** Follow the pre-recorded instructions.
- 3** When finished, press **[OFF]**.

#### Note:

- If the handset still indicate there are new messages even after you have listened to all new messages, turn it off by pressing and holding **[#]** until the handset beeps.

#### Base unit\*1

\*1 KX-TG7741 series: page 3

To listen to voice mail messages, you have to dial your voice mail access number manually.



## Intercom

Intercom calls can be made:

- between handsets
  - between a handset and the base unit\*<sup>1</sup>
- \*<sup>1</sup> KX-TG7741 series: page 3

### Note:

- When paging unit(s), the paged unit(s) beeps for 1 minute.
- If you receive an outside call while talking on the intercom, you hear 2 tones.
  - To answer the call with the handset, press **[OFF]**, then press **[↶]**.
  - To answer the call with the base unit, press **[SP-PHONE]** 2 times.\*<sup>1</sup>

\*<sup>1</sup> KX-TG7741 series: page 3

## Making an intercom call

### Handset

- 1 **[MENU]** → **[INT]**
- 2 **[↕]**: Select the desired unit. → **[SELECT]**
  - To stop paging, press **[OFF]**.
- 3 When you finish talking, press **[OFF]**.

### Base unit\*<sup>1</sup>

\*<sup>1</sup> KX-TG7741 series: page 3

- 1 Press **[INTERCOM]**.
  - To page a specific handset, enter the handset number.
  - To page all handsets, press **[0]** or wait for a few seconds.
  - To stop paging, press **[INTERCOM]**.
- 2 When you finish talking, press **[INTERCOM]**.

## Answering an intercom call

### Handset

- 1 Press **[↶]** to answer the page.
- 2 When you finish talking, press **[OFF]**.

### Base unit\*<sup>1</sup>

\*<sup>1</sup> KX-TG7741 series: page 3

- 1 Press **[INTERCOM]** to answer the page.
- 2 When you finish talking, press **[INTERCOM]**.

## Handset locator

You can locate a misplaced handset by paging it.

- 1 **Base unit:**  
Press **[LOCATOR]**.
  - All registered handsets beep for 1 minute.
- 2 To stop paging:  
**Base unit:**  
Press **[LOCATOR]**.  
**Handset:**  
■ **KX-TG7731 series: page 3**  
Press **[OFF]**.  
■ **KX-TG7741 series: page 3**  
Press **[↶]**, then press **[OFF]**.

### Transferring calls, conference calls

Outside calls can be transferred or a conference call with an outside party can be made:

- between 2 handsets
- between a handset and the base unit\*1

\*1 KX-TG7741 series: page 3

#### Handset

- 1 During an outside call, press **[INT]** to put the call on hold.
- 2 **[↕]**: Select the desired unit. → **[SELECT]**
- 3 Wait for the paged party to answer.
  - If the paged party does not answer, press **[↶]** to return to the outside call.
- 4 **To complete the transfer:**  
Press **[OFF]**.
  - The outside call is being routed to the destination unit.

**To establish a conference call:**

**[MENU]** → **[↕]**: "Conference" → **[SELECT]**

- To leave the conference, press **[OFF]**. The other 2 parties can continue the conversation.
- To put the outside call on hold:  
**[MENU]** → **[↕]**: "Hold" → **[SELECT]**  
To resume the conference: **[MENU]** → **[↕]**: "Conference" → **[SELECT]**

#### Base unit\*1

\*1 KX-TG7741 series: page 3

- 1 During an outside call, press **[INTERCOM]**.
  - To page a specific handset, enter the handset number.
  - To page all handsets, press **[0]** or wait for a few seconds.
- 2 Wait for the paged party to answer.
  - If paged party does not answer, press **[INTERCOM]** to return to the outside call.
- 3 **To complete the transfer:**  
Press **[SP-PHONE]**.

- The outside call is being routed to the handset.

**To establish a conference call:**

Press **[CONF]**.

- To leave the conference, press **[SP-PHONE]**. The other 2 parties can continue the conversation.
- To put the outside call on hold, press **[HOLD]**. To resume the conference, press **[CONF]**.

### Answering a transferred call

#### Handset

Press **[↶]** to answer the page.

#### Base unit\*1

\*1 KX-TG7741 series: page 3

Press **[SP-PHONE]** to answer the page.

## Wall mounting

### Note:

- Make sure that the wall and the fixing method are strong enough to support the weight of the unit.

### Base unit

- 1 Thread the AC adaptor cord and telephone line cord through the hole in the wall mounting adaptor in the direction of the arrow.

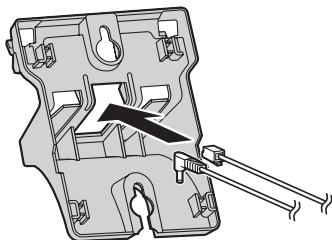

- 2 Tuck the telephone line cord inside the wall mounting adaptor (1). Connect the AC adaptor cord and telephone line cord (2).

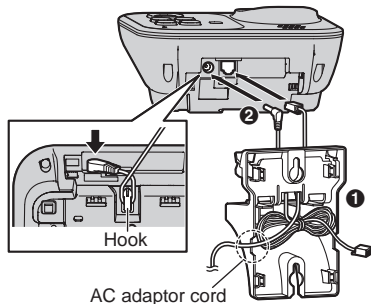

- 3 Insert the hooks on the wall mounting adaptor into holes A and B on the base unit.

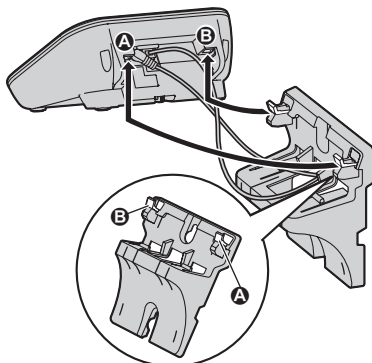

- 4 Adjust the adaptor to hold the base unit, then push it in the direction of the arrow until it clicks into place.

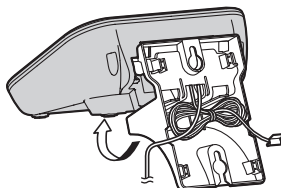
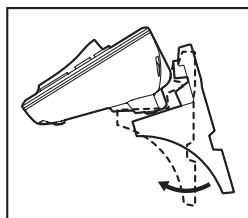

## Useful Information

- 5 Mount the unit on a wall then slide down to secure in place.

AC adaptor cord

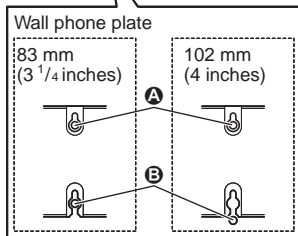
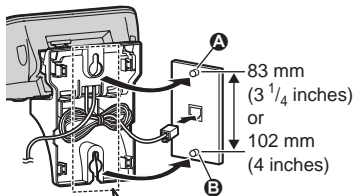
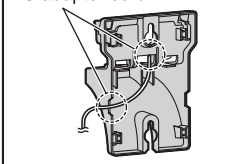

## To remove the wall mounting adaptor

While pushing down the release levers (1), remove the adaptor (2).

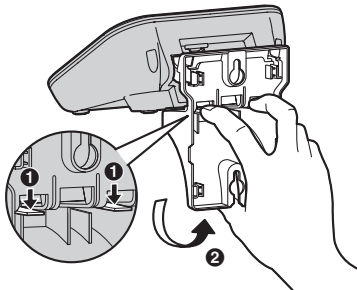

## Charger

Drive the screws (not supplied) into the wall.

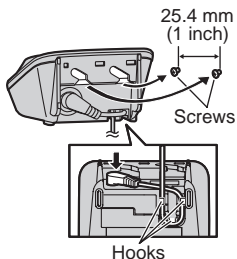

## Error messages

Display message	Cause/solution
Base no power or No link. Re-connect base AC adaptor.	<ul style="list-style-type: none"> <li>● The handset has lost communication with the base unit. Move closer to the base unit and try again.</li> <li>● Unplug the base unit's AC adaptor to reset the unit. Reconnect the adaptor and try again.</li> <li>● The handset's registration may have been canceled. Re-register the handset (page 42).</li> </ul>
Busy	<ul style="list-style-type: none"> <li>● No cellular phone is registered to the base unit. Register a cellular phone (page 18).</li> <li>● The called unit is in use.</li> <li>● Other units are in use and the system is busy. Try again later.</li> <li>● The handset you are using is too far from the base unit. Move closer and try again.</li> </ul>
Call phone company for your access #	<ul style="list-style-type: none"> <li>● You have not stored the voice mail access number. Store the number (page 55).</li> </ul>
Check tel line	<ul style="list-style-type: none"> <li>● The supplied telephone line cord has not been connected yet or not connected properly. Check the connections (page 11).</li> <li>● If you do not connect the telephone line cord and use only cellular lines, set the cellular line only mode (page 20).</li> </ul>
Error!!	<ul style="list-style-type: none"> <li>● Recording was too short. Try again.</li> <li>● Someone is using a cellular line or headset. Try again later.</li> <li>● The phonebook copy is incomplete (page 46). The cellular phone is disconnected from the base unit. Make sure that other Bluetooth devices are not connected to the cellular phone, and try again.</li> </ul>
Failed	<ul style="list-style-type: none"> <li>● Although the unit tried to connect to the cellular phone or headset, the connection has been failed.             <ul style="list-style-type: none"> <li>– Someone is using a cellular line or headset. Try again later.</li> <li>– Make sure that the cellular phone or headset is not connected to other Bluetooth devices.</li> </ul> </li> </ul>
Invalid	<ul style="list-style-type: none"> <li>● There is no handset registered to the base unit matching the handset number you entered.</li> <li>● The handset is not registered to the base unit. Register the handset (page 42).</li> </ul>
Requires subscription to Caller ID.	<ul style="list-style-type: none"> <li>● You must subscribe to a Caller ID service. Once you receive caller information after subscribing to a Caller ID service, this message will not be displayed.</li> </ul>

## Useful Information

Display message	Cause/solution
Use rechargeable battery.	<ul style="list-style-type: none"><li>● A wrong type of battery such as Alkaline or Manganese was inserted. Use only the rechargeable Ni-MH batteries noted on page 5, 8.</li></ul>

## Troubleshooting

If you still have difficulties after following the instructions in this section, disconnect the base unit's AC adaptor, then reconnect the base unit's AC adaptor. Remove the batteries from the handset, and then insert the batteries into the handset again.

### General use

Problem	Cause/solution
The handset does not turn on even after installing charged batteries.	<ul style="list-style-type: none"><li>● Place the handset on the base unit or charger to turn on the handset.</li></ul>
The unit does not work.	<ul style="list-style-type: none"><li>● Make sure the batteries are installed correctly (page 11).</li><li>● Fully charge the batteries (page 12).</li><li>● Check the connections (page 11).</li><li>● Unplug the base unit's AC adaptor to reset the unit. Reconnect the adaptor and try again.</li><li>● The handset has not been registered to the base unit. Register the handset (page 42).</li></ul>
I cannot register a cellular phone to the base unit.	<ul style="list-style-type: none"><li>● Depending on the compatibility of the cellular phone, you may not be able to register it to the base unit. Confirm that your cellular phone supports the hands-free profile (HFP) specification.</li><li>● Confirm that the Bluetooth feature of your cellular phone is turned on. You may need to turn this feature on depending on your cellular phone.</li><li>● The Bluetooth technology on your cellular phone may not be functioning normally. Turn off and on your cellular phone.</li><li>● If your cellular phone is already connected to another Bluetooth device such as a Bluetooth headset, turn it off or disconnect it from your cellular phone.</li><li>● Some cellular phones may require you to enter the base unit PIN to register. Confirm that you entered the correct PIN.</li></ul>

Problem	Cause/solution
I cannot connect a cellular phone to the base unit.	<ul style="list-style-type: none"> <li>● Confirm that your cellular phone is turned on.</li> <li>● Confirm that your cellular phone is within base unit range (page 15).</li> <li>● Depending on the state of the wireless environment, such as the presence of any electrical interference, there may be a delay even if the auto connection feature is turned on. You can connect to the base unit manually (page 20).</li> <li>● The cellular phone has not been registered to the base unit. Register the cellular phone (page 18).</li> </ul>
I cannot hear a dial tone.	<ul style="list-style-type: none"> <li>● Make sure the base unit's AC adaptor is connected properly (page 11).</li> <li>● Make sure that the CELL 1 or CELL 2 indicator lights green (page 16).</li> <li>● Make sure the telephone line cord is connected properly (page 11).</li> <li>● Disconnect the base unit from the telephone line and connect the line to a known working telephone. If the working telephone operates properly, contact our service personnel to have the unit repaired. If the working telephone does not operate properly, contact your service provider/telephone company.</li> </ul>
The indicator on the handset flashes slowly.	<ul style="list-style-type: none"> <li>● New messages have been recorded. Listen to the new messages (page 50).</li> <li>● New voice mail messages have been recorded. Listen to the new voice mail messages (page 56).</li> </ul>
The receiver volume is changed to level 4 (default), even though I set it to level 5 (maximum level).	<ul style="list-style-type: none"> <li>● The receiver volume returns to level 4 after you hang up. Press <b>[+]</b> or <b>[-]</b> to adjust the volume every time or as needed.</li> </ul>



### Programmable settings

Problem	Cause/solution
The display is in a language I cannot read.	<ul style="list-style-type: none"> <li>● Change the display language (page 17).</li> </ul>
I cannot register a handset to a base unit.	<ul style="list-style-type: none"> <li>● The maximum number of handsets (6) is already registered to the base unit. Cancel unused handset registrations from the base unit (page 42).</li> </ul>

### Battery recharge

Problem	Cause/solution
The handset beeps and/or  flashes.	<ul style="list-style-type: none"> <li>● Battery charge is low. Fully charge the batteries (page 12).</li> </ul>

## Useful Information

Problem	Cause/solution
I fully charged the batteries, but –  still flashes, –  is displayed, or – the operating time seems to be shorter.	<ul style="list-style-type: none"><li>● Clean the battery ends (+, -) and the charge contacts with a dry cloth and charge again.</li><li>● It is time to replace the batteries (page 11).</li></ul>

## Making/answering calls, intercom

Problem	Cause/solution
 is displayed.	<ul style="list-style-type: none"><li>● The handset is too far from the base unit. Move closer.</li><li>● The base unit's AC adaptor is not properly connected. Reconnect AC adaptor to the base unit.</li><li>● The handset is not registered to the base unit. Register it (page 42).</li></ul>
Noise is heard, sound cuts in and out.	<ul style="list-style-type: none"><li>● You are using the handset or base unit in an area with high electrical interference. Re-position the base unit and use the handset away from sources of interference.</li><li>● Move closer to the base unit.</li><li>● If you use a DSL/ADSL service, we recommend connecting a DSL/ADSL filter between the base unit and the telephone line jack. Contact your DSL/ADSL provider for details.</li></ul>
The handset or base unit does not ring.	<ul style="list-style-type: none"><li>● The ringer volume is turned off. Adjust the ringer volume (page 35, 37).</li><li>● When one handset is selected to ring for cellular calls, other units do not ring. To change the selection, see page 19.</li><li>● Silent mode is turned on for the handset. Turn it off (page 40).</li></ul>
I cannot make local calls with the handset or base unit using a cellular line.	<ul style="list-style-type: none"><li>● You need to add your area code when making cellular calls. Store your area code in order to automatically add it to the beginning of the 7-digit phone number when making cellular calls (page 21).</li></ul>
I cannot make or answer cellular calls with the handset or base unit.	<ul style="list-style-type: none"><li>● Depending on the cellular phone's compatibility, you may not be able to make or answer cellular calls even if the cellular phone is connected to the base unit.</li><li>● Make sure that the CELL 1 or CELL 2 indicator lights green and the cellular phone is connected to the base unit (page 20).</li><li>● If someone is talking on a cellular call or using the headset, you cannot use the cellular feature. There can be only one active Bluetooth connection at a time.</li><li>● The cellular phone is being used separately from your system.</li></ul>



Problem	Cause/solution
I can make and answer cellular calls but cannot hear a sound.	<ul style="list-style-type: none"> <li>The Bluetooth technology on your cellular phone may not be functioning normally. Turn off and on your cellular phone.</li> <li>Disconnect and reconnect the base unit AC adaptor and try again.</li> </ul>
I cannot switch cellular calls from the unit to the cellular phone.	<ul style="list-style-type: none"> <li>Your cellular phone may not support this feature. Refer to the operating instructions of your cellular phone.</li> </ul>
I cannot make a call using the landline.	<ul style="list-style-type: none"> <li>The dialing mode may be set incorrectly. Change the setting (page 17).</li> <li>The cellular line only mode is turned on. Turn it off (page 20).</li> </ul>
I cannot make long distance calls.	<ul style="list-style-type: none"> <li>Make sure that you have long distance service.</li> </ul>

### Caller ID/Talking Caller ID

Problem	Cause/solution
Caller information is not displayed.	<ul style="list-style-type: none"> <li>You must subscribe to Caller ID service. Contact your service provider/telephone company for details.</li> <li>If your unit is connected to any additional telephone equipment such as a Caller ID box or cordless telephone line jack, plug the unit directly into the wall jack.</li> <li>If you use a DSL/ADSL service, we recommend connecting a DSL/ADSL filter between the base unit and the telephone line jack. Contact your DSL/ADSL provider for details.</li> <li>The name display service for landline calls may not be available in some areas. Contact your service provider/telephone company for details.</li> <li>Other telephone equipment may be interfering with this unit. Disconnect the other equipment and try again.</li> </ul>
Caller information is displayed or announced late.	<ul style="list-style-type: none"> <li>Depending on your service provider/telephone company, the unit may display or announce the caller's information at the 2nd ring or later.</li> <li>Move closer to the base unit.</li> </ul>

## Useful Information

Problem	Cause/solution
Caller information is not announced.	<ul style="list-style-type: none"><li>● The handset or base unit's ringer volume is turned off. Adjust it (page 23, 28, 35, 37).</li><li>● When one handset is selected to ring for cellular calls, other units do not announce caller information. To change the selection, see page 19.</li><li>● The Talking Caller ID feature is turned off. Turn it on (page 37).</li><li>● The ring as cell mode is set to "On (without Talking CID)". To change the mode, see page 19.</li><li>● The number of rings for the answering system is set to "2 rings" or "Toll saver". Select a different setting (page 53).</li><li>● Your unit does not announce caller information if<ul style="list-style-type: none"><li>– the base unit or 2 or more handsets are on a call.</li><li>– a headset is in use.</li></ul></li></ul>
The caller list/incoming phone numbers are not edited automatically.	<ul style="list-style-type: none"><li>● The Caller ID number auto edit feature is turned off. Turn it on and try again (page 38).</li><li>● You need to call back the edited number to activate Caller ID number auto edit.</li></ul>
I cannot dial the phone number edited in the caller list.	<ul style="list-style-type: none"><li>● The phone number you dialed might have been edited incorrectly (for example, the long distance "1" or the area code is missing). Edit the phone number with another pattern (page 44).</li></ul>
Time on the unit has shifted.	<ul style="list-style-type: none"><li>● Incorrect time information from incoming Caller ID changes the time. Set the time adjustment to "Manual" (off) (page 36).</li></ul>
The 2nd caller's information is not displayed during an outside call.	<ul style="list-style-type: none"><li>● In order to use Caller ID, call waiting, or Call Waiting Caller ID (CWID), you must first contact your service provider/telephone company and subscribe to the desired service. After subscribing, you may need to contact your service provider/telephone company again to activate this specific service, even if you already subscribed to both Caller ID and Call Waiting with Caller ID services (CWID).</li></ul>

## Using Bluetooth devices

Problem	Cause/solution
I cannot copy phonebook entries from a cellular phone.	<ul style="list-style-type: none"> <li>● Confirm that the cellular phone supports Bluetooth wireless technology.</li> <li>● Confirm that the cellular phone supports the Phone Book Access Profile (PBAP) or Object Push Profile (OPP) specification.</li> <li>● If the cellular phone is already connected to another Bluetooth device such as a Bluetooth headset, turn it off or disconnect it from the cellular phone.</li> <li>● Someone is using a cellular line or headset. Try again later.</li> <li>● Turn the cellular phone off, then turn it on and try again.</li> <li>● If an entry is already stored in the unit's shared phonebook, the entry cannot be copied even by selecting another group.</li> </ul>
I cannot have a conversation using the headset.	<ul style="list-style-type: none"> <li>● Your Bluetooth headset is not registered. Register it (page 47).</li> <li>● Turn your headset off, then turn it on and try again.</li> </ul>
Noise is heard during a call on the headset.	<ul style="list-style-type: none"> <li>● A Bluetooth headset can communicate with the base unit within a range of approximately 10 m (33 feet). The connection may be subject to interference from obstructions such as walls or electronic devices. Move closer to the base unit.</li> </ul>
I cannot connect my headset to the base unit.	<ul style="list-style-type: none"> <li>● Confirm that your headset is turned on.</li> <li>● If your headset is already connected to another Bluetooth device such as your cellular phone, disconnect the headset from your cellular phone, then perform the connecting procedure from the base unit.</li> <li>● If someone is using a cellular line, you cannot connect the headset. There can be only one active Bluetooth connection at a time.</li> <li>● The headset has not been registered to the base unit. Register the headset (page 47).</li> </ul>
Some headset enhanced features are not available.	<ul style="list-style-type: none"> <li>● The base unit does not support enhanced features such as Last number redial or Call reject.</li> </ul>
An error tone is heard when I try to program the Bluetooth feature.	<ul style="list-style-type: none"> <li>● The Bluetooth feature cannot be accessed immediately after connecting the AC adaptor to the base unit. Wait a few seconds and try again.</li> <li>● The headset has not connected to the base unit yet, even though you performed the connecting procedure setting. Wait a few seconds and try again.</li> </ul>

### Answering system

Problem	Cause/solution
The unit does not record new messages.	<ul style="list-style-type: none"><li>• The answering system is turned off. Turn it on (page 49).</li><li>• The answering system does not answer or record calls from cellular lines.</li><li>• The message memory is full. Erase unnecessary messages (page 50).</li><li>• The recording time is set to “<b>Greeting only</b>”. Change the setting (page 53).</li><li>• If you subscribe to a voice mail service, messages are recorded by your service provider/telephone company, not your telephone. Change the unit’s number of rings setting or contact your service provider/telephone company (page 53).</li><li>• The answering system will not answer incoming calls while:<ul style="list-style-type: none"><li>– the base unit or 2 or more handsets are on a cellular call or an intercom call.</li><li>– a headset is in use.</li></ul>Caller information is recorded in the caller list.</li></ul>
I cannot operate the answering system remotely.	<ul style="list-style-type: none"><li>• The remote access code is not set. Set the remote access code (page 51).</li><li>• You are entering the wrong remote access code. If you have forgotten your remote access code, enter the remote access code setting to check your current code (page 51).</li><li>• The answering system is turned off. Turn it on (page 52).</li><li>• You cannot operate the answering system when calling a cellular phone registered to the base unit.</li></ul>

### Bluetooth PIN

Problem	Cause/solution
I cannot remember the PIN.	<ul style="list-style-type: none"><li>• Change the PIN using the following method.<ol style="list-style-type: none"><li><b>1</b> [MENU]# [6] [1] [9]</li><li><b>2</b> [X] [7] [0] [0] [0]</li><li><b>3</b> Enter the new 4-digit PIN. → [OK]</li><li><b>4</b> Enter the new 4-digit PIN again. → [SAVE] → [OFF]</li></ol></li></ul>

**Liquid damage**

Problem	Cause/solution
Liquid or other form of moisture has entered the handset/base unit.	<ul style="list-style-type: none"><li>● Disconnect the AC adaptor and telephone line cord from the base unit. Remove the batteries from the handset and leave to dry for at least 3 days. After the handset/base unit are completely dry, reconnect the AC adaptor and telephone line cord. Insert the batteries and charge fully before use. If the unit does not work properly, contact an authorized service center.</li></ul>

**Caution:**

- To avoid permanent damage, do not use a microwave oven to speed up the drying process.

### FCC and other information

This equipment complies with Part 68 of the FCC rules and the requirements adopted by the ACTA. On the bottom of this equipment is a label that contains, among other information, a product identifier in the format US:ACJ-----.

If requested, this number must be provided to the telephone company.

- Registration No. .... (found on the bottom of the unit)
- Ringer Equivalence No. (REN) .....0.1B

A plug and jack used to connect this equipment to the premises wiring and telephone network must comply with the applicable FCC Part 68 rules and requirements adopted by the ACTA. A compliant telephone cord and modular plug is provided with the product. It is designed to be connected to a compatible modular jack that is also compliant.

The REN is used to determine the number of devices that may be connected to a telephone line. Excessive RENs on a telephone line may result in the devices not ringing in response to an incoming call. In most but not all areas, the sum of RENs should not exceed five (5.0). To be certain of the number of devices that may be connected to a line, as determined by the total RENs, contact the local telephone company. For products approved after July 23, 2001, the REN for the product is part of the product identifier that has the format US:AAAEQ##TXXXX. The digits represented by ## are the REN without a decimal point (e.g., 03 is a REN of 0.3).

If this equipment causes harm to the telephone network, the telephone company will notify you in advance that temporary discontinuance of service may be required. But if advance notice isn't practical, the telephone company will notify the customer as soon as possible. Also, you will be

advised of your right to file a complaint with the FCC if you believe it is necessary.

The telephone company may make changes in its facilities, equipment, operations or procedures that could affect the operation of the equipment. If this happens the telephone company will provide advance notice in order for you to make necessary modifications to maintain uninterrupted service.

If trouble is experienced with this equipment, for repair or warranty information, please contact a Factory Service Center or other Authorized Servicer. If the equipment is causing harm to the telephone network, the telephone company may request that you disconnect the equipment until the problem is resolved.

Connection to party line service is subject to state tariffs. Contact the state public utility commission, public service commission or corporation commission for information.

If your home has specially wired alarm equipment connected to the telephone line, ensure the installation of this equipment does not disable your alarm equipment. If you have questions about what will disable alarm equipment, consult your telephone company or a qualified installer.

This equipment is hearing aid compatible as defined by the FCC in 47 CFR Section 68.316.

When you hold the phone to your ear, noise might be heard in your Hearing Aid. Some Hearing Aids are not adequately shielded from external RF (radio frequency) energy. If noise occurs, use an optional headset accessory or the speakerphone option (if applicable) when using this phone. Consult with your audiologist or Hearing Aid

manufacturer about the availability of Hearing Aids which provide adequate shielding to RF energy commonly emitted by digital devices.

### WHEN PROGRAMMING EMERGENCY NUMBERS AND(OR) MAKING TEST CALLS TO EMERGENCY NUMBERS:

- 1) Remain on the line and briefly explain to the dispatcher the reason for the call.
- 2) Perform such activities in the off-peak hours, such as early morning or late evenings.

This device complies with Part 15 of the FCC Rules. Operation is subject to the following two conditions:

(1) This device may not cause harmful interference, and (2) this device must accept any interference received, including interference that may cause undesired operation.

Privacy of communications may not be ensured when using this phone.

### CAUTION:

Any changes or modifications not expressly approved by the party responsible for compliance could void the user's authority to operate this device.

### NOTE:

This equipment has been tested and found to comply with the limits for a Class B digital device, pursuant to Part 15 of the FCC Rules. These limits are designed to provide reasonable protection against harmful interference in a residential installation. This equipment generates, uses, and can radiate radio frequency energy and, if not installed and used in accordance with the instructions, may cause harmful interference to radio communications. However, there is no guarantee that interference will not occur in a particular installation. If this equipment does cause harmful interference to radio or television reception, which can be determined by turning the equipment off and on, the user is

encouraged to try to correct the interference by one or more of the following measures:

- Reorient or relocate the receiving antenna.
- Increase the separation between the equipment and receiver.
- Connect the equipment into an outlet on a circuit different from that to which the receiver is connected.
- Consult the dealer or an experienced radio/TV technician for help.

Some cordless telephones operate at frequencies that may cause interference to nearby TVs and VCRs. To minimize or prevent such interference, the base of the cordless telephone should not be placed near or on top of a TV or VCR. If interference is experienced, move the cordless telephone further away from the TV or VCR. This will often reduce or eliminate interference.

### FCC RF Exposure Warning:

- This product complies with FCC radiation exposure limits set forth for an uncontrolled environment.
- To comply with FCC RF exposure requirements, the base unit must be installed and operated 20 cm (8 inches) or more between the product and all person's body (excluding extremities of hands, wrist and feet).
- This product may not be collocated or operated in conjunction with any other antenna or transmitter.
- The handset may be carried and operated with only the specific provided belt-clip. Other non-tested belt-clips or similar body-worn accessories may not comply and must be avoided.

### Notice

- FCC ID can be found inside the battery compartment or on the bottom of the units.

### Compliance with TIA-1083 standard:

Telephone handsets identified with this logo have reduced noise and interference when used with T-Coil equipped hearing aids and cochlear implants.





# Guía Rápida Española

## Instalación

### Unidad base

- Use solo el adaptador de corriente Panasonic PNLV226 incluido. "Clic"

Oprima firmemente el contacto.



#### Correcto

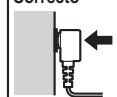

#### Incorrecto



Gancho

A la toma de corriente

A la toma de teléfono de línea única (RJ11C)

Filtro DSL/ADSL\*

"Clic"

\*Requiere un filtro DSL/ADSL (no incluido) si tiene este tipo de servicio.

### Auricular

- UTILICE SOLO baterías de Ni-MH tamaño AAA (R03).
- NO utilice baterías Alcalinas, de Manganeseo o de Ni-Cd.
- Compruebe que las polaridades son las correctas (+, -).



SOLO baterías Ni-MH recargables

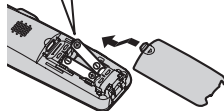

### Cargador

- Use solo el adaptador de corriente Panasonic PNLV226 incluido.

A la toma de corriente

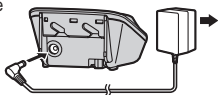

### CARGUE APROXIMADAMENTE DURANTE 7 HORAS

Confirme que aparezca "Cargando".

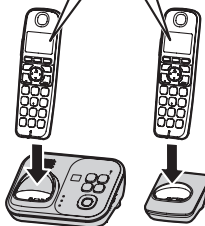

## Sugerencias de operación

### Teclas de función

El auricular incluye 3 teclas de función. Al oprimir una tecla de función, puede seleccionar la función que aparece directamente encima de ella en la pantalla.

[**☰**], [**MENU**], [**CEL.**] y otras funciones adicionales se asignan a las teclas de función. Preste atención a la pantalla para ver qué funciones están asignadas a las teclas de función durante la operación del auricular.

### Tecla de volumen

Oprima [**+**] o [**-**] repetidamente para ajustar el volumen del receptor o del altavoz mientras habla.

### Tecla navegadora

- [**▲**], [**▼**], [**◀**], o [**▶**]: Navegue por diversas listas y elementos.
- [**↶**] CID (identificador de llamadas): Vea la lista de personas que llamaron.
- [**↷**] REDIAL (Remarcación): Vea la lista de remarcación.

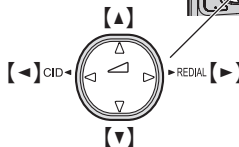
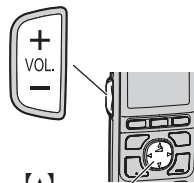
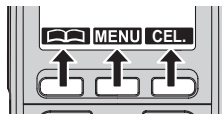

## Cambio de idiomas (predeterminado: "English") (Auricular)

Cuando instale las baterías por primera vez, es posible que aparezca "Date and time Press SELECT". Oprima [**OFF**] para salir.

### Idioma de la pantalla

[**MENU**] [**☰**][**1**][**0**] → [**+**]: "Español" → [**GUARDA**] → [**OFF**]

### Idioma de la guía de voz

[**MENU**] [**☰**][**1**][**2**] → [**+**]: "Español" → [**GUARDA**] → [**OFF**]

## Fecha y hora (Auricular)

**1** [**MENU**] [**☰**][**0**][**1**]

**2** Introduzca el día, mes y año actuales. → [**OK**]

**3** Introduzca la hora y minuto actuales (formato de reloj de 24 horas).

**4** [**GUARDA**] → [**OFF**]

## Cómo grabar el mensaje de saludo del contestador de llamadas para la línea terrestre (Auricular)

Si utiliza un mensaje de saludo pregrabado, no es necesario que grabe su propio mensaje de saludo.

**1** [**MENU**] [**☰**][**3**][**0**][**2**] → [**+**]: "sí" → [**SELEC.**]

**2** Después de que suene un pitido, sostenga el auricular a una distancia aproximada de 20 cm (8 pulgadas) y hable con claridad en el micrófono (máx. de 2 minutos).

**3** Oprima [**ALTO**] para dejar de grabar. → [**OFF**]

## Enlace a celular

Puede usar la unidad para hacer o contestar llamadas usando una línea de teléfono celular. Sus teléfonos celulares deben tener tecnología inalámbrica Bluetooth® compatible con este producto. Para obtener más detalles, visite nuestro sitio web: <http://www.panasonic.com/link2cell>

- Coloque su teléfono celular cerca de la unidad base. Si su teléfono celular está demasiado cerca de la unidad base durante la llamada celular, es posible que escuche ruido. Para un mejor funcionamiento, le recomendamos que coloque su teléfono celular de 0.6 m a 3 m (2 pies a 10 pies) de la unidad base.



## Cómo registrar un teléfono celular con Bluetooth

### 1 Auricular:

Para CELL 1: **[MENU] #6241**

Para CELL 2: **[MENU] #6242**

- Después de que el indicador de CELL 1 o CELL 2 comience a parpadear en rojo en la unidad base, el resto del procedimiento debe completarse en menos de 5 minutos.

### 2 Su teléfono celular:

Mientras el indicador de CELL 1 o CELL 2 está parpadeando en rojo, siga las instrucciones de su teléfono celular para entrar al modo de registro.

- Dependiendo de su teléfono celular, es posible que le pida que introduzca el NIP de la unidad base (predeterminado: "0000").

### 3 Auricular:

Espere a que se emita un pitido largo.

- Es posible que tarde más de 10 segundos en completar el registro.
- Cuando el indicador de CELL 1 o CELL 2 se ilumina en verde, esto significa que el teléfono celular está conectado a la unidad base. Ya está listo para hacer llamadas regulares de celular.

### 4 Para seleccionar qué unidad recibe llamadas para la línea celular (predeterminado: "Todo"):

**[OK] → [↔]:** Seleccione el auricular deseado o "Todo". → **[GUARDA]**

- Si no se requiere, vaya al paso 5.

### 5 [OFF]

#### Nota:

- Asegúrese de que su teléfono celular está configurado para conectar este producto automáticamente. Consulte las instrucciones de operación de su teléfono celular.

## Marcas registradas



- La marca denominativa y los logotipos de Bluetooth® son propiedad de Bluetooth SIG, Inc. y cualquier uso de dichas marcas por parte de Panasonic Corporation se hace bajo licencia. Todas las demás marcas comerciales que se identifican en el presente pertenecen a sus respectivos propietarios.

## Enlace a celular

Unidad base: Indicadores CELL 1/CELL 2

Estado	Significado
Verde (encendido)	Un teléfono celular está conectado. Listo para hacer o recibir llamadas celulares.
Verde (parpadea)	La línea del celular se está usando. Las entradas del directorio telefónico se están copiando desde un teléfono celular.
Verde (parpadea rápidamente)	Se está recibiendo una llamada de celular.
Ámbar (encendido)	No hay un teléfono celular conectado a la unidad base.
Ámbar (parpadea rápidamente)	La unidad base está buscando el teléfono celular registrado.
Rojo (parpadea)	Una llamada de celular se pone en espera.
Luz apagada	No hay un teléfono celular registrado en la unidad base.

### Auricular: enlace a elementos de la pantalla del celular

	Se está usando una línea de celular. <ul style="list-style-type: none"> <li>• Cuando parpadea: La llamada de celular se pone en espera.</li> <li>• Cuando parpadea rápidamente: Se está recibiendo una llamada de celular.</li> </ul>
 <sup>1</sup> <sub>2</sub>	Un teléfono celular está conectado. <sup>*1</sup> Listo para hacer o recibir llamadas celulares. <ul style="list-style-type: none"> <li>• Cuando está apagado: No hay un teléfono celular conectado a la unidad base.</li> </ul> <sup>*1</sup> La línea o líneas celulares correspondientes se indican enseguida del elemento.
	Está recibiendo una llamada de celular en esa línea.

### Cómo conectar o desconectar el teléfono celular

#### Conexión automática al teléfono celular

La unidad se conecta al teléfono celular a intervalos regulares si se pierde la conexión. Consulte las instrucciones de operación para cambiar el intervalo (predeterminado: "1 min").

- Cuando está usando una línea celular o un audífono con Bluetooth, la unidad base pierde la conexión de otros dispositivos con Bluetooth (teléfono celular o audífono). Para restablecer la conexión a los teléfonos celulares automáticamente, deje encendida la conexión automática.

#### Cómo conectar o desconectar manualmente el teléfono celular

Cuando haga o conteste llamadas con su teléfono celular, le recomendamos que lo desconecte de la unidad base; de lo contrario, es posible que no escuche el audio que reciba en su teléfono celular.

También puede reconectar manualmente el teléfono celular a la unidad base sin esperar a que la función de conexión automática reanude la conexión.

#### 1 Para conectarlo o desconectarlo:

Para CELL 1: **[MENU] #6251** (suena un pitido largo.)

Para CELL 2: **[MENU] #6252** (suena un pitido largo.)

#### 2 [OFF]

## Enlace a celular

### Modo exclusivo para la línea celular (si no utiliza la línea terrestre)

Si no utiliza la línea terrestre, configure el modo exclusivo para la línea celular para usar esta unidad en forma más conveniente.

**1** [MENU] #157

**2** Para encenderlo: [↕]: "Encendido" → [SELEC.] → [↕]: "sí" → [SELEC.]

Para apagarlo: [↕]: "Apagado" → [SELEC.]

## Operaciones básicas

### Cómo hacer y contestar llamadas (Auricular)

Para hacer llamadas de celular	<p><b>1</b> Marque el número telefónico. → [CEL.]</p> <ul style="list-style-type: none"> <li>• Cuando el modo exclusivo para la línea celular está configurado, también puede oprimir [↶]/[↷] en lugar de [CEL.].</li> <li>• Cuando solo hay 1 teléfono celular registrado, la unidad comienza a marcar.</li> </ul> <p><b>2</b> Cuando hay 2 teléfonos celulares registrados: [↕]: Seleccione el teléfono celular deseado. → [SELEC.]</p>
Para hacer llamadas por la línea terrestre	Marque el número telefónico. → [↶]/[↷]
Para contestar llamadas	[↶]/[↷]
Para colgar	[OFF]
Para ajustar el volumen del receptor o del altavoz	Oprima [+] o [-] repetidamente mientras habla.
Cómo hacer una llamada usando la lista de remarcación	<p><b>1</b> [▶] REDIAL → [↕]: Seleccione el número telefónico deseado.</p> <p><b>2</b> Para hacer una llamada celular: Cuando solo hay 1 teléfono celular registrado: [CEL.] o Cuando hay 2 teléfonos celulares registrados: [CEL.] → [↕]: Seleccione el teléfono celular deseado. → [SELEC.]</p> <p>Para hacer una llamada terrestre: [↶]</p>

### Cómo hacer y contestar llamadas (Unidad base: Serie KX-TG7741)

Para hacer llamadas de celular	<p>[CELL 1]/[CELL 2] → Marque el número telefónico.</p> <ul style="list-style-type: none"> <li>• Cuando el modo exclusivo para la línea celular está configurado, también puede oprimir [SP-PHONE] en lugar de [CELL 1]/[CELL 2].</li> </ul>
Para hacer llamadas por la línea terrestre	[SP-PHONE] → Marque el número telefónico.
Para contestar llamadas	[SP-PHONE]
Para colgar	[SP-PHONE]
Para ajustar el volumen del altavoz	Oprima [+] o [-] repetidamente mientras habla.

## Operaciones básicas

### Cómo hacer y contestar llamadas (Unidad base: Serie KX-TG7741)

Remarcación del último número marcado	<b>1</b> Para hacer una llamada celular: [CELL 1]/[CELL 2] Para hacer una llamada terrestre: [SP-PHONE] <b>2</b> [REDIAL]
---------------------------------------	---

### Para ajustar el volumen del timbre (Auricular)

Para ajustar el volumen del timbre del auricular (línea de celular)	<b>1</b> Para CELL 1: [MENU] #6281 Para CELL 2: [MENU] #6282 <b>2</b> [↕]: Seleccione el volumen deseado. → [GUARDA] → [OFF]
---	--

Para ajustar el volumen del timbre del auricular (línea terrestre)	<b>1</b> [MENU] #160 <b>2</b> [↕]: Seleccione el volumen deseado. → [GUARDA] → [OFF]
--	---

Para ajustar el volumen del timbre de la unidad base (línea celular)	<b>1</b> Para CELL 1: [MENU] #*6281 Para CELL 2: [MENU] #*6282 <b>2</b> [↕]: Seleccione el volumen deseado. → [GUARDA] → [OFF]
--	--

Para ajustar el volumen del timbre de la unidad base (línea terrestre)	<b>1</b> [MENU] #*160 <b>2</b> [↕]: Seleccione el volumen deseado. → [GUARDA] → [OFF]
--	--

### Directorio telefónico compartido (Auricular)

Para añadir entradas	<b>1</b> [☑] → [AÑAD.] <b>2</b> Introduzca el nombre de la persona (máx. 16 caracteres). → [OK] <b>3</b> Introduzca el número telefónico de la persona (máx. 24 dígitos). → [OK] <b>4</b> [↕]: Seleccione el grupo deseado. → [SELEC.] 2 veces → [OFF]
----------------------	---

Para hacer llamadas	<b>1</b> [☑] → [↕]: Seleccione la entrada deseada. <b>2</b> Para hacer una llamada celular: Cuando solo hay 1 teléfono celular registrado: [CEL.] o Cuando hay 2 teléfonos celulares registrados: [CEL.] → [↕]: Seleccione el teléfono celular deseado. → [SELEC.] Para hacer una llamada terrestre: [☑]
---------------------	---

### Contestador de llamadas de la línea terrestre (Unidad base)

Contestador encendido/apagado	Oprima [ANSWER ON/OFF] para encender y apagar el contestador de llamadas.
-------------------------------	---

Para escuchar mensajes	[▶] (PLAY)
------------------------	------------

### Contestador de llamadas de la línea terrestre (Auricular)

Para escuchar mensajes	Para escuchar mensajes nuevos: [MENU] #323 Para escuchar todos los mensajes: [MENU] #324
------------------------	---

## Cómo usar dispositivos Bluetooth

### Copiado de entradas del directorio telefónico desde un teléfono celular con Bluetooth (transferencia del directorio telefónico)

Puede copiar entradas del directorio telefónico desde los teléfonos celulares registrados o desde otros teléfonos celulares (no registrados) al directorio telefónico compartido de la unidad.

#### 1 Auricular: [MENU] #618

#### 2 Auricular:

**Para copiar desde teléfonos celulares registrados:**

[↕]: Seleccione el teléfono celular deseado. → [SELEC.]

- Los elementos copiados se almacenan en el grupo ("Cel. 1" o "Cel. 2") en el que está registrado el teléfono celular.

**Para copiar desde otros teléfonos celulares (no registrados):**

[↕]: "otro celular" → [SELEC.] → [↕]: Seleccione el grupo al que desea copiar. → [SELEC.]

#### 3 Cuando aparezca "Transf. datos del directorio del celular": Vaya al paso 4.

**Cuando aparezca el menú "selec. modo" :**

[↕]: Seleccione "Auto" o "Manual". → [SELEC.]

"Auto": Descargue todas las entradas del teléfono celular automáticamente. Vaya al paso 5.

"Manual": Copie las entradas que seleccionó.

- El menú "selec. modo" aparece solo cuando el teléfono celular soporta PBAP (Perfil de Acceso a Directorio Telefónico) para la conexión Bluetooth.

#### 4 Teléfono celular:

Siga las instrucciones de su teléfono celular para copiar las entradas del directorio telefónico.

- Para otros teléfonos celulares (no registrados), necesita buscar y seleccionar la unidad base. Es posible que requiera el NIP de la unidad base (predeterminado: "0000").
- Las entradas que se están copiando aparecen en el auricular.

#### 5 Auricular:

Espere a que aparezca "Completo". → [OFF]

**Cómo usar dispositivos Bluetooth****Cómo usar un audífono Bluetooth (opcional) para llamadas por la línea terrestre**

Al registrar un audífono Bluetooth en la unidad base, podrá tener conversaciones inalámbricas a manos libres para llamadas por la línea terrestre.

- La conexión del audífono con Bluetooth no está disponible mientras alguien se encuentra usando la línea celular.

**Cómo registrar un audífono en la unidad base****1 Su audífono:**

Configure su audífono en modo de registro.

- Consulte las instrucciones de operación de su audífono.

**2 Auricular:**

**[MENU] #621**

**3** Introduzca el NIP de su audífono.

- Por lo general, el NIP predeterminado es "0000". Consulte las instrucciones de operación del audífono.

**4** Oprima **[OK]**, y después espere a que se emita un pitido largo. → **[OFF]**

- Cuando el indicador HEADSET de la unidad base se ilumina en verde, usted está listo para usar el audífono.

**Cómo operar un audífono inalámbrico con Bluetooth usando una línea terrestre**

Consulte las instrucciones de operación de su audífono para ver cómo funciona.

**■ Cómo contestar llamadas de la línea terrestre con su audífono**

Para contestar una llamada de línea terrestre, encienda su audífono. Para ello, consulte las instrucciones de operación de su audífono.

Cuando termine de hablar, apague su audífono. Para ello, consulte las instrucciones de operación de su audífono.

- Si no puede colgar la llamada usando su audífono;
  - oprima **[■]** (STOP) en la unidad base. (serie KX-TG7731)
  - oprima **[SP-PHONE]** en la unidad base 2 veces. (serie KX-TG7741)

**■ Cómo cambiar entre la unidad base y su audífono**

Puede cambiar entre la unidad base y su audífono:

- durante una llamada por una línea terrestre con el altavoz de la unidad base. (serie KX-TG7741)
- durante una llamada de intercomunicador entre la unidad base y el auricular. (serie KX-TG7741)
- mientras escucha los mensajes grabados en el contestador de llamadas de la unidad base.\*1

**Serie KX-TG7741**

Para cambiar a su audífono:

Oprima **[HEADSET]** en la unidad base.

Para cambiar a la unidad base:































Oprima **[SP-PHONE]** en la unidad base.

**\*1 Serie KX-TG7731**

- Solo puede cambiar entre la unidad base y su audífono. Encienda el audífono. Para ello, consulte las instrucciones de operación de su audífono.



**Preguntas frecuentes**

Pregunta	Causa y solución
¿Por qué aparece  ?	<ul style="list-style-type: none"> <li>● El auricular está demasiado lejos de la unidad base. Acérquelo.</li> <li>● El adaptador para corriente de la unidad base no está conectado correctamente. Conecte de nuevo el adaptador para corriente a la unidad base.</li> <li>● El auricular no está registrado en la unidad base. Regístrelo.               <ol style="list-style-type: none"> <li><b>1 Auricular:</b> [MENU]                                </li></ol></li></ul>

## Customer services

### **Customer Services Directory (United States and Puerto Rico)**

Obtain Product Information and Operating Assistance; locate your nearest Dealer or Service Center; purchase Parts and Accessories; or make Customer Service and Literature requests by visiting our Web Site at:

**<http://www.panasonic.com/help>**

or, contact us via the web at:

**<http://www.panasonic.com/contactinfo>**

You may also contact us directly at: 1-800-211-PANA (1-800-211-7262), Monday - Friday 9 am to 9 pm; Saturday - Sunday 10 am to 7 pm, EST.

TTY users (hearing or speech impaired users) can call 1-877-833-8855.

### **Accessory Purchases (United States and Puerto Rico)**

Purchase Parts, Accessories and Instruction Books online for all Panasonic Products by visiting our Web Site at:

**<http://www.pstc.panasonic.com>**

or, send your request by E-mail to:

**[npcparts@us.panasonic.com](mailto:npcparts@us.panasonic.com)**

You may also contact us directly at:

1-800-332-5368 (Phone) 1-800-237-9080 (Fax Only)

(Monday - Friday 9 am to 9 pm, EST.)

Panasonic Service and Technology Company

20421 84th Avenue South, Kent, WA 98032

(We Accept Visa, MasterCard, Discover Card, American Express, and Personal Checks.)

TTY users (hearing or speech impaired users) can call 1-866-605-1277.

## Warranty (For United States and Puerto Rico)

PANASONIC CORPORATION OF NORTH AMERICA

One Panasonic Way, Secaucus, New Jersey 07094

# Panasonic Telephone Products Limited Warranty

### Limited Warranty Coverage

If your product does not work properly because of a defect in materials or workmanship, Panasonic Corporation of North America (referred to as "the warrantor") will, for the length of the period indicated on the chart below, which starts with the date of original purchase ("Limited Warranty period"), at its option either (a) repair your product with new or refurbished parts, or (b) replace it with a new or a refurbished product. The decision to repair or replace will be made by the warrantor.

#### Parts

One (1) Year

#### Labor

One (1) Year

During the "Labor" Limited Warranty period there will be no charge for labor. During the "Parts" Limited Warranty period, there will be no charge for parts. You must mail-in your product prepaid during the Limited Warranty period. This Limited Warranty excludes both parts and labor for batteries, antennas, and cosmetic parts (cabinet). This Limited Warranty only applies to products purchased and serviced in the United States or Puerto Rico. This Limited Warranty is extended only to the original purchaser and only covers products purchased as new.

### Ship-In Service

For assistance in the continental United States and Puerto Rico in obtaining repairs please ship the product prepaid to:

**PSTC (Panasonic) Exchange Center,**

**4900 George McVay Drive, Suite B Door #12, McAllen, TX 78503**

[panacare@us.panasonic.com](mailto:panacare@us.panasonic.com)

When shipping the unit carefully pack in a padded shipping carton, include all accessories, and send it prepaid. Include a letter detailing the complaint, a return address and provide a day time phone number where you can be reached. P.O. Boxes are not acceptable. Keep the tracking number for your records. A copy of valid registered receipt is required under the 1 year parts and labor Limited Warranty.

For Limited Warranty service for headsets if a headset is included with this product please follow instructions above.

**IF REPAIR IS NEEDED DURING THE LIMITED WARRANTY PERIOD THE PURCHASER WILL BE REQUIRED TO FURNISH A SALES RECEIPT/PROOF OF PURCHASE INDICATING DATE OF PURCHASE, AMOUNT PAID AND PLACE OF PURCHASE. CUSTOMER WILL BE CHARGED FOR THE REPAIR OF ANY UNIT RECEIVED WITHOUT SUCH PROOF OF PURCHASE.**

### Limited Warranty Limits And Exclusions

This Limited Warranty ONLY COVERS failures due to defects in materials or workmanship, and DOES NOT COVER normal wear and tear or cosmetic damage. The Limited Warranty ALSO DOES NOT COVER damages which occurred in shipment, or failures which are caused by products not supplied by the warrantor, or failures which result from accidents, misuse, abuse, neglect, bug infestation, mishandling, misapplication, alteration, faulty installation, set-up adjustments, misadjustment of consumer controls, improper maintenance, power line surge, lightning damage, modification, introduction of sand, humidity or liquids, commercial use such as hotel, office, restaurant, or other business or rental use of the product, or service by anyone other than a Factory Service Center or other Authorized Servicer, or damage that is attributable to acts of God.

**THERE ARE NO EXPRESS WARRANTIES EXCEPT AS LISTED UNDER "LIMITED WARRANTY COVERAGE". THE WARRANTOR IS NOT LIABLE FOR INCIDENTAL OR CONSEQUENTIAL DAMAGES RESULTING FROM THE USE OF THIS PRODUCT, OR ARISING OUT OF ANY BREACH OF THIS LIMITED WARRANTY.** (As examples, this excludes damages for lost time, lost calls or messages, cost of having someone remove or re-install an installed unit if applicable, travel to and from the servicer. The items listed are not exclusive, but are for illustration only.) **ALL EXPRESS AND IMPLIED WARRANTIES, INCLUDING THE WARRANTY OF MERCHANTABILITY, ARE LIMITED TO THE PERIOD OF THE LIMITED WARRANTY.**

Some states do not allow the exclusion or limitation of incidental or consequential damages, or limitations on how long an implied warranty lasts, so the exclusions may not apply to you.

This Limited Warranty gives you specific legal rights and you may also have other rights which vary from state to state. If a problem with this product develops during or after the Limited Warranty period, you may contact your dealer or Service Center. If the problem is not handled to your satisfaction, then write to the warrantor's Consumer Affairs Department at the addresses listed for the warrantor.

**PARTS AND SERVICE, WHICH ARE NOT COVERED BY THIS LIMITED WARRANTY, ARE YOUR RESPONSIBILITY.**

#### When you ship the product

- Carefully pack your unit, preferably in the original carton.
- Attach a letter, detailing the symptom.
- Send the unit to PSTC (Panasonic) Exchange Center, prepaid and adequately insured.
- Do not send your unit to Panasonic Corporation of North America listed on the back cover or to executive or regional sales offices. These locations do not repair consumer products.

## Index

- # 3-way conference: 25, 29
- A** Additional handset: 42
  - Alarm: 40
  - Answering calls: 23, 27
  - Answering system
    - Call screening: 49
    - Erasing messages: 50, 51, 52
    - Greeting message: 50
    - Greeting only: 53
    - Listening to messages: 50, 52
    - Number of rings: 53
    - Recording time: 53
    - Remote access code: 51
    - Remote operation: 51
    - Ring count: 53
    - Toll saver: 53
    - Turning on/off: 49, 52
  - Auto talk: 23, 38
- B** Battery: 11, 12
  - Belt clip: 15
  - Bluetooth wireless technology
    - Cellular phone (Link to cell): 18
    - Headset: 47
    - Phonebook transfer: 46
  - Booster (Clarity booster): 24
- C** Call block: 41
  - Call share: 24, 29
  - Call waiting: 24, 28
  - Call Waiting Caller ID: 24
  - Caller ID number auto edit: 38, 44
  - Caller ID service: 43
  - Caller list: 44
  - Caller list edit: 44
  - Cellular calls: 22, 27
  - Cellular phone
    - Deregistration: 21
    - Registration: 18
  - Chain dial: 32
  - CID (Caller ID): 44
  - Conference calls: 58
  - Control type: 15
  - Customer support: 38
- D** Date and time: 17
  - Dialing mode: 17
  - Direct command code: 33
  - Display
    - Contrast: 37
    - Language: 17
- E** Eco mode: 13
  - Equalizer: 24
  - Error messages: 61
- F** Flash: 24, 28
- G** Groups: 30, 43
- H** Handset
  - Deregistration: 42
  - Locator: 57
  - Name: 40
  - Registration: 42
  - Hold: 23, 28
- I** Intercom: 57
- K** Key tone: 37
- L** Landline calls: 22, 27
  - Line mode: 38
  - Link to cell
    - Area code: 21
    - Auto connection: 19
    - Cellular line only mode: 20
    - Cellular line selection: 20
    - Connection: 20
    - Ring as cell mode: 19
    - Select unit to ring: 19
- M** Making calls: 22, 27
  - Missed calls: 43
  - Mute: 24, 28
- P** Pause: 22, 27
  - Phonebook: 30
  - PIN: 21
  - Power failure: 12
- R** Redialing: 22, 27
  - Ringer ID: 43
  - Ringer tone: 35, 37, 43
  - Rotary/pulse service: 24
- S** Silent mode: 40
  - SP-PHONE (Speakerphone): 22
- T** Talking Caller ID: 43
  - Temporary tone dialing: 24, 29
  - Time adjustment: 36
  - Transferring calls: 58
  - Troubleshooting: 62
  - TTY: 82
- V** VM (Voice mail): 55
  - Voice guidance language: 17
  - Voice mail: 53, 55
  - Volume
    - Receiver: 22
    - Ringer (Base unit): 28, 35, 37
    - Ringer (Handset): 23, 35, 37
    - Speaker: 22, 27

**W** Wall mounting: 59



# IMPORTANT!

If your product is not working properly. . .

- ① **Reconnect AC adaptor to the base unit.**
- ② **Check if telephone line cord is connected.**
- ③ **Use rechargeable Ni-MH batteries.**  
(Alkaline/Manganese/Ni-Cd batteries CANNOT be used.)
- ④ Read **troubleshooting** page in the **Operating Instructions**.



Visit our Web site: <http://www.panasonic.com/help>

- **FAQ and troubleshooting hints are available.**

#### For your future reference

We recommend keeping a record of the following information to assist with any repair under warranty.

Serial No.	Date of purchase
(found on the bottom of the base unit)	
Name and address of dealer	



Panasonic Corporation of North America  
One Panasonic Way, Secaucus, New Jersey 07094

© Panasonic System Networks Co., Ltd. 2011

Printed in China



\*TG7731\*



## Free Manuals Download Website

<http://myh66.com>

<http://usermanuals.us>

<http://www.somanuals.com>

<http://www.4manuals.cc>

<http://www.manual-lib.com>

<http://www.404manual.com>

<http://www.luxmanual.com>

<http://aubethermostatmanual.com>

Golf course search by state

<http://golfingnear.com>

Email search by domain

<http://emailbydomain.com>

Auto manuals search

<http://auto.somanuals.com>

TV manuals search

<http://tv.somanuals.com>