

# Operating Instructions

Digital Time Lapse  
Video Cassette Recorder

**DTL**

Model AG-**DTL1P**

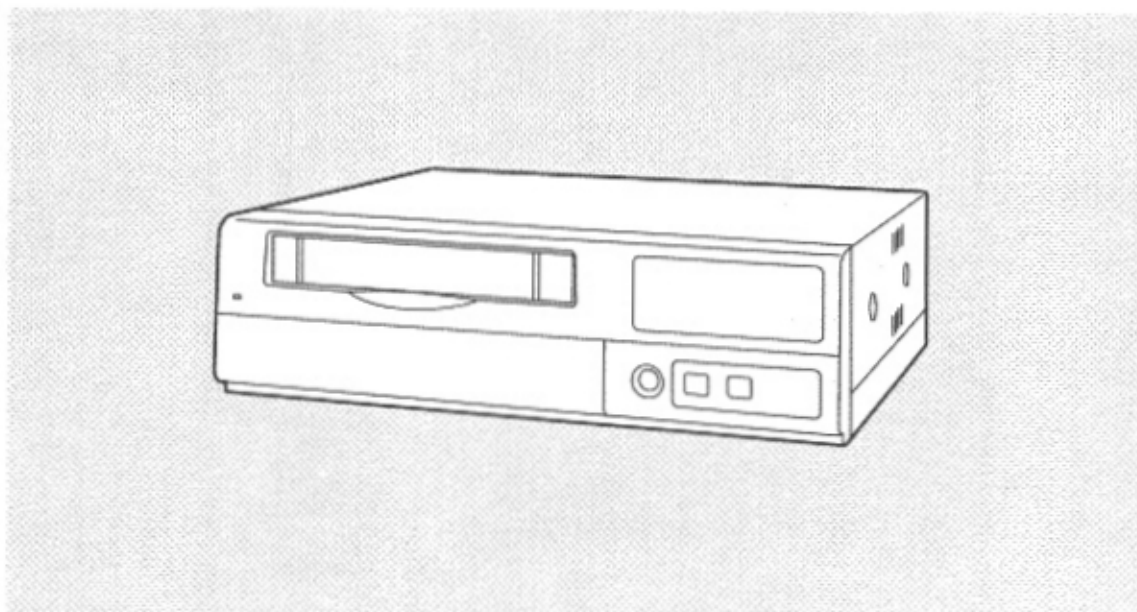

**Panasonic**

Before attempting to connect, operate or adjust this product, please read these instructions completely.

Printed in USA  
VQT8822

F0600W 



## IMPORTANT

"Unauthorized recording of copyrighted television programs, video tapes and other materials may infringe the right of copyright owners and be contrary to copyright laws."



### CAUTION

RISK OF ELECTRIC SHOCK  
DO NOT OPEN



CAUTION: TO REDUCE THE RISK OF ELECTRIC SHOCK,  
DO NOT REMOVE COVER (OR BACK).  
NO USER SERVICEABLE PARTS INSIDE.  
REFER TO SERVICING TO QUALIFIED SERVICE PERSONNEL.



The lightning flash with arrowhead symbol, within an equilateral triangle, is intended to alert the user to the presence of uninsulated "dangerous voltage" within the product's enclosure that may be of sufficient magnitude to constitute a risk of electric shock to persons.



The exclamation point within an equilateral triangle is intended to alert the user to the presence of important operating and maintenance (service) instructions in the literature accompanying the appliance.

### CAUTION:

Do not install or place this unit in a bookcase, built-in cabinet or in another confined space in order to keep well ventilated condition. Ensure that curtains and any other materials do not obstruct the ventilation condition to prevent risk of electric shock or fire hazard due to overheating.

### WARNING:

TO REDUCE THE RISK OF FIRE OR SHOCK HAZARD, DO NOT EXPOSE THIS EQUIPMENT TO RAIN OR MOISTURE.

### CAUTION:

TO REDUCE THE RISK OF FIRE OR SHOCK HAZARD AND ANNOYING INTERFERENCE, USE THE RECOMMENDED ACCESSORIES ONLY.

#### FCC Note:

This device complies with Part 15 of the FCC Rules. To assure continued compliance follow the attached installation instructions and do not make any unauthorized modifications.

This equipment has been tested and found to comply with the limits for a class A digital device, pursuant to Part 15 of the FCC Rules. These limits are designed to provide reasonable protection against harmful interference when the equipment is operated in a commercial environment. This equipment generates, uses, and can radiate radio frequency energy and, if not installed and used in accordance with the instruction manual, may cause harmful interference to radio communications. Operation of this equipment in a residential area is likely to cause harmful interference in which case the user will be required to correct the interference at his own expense.

Replace battery with part No. VL3032/1GUF only. Use of another battery may present a risk of fire or explosion.

Caution—Battery may explode if mistreated. Do not recharge, disassemble or dispose of in fire.

 indicates safety information.

- Do not insert fingers or any objects into the video cassette holder.
- Avoid operating or leaving the unit near strong magnetic fields. Be especially careful of large audio speakers.
- Avoid operating or storing the unit in an excessively hot, cold, or damp environment as this may result in damage both to the recorder and to the tape.
- Do not spray any cleaner or wax directly on the unit.
- If the unit is not going to be used for a length of time, protect it from dirt and dust.
- Do not leave a cassette in the recorder when not in use.
- Do not block the ventilation slots of the unit.
- Use this unit horizontally and do not place anything on the top panel.
- Cassette tape can be used only for one-side, one direction recording. Two-way or two-track recordings cannot be made.
- Cassette tape can be used for either Color or Black & White recording.
- Do not attempt to disassemble the recorder. There are no user serviceable parts inside.
- If any liquid spills inside the recorder, have the recorder examined for possible damage.
- Refer any needed servicing to authorized service personnel.

# Contents

<b>Features</b> .....	<b>4</b>	<b>Setting menus</b> .....	<b>39</b>
<b>Parts and their functions</b> .....	<b>5</b>	Setting method .....	39
Front panel .....	5	<b>Menu page P1</b>	
Rear panel .....	10	TIME/DATE PRESET screen .....	40
<b>Performing initial settings</b> .....	<b>11</b>	REC LOCK screen .....	40
Setting the date and time .....	11	HOUR METER screen .....	40
Simple time adjustment .....	12	<b>Menu page P2</b>	
Simple date and time adjustment .....	13	DISPLAY screen .....	41
Setting the recording time mode and number of		REC LOSS INDICATOR screen .....	41
cameras .....	14	DAYLIGHT SAVING screen .....	42
Setting the recording mode .....	15	<b>Menu page P3</b>	
<b>Frame recording and field recording</b> ..	<b>17</b>	RECORDING T-MODE & CAMERA screen ...	43
<b>Connections</b> .....	<b>18</b>	<b>Menu page P4</b>	
<b>Recording</b> .....	<b>20</b>	RECORDING MODE screen .....	43
<b>Playback</b> .....	<b>21</b>	ALARM/SENSOR REC screen .....	44
Normal playback .....	21	<b>Menu page P5</b>	
Still-picture playback .....	21	VTR MODE SELECT screen .....	45
<b>Changing over the screen display</b> ....	<b>22</b>	<b>Menu page P6</b>	
Changing over the screen during playback ...	22	TAPE REMAIN screen .....	46
Changing between the 1-screen and 4-in-1 screen		REC REVIEW screen .....	46
display .....	22	ERROR WARN BUZZER screen .....	47
Switching between the cameras .....	22	REC WARNING screen .....	47
<b>Useful functions</b> .....	<b>23</b>	<b>Menu page P7</b>	
Memory stop .....	23	TERMINAL INPUT SELECT screen .....	48
Alarm recording and sensor (emergency)		TERMINAL OUTPUT SELECT screen .....	48
recording .....	24	VIDEO OUT SEQUENCE screen .....	49
Alarm memory recall and power loss memory		EXT SWITCHER screen .....	49
recall .....	26	<b>Menu page P8</b>	
Search playback (cue/review) .....	27	PROGRAM TIMER screen .....	50
Alarm search (alarm recording section search) ..	27	INTERNAL WEEKLY TIMER screen .....	50
Time/date search .....	28	<b>Menu page P9</b>	
Internal timer recording .....	29	FREE SET TIMER screen .....	51
External timer recording .....	33	<b>Menu page P10</b>	
<b>Terminal connections</b> .....	<b>35</b>	RS-232C PARAMETERS screen .....	52
Alarm recording connections .....	35	USER ID REC screen .....	52
Tape-end output connections .....	36	<b>RS-232C interface</b> .....	<b>53</b>
Auto OFF output connections and recording output		1. Hardware specifications .....	53
connections .....	36	(1) Interface specifications .....	53
External timer input connections .....	36	(2) Communication parameters .....	53
Time setting connections .....	37	2. Software specifications .....	54
External timer input connections .....	37	(1) External interface specifications .....	54
<b>Terminal signal levels</b> .....	<b>38</b>	(2) Transmitting format (PC → unit) .....	54
		(3) Receiving format (unit → PC) .....	55
		(4) List of commands .....	56
		<b>Error messages</b> .....	<b>102</b>
		<b>Video head cleaning</b> .....	<b>103</b>
		<b>Condensation</b> .....	<b>103</b>
		<b>Maintenance</b> .....	<b>103</b>
		<b>Specifications</b> .....	<b>104</b>

# Features

---

## Built-in frame switcher for supporting 16 cameras

- The unit also supports asynchronous cameras.
- The unit enables recording after the cameras are switched over automatically as dictated by the recording time mode.
- During recording, the cameras can be switched and their images viewed on a TV monitor at a time other than the recording timing which has been set.

## Digital recordings with a high picture quality

Digital recordings with a high picture quality can be made on S-VHS tapes. The incorporation of high-performance A/D and D/A circuitry means that high-quality digital recording is possible even when recording after switching from one camera to another.

- High picture quality mode: 520 lines for horizontal resolution, 50 dB for S/N ratio
- Standard picture quality mode: 380 lines for horizontal resolution, 50 dB for S/N ratio

## Wide selection of recording time modes

- There is a choice of 14 different recording time modes.

3 hours, 9 hours, 12 hours, 18 hours, 24 hours, 48 hours, 72 hours, 96 hours, 120 hours, 180 hours, 240 hours, 360 hours, 480 hours and 960 hours
---

- It is possible to switch between frame recording and field recording.

## Camera-specific playback

During playback, any camera can be selected and its recording played back. During cue or review, as well, any camera can be selected and its recording played back.

## Playback with 4 pictures simultaneously shown on the screen

The pictures recorded by four of the cameras can be selected and, by dividing the TV monitor screen into four parts, all of the four pictures can be played back at the same time on the respective parts of the screen.

## Date/time search function

The recording date and time (month / day / hours / minutes) can be selected to initiate a search of the recorded data.

## Alarm search function

Recorded data that includes alarm recordings can be searched.

## High reliability and high durability

- IQ mechanism with top-notch reliability and durability
- Stable tape travel achieved using a 2DD reel motor
- Automatic head cleaning function for cleaning the head cylinder each time a tape is loaded

## Space-saving design with 38 cm width and vertical installation capability

The unit can be installed upright on its left-side panel and secured using the special-purpose mounting brackets (optional accessory STEN-B6730).

- Do not install the unit upright on its right-side panel. This may cause the unit to malfunction.

## On-screen setting functions

The unit's many and varied functions can be set on the monitor screen.

## Other features

- 75Ω termination ON/OFF function provided for camera input (16) connectors
- Switching between 8 camera input connectors and 8 camera loop-through outputs possible
- RS-232C control facility
- Audio recording (in the 3-hour to 24-hour time modes)
- Simple clock adjustment functions
- Recording time and operating camera setting function
- Diverse internal timer and external timer functions

# Parts and their functions

## Front panel

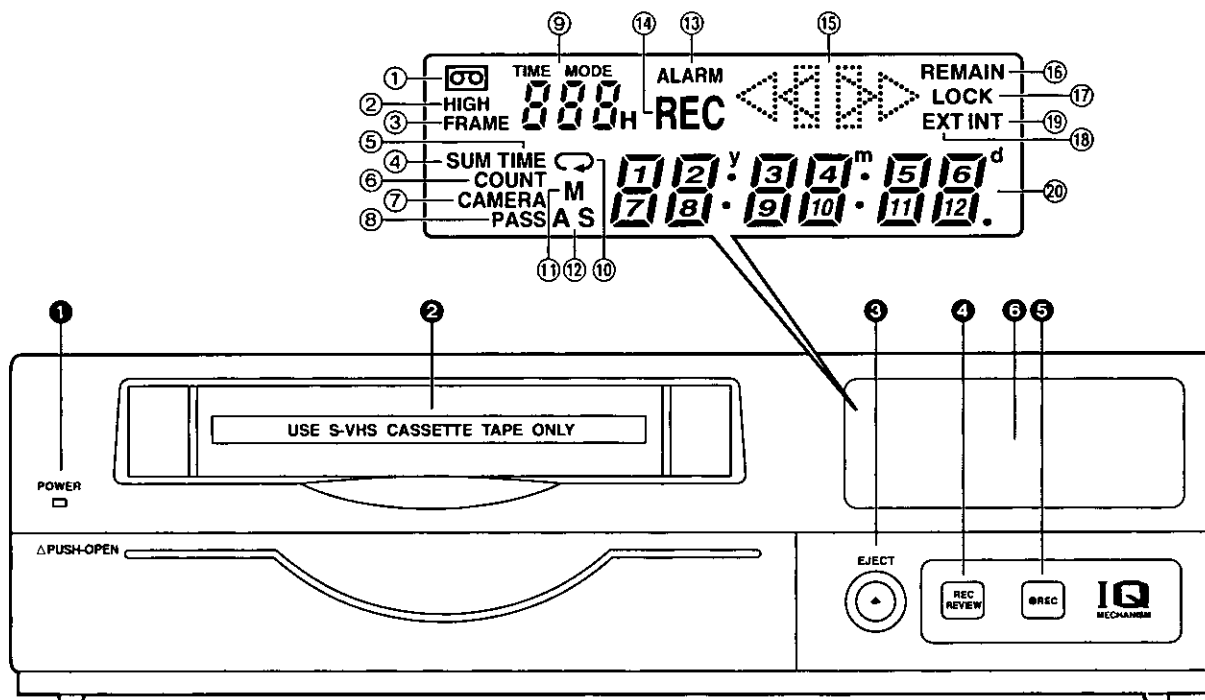

### ❶ POWER lamp

This lights when the power is turned on.

### ❷ Cassette insertion slot

Always use S-VHS cassette tapes. If a VHS tape is inserted instead, it will be automatically ejected when the REC button is pressed. A cassette tape will also be ejected when the REC button is pressed if its accidental erasure prevention tab has been broken out.

This unit is designed to provide the high level of reliability required of a time lapse recorder for use in such applications as surveillance, security and monitoring.

In order to ensure that this unit will perform reliably in recording operations, it is recommended that the following Panasonic video tape be used:

**S-VHS tape:** ST-120 series (120-minute tape)

### ❸ EJECT button

Press this to eject the cassette tape.  
It will not work unless it is pressed firmly.

### ❹ REC REVIEW button

Press this during recording to monitor what is being recorded. Several images captured a moment before the button was pressed are played back, and then the recording mode is restored. It takes about 10 seconds for the playback picture to appear.

### ❺ REC button

Press this to start recording.

# Parts and their functions

---

## ⑥ Display tube

### ①

Lights when a cassette tape is inserted.  
It flashes when an error is detected as a result of the recording review.

### ② HIGH

Lights when a tape which was recorded in the high picture quality mode is being played back and when a tape is being recorded in the high picture quality mode.

### ③ FRAME

Lights when a tape which was recorded in the frame mode is being played back and when a tape is being recorded in the frame mode.

### ④ SUM

Lights when the time is displayed in the summer-time (daylight saving) mode.

### ⑤ TIME

Lights when the time is displayed.

### ⑥ COUNT

Lights when the tape counter value is displayed.

### ⑦ CAMERA

Lights when the camera number is displayed.

### ⑧ PASS

Lights when the number of repeated tape recordings (passes) is displayed.

### ⑨ TIME MODE

Indicates the recording time mode.

### ⑩

Lights when repeat recording has been set.

### ⑪ M

Lights when the memory stop mode has been set.

### ⑫ AS (S)

**AS** : Lights when the alarm search mode has been set.

**S** : Lights when the time search mode has been set. The lamp flashes while a search is in progress.

### ⑬ ALARM

Lights during an alarm recording.  
Flashes upon completion of the alarm recording.

### ⑭ REC

Lights during recording or rec-pause.

### ⑮ Video operation mode displays

 : Playback

 : Reverse playback

**REC**  : Recording, recording monitoring

**REC**  : Rec-pause

 : Still picture (flashes during frame playback), frame feed

 : Fast forward, cue

 : Rewind, review

### ⑯ REMAIN

Flashes when the tape end is approaching (when the remaining tape alarm mode has been set).

### ⑰ LOCK

Lights when the lock mode has been set by the LOCK switch or using the REC LOCK item on the setting menu.

### ⑱ EXT

Lights when the external timer mode has been set.

### ⑲ INT

Lights when the internal timer mode has been set.

### ⑳ Counter display

Displays the time or tape counter value; displays the error code when an error has occurred.

In addition, when a discrepancy has arisen between the number of cameras set and the number of cameras actually connected because one of the cables connected to the CAMERA IN connectors has been disconnected or loosened, the camera number concerned will flash on the display to warn the user.

# Parts and their functions

## Front panel (sub panel)

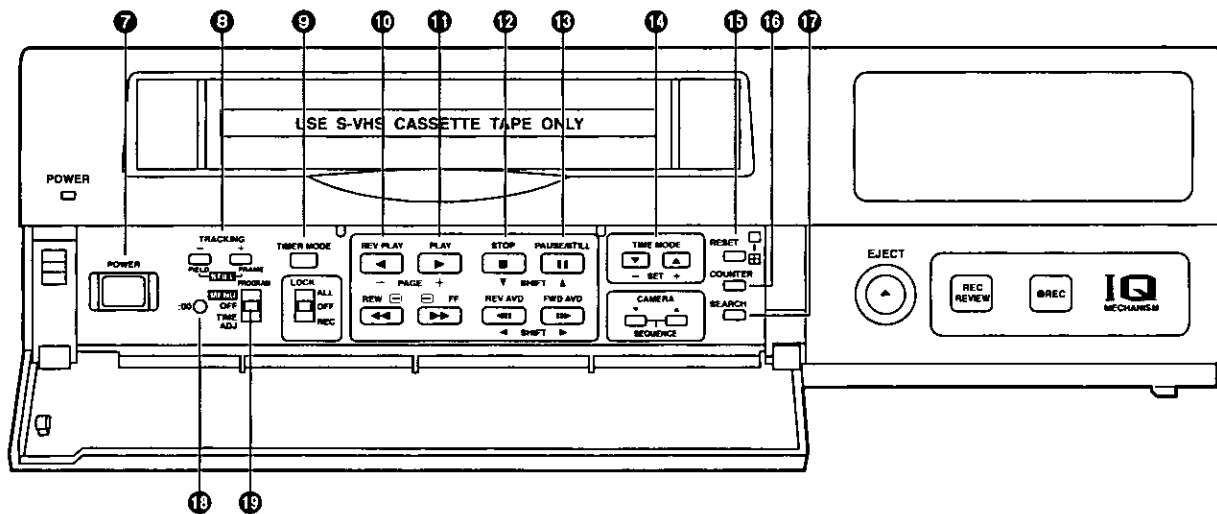

### 7 POWER switch

Used to turn the unit's power ON and OFF.  
When the power is turned on, the POWER lamp lights, and the buzzer is sounded once.

### 8 TRACKING buttons

Press during normal playback to adjust the tracking.  
When these buttons are pressed during still-picture playback, the unit is set to the field still-picture or frame still-picture mode.  
However, the unit will not be set to the frame still-picture mode if a tape recorded in the field mode has been inserted.

### 9 TIMER MODE button

Used to select the timer mode. Each time it is pressed, the mode is changed, and one of the following mode lamps lights on the display tube.

**No display:** Normal recording

**EXT** : External timer recording

**INT** : Internal timer recording

### 10 REV PLAY button

Press to play back the tape in the reverse direction.  
When the PROGRAM switch is at the MENU position, this button functions as the PAGE (-) button to select the setting menu screen.  
When the PROGRAM switch is at the TIME ADJ position, the button switches between the date display and time display.

### 11 PLAY button

Press to play back the tape in the forward direction.  
When the PROGRAM switch is at the MENU position, this button functions as the PAGE (+) button to select the setting menu screen.  
When the PROGRAM switch is at the TIME ADJ position, the button switches between the date display and time display.

### 12 STOP button

Press to stop the operation mode.  
When the PROGRAM switch is at the MENU position, this button functions as the SHIFT (▼) button to select the items on the setting menu screen.  
When the PROGRAM switch is at the TIME ADJ position, the button moves the screen display position downward.

# Parts and their functions

## 13 PAUSE STILL button

Press to initiate rec-pause or still-picture playback. When the unit remains in the pause or still-picture playback mode for more than a prescribed period of time, it is automatically set to the stop mode in order to protect the tape.

When the PROGRAM switch is at the MENU position, this button functions as the SHIFT (▲) button to select the items on the setting menu screen.

When the PROGRAM switch is at the TIME ADJ position, the button moves the screen display position upward.

## 14 TIME MODE buttons

Press to select the recording time mode.

- 3H : 3-hour recording mode
- 9H : 9-hour recording mode
- 12H : 12-hour recording mode
- 18H : 18-hour recording mode
- 24H : 24-hour recording mode
- 48H : 48-hour recording mode
- 72H : 72-hour recording mode
- 96H : 96-hour recording mode
- 120H : 120-hour recording mode
- 180H : 180-hour recording mode
- 240H : 240-hour recording mode
- 360H : 360-hour recording mode
- 480H : 480-hour recording mode
- 960H : 960-hour recording mode

When the PROGRAM switch is at the MENU position, these buttons function as the SET (+) and (-) buttons to select the settings for the setting menu items.

## 15 RESET button

Press while the counter value is shown on the display tube by the COUNTER button to reset the CTL counter.

When the camera number is shown on the display tube by the COUNTER button during playback, this button is used to switch the monitor screen between 1-screen playback and 4-screen playback.

## 16 COUNTER button

Used to switch the display mode on the display tube.

Each time the COUNTER button is pressed, the mode is switched as follows.

### Camera number display:

The current camera number is displayed.

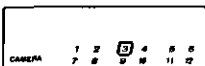

### Clock display:

The current time is displayed.

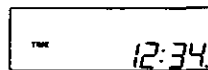

24-hour display

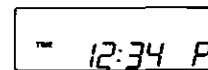

12-hour display

### Counter display:

The tape counter is displayed.

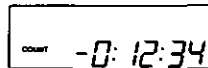

### Pass display:

This indicates the number of times (passes) repeat recording has been performed when repeat recording has been set.

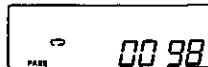

## 17 SEARCH button

Press to select the search mode.

Each time this button is pressed in the counter display mode, the search mode is switched, and one of the following mode lamps lights on the display tube:

**M** : Memory stop mode

**AS** : Alarm search mode

When the SEARCH button is pressed while the time is displayed on the display tube by the COUNTER button, the time search mode is set, and "S" lights on the display tube.

## 18 :00 button

Press to set the seconds digits of the time to "00."

The seconds are reset to "00" when this button is pressed while the display shows 0 to 29 seconds, and they are carried up to 1 minute and set to "00" when it is pressed while the display shows 30 to 59 seconds.

## 19 PROGRAM switch

Used to display the menu and adjust the time.

Keep this switch at OFF for normal operation.

### MENU:

The setting menu screen is displayed.

When the switch is set to the MENU position while holding down the STOP button, the alarm screen or power loss screen appears.

### TIME ADJ:

Set the switch to this position when adjusting the time or adjusting the screen display position.



# Parts and their functions

## Front panel (sub panel)

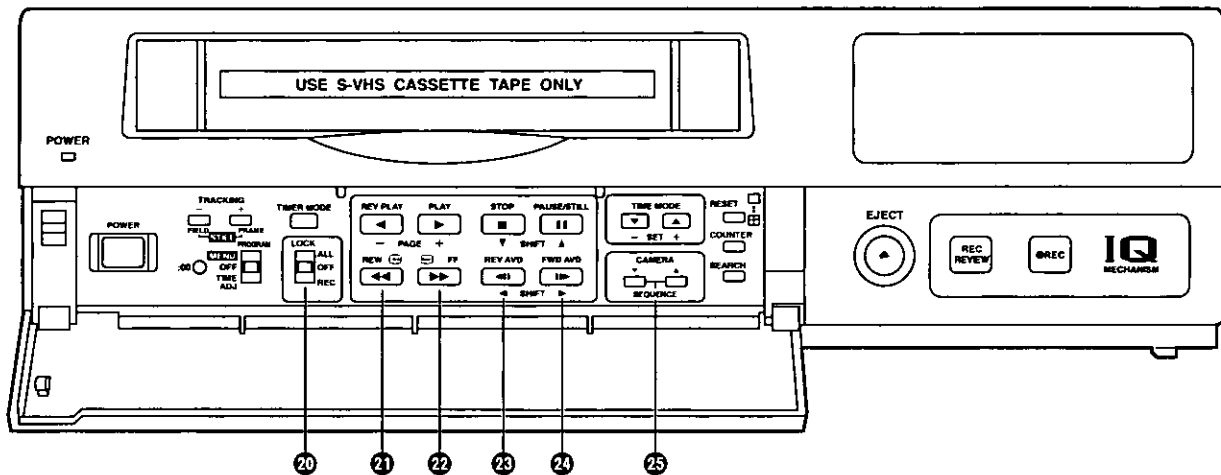

### 20 LOCK switch

Used to set the lock mode.

**ALL** : All normal operations are suspended, and LOCK lights on the display tube.

**OFF** : Normal operations can be conducted.

**REC** : Normal operations are suspended after recording has commenced, and LOCK lights on the display tube.  
(REC REVIEW button operations are acknowledged.)

### 21 REW/⏮ button

Press in the stop mode to rewind the tape.

When this button is pressed during playback or still-picture playback, the tape is reviewed.

### 22 ⏭/FF button

Press in the stop mode to fast forward the tape.

When this button is pressed during playback or still-picture playback, the tape is cued.

### 23 REV AVD button

Press during still-picture playback to advance the tape frame by frame in the reverse direction.

When the PROGRAM switch is at the MENU position, this button serves as the SHIFT (◀) button to select the setting menu screen items.

When the PROGRAM switch is at the TIME ADJ position, the button moves the screen display position toward the left.

### 24 FWD AVD button

Press during still-picture playback to advance the tape frame by frame in the forward direction.

When the PROGRAM switch is at the MENU position, this button serves as the SHIFT (▶) button to select the setting menu screen items.

When the PROGRAM switch is at the TIME ADJ position, the button moves the screen display position toward the right.

### 25 CAMERA buttons

#### In the playback mode:

Press during playback to select the camera and play back the pictures recorded by the selected camera.

#### In any other mode:

When the buttons are pressed in any other mode, the camera to be monitored can be selected.

When the [▼] button and [▲] button are pressed together, the auto sequence mode is established.

When they are pressed in the auto sequence mode, the unit is switched to the manual sequence mode.

# Parts and their functions

## Rear panel

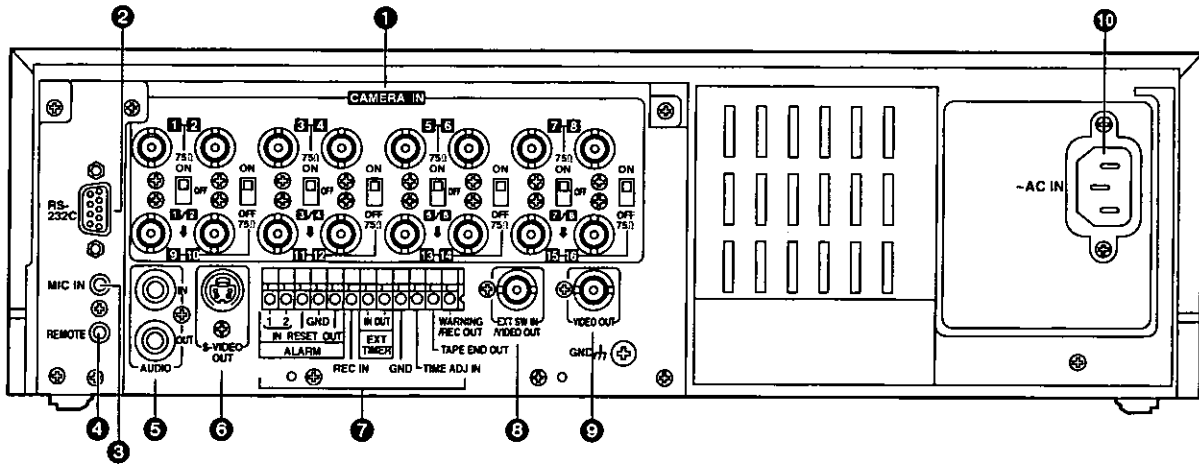

- 1 CAMERA IN connectors 1 to 16 (BNC), 75Ω termination/loop through selector switches 1 to 8, 75Ω termination switches 9 to 16**

The camera and other external video input signals (max. 16 inputs) are connected to these connectors.

To use these connectors, select REC TYPE as the RECORDING T-MODE & CAMERA setting on menu screen P3.

**<Note>**

The 75Ω termination/loop through selector switches 1 to 8 have 3 positions.

Switches 9 to 16 have 2 positions, 75 Ω termination ON and OFF.

- 2 RS-232C connector**

This is used to connect a personal computer or other such device for controlling the unit.

- 3 MIC IN jack (M3)**

This is used to connect the audio input signals from the microphone. (600Ω impedance)

- 4 REMOTE connector**

This is used to connect the model AG-A11 remote controller available as an optional accessory.

- 5 AUDIO connectors (pin jacks)**

These are the audio input and output connectors. When a microphone has been connected to the MIC IN jack, the sound from this jack takes precedence in recording.

- 6 S-VIDEO OUT connector (4P)**

This is used to connect the unit to a device equipped with an S-video input connector.

- 7 Terminal section**

- 8 EXT SW IN/VIDEO OUT connector (BNC)**

The same video signals are output as the signals from the VIDEO OUT connector 9. When EXT SW IN is selected as the EXT SWITCHER MODE setting on menu screen P7, the connector can be made to serve as an input connector of the external switcher.

- 9 VIDEO OUT connector (BNC)**

The video signals from the camera switched by the internal sequential switcher are output from this connector during recording.

During playback, the playback pictures of the recorded tape are output.

The menu screen or time adjustment screen is also displayed.

- 10 AC IN socket**

One end of the accessory power cord is connected to this socket, and the other end is connected to a household AC 120V power outlet.

# Performing initial settings

Before operating the unit, perform the following initial settings.

## ■ Setting the date and time

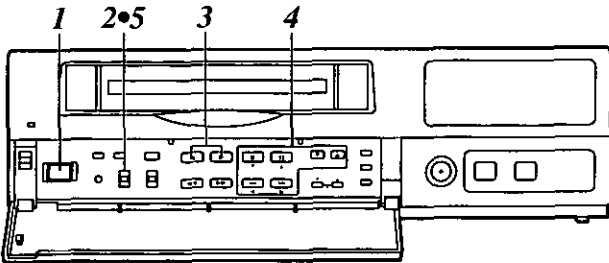

- 1** Set the power switch to ON.
- 2** Set the PROGRAM switch to the MENU position.  
The setting menu screen is shown on the TV monitor.
- 3** Press the PAGE (+) or PAGE (-) button to display the P1 TIME/DATE PRESET screen.  
The flashing items are ones that can be set.

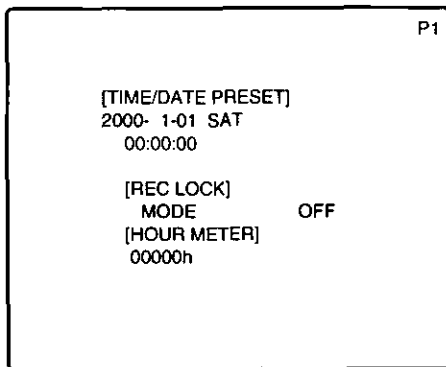

- 4** Proceed as follows to set the date and time.
  - Use the (▼) and (▲) SHIFT buttons to move the flashing part to the item whose setting is to be changed.
  - Use the (◀) and (▶) SHIFT buttons to move the flashing part to the column where the setting is to be changed.
  - Press the (+) or (-) SET button to adjust the figures.
- 5** Upon completion of the settings, set the PROGRAM switch to the OFF position.  
The setting menu screen is cleared from the TV monitor, and the normal mode is restored.

# Performing initial settings

If the clock is running fast or slow, follow the steps below to adjust it.

## ■ Simple time adjustment

When the clock is running up to 30 seconds fast or slow

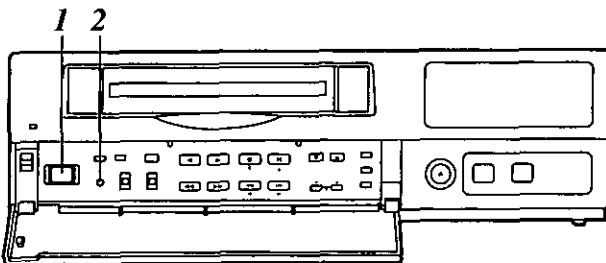

**1** Set the power switch to ON.

**2** The second digits of the time are reset to "00" when the 00: button is pressed in synchronization with the time signal, etc. They are reset to "00" when the button is pressed while the display shows 0 to 29 seconds. They are carried up to 1 minute and set to "00" when it is pressed while the display shows 30 to 59 seconds.

When the clock is running up to 15 minutes fast or slow

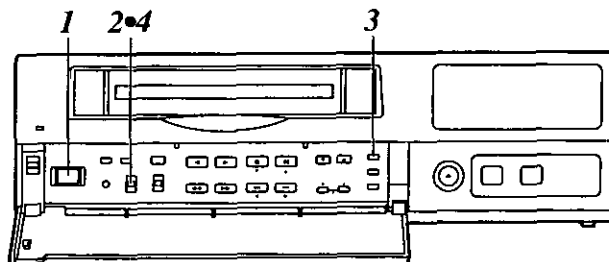

**1** Set the power switch to ON.

**2** Set the PROGRAM switch to the "adjust time" position. The counter display shows the current time, and the "minutes" digits flash.

**3** The minute and second digits of the time are reset to "00:00" when the RESET button is pressed in synchronization with the time signal, etc. They are reset to "00:00" when the button is pressed while the display shows 0 to 14 minutes. They are carried up to 1 hour and set to "00:00" when it is pressed while the display shows 45 to 59 minutes.

**4** Upon completion of the settings, set the PROGRAM switch to the OFF position.

# Performing initial settings

---

If the date and time are wrong, follow the steps below to adjust them.

## ■ Simple date and time adjustment

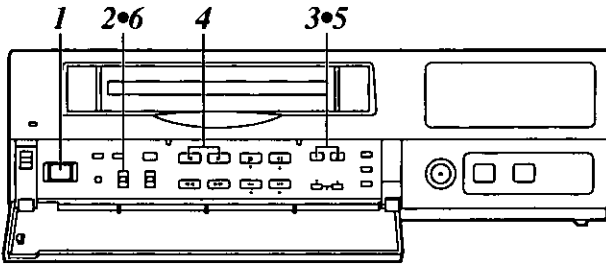

- 1** Set the power switch to ON.
- 2** Set the PROGRAM switch to the “adjust time” position.  
The counter display shows the current time, and the “minutes” digits flash.
- 3** Press the SET (+) or SET (-) button to set the “minutes” digits.
- 4** Press the PAGE (+) or PAGE (-) button.  
The current date appears, and the “date” digits flash.
- 5** Press the SET (+) or SET (-) button to set the “date” digits.
- 6** Upon completion of the settings, set the PROGRAM switch to the OFF position.

# Performing initial settings

## ■ Setting the recording time mode and number of cameras

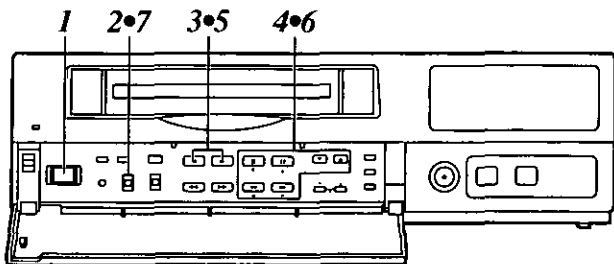

- 1 Set the power switch to ON.
- 2 Set the PROGRAM switch to the MENU position. The setting menu screen is shown on the TV monitor.
- 3 Press the PAGE (+) or PAGE (-) button to display the P3 RECORDING T-MODE & CAMERA screen. The flashing items are ones that can be set.

- 4 Follow the steps below to set the recording time mode and number of cameras.
  - Use the (▼), (▲), (◀) and (▶) SHIFT buttons to move the flashing part to the item whose setting is to be changed.
  - Press the (+) and (-) SET buttons to change the setting.

On the P3 RECORDING T-MODE & CAMERA screen, set the number of cameras to be used and their recording time modes for RT0 through RT7 in the REC TYPE column ahead of time. Different kinds of recordings can be undertaken by setting these two items when normal recording or timer recording is to be performed.

**<Notes>**

- For RT0, T-MODE (recording time mode) is fixed at OFF.
- For RT7, the setting for the number of cameras to be used is fixed at 1 unit for C1.

Fixed at OFF.

The number of cameras to be used is displayed automatically here.

[RECORDING T-MODE & CAMERA]		P3																
REC TYPE	T-MODE	C. NO	(CAMERA SELECT)															
			C1	C3	C5	C7	C9	C11	C13	C15	C2	C4	C6	C8	C10	C12	C14	C16
RT0	OFF	*16	Y	Y	Y	Y	Y	Y	Y	Y	Y	Y	Y	Y	Y	Y	Y	Y
RT1	3H	*08	Y	Y	Y	Y	N	N	N	N	N	N	N	N	N	N	N	N
RT2	12H	*04	Y	Y	N	N	N	N	N	N	N	N	N	N	N	N	N	N
RT3	24H	*06	Y	Y	Y	N	N	N	N	N	N	N	N	N	N	N	N	N
RT4	240H	*10	Y	Y	Y	Y	Y	Y	N	N	N	N	N	N	N	N	N	N
RT5	120H	*16	Y	Y	Y	Y	Y	Y	Y	Y	Y	Y	Y	Y	Y	Y	Y	Y
RT6	480H	*12	Y	Y	Y	Y	Y	Y	Y	N	N	N	N	N	N	N	N	N
RT7	480H	*01 C1																

Fixed at 01 C1.

The recording time mode is set here.

The cameras to be used are set here. The cameras are set in pairs: C1-C2, C3-C4 and so on up to C15-C16. "Y" (YES) is set for each pair of cameras that is to be used. A black burst signal (black screen) is recorded if no video signals are supplied from a camera even when "Y" (YES) has been set for that camera.

# Performing initial settings

## ■ Setting the recording mode

**5** Press the PAGE (+) or PAGE (-) button to display the P4 RECORDING MODE screen.

The flashing items are ones that can be set.

[RECORDING MODE]		P4
FIELD/FRAME	FIELD	
PICTURE QUALITY	HIGH	
REC-TYPE	RT0 ( OFF*16)	
[ALARM/SENSOR REC]		
MODE	OFF	
FIELD/FRAME	FIELD	
PICTURE QUALITY	HIGH	
DURATION	0.5min	
BUZZER	OFF	
REPEAT	OFF	
GROUP ALARM1	RT0 ( OFF*16)	
GROUP ALARM2	RT0 ( OFF*16)	

- 6** Set the recording mode by proceeding as follows.
- Use the (▼) and (▲) SHIFT buttons to move the flashing part to the item whose setting is to be changed.
  - Press the (+) and (-) SET buttons to change the setting.

**7** Upon completion of the settings, set the PROGRAM switch to the OFF position. The setting menu screen is cleared from the TV monitor, and the normal mode is restored.

### P4 RECORDING MODE screen

- Either field recording or frame recording is selected for the FIELD/FRAME item setting.
- Either high-quality recording or standard quality recording is selected for the PICTURE QUALITY item setting.
- The recording time mode which was set on the P3 RECORDING T-MODE & CAMERA screen is selected for the REC-TYPE setting.  
When type RT0 is selected, the recording time mode which was set using the TIME MODE button on the front panel is used for recording.  
When a type from RT1 to RT7 is selected, the recording time mode which was set by RT1 to RT7 is used for recording.

### <Notes>

- When RT7 is selected for the REC-TYPE item setting, frame recording will be forcibly performed regardless of the FIELD/FRAME item setting.
- Recording is possible at 60 fields a second (which is the same rate as for video machines used in the home) if NORMAL is selected as the PICTURE QUALITY item setting and the recording time mode is set to 3H when RT7 has been selected as the REC-TYPE item setting.
- If the recording time mode is set to 3H when a setting other than RT7 has been selected for the REC-TYPE item, recording will be performed automatically in the high picture quality mode regardless of the PICTURE QUALITY item setting.

# Performing initial settings

The table below shows the correlation between the recording time modes and number of cameras.  
(When an S-VHS 120-minute tape is used)  
Set the modes according to what is to be accomplished.

## High picture quality mode (field recording)

Recording time mode	No. of fields to be recorded per sec.	Time taken to switch cameras (sec.)	Time taken for recording turn to circulate and return to the first camera for the no. of cameras connected							
			2 cameras	4 cameras	6 cameras	8 cameras	10 cameras	12 cameras	14 cameras	16 cameras
3H	30.00	0.033	0.07	0.13	0.20	0.27	0.33	0.40	0.47	0.53
9H	10.00	0.100	0.20	0.40	0.60	0.80	1.00	1.20	1.40	1.60
12H	6.00	0.167	0.33	0.67	1.00	1.33	1.67	2.00	2.33	2.67
18H	4.29	0.233	0.47	0.93	1.40	1.87	2.33	2.80	3.27	3.73
24H	3.33	0.300	0.60	1.20	1.80	2.40	3.00	3.60	4.20	4.80
48H	1.76	0.567	1.13	2.27	3.40	4.53	5.67	6.80	7.93	9.07
72H	1.20	0.833	1.67	3.33	5.00	6.67	8.33	10.00	11.67	13.33
96H	0.91	1.100	2.20	4.40	6.60	8.80	11.00	13.20	15.40	17.60
120H	0.73	1.367	2.73	5.47	8.20	10.93	13.67	16.40	19.13	21.87
180H	0.49	2.033	4.07	8.13	12.20	16.27	20.33	24.40	28.47	32.53
240H	0.37	2.700	5.40	10.80	16.20	21.60	27.00	32.40	37.80	43.20
360H	0.25	4.033	8.07	16.13	24.20	32.27	40.33	48.40	56.47	64.53
480H	0.19	5.367	10.73	21.47	32.20	42.93	53.67	64.40	75.13	85.87
960H	0.09	10.700	21.40	42.80	64.20	85.60	107.00	128.40	149.80	171.20

## Standard picture quality mode (field recording)

Recording time mode	No. of fields to be recorded per sec.	Time taken to switch cameras (sec.)	Time taken for recording turn to circulate and return to the first camera for the no. of cameras connected							
			2 cameras	4 cameras	6 cameras	8 cameras	10 cameras	12 cameras	14 cameras	16 cameras
3H	30.00	0.033	0.07	0.13	0.20	0.27	0.33	0.40	0.47	0.53
9H	20.00	0.050	0.10	0.20	0.30	0.40	0.50	0.60	0.70	0.80
12H	12.00	0.083	0.17	0.33	0.50	0.67	0.83	1.00	1.17	1.33
18H	8.57	0.117	0.23	0.47	0.70	0.93	1.17	1.40	1.63	1.87
24H	6.67	0.150	0.30	0.60	0.90	1.20	1.50	1.80	2.10	2.40
48H	3.53	0.283	0.57	1.13	1.70	2.27	2.83	3.40	3.97	4.53
72H	2.40	0.417	0.83	1.67	2.50	3.33	4.17	5.00	5.83	6.67
96H	1.82	0.550	1.10	2.20	3.30	4.40	5.50	6.60	7.70	8.80
120H	1.46	0.683	1.37	2.73	4.10	5.47	6.83	8.20	9.57	10.93
180H	0.98	1.017	2.03	4.07	6.10	8.13	10.17	12.20	14.23	16.27
240H	0.74	1.350	2.70	5.40	8.10	10.80	13.50	16.20	18.90	21.60
360H	0.50	2.017	4.03	8.07	12.10	16.13	20.17	24.20	28.23	32.27
480H	0.37	2.683	5.37	10.73	16.10	21.47	26.83	32.20	37.57	42.93
960H	0.19	5.350	10.70	21.40	32.10	42.80	53.50	64.20	74.90	85.60

### <Notes>

- The actual recording time will be slightly longer than the figure indicated by the recording time mode.
- In the frame recording mode, it takes twice as long for the cameras to be switched.
- When the recording time mode is set to 3H, recording will be performed automatically in the high picture quality mode even if the standard picture quality mode has been set.



# Frame recording and field recording

With frame recording, the image of one camera is recorded in two fields, and after leaving a fixed interval, the image of the next camera is recorded.

With field recording, the image of one camera is recorded in one field, and after leaving half of the interval for frame recording, the image of the next camera is recorded.

The gaps between the recorded images are shorter which enables the cameras to be switched in half the time taken by frame recording.

## Example where cameras 1 to 4 are connected

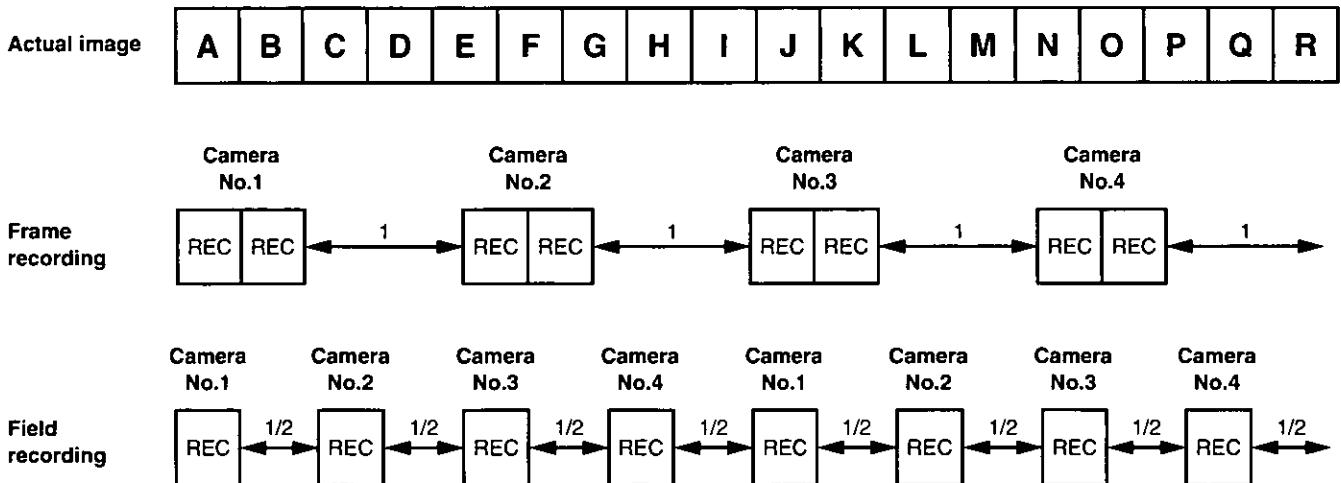

# Connections

## Example of connections to switch between 16 cameras for recording

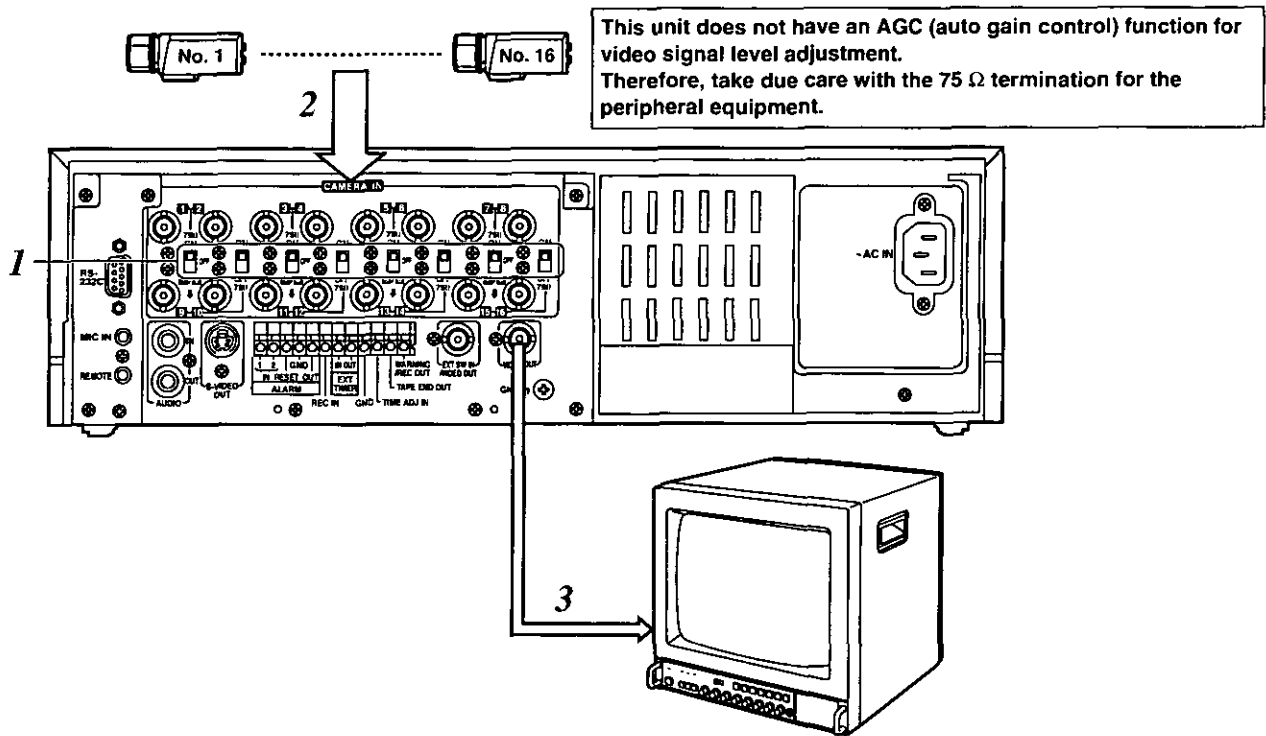

- 1 Set all 8 of the 75  $\Omega$  termination switches to the ON position.
- 2 Connect the 16 cameras to CAMERA IN connectors 1 to 16.
- 3 Connect the TV monitor to the VIDEO OUT connector.

### <Notes>

- When connecting line-locked cameras, select ON for the LL CAMERA item setting on the setting menu shown on the P7 VIDEO OUT SEQUENCE screen.  
The images on the monitor will shake fractionally: this is normal and not indicative of malfunctioning.
- This unit does not contain a compensation circuit. Install a compensator when the total length of the cables (coaxial 3C-2V) used to connect the cameras exceeds 200 meters.  
There is no need to install a compensator if the total length is under 400 meters if coaxial cables (5C-2V) with minimal transmission loss are used.

# Connections

When using a frame switcher during recording to output more than one screen image on the TV monitor

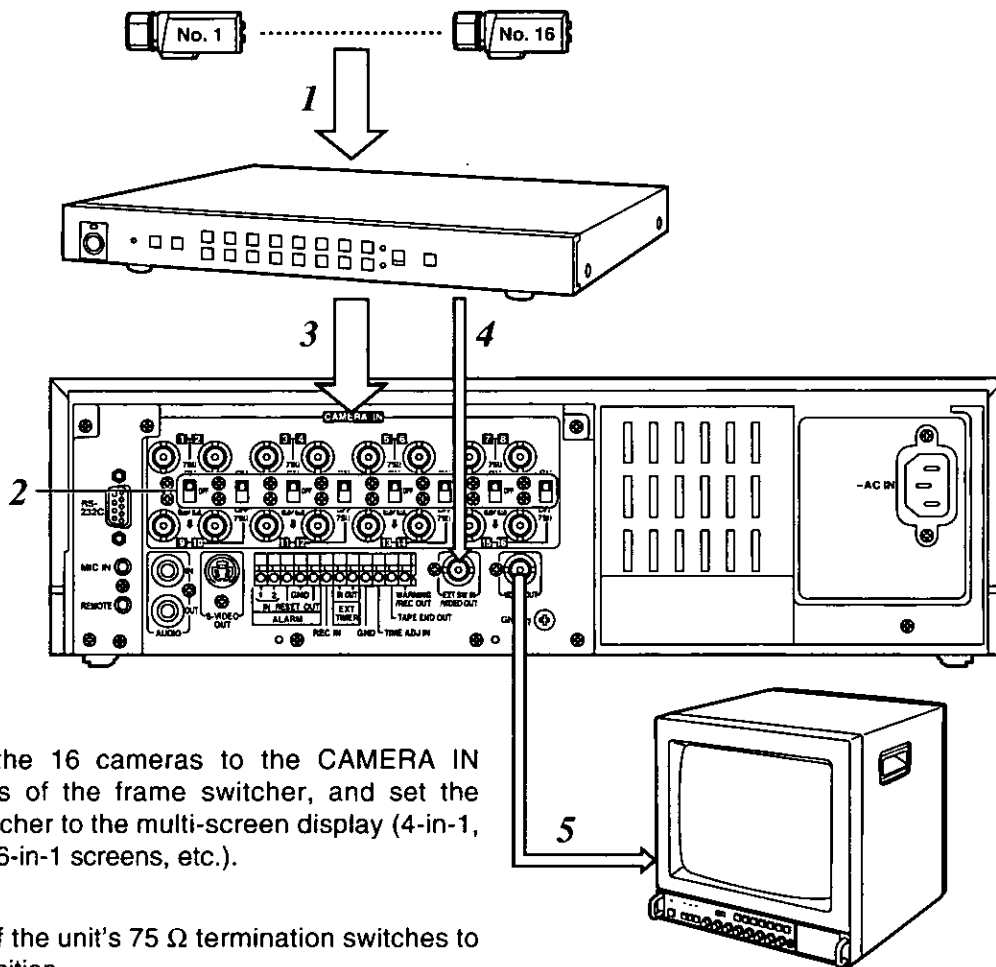

- 1** Connect the 16 cameras to the CAMERA IN connectors of the frame switcher, and set the frame switcher to the multi-screen display (4-in-1, 9-in-1 or 16-in-1 screens, etc.).
- 2** Set all 8 of the unit's 75  $\Omega$  termination switches to the ON position.
- 3** Connect the 16 camera outputs of the frame switcher to CAMERA IN connectors **1** through **16** on the unit.
- 4** Connect the video output of the frame switcher to the EXT SW IN/VIDEO OUT connector on the unit.
- 5** Connect the TV monitor to the VIDEO OUT connector on the unit.
- 6** Select EXT SW IN as the MODE item setting on the setting menu shown on the P7 EXT SWITCHER screen.  
The multiple images set by the frame switcher can be viewed on the TV monitor in all modes except for the playback mode.

# Recording

Proceed with recording after having performed the connections and followed the steps for "Setting the date and time" (page 11) and "Setting the recording time mode and number of cameras" (page 14).

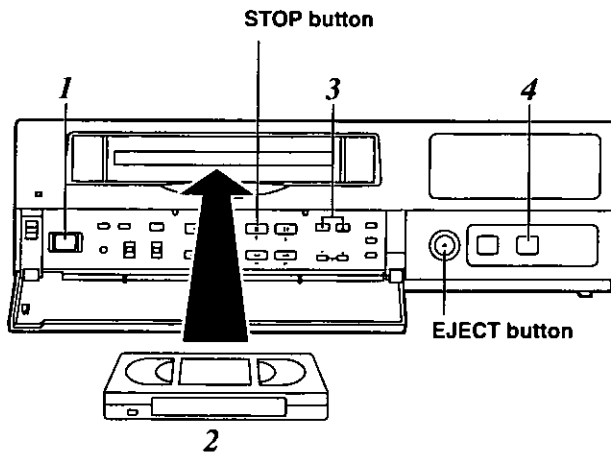

**1** Set the power switch to ON.  
When the power is turned on, the POWER lamp lights, and the buzzer is sounded once.

**2** Insert the cassette tape.  
Press the EJECT button to eject the cassette tape. It will not work unless it is pressed firmly.

**<Note>**

Always use S-VHS cassette tapes. If a VHS tape is inserted instead, it will be automatically ejected when the REC button is pressed.

A cassette tape will also be ejected when the REC button is pressed if its accidental erasure prevention tab has been broken out.

This unit is designed to provide the high level of reliability required of a time lapse recorder for use in such applications as surveillance, security and monitoring.

In order to ensure that this unit will perform reliably in recording operations, it is recommended that the following Panasonic video tape be used:

**S-VHS tape:** ST-120 series (120-minute tape)

**3** Press the TIME MODE buttons to set the recording time mode.

**4** Press the REC button.  
Recording is started in the set time mode using the set cameras which are switched in turn automatically.  
To stop the recording, press the STOP button.

When 8 cameras are to be used, select "N" (NO) for C9—C16 in the RT0 camera setting columns (CAMERA SELECT) on the setting menu shown on the P3 RECORDING T-MODE & CAMERA screen.

[RECORDING T-MODE & CAMERA]													P3					
REC T-	C.	(CAMERA SELECT)																
TYPE	MODE	NO	C1	C3	C5	C7	C9	C11	C13	C15	C2	C4	C6	C8	C10	C12	C14	C16
RT0	OFF*	8	Y	Y	Y	Y	N	N	N	N								
RT1	OFF*	16	Y	Y	Y	Y	Y	Y	Y	Y								
RT2	OFF*	16	Y	Y	Y	Y	Y	Y	Y	Y								
RT3	OFF*	16	Y	Y	Y	Y	Y	Y	Y	Y								
RT4	OFF*	16	Y	Y	Y	Y	Y	Y	Y	Y								
RT5	OFF*	16	Y	Y	Y	Y	Y	Y	Y	Y								
RT6	OFF*	16	Y	Y	Y	Y	Y	Y	Y	Y								
RT7	OFF*	01	C1															

Y: YES N: NO

When recording always in the same recording time mode instead of setting the mode using the TIME MODE button, set RT1 through RT7 for the REC TYPE item on the setting menu shown on the P3 RECORDING T-MODE & CAMERA screen, and set the REC TYPE (RT1 through RT7) to be used for recording for the REC-TYPE item on the P4 RECORDING MODE screen.  
Select RT7 when using one camera for the recording. This enables the images of the camera connected to the camera input 1 connector to be recorded.

# Playback

## Normal playback

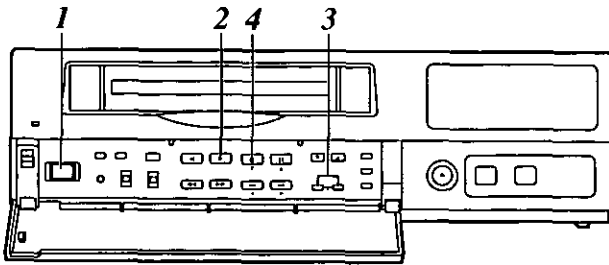

- 1 Set the power switch to ON, and insert the cassette tape.
- 2 Press the PLAY button to start playback.  
When 8 cameras are being used, the 8 camera numbers appear on the camera number display of the display tube, and the number of the camera whose pictures are being played back is enclosed in a square.

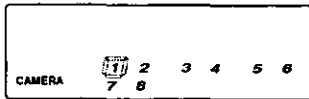

- 3 Press the CAMERA buttons to set the playback camera.
- 4 To stop the playback, press the STOP button.

### <Note>

When video noise in blocks interferes with playback, press the (+) or (-) tracking button until the noise is eliminated.

## Still-picture playback

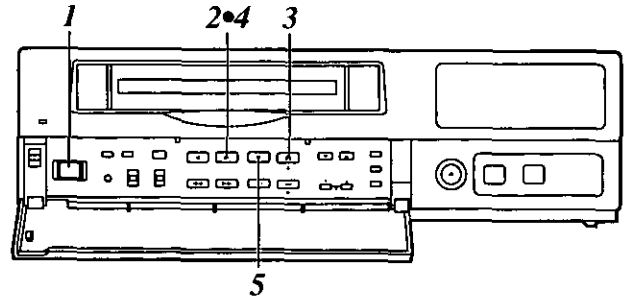

- 1 Set the power switch to ON, and insert the cassette tape.
- 2 Press the PLAY button to start playback.
- 3 Press the PAUSE STILL button.  
The unit is now set to the still-picture playback mode.  
(When the frame advance button is pressed in the still-picture playback mode, the tape is played back one frame at a time.)
- 4 Press the PLAY button again to return to normal playback.
- 5 To stop the playback, press the STOP button.

### <Note>

If a switch is made to cameras No.13 to 16 when a tape which was frame-recorded using cameras No.13 to 16 is being played back in the still-picture playback mode, blue background signals will be output.

# Changing over the screen display

## Changing over the screen during playback

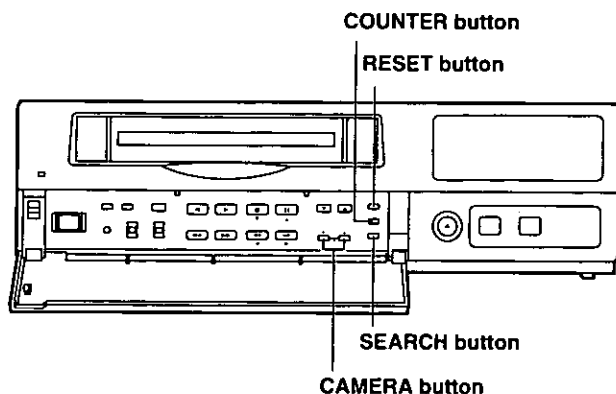

## Changing between the 1-screen and 4-in-1 screen display

**1** During playback, one screen is displayed on the TV monitor.



**2** Press the COUNTER button to establish the camera number display mode.

**3** Press the RESET button to change over to the 4-in-1 screen display. Each time the RESET button is now pressed, the display is switched between the 1-screen and 4-in-1 screen.

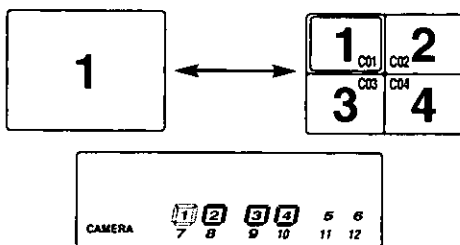

Four camera numbers are enclosed in squares on the camera number display of the display tube, and the square corresponding to the number of the selected camera flashes. In addition, the numbers of the cameras (C01/C02/C03/C04) appear in the center of the TV monitor.

### <Note>

It is not possible to switch to the 4-in-1 screen display when a tape which was frame-recorded using cameras No.13 to 16 is to be played back.

## Switching between the cameras

### In the 1-screen display mode

The pictures recorded by a specific camera can be monitored by pressing the CAMERA button during playback.

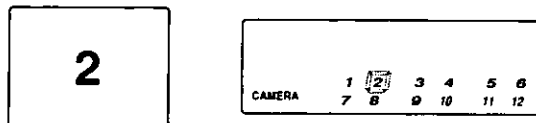

### In the 4-in-1 screen display mode

When monitoring the pictures recorded by specific cameras on the four screens in the 4-in-1 screen display mode

**1** Press the SEARCH button to move to the screen with the white border.



**2** Press the CAMERA button to set the camera.

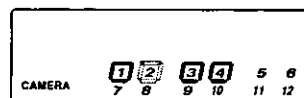

**3** Repeat steps 1 and 2 for the other screens to set the camera for each.

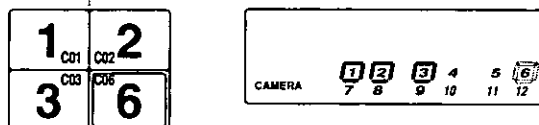

# Useful functions

---

## Memory stop

This function serves to rewind or fast forward the tape to the "00:00:00" counter position and then automatically set the unit to the stop mode when a regular operation is being performed.

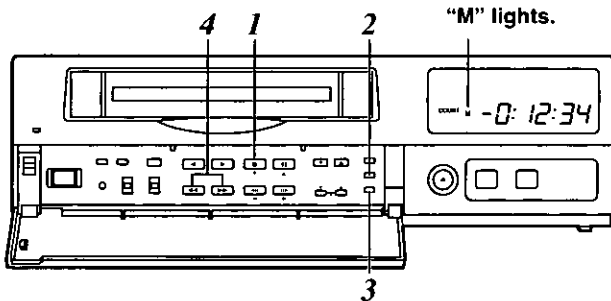

- 1** Press the STOP button to set the unit to the stop mode.
- 2** Press the COUNTER button to establish the counter display mode.
- 3** Press the SEARCH button.  
Check that "M" lights on the display tube and that the memory stop mode is established.  
Press the SEARCH button again if "AS" has lighted.
- 4** Press the REW button if the counter reading is higher than "00:00:00"; conversely, press the FF button if it is lower (a negative value) than "00:00:00."
- 5** The counter reading approaches "00:00:00," and the tape is automatically set to the stop mode.

# Useful functions

## Alarm recording and sensor (emergency) recording

### Alarm recording

This function enables recording with changes made to the time mode and/or cameras used for recording when an alarm signal (see page 35 for details on the alarm recording connections) is input during recording.

### Sensor (emergency) recording

This function enables recording with changes made to the time mode and/or cameras used for recording as soon as an alarm signal is input even when the unit's power is off.

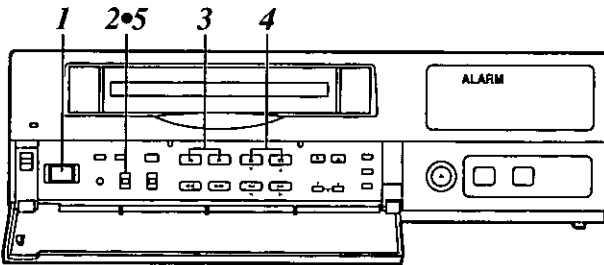

- 1 Set the POWER switch to ON, and insert the cassette tape.
- 2 Set the PROGRAM switch to the MENU position. The setting menu screen now appears on the TV monitor.
- 3 Press the PAGE (+) or PAGE (-) button to display the P4 ALARM/SENSOR REC screen. The flashing items are ones that can be set.

[RECORDING MODE]		P4
FIELD/FRAME	FIELD	
PICTURE QUALITY	HIGH	
REC-TYPE	RT0 ( OFF*16)	
[ALARM/SENSOR REC]		
MODE	OFF	
FIELD/FRAME	FIELD	
PICTURE QUALITY	HIGH	
DURATION	0.5min	
BUZZER	OFF	
REPEAT	OFF	
GROUP ALARM1	RT0 ( OFF*16)	
GROUP ALARM2	RT0 ( OFF*16)	

- 4 Take the following steps to set the recording mode to be established when an alarm signal is input:

- Use the (▼) and (▲) SHIFT buttons to move the flashing part to the item whose setting is to be changed.
- Press the (+) and (-) SET buttons, and change the setting.

#### <Notes>

- Alarm recording and sensor recording are selected using the MODE item. Select OFF as the MODE item setting if recording is not to be performed when an alarm signal is input.
- The recording time (DURATION) is set as follows between 30 seconds and 10 minutes: CONTINUE (up to the tape-end) or MANUAL (while the alarm signal is input).

- 5 When the settings are completed, set the PROGRAM switch to the OFF position. The setting menu screen is cleared from the TV monitor, and the normal mode is restored.



# Useful functions

## When ALARM is selected as the MODE item setting

Press the REC button to start recording.  
 The alarm recording mode is established when an alarm signal is input.  
 Once alarm recording is initiated, "ALARM" flashes on the display tube.  
 When the STOP button is pressed, the display is cleared, and recording stops.  
 ● When OFF or SENSOR is selected as the MODE setting on the menu screen shown on P4 ALARM/SENSOR REC, the alarm recording function does not work.

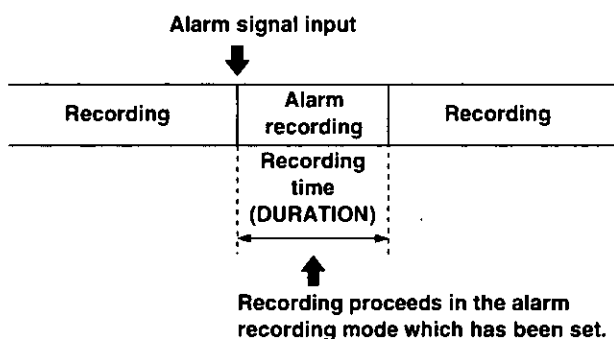

<Note>  
 When alarm recording is completed, the operation prior to the alarm signal input is restored.

## When SENSOR is selected as the MODE item setting

Sensor recording starts as soon as an alarm signal is input even when the unit's power is off or the tape has stopped.  
 ● When OFF or ALARM is selected as the MODE setting on the menu screen shown on P4 ALARM/SENSOR REC, the sensor recording function does not work.

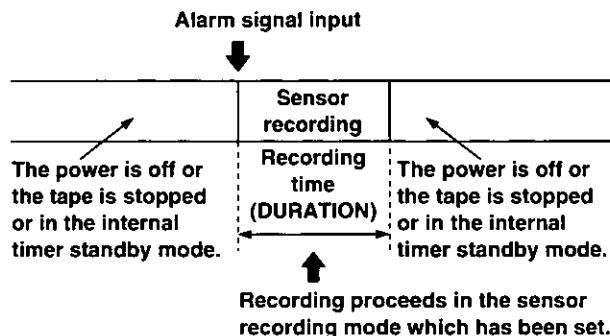

<Note>  
 When sensor recording is completed, the operation prior to the alarm signal input is restored.

## When ALARM/SENSOR is selected as the MODE item setting

Both alarm recording and sensor recording are performed.  
 If an alarm signal is input during recording, the alarm recording mode is established, and when it is input while the unit's power is off or the tape has stopped, sensor recording is started.

# Useful functions

## Alarm memory recall and power loss memory recall

Alarm memory recall is a function for storing in the memory those dates/times and number of occasions on which the alarm recording and sensor recording functions were activated.

Power loss memory recall is a function for storing in the memory those dates/times and number of occasions on which the primary power supply was shut off due to a power outage, etc.

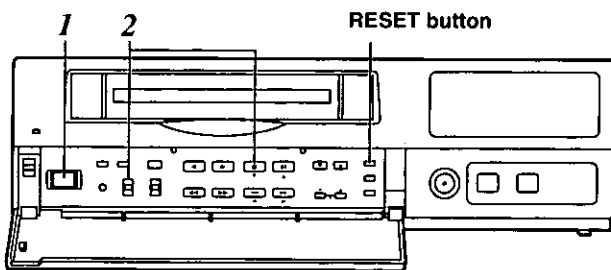

**1** Set the POWER switch to ON.

**2** Set the PROGRAM switch to the MENU position while holding down the STOP button. The ALARM RECALL screen and POWER LOSS MEMORY screen now appear.

The alarm number/s and dates/times when the alarm signal was input are displayed on the ALARM RECALL screen.

The number of times the primary power source has been shut off and the dates/times when this happened are displayed on the POWER LOSS MEMORY screen.

(Data is displayed in sequence with the latest at the top of the screen.)

[ALARM RECALL]		
29	12-30-2000	3:15
28	12-04-2000	12:10
27	10-25-2000	2:20
26	9-10-2000	2:30
25	8-11-2000	6:55
24	5-10-2000	3:22
23	4-11-2000	6:55
22	3-10-2000	3:22
[POWER LOSS MEMORY]		
14	12-01-2000	12:00
13	10-05-2000	10:30
12	08-10-2000	9:20
11	3-02-2000	7:00

The following display appears when alarm recording was never performed or when the primary power supply was never shut off.

[ALARM RECALL]		
**	**--**--*****	**:**
**	**--**--*****	**:**
**	**--**--*****	**:**
**	**--**--*****	**:**
**	**--**--*****	**:**
**	**--**--*****	**:**
**	**--**--*****	**:**
**	**--**--*****	**:**
**	**--**--*****	**:**
**	**--**--*****	**:**
[POWER LOSS MEMORY]		
**	**--**--*****	**:**
**	**--**--*****	**:**
**	**--**--*****	**:**
**	**--**--*****	**:**

### <Notes>

- Data for up to 8 alarms is stored on the ALARM RECALL screen whereas data for up to 4 power losses is stored on the POWER LOSS MEMORY screen.
- A total of 99 alarms and 99 power losses are stored in the memory. When 99 is exceeded, the count returns to "00."
- As with alarm recordings, the sensor recordings are stored as alarm memory data.
- The alarm memory data and power loss memory data are stored in the memory circuit inside the unit. They are not recorded on the tape.
- When the PROGRAM switch is set to any position except MENU, the ALARM RECALL screen and POWER LOSS MEMORY screen displays are cleared.
- When the RESET button is pressed while the ALARM RECALL screen is displayed, the memory can be cleared, but the POWER LOSS MEMORY screen is not cleared.

[ALARM RECALL]		
**	**--**--*****	**:**
**	**--**--*****	**:**
**	**--**--*****	**:**
**	**--**--*****	**:**
**	**--**--*****	**:**
**	**--**--*****	**:**
**	**--**--*****	**:**
**	**--**--*****	**:**
**	**--**--*****	**:**
**	**--**--*****	**:**
[POWER LOSS MEMORY]		
14	12-01-2000	12:00
13	10-05-2000	10:30
12	08-10-2000	9:20
11	3-02-2000	7:00

# Useful functions

## Search playback (cue/review)

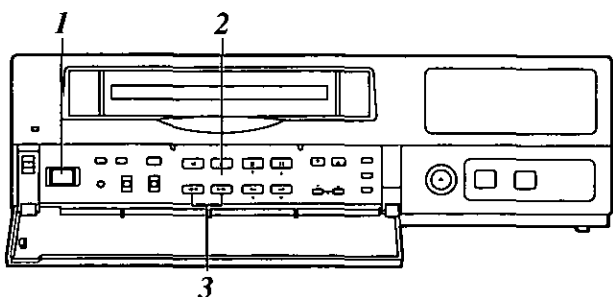

- 1 Set the POWER switch to ON, and insert the cassette tape.
- 2 Press the PLAY button to start playback.
- 3 Press the FF button or REW button.  
The unit performs search playback (cue or review) while the FF button or REW button is held down. Normal playback is restored when the FF button or REW button is released.

### <Notes>

- When search playback is performed with a tape which was frame-recorded using cameras No.13 to 16, the recorded images of all the cameras are mixed and output even if a particular camera is selected.
- The picture will become quite blurred when search playback is performed for a tape which was field-recorded in the standard picture quality mode. This is normal and not indicative of malfunctioning.

## Alarm search (alarm recording section search)

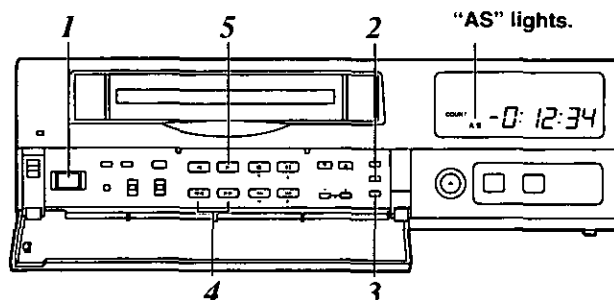

- 1 Set the POWER switch to ON, and insert the cassette tape containing the alarm recording.
- 2 Press the COUNTER button to establish the counter display mode.
- 3 Press the SEARCH button.  
Check that "AS" lights on the display tube and that the alarm search mode is established. Press the SEARCH button again if "M" has lighted.
- 4 While the unit is in the stop, fast forward or rewind mode, press the REW or FF button.  
The first alarm recording section is searched in the direction corresponding to the button pressed, and the unit is set to the still-picture playback mode.
- 5 To play back the section, press the PLAY button.

### <Notes>

- To release the alarm search mode, press the SEARCH button again to clear "AS" from the display tube.
- The alarm search function can be used to search for only those alarm recording sections which were recorded for more than 30 seconds in the 3-hour, 9-hour, 12-hour, 18-hour or 24-hour recording time mode.
- When the FF button or REW button is pressed during playback, search playback (cue or review) is initiated, and even when the button is released, search playback will continue if the unit is in the alarm search mode.

# Useful functions

## Time/date search

This function is used to search for a particular recording section by designating its date and time.

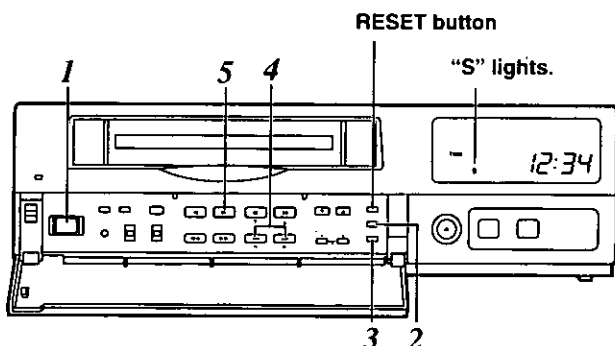

- 1 Set the POWER switch to ON, and insert the cassette tape.
- 2 Press the COUNTER button to establish the time display mode.
- 3 Press the SEARCH button.  
"S" lights on the display tube, and the TIME DATE SEARCH screen appears on the TV monitor.

The time at which the recording was ended is shown on the TIME DATE SEARCH screen.  
When the tape is played back, the date and time recorded on the tape are displayed.  
When the RESET button is now pressed, the display changes to the time at which the recording was started.

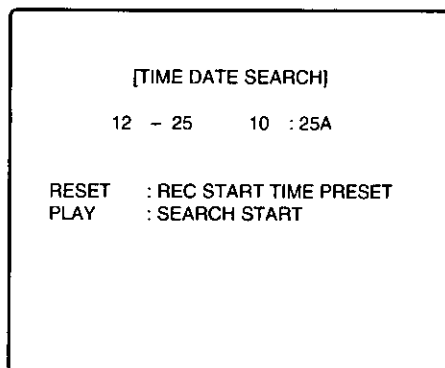

- 4 Follow the steps below to set the search date and time.
  - Use the (◀) and (▶) SHIFT buttons to move the flashing part to the item whose setting is to be changed.
  - Press the (+) and (-) SET buttons to set the figure.

- 5 Press the PLAY button or REV PLAY button.  
The recording section with the designated date and time is now searched.

### <Notes>

- The tape comes to a stop at its end or start if no recording section with the date and time was found as a result of the search.
- When the tape is stopped during recording, it will stop at the border between the new recording and old recording, and the continuity in the date and time recorded on the tape will be lost.  
In this state, searches may not be performed properly.  
When the date or time to be searched is in the newly recorded section, it is recommended that the REV PLAY button be pressed. By pressing this button, the tape is returned a little in the reverse direction, the date and time data is loaded, and the search is performed using this data as a reference.

- 6 To release the time/date search mode, press any of the function buttons.

# Useful functions

## Internal timer recording

Recording can be started and ended at the desired times which are set using the internal timer.

### <Note>

Before setting the internal timer recording, complete the connections as well as the steps for "Setting the date and time" (page 11) and "Setting the recording time mode and number of cameras" (page 14).

### Registering programs for internal timer recording

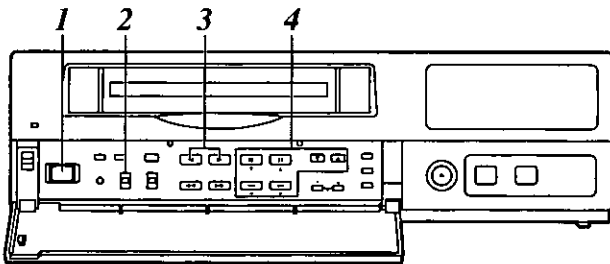

- 1 Set the POWER switch to ON, and insert the cassette tape.
- 2 Set the PROGRAM switch to the MENU position. The setting menu screen now appears on the TV monitor.
- 3 Press the PAGE (+) or PAGE (-) button to display the P8 PROGRAM TIMER screen. The flashing items are ones that can be set.

[PROGRAM TIMER]				P8
(TIMER)	START	END	REC-TYPE	
PGM1	0:00	0:00	RT0 ( OFF*16)	
PGM2	0:00	0:00	RT0 ( OFF*16)	
PGM3	0:00	0:00	RT0 ( OFF*16)	
PGM4	0:00	0:00	RT0 ( OFF*16)	
PGM5	0:00	0:00	RT0 ( OFF*16)	
PGM6	0:00	0:00	RT0 ( OFF*16)	
PGM7	0:00	0:00	RT0 ( OFF*16)	
PGM8	0:00	0:00	RT0 ( OFF*16)	
[INTERNAL WEEKLY TIMER]				
(SUN MON TUE WED THU FRI SAT DLY)				
*** **				
*** **				

**(TIMER)**  
Register the programs (PGM1-PGM8) in this column when using the internal timer to record them.  
**START**  
The recording start times are set in this column.  
**END**  
The recording end times are set in this column.  
**REC-TYPE**  
The recording type (RT0 to RT7) are set in this column.

- 4 Take the following steps to set the timer recording mode.
  - Use the (▼), (▲), (◀) and (▶) SHIFT buttons to move the flashing part to the item whose setting is to be changed.
  - Press the (+) and (-) SET buttons, and change the setting.

# Useful functions

## Weekly timer

This function is used to record for the programmed duration every week at the same time on the same day.

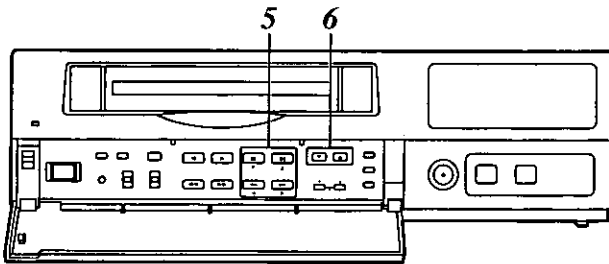

**5** Use the (▼), (▲), (◀) and (▶) SHIFT buttons to move the flashing part to the day-of-the-week (SUN through SAT) item on the INTERNAL WEEKLY TIMER screen.

**6** Press the (+) and (-) SET buttons, and set the programs (PGM1-PGM8) registered on the PROGRAM TIMER screen for the days of the week concerned.

- Two programs each—one on the top line and the other on the bottom—can be set for each day of the week.  
Leave “\*\*\*” unchanged where no programs are to be set.
- When programmed time zone overlap on the same day, the program on the top line takes precedence.

## Daily timer

This function is used to record for the programmed duration at the same time every day.

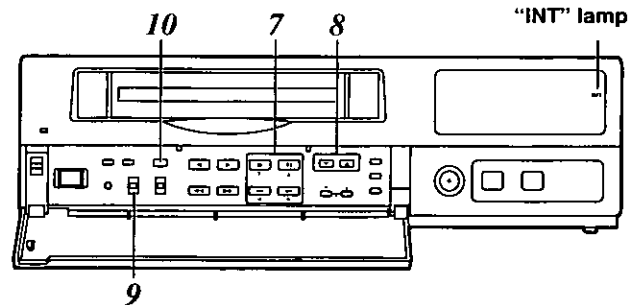

**7** Use the (▼), (▲), (◀) and (▶) SHIFT buttons to move the flashing part to the DLY item.

**8** As with the weekly timer function, press the (+) and (-) SET buttons, and set the programs (PGM1-PGM8) registered on the PROGRAM TIMER screen.

**9** Upon completion of the settings, set the PROGRAM switch to the OFF position.  
The setting menu screen is cleared from the TV monitor, and the normal mode is restored.

**10** Press the TIMER MODE button on the front panel and set it to the internal timer recording mode (the “INT” lamp lights on the display tube).

### <Notes>

- If the cassette tape has not been inserted or its accidental erasure prevention tab has been broken out, the buzzer will sound, and the INT lamp will flash.
- To release the internal timer recording mode, press the TIMER MODE button and turn off the INT lamp on the display tube.

### <Note>

If the time zone programmed using the daily timer overlaps the time zone programmed using the weekly timer, the weekly timer will take precedence.

# Useful functions

## Free-set timer

Recording is initiated for the programmed duration on the date which has been set.

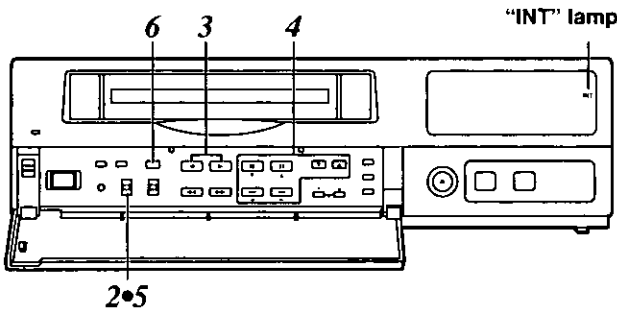

- 1 Finish setting the weekly timer and daily timer.
- 2 Set the PROGRAM switch to the MENU position. The setting menu screen now appears on the TV monitor.
- 3 Press the PAGE (+) or PAGE (-) button to display the P9 FREE SET TIMER screen. The flashing items are ones that can be set.

[FREE SET TIMER]				P9
	MONTH	DAY	SET	
1)	**	-	**	*****
2)	**	-	**	*****
3)	**	-	**	*****
4)	**	-	**	*****
5)	**	-	**	*****
6)	**	-	**	*****
7)	**	-	**	*****
8)	**	-	**	*****
9)	**	-	**	*****
10)	**	-	**	*****
11)	**	-	**	*****
12)	**	-	**	*****

### MONTH

Set the month (1-12, \*\*) of the date concerned in this column.

Set "\*" if the month is not going to be registered.

"\*\*-\*-\*-\*\*\*\*\*" appears for MONTH, DAY and SET.

### DAY

Set the day (1-31) of the date concerned in this column.

### SET

Select the program which was set for the weekly timer.

SUN-SAT, P\_OFF (POWER OFF mode throughout the day)

### <Note>

Twelve days' worth of dates can be set for the free-set timer.

- 4 Take the following steps to set the timer recording mode.

- Use the (▼), (▲), (◀) and (▶) SHIFT buttons to move the flashing part to the item whose setting is to be changed.
- Press the (+) and (-) SET buttons, and change the setting.

- 5 Upon completion of the settings, set the PROGRAM switch to the OFF position.

The setting menu screen is cleared from the TV monitor, and the normal mode is restored.

- 6 Press the TIMER MODE button on the front panel and set it to the internal timer recording mode (the "INT" lamp lights on the display tube).

When the free-set timer is executed, "\*" will appear on the right of the free-set timer number.

### <Notes>

- If the cassette tape has not been inserted or its accidental erasure prevention tab has been broken out, the buzzer will sound, and the INT lamp will flash. The buzzer will sound and the INT lamp will flash also when the date/time or the program timer has not been set.
- To release the internal timer recording mode, press the TIMER MODE button to turn off the INT lamp on the display tube.

[FREE SET TIMER]				P9
	MONTH	DAY	SET	
1) *	5	-	3	SUN
1) *	5	-	4	SUN
1) *	5	-	5	SUN
4)	**	-	**	*****
5)	**	-	**	*****
6)	**	-	**	*****
7)	**	-	**	*****
8)	**	-	**	*****
9)	**	-	**	*****
10)	**	-	**	*****
11)	**	-	**	*****
12)	**	-	**	*****

### <Note>

If the time zone programmed using the free-set timer overlaps the time zone programmed using the weekly timer, the free-set timer takes precedence.

# Useful functions

## Example of some internal timer recording programs

[PROGRAM TIMER]				P8
(TIMER)	START	END	REC-TYPE	
PGM1	9:00	17:00	RT1 ( 18H*04)	
PGM2	9:00	9:00	RT3 ( 48H*02)	
PGM3	10:00	12:00	RT2 ( 9H*06)	
PGM4	0:00	0:00	RT0 ( OFF*16)	
PGM5	23:00	6:00	RT4 ( 72H*04)	
PGM6	10:00	11:00	RT0 ( OFF*16)	
PGM7	5:00	6:00	RT7 ( 120H*01)	
PGM8	8:00	12:00	RT6 ( 24H*16)	

  

[INTERNAL WEEKLY TIMER]							
(SUN)	MON	TUE	WED	THU	FRI	SAT	DLY
PGM1	PGM2	***	PGM1	PGM6	PGM5	***	PGM8
PGM3	***	***	***	***	***	PGM7	***

### ■ Recording on Sunday

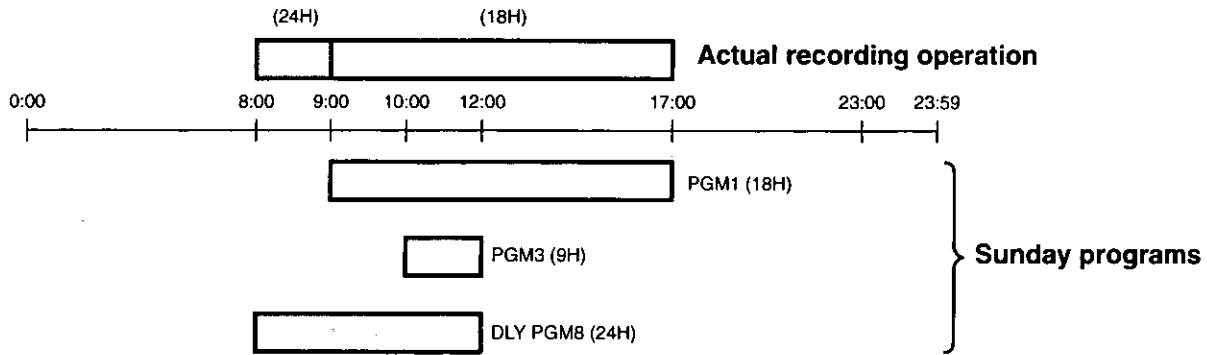

### ■ Recording on Monday

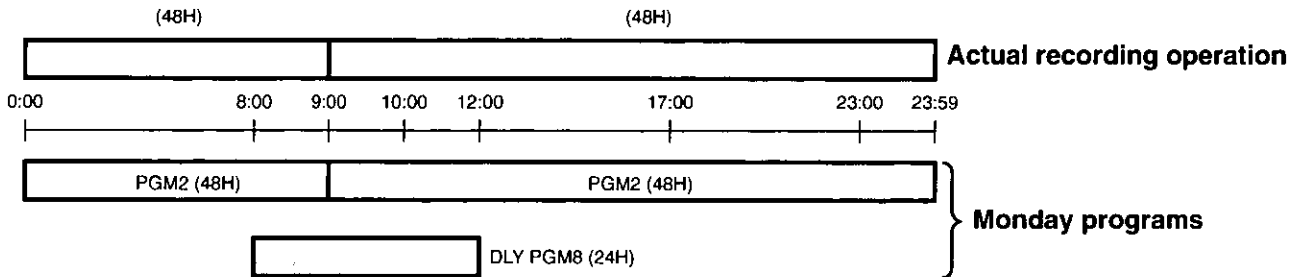

### ■ Recording on Friday

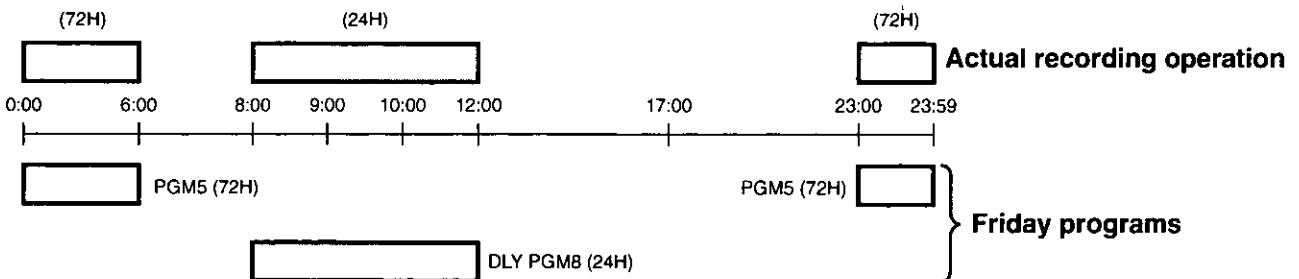



# Useful functions

## External timer recording

Using an external timer, recording can be started and ended at any time which has been set.

### <Note>

Before setting the external timer recording, complete the connections as well as the steps for "Setting the date and time" (page 11) and "Setting the recording time mode and number of cameras" (page 14).

**When using an external timer connected to the unit's power cord (control exercised at the primary power supply side)**

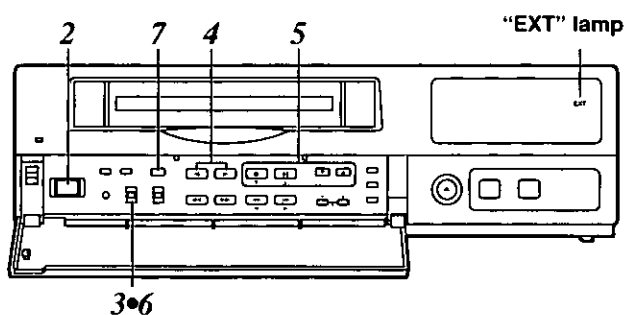

**1** Connect the external timer to the unit's power cord, and turn on its power.

**2** Set the unit's POWER switch to ON, and insert the cassette tape.

**3** Set the PROGRAM switch to the MENU position. The setting menu screen now appears on the TV monitor.

**4** Press the PAGE (+) or PAGE (-) button to display the P7 TERMINAL INPUT SELECT screen. The flashing items are ones that can be set.

[TERMINAL INPUT SELECT]	P7
EXT TIMER IN	OFF
TIME ADJUST IN	9:00
[TERMINAL OUTPUT SELECT]	
ALARM/SENSOR OUT	CONTINUE
ERROR WARN/REC OUT	WARNING
EXT TIMER OUT	START 0:00
	END 0:00
[VIDEO OUT SEQUENCE]	
SW INTERVAL	2s
BYPASS CAMERA	OFF
BLACK MATTE	OFF
LL CAMERA	OFF
[EXT SWITCHER]	
MODE	VIDEO OUT

**5** Use the (▼) and (▲) SHIFT buttons to move the flashing part to the EXT TIMER IN item, and press the (+) and (-) SET buttons to select OFF as the item's setting.

**6** Upon completion of the settings, set the PROGRAM switch to the OFF position. The setting menu screen is cleared from the TV monitor, and the normal mode is restored.

**7** Press the TIMER MODE button on the front panel and set it to the external timer recording mode (the "EXT" lamp lights on the display tube).

### <Notes>

- If the cassette tape has not been inserted or its accidental erasure prevention tab has been broken out, the buzzer will sound, and the EXT lamp will flash.
- To release the external timer recording mode, press the TIMER MODE button to turn off the EXT lamp on the display tube.

**8** Set the external timer. Recording will start automatically when the unit's power is turned on by the operation of the external timer.

### <Note>

While the unit's power is not turned on in the external timer recording mode, sensor recording will not be performed even if an alarm signal is input.

# Useful functions

When using an external timer connected to the terminal section on the unit's rear panel (control exercised at the EXT TIMER connector)

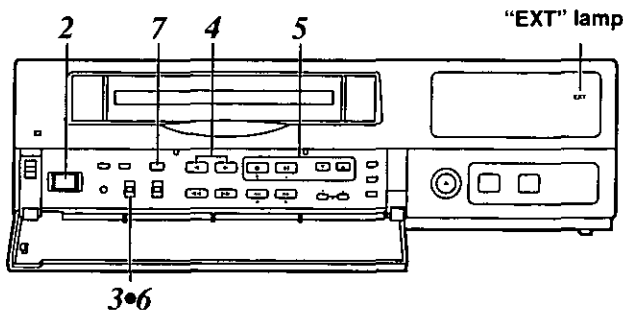

- 1 Connect the external timer to the terminal section on the unit's rear panel, and turn on its power.
- 2 Set the unit's POWER switch to ON, and insert the cassette tape.
- 3 Set the PROGRAM switch to the MENU position. The setting menu screen now appears on the TV monitor.
- 4 Press the PAGE (+) or PAGE (-) button to display the P7 TERMINAL INPUT SELECT screen. The flashing items are ones that can be set.

[TERMINAL INPUT SELECT]		P7
EXT TIMER IN	OFF	
TIME ADJUST IN	9:00	
[TERMINAL OUTPUT SELECT]		
ALARM/SENSOR OUT	CONTINUE	
ERROR WARN/REC OUT	WARNING	
EXT TIMER OUT	START 0:00	
	END 0:00	
[VIDEO OUT SEQUENCE]		
SW INTERVAL	2s	
BYPASS CAMERA	OFF	
BLACK MATTE	OFF	
LL CAMERA	OFF	
[EXT SWITCHER]		
MODE	VIDEO OUT	

- 5 Use the (▼) and (▲) SHIFT buttons to move the flashing part to the EXT TIMER IN item, and press the (+) and (-) SET buttons to select ON as the item's setting.
- 6 Upon completion of the settings, set the PROGRAM switch to the OFF position. The setting menu screen is cleared from the TV monitor, and the normal mode is restored.

- 7 Press the TIMER MODE button on the front panel and set it to the external timer recording mode (the "EXT" lamp lights on the display tube). The power is automatically turned off, and the unit waits for the control signal to be sent from the external timer.

**<Notes>**

- If the cassette tape has not been inserted or its accidental erasure prevention tab has been broken out, the buzzer will sound, and the EXT lamp will flash.
- To release the external timer recording mode, press the TIMER MODE button to turn off the EXT lamp on the display tube.

- 8 Set the external timer. Recording will start automatically when the unit's power is turned on by the control signal sent from the external timer.

# Terminal connections

As shown below, firmly twist the end of the cord which is to be connected to the terminal section.

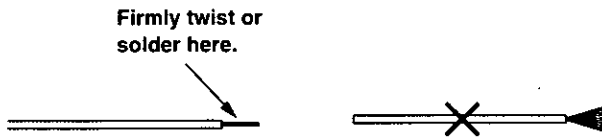

**Solid wire** : 0.4 to 1.2 mm diameter  
**Twisted wire** : 0.3 to 1.25 mm  
 (The diameter of the strands must be 0.18 mm or more.)

 When connecting or disconnecting the cord, press this part down using a regular screwdriver.

- Failure to twist the end of the cord firmly can cause short-circuiting.

## Alarm recording connections

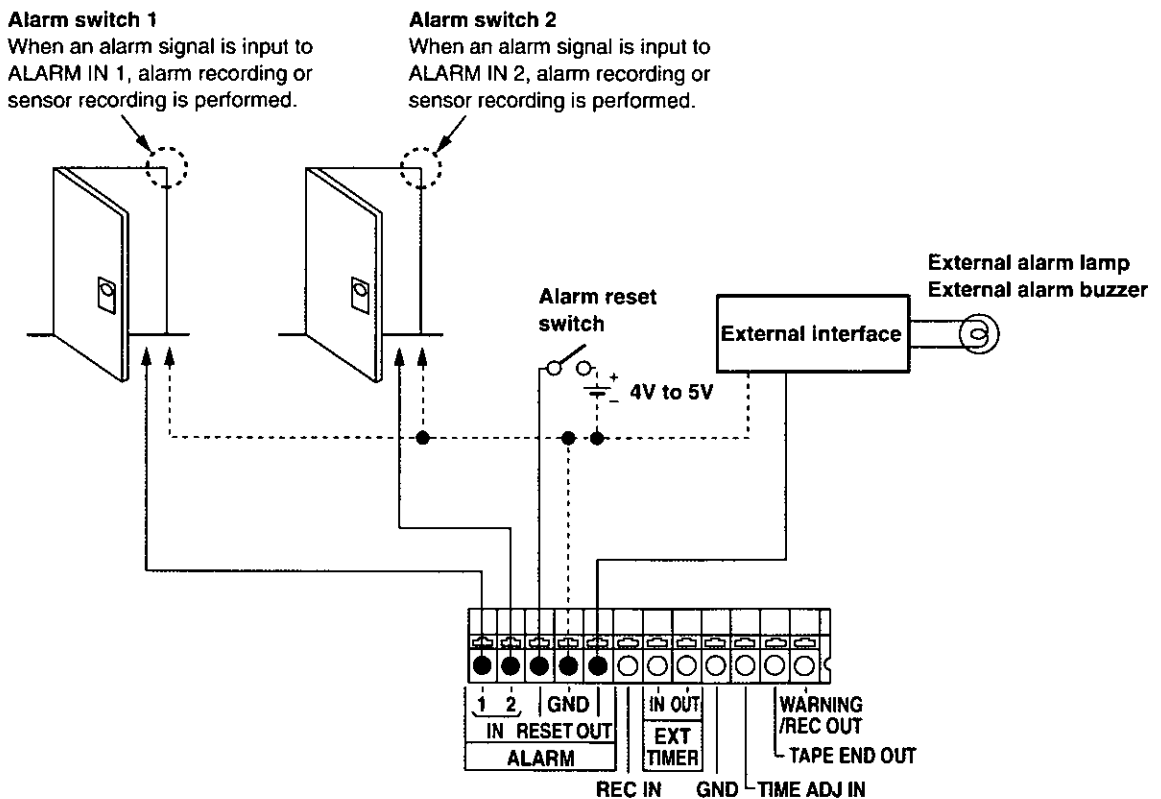

- When alarm recording has been set for MODE on the menu screen shown on P4 ALARM/SENSOR REC, alarm recording is started when the alarm switch is set to ON.
- Alarm recording is released when the alarm reset switch is set to ON.

# Terminal connections

## Tape-end output connections

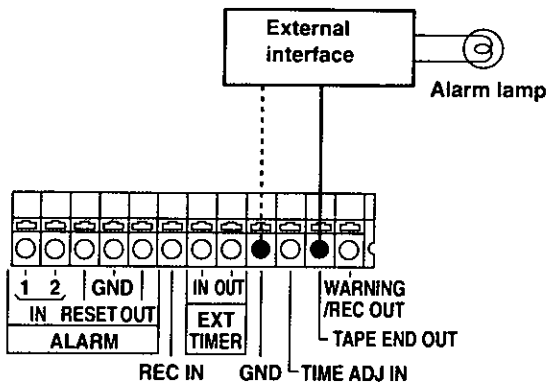

When the cassette tape comes to its end during recording, the alarm device which has been installed externally is triggered.

## External timer input connections

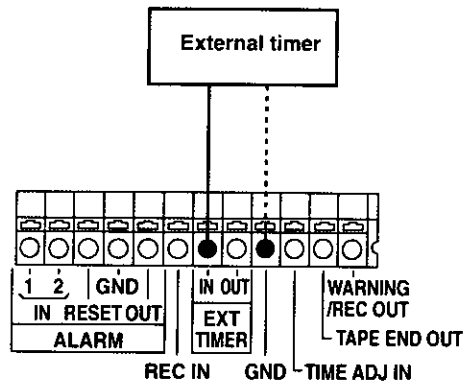

An external timer can be used for recording.

- Select ON for EXT TIMER IN on the menu screen shown on P7 TERMINAL INPUT SELECT, and set the front panel TIMER MODE button to EXT (external timer recording).

The unit's power is turned off, and recording is started by the signal from the external timer.

## Auto OFF output connections and recording output connections

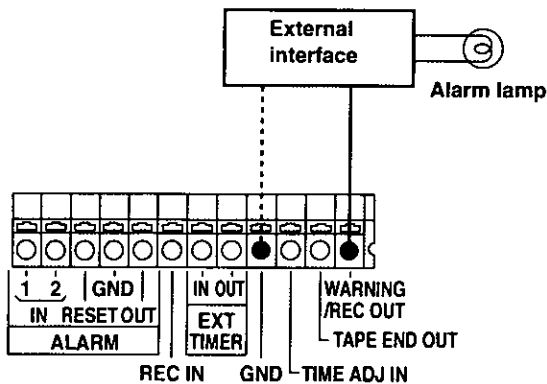

### External timer signal

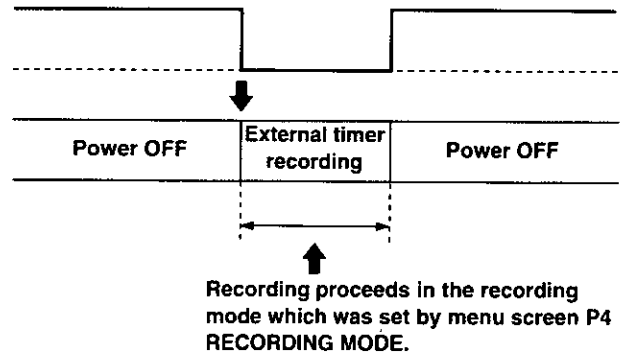

The auto OFF output and recording output connections are the same. Select between them using ERROR WARN/REC OUT on the menu screen shown on P7 TERMINAL OUTPUT SELECT.

### Auto OFF output

When a problem has occurred in the unit, the alarm device which has been installed externally is triggered.

In this case, the error code appears on the display. (See page 102.)

### Recording output

When the unit is set to the recording mode, the alarm device which has been installed externally is triggered.

# Terminal connections

## Time setting connections

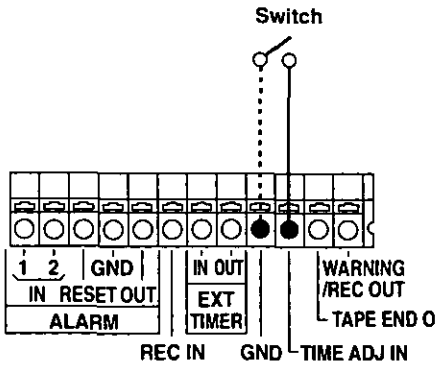

### When setting the unit's time using an external switch

- Using the TIME ADJUST IN item on the menu screen shown on P7 TERMINAL INPUT SELECT, set the time which is to be set when the signal is supplied from the external switch.
- When the external switch is set to ON, the unit is set to the set time.

## External timer input connections

A second time lapse recorder unit can be used as an external timer or the external switch for setting the time.

- Using the EXT TIMER OUT item on the menu screen shown on P7 TERMINAL OUTPUT SELECT, set the start time (START) and end time (END) at which the control signals are to be output.

### When using a second time lapse recorder as an external timer

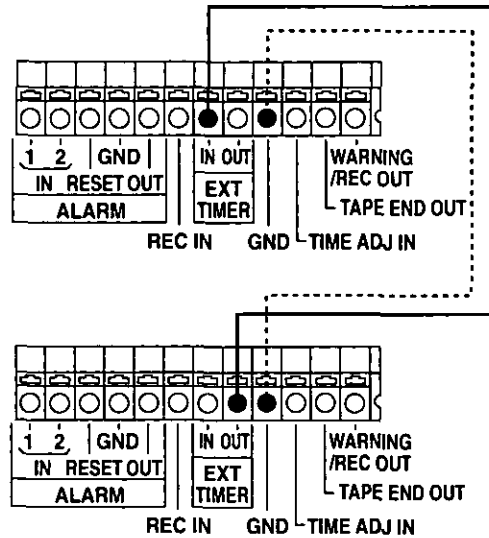

### When using a second time lapse recorder as the external switch for setting the time

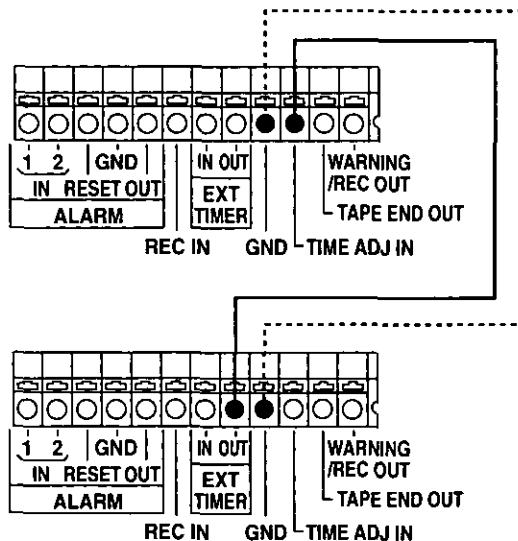

# Terminal signal levels

## External interface preparation specifications

Example of lamp lighted by HIGH signal

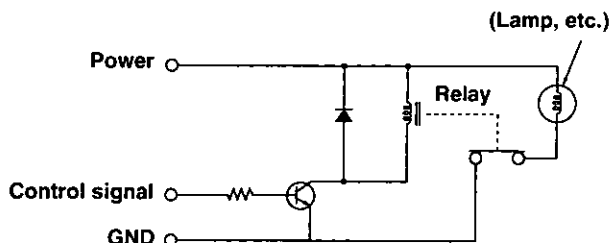

- Use devices with ratings which support the actual operating conditions.

Terminal	Signal level	Remarks	Terminal	Signal level	Remarks
ALARM IN 1/2	 $V_{IH} = 4.0\text{ V to }5.0\text{ V}$ $V_{IL} = 0.0\text{ V to }0.6\text{ V}$ $T \geq 100\text{ ms}$	Ground input	TIME ADJ IN	 $V_{IH} = 4.0\text{ V to }5.0\text{ V}$ $V_{IL} = 0.0\text{ V to }0.6\text{ V}$ $T \geq 100\text{ ms}$	Ground input
ALARM RESET IN	 $V_{IH} = 4.0\text{ V to }5.0\text{ V}$ $V_{IL} = 0.0\text{ V to }0.6\text{ V}$ $T \geq 100\text{ ms}$	High input	TAPE END OUT	 $V_{OH} = 11.0\text{ V to }13.0\text{ V}$ $V_{OL} = 0.0\text{ V to }0.6\text{ V}$ $4.7\text{ k}\Omega$ pull-up resistor (+12V) output	Ground output When REPEAT has been selected as the (TAPE END) MODE setting on the menu screen shown on P5 (VTR MODE SELECT), output time T is 2 seconds. If a setting other than REPEAT is selected, the signal will continue to be output until one of the function buttons is pressed. The signal will continue to be output until one of the function buttons is pressed also when a setting other than OFF has been selected as the LEVEL setting on the menu screen shown on P6 TAPE REMAIN.
ALARM OUT	 $V_{OH} = 11.0\text{ V to }13.0\text{ V}$ $V_{OL} = 0.0\text{ V to }0.6\text{ V}$ $4.7\text{ k}\Omega$ pull-up resistor (+12V) output	Ground output The output format is set using the ALARM/SENSOR OUT item on the menu screen shown on P7 TERMINAL OUTPUT SELECT.	WARNING/R EC OUT	 Open drain output $V_{OL} = 0.0\text{ V to }1.0\text{ V}$ Max. 200 mA drive enabled	Ground output
REC IN	 $V_{IH} = 4.0\text{ V to }5.0\text{ V}$ $V_{IL} = 0.0\text{ V to }0.6\text{ V}$ $T \geq 100\text{ ms}$	Ground input			
EXT TIMER IN	 $V_{IH} = 4.0\text{ V to }5.0\text{ V}$ $V_{IL} = 0.0\text{ V to }0.6\text{ V}$ T: Recording time	Ground input Recording is performed during the $V_{IL}$ input (T).			
EXT TIMER OUT	 $V_{OL} = 0.0\text{ V to }0.6\text{ V}$	Ground output Output time T is set using the EXT TIMER OUT item on the menu screen shown on P7 TERMINAL OUTPUT SELECT.			

# Setting menus

## Setting method

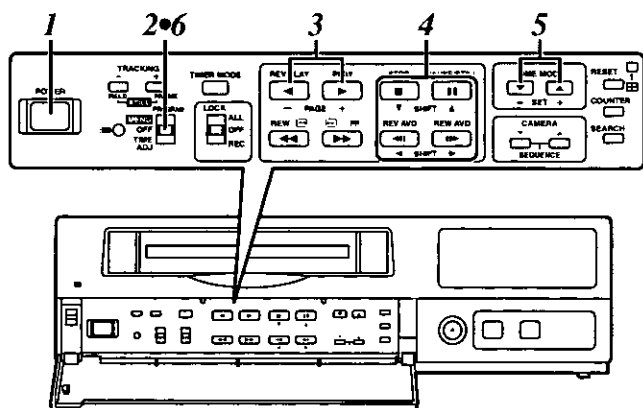

- 1** Set the POWER switch to ON.
- 2** Set the PROGRAM switch to the MENU position.  
The setting menu screen now appears on the TV monitor.
- 3** Press the PAGE (+) or PAGE (-) button to display the setting screen.  
The flashing items are ones that can be set.
- 4** Use the (▼), (▲), (◀) and (▶) SHIFT buttons to move the flashing part to the item whose setting is to be changed.
- 5** Press the (+) and (-) SET buttons to change the setting.
- 6** Upon completion of the settings, set the PROGRAM switch to the OFF position.  
The setting menu screen is cleared from the TV monitor, and the normal mode is restored.

# Setting menus

## Menu page P1

P1
[TIME/DATE PRESET] 2000- 1-01 SAT 00:00:00  [REC LOCK] MODE           OFF [HOUR METER] 00000h

### TIME/DATE PRESET screen

Menu item	Description of function
Year Month Day Day of the week Hours Minutes Seconds	For setting the date and time  

### REC LOCK screen

Menu item	Description of function
MODE	For setting the operation lock mode during recording. <u>ON</u> : During recording, all the buttons and switches with the sole exception of the REC REVIEW button are made non-operational. <u>OFF</u> : Even during recording, all the buttons and switches can be operated.

The underlining indicates the factory mode setting.

### HOUR METER screen

Menu item	Description of function
	For displaying as a number of hours the cumulative recording duration from the time when recording was started.



# Setting menus

## Menu page P2

[DISPLAY]		P2
CHARACTER	WHITE	
POSITION	R-BOTTOM	
TIME SELECT	24HOURS	
DATE	ON	
TIME	ON	
T-MODE	ON	
REC/ALARM	ON	
[REC LOSS INDICATOR]		
VIDEO OUT	CAMERA	
[DAYLIGHT SAVINGS]		
MODE	OFF	
	<WEEK>	<MONTH>
START	1ST-SUN	4 2:00
END	LST-SUN	10 2:00

### DISPLAY screen

Menu item	Description of function
CHARACTER	For setting the type of characters which are displayed on the monitor screen. <u>WHITE</u> : White characters with black borders are displayed. <u>BLACK</u> : Black characters with white borders are displayed.
POSITION	For setting the position where the characters are displayed on the monitor screen. <u>L-UPPER</u> : The characters are displayed at the top left of the screen. <u>R-UPPER</u> : The characters are displayed at the top right of the screen. <u>L-BOTTOM</u> : The characters are displayed at the bottom left of the screen. <u>R-BOTTOM</u> : The characters are displayed at the bottom right of the screen. <u>CENTER</u> : The characters are displayed in the center of the screen.
TIME SELECT	For setting the 12-hour or 24-hour system for the time. <u>24HOURS</u> : The 24-hour system is used to display the time. <u>AM/PM</u> : The 12-hour AM/PM system is used to display the time.
DATE	For setting whether to display the date on the monitor screen. <u>ON</u> : The date is displayed on the monitor screen. <u>OFF</u> : The date is not displayed on the monitor screen.
TIME	For setting whether to display the time on the monitor screen. <u>ON</u> : The time is displayed on the monitor screen. <u>OFF</u> : The time is not displayed on the monitor screen.
T-MODE	For setting whether to display the recording time mode and camera number on the monitor screen. <u>ON</u> : The recording time mode and camera number are displayed on the monitor screen. <u>OFF</u> : The recording time mode and camera number are not displayed on the monitor screen.
REC/ALARM	For setting whether to display the alarm number and operation mode on the monitor screen. <u>ON</u> : The alarm number and operation mode are displayed on the monitor screen. <u>OFF</u> : The alarm number and operation mode are not displayed on the monitor screen.

The underlining indicates the factory mode setting.

### REC LOSS INDICATOR screen

Menu item	Description of function
VIDEO OUT	For setting the video signals to be output to the monitor screen in all modes except the recording mode. <u>CAMERA</u> : Video signals from the camera are output to the monitor screen. <u>BLUE</u> : The blue background signals are output to the monitor screen.

The underlining indicates the factory mode setting.

# Setting menus

## Menu page P2

[DISPLAY]		P2
CHARACTER	WHITE	
POSITION	R-BOTTOM	
TIME SELECT	24HOURS	
DATE	ON	
TIME	ON	
T-MODE	ON	
REC/ALARM	ON	
[REC LOSS INDICATOR]		
VIDEO OUT	CAMERA	
[DAYLIGHT SAVINGS]		
MODE	OFF	
	<WEEK>	<MONTH> <TIME>
START	1ST-SUN	4 2:00
END	LST-SUN	10 2:00

### DAYLIGHT SAVING screen

Menu item	Description of function
MODE	For switching the daylight saving time setting ON or OFF. ON : Daylight saving time is set to ON. OFF: Daylight savings time is set to OFF.
START	For setting the day and time when daylight saving time starts. <WEEK> For setting the week and day of the week when daylight saving time is due to start. 1ST : 1st week 2ND : 2nd week 3RD : 3rd week 4TH : 4th week LST : Last week SUN—SAT Factory mode setting (1ST-SUN) <MONTH> For setting the month at which daylight saving time is due to start. 1—12 Factory mode setting (4) <TIME> For setting the time at which daylight saving time is due to start. The minutes cannot be set. 1:00—22:00 Factory mode setting (2:00)
END	For setting the day and time when daylight savings time ends. <WEEK> For setting the week and day of the week when daylight saving time is due to end. 1ST : 1st week 2ND : 2nd week 3RD : 3rd week 4TH : 4th week LST : Last week SUN—SAT Factory mode setting (LST-SUN) <MONTH> For setting the month at which daylight saving time is due to end. 1—12 Factory mode setting (10) <TIME> For setting the time at which daylight saving time is due to end. The minutes cannot be set. 1:00—22:00 Factory mode setting (2:00)

The underlining indicates the factory mode setting.

# Setting menus

## Menu page P3

[RECORDING T-MODE & CAMERA]		P3																
REC T-	C.	(CAMERA SELECT)																
TYPE	MODE	NO	C1	C3	C5	C7	C9	C11	C13	C15	C2	C4	C6	C8	C10	C12	C14	C16
RT0	OFF*	16	Y	Y	Y	Y	Y	Y	Y	Y	Y	Y	Y	Y	Y	Y	Y	Y
RT1	OFF*	16	Y	Y	Y	Y	Y	Y	Y	Y	Y	Y	Y	Y	Y	Y	Y	Y
RT2	OFF*	16	Y	Y	Y	Y	Y	Y	Y	Y	Y	Y	Y	Y	Y	Y	Y	Y
RT3	OFF*	16	Y	Y	Y	Y	Y	Y	Y	Y	Y	Y	Y	Y	Y	Y	Y	Y
RT4	OFF*	16	Y	Y	Y	Y	Y	Y	Y	Y	Y	Y	Y	Y	Y	Y	Y	Y
RT5	OFF*	16	Y	Y	Y	Y	Y	Y	Y	Y	Y	Y	Y	Y	Y	Y	Y	Y
RT6	OFF*	16	Y	Y	Y	Y	Y	Y	Y	Y	Y	Y	Y	Y	Y	Y	Y	Y
RT7	OFF*	01	C1															

Y: YES N: NO

### RECORDING T-MODE & CAMERA screen

Menu item	Description of function
REC TYPE	The combination of recording time mode and number of cameras is registered as the recording type. RT0—RT7 <b>&lt;Notes&gt;</b> • The recording time mode (T-MODE) for RT0 is fixed at OFF. • The number of cameras (CAMERA SELECT) for RT7 is fixed at 1 (01).
T-MODE	For setting the recording time mode. OFF, 3H, 9H, 12H, 18H, 24H, 48H, 72H, 96H, 120H, 180H, 240H, 360H, 480H, 960H <b>&lt;Note&gt;</b> When OFF is selected as the recording time mode, the mode will accord with the setting of the TIME MODE button (on the sub panel).
C. NO	The number of cameras set for the CAMERA SELECT item appears in this column.
CAMERA SELECT	For selecting Y (yes) or N (no) to determine whether or not a particular camera number is to be used. Y : The camera will be used. N : The camera will not be used. <b>&lt;Note&gt;</b> It is not possible to select N (NO) for all the cameras.

## Menu page P4

[RECORDING MODE]		P4
FIELD/FRAME	FIELD	
PICTURE QUALITY	HIGH	
REC-TYPE	RT0 ( OFF*16)	
[ALARM/SENSOR REC]		
MODE	OFF	
FIELD/FRAME	FIELD	
PICTURE QUALITY	HIGH	
DURATION	0.5min	
BUZZER	OFF	
REPEAT	OFF	
GROUP ALARM1	RT0 ( OFF*16)	
GROUP ALARM2	RT0 ( OFF*16)	

### RECORDING MODE screen

Menu item	Description of function
FIELD/FRAME	For selecting field recording or frame recording. <u>FIELD</u> : Field recording is initiated. FRAME: Frame recording is initiated.
PICTURE QUALITY	For setting the quality of the pictures to be recorded. <u>HIGH</u> : The pictures are recorded at a high quality. NORMAL : The pictures are recorded at the standard quality.
REC-TYPE	For selecting the recording type from what has been registered on menu page P3. <u>RT0—RT7</u>

The underlining indicates the factory mode setting.

#### <Note>

When RT7 has been selected as the REC-TYPE item setting, the FIELD/FRAME item setting is overridden and frame recording is forcibly initiated.

# Setting menus

## Menu page P4

[RECORDING MODE]		P4
FIELD/FRAME	FIELD	
PICTURE QUALITY	HIGH	
REC-TYPE	RT0 ( OFF:*16)	
[ALARM/SENSOR REC]		
MODE	OFF	
FIELD/FRAME	FIELD	
PICTURE QUALITY	HIGH	
DURATION	0.5min	
BUZZER	OFF	
REPEAT	OFF	
GROUP ALARM1	RT0 ( OFF:*16)	
GROUP ALARM2	RT0 ( OFF:*16)	

### ALARM/SENSOR REC screen

Menu item	Description of function
MODE	For setting what recording operation is to be performed when an alarm signal has been input. <u>OFF</u> : The unit operates normally regardless of whether an alarm signal is input. ALARM/SENSOR: Alarm recording or sensor recording is performed. ALARM : Alarm recording is performed. SENSOR: Sensor recording is performed.
FIELD/FRAME	For selecting field recording or frame recording when alarm recording or sensor recording is to be performed. <u>FIELD</u> : Field recording is performed. FRAME : Frame recording is performed.
PICTURE QUALITY	For setting the picture quality when alarm recording or sensor recording is to be performed. <u>HIGH</u> : Recording is performed at a high quality. NORMAL : Recording is performed at the standard quality. NO CHANGE : Recording is performed at the current quality setting.
DURATION	For setting the length of the alarm recording or sensor recording. <u>0.5min</u> : Recording for 30 seconds. 1.0min : Recording for 1 minute. 1.5min : Recording for 1 minute and 30 seconds. 2.0min : Recording for 2 minutes. 3.0min : Recording for 3 minutes. 5.0min : Recording for 5 minutes. 10min : Recording for 10 minutes. CONTINUE: Recording continues until the tape-end. MANUAL : Recording is performed only while an alarm signal is input.
BUZZER	For setting whether the buzzer is to sound during alarm recording or sensor recording. <u>ON</u> : The buzzer sounds. It stops when any one of the function buttons is pressed. OFF: The buzzer does not sound.
REPEAT	For setting whether alarm recording or sensor recording is to be performed if an alarm signal has been input while repeat recording is underway or while the tape is being rewind. <u>OFF</u> : Alarm recording or sensor recording is not performed when the tape is being rewind. If an alarm signal has been input even when tape rewinding is completed, alarm recording or sensor recording is performed. <u>ON</u> : Alarm recording or sensor recording (or both) is forcibly performed even while the tape is being rewind.
GROUP ALARM1	For selecting the recording type from what was registered on menu page P3 when alarm recording or sensor recording is to be performed if an alarm signal is input to ALARM IN 1. <u>RT0—RT7</u>
GROUP ALARM2	For selecting the recording type from what was registered on menu page P3 when alarm recording or sensor recording is to be performed if an alarm signal is input to ALARM IN 2. <u>RT0—RT7</u>

The underlining indicates the factory mode setting.

#### <Note>

When RT7 has been selected as the REC-TYPE item setting, the FIELD/FRAME item setting is overridden and frame recording is forcibly initiated.

# Setting menus

## Menu page P5

[VTR MODE SELECT]		P5
(TAPE IN)	STOP	
(TAPE END)		
MODE	STOP	
ALARM IN	STOP	
(EJECT OPERATION)	EJECT	
(VIDEO MODE)	AUTO	

### VTR MODE SELECT screen

Menu item	Description of function
(TAPE IN)	For setting the operation mode that is to be established when the cassette tape has been inserted into the unit. <u>STOP</u> : The unit is set to the stop mode. REC : Recording is performed. REW ↗ REC: The tape is first rewound to its start, and then recording is performed.
(TAPE END) MODE	For setting the operation mode that is to be established when the tape-end position is reached. <u>STOP</u> : The unit is set to the stop mode at the tape-end position. BUZZER: The unit is set to the stop mode at the tape-end position, and the buzzer sounds. REW : The tape is rewound to its start position, and then the unit is set to the stop mode. REPEAT: The tape is rewound to its start position, and recording is performed. EJECT : The tape is ejected at the tape-end position.
(TAPE END) ALARM IN	For setting the operation mode that is to be established when the tape-end position is reached after alarm recording or sensor recording has been performed. <u>STOP</u> : The unit is set to the stop mode at the tape-end position. The tape is ejected when EJECT has been selected as the (TAPE END) MODE setting. CONTINUE: The unit continues with the operation selected as the (TAPE END) MODE setting regardless of whether an alarm signal is input.
(EJECT OPERATION)	For setting the EJECT button operation. <u>EJECT</u> : The tape is ejected by operating the button. REW ↗ EJECT: The tape is ejected after it has been rewound to its start position by operating the button.
(VIDEO MODE)	For setting the color of the video output signal. <u>AUTO</u> : The color is automatically switched in accordance with the input signal. B/W : The signal is forcibly set to monochrome.

The underlining indicates the factory mode setting.

# Setting menus

## Menu page P6

[TAPE REMAIN]		P6
LEVEL	OFF	
BUZZER	OFF	
[REC REVIEW]		
AUTO	OFF	
ERROR BUZZER	OFF	
[ERROR WARN BUZZER]		
MODE	OFF	
[REC WARNING]		
REC LOSS BUZZER	OFF	

### TAPE REMAIN screen

Menu item	Description of function
LEVEL	For setting at what point REMAIN is to flash on the display tube and the remaining tape warning is to be displayed when the tape-end position is about to be reached. (When using a 120-minute tape) The REMAIN flashing is released when any button is pressed. <u>OFF</u> : The remaining tape warning is not displayed. 2% : The warning is displayed when the remaining tape amount is less than approximately 2%. 10%: The warning is displayed when the remaining tape amount is less than approximately 10%. 20%: The warning is displayed when the remaining tape amount is less than approximately 20%. 30%: The warning is displayed when the remaining tape amount is less than approximately 30%.
BUZZER	For setting whether the buzzer is to sound when the tape-end position is about to be reached. The buzzer is stopped when any button is pressed. ON : The buzzer sounds at the position which was set for the LEVEL item. <u>OFF</u> : The buzzer does not sound.

The underlining indicates the factory mode setting.

### REC REVIEW screen

Menu item	Description of function
AUTO	For setting automatic REC REVIEW. (This function plays back the recording after recording for a specific time in order to detect whether the proper video level is being maintained during recording.) ON : REC REVIEW is performed automatically. If the level detected is found to be unacceptable, the tape is loaded and unloaded three times, and REC REVIEW is automatically performed again. If it is still unacceptable even after this, recording is performed. <u>OFF</u> : REC REVIEW is not performed automatically.
ERROR BUZZER	For setting whether the buzzer is to sound when it is discovered by REC REVIEW that the proper video level was not maintained. ON : The buzzer sounds. It is stopped when any button is pressed. <u>OFF</u> : The buzzer does not sound.

The underlining indicates the factory mode setting.

# Setting menus

## Menu page P6

[TAPE REMAIN] LEVEL	OFF	P6
BUZZER	OFF	
[REC REVIEW] AUTO	OFF	
ERROR BUZZER	OFF	
[ERROR WARN BUZZER] MODE	OFF	
[REC WARNING]	OFF	
REC LOSS BUZZER	OFF	

### ERROR WARN BUZZER screen

Menu item	Description of function
<u>MODE</u>	For setting whether the buzzer is to sound when a problem occurs in the unit and the power is automatically turned off. ON : The buzzer sounds. <u>OFF</u> : The buzzer does not sound.

The underlining indicates the factory mode setting.

### REC WARNING screen

Menu item	Description of function
<u>REC LOSS BUZZER</u>	For setting whether the buzzer is to sound when the unit is kept in the stop mode for a prolonged period of time. The buzzer is stopped when any button is pressed. <u>OFF</u> : The buzzer does not sound. 5min : The buzzer sound when the unit is kept in the stop mode for 5 minutes. 10min: The buzzer sound when the unit is kept in the stop mode for 10 minutes. 20min: The buzzer sound when the unit is kept in the stop mode for 20 minutes. 30min: The buzzer sound when the unit is kept in the stop mode for 30 minutes.

The underlining indicates the factory mode setting.

# Setting menus

## Menu page P7

[TERMINAL INPUT SELECT]	P7
EXT TIMER IN	OFF
TIME ADJUST IN	9:00
[TERMINAL OUTPUT SELECT]	
ALARM/SENSOR OUT	CONTINUE
ERROR WARN/REC OUT	WARNING
EXT TIMER OUT	START 0:00
	END 0:00
[VIDEO OUT SEQUENCE]	
SW INTERVAL	2s
BYPASS CAMERA	OFF
BLACK MATTE	OFF
LL CAMERA	OFF
[EXT SWITCHER]	
MODE	VIDEO OUT

### TERMINAL INPUT SELECT screen

Menu item	Description of function
EXT TIMER IN	For setting whether the signals from the external timer connected to the rear panel terminal section are to be acknowledged in the external timer recording mode. <u>ON</u> : The signals from the external timer are acknowledged. <u>OFF</u> : The signals from the external timer are not acknowledged. Select OFF when using an external timer which has been connected to the unit's power cord.
TIME ADJUST IN	For setting the time to be set when signals have been input from the component connected to TIME ADJ IN on the rear panel terminal section. 00:00 to 23:59, RESET Factory setting mode (9:00) <Notes> <ul style="list-style-type: none"> <li>• The seconds are fixed at "00."</li> <li>• When signals are input after RESET has been set, the minutes of the time are set to "00."                The minute setting is returned to "00" while it is between 0 and 15 minutes when signals are input.                The hour is carried up and the minutes are set to "00" while the setting is between 45 and 59 minutes when signals are input.</li> </ul>

The underlining indicates the factory mode setting.

### TERMINAL OUTPUT SELECT screen

Menu item	Description of function
ALARM/SENSOR OUT	For setting how the control signals are to be output to the component connected to ALARM OUT on the rear panel terminal section when alarm recording or sensor recording is performed. <u>CONTINUE</u> : The control signals continue to be output even after recording. ALARM REC : The control signals are output only during alarm recording or sensor recording.
ERROR WARN/REC OUT	For setting how the control signals are to be output to the component connected to WARNING/REC OUT on the rear panel terminal section when a problem has occurred in the unit. <u>WARNING</u> : The control signals continue to be output. REC : The control signals are output only during recording.
EXT TIMER OUT	For setting the START time and END time at which the control signals are to be output to the component connected to EXT TIMER OUT on the rear panel terminal section. <u>0:00—23:59</u> <Note> The control signals are not output when the same time has been set for both the START and END times.

The underlining indicates the factory mode setting.



# Setting menus

## Menu page P7

[TERMINAL INPUT SELECT]	P7
EXT TIMER IN	OFF
TIME ADJUST IN	9:00
[TERMINAL OUTPUT SELECT]	
ALARM/SENSOR OUT	CONTINUE
ERROR WARN/REC OUT	WARNING
EXT TIMER OUT	START 0:00
	END 0:00
[VIDEO OUT SEQUENCE]	
SW INTERVAL	2s
BYPASS CAMERA	OFF
BLACK MATTE	OFF
LL CAMERA	OFF
[EXT SWITCHER]	
MODE	VIDEO OUT

### VIDEO OUT SEQUENCE screen

Menu item	Description of function
SW INTERVAL	For setting the timing at which the video signals which are supplied from the camera and which are to be output from the rear panel VIDEO OUT connector are to be switched. 1s (1 sec.), 1.5s (1.5 sec.), <u>2s</u> (2 sec.), 2.5s (2.5 sec.), 3s (3 sec.), 4s (4 sec.), 5s (5 sec.), 10s (10 sec.)
BYPASS CAMERA	For setting whether the video signals of a specific camera are not to be output from the VIDEO OUT connector. <u>OFF</u> : The video signals of all the cameras are output. C1—C16: The video signals of the specified camera/s are not output.
BLACK MATTE	For setting the processing of the black burst signal when switching the video signals which are output from the video signal output connector. <u>ON</u> : The black burst signal is instantly output when the video signal is switched. <u>OFF</u> : The black burst signal is not output when the video signal is switched.
LL CAMERA	For setting the synchronization system of the connected cameras. <u>ON</u> : Line-lock type of cameras <u>OFF</u> : Internal sync and external sync type of cameras <Notes> ● Use of the internal sync type of cameras is recommended. ● Select the ON setting when even one line-lock type of camera is used.

The underlining indicates the factory mode setting.

### EXT SWITCHER screen

Menu item	Description of function
MODE	For switching the function of the EXT SW IN/VIDEO OUT connector on the rear panel. <u>VIDEO OUT</u> : The connector is used to output the video signals. EXT SW IN : The connector is used to input the signals of the external sequential switcher.

The underlining indicates the factory mode setting.

# Setting menus

## Menu page P8

[PROGRAM TIMER] P8			
(TIMER)	START	END	REC-TYPE
PGM1	0:00	0:00	RT0 ( OFF*16)
PGM2	0:00	0:00	RT0 ( OFF*16)
PGM3	0:00	0:00	RT0 ( OFF*16)
PGM4	0:00	0:00	RT0 ( OFF*16)
PGM5	0:00	0:00	RT0 ( OFF*16)
PGM6	0:00	0:00	RT0 ( OFF*16)
PGM7	0:00	0:00	RT0 ( OFF*16)
PGM8	0:00	0:00	RT0 ( OFF*16)

[INTERNAL WEEKLY TIMER]						
(SUN	MON	TUE	WED	THU	FRI	SAT DLY)
***	***	***	***	***	***	***
***	***	***	***	***	***	***

### PROGRAM TIMER screen

Menu item	Description of function
(TIMER)	Three items—the recording start time, recording end time and the recording type selected for REC TYPE on menu page P3—are combined and registered as the program for recording to be performed using the unit's internal timer. PGM1—PGM8
START	For setting the recording start time for recording to be performed using the unit's internal timer. <u>0:00—23:59</u>
END	For setting the recording end time for recording to be performed using the unit's internal timer. <u>0:00—23:59</u>
REC-TYPE	For setting the recording type for recording to be performed using the unit's internal timer. <u>RT0—RT7</u>

The underlining indicates the factory mode setting.

### INTERNAL WEEKLY TIMER screen

Menu item	Description of function
	The programs (max. 2) registered for (TIMER) on the PROGRAM TIMER screen are set for the days of the week. Select DLY when recording every day using a particular program. <u>***</u> , PGM1—PGM8 <Notes> <ul style="list-style-type: none"> <li>● Set "<u>***</u>" if no programs are going to be registered.</li> <li>● The program registered on the top line takes precedence.</li> </ul>

The underlining indicates the factory mode setting.

# Setting menus

## Menu page P9

[FREE SET TIMER]				P9
	MONTH	DAY	SET	
1)	**	-	**	*****
2)	**	-	**	*****
3)	**	-	**	*****
4)	**	-	**	*****
5)	**	-	**	*****
6)	**	-	**	*****
7)	**	-	**	*****
8)	**	-	**	*****
9)	**	-	**	*****
10)	**	-	**	*****
11)	**	-	**	*****
12)	**	-	**	*****

### FREE SET TIMER screen

On this screen, the programs registered for (TIMER) on the PROGRAM TIMER screen and the programs of the days of the week which were set on the INTERNAL WEEKLY TIMER screen are set for the desired dates (12 days' worth).

Menu item	Description of function
MONTH	For setting the month of the desired date. 1—12, ** <Note> Set "*" if the month is not going to be registered. "*-*-*-*" appears for MONTH, DAY and SET.
DAY	For setting the day of the desired date. 1—31
SET	For selecting the program which was set using the weekly timer. SUN—SAT, P_OFF (POWER OFF mode throughout the day)

The underlining indicates the factory mode setting.

# Setting menus

## Menu page P10

[RS-232C PARAMETERS]	P10
BIT LENGTH	7bit
STOP BIT	STOP-1
PARITY	ODD
BAUD RATE	9600
[USER ID REC]	
00000000	

### RS-232C PARAMETERS screen

The RS-232C parameters are set on this screen.

Menu item	Description of function
BIT LENGTH	For setting the bit length. <u>7bit</u> , 8bit
STOP BIT	For setting the stop bit. <u>STOP-1</u> , STOP-2
PARITY	For setting the parity. <u>ODD</u> , EVEN, NON
BAUD RATE	For setting the communication speed (bps). 1200, 2400, 4800, <u>9600</u> , 19200

The underlining indicates the factory mode setting.

### USER ID REC screen

Menu item	Description of function
	The user ID (max. 8 alphanumerics) is set on this screen. By setting the user ID here, it will be recorded onto the recording tape. <Note> The following 16 alphanumerics can be used. 0, 1, 2, 3, 4, 5, 6, 7, 8, 9, A, B, C, D, E, F

The following functions can be controlled by using the RS-232C interface.

■ **Basic operations**

The same basic operations as those performed by the unit's buttons and switches can be initiated.

■ **Status checks**

The unit's current operation mode can be checked.

■ **Setting menus**

The setting menu items can be detected and set.

■ **Search function**

Specific frame positions can be searched.

## 1. Hardware specifications

### (1) Interface specifications

**Connector:**

D-Sub 9-pin  
DCE specifications (straight cable supported)

Pin No.	Signal	Description
1	GND	GND
2	SD (TXD)	Transmitted Data
3	RD (RXD)	Received Data
4	ER (DTR)	Data Terminal Ready
5	SG	Signal GND
6	DR (DSR)	Data Set Ready
7	CS (CTS)	Clear to Send
8	RS (RTS)	Request to Send
9	N.C	-----

### Example of connections (9P)

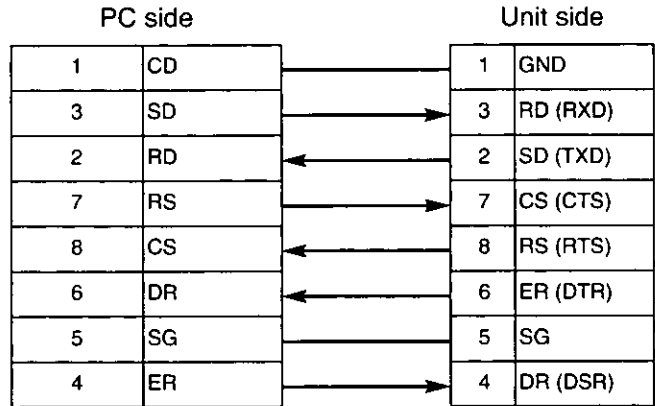

### Example of connections (25P)

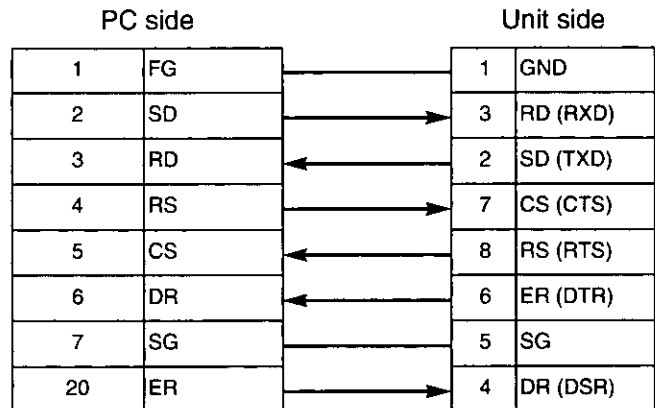

### (2) Communication parameters

The unit's communication parameters are as follows. To change any of these parameters, make the changes on the menus.

- Baud rate** : 9600 bps
- Bit length** : 7 bits
- Stop bit** : 1 bit
- Parity** : Odd

## 2. Software specifications

### (1) External interface specifications

Communication system	Asynchronous, full duplex
Baud rate	1200, 2400, 4800, 9600 or 19200 bps
Bit length	8 bits or 7 bits
Stop bit	1 bit or 2 bits
Parity	None, odd or even

#### <Notes>

- The factory settings are 9600 bps, 7 bits, 1 stop bit and odd parity.
- The unit's receive buffer has a capacity of 127 bytes.

### (2) Transmitting format (PC → unit)

#### ■ Data format

[STX] [discrimination] [:] [data] [ETX]  
02H XX XX XX 3AH XX.....XX 03H

20H<XX<7FH

(XX = hexadecimal character code)

#### ● discrimination:

Command identifier (3 bytes)

- : : Code serving as a delimiter between the command and data
- data : The data code is added as and when required.

1. A send command always starts with STX (character code 02H). "discrimination" which follows the command is the command identifier. If necessary, "data" is added after the colon (:). The command is ended with ETX (character code 03H).
2. When STX is re-sent before ETX is sent, the unit's internal receive buffer is cleared (all the data received so far is destroyed), the re-sent STX is placed at the head, and the new data is processed.

## (3) Receiving format (unit → PC)

The unit responds to a send command with the following format data.

### 1. First, the unit returns the data that indicates whether the command from the PC was received properly.

- 1) In the case of error-free communication, the unit returns ACK (acknowledge) data.

[ACK]  
06H

- 2) If there is an error in the communication, the unit returns data starting with NAK (negative acknowledge character code 15H).

If data is being sent, the unit returns NAK after the data has been sent.

The unit then destroys all the received data with the error.

[NAK] □  
15H (XX)

#### ● Content of □

- 1 (31H): Parity error
- 2 (32H): Data overflow error
- 3 (33H): Framing error
- 4 (34H): Overrun error

### 2. After the unit has returned ACK when the communication was error-free, the unit operates as follows to return the data with the following format.

- 1) The response data (return data) format used when the commands from the PC have been received properly by the unit is as follows:

[STX] [data] [ETX]  
02H XX.....XX 03H

#### example:

**Send command**    **Return data = Receive data**

[STX] QOP [ETX] → [ACK] [STX] OEJ [ETX]

[STX] QCD [ETX] → [ACK] [STX] CD □□□□□□□□ [ETX]

- 2) When the data contains errors or the a problem occurs in the unit, the nature of the errors or the reason why the data was not received is returned with the following format:

[STX] E R □ [ETX]  
02H 45H 52H XX 03H

#### ● Content of □

- 2 (32H) : Cassette up/down error
- 3 (33H) : Loading error
- 4 (34H) : Drum or capstan system error
- 5 (35H) : Reel system error
- 6 (36H) : Tension system error
- 7 (37H) : Solenoid error
- D (44H) : Condensation error
- E (45H) : Command or parameter error
- M (4DH) : Non-executable command (in setting menu mode or time adjustment mode)
- P (50H) : Search error (at tape start or end)
- F (46H) : Search error (search suspended by front panel operation)
- T (54H) : Search error (no target position)
- I (49H) : Search error (search suspended by command)
- O (4FH) : Receive buffer overflow

#### <Note>

When using a PC to control the unit, check the unit's operations carefully.

It is recommended that the unit be controlled while simultaneously monitoring its status information.

## (4) List of commands

The tables below show the send commands for each mode as seen from the PC side and the operations of those commands.

“STX” is hexadecimal code 02H, “ETX” is hexadecimal code 03H, : is hexadecimal code 3AH, and the “discrimination” and “data” parts signify the ASCII codes corresponding to their symbols.

### • Communication control commands

Data transmitted by PC	Data returned from unit in response	Description of command
[STX] RAF [ETX]	[STX] RAF [ETX]	Sets the ACK (acknowledge) code return function to OFF.
[STX] RAN [ETX]	[STX] RAN [ETX]	Sets the ACK (acknowledge) code return function to ON.
[STX] RCK [ETX]	[STX] RCK [ETX]	Checks the communication line.
[STX] RSE:m [ETX]	[STX] RSE [ETX]	Sets the search end mode.

### • Counter control commands

Data transmitted by PC	Data returned from unit in response	Description of command
[STX] CCP:data [ETX]	[STX] CCP [ETX]	Presets the CTL counter data (same as the CLP command).
[STX] CLP:data [ETX]	[STX] CLP [ETX]	Presets the CTL counter data (same as the CCP command).
[STX] CRT [ETX]	[STX] CRT [ETX]	Resets the CTL counter data.

### • Display control commands

Data transmitted by PC	Data returned from unit in response	Description of command
[STX] DBB [ETX]	[STX] DBB [ETX]	Sets the characters to black.
[STX] DBW [ETX]	[STX] DBW [ETX]	Sets the characters to white.
[STX] DDS:d:t:m:r [ETX]	[STX] DDS [ETX]	Sets the display item on the monitor screen.
[STX] DFC:m [ETX]	[STX] DFC [ETX]	Set the display mode of the display tube.
[STX] DMS:d:m:n [ETX]	[STX] DMS [ETX]	Sets the time system (12-hour or 24-hour) display mode.
[STX] DPP:mm [ETX]	[STX] DPP [ETX]	Sets the display position on the monitor screen.



## ● Media operation control commands

Data transmitted by PC	Data returned from unit in response	Description of command
[STX] HEA [ETX]	[STX] HEA [ETX]	Sets the unit's operation when the EJECT button is pressed to REW → EJECT.
[STX] HEE [ETX]	[STX] HEE [ETX]	Sets the unit's operation when the EJECT button is pressed to EJECT.
[STX] HRE:m [ETX]	[STX] HRE [ETX]	Sets the unit's operation mode at the tape-end position during recording.
[STX] HRL:m [ETX]	[STX] HRL [ETX]	Sets the lock mode for the operation during recording.
[STX] HTI:m [ETX]	[STX] HTI [ETX]	Sets the operation mode that is to be established when the tape has been inserted.
[STX] HTR:m:b [ETX]	[STX] HTR [ETX]	Sets the warning for when the tape-end position is about to be reached.

## ● Operation control commands

Data transmitted by PC	Data returned from unit in response	Description of command
[STX] OAC [ETX]	[STX] OAC [ETX]	Releases the alarm signal input.
[STX] OAF [ETX]	[STX] OAF [ETX]	Advances the tape frame by frame in the forward direction.
[STX] OAI:n [ETX]	[STX] OAI [ETX]	Inputs the alarm signal.
[STX] OAR [ETX]	[STX] OAR [ETX]	Advances the tape frame by frame in the reverse direction.
[STX] OEJ [ETX]	[STX] OEJ [ETX]	EJECT
[STX] OFF [ETX]	[STX] OFF [ETX]	FAST FORWARD
[STX] OPA [ETX]	[STX] OPA [ETX]	PAUSE
[STX] OPL [ETX]	[STX] OPL [ETX]	PLAY
[STX] OPR [ETX]	[STX] OPR [ETX]	REVERSE PLAY
[STX] ORC [ETX]	[STX] ORC [ETX]	RECORD
[STX] ORR [ETX]	[STX] ORR [ETX]	REC CHECK
[STX] ORW [ETX]	[STX] ORW [ETX]	REWIND
[STX] OSF:n [ETX]	[STX] OSF [ETX]	FORWARD SEARCH
[STX] OSP [ETX]	[STX] OSP [ETX]	STOP
[STX] OSR:n [ETX]	[STX] OSR [ETX]	REVERSE SEARCH

## ● Power control commands

Data transmitted by PC	Data returned from unit in response	Description of command
[STX] POF [ETX]	[STX] POF [ETX]	Sets the POWER switch to OFF.
[STX] PON [ETX]	[STX] PON [ETX]	Sets the POWER switch to ON.

## ● Search control commands

Data transmitted by PC	Data returned from unit in response	Description of command
[STX] SAS:data [ETX]	[STX] SAS [ETX]	Performs alarm number search and establishes the STILL mode.
[STX] SCP:data [ETX]	[STX] SCP [ETX]	Performs counter value search and performs playback.
[STX] SCS:data [ETX]	[STX] SCS [ETX]	Performs counter value search and establishes the STILL mode.
[STX] SPT:data [ETX]	[STX] SPT [ETX]	Performs playback as far as the designated position (same as the OPT command).
[STX] STS:data [ETX]	[STX] STS [ETX]	Performs a date and time search and establishes the STILL mode.

## ● Timer control commands

Data transmitted by PC	Data returned from unit in response	Description of command
[STX] TAT:data [ETX]	[STX] TAT [ETX]	Sets the time to be set when signals have been input from the component connected to TIME ADJ IN on the rear panel terminal section.
[STX] TCS:data [ETX]	[STX] TCS [ETX]	Sets the current date.
[STX] TTS:data [ETX]	[STX] TTS [ETX]	Sets the current time.

## ● Video control commands

Data transmitted by PC	Data returned from unit in response	Description of command
[STX] VMD:m [ETX]	[STX] VMD [ETX]	Sets the color of the video output signals.
[STX] VNR:m [ETX]	[STX] VNR [ETX]	Sets the video signals to be output to the monitor screen at all times except when the unit is in the recording mode.
[STX] VVC [ETX]	[STX] VVC [ETX]	Detects whether video signals are input.

## ● Time lapse control commands

Data transmitted by PC	Data returned from unit in response	Description of command
[STX] LAD:m [ETX]	[STX] LAD [ETX]	Sets the duration of the alarm recording or sensor recording.
[STX] LAI:m [ETX]	[STX] LAI [ETX]	Sets the operation mode that is to be established when an alarm signal has been input while the tape is at its end position.
[STX] LAR [ETX]	[STX] LAR [ETX]	Deletes the ALARM RECALL data.
[STX] LBM:m [ETX]	[STX] LBM [ETX]	Sets the processing of the black burst signal when the video signals are switched.
[STX] LBP:m [ETX]	[STX] LBP [ETX]	Prevents the video signals of a specific camera from being output.
[STX] LBR:m [ETX]	[STX] LBR [ETX]	Sets the buzzer when the REW REVIEW results are no-good.
[STX] LBZ:m [ETX]	[STX] LBZ [ETX]	Sets the buzzer during alarm recording or sensor recording.
[STX] LMS:m [ETX]	[STX] LMS [ETX]	Sets the timing at which the video signals which are supplied from the camera and which are to be output from the rear panel VIDEO OUT connector are to be switched.
[STX] LDA:m [ETX]	[STX] LDA [ETX]	Sets the output of the control signals to the component connected to the ALARM OUT terminal.
[STX] LDF:m [ETX]	[STX] LDF [ETX]	Sets the recording mode in which to perform alarm recording or sensor recording.
[STX] LDM:m [ETX]	[STX] LDM [ETX]	Sets recording mode that is to be established when the alarm signal has been input.
[STX] LDO:data1:data2 [ETX]	[STX] LDO [ETX]	Sets the start and end times when the control signals are to be output to the component connected to the EXT TIMER OUT terminal.
[STX] LDP:m [ETX]	[STX] LDP [ETX]	Sets the picture quality for performing alarm recording or sensor recording.
[STX] LDS:m [ETX]	[STX] LDS [ETX]	Selects the mode (field or frame) for performing still-picture playback.
[STX] LDT:m:n [ETX]	[STX] LDT [ETX]	Sets the recording type in which to record when an alarm signal has been input to the ALARM IN 1 or 2 terminal.
[STX] LDW:m [ETX]	[STX] LDW [ETX]	Sets the output of the control signals which are to be output to the component connected to the WARNING/REC OUT connector.
[STX] LDX:m [ETX]	[STX] LDX [ETX]	Switches the function of the EXT SW IN/VIDEO OUT connector.
[STX] LFS:nn:mmdd:p [ETX]	[STX] LFS [ETX]	Sets the free-set timer.
[STX] LIP:n:data1:data2:t [ETX]	[STX] LIP [ETX]	Sets internal timer recording.
[STX] LIW:abcdefghijklmnp [ETX]	[STX] LIW [ETX]	Sets the weekly timer and daily timer.
[STX] LLL:m [ETX]	[STX] LLL [ETX]	Sets the synchronization system of the cameras to be connected.
[STX] LMA:m [ETX]	[STX] LMA [ETX]	Switches the search mode.
[STX] LMP:p:n [ETX]	[STX] LMP [ETX]	Switches the screen display (4-in-1 or 1-screen display) and sets the camera numbers.
[STX] LNR:f:p:t [ETX]	[STX] LNR [ETX]	Sets the recording mode, picture quality and recording type.
[STX] LRB:m [ETX]	[STX] LRB [ETX]	Sets the buzzer operation in the event that the unit is kept in the stop mode for a prolonged period of time.

## • Time lapse control commands

Data transmitted by PC	Data returned from unit in response	Description of command
[STX] LRI:m [ETX]	[STX] LRI [ETX]	Sets alarm recording or sensor recording to be performed if an alarm signal has been input while repeat recording is underway or while the tape is being rewound.
[STX] LRM:m [ETX]	[STX] LRM [ETX]	Sets the timer recording mode.
[STX] LRR:m [ETX]	[STX] LRR [ETX]	Sets REC REVIEW.
[STX] LSQ:m:t [ETX]	[STX] LSQ [ETX]	Sets the camera number and sequence mode.
[STX] LST:data1:data2 [ETX]	[STX] LST [ETX]	Sets the start date/time and end date/time for daylight saving.
[STX] LSU:m [ETX]	[STX] LSU [ETX]	Turns daylight saving setting ON or OFF.
[STX] LTM:m [ETX]	[STX] LTM [ETX]	Sets the recording time mode.
[STX] LTY:n:t:abcdefgh [ETX]	[STX] LTY [ETX]	Sets the combination of the recording time mode and number of cameras.
[STX] LUI:data [ETX]	[STX] LUI [ETX]	Sets the recording user ID.
[STX] LWB:m [ETX]	[STX] LWB [ETX]	Sets the buzzer operation during auto OFF.
[STX] LWR [ETX]	[STX] LWR [ETX]	Deletes the POWER LOSS MEMORY data.
[STX] LXT:m [ETX]	[STX] LXT [ETX]	Sets whether to acknowledge the input of the external timer signals.

## • Query control commands

Data transmitted by PC	Data returned from unit in response	Description of command
[STX] QAL [ETX]	[STX] ALV0 [ETX]	Queries the address level.
[STX] QAM:m [ETX]	[STX] LDmdata [ETX]	Queries the alarm recording and/or sensor recording setting.
[STX] QBM [ETX]	[STX] LBMm [ETX]	Queries the setting for the black burst signal processing when the video signals are switched.
[STX] QBP [ETX]	[STX] LBPm [ETX]	Queries the camera from which no video signals are to be output.
[STX] QBR [ETX]	[STX] LBRm [ETX]	Queries the buzzer setting for the results yielded by performing REC REVIEW.
[STX] QCC [ETX]	[STX] CCPdata [ETX]	Queries the counter data (same as the QCD command).
[STX] QCD [ETX]	[STX] CDdata [ETX]	Queries the counter data (same as the QCC command).
[STX] QDA [ETX]	[STX] LDAm [ETX]	Queries the output setting of the control signals to the component connected to the ALARM OUT terminal.
[STX] QDB [ETX]	[STX] DBm [ETX]	Queries the color setting for the characters.
[STX] QDD [ETX]	[STX] DDSd:t:m:r [ETX]	Queries the display item setting for the monitor screen.
[STX] QDF [ETX]	[STX] DFCm [ETX]	Queries the display mode of the display tube.
[STX] QDM [ETX]	[STX] DMSd:m:n [ETX]	Queries the time display mode setting.
[STX] QDO [ETX]	[STX] LDOdata1:data2 [ETX]	Queries the setting of the start and end times when the control signals are to be output to the component connected to the EXT TIMER OUT terminal.
[STX] QDP [ETX]	[STX] DPPmm [ETX]	Queries the display position setting for the monitor screen.
[STX] QDS [ETX]	[STX] LDSm [ETX]	Queries the selection of the mode (field or frame) for performing still-picture playback.
[STX] QDW [ETX]	[STX] LDWm [ETX]	Queries the setting for how the control signals are to be output to the component connected to the WARNING/REC OUT terminal.
[STX] QDX [ETX]	[STX] LDXm [ETX]	Queries the setting to switch the EXT SW IN/VIDEO OUT connector function.
[STX] QFS:nn [ETX]	[STX] LFSnn:mmdd:p [ETX]	Queries the free-set timer setting.
[STX] QHI [ETX]	[STX] HTIm [ETX]	Queries the operation mode that is to be established when a tape has been inserted.
[STX] QHJ [ETX]	[STX] HEm [ETX]	Queries the setting for the operation that is to be established when the EJECT button is pressed.
[STX] QHL [ETX]	[STX] HRLm [ETX]	Queries the lock mode setting for operations during recording.
[STX] QHR:H [ETX]	[STX] HTRdata [ETX]	Queries the remaining tape amount.
[STX] QHT [ETX]	[STX] HREm [ETX]	Queries the setting for the operation mode that is to be established (during recording) at the tape-end position.
[STX] QIC [ETX]	[STX] 1 [ETX]	Queries the product area identification code.
[STX] QID [ETX]	[STX] data [ETX]	Queries the ID code of the unit.

## • Query control commands

Data transmitted by PC	Data returned from unit in response	Description of command
[STX] QIP:n [ETX]	[STX] LIPn:data1:data2:t [ETX]	Queries the internal timer recording setting.
[STX] QIR [ETX]	[STX] LUImdata [ETX]	Queries the user ID of the playback tape.
[STX] QIW [ETX]	[STX] LIWabcdefgh:ijklmnop [ETX]	Queries the settings of the weekly timer and daily timer.
[STX] QLA:m [ETX]	[STX] LAmn [ETX]	Queries the setting for the operation mode that is to be established when an alarm signal has been input at the tape-end position and for the duration of the alarm recording and/or sensor recording.
[STX] QMS [ETX]	[STX] LMSm [ETX]	Queries the setting of the timing at which the video signals which are supplied from the camera and which are to be output from the rear panel VIDEO OUT connector are to be switched.
[STX] QLD:n [ETX]	[STX] LANnn:data1:data2 [ETX]	Queries the ALARM RECALL data.
[STX] QLE [ETX]	[STX] LRIm [ETX]	Queries the setting for alarm recording or sensor recording if an alarm signal has been input while repeat recording is underway or while the tape is being rewound.
[STX] QLH [ETX]	[STX] LHRhhhh [ETX]	Queries the current value of the hour meter.
[STX] QLM [ETX]	[STX] LRMm [ETX]	Queries the timer recording mode setting.
[STX] QLP:n [ETX]	[STX] LPLnn:data1:data2 [ETX]	Queries the POWER LOSS MEMORY data.
[STX] QLT [ETX]	[STX] LTMm [ETX]	Queries the setting of the recording/playback time mode.
[STX] QLZ [ETX]	[STX] LBZm [ETX]	Queries the setting of the buzzer operation during alarm recording or sensor recording.
[STX] QMA [ETX]	[STX] LMAm [ETX]	Queries the search mode.
[STX] QMP [ETX]	[STX] LMPp:c0c1c2c3 [ETX]	Queries the settings for switching the screen display (4-in-1 or 1-screen display) and for the camera numbers.
[STX] QNL [ETX]	[STX] LLLm [ETX]	Queries the synchronization system setting for the cameras to be connected.
[STX] QNR [ETX]	[STX] VNRm [ETX]	Queries the setting of the video signals which are to be output to the monitor screen in all modes except for the recording mode.
[STX] QOP [ETX]	[STX] data [ETX]	Queries the unit's operation mode.
[STX] QOR [ETX]	[STX] ORm [ETX]	Queries the results yielded by performing REC REVIEW.
[STX] QOS [ETX]	[STX] OPSdata [ETX]	Queries the operation modes.
[STX] QPB:m [ETX]	[STX] LPBm:r:data [ETX]	Queries playback tape information.
[STX] QRA [ETX]	[STX] RAM [ETX]	Queries the ACK (acknowledge) code response setting.
[STX] QRE [ETX]	[STX] LRBm [ETX]	Queries the setting of the buzzer operation in the event that the unit is kept in the stop mode for a prolonged period of time.
[STX] QRF [ETX]	[STX] LNRf:p:t [ETX]	Queries the settings of the recording mode, picture quality and recording type.

## • Query control commands

Data transmitted by PC	Data returned from unit in response	Description of command
[STX] QRR [ETX]	[STX] LRRm [ETX]	Queries the REC REVIEW setting.
[STX] QRS [ETX]	[STX] RSEm [ETX]	Queries the search end mode setting.
[STX] QRV:m [ETX]	[STX] VERdata [ETX]	Queries the software version.
[STX] QSQ [ETX]	[STX] LSQm:t [ETX]	Queries the camera number and sequence mode settings.
[STX] QST [ETX]	[STX] LSTdata1:data2 [ETX]	Queries the start date/time and end date/time settings for daylight saving time.
[STX] QSU [ETX]	[STX] LSUm [ETX]	Queries the ON/OFF setting for daylight saving time.
[STX] QTA [ETX]	[STX] TATmm:S [ETX]	Queries the setting for the time to be set when signals have been input from the component connected to TIME ADJ IN on the rear panel terminal section.
[STX] QTC [ETX]	[STX] TTSdata [ETX]	Queries the current time setting.
[STX] QTL [ETX]	[STX] TCSdata [ETX]	Queries the current date setting.
[STX] QTR [ETX]	[STX] HTRm:b [ETX]	Queries the setting for warnings when the tape-end position is about to be reached.
[STX] QTY:n [ETX]	[STX] LTYn:t:abcdefgh [ETX]	Queries the combination setting of the recording time mode and number of cameras.
[STX] QUI [ETX]	[STX] LUISdata [ETX]	Queries the recording user ID setting.
[STX] QVC [ETX]	[STX] VVCm:data [ETX]	Queries the results of searching for video signal input.
[STX] QVM [ETX]	[STX] VMDm [ETX]	Queries the color setting of the video output signals.
[STX] QWB [ETX]	[STX] LWBm [ETX]	Queries the buzzer setting in the auto OFF mode.
[STX] QXT [ETX]	[STX] LXTm [ETX]	Queries the setting for acknowledging the input of the external timer signal.

## ■ Communication control commands

Data transmitted by PC	Data returned from unit in response	Description of command
[STX] RAF [ETX]	[STX] RAF [ETX]	Disables the return of the ACK (acknowledge) code. <b>&lt;Note&gt;</b> This command is not acknowledged while a search control command is being processed.
[STX] RAN [ETX]	[STX] RAN [ETX]	Enables the return of the ACK (acknowledge) code. <b>&lt;Note&gt;</b> This command is not acknowledged while a search control command is being processed.
[STX] RCK [ETX]	[STX] RCK [ETX]	Checks whether communication has been established. <b>&lt;Note&gt;</b> This command is not acknowledged while a search control command is being processed.
[STX] RSE:m [ETX] <b>Parameter</b> m = 0: Normal 1: No command when search is completed 2: No command when search is completed/when error is discovered	[STX] RSE [ETX]	Sets the timing at which the search completion command is to be sent and sets the enabling/disabling of the transmission. <ul style="list-style-type: none"> <li>● <b>When "normal" is selected</b> When search is started: ACK code is returned. When search is completed: [STX]□□□[ETX] is returned. When search is suspended: [STX]ER□□□[ETX] is returned.</li> <li>● <b>When "no command when search is completed" is selected</b> When search is started: [STX]□□□[ETX] is returned after ACK is returned. When search is completed: No return When search is suspended: [STX]ER□□□[ETX] is returned.</li> <li>● <b>When "no command when search is completed/when error is discovered" is selected</b> When search is started: [STX]□□□[ETX] is returned after ACK is returned. When search is completed: No return When search is suspended: No return</li> </ul> <b>&lt;Note&gt;</b> This command is not acknowledged while a search control command is being processed.



## ■ Counter control command

Data transmitted by PC	Data returned from unit in response	Description of command
<p>[STX] CCP:data [ETX]</p> <p><b>Parameter</b>            data = ghmmssff            g = Blank : With a positive (+) value                - sign : With a negative (-) value            h = 0—9 : Hours (12-hour system)            mm = 00—59 : Minutes            ss = 00—59 : Seconds            ff = 00—29 : Frames</p>	<p>[STX] CCP [ETX]</p>	<p>Presets a designated counter value on the CTL counter.  <b>&lt;Note&gt;</b>            This command is not acknowledged while a search control command is being processed or while a tape is being ejected.</p>
<p>[STX] CLP:data [ETX]</p> <p><b>Parameter</b>            data = ghmmssff            g = Blank : With a positive (+) value                - sign : With a negative (-) value            h = 0—9 : Hours (12-hour system)            mm = 00—59 : Minutes            ss = 00—59 : Seconds            ff = 00—29 : Frames</p>	<p>[STX] CLP [ETX]</p>	<p>Presets a designated counter value on the CTL counter.  <b>&lt;Note&gt;</b>            This command is not acknowledged while a search control command is being processed or while a tape is being ejected.</p>
<p>[STX] CRT [ETX]</p>	<p>[STX] CRT [ETX]</p>	<p>Resets the CTL counter data.  <b>&lt;Note&gt;</b>            This command is not acknowledged while a search control command is being processed.</p>

## ■ Display control commands

Data transmitted by PC	Data returned from unit in response	Description of command
[STX] DBB [ETX]	[STX] DBB [ETX]	Sets black as the color of the characters displayed on the monitor screen. <b>&lt;Note&gt;</b> This command is not acknowledged while a search control command is being processed.
[STX] DBW [ETX]	[STX] DBW [ETX]	Sets white as the color of the characters displayed on the monitor screen. <b>&lt;Note&gt;</b> This command is not acknowledged while a search control command is being processed.
[STX] DDS:d:t:m:r [ETX] <b>Parameter</b> d = N or F (date) t = N or F (time) m = N or F (recording time mode) r = N or F (REC/ALARM) N: ON (displayed) F: OFF (not displayed)	[STX] DDS [ETX]	Sets the display items on the monitor screen. <b>&lt;Note&gt;</b> This command is not acknowledged while a search control command is being processed.
[STX] DFC:m [ETX] <b>Parameter</b> m = C: (COUNT) counter display I: (TIME) clock display M: (CAMERA) camera number display P: (PASS) pass display	[STX] DFC [ETX]	Sets the display mode of the display tube. <b>&lt;Note&gt;</b> This command is not acknowledged while a search control command is being processed.
[STX] DMS:d:m:n [ETX] <b>Parameter</b> d = T (fixed) m = M: AM/PM display H: 24-hour display n = 0—9: VTR ID No. This unit does not have a function for displaying the VTR ID No. so any number between 0 and 9 may be sent.	[STX] DMS [ETX]	Sets the time display mode (12-hour or 24-hour system). <b>&lt;Note&gt;</b> This command is not acknowledged while a search control command is being processed.
[STX] DPP:mm [ETX] <b>Parameter</b> mm = C: Center LB: Bottom left LT: Top left RB: Bottom right RT: Top right	[STX] DPP [ETX]	Sets the position where the characters are to be displayed on the monitor screen. <b>&lt;Note&gt;</b> This command is not acknowledged while a search control command is being processed.

## ■ Media operation control commands

Data transmitted by PC	Data returned from unit in response	Description of command
[STX] HEA [ETX]	[STX] HEA [ETX]	Sets the operation that is to take place when the EJECT button is pressed to REW ↗ EJECT (tape is ejected after it has been rewound to its start position). <b>&lt;Note&gt;</b> This command is not acknowledged while a search control command is being processed.
[STX] HEE [ETX]	[STX] HEE [ETX]	Sets the operation that is to take place when the EJECT button is pressed to EJECT. <b>&lt;Note&gt;</b> This command is not acknowledged while a search control command is being processed.
[STX] HRE:m [ETX] <b>Parameter</b> m = B: BUZZER E: EJECT P: REPEAT R: REWIND S: STOP	[STX] HRE [ETX]	Sets the unit's operation mode that is to be established when the tape-end is reached during recording. <b>&lt;Note&gt;</b> This command is not acknowledged while a search control command is being processed.
[STX] HRL:m [ETX] <b>Parameter</b> m = F: Recording enabled N: Recording disabled	[STX] HRL [ETX]	Sets the lock mode for operation during recording.
[STX] HTI:m [ETX] <b>Parameter</b> m = A: REWIND ↗ REC R: REC S: STOP	[STX] HTI [ETX]	Sets the unit's operation mode that is to be established when the tape has been inserted. <b>&lt;Note&gt;</b> This command is not acknowledged while a search control command is being processed.
[STX] HTR:m:b [ETX] <b>Parameter</b> m = 0: 2% of tape remaining 1: 10% of tape remaining 2: 20% of tape remaining 3: 30% of tape remaining F: (OFF) no warning b = N: Warning is sounded by buzzer. F: (OFF) warning is not sounded by buzzer.	[STX] HTR [ETX]	Sets the remaining tape amount for which REMAIN is to flash on the display tube as a warning display, and sets the buzzer to sound when the tape-end position is about to be reached. (When a 120-minute tape is used)

## ■ Operation control commands

Data transmitted by PC	Data returned from unit in response	Description of command
[STX] OAC [ETX]	[STX] OAC [ETX]	Releases the alarm signal input.
[STX] OAF [ETX]	[STX] OAF [ETX]	Advances the tape frame by frame in the forward direction.
[STX] OAI:n [ETX] <b>Parameter</b> n = 1: ALARM IN 1 2: ALARM IN 2 No parameter: ALARM IN 1	[STX] OAI [ETX]	Inputs the alarm signal.
[STX] OAR [ETX]	[STX] OAR [ETX]	Advances the tape frame by frame in the reverse direction.
[STX] OEJ [ETX]	[STX] OEJ [ETX]	Ejects the cassette tape.
[STX] OFF [ETX]	[STX] OFF [ETX]	Fast forwards the tape.
[STX] OPA [ETX]	[STX] OPA [ETX]	Sets the unit to the pause mode (REC PAUSE or PLAY PAUSE) or pause release mode (REC or PLAY).
[STX] OPL [ETX]	[STX] OPL [ETX]	Plays back the tape.
[STX] OPR [ETX]	[STX] OPR [ETX]	Plays back the tape in the reverse direction.
[STX] ORC [ETX]	[STX] ORC [ETX]	Sets the unit to the recording mode. When the unit is set to REC INHIBIT, error code ERE is returned from the unit.
[STX] ORR [ETX]	[STX] ORR [ETX]	Performs REC REVIEW.
[STX] ORW [ETX]	[STX] ORW [ETX]	Rewinds the tape.
[STX] OSF:n [ETX] <b>Parameter</b> n = 1: 1 × normal speed 4: 4 × normal speed 7: 7 × normal speed	[STX] OSF [ETX]	Sets the tape playback speed in the forward direction.
[STX] OSP [ETX]	[STX] OSP [ETX]	Sets the unit to the stop mode.
[STX] OSR:n [ETX] <b>Parameter</b> n = 1: 1 × normal speed 4: 4 × normal speed 7: 7 × normal speed	[STX] OSR [ETX]	Sets the tape playback speed in the reverse direction.

### <Note>

Refer to the RS-232C mode transition table (page 101) for the conditions under which the operation control commands are acknowledged.

## ■ Power control commands

Data transmitted by PC	Data returned from unit in response	Description of command
[STX] POF [ETX]	[STX] POF [ETX]	Sets the POWER switch to OFF.
[STX] PON [ETX]	[STX] PON [ETX]	Sets the POWER switch to ON.

## ■ Search control commands

Data transmitted by PC	Data returned from unit in response	Description of command
<p>[STX] SAS:data [ETX]</p> <p><b>Parameter</b>            data = nn:d            nn = 0—9: Alarm number            d = F: Forward direction                N: Reverse direction</p>	<p>[STX] SAS [ETX]</p>	<p>Searches the alarm number designated by the parameter in the direction designated by the parameter. The unit is set to STILL mode upon completion of the search.</p> <p>If the designated position is an illegal position (that is, the target position does not exist), error code ERT is returned from the unit, and the STOP mode is established.</p> <p>If the OSP (STOP) command or OEJ (tape EJECT) command is assigned during operation, error code ERI is returned from the unit.</p> <p>If the unit's operation mode has been changed by an operation at its front panel, error code ERF is returned from the unit.</p> <p>If the tape reaches its start or end during operation, error code ERP is returned from the unit.</p> <p>When data differing from the reference data has been sent, error code ERE is returned from the unit.</p> <p><b>&lt;Note&gt;</b>            This command is not acknowledged while a search control command is being processed or while one of the following modes is established.</p> <div style="border: 1px solid black; padding: 2px; width: fit-content;">EJECT, REC, REC PAUSE, REC CHECK, POWER OFF</div>
<p>[STX] SCP:data [ETX]</p> <p><b>Parameter</b>            data = ghmmssff            (CTL data referenced)            g = Blank : With a positive (+) value                - sign : With a negative (-) value            h = 0—9: Hours            mm = 00—59: Minutes            ss = 00—59: Seconds            ff = 00 (fixed): Frames</p>	<p>[STX] SCP [ETX]</p>	<p>Searches the counter value designated by the parameter. Playback is started upon completion of the search.</p> <p>If the designated position is an illegal position (that is, the target position does not exist), error code ERT is returned from the unit, and the STOP mode is established.</p> <p>If the OSP (STOP) command or OEJ (tape EJECT) command is assigned during operation, error code ERI is returned from the unit.</p> <p>If the unit's operation mode has been changed by an operation at its front panel, error code ERF is returned from the unit.</p> <p>If the tape reaches its start or end during operation, error code ERP is returned from the unit.</p> <p>When data differing from the reference data has been sent, error code ERE is returned from the unit.</p> <p><b>&lt;Note&gt;</b>            This command is not acknowledged while a search control command is being processed or while one of the following modes is established.</p> <div style="border: 1px solid black; padding: 2px; width: fit-content;">EJECT, REC, REC PAUSE, REC CHECK, POWER OFF</div>

## ■ Search control commands

Data transmitted by PC	Data returned from unit in response	Description of command
<p>[STX] SCS:data [ETX]</p> <p><b>Parameter</b>            data = ghmmssff            (CTL data referenced)            g = Blank : With a positive (+)                  value                  - sign: With a negative (-)                  value            h = 0—9 : Hours            mm = 00—59 : Minutes            ss = 00—59 : Seconds            ff = 00 (fixed): Frames</p>	<p>[STX] SCS [ETX]</p>	<p>Searches the counter value designated by the parameter. The unit is set to STILL mode upon completion of the search.</p> <p>If the designated position is an illegal position (that is, the target position does not exist), error code ERT is returned from the unit, and the STOP mode is established.</p> <p>If the OSP (STOP) command or OEJ (tape EJECT) command is assigned during operation, error code ERI is returned from the unit.</p> <p>If the unit's operation mode has been changed by an operation at its front panel, error code ERF is returned from the unit.</p> <p>If the tape reaches its start or end during operation, error code ERP is returned from the unit.</p> <p>When data differing from the reference data has been sent, error code ERE is returned from the unit.</p> <p><b>&lt;Note&gt;</b>            This command is not acknowledged while a search control command is being processed or while one of the following modes is established.</p> <div style="border: 1px solid black; padding: 2px; width: fit-content;">             EJECT, REC, REC PAUSE, REC CHECK, POWER OFF           </div>
<p>[STX] SPT:data [ETX]</p> <p><b>Parameter</b>            data = ghmmssff            (CTL data referenced)            g = Blank : With a positive (+)                  value                  - sign: With a negative (-)                  value            h = 0—9 : Hours            mm = 00—59 : Minutes            ss = 00—59 : Seconds            ff = 00—29 : Frames</p>	<p>[STX] SPT [ETX]</p>	<p>Searches up to the position designated by the parameter. The unit is placed in the STILL mode upon completion of the playback.</p> <p>If the designated position is before the current position, the STILL mode is established without playing back the tape.</p> <p>If the OSP (STOP) command or OEJ (tape EJECT) command is assigned during operation, error code ERI is returned from the unit.</p> <p>If the unit's operation mode has been changed by an operation at its front panel, error code ERF is returned from the unit.</p> <p>If the tape reaches its start or end during operation, error code ERP is returned from the unit.</p> <p>When data differing from the reference data has been sent, error code ERE is returned from the unit.</p> <p><b>&lt;Note&gt;</b>            This command is not acknowledged while a search control command is being processed or while one of the following modes is established.</p> <div style="border: 1px solid black; padding: 2px; width: fit-content;">             EJECT, REC, REC PAUSE, REC CHECK, POWER OFF           </div>

## ■ Search control commands

Data transmitted by PC	Data returned from unit in response	Description of command
<p>[STX] STS:data [ETX]</p> <p><b>Parameter</b>            data = mmddhht:d            mm = 01—12: Month            dd = 01—31: Day            hh = 00—23: Hours            tt = 00—59: Minutes            d = F : Forward direction                  N : Reverse direction</p>	<p>[STX] STS [ETX]</p>	<p>Searches the date and time designated by the parameter in the direction designated by the parameter.            The unit is set to STILL mode upon completion of the search.            If the designated position is an illegal position (that is, the target position does not exist), error code ERT is returned from the unit, and the STOP mode is established.            If the OSP (STOP) command or OEJ (tape EJECT) command is assigned during operation, error code ERI is returned from the unit.            If the unit's operation mode has been changed by an operation at its front panel, error code ERF is returned from the unit.            If the tape reaches its start or end during operation, error code ERP is returned from the unit.            When data differing from the reference data has been sent, error code ERE is returned from the unit.</p> <p><b>&lt;Note&gt;</b>            This command is not acknowledged while a search control command is being processed or while one of the following modes is established.</p> <div style="border: 1px solid black; padding: 2px; width: fit-content;">             EJECT, REC, REC PAUSE, REC CHECK, POWER OFF           </div>



## ■ Timer control commands

These commands are not acknowledged while a search control command is being processed.

Data transmitted by PC	Data returned from unit in response	Description of command
<p>[STX] TAT:data [ETX]</p> <p><b>Parameter</b>            data = mm:n            mm = 00—23 : Digit(s) of the hour to be set                      FF : Sets the digits for the minutes to 00.            n = S (fixed)</p>	[STX] TAT [ETX]	Sets the time to be set when signals have been input from the component connected to TIME ADJ IN on the rear panel terminal section.
<p>[STX] TCS:data [ETX]</p> <p><b>Parameter</b>            data = yyymmdd            yyyy = 2000—2099:                    Gregorian calendar            mm = 01—12: Month            dd = 01—31: Day</p>	[STX] TCS [ETX]	Sets the current date. When a day which does not exist for the month or due to a leap year has been set, error code ERE is returned from the unit.
<p>[STX] TTS:data [ETX]</p> <p><b>Parameter</b>            data = hhmmss            hh = 00—23: Hours (24-hour system)            mm = 00—59: Minutes            ss = 00—59: Seconds</p>	[STX] TTS [ETX]	Sets the current time.

## ■ Video control command

These commands are not acknowledged while a search control command is being processed.

Data transmitted by PC	Data returned from unit in response	Description of command
<p>[STX] VMD:m [ETX]</p> <p><b>Parameter</b>            m = A: AUTO            Color and monochrome are switched automatically in accordance with the input signals.            B: B/W            Monochrome is forcibly set.</p>	[STX] VMD [ETX]	Sets the color of the video output signals.
<p>[STX] VNR:m [ETX]</p> <p><b>Parameter</b>            m = C: CAMERA            Video signals supplied from the cameras            B: BLUE BACK            Blue background signals</p>	[STX] VNR [ETX]	Sets the video signals (video signals from the camera and blue background signal) to be output to the monitor screen in all modes except the recording mode.
[STX] VVC [ETX]	[STX] VVC [ETX]	<p>Switches the cameras in sequence to detect whether video signals are input to CAMERA IN connectors ① through ⑯. Signals cannot be detected when the POWER switch is at OFF.</p> <p>The detection results are checked using the QVC command.</p>

## ■ Time lapse control commands

These commands are not acknowledged while a search control command is being processed.

Data transmitted by PC	Data returned from unit in response	Description of command
<p>[STX] LAD:m [ETX]</p> <p><b>Parameter</b>            m = 0: 30 seconds            1: 1 minute            2: 1 minute and 30 seconds            3: 2 minutes            4: 3 minutes            5: 6 minutes            6: 10 minutes            7: CONTINUE:            Recording continues until the tape-end.            8: MANUAL:            Recording only while an alarm signal is input.</p>	[STX] LAD [ETX]	Sets the time during which alarm recording or sensor recording is to be performed.
<p>[STX] LAI:m [ETX]</p> <p><b>Parameter</b>            m = S: STOP            Stop mode established at tape-end position.            C: CONTINUE            Alarm signal input is ignored.</p>	[STX] LAI [ETX]	Sets the operation mode that is to be established when an alarm signal has been input at the tape-end position.
[STX] LAR [ETX]	[STX] LAR [ETX]	Deletes the ALARM RECALL data.
<p>[STX] LBM:m [ETX]</p> <p><b>Parameter</b>            m = N: ON            Output of the black burst signal.            F: OFF            No output of the black burst signal.</p>	[STX] LBM [ETX]	Sets the processing to be performed for the black burst signal when the video signals to be output from the video signal output connectors are switched.
<p>[STX] LBP:m [ETX]</p> <p><b>Parameter</b>            m = *: Video signals of all the cameras are output.            0: Camera 1            1: Camera 2            2: Camera 3            3: Camera 4            4: Camera 5            5: Camera 6            6: Camera 7            7: Camera 8            8: Camera 9            9: Camera 10            A: Camera 11            B: Camera 12            C: Camera 13            D: Camera 14            E: Camera 15            F: Camera 16</p>	[STX] LBP [ETX]	Prevents the video signals of the camera designated by the parameter from being output from the VIDEO OUT connector.

## ■ Time lapse control commands

These commands are not acknowledged while a search control command is being processed.

Data transmitted by PC	Data returned from unit in response	Description of command
<p>[STX] LBR:m [ETX]</p> <p><b>Parameter</b>            m = N: Buzzer ON            F: Buzzer OFF</p>	[STX] LBR [ETX]	Sets whether the buzzer is to sound when REC REVIEW reveals that the proper video level was not maintained.
<p>[STX] LBZ:m [ETX]</p> <p><b>Parameter</b>            m = N: Buzzer ON            F: Buzzer OFF</p>	[STX] LBZ [ETX]	Sets whether the buzzer is to sound during alarm recording and sensor recording.
<p>[STX] LMS:m [ETX]</p> <p><b>Parameter</b>            m = 0: 1 second            1: 1.5 seconds            2: 2 seconds            3: 2.5 seconds            4: 3 seconds            5: 4 seconds            6: 5 seconds            7: 10 seconds</p>	[STX] LMS [ETX]	Sets the timing at which to switch the video signals which are supplied from the camera and which are to be output from the rear panel VIDEO OUT connector.
<p>[STX] LDA:m [ETX]</p> <p><b>Parameter</b>            m = C: CONTINUE            Control signals continue to be output even after recording.            A: ALARM REC            Control signals are output only during alarm recording and sensor recording.</p>	[STX] LDA [ETX]	Sets how the control signals are to be output to the component connected to ALARM OUT on the rear panel terminal section when alarm recording or sensor recording is performed.
<p>[STX] LDF:m [ETX]</p> <p><b>Parameter</b>            m = I: Field recording            R: Frame recording</p>	[STX] LDF [ETX]	Sets whether field recording or frame recording is to be performed for alarm recording and sensor recording.
<p>[STX] LDM:m [ETX]</p> <p><b>Parameter</b>            m = F: OFF            Alarm signal input is ignored.            M: ALARM/SENSOR            Alarm recording or sensor recording is performed.            A: ALARM            Alarm recording is performed.            S: SENSOR            Sensor recording is performed.</p>	[STX] LDM [ETX]	Sets what recording is to be performed when an alarm signal has been input.

## ■ Time lapse control commands

These commands are not acknowledged while a search control command is being processed.

Data transmitted by PC	Data returned from unit in response	Description of command
[STX] LDO:data1:data2 [ETX] <b>Parameter</b> data1 = hhmm (start time) data2 = hhmm (end time) hh = 00—23: Hours (24-hour system) mm = 00—59: Minutes	[STX] LDO [ETX]	Sets the start time (START) and end time (END) at which the control signals are to be output to the component connected to EXT TIMER OUT on the rear panel terminal section. <b>&lt;Note&gt;</b> The control signals are not output when the same time has been set for both the START and END times.
[STX] LDP:m [ETX] <b>Parameter</b> m = H: HIGH Recording at a high picture quality N: NORMAL Recording at the standard picture quality F: NO CHANGE Recording at the currently set picture quality	[STX] LDP [ETX]	For setting the picture quality with which to perform alarm recording and/or sensor recording.
[STX] LDS:m [ETX] <b>Parameter</b> m = I: Field playback R: Frame playback	[STX] LDS [ETX]	For selecting field playback or frame playback for still-picture playback.
[STX] LDT:m:n [ETX] <b>Parameter</b> m = 0—7: Recording type of ALARM IN 1 n = 0—7: Recording type of ALARM IN 2	[STX] LDT [ETX]	For setting the recording type to be used if an alarm signal has been input to ALARM IN 1 or 2.
[STX] LDW:m [ETX] <b>Parameter</b> m = W: WARNING Control signals continue to be output. R: REC Control signals are output only during recording.	[STX] LDW [ETX]	Sets how the control signals are to be output to the component connected to WARNING/REC OUT on the rear panel terminal section when a problem has occurred in the unit.
[STX] LDX:m [ETX] <b>Parameter</b> m = V: VIDEO OUT Video signal output connector E: EXT SW IN External sequential switcher signal input connector	[STX] LDX [ETX]	Switches the function of the rear panel EXT SW IN/VIDEO OUT connector.

## ■ Time lapse control commands

These commands are not acknowledged while a search control command is being processed.

Data transmitted by PC	Data returned from unit in response	Description of command
<p>[STX] LFS:nn:mmdd:p [ETX]</p> <p><b>Parameter</b>            nn = 00: Free-set timer is not set.                  01—12: Free-set timer                          number            mm = 01—12: Month            dd = 01—31: Day            p = 0: Sunday                  1: Monday                  2: Tuesday                  3: Wednesday                  4: Thursday                  5: Friday                  6: Saturday                  F: Power OFF throughout the                      day</p>	<p>[STX] LFS [ETX]</p>	<p>Sets the free-set timer.            When a day which does not exist for the month has been set, error code ERT is returned from the unit.</p>
<p>[STX] LIP:n:data1:data2:t [ETX]</p> <p><b>Parameter</b>            n = 1—8: Program registration                      number (PGM1—PGM8)</p> <p>data1 = hhmm (start time)            data2 = hhmm (end time)            hh = 00—23: Hours (24-hour                          system)            mm = 00—59: Minutes</p> <p>t = 0—6: Recording type (RT0—                      RT6)</p>	<p>[STX] LIP [ETX]</p>	<p>Combines and registers three items—the recording start time, recording end time and the recording type—as the program for recording to be performed using the unit's internal timer.</p>
<p>[STX] LIW:abcdefgh:ijklmnop [ETX]</p> <p><b>Parameter</b>            a—p = 1—8: Program registration                      number (PGM1—                      PGM8)                  F: Timer is not set.</p> <div style="border: 1px solid black; padding: 5px;"> <p>a = Program 1 on Sunday            b = Program 1 on Monday            c = Program 1 on Tuesday            d = Program 1 on Wednesday            e = Program 1 on Thursday            f = Program 1 on Friday            g = Program 1 on Saturday            h = Daily program 1            i = Program 2 on Sunday            j = Program 2 on Monday            k = Program 2 on Tuesday            l = Program 2 on Wednesday            m = Program 2 on Thursday            n = Program 2 on Friday            o = Program 2 on Saturday            p = Daily program 2</p> </div>	<p>[STX] LIW [ETX]</p>	<p>Sets the weekly timer and daily timer.</p>

## ■ Time lapse control commands

These commands are not acknowledged while a search control command is being processed.

Data transmitted by PC	Data returned from unit in response	Description of command				
<p>[STX] LLL:m [ETX]</p> <p><b>Parameter</b>            m = N: Line-lock type            F: Internal sync and external sync type</p>	[STX] LLL [ETX]	<p>Sets the synchronization system of the camera/s connected.</p> <p><b>&lt;Notes&gt;</b></p> <ul style="list-style-type: none"> <li>● Use of the internal sync type of cameras is recommended.</li> <li>● Select the ON setting when even one line-lock type of camera is used.</li> </ul>				
<p>[STX] LMA:m [ETX]</p> <p><b>Parameter</b>            m = F: Search mode OFF            M: Memory stop mode            A: Alarm search mode</p>	[STX] LMA [ETX]	Switches the search mode.				
<p>[STX] LMP:p:n [ETX]</p> <p><b>Parameter</b>            p = S: 1-screen display            0: 4-in-1 screen display;                Selected screen No.0            1: 4-in-1 screen display;                Selected screen No.1            2: 4-in-1 screen display;                Selected screen No.2            3: 4-in-1 screen display;                Selected screen No.3</p> <table border="1" style="margin-left: 20px;"> <tr> <td style="text-align: center;">0</td> <td style="text-align: center;">1</td> </tr> <tr> <td style="text-align: center;">2</td> <td style="text-align: center;">3</td> </tr> </table> <p>n = *: Camera No. is not changed.            0—F: Camera No.1 to 16;                Camera number is designated for the screen No. selected by parameter p.</p>	0	1	2	3	[STX] LMP [ETX]	Switches the screen display (4-in-1 or 1-screen display) and sets the camera numbers.
0	1					
2	3					
<p>[STX] LNR:f:p:t [ETX]</p> <p><b>Parameter</b>            f = I: Field recording            R: Frame recording</p> <p>p = H: HIGH                Recording at a high picture quality            N: NORMAL                Recording at the standard picture quality</p> <p>t = 0—7: Recording type (RT0—7)</p>	[STX] LNR [ETX]	Sets the recording mode, picture quality and recording type.				

## ■ Time lapse control commands

These commands are not acknowledged while a search control command is being processed.

Data transmitted by PC	Data returned from unit in response	Description of command
<p>[STX] LRB:m [ETX]</p> <p><b>Parameter</b>            m = F: Buzzer OFF            0: 5 minutes            1: 10 minutes            2: 20 minutes            3: 30 minutes</p>	[STX] LRB [ETX]	Sets the buzzer to sound a warning in the event that the unit has been kept in the stop mode for the time designated by the parameter.
<p>[STX] LRI:m [ETX]</p> <p><b>Parameter</b>            m = A: Alarm signal input is acknowledged.            F: Alarm signal input is ignored.</p>	[STX] LRI [ETX]	Sets whether alarm recording or sensor recording is to be performed if an alarm signal has been input while repeat recording is underway or while the tape is being rewound.
<p>[STX] LRM:m [ETX]</p> <p><b>Parameter</b>            m = E: External timer recording            I: Internal timer recording            N: Regular recording</p>	[STX] LRM [ETX]	Sets the timer recording mode.
<p>[STX] LRR:m [ETX]</p> <p><b>Parameter</b>            m = N: REC REVIEW is performed automatically.            F: REC REVIEW OFF</p>	[STX] LRR [ETX]	Sets REC REVIEW. This function plays back the recording after recording for a specific time to detect whether the proper video level is being maintained during recording.
<p>[STX] LSQ:m:t [ETX]</p> <p><b>Parameter</b>            m = 0—F: Camera No.1—16            t = A: Auto sequence mode            M: Manual sequence mode</p>	[STX] LSQ [ETX]	Selects the camera number and sequence mode.
<p>[STX] LST:data1:data2 [ETX]</p> <p><b>Parameter</b>            data1 = ndmmtt (start date/time)            data2 = ndmmtt (end date/time)            n = 1: 1st week            2: 2nd week            3: 3rd week            4: 4th week            L: Last week            d = 0: Sunday            1: Monday            2: Tuesday            3: Wednesday            4: Thursday            5: Friday            6: Saturday            mm = 01—12: Month            tt = 01—22: Hours</p>	[STX] LST [ETX]	Sets the start date/time and end date/time settings for daylight saving time.



## ■ Time lapse control commands

These commands are not acknowledged while a search control command is being processed.

Data transmitted by PC	Data returned from unit in response	Description of command
<p>[STX] LSU:m [ETX]</p> <p><b>Parameter</b>            m = N: Daylight saving time setting                  ON            F: Daylight saving time setting                  OFF</p>	<p>[STX] LSU [ETX]</p>	<p>Sets the daylight saving time setting to ON or OFF.</p>
<p>[STX] LTM:m [ETX]</p> <p><b>Parameter</b>            m = 0: 3-hour recording                  1: 9-hour recording                  2: 12-hour recording                  3: 18-hour recording                  4: 24-hour recording                  5: 48-hour recording                  6: 72-hour recording                  7: 96-hour recording                  8: 120-hour recording                  9: 180-hour recording                  A: 240-hour recording                  B: 360-hour recording                  C: 480-hour recording                  D: 960-hour recording</p>	<p>[STX] LTM [ETX]</p>	<p>Sets the recording time mode.</p>

## ■ Time lapse control commands

These commands are not acknowledged while a search control command is being processed.

Data transmitted by PC	Data returned from unit in response	Description of command
<p>[STX] LTY:n:t:abcdefgh [ETX]</p> <p><b>Parameter</b>  n = 1—6: Recording type (RT1—6)  t = 0: 3-hour recording  1: 9-hour recording  2: 12-hour recording  3: 18-hour recording  4: 24-hour recording  5: 48-hour recording  6: 72-hour recording  7: 96-hour recording  8: 120-hour recording  9: 180-hour recording  A: 240-hour recording  B: 360-hour recording  C: 480-hour recording  D: 960-hour recording  F: OFF (setting of TIME MODE button is complied with)  a = Y or N: for setting cameras No.1 and 2  b = Y or N: for setting cameras No.3 and 4  c = Y or N: for setting cameras No.5 and 6  d = Y or N: for setting cameras No.7 and 8  e = Y or N: for setting cameras No.9 and 10  f = Y or N: for setting cameras No.11 and 12  a = Y or N: for setting cameras No.13 and 14  h = Y or N: for setting cameras No.15 and 16  Y: Used  N: Not used</p>	[STX] LTY [ETX]	Sets the combination of the recording time mode and number of cameras.
<p>[STX] LUI:data [ETX]</p> <p><b>Parameter</b>  data = U7U6U5U4U7U3U2U1U0</p> <p>An ASCII code is used to set the user ID to be written onto the tape.  Binary 4BIT×8  ↓  ASCII code: 0—9, A—F</p>	[STX] LUI [ETX]	<p>Sets the user ID (max. 8 alphanumerics).  By setting the user ID, it will be recorded onto the recording tape.  &lt;Note&gt;  The following 16 alphanumerics can be used.  0, 1, 2, 3, 4, 5, 6, 7, 8, 9, A, B, C, D, E, F</p>
<p>[STX] LWB:m [ETX]</p> <p><b>Parameter</b>  m = N: Buzzer ON  F: Buzzer OFF</p>	[STX] LWB [ETX]	Sets whether the buzzer is to sound when a problem occurs in the unit and the power is automatically turned off.

## ■ Time lapse control commands

These commands are not acknowledged while a search control command is being processed.

Data transmitted by PC	Data returned from unit in response	Description of command
[STX] LWR [ETX]	[STX] LWR [ETX]	Deletes the POWER LOSS MEMORY data.
[STX] LXT:m [ETX] <b>Parameter</b> m = N: Signals are acknowledged. F: Signals are not acknowledged.	[STX] LXT [ETX]	Sets whether the signals from the external timer connected to the rear panel terminal section are to be acknowledged in the external timer recording mode.

## ■ Query control commands

Data transmitted by PC	Data returned from unit in response	Description of command
[STX] QAL [ETX]	[STX] ALV0 [ETX]	Queries the address level. It supports only address level 0 in the MIS standards.
<p>[STX] QAM:m [ETX]</p> <p><b>Parameter</b>  m = M: MODE  Queries the recording mode when an alarm signal has been input.</p> <p>F: FIELD/FRAME  Queries the recording mode in which alarm recording and/or sensor recording is to be performed.</p> <p>P: PICTURE QUALITY  Queries the picture quality with which alarm recording and/or sensor recording is to be performed.</p> <p>T: ALARM 1/2 REC-TYPE  Queries the recording type to be used when an alarm signal has been input to ALARM IN 1 or 2.</p>	<p>[STX] LDmdata [ETX]</p> <p><b>Parameter</b>  m = M: MODE</p> <div style="border: 1px solid black; padding: 5px; margin-bottom: 10px;"> data =  F: OFF  Alarm signal input is ignored.  M: ALARM/SENSOR  Alarm recording and/or sensor recording is performed.  A: ALARM  Alarm recording is performed.  S: SENSOR  Sensor recording is performed. </div> <p>m = F: FIELD/FRAME</p> <div style="border: 1px solid black; padding: 5px; margin-bottom: 10px;"> data =  I: Field recording  R: Frame recording </div> <p>m = P: PICTURE QUALITY</p> <div style="border: 1px solid black; padding: 5px; margin-bottom: 10px;"> data =  H: HIGH  Recording at a high picture quality  N: NORMAL  Recording at the standard picture quality  F: NO CHANGE  Recording at the picture quality currently set </div> <p>m = T: ALARM 1/2 REC-TYPE</p> <div style="border: 1px solid black; padding: 5px;"> data =m:n  m = 0—7: ALARM IN 1 recording type  n = 0—7: ALARM IN 2 recording type </div>	Queries the alarm recording and sensor recording settings.
[STX] QBM [ETX]	<p>[STX] LBMm [ETX]</p> <p><b>Parameter</b>  m = N: ON  The black burst signal is output.</p> <p>F: OFF  The black burst signal is not output.</p>	Queries the processing of the black burst signal when the video signals to be output from the video signal output connector are switched.

## ■ Query control commands

Data transmitted by PC	Data returned from unit in response	Description of command
[STX] QBP [ETX]	<p>[STX] LBPm [ETX]</p> <p><b>Parameter</b>            m = *: The video signals of all the cameras are output.            0: Camera 1            1: Camera 2            2: Camera 3            3: Camera 4            4: Camera 5            5: Camera 6            6: Camera 7            7: Camera 8            8: Camera 9            9: Camera 10            A: Camera 11            B: Camera 12            C: Camera 13            D: Camera 14            E: Camera 15            F: Camera 16</p>	Queries the camera whose video signals are not to be output to the VIDEO OUT connector.
[STX] QBR [ETX]	<p>[STX] LBRm [ETX]</p> <p><b>Parameter</b>            m = N: Buzzer ON            F: Buzzer OFF</p>	Queries the setting for whether the buzzer is to sound when REC REVIEW reveals that the proper video level was not maintained.
[STX] QCC [ETX]	<p>[STX] CCPdata [ETX]</p> <p><b>Parameter</b>            data = ghmmssff            g = Blank : With a positive (+) value                  - sign : With a negative (-) value            h = 0—9: Hours (12-hour system)            mm = 00—59 : Minutes            ss = 00—59 : Seconds</p>	Queries the current CTL counter data (in 1-second increments).
[STX] QCD [ETX]	<p>[STX] CDdata [ETX]</p> <p><b>Parameter</b>            data = fwghmmssff            f = F: Fine                  C: Coarse            w = S: Search STILL                  P: Search PLAY            g = Blank : With a positive (+) value                  - sign : With a negative (-) value            h = 0—9: Hours (12-hour system)            mm = 00—59 : Minutes            ss = 00—59 : Seconds            ff = 00 (fixed) : Frames</p>	Queries the current CTL counter data.

## ■ Query control commands

Data transmitted by PC	Data returned from unit in response	Description of command
[STX] QDA [ETX]	[STX] LDAm [ETX] <b>Parameter</b> m = C: CONTINUE The control signals continue to be output even after recording. A: ALARM REC The control signals are output only during alarm recording or sensor recording (or both).	Queries the setting for how the control signals are to be output to the component connected to ALARM OUT on the rear panel terminal section when alarm recording or sensor recording (or both) is performed.
[STX] QDB [ETX]	[STX] DBm [ETX] <b>Parameter</b> m = B: BLACK W: WHITE	Queries the colors of the characters which are to be displayed on the monitor screen.
[STX] QDD [ETX]	[STX] DDSd:t:m:r [ETX] <b>Parameter</b> d = N or F (date) t = N or F (time) m = N or F (recording time mode) r = N or F (REC/ALARM) N: ON (displayed) F: OFF (not displayed)	Queries the items which are to be displayed on the monitor screen.
[STX] QDF [ETX]	[STX] DFCm [ETX] <b>Parameter</b> m = C: (COUNT) counter display I: (TIME) clock display M: (CAMERA) camera number display P: (PASS) pass display	Queries the display mode of the display tube.
[STX] QDM [ETX]	[STX] DMSt:m:n [ETX] <b>Parameter</b> d = T (fixed) m = M: AM/PM display H: 24-hour display n = 0—9: VTR ID No. This unit does not have a function for displaying the VTR ID No. so any number (which is not determined) between 0 and 9 is returned.	Queries the time display mode (12-hour or 24-hour system).
[STX] QDO [ETX]	[STX] LDOdata1:data2 [ETX] <b>Parameter</b> data1 = hhmm (start time) data2 = hhmm (end time) hh = 00—23: Hours (24-hour system) mm = 00—59: Minutes	Queries the setting of the start and end times at which the control signals are to be output to the component connected to the EXT TIMER OUT terminal on the rear panel.

## ■ Query control commands

Data transmitted by PC	Data returned from unit in response	Description of command
[STX] QDP [ETX]	[STX] DPPmm [ETX] <b>Parameter</b> mm = C: Center LB: Bottom left LT: Top left RB: Bottom right RT: Top right	Queries the position where the characters are to be displayed on the monitor screen.
[STX] QDS [ETX]	[STX] LDSm [ETX] <b>Parameter</b> m = I: Field playback R: Frame playback	Queries whether field playback or frame playback is to be initiated when still-picture playback is performed.
[STX] QDW [ETX]	[STX] LDWm [ETX] <b>Parameter</b> m = W: WARNING The control signals continue to be output. R: REC The control signals are output only during recording.	Queries the setting for how the control signals are to be output to the component connected to WARNING/REC OUT on the rear panel terminal section when a problem has occurred in the unit.
[STX] QDX [ETX]	[STX] LDXm [ETX] <b>Parameter</b> m = V: VIDEO OUT Video signal output connector E: EXT SW IN External sequential switcher signal input connector	Queries the function of the EXT SW IN/VIDEO OUT connector on the rear panel.
[STX] QFS:nn [ETX] <b>Parameter</b> nn = 01—12: Free-set timer number	[STX] LFSnn:mmdd:p [ETX] <b>Parameter</b> nn = 00: Free-set timer is not set. 01—12: Free-set timer number mm = 01—12: Month dd = 01—31: Day p = 0: Sunday 1: Monday 2: Tuesday 3: Wednesday 4: Thursday 5: Friday 6: Saturday F: Power OFF throughout the day	Queries the free-set timer setting.
[STX] QHI [ETX]	[STX] HTIm [ETX] <b>Parameter</b> m = A: REWIND ♦ REC R: REC S: STOP	Queries the unit's operation mode that is to be established when the tape is inserted.

## ■ Query control commands

Data transmitted by PC	Data returned from unit in response	Description of command
[STX] QHJ [ETX]	[STX] HEm [ETX] <b>Parameter</b> m = E: EJECT A: REWIND → EJECT	Queries the setting for the operation to be performed when the EJECT button is pressed.
[STX] QHL [ETX]	[STX] HRLm [ETX] <b>Parameter</b> m = F: Recording enabled N: Recording disabled	Queries the lock mode for operations while recording is underway.
[STX] QHR:H [ETX]	[STX] HTRdata [ETX] <b>Parameter</b> data = hhmmss hh = 00—23: Hours mm = 00—59: Minutes ss = 00 (fixed): Seconds	Queries the remaining tape amount. When the amount is undetermined or the tape has been ejected, data = FFFFFFF is returned. <b>&lt;Note&gt;</b> This command is valid when a 120-minute tape is used and the 3-hour recording mode has been set.
[STX] QHR:H [ETX]	[STX] HTRdata [ETX] <b>Parameter</b> data = hhmmss hh = 00—23: Hours mm = 00—59: Minutes ss = 00 (fixed): Seconds	Queries the remaining tape amount. When the amount is undetermined or the tape has been ejected, data = FFFFFFF is returned. <b>&lt;Note&gt;</b> This command is valid when a 120-minute tape is used and the 3-hour recording mode has been set.
[STX] QHT [ETX]	[STX] HREm [ETX] <b>Parameter</b> m = B: BUZZER E: EJECT P: REPEAT R: REWIND S: STOP	Queries the unit's operation mode that is to be established when the tape has reached its end position during recording.
[STX] QIC [ETX]	[STX] 1 [ETX]	Queries the product area identification code. The unit returns "1" for a tape component.
[STX] QID [ETX]	[STX] data [ETX] <b>Parameter</b> data = AG-DTL1P	Queries the ID code of the unit.
[STX] QIP:n [ETX] <b>Parameter</b> n = 1—8: Program registration number (PGM1—PGM8)	[STX] LIPn:data1:data2:t [ETX] <b>Parameter</b> n = 1—8: Program registration number (PGM1—PGM8)  data1 = hhmm (start time) data2 = hhmm (end time) hh = 00—23: Hours (24-hour system) mm = 00—59: Minutes  t = 0—6: Recording type (RT0—RT6)	Queries the program which combines three items—the recording start time, recording end time and the recording type—for recording using the unit's internal timer.



## ■ Query control commands

Data transmitted by PC	Data returned from unit in response	Description of command
[STX] QIR [ETX]	<p>[STX] LUImdata [ETX]</p> <p><b>Parameter</b>            m = R: READ OK            E: READ NG</p> <p>data = U7U6U5U4U7U3U2U1U0</p> <p>The user ID is returned as an 8-character ASCII code.            Binary 4BIT×8            ↓            ASCII code: 0—9, A—F</p>	Queries the user ID recorded on the playback tape.
[STX] QIW [ETX]	<p>[STX] LIWabcdehgh:ijklmnop [ETX]</p> <p><b>Parameter</b>            a—p = 1—8: Program registration number (PGM1—PGM8)            F: Timer is not set.</p> <div style="border: 1px solid black; padding: 5px;"> <p>a = Program 1 on Sunday            b = Program 1 on Monday            c = Program 1 on Tuesday            d = Program 1 on Wednesday            e = Program 1 on Thursday            f = Program 1 on Friday            g = Program 1 on Saturday            h = Daily program 1            i = Program 2 on Sunday            j = Program 2 on Monday            k = Program 2 on Tuesday            l = Program 2 on Wednesday            m = Program 2 on Thursday            n = Program 2 on Friday            o = Program 2 on Saturday            p = Daily program 2</p> </div>	Queries the weekly timer and daily timer setting.
<p>[STX] QLA:m [ETX]</p> <p><b>Parameter</b>            m = l: Operation mode            D: Time setting</p>	<p>[STX] LAmn [ETX]</p> <p><b>Parameter</b>            m = l: Operation mode</p> <div style="border: 1px solid black; padding: 5px;"> <p>n = S: STOP            Stop mode at tape-end position            C: CONTINUE            Alarm signal input is ignored.</p> </div> <p>m = D: Time setting</p> <div style="border: 1px solid black; padding: 5px;"> <p>n = 0: 30 seconds            1: 1 minute            2: 1 minute and 30 seconds            3: 2 minutes            4: 3 minutes            5: 6 minutes            6: 10 minutes            7: CONTINUE            Recording continues until the tape-end.            8: MANUAL            Recording is performed only while an alarm signal is input.</p> </div>	Queries the operation mode that is to be established when an alarm signal has been input at the tape-end position, and the duration of the alarm recording and/or sensor recording.

## ■ Query control commands

Data transmitted by PC	Data returned from unit in response	Description of command
[STX] QMS [ETX]	<p>[STX] LMSm [ETX]</p> <p><b>Parameter</b>            m = 0: 1 second                  1: 1.5 seconds                  2: 2 seconds                  3: 2.5 seconds                  4: 3 seconds                  5: 4 seconds                  6: 5 seconds                  7: 10 seconds</p>	Queries the timing at which to switch the video signals which are supplied from the camera and which are to be output from the rear panel VIDEO OUT connector.
<p>[STX] QLD:n [ETX]</p> <p><b>Parameter</b>            n = 0—7            Up to the last 8 sets of data are designated by this parameter with 0 serving as the latest data.</p>	<p>[STX] LANnn:data1:data2 [ETX]</p> <p><b>Parameter</b>            nn = 00—99: Alarm number</p> <p>data1 = yyyyymmdd            yyyy = 2000—2099: Gregorian calendar            mm = 01—12: Month            dd = 01—31: Day</p> <p>data2 = hhmmss            hh = 00—23: Hours (24-hour system)            mm = 00—59: Minutes            ss = 00—59: Seconds</p>	Queries the ALARM RECALL data.
[STX] QLE [ETX]	<p>[STX] LRIm [ETX]</p> <p><b>Parameter</b>            m = A: Alarm signal input is acknowledged.                  F: Alarm signal input is ignored.</p>	Queries the setting for the alarm recording and/or sensor recording to be performed if an alarm signal has been input while repeat recording is underway or while the tape is being rewound.
[STX] QLH [ETX]	<p>[STX] LHRhhhh [ETX]</p> <p><b>Parameter</b>            hhhh = 0000—9999            The cumulative drum rotation time in hours is returned as a 4-digit figure.</p>	Queries the current value of the hour meter.
[STX] QLM [ETX]	<p>[STX] LRMm [ETX]</p> <p><b>Parameter</b>            m = E: External timer recording                  I: Internal timer recording                  N: Regular recording</p>	Queries the timer recording mode setting.

## ■ Query control commands

Data transmitted by PC	Data returned from unit in response	Description of command
<p>[STX] QLP:n [ETX]</p> <p><b>Parameter</b> n = 0—3 Up to the last 4 sets of data are designated by this parameter with 0 serving as the latest data.</p>	<p>[STX] LPLnn:data1:data2 [ETX]</p> <p><b>Parameter</b> nn = 00—99: Alarm number</p> <p>data1 = yyyyymmdd yyyy = 2000—2099: Gregorian calendar mm: 01—12: Month dd = 01—31: Day</p> <p>data2 = hhmmss hh = 00—23: Hours (24-hour system) mm = 00—59: Minutes ss = 00—59: Seconds</p>	<p>Queries the POWER LOSS MEMORY data.</p>
<p>[STX] QLT [ETX]</p>	<p>[STX] LTMm [ETX]</p> <p><b>Parameter</b> t = 0: 3-hour recording 1: 9-hour recording 2: 12-hour recording 3: 18-hour recording 4: 24-hour recording 5: 48-hour recording 6: 72-hour recording 7: 96-hour recording 8: 120-hour recording 9: 180-hour recording A: 240-hour recording B: 360-hour recording C: 480-hour recording D: 960-hour recording</p>	<p>Queries the recording/playback time mode setting.</p>
<p>[STX] QLZ [ETX]</p>	<p>[STX] LBZm [ETX]</p> <p><b>Parameter</b> m = N: Buzzer ON F: Buzzer OFF</p>	<p>Queries the setting of the buzzer operation during alarm recording and/or sensor recording.</p>
<p>[STX] QMA [ETX]</p>	<p>[STX] LMAm [ETX]</p> <p><b>Parameter</b> m = F: Search mode OFF M: Memory stop mode A: Alarm search mode</p>	<p>Queries the search mode.</p>

## ■ Query control commands

Data transmitted by PC	Data returned from unit in response	Description of command				
[STX] QMP [ETX]	<p>[STX] LMPp:c0c1c2c3 [ETX]</p> <p><b>Parameter</b>            p = S: 1-screen display            0: 4-in-1 screen display;                Selected screen No.0            1: 4-in-1 screen display;                Selected screen No.1            2: 4-in-1 screen display;                Selected screen No.2            3: 4-in-1 screen display;                Selected screen No.3</p> <table border="1" data-bbox="603 611 762 730"> <tr> <td>0</td> <td>1</td> </tr> <tr> <td>2</td> <td>3</td> </tr> </table> <p>c0 = 0—F: Camera numbers designated for selected screen No.0            c1 = 0—F: Camera numbers designated for selected screen No.1            c2 = 0—F: Camera numbers designated for selected screen No.2            c3 = 0—F: Camera numbers designated for selected screen No.3</p>	0	1	2	3	<p>Queries the settings for the screen display (4-in-1 or 1-screen display) and camera numbers.</p>
0	1					
2	3					
[STX] QNL [ETX]	<p>[STX] LLLm [ETX]</p> <p><b>Parameter</b>            m = N: Line-lock type                F: Internal sync and external sync type</p>	<p>Queries the synchronization system of the camera connected.</p>				
[STX] QNR [ETX]	<p>[STX] VNRm [ETX]</p> <p><b>Parameter</b>            m = C: CAMERA                Video signals from camera            B: BLUE BACK                Blue background signals</p>	<p>Queries the setting for the video signals to be output to the monitor screen in all modes except the recording mode.</p>				

## ■ Query control commands

Data transmitted by PC	Data returned from unit in response	Description of command
[STX] QOP [ETX]	[STX] data [ETX] data = LIT: INTERNAL TIEMER RECORDING OSP: STOP OEJ: EJECT OFF: FAST FORWARD ORW: REWIND OSF: FORWARD SEARCH OSR: REVERSE SEARCH OPL: FORWARD PLAY OPP: PLAY PAUSE OPR: REVERSE PLAY ORC: REC ORP: REC PAUSE ORR: REC REVIEW POF: POWER OFF SAS: ALARM RECALL PLAY SCS: COUNTER SEARCH (STILL) SCP: COUNTER SEARCH (PLAY) SPT: PLAY to	Queries the unit's operation mode. The unit's current status is detected, and the status command is returned.
[STX] QOR [ETX]	[STX] ORm [ETX] <b>Parameter</b> m = O: REC REVIEW OK N: REC REVIEW NG	Queries the results yielded by performing REC REVIEW.
[STX] QOR [ETX]	[STX] ORm [ETX] <b>Parameter</b> m = O: REC REVIEW OK N: REC REVIEW NG	Queries the results yielded by performing REC REVIEW.
[STX] QOS [ETX]	[STX] OPSdata [ETX] data = AD0AD1AD2AD3AD4 <b>&lt;Note&gt;</b> For details on AD*, refer to Bitmap table (A).	Queries the unit's operation modes. The unit's current status is detected and sent in the form of bitmap information. The unit converts this bitmap information into ASCII codes which it then returns.

• Bitmap table (A)

ADDRESS	BIT7	BIT6	BIT5	BIT4	BIT3	BIT2	BIT1	BIT0
AD 0	0	0	0	0	0	0	0	0
AD 1	0	0	0	0	0	0	0	0
AD 2	REC INHIBIT TAB	CASSETTE IN/OUT	0	VTR STATUS				
AD 3	0	0	0	0	0	0	0	0
AD 4	0	0	0	0	0	0	0	0

**VTR STATUS DATA**

BIT4—BIT0	VTR STATUS	BIT4—BIT0	VTR STATUS
0, 1, 1, 1, 1	FORWARD SEARCH (7× normal speed)	0, 0, 1, 1, 1	PLAY PAUSE
0, 1, 1, 1, 0	REVERSE SEARCH (7× normal speed)	0, 0, 1, 1, 0	PLAY
0, 1, 1, 0, 1	FORWARD SEARCH (4× normal speed)	0, 0, 1, 0, 1	FORWARD SEARCH (1× normal speed)
0, 1, 1, 0, 0	REVERSE SEARCH (4× normal speed)	0, 0, 1, 0, 0	POWER OFF
0, 1, 0, 1, 1	REVERSE SEARCH (1× normal speed)	0, 0, 0, 1, 1	FAST FORWARD
0, 1, 0, 1, 0	REC REVIEW	0, 0, 0, 1, 0	REWIND
0, 1, 0, 0, 1	REC PAUSE	0, 0, 0, 0, 1	EJECT
0, 1, 0, 0, 0	RECORDING	0, 0, 0, 0, 0	STOP

## ■ Query control commands

Data transmitted by PC	Description of command	
<p>[STX] QPB:m [ETX]</p> <p><b>Parameter</b>            m = D: Date information                T: Time information                C: Camera connection information                R: Recording time mode information                A: Alarm number information                O: Monitor screen display information</p>	<p>Queries the playback tape information.</p>	
<p><b>Data returned from unit in response</b></p>		
<p>[STX] LPBm:r:data [ETX]</p>		
<p><b>Parameter</b></p>		
<p>m = D: Date information            r = O: READ OK            N: READ NG</p> <div style="border: 1px solid black; padding: 5px; margin: 5px 0;"> <p>data = yyyyymmdd              yyyy = 2000—2099: Gregorian calendar              mm = 01—12: Month              dd = 01—31: Day</p> </div> <p>m = T: Time information            r = O: READ OK            N: READ NG</p> <div style="border: 1px solid black; padding: 5px; margin: 5px 0;"> <p>data = hhmmss              hh = 00—23: Hours              mm = 00—59: Minutes              ss = 00—59: Seconds</p> </div> <p>m = C: Camera connection information            r = O: READ OK            N: READ NG</p> <div style="border: 1px solid black; padding: 5px; margin: 5px 0;"> <p>data = C13-16C9-12C5-8C1-4              C13-16 = 1—F: Connection information for camera No.13—16              C9-12 = 1—F: Connection information for camera No.9—12              C5-8 = 1—F: Connection information for camera No.5—8              C1-4 = 1—F: Connection information for camera No.1—4</p> <p><b>&lt;Note&gt;</b>              For details on C*, refer to the camera connection information table.</p> </div>	<p>m = R: Recording time mode information            r = O: READ OK            N: READ NG</p> <div style="border: 1px solid black; padding: 5px; margin: 5px 0;"> <p>data = t              t = 0: 3-hour recording              1: 9-hour recording              2: 12-hour recording              3: 18-hour recording              4: 24-hour recording              5: 48-hour recording              6: 72-hour recording              7: 96-hour recording              8: 120-hour recording              9: 180-hour recording              A: 240-hour recording              B: 360-hour recording              C: 480-hour recording              D: 960-hour recording</p> </div> <p>m = A: Alarm number information            r = O: READ OK            N: READ NG</p> <div style="border: 1px solid black; padding: 5px; margin: 5px 0;"> <p>data = nn              nn = 00—99: Alarm number              FF: No alarm data</p> </div>	<p>m = O: Monitor screen display information            r = O: READ OK            N: READ NG</p> <div style="border: 1px solid black; padding: 5px; margin: 5px 0;"> <p>data = xx:yy:d1d2              xx = 00—22: Position of head character (in horizontal direction)              Position from left when monitor screen has been divided horizontally into 22 segments.              yy = 00—14: Position of head character (in vertical direction)              Position from top when monitor screen has been divided vertically into 14 segments.              d1d2 = 00—FF: Monitor screen display ON/OFF</p> <p><b>&lt;Note&gt;</b>              For details on d1d2, refer to the monitor screen display information table.</p> </div>

● Camera connection information table

Return command	Camera No. and connection ON (O)/OFF (X)			
	No. 1 (5, 9, 13)	No. 2 (6, 10, 14)	No. 3 (7, 11, 15)	No. 4 (8, 12, 16)
1	O	X	X	X
2	X	O	X	X
3	O	O	X	X
4	X	X	O	X
5	O	X	O	X
6	X	O	O	X
7	O	O	O	X
8	X	X	X	O
9	O	X	X	O
A	X	O	X	O
B	O	O	X	O
C	X	X	O	O
D	O	X	O	O
E	X	O	O	O
F	O	O	O	O

● Monitor screen display information table

Return command (d1)	Monitor screen display information ON (O)/OFF (X)			
	Camera No.	Time	Date	Alarm number
0	X	X	X	X
1	O	X	X	X
2	X	O	X	X
3	O	O	X	X
4	X	X	O	X
5	O	X	O	X
6	X	O	O	X
7	O	O	O	X
8	X	X	X	O
9	O	X	X	O
A	X	O	X	O
B	O	O	X	O
C	X	X	O	O
D	O	X	O	O
E	X	O	O	O
F	O	O	O	O

Return command (d2)	Monitor screen display information ON (O)/OFF (X)			
	Recording time mode	24-/12-hour system display	—	—
0	X	X	X	X
1	O	X	X	X
2	X	O	X	X
3	O	O	X	X
4	X	X	O	X
5	O	X	O	X
6	X	O	O	X
7	O	O	O	X
8	X	X	X	O
9	O	X	X	O
A	X	O	X	O
B	O	O	X	O
C	X	X	O	O
D	O	X	O	O
E	X	O	O	O
F	O	O	O	O



## ■ Query control commands

Data transmitted by PC	Data returned from unit in response	Description of command
[STX] QRA [ETX]	[STX] RA <sub>m</sub> [ETX] m = N: ACK ON F: ACK OFF	Queries the ACK (acknowledge) code response setting.
[STX] QRE [ETX]	[STX] LRB <sub>m</sub> [ETX] <b>Parameter</b> m = F: Buzzer OFF 0: 5 minutes 1: 10 minutes 2: 20 minutes 3: 30 minutes	Queries the setting of the buzzer operation in the event that the unit is kept in the stop mode for a prolonged period of time.
[STX] QRF [ETX]	[STX] LNRf:p:t [ETX] <b>Parameter</b> f = I: Field recording R: Frame recording  p = H: HIGH Recording at a high picture quality N: NORMAL Recording at the standard picture quality  t = 0—7: Recording type (RT0—7)	Queries the recording mode, picture quality and recording type settings.
[STX] QRR [ETX]	[STX] LRR <sub>m</sub> [ETX] <b>Parameter</b> m = N: REC REVIEW is performed automatically. F: REC REVIEW OFF	Queries the REC REVIEW setting.
[STX] QRS [ETX]	[STX] RSE <sub>m</sub> [ETX] <b>Parameter</b> m = 0: Normal 1: No command upon completion 2: No command upon completion/when an error has occurred	Queries the search end mode setting.
[STX] QRV:m [ETX] <b>Parameter</b> m = D: ROM version of digital video microcomputer S: Version of servo syscon microcomputer I: ROM version of interface No parameter: ROM version of interface	[STX] VERdata [ETX] <b>Parameter</b> data = d1d2.d3d4-d5d6-d7.d8d9 d1—d9: Software version	Queries the versions of the software used with each of the microcomputers.

## ■ Query control commands

Data transmitted by PC	Data returned from unit in response	Description of command
[STX] QSQ [ETX]	[STX] LSQm:t [ETX] <b>Parameter</b> m = 0—F: Camera No. 1—16 t = A: Auto sequence mode M: Manual sequence mode	Queries the camera number selection and sequence mode.
[STX] QST [ETX]	[STX] LSTdata1:data2 [ETX] <b>Parameter</b> data1 = ndmmtt (start date/time) data2 = ndmmtt (end date/time) n = 1: 1st week 2: 2nd week 3: 3rd week 4: 4th week L: Last week d = 0: Sunday 1: Monday 2: Tuesday 3: Wednesday 4: Thursday 5: Friday 6: Saturday mm = 01—12: Month tt = 01—22: Hours	Queries the start date/time and end date/time of daylight saving time.
[STX] QSU [ETX]	[STX] LSUm [ETX] <b>Parameter</b> m = N: Daylight saving time setting ON F: Daylight saving time setting OFF	Queries the ON/OFF setting for daylight saving time.
[STX] QTA [ETX]	[STX] TATmm:S [ETX] <b>Parameter</b> data = mm:n mm = 00—23: Digits of hours to be set FF: Sets minute digits to 00. n = S (fixed)	Queries the setting of the time to be set when signals have been input from the component connected to TIME ADJ IN on the rear panel terminal section.
[STX] QTC [ETX]	[STX] TTSdata [ETX] <b>Parameter</b> data = hhmmss hh = 00—23: Hours (24-hour mode) mm = 00—59: Minutes ss = 00—59: Seconds	Queries the current time setting.
[STX] QTL [ETX]	[STX] TCSdata [ETX] <b>Parameter</b> data = yyyyymmdd yyyy = 2000—2099: Gregorian calendar mm = 01—12: Month dd = 01—31: Day	Queries the current date setting.

## ■ Query control commands

Data transmitted by PC	Data returned from unit in response	Description of command
<p>[STX] QTR [ETX]</p>	<p>[STX] HTRm:b [ETX]</p> <p><b>Parameter</b>            m = 0: 2% of tape remaining            1: 10% of tape remaining            2: 20% of tape remaining            3: 30% of tape remaining            F: (OFF) no warning            b = N: Warning is sounded by buzzer.            F: (OFF) warning is not sounded by buzzer.</p>	<p>Queries the setting for the remaining tape amount for which REMAIN is to flash on the display tube as a warning display, and the setting for the buzzer to sound when the tape-end position is about to be reached.            (When a 120-minute tape is used)</p>
<p>[STX] QTY:n [ETX]</p> <p><b>Parameter</b>            n = 1—6: Recording type (RT1—6)</p>	<p>[STX] LTYn:t:abcdefgh [ETX]</p> <p><b>Parameter</b>            n = 1—6: Recording type (RT1—6)            t = 0: 3-hour recording            1: 9-hour recording            2: 12-hour recording            3: 18-hour recording            4: 24-hour recording            5: 48-hour recording            6: 72-hour recording            7: 96-hour recording            8: 120-hour recording            9: 180-hour recording            A: 240-hour recording            B: 360-hour recording            C: 480-hour recording            D: 960-hour recording            F: OFF (setting of TIME MODE button is complied with)            a = Y or N: for setting cameras No.1 and 2            b = Y or N: for setting cameras No.3 and 4            c = Y or N: for setting cameras No.5 and 6            d = Y or N: for setting cameras No.7 and 8            e = Y or N: for setting cameras No.9 and 10            f = Y or N: for setting cameras No.11 and 12            a = Y or N: for setting cameras No.13 and 14            h = Y or N: for setting cameras No.15 and 16            Y: Used            N: Not used</p>	<p>Queries the setting for the combination of the recording time mode and number of cameras.</p>

## ■ Query control commands

Data transmitted by PC	Data returned from unit in response	Description of command
[STX] QUI [ETX]	<p>[STX] LUISdata [ETX]</p> <p><b>Parameter</b> data = U7U6U5U4U7U3U2U1U0</p> <p>Sets the user ID to be written using an ASCII code. Binary 4BIT×8 ↓ ASCII code: 0—9, A—F</p>	Queries the setting of the user ID to be recorded.
[STX] QVC [ETX]	<p>[STX] VVCm:data [ETX]</p> <p><b>Parameter</b> m = A: Execution of detection processing by VCC command underway S: Detection processing by VCC command completed or detection stopped</p> <p>data = C13-16C9-12C5-8C1-4 C13-16 = 1—F: Connection information for camera No.13—16 C9-12 = 1—F: Connection information for camera No.9—12 C5-8 = 1—F: Connection information for camera No.5—8 C1-4 = 1—F: Connection information for camera No.1—4</p> <p>&lt;Note&gt; For details on C*, refer to the Camera connection information table.</p>	<p>Queries the results of detecting whether the video input signals are present.</p> <p>&lt;Note&gt; When the POWER switch is at OFF, the signals are not detected, and an error results. Initiate the detection processing using the VVC command before executing the QVC command. Correct results cannot be obtained unless processing has been completed using the VVC command.</p>
[STX] QVM [ETX]	<p>[STX] VMDm [ETX]</p> <p><b>Parameter</b> m = A: AUTO Color is switched automatically in accordance with the input signals. B: B/W Monochrome</p>	Queries the color setting for the video output signals.
[STX] QWB [ETX]	<p>[STX] LWBm [ETX]</p> <p><b>Parameter</b> m = N: Buzzer ON F: Buzzer OFF</p>	Queries the setting for whether the buzzer is to sound when a problem occurs in the unit and the power is automatically turned off.
[STX] QXT [ETX]	<p>[STX] LXTm [ETX]</p> <p><b>Parameter</b> m = N: Signals are acknowledged. F: Signals are not acknowledged.</p>	Queries the setting for whether the signals from the external timer connected to the rear panel terminal section are to be acknowledged in the external timer recording mode.

## ■ Mode transition table

Return command	VTR STATUS													
	STOP	FF	REW	PLAY	REV PLAY	STILL/ PAUSE	CUE	REVIEW	REC PAUSE	REC	REC CHECK	EJECT	POWER OFF	
OPR	○	○	○	○	○	○	○	○	○	×	×	×	×	×
OPL	○	○	○	—	○	○	○	○	○	×	×	×	×	×
OSP	—	○	○	○	○	○	○	○	○	○	○	○	×	×
OPA	○	○	○	○	○	PLAY	○	○	○	REC	REC PAUSE	×	×	×
ORW	○	○	○	○	○	○	○	○	○	×	×	×	×	×
OFF	○	○	○	○	○	○	○	○	○	×	×	×	×	×
OAF	×	×	×	×	×	○	×	×	×	×	×	×	×	×
OAR	×	×	×	×	×	○	×	×	×	×	×	×	×	×
OEJ	○	○	○	○	○	○	○	○	○	○	○	○	—	×
ORR	×	×	×	×	×	×	×	×	×	○	—	×	×	×
ORC	○	○	○	○	○	REC PAUSE	○	○	○	○	—	○	×	×
PON	—	—	—	—	—	—	—	—	—	—	—	—	—	○
POF	○	○	○	○	○	○	○	○	○	○	○	○	○	—
Search command	○	○	○	○	○	○	○	○	○	×	×	×	×	×

<Note>



- : Operation changes to a return command mode.
- ×
- : The operation status is retained.

**OPA command** : This command may cause the unit to transfer from its current operation mode to a different operation mode.

**Search commands** : OPT, SCP, SCS, SMS, SPT, SRS, SUB

# Error messages

When a problem has occurred in the unit, one of the following messages appears on the counter display. If the error is not released even after taking the suggested remedial action, set the POWER switch to OFF, disconnect the power cord, and consult your dealer.

Error No.	Description of problem	Remedial action
— d —	Condensation has formed. The only function button which can be operated is the EJECT button. The loading operation is not performed when a cassette tape has been inserted. The cylinder rotates when a cassette tape has not been inserted.	Wait with the power on until the error message is cleared.
E — 2	This appears when the cassette tape has not been inserted correctly or it has not been ejected 2 to 5 seconds or so after the EJECT button has been pressed. The power is automatically turned off.	Turn the power off and back on again.
E — 3	This appears when the loading or unloading operation is not completed even after 2 to 5 seconds or so have elapsed. The power is automatically turned off.	
E — 4	This appears when the rotational speed of the cylinder motor is abnormally low. The power is automatically turned off.	Deterioration of the cassette tape may be to blame. Turn the power off and back on again, and replace the cassette tape.
E — 5	This appears when an abnormal torque applied to the reel motor, etc. has been detected. The power is automatically turned off.	
E — 6	This appears when the tape transport becomes unstable. The power is automatically turned off.	
E — 7	This appears when a problem occurs in the solenoid controlling the reel base. The power is automatically turned off.	Turn the power off and back on again.
 (flashes)	"  " flashes when the proper video level could not be achieved after REC REVIEW.	Dirty heads or deterioration of the cassette tape may be to blame. Clean the heads or replace the cassette tape.

## ***Video head cleaning***

---

This unit comes with an auto head cleaning function to reduce the amount of dirt on the heads automatically. However, to further improve reliability, it is recommended that the video heads be cleaned as and when appropriate.

For details on the actual cleaning method to be used, consult a representative at one of our servicing companies or your dealer.

## ***Condensation***

---

Condensation occurs according to the same principle as when droplets of water form on the window panes of a heated room. It occurs when the unit or its tapes are moved to a location with a very different temperature and/or humidity level. Specifically, it occurs:

- In a highly humid location where steam is trapped or when the unit is moved to a room immediately after the heater was turned on
- When the unit is suddenly moved from an air-conditioned location to a hot or very humid location

After the unit is moved to such a location, leave the unit or tapes standing for about 10 minutes before turning on the power.

If condensation has formed on the unit, the error message (- d -) lights on the counter display, and the cassette tape is automatically ejected.

Keep the power on, and wait until the error message is cleared.

## ***Maintenance***

---

Before proceeding with maintenance, always set the POWER switch to OFF, and disconnect the power cord from the power outlet by pulling the molded part of the power plug.

Use a soft cloth to clean the cabinet. To remove stubborn dirt, dilute some kitchen detergent, soak a cloth in the solution, wring it out well and wipe. Use a dry cloth to take up any remaining moisture. Do not use thinners or benzine.

# Specifications

## [GENERAL]

<b>Supply voltage:</b> AC 120 V, 50 Hz – 60 Hz
<b>Power consumption:</b> 37 W

**Ambient operating temperature:**

41°F to 104°F (5°C to 40°C)

**Ambient operating humidity:**

35% to 85% (no condensation)

**Dimensions (W×H×D):**

15"×4 3/8"×13 7/16" (380×110×340 mm)

**Weight:**

15.84 lb (7.2 kg)

**Recording system:**

D-TL recording system  
(DV compression multi-segment recording)

**Recording track:**

Audio signal, Linear: 1 track

**Tape speed:**

20.84 mm/sec. (3-hour mode)

**Tape used:**

S-VHS standard tape (120-minute tape recommended)

**Recording time modes:**

3, 9, 12, 18, 24, 48, 72, 96, 120, 180, 240, 360, 480 and 960 hours

**FF/REW time:**

Less than 3 minutes (using 120-minute tape)

## [VIDEO]

**Horizontal resolution**

HIGH : More than 520 lines (B&W/COLOR)

NORMAL : More than 380 lines (B&W/COLOR)

**S/N ratio:**

HIGH : Better than 50 dB (B&W/COLOR)

NORMAL : Better than 50 dB (B&W/COLOR)

**Camera inputs (BNC) × 16:**

1.0 V [p-p], 75 Ω, (loop-through, 75 Ω ON/OFF) unbalanced

**S-VIDEO OUT (4P):**

Luminance signal:

1.0 V [p-p]

Chrominance signal:

0.286 V [p-p] (burst level)

75 Ω, unbalanced

**External switcher input/video output (BNC):**

1.0 V [p-p], 75 Ω, unbalanced

**VIDEO OUT (BNC):**

1.0 V [p-p], 75 Ω, unbalanced

## [AUDIO]

**S/N ratio:**

42 dB (3-hour mode, "A" weighted)

**Frequency response:**

70 Hz to 7 kHz (3-hour mode)

**Recording/Playback time modes:**

3, 9, 12, 18 and 24 hours

**Audio input (pin jack):**

-10 dBV, 47 kΩ, unbalanced

**Mic input:**

-60 dBV, 600 Ω to 4.7 kΩ, unbalanced

**Audio output (pin jack):**

-8 dBV, 600 Ω, unbalanced

## [TERMINAL SECTION]

**Inputs:**

ALARM IN 1, ALARM IN 2, ALARM RESET IN, REC IN, EXT TIMER IN, TIME ADJ IN

**Outputs:**

ALARM OUT, EXT TIMER OUT, TAPE END OUT, WARNING/REC OUT

## [OTHER]

**REMOTE connector:**

Exclusively designed for AG-A11 remote controller (optional accessory)

**RS-232C connector:**

D-sub, 9 pins, RS-232C interface

## [ACCESSORIES]

**Power cord:**

× 1





---

# Panasonic

## **VIDEO IMAGING SYSTEMS COMPANY**

A Division of Panasonic Broadcast & Television Systems Company  
A Unit of Matsushita Electric Corporation of America

**Executive Office:** One Panasonic Way 3E-7, Secaucus, New Jersey 07094

### **REGIONAL OFFICES:**

**Northeast:** One Panasonic Way, Secaucus, NJ 07094 (201) 348-7303

**Southern:** 1225 Northbrook Parkway, Suite 1-160, Suwanee, GA 30024 (770) 338-6838

**Midwest:** 1707 North Randall Road, Elgin, IL 60123 (847) 468-5211

**Western:** 6550 Katella Ave., Cypress, CA 90630 (714) 373-7840

### **Panasonic Canada Inc.**

5770 Ambler Drive, Mississauga, Ontario L4W 2T3 (905) 624-5010

### **Panasonic Sales Company**

**Division of Matsushita Electric of Puerto Rico Inc.**

San Gabriel Industrial Park, 65th Infantry Ave., Km. 9.5, Carolina, Puerto Rico 00630 (787) 750-4300

## Free Manuals Download Website

<http://myh66.com>

<http://usermanuals.us>

<http://www.somanuals.com>

<http://www.4manuals.cc>

<http://www.manual-lib.com>

<http://www.404manual.com>

<http://www.luxmanual.com>

<http://aubethermostatmanual.com>

Golf course search by state

<http://golfingnear.com>

Email search by domain

<http://emailbydomain.com>

Auto manuals search

<http://auto.somanuals.com>

TV manuals search

<http://tv.somanuals.com>