

# Operating Instructions



**SUPER DRIVE**



Model No.

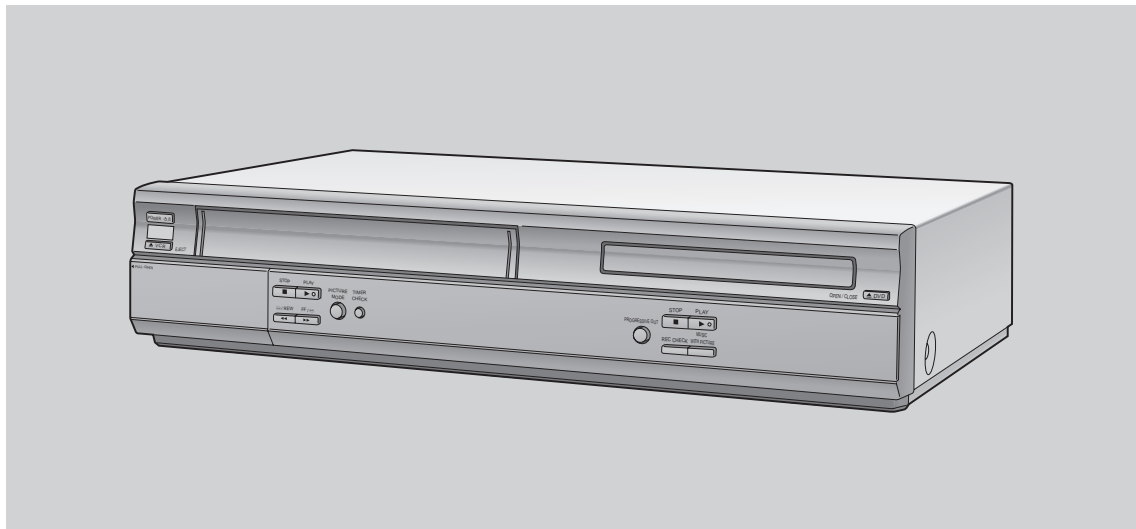

**Panasonic**  
Professional/Industrial Video

## DVD Player/Video Cassette Recorder

Before attempting to connect, operate or adjust this product, please read these instructions completely.

VQT0C73-1

# Contents

## Before Use

<b>Dear Customer</b> .....	<b>3</b>
Accessories .....	3
<b>Usage Precautions</b> .....	<b>5</b>
<b>Video deck and cassette tape information</b> .....	<b>5</b>
<b>Disc information</b> .....	<b>6</b>
<b>Control reference guide</b> .....	<b>7</b>
FRONT .....	7
REAR .....	7
The unit's display .....	8
Infra-red Remote Controller .....	9
<b>The remote control</b> .....	<b>11</b>
Installing the Batteries .....	11
Use .....	11
<b>Connections</b> .....	<b>12</b>
Basic Connections .....	12
Connection to a TV using the Audio/Video Input Sockets .....	12
To enjoy DVD video with a higher image quality .....	13
<b>Cable Connection</b> .....	<b>14</b>
<b>Tuning the TV to your unit</b> .....	<b>15</b>
Plug in Auto Tuning .....	15

## VCR

<b>VCR Playback</b> .....	<b>17</b>
Basic Playback .....	17
Other Playback Functions .....	18
Tracking Adjustment and Vertical Locking Adjustment .....	19
<b>Manual Recording</b> .....	<b>20</b>
One-Touch Recording (OTR) .....	21
<b>Timer Recording</b> .....	<b>22</b>
To Program with the On Screen Display (OSD) .....	22
<b>Search Functions</b> .....	<b>24</b>
Jet Navigator .....	24
To Check the Recorded Programming Data (Time Stamp Function) .....	26
To Find the Beginning of Each Recording (VHS Index Search System) .....	26
Searching while checking the video cassette contents (Intro-Jet Scan) .....	27
<b>Other Functions</b> .....	<b>27</b>
To Delete all of a Cassette's Contents (Tape Refresh Function) .....	27
<b>Settings Using the On Screen Display</b> .....	<b>28</b>
Common procedure .....	28
To Select the Desired Language .....	28
Setting the Clock of your unit .....	28
Channel Set .....	29
Option .....	30
Onscreen display .....	31
Changing audio .....	31

## DVD

<b>Playing discs</b> .....	<b>32</b>
Basic play .....	32
Starting play from where you stopped it .....	33
To immediately access a specific scene or track .....	34
<b>Other methods of play</b> .....	<b>35</b>
<b>Playing the programs or play lists on DVD-RAM</b> .....	<b>37</b>
Selecting a program to play (Direct Navigator) .....	37
To play back favorite scenes only (Play lists) .....	37
<b>MP3/WMA and CD text navigating menus</b> .....	<b>38</b>
<b>To get more enjoyment from movies and music</b> .....	<b>40</b>
To switch subtitle, audio or angle-view .....	40
To change the settings in accordance with the software .....	41
<b>Using On-Screen Menu Icons</b> .....	<b>43</b>
Common procedures .....	43
Disc information .....	44
Progress indicator .....	44
Unit information .....	45
<b>Enjoying more powerful sound</b> .....	<b>47</b>
To connect to external audio devices .....	47
<b>Changing settings</b> .....	<b>48</b>
Common procedures .....	48
SET UP menus .....	49
Quick Setup .....	50
Entering a password (Ratings) .....	51
Digital output .....	51

## Others

<b>Editing</b> .....	<b>52</b>
Assemble Editing .....	52
Adding Music to Video (MUSIC WITH PICTURE) .....	53

## Helpful Hints

<b>Error Messages</b> .....	<b>54</b>
On Screen Display .....	54
Self-diagnostic Indications .....	54
<b>Before Requesting Service</b> .....	<b>55</b>
<b>Glossary</b> .....	<b>58</b>
<b>Q&amp;A</b> .....	<b>60</b>
<b>Specifications</b> .....	<b>61</b>
<b>Index</b> .....	<b>63</b>

# Dear Customer

Thank you for purchasing this product.  
For optimum performance and safety, please read these instructions carefully.

- Operations in these instructions are described mainly with the remote control, but you can do the operations on the main unit if the controls are the same.

## Accessories

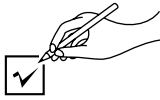

Please check and identify the supplied accessories. Use numbers indicated in parentheses when asking for replacement parts.

- 1 pc. Infrared Remote Controller  
(EUR7615LB0)

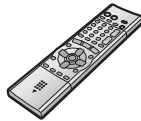

- 1 pc. Coaxial Cable



- 1 pc. AC Power Cord

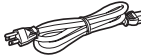

- 2 pcs. "R6" size Batteries



The model number and serial number of this product can be found on either the back or the bottom of the unit. Please note them in the space provided below and keep for future reference.

MODEL NUMBER **AG-VP300P**

SERIAL NUMBER \_\_\_\_\_

### User memo:

DATE OF PURCHASE \_\_\_\_\_

DEALER NAME \_\_\_\_\_

DEALER ADDRESS \_\_\_\_\_

TELEPHONE NUMBER \_\_\_\_\_

Apparatus Claims of U.S. Patent Nos. 4,631,603, 4,577,216, and 4,819,098, licensed for limited viewing uses only.

This product incorporates copyright protection technology that is protected by method claims of certain U.S. patents and other intellectual property rights owned by Macrovision Corporation and other rights owners. Use of this copyright protection technology must be authorized by Macrovision Corporation, and is intended for home and other limited viewing uses only unless otherwise authorized by Macrovision Corporation. Reverse engineering or disassembly is prohibited.

Manufactured under license from Dolby Laboratories. "Dolby" and the double-D symbol are trademarks of Dolby Laboratories.

Manufactured under license from Digital Theater Systems, Inc. US Pat. No. 5,451,942, 5,956,674, 5,974,380, 5,978,762 and other world-wide patents issued and pending. "DTS" and "DTS Digital Surround" are registered trademarks of Digital Theater Systems, Inc. Copyright 1996, 2000 Digital Theater Systems, Inc. All rights reserved.

Windows Media, and the Windows logo are trademarks, or registered trademarks of Microsoft Corporation in the United States and/or other countries.

WMA is a compression format developed by Microsoft Corporation. It achieves the same sound quality as MP3 with a file size that is smaller than that of MP3.

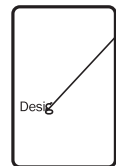

MPEG Layer-3 audio decoding technology licensed from Fraunhofer IIS and Thomson multimedia.



Please read these precautions before

**■ Avoid Sudden Change**

If this unit is suddenly moved from a cold place to a warm place, dew may form on the tape

**■ Humidity and**

Avoid places where humidity is high, which may cause

**Do not**

The video heads are sensitive to cleaning fluid or dust. Do not use any cleaning fluid or dust to remove any dust. Do not place anything

Do not place anything

Do not place anything

Do not place anything

Do not place anything

Do not place anything

Do not place anything

Do not place anything

Do not place anything

Do not place anything

Do not place anything

Do not place anything

Do not place anything

Do not place anything

Do not place anything

Do not place anything

Do not place anything

Do not place anything

Do not place anything

Do not place anything

Do not place anything

Do not place anything

Do not place anything

Do not place anything

Do not place anything

Do not place anything

Do not place anything

Do not place anything

Do not place anything

Do not place anything

Do not place anything

## tape information

### Dirt on the video heads

If the video heads get dirty, pictures will not be recorded or played back clearly. (See the following conditions.)

**Normal picture**   **Small amount of dirt**   **Large amount of dirt**



If this happens, insert and eject a cassette 5–10 times successively to remove the dirt from the video heads.

If a clear picture is not produced, insert a commercially available cleaning cassette. Then, press **[RECO] (●REC/OTR)** (→ page 7, 9) and keep it running for approximate 10 seconds to clean the video heads.

If the problem still persists after performing all of the measures listed above, contact a service personnel to request assistance.

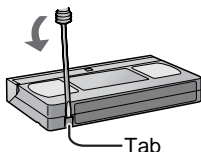
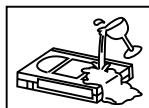

Heads mainly become dirty because of scratched or dirty tapes, use of the unit in places where temperature and humidity are high, dust in the air and the other reasons.

Never use tapes on which juice has been spilt or those that are extremely damaged since this will not only cause the heads to become dirty, but will also make the unit malfunction.



# Disc information

## Discs that can be played

Disc type	Logo	Indication in these operating instructions*
DVD-RAM		<b>RAM</b> Shown as "DVD-VR" on the display
DVD-Video		<b>DVD-V</b>
DVD-R		
Video CD		<b>VCD</b>
CD		<b>CD</b> <b>CDtext</b>
CD-R/RW	—	<b>MP3</b> <b>WMA</b>

### \*Discs you can use

These indications show you the features you can use with the different types of discs.

- Use discs with the above logos and that conform to specifications. The unit cannot play other discs correctly.
- Do not use irregularly shaped discs (e.g. heart-shaped), as these can damage the unit.
- It may not be possible to play CD-R, CD-RW, DVD-R and DVD-RAM in all cases due to the type of disc or condition of the recording.

## Discs that cannot be played

PAL discs, DVD-ROM, DVD-Audio, CD-ROM, CDV, CD-G, +RW, DVD-RW, CVD, SVCD, SACD, Divx Video Discs and Photo CD, DVD-RAM that cannot be removed from their cartridge, and 2.6-GB and 5.2-GB DVD-RAM, etc.

## DVDs that can be played

You can play discs with these symbols.



## Disc structure

Disc structure and the labels given to the items on discs depend on the disc type.

- Track:** the smallest division on CDs and Video CDs, or a single MP3/WMA file.
- Chapter:** the smallest division on DVD-Video.
- Group:** collections of tracks and equivalent to folders on data discs.
- Title:** the largest division on DVD-Video, usually an entire movie.
- Program:** the division on DVD-RAM equivalent to a single recording.
- Play list:** the group of scenes on DVD-RAM.
- Scene:** DVD-RAM program sections specified and grouped into play lists on a DVD video recorder.

## DVD-RAM discs

The DVD-RAM you can play on this unit are those recorded with DVD video recorders, DVD video cameras, personal computers, etc. using Version 1.1 of the Video Recording Format (a unified video recording standard).

- Remove discs from their cartridges before use and return them when you are finished, making sure that the labels of the disc and cartridge face the same way.
- Some parts of the disc, for example where one program ends and another begins, may not play smoothly.

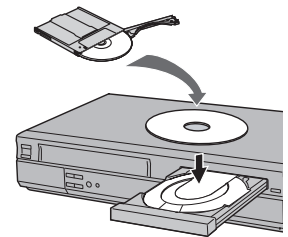

## DVD-R discs

Panasonic DVD-R discs recorded and finalized (a process that allows play on compatible equipment) on a Panasonic DVD video recorder or DVD video camera are played as DVD-Video on this unit.

## CD-R and CD-RW discs

This unit can play CD-R/RW (audio recording disc) recorded with CD-DA, video CD, MP3, or WMA. Close the session or finalize (a process that allows play on compatible equipment) after recording.

## Playing DVDs and Video CDs

The producer of these discs can control how they are played so you may not always be able to control play as described in these operating instructions (for example if the play time is not displayed or if a Video CD has menus). Read the disc's instructions carefully.

## To clean discs

### DVD-Video, Video CD, CD

Wipe with a damp cloth and then wipe dry.

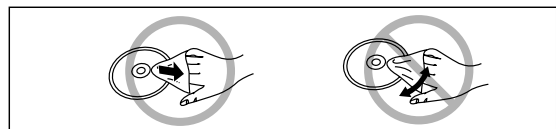

### DVD-RAM, DVD-R

- Clean with an optional DVD-RAM/PD disc cleaner (LF-K200DCA1, where available).
- Never use cloths or cleaners for CDs etc.

## Handling precautions

- Do not write on the label side with a ball-point pen or other writing instrument.
- Do not use record cleaning sprays, benzene, thinner, static electricity prevention liquids or any other solvent.
- Do not attach labels or stickers to discs. (Do not use discs with exposed adhesive from tape or left over peeled-off stickers.)
- Do not use scratch-proof protectors or covers.
- Do not use discs printed with label printers available on the market.

## Region number supported by this player

Region numbers are allocated to DVD players and software according to where they are sold.

The region number of this player is "1".

The player will play DVD-Video marked with labels containing "1" or "ALL".

Examples:



# Control reference guide

This section describes in detail the function of each button, switch and connection socket.

## FRONT

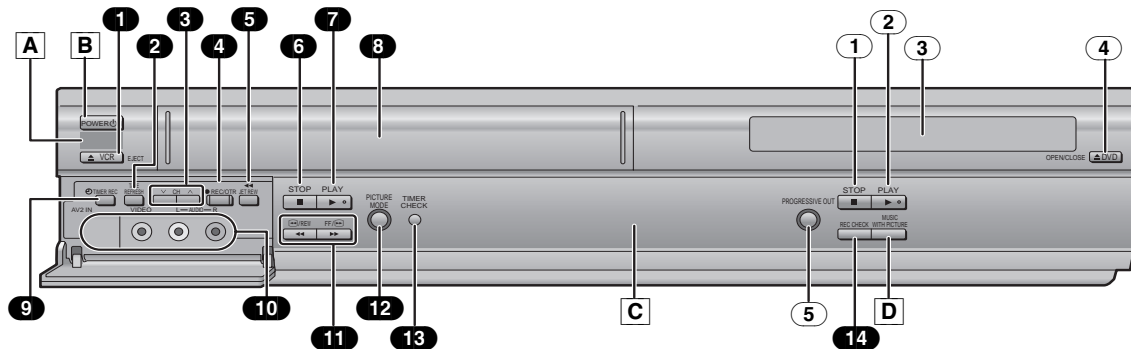

### Common section

- A** Infra-red remote control receiver window
- B** **POWER** button  
Press [POWER] to switch this unit from on to standby mode or vice versa. In standby mode, the unit is still connected to the main AC power.
- C** Display
- D** **MUSIC WITH PICTURE** button ..... (→page 53)

### VCR section

- 1** Tape eject button (▲VCR EJECT) ..... (→page 17)
- 2** TAPE REFRESH button ..... (→page 27)
- 3** Channel up/down buttons (CH $\nabla$ / $\wedge$ ) ..... (→page 19,20)
- 4** Recording/One-Touch Recording button (●REC/OTR) ..... (→page 20,21)
- 5** Jet Rewind button (◀◀JET REW) ..... (→page 17)
- 6** Stop button ..... (→page 17)
- 7** Play button ..... (→page 17)

### Cassette compartment

- 8** Cassette compartment
- 9** Timer recording button (⌚TIMER REC) ..... (→page 22)
- 10** AV2 IN (AUDIO/VIDEO) sockets ..... (→page 52)
- 11** Fast-forward/rewind buttons (◀◀/REW, FF/▶▶) ..... (→page 17)
- 12** PICTURE MODE button ..... (→page 19)
- 13** Timer program check button (TIMER CHECK) ..... (→page 23)
- 14** Record check button (REC CHECK) ..... (→page 21)

### DVD section

- 1** Stop button ..... (→page 33)
- 2** Play button ..... (→page 32)
- 3** Disc tray
- 4** Disc tray open/close button (▲DVD OPEN/CLOSE) ..... (→page 32)
- 5** PROGRESSIVE OUT button ..... (→page 33)

## REAR

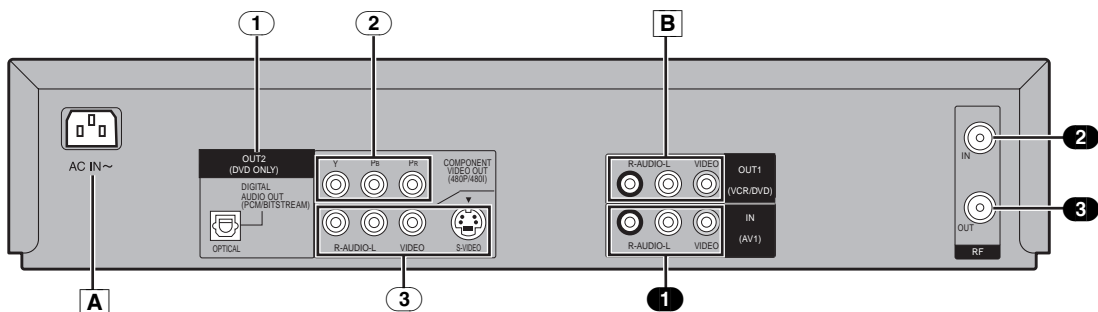

### Common section

- A** AC Input socket
- B** OUT1 (VCR/DVD) terminal

### VCR section

- 1** AUDIO IN/VIDEO IN (AV1) sockets ..... (→page 52)
- 2** RF IN socket
- 3** RF OUT socket

### DVD section

- 1** OUT2 (DVD ONLY) terminal/DIGITAL AUDIO OUT (OPTICAL, PCM/BIT STREAM) ..... (→page 47)
- 2** OUT2 (DVD ONLY) terminal/COMPONENT VIDEO OUT (480P/480i) .... (→page 13)
- 3** OUT2 (DVD ONLY) terminal/AUDIO/VIDEO/S-VIDEO OUT ..... (→page 13)

## The unit's display

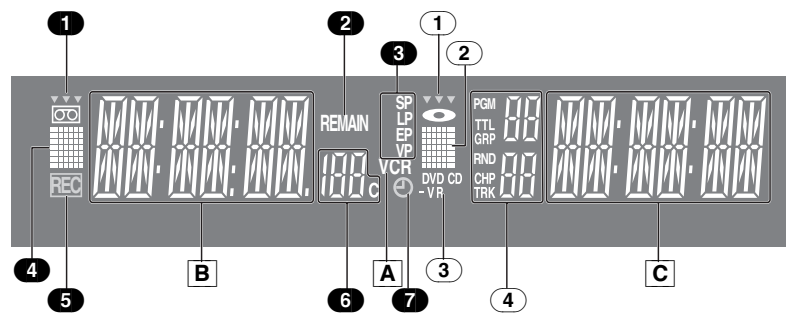

### Common section

- A VCR indicator** .....(→page 17,20)
- When video on this unit is viewed: (Only when the audio/video cable is not connected →page 12)
- B Main display**
- Current time
  - VCR recording and play counter
  - Timer recording Start time
  - Miscellaneous messages, etc.
- C Main display (orange)**
- Disc play counter
  - Timer recording end time
  - Miscellaneous messages, etc.

### VCR section

- 1 “” indication** .....(→page 17)
- Lights up when a cassette is inserted.
  - Flashes when recording or timer recording is attempted with no cassette inserted.
  - “▼▼▼” indicates that the output selected is “VCR”. It flashes for approx. 5 seconds immediately after the output is switched.
- 2 Tape remaining display indicator** .....(→page 20)
- Lights up when the remaining time on a cassette is displayed.
- 3 Tape speed indicator**.....(→page 20)
- SP: When recording or playing in the Normal mode
  - LP: When playing in the Long play mode.
  - EP: When recording or playing in the Extra long play mode.
  - VP: When recording or playing in the five-time (Long play) mode.
- 4 Tape operation status** .....(→page 17,20)
- The operation status of this unit, such as playback, fast forward (or fast rewind)

- 5 Recording indicator (REC) (red)** ..... (→page 20)
- On:** while recording or while a timer recording is being performed
- 6 Channel display** ..... (→page 20)
- 1, 2, 3, ....., 125 / A1, A2
  - Indicates the channel while in the TV reception mode or the channel set for timer recording.
- 7 Timer program display (red)** ..... (→page 22)
- On:** when a timer recording is in standby mode, or being performed

### DVD section

- 1 “” indication**..... (→page 17)
- Lights up when a disc is inserted.
  - “▼▼▼” indicates that the output selected is “DVD”. It flashes for approx. 5 seconds immediately after the output is switched.
- 2 Disc operation status** ..... (→page 32)
- The operation status of this unit, such as playback, pause (still)
- 3 Disc type**
- DVD-VR:** DVD-RAM  
**DVD-V:** DVD-Video, DVD-R  
**V CD:** Video CD  
**CD:** Audio CD, CD text
- When an MP3 or WMA disc is used, “MP3”, “WMA” is indicated in the Main display section **C**.
- 4 The display mode of the main display section**
- PGM:** during program play (→page 36)  
**TTL:** title number (DVD)  
**GRP:** group number (MP3/WMA)  
**RND:** during random play (→page 36)  
**CHP:** chapter number (DVD)  
**TRK:** track number (Video CD/Audio CD/MP3/WMA)  
**PG:** program number (DVD-RAM)  
**PL:** play list number (DVD-RAM)





**DVD OPERATION**

When you operate the DVD, always select "DVD" with the [VCR/TV/DVD] switch.

If "DVD" is not selected, normal operation will not be possible.

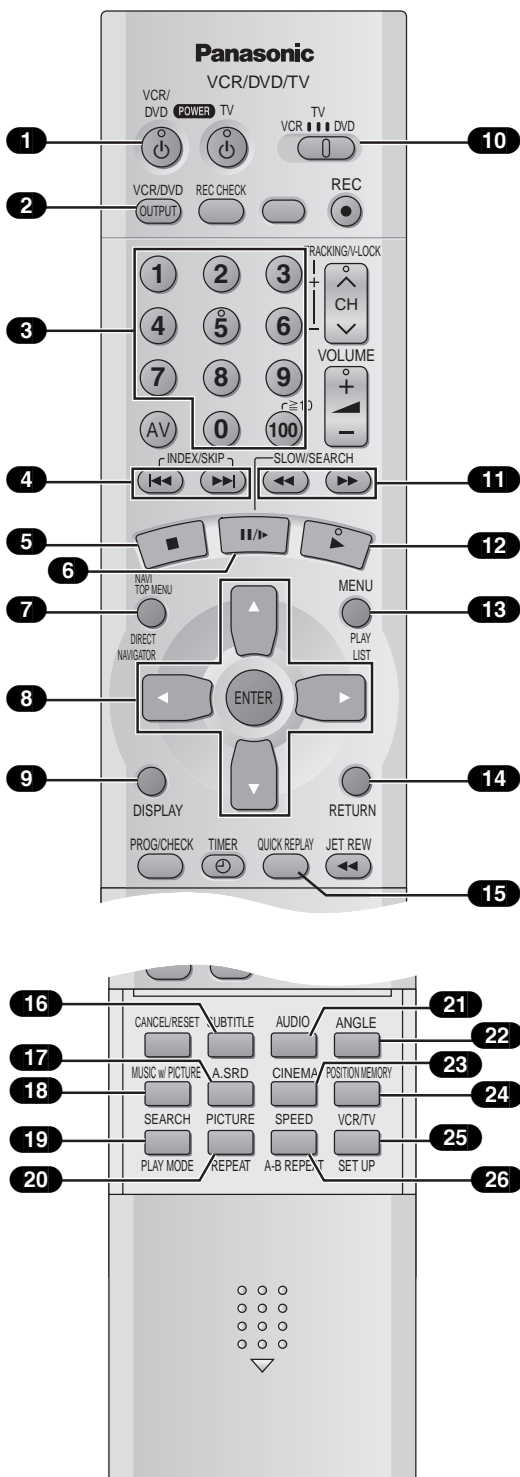

- 1 DVD POWER button (DVD)**.....(→page 32)  
Press [DVD] to switch this unit from on to standby mode or vice versa. In standby mode, the unit is still connected to the main AC power.
- 2 VCR/DVD output switch button (VCR/DVD OUTPUT)** .....(→page 17)
- 3 Numeric buttons (0-9, ≥10)**.....(→page 32,34)
  - When selecting a title, chapter, track, group or play list, etc.  
Example: "05"; [5]  
"15"; [≥10]→[1]→[5]  
MP3 WMA "16"; [1]→[6]  
"125"; [1]→[2]→[5]
- 4 Skip buttons (SKIP)** .....(→page 34)
- 5 Stop button (■)** .....(→page 33)
- 6 Still button (II/▶)**.....(→page 35)
- 7 Top menu and Direct Navigator button (TOP MENU, DIRECT NAVIGATOR)** .(→page 37,38)
- 8 Cursor buttons (▲, ▼, ◀, ▶)/ ENTER button** .....(→page 43,48)
- 9 On-screen menu icon button (DISPLAY)** .(→page 43)
- 10 VCR/TV/DVD switch (VCR/TV/DVD)**
- 11 Slow/search buttons (SKIP, SLOW/SEARCH)** .....(→page 35)
- 12 Play button (▶)** .....(→page 32)
- 13 PLAY LIST button** .....(→page 37)
- 14 RETURN button**.....(→page 37,38,40,43,48)
- 15 QUICK REPLAY button** .....(→page 35)
- 16 SUBTITLE button** .....(→page 40)
- 17 Advanced surround button (A.SRD)** .....(→page 41)
- 18 MUSIC WITH PICTURE button (MUSIC w/ PICTURE)** .....(→page 53)
- 19 PLAY MODE button** .....(→page 36)
- 20 REPEAT button** .....(→page 35)
- 21 AUDIO button**.....(→page 40)
- 22 ANGLE button** .....(→page 40)
- 23 CINEMA button** .....(→page 41)
- 24 POSITION MEMORY button** .....(→page 33)
- 25 DVD SET UP menu button (SET UP)** .....(→page 48)
- 26 A-B REPEAT button**.....(→page 35)

## TV OPERATION

Only Panasonic TVs can be operated with the provided remote control. The settings for operating the TV with the remote control have already been made.

No additional settings need to be performed.

However, some Panasonic TVs cannot be operated using this remote control.

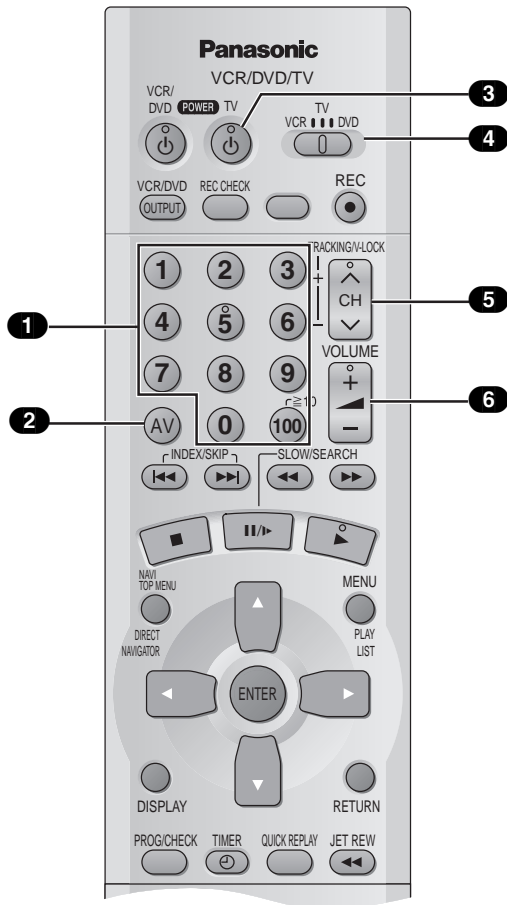

When you operate the TV, always select "TV" with the [VCR/TV/DVD] switch.  
If "TV" is not selected, normal operation will not be possible.

- 1 Numeric buttons (0-9, 100)..... (→page 15,20)**
  - Selects the television channel.
- 2 Television input mode selector (AV)**
  - Selects TV input or AV input.
- 3 TV POWER button (TV)**
  - Press to switch the TV from on to standby mode or vice versa. In standby mode, the TV is still connected to the mains.
  - With some TV models, it may only be possible to switch the TV to the standby mode using this button. In this case, use [AV], [CH]  $\downarrow/\uparrow$  or the numeric buttons to switch the TV on.
- 4 VCR/TV/DVD switch (VCR/TV/DVD)**
- 5 Channel up/down buttons (CH  $\downarrow/\uparrow$ )**
  - Selects the required television channel.
- 6 TV volume up/down buttons (+  $\blacktriangle$  -, VOLUME)**
  - Adjusts the volume of the TV.

## Installing the Batteries

Insert the batteries with the polarity ( $\oplus$  and  $\ominus$ ) correctly aligned.

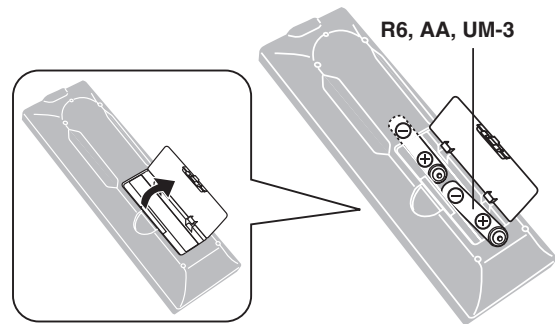

### Power Source for the Remote Controller:

The remote controller is powered by 2 "AA", "UM-3" or "R6" size batteries. The life of the batteries is about one year, although this depends on the frequency of use.

### Precautions for Battery Replacement:

- Load the new batteries with their polarity ( $\oplus$  and  $\ominus$ ) aligned correctly.
- Do not apply heat to the batteries, or an internal short circuit may occur.
- If you do not intend to use the remote controller for a long period of time, remove the batteries and store them in a cool and dry place.
- Remove spent batteries immediately and dispose of them properly.
- Do not use an old and a new battery together, and never use an alkaline battery with a manganese battery.
- Do not use rechargeable batteries.

## Use

Aim at the receiver window, avoiding obstacles, at a maximum range of 7 m (23 feet) directly in front of the unit.

- Keep the transmission window and the unit's sensor free from dust.
- Operation can be affected by strong light sources, such as direct sunlight, and the glass doors on cabinets.

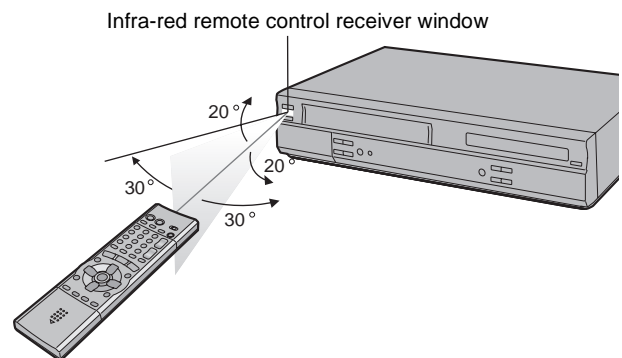

# Connections

This section shows you how to connect the unit to an antenna, TV, etc.

When the unit is turned on after connecting the antenna cable and the AC power cord, Plug in Auto Tuning and Auto Clock Setting start automatically.

## Basic Connections

The following connections are required to record the video cassette and play back the video cassette and discs through the TV.

### Preparation

- Refer to the television's operating instructions.
- Turn the television off and disconnect its AC power supply cord.

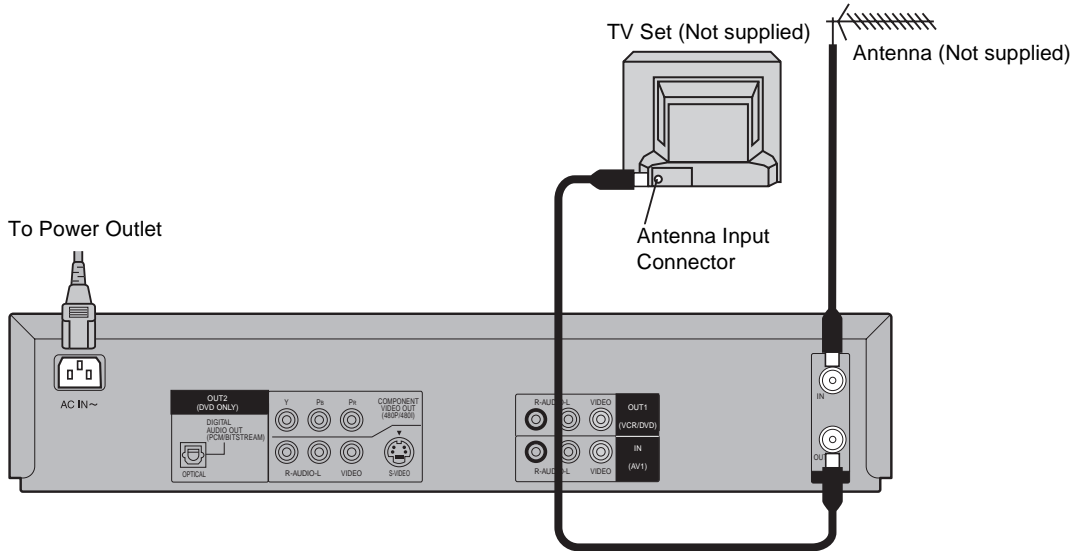

## Connection to a TV using the Audio/Video Input Sockets

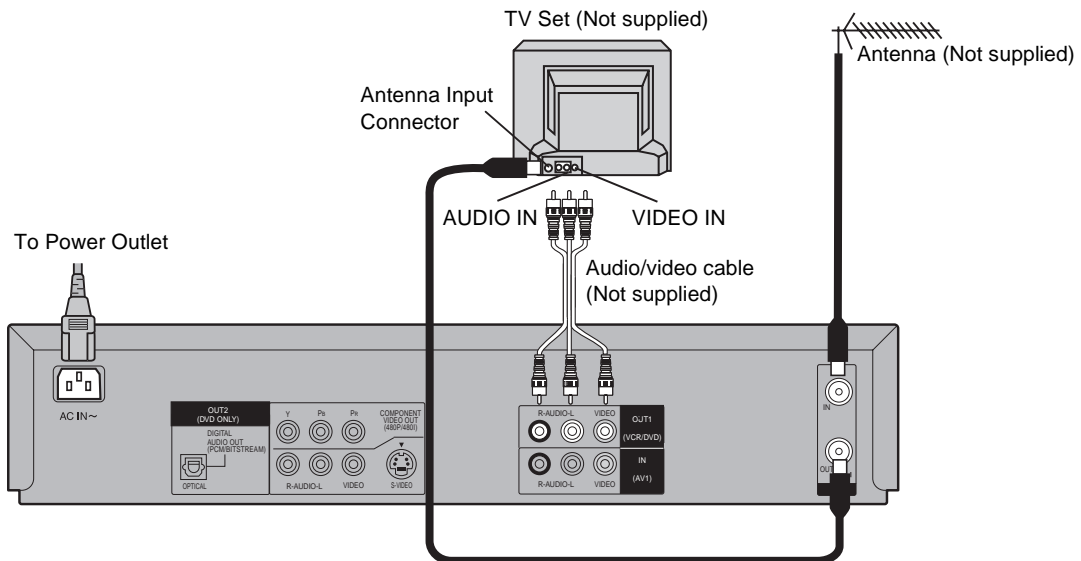

### Note:

- Connect audio/video cables directly to your TV. The video signals on DVDs and videotapes have copyright protection. The video may not be shown correctly if you connect through an A/V selector or other equipment.

### To enjoy sound through other audio equipment

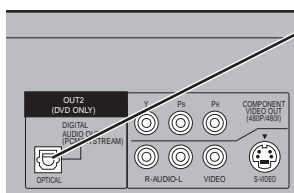

You can output digital signals from this unit's OPTICAL DIGITAL AUDIO OUT terminal, enabling you to enjoy the powerful surround effects found on discs recorded with Dolby Digital or DTS. Connect an amplifier with built-in decoders. See page 47 for connection examples.

## To enjoy DVD video with a higher image quality

The following connections are for the DVD section only.

Carry out the Basic Connections described on the left page to view video from the VCR section.

- You may need to change the video-input mode on the TV to view video from the VCR and DVD sections. Read your television's operating instructions for details.

### Connection to a TV using the COMPONENT VIDEO OUT terminal (progressive out)

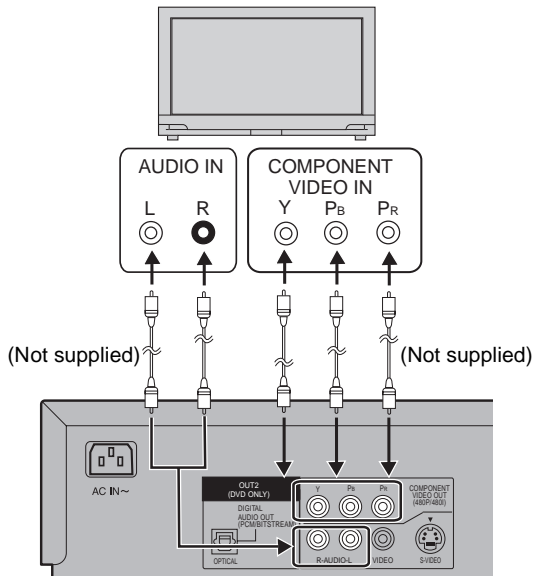

#### COMPONENT VIDEO OUT terminal (progressive out)

These terminals can be used for either interlace or progressive output and provide a purer picture than the S-VIDEO OUT terminal. Connection using these terminals outputs the color difference signals (P<sub>B</sub>/P<sub>R</sub>) and luminance signal (Y) separately in order to achieve high fidelity in reproducing colors.

- The description of the component video input terminals depends on the television or monitor (e.g. Y/P<sub>B</sub>/P<sub>R</sub>, Y/B-Y/R-Y, Y/C<sub>B</sub>/C<sub>R</sub>). Connect to terminals of the same color.
- When making this connection, ensure you connect the audio cables (not supplied) to the corresponding audio input terminals on the television.
- After making this connection, change the black level for a better picture (Black Level Control → page 49).

#### To enjoy progressive video

- 1) Connect to the component video input terminals on a 480P compatible television. (Video will not be displayed correctly if connected to an incompatible television.)
  - 2) In SET UP menus, set "Progressive Out (Component)" to "Enable" (→ page 49).
  - 3) Change "Video output mode" to "480P" in the on-screen menu (→ page 46).
- All televisions manufactured by Panasonic and that have 480P input connectors are compatible. Consult the manufacturer if you have another brand of television.

### Connection to a TV using the S-VIDEO OUT terminal

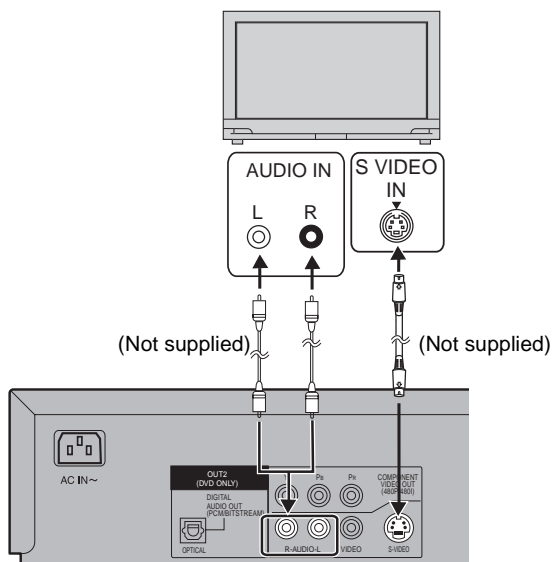

#### S-VIDEO OUT terminal

The S-VIDEO OUT terminal achieves a more vivid picture than the VIDEO OUT terminal by separating the chrominance (C) and luminance (Y) signals. (Actual results depend on the television.)

- When making this connection, ensure you connect the audio cables to the corresponding audio input terminals on the television.
- Connect to a different terminal group (e.g., "VIDEO 2") than that you used for the connection through this unit's OUT1 (VCR/DVD) terminal. Picture from this unit's VCR will not appear when you use the same group input terminal connections because the S-video terminal input takes precedence.

#### About the output terminal common to VCR and DVD and the one exclusively for DVD

This unit has an output terminal common to VCR and DVD and one exclusively for DVD.

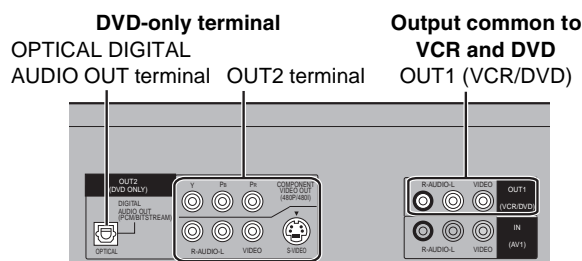

- For the OUT1 (VCR/DVD) terminal, VCR and DVD outputs can be switched or it can be assigned for VCR output only.
- The OUT2 terminal can only output the DVD signal.

#### Note:

- Even if "AUTO" is selected in "OUT1 [VCR/DVD]" of the VCR MENU "OPTION" (→ page 30), the desired output may not be selected depending on the operation. In this case, press [VCR/DVD OUTPUT] on the remote controller to switch manually.
- When Video is switched to DVD or vice versa, the audio volume may suddenly increase or decrease. This is because when the audio output of this unit is connected to the TV, etc., the audio output of the DVD is generally lower. When you increase the volume level to play back DVD audio, reduce it when playback is finished.

# Cable Connection

## Cable-This Unit-TV (For CATV/PAY Channels Recording/Playback)

The unit has an extended range, and can tune the Low-Band, Mid-Band, Super-Band, Hyper-Band, Ultra-Band, and Special cable channels (Channels A-5-A-1, A-W, AA-EEE, GGG-WWW, WWW+1-WWW+12, 100-125, 5A). Also, the unit can tune to any of the 56 UHF channels (14-69). Refer to Channel Set on page 29.

### BASIC Hook-Up

Since the unit can tune Mid and Super Bands, this connection will provide the reception of all cable channels except those which are intentionally scrambled.

However, if you subscribe to a special channel which is scrambled you will probably have a descrambler box for proper reception. The unit by itself cannot properly receive a scrambled program since it does not contain a descrambler. In order for the unit to properly receive a scrambled program, your existing descrambler must be used. There are two commonly used methods of connection in this case.

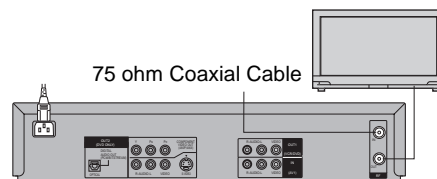

### Typical Cable System Hook Ups with Cable Converter/Descrambler Boxes

#### One cable TV box/satellite receiver

The following cable hook-up allows this unit -TV functions except for viewing one channel while recording another.

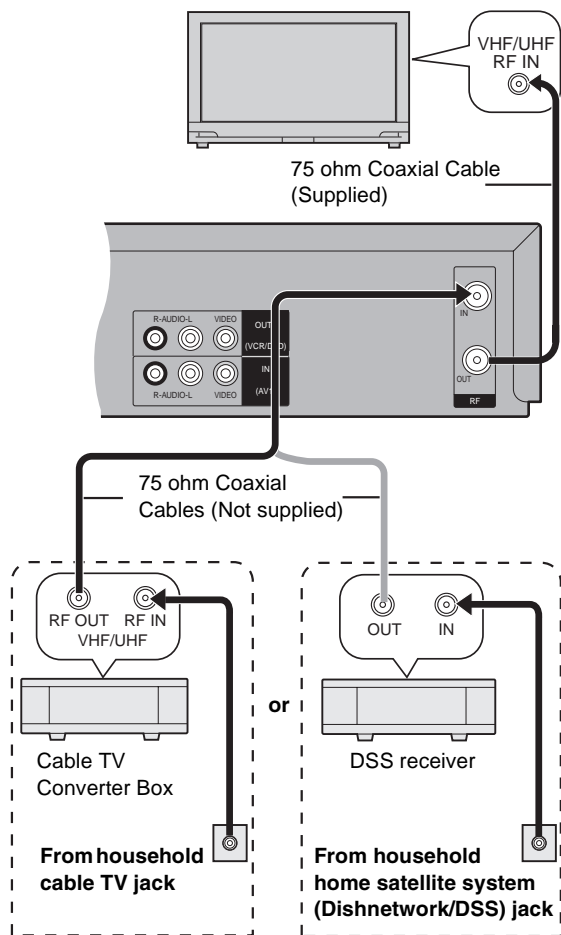

#### Two cable TV boxes

The following cable hook-up allows the unit's functions, including viewing one channel while recording another, but it requires two cable TV Converter/Descrambler Boxes, one Switch Box and one 2-Way Splitter.

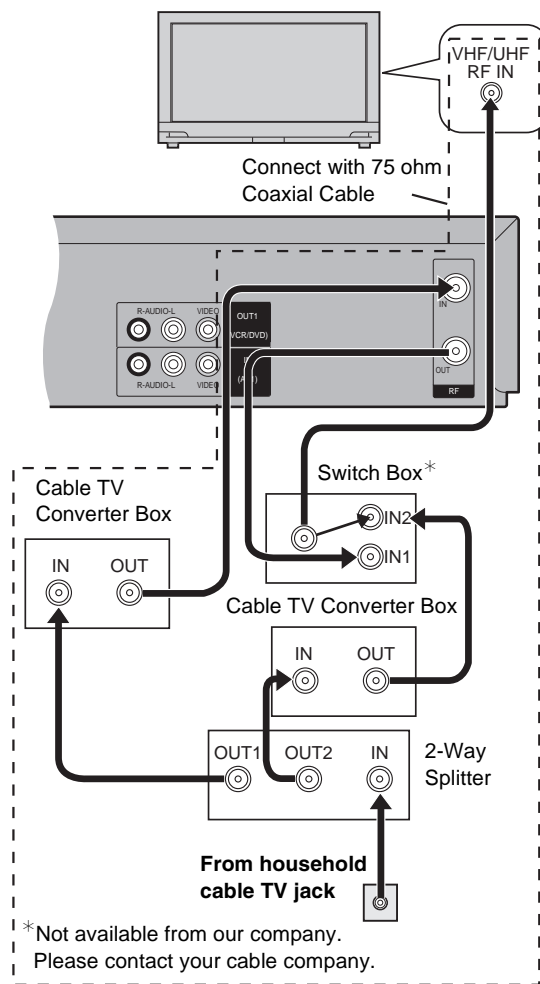

\* Not available from our company. Please contact your cable company.

Since the unit has an extended range of tuning, tuning-programing of non-scrambled Mid-Band and Super-Band TV programs is possible. When a cable converter or descrambler box is connected to the unit, all timer-controlled recording functions will continue to operate with the exception of changing channels automatically. CATV Channel selection will have to be performed with the cable converter. Timer-controlled recording from CATV Channels is therefore limited to one channel at any given time.

## *Tuning the TV to your unit*

---

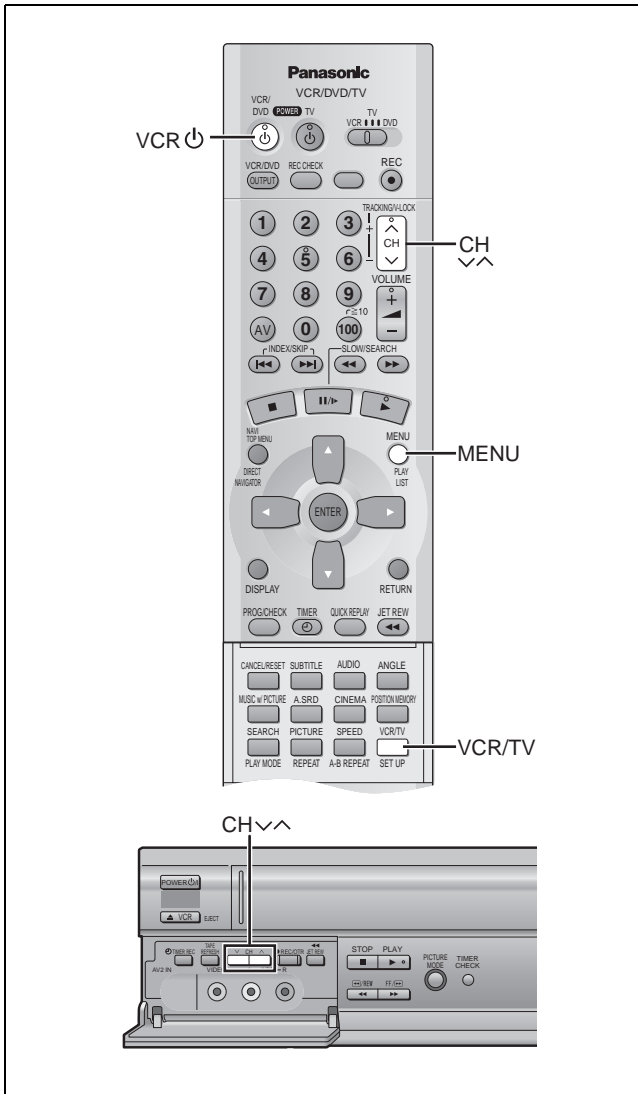

### To Restart Plug in Auto Tuning

Make sure there is no video cassette and disc loaded in the unit.

- 1) Keep both [CH]  $\nabla$  and  $\wedge$  on this unit pressed simultaneously for 3 seconds or more while the unit is powered on.
  - The channel displayed on the unit's display disappears for a moment then changes to 2.

#### Display Symbol



Disappears → 2

- 2) Disconnect the AC power cord and then reconnect it.
- 3) Turn on this unit.
- 4) Press [VCR/TV] to select the VCR mode.
  - Plug in Auto Tuning restarts.

### If Auto Tuning stops halfway by turning the unit off or a power failure:

- 1) Disconnect the AC power cord and then reconnect it.
- 2) Turn on this unit.
  - Plug in Auto Tuning restarts.

### To Change the RF Output Channel

In some rare cases after tuning the TV to your unit, interference may be visible on the picture. To get rid of this interference, you can manually adjust the RF output channel a few channels up and down from the current setting. The procedure is described below.

- 1) Hold down [MENU] for 5 seconds or more.
  - The unit's display changes as shown below and the VCR picture on the TV displays this pattern.

#### On Screen Display

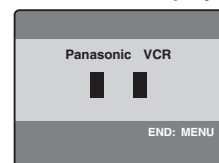

- 2) Enter the desired channel number (3 or 4) by [CH]  $\nabla$   $\wedge$ .
 

3  $\leftrightarrow$  4
- 3) Press [MENU] to finish the setting mode.
- 4) Retune your TV to the new RF channel for this unit.

#### Note:

- Even if the RF output channel has been changed, it is not necessary to perform Auto Tuning.

#### Preparations

- Switch [VCR/TV/DVD] to "VCR".



# VCR Playback

## Basic Playback

### Preparations

- Confirm that the TV is on and the unit viewing channel is selected.
- Switch [VCR/TV/DVD] to "VCR".
- Press [VCR ⏻] to turn on the unit.
- Press [VCR/TV] to select the VCR mode.

### Operations

- 1 Insert a recorded video cassette tape.**
- 2 Start viewing the picture by pressing [▶](PLAY).**
  - Play starts automatically if you insert a prerecorded tape or one that has had its tab (Tapes →page 5) removed.
- 3 Search forward (Cue)/backward (Review) by tapping [▶▶] or [◀◀].**
  - To change back to normal playback, press [▶](PLAY).
  - If you keep [▶▶] or [◀◀] pressed, search playback is activated while the button is pressed, and operation returns to normal playback when the button is released.
- 4 View a still picture by pressing [⏏].**
  - To continue normal playback, press [▶](PLAY) or [⏏].
- 5 View a slow motion picture.**
  - Keep [⏏] pressed for 2 seconds or more.
  - To continue normal playback, press [▶](PLAY).

### Display Symbols



VCR

## To Switch to the Desired Video (Common Output)

This unit allows both video cassette and DVD discs to be played back. You can set the unit so that the output is automatically switched to the device which starts playback.

### Operations

- 1 Press [MENU] to show the VCR MENU.**
- 2 Select "OPTION" by pressing [Cursor]▲▼ and then press [ENTER].**
- 3 Select "OUT1[VCR/DVD]" by pressing [Cursor]▲▼.**
- 4 Select "VCR", "MANUAL" or "AUTO" by pressing [Cursor]◀▶.**

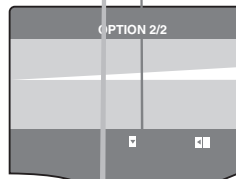

Display Symbols

### VCR: Only VCR outputs

- Even if you press [VCR/DVD OUTPUT], the DVD video is not shown.

### MANUAL: When the VCR output and DVD output are manually switched

- Press [VCR/DVD OUTPUT] to switch to the desired video source.
- Each press of [VCR/DVD OUTPUT] alternately switches between VCR and DVD.
- They are not switched automatically.

### AUTO: Initially set at this position

- VCR and DVD are automatically switched depending on the manipulation or the unit operation.
- You may also switch them by pressing [VCR/DVD OUTPUT].

### To make the on screen display disappear

Press [MENU] twice.

### Note:

- You can switch to the desired video with the above operation only when the video from this unit is viewed through the OUT1 (VCR/DVD) terminal.
- Depending on the operation, the desired output may not be switched automatically even if "AUTO" is selected. In this case, press [VCR/DVD OUTPUT] to switch it manually.

### To stop viewing the picture

Press [■].

### To Eject the Video Cassette Using the Remote Controller

You can eject the video cassette with [▲VCR EJECT] on the unit. You can also use the remote controller. Keep pressing [■] on the remote controller for at least 3 seconds.

### Fast-forwarding or Rewinding the Tape

Press [▶▶] or [◀◀] in the stop mode.

- To stop fast-forwarding or rewinding, press [■].

### To Obtain a Higher Speed Rewind (Jet Rewind)

Press [JET REW ◀◀].

The "J : REW" indication appears on the TV screen and the unit's display. (except when the remaining tape time indication appears)

- Depending on a cassette and an operating condition, the rewind speed is limited.
- The tape counter is reset to "0:00.00" when the tape is rewound to the beginning.
- Depending on a cassette, this function may not work.
- To stop Jet Rewind, press [■].

### S-VHS Quasi Playback (SQPB)

It is also possible to play back tapes recorded in the S-VHS system.

- Some picture noise may occur depending on the type of tape used.
- It is not possible to record in the S-VHS system with this unit.

(continues on the next page)

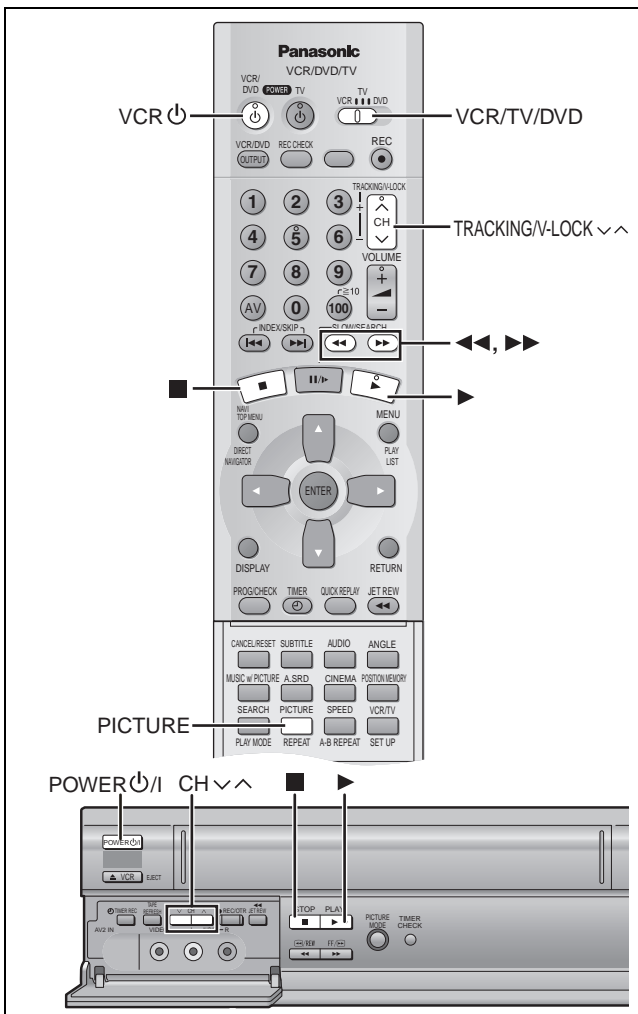

## To Obtain a Higher Speed Picture than Cue, Review (Jet Search)

During playback, tap [▶▶] or [◀◀] twice.

- Select search speed to view the picture recorded. (→page 30)
- The picture that appears in the EP or VP mode at approx. 35 times speed may be distorted. A vertical scroll may occur. It is not a malfunction but if it happens, change to approx. 27 times speed.
- The picture may not be in color or may be distorted depending on the TV.
- Press [▶▶](PLAY) to cancel the Jet Search.

### Notes:

- When this unit is off, an inserted video cassette can be played back by pressing [▶▶](PLAY).
- You can eject tapes when the unit is in standby mode. It switches back to standby once it ejects the tape.
- When the tape reaches its end, this unit automatically rewinds it to the beginning. During timer recording, OTR and fast-forwarding, this function does not work.
- Jet Search, cue, review or slow playback will be automatically released after 10 minutes, and still playback, after 5 minutes.
- When viewing a still picture or slow playback, the picture that appears in the VP mode may be distorted.
- When playing back a tape which was recorded on another VCR, it may be necessary to adjust tracking control using the [TRACKING/V-LOCK] buttons. (→page 19.) In some cases the picture quality may still be inferior. This is due to format constraints.

## Other Playback Functions

### To Stop Playback Automatically (Playback Off Timer Function)

If you set the playback duration, the playback will stop automatically.

After the set playback time has elapsed, this unit automatically stops playback and switches off.

### Operations

- 1 During normal playback  
Press [▶▶] on this unit for more than 2 seconds.
- 2 Press [▶▶] on this unit repeatedly to select the desired playback duration on the unit's display.

Repeatedly pressing this button changes the indication in the following order:

Counter display (normal playback mode)  
→30 (min.)→60 (min.)→90 (min.)  
→120 (min.)→180 (min.)→240 (min.)→  
Counter display (normal playback mode)

- This unit will automatically switch off when Play-Off Timer is completed.

### To turn the unit on again

Press [POWER] (VCR).

### To stop midway

Press [■].

### Notes:

- The Play-Off Timer function works during normal playback.
- When the tape reaches its end during Play-Off Timer, the tape will be rewound to the start and this unit will turn itself off.
- Repeat Playback function does not work during Play-Off Timer.

## To Play back the Recorded Part Repeatedly

Keep [▶▶](PLAY) pressed on the remote controller for 5 seconds or more.

The "R ▶" indication appears on the TV screen.

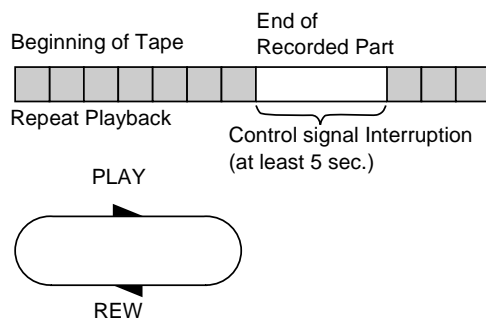

At the end of the program, the tape rewinds to the beginning of the program and plays it again. (It only works if there is a 5 second blank at the end of the program.) This repeats until you cancel it.

### To cancel

Press [■].

- It also cancels if you play, pause, cue, or review.

### Notes:

- Repeat Playback function does not work during Play-Off Timer.

## and Adjustment

Press [PICTURE] once  
follow

STANDARD
DYNAMIC
SOFT

- Pressing [PICTURE] once  
the On Screen Display appears  
that, pressing it repeatedly changes  
the indication in the following order.

**STANDARD** (Initial Setting) → **DYNAMIC**  
**SOFT** → **STANDARD** (Initial Setting)

...  
for you, but you may  
tape recorded on

... at the same time.  
ure

... on the unit.

...  
ng while paused.

... at the same time.

... Try adjusting the

... on the unit.

VCR

# Manual Recording

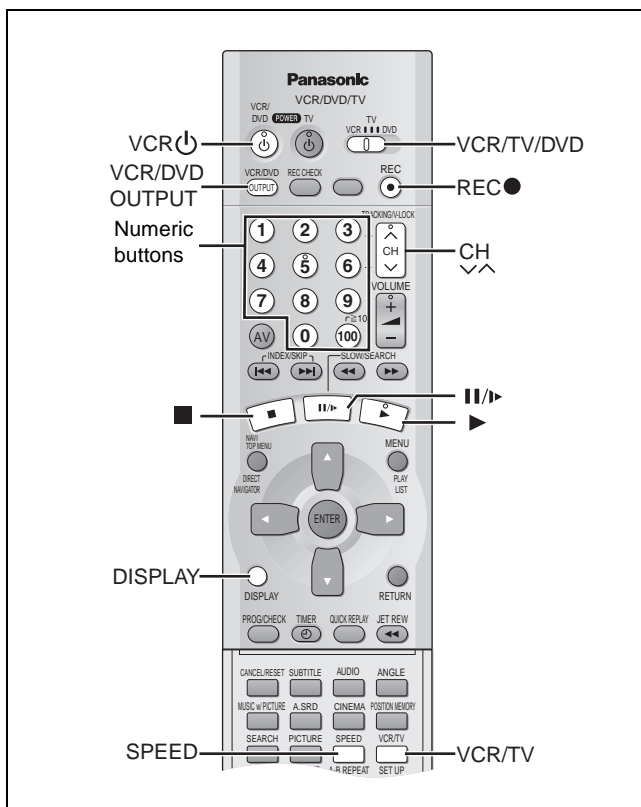

## Tape Speeds:

There are three tape speeds.

SP: You can record the length shown on the tape.

EP: Three times the length of SP mode.

VP: Five times the length of SP mode.

- To have a longer recording duration, select "EP" or "VP".
- If the image quality is important to you or if you wish to store the video cassette for a long period, select "SP".
- This unit can play tapes recorded with LP mode on other equipment ("LP" lights on the display).

## VP mode:

- "VP" flashes in the unit's display for 8 seconds after recording has started.
- **A cassette recorded in VP mode by this unit cannot be played back by other VCRs. It is recommended to distinguish it from other cassettes by indicating "VP" on the cassette label, etc.**
- It takes more time for automatic tracking to work when playing tapes recorded with VP mode, and it may not work at all with some tapes. Do tracking manually if this is the case (→page 19).

## Preparations

- Confirm that the TV is on and the unit viewing channel is selected.
- Switch [VCR/TV/DVD] to "VCR".
- Check that the clock is set to the correct time. If it has not been set, refer to page 28.

## Operations

- 1 Insert a video cassette tape with an intact erasure prevention tab.
  - If it has already been inserted, press [VCR] to turn the unit on.
- 2 Press [VCR/TV] to select the VCR mode.
- 3 Press [CH] buttons to select the TV station.
  - If you press and hold down these buttons, the channels changes quickly.
  - You can also select the channels with the numeric buttons.  
Example: "5"; [0]→[5]  
"15"; [1]→[5]  
"125"; [100]→[2]→[5]
- 4 Press [SPEED] to select the tape speed.
 

Each time you press the button:  
SP→EP→VP
- 5 Press [REC] (●REC/OTR) to start recording.

## Display Symbols



## To stop recording.

Press [■].

## To Interrupt Recording

Press [||▶] during recording.

Press it again to continue recording.

## Note:

- Even if the tape you use is labeled "S-VHS", it is not possible to record in the S-VHS system with this unit. It records in normal VHS system.
- You cannot play VP recordings on other equipment.
- You cannot change channels while recording. You can change channels while in the pause mode.
- Recording pause stops after 5 minutes, and returns to the stop mode.
- When a video cassette with a broken off erasure prevention tab is inserted, the "⊞" indication will flash to indicate that recording is not possible even if [REC] (●REC/OTR) is pressed.

## To Display the Approximate Remaining Tape Time

- 1) Select "TAPE SELECT" from the on screen display and select the corresponding video cassette tape length (→page 30).
- 2) Press [DISPLAY].

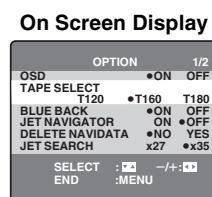

The display changes as follows each time [DISPLAY] is pressed.

Clock→Counter→Remaining Tape Time→Clock

- The remaining tape time may not be displayed correctly depending on the tape used.

## To View One TV Program while Recording Another One

- 1) Refer to steps 1-5 of the manual recording operation.
- 2) Press [VCR/TV] to select the TV mode.
- 3) Switch [VCR/TV/DVD] to "TV".
- 4) Press [CH] buttons or the numeric buttons to select the TV program that you wish to view.

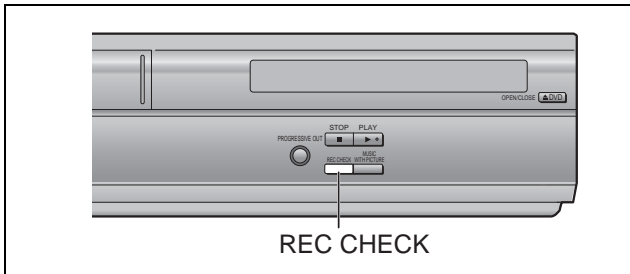

### To play back a disc while recording on a video cassette

You can play back a DVD disc while recording.

- Playback will not affect the recording.

#### Operations

- 1 While recording,  
Switch [VCR/TV/DVD] to "DVD".
- 2 If "OUT1 [VCR/DVD]" is set to "MANUAL"  
(→page 17), press [VCR/DVD OUTPUT] to switch to DVD.
- 3 Insert the disc and press [▶](PLAY) to start playback.  
(→page 32)

### Record check

To check whether or not recording is proceeding normally,  
Press [REC CHECK] while recording.



During recording

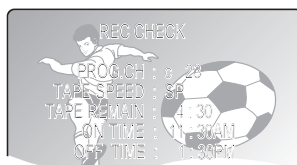

During Timer recording

- The program currently being recorded is shown for approx. 5 seconds.
- If [REC CHECK] is pressed at a time other than while recording, the timer recording list screen appears.
- The record check is operational only while the video from a disc is being viewed through the OUT1 (VCR/DVD) terminal.

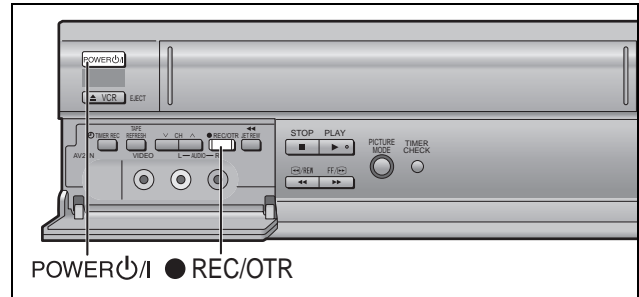

### One-Touch Recording (OTR)

To start recording quickly and for a set duration.

#### Preparation

- Insert a video cassette with an intact erasure prevention tab.

#### Operations

- 1 Ready the video source which is to be recorded,  
and start recording.
- 2 Press [●REC/OTR] on this unit repeatedly to select the desired recording duration.
  - The duration indicated on the unit's display changes by pressing [●REC/OTR] as follows:
    - Counter display (normal recording mode)  
→30 (min.)→60 (min.)→90 (min.)  
→120 (min.)→180 (min.)→240 (min.)→
    - Current time (normal recording mode)

- This unit will automatically switch off when OTR is completed. To turn the unit on again, press [POWER⏻/I] (VCR⏻).

#### To stop OTR at any time

Press [■] or [POWER⏻/I] (VCR⏻).

#### Notes:

- The OTR function works during normal recording.
- When the tape reaches its end during OTR, the unit will turn itself off.

# Timer Recording

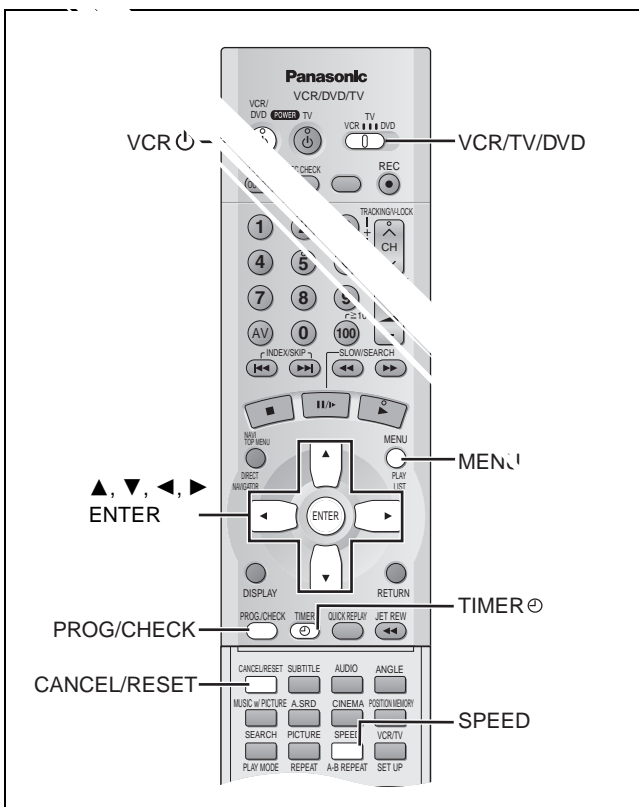

## Operations

- 1 Press [PROG/CHECK] repeatedly to select a blank line and press [ENTER].
- 2 Press [PROG/CHECK] repeatedly to select a blank line and press [ENTER].
- 3 Select "DATE" with [Cursor]◀▶ and change it with [Cursor]▲▼.
- 4 Select "CH" with [Cursor]◀▶ and change it with [Cursor]▲▼.
- 5 Select "ON" with [Cursor]◀▶ and change the start time with [Cursor]▲▼.
  - When kept pressed, the changes in 30-minute steps.
- 6 Select "OFF" with [Cursor]◀▶ and change the end time with [Cursor]▲▼.

## On Screen Display

DATE	CH	ON	OFF	1/2
29SA	2	8:02PM	9:30PM	SP
SU-SA	125	10:30AM	11:00AM	A
SU	14	3:00PM	4:00PM	SP
19WE	5	10:15PM	11:30PM	VP
28FR	A1	8:02PM	9:30PM	SP
30SU	4	7:10PM	7:55PM	VP
PROG.:ENTER		END:MENU		

- 7 Press [SPEED] to change tape speed.
- Tape Speeds → page 23
- time you press the
- S... →VP→A\*

\*Auto... Change fur... page 23

•When the navigator... "OFF" (→page 30), pro...

to step 7.

- 8 If "JET NAV. GA... VCR MENU "O... "ON" (→page 24, 00), Press [Cursor]▶▶▶▶ select a category and display the category list with [Cursor]▲▼. Select the desired category pressing [Cursor]▲▼◀ and confirm with [MENU]. You can also set an... (→page 25).

## To Program with the On Screen Display (OSD)

This method offers easy step-by-step programming with the remote control while you view the prompts on the TV screen. Up to 16 timer programs, including weekly and daily programs, can be recorded for up to one month in advance by setting the timer.

### Preparations

- Turn on the unit.
- Confirm that the TV is on and the unit viewing channel is selected.
- Insert a video cassette tape with an intact erasure prevention tab (→page 5).
- Check that the clock is set to the correct time. If it has not been set, refer to page 28.

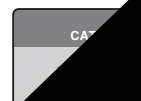



### Weekly Timer Recording

In step 3, select the desired day by pressing [Cursor]▲▼. For example, SU (Sunday)

#### On Screen Display

DATE	CH	ON	OFF	1/2
1 29SA	2	8:02PM	9:30PM	SP
2 SU-SA	125	10:30AM	11:00AM	A
3 SU	14	3:00PM	4:00PM	SP
4 19WE	5	10:15PM	11:30PM	VP
5 28FR	A1	8:02PM	9:30PM	SP
6 30SU	4	7:10PM	7:55PM	VP
7				
8				

SELECT: [Left] [Right] -/+ [Up] [Down]

(SU=Sunday, MO=Monday, TU=Tuesday, WE=Wednesday, TH=Thursday, FR=Friday, SA=Saturday)

### Daily Timer Recording

For this timer function, several groups of days can be selected.

- Ⓐ Daily recording from Monday to Friday (MO-FR)
- Ⓑ Daily recording from Monday to Saturday (MO-SA)
- Ⓒ Daily recording from Sunday to Saturday (SU-SA)

In step 3, select the desired days by pressing [Cursor]▲▼. For example, Ⓒ

DATE	CH	ON	OFF	1/2
1 29SA	2	8:02PM	9:30PM	SP
2 SU-SA	125	10:30AM	11:00AM	A
3 SU	14	3:00PM	4:00PM	SP
4 19WE	5	10:15PM	11:30PM	VP
5 28FR	A1	8:02PM	9:30PM	SP
6 30SU	4	7:10PM	7:55PM	VP
7				
8				

SELECT: [Left] [Right] -/+ [Up] [Down]

### Timer Recording from an External Signal Source

If timer recording is performed by a unit connected to the audio/video input sockets, select the A1 or A2 indicator in step 4 for the program position.

DATE	CH	ON	OFF	1/2
1 29SA	2	8:02PM	9:30PM	SP
2 SU-SA	125	10:30AM	11:00AM	A
3 SU	14	3:00PM	4:00PM	SP
4 19WE	5	10:15PM	11:30PM	VP
5 28FR	A1	8:02PM	9:30PM	SP
6 30SU	4	7:10PM	7:55PM	VP
7				
8				

SELECT: [Left] [Right] -/+ [Up] [Down]

### Auto SP/EP Change Function

If, during a timer recording performed in SP mode, this unit determines that the remaining tape time is insufficient to record the program to its end, the Auto SP/EP Change function automatically changes the tape speed to EP to ensure that the whole program will be recorded.

Depending on the remaining tape length, recording may be performed in EP mode from the start. However, if the remaining tape time is still not sufficient in this case, the program cannot be recorded to the end.

Timer programming

1st program (30 min.)	2nd program (60 min.)	
Video tape		
30 min. at SP	15 min. at SP	45 min. at EP (when using a 60-min. tape)

- The tape length must be set correctly. (→page 30.)
- Some tapes may not work correctly.
- If the recording speed changes from SP to EP during a timer recording, some brief picture distortion occurs at that point.

### Checking a Timer Program

- This unit must be turned on, or the timer recording indicator “Ⓜ” lit.
- Confirm that the TV is on and this unit viewing channel is selected.

- 1) Press [PROG/CHECK].
  - Every time you press [PROG/CHECK], the program shifts below.
  - Alternatively, you can press [TIMER CHECK] on the unit to display the timer programming screen.

DATE	CH	ON	OFF	1/2
1 29SA	2	8:02PM	9:30PM	SP
2 SU-SA	125	10:30AM	11:00AM	A
3 SU	14	3:00PM	4:00PM	SP
4 19WE	5	10:15PM	11:30PM	VP
5 28FR	A1	8:02PM	9:30PM	SP
6 30SU	4	7:10PM	7:55PM	VP
7				
8				

PROG.:ENTER END:MENU

- 2) Press [Cursor]▶ to display the Category. (When “JET NAVIGATOR” is set to “ON”).
  - Press [Cursor]◀ again to make the previous display appear.

DATE	CH	ON	OFF	1/2
1 29SA	2	8:02PM	9:30PM	SP
2 SU-SA	125	10:30AM	11:00AM	A
3 SU	14	3:00PM	4:00PM	ETC
4 19WE	5	10:15PM	11:30PM	VP
5 28FR	A1	8:02PM	9:30PM	SP
6 30SU	4	7:10PM	7:55PM	VP
7				
8				

PROG.:ENTER END:MENU

### Cancelling a Timer Program

- This unit must be turned on, or in timer recording standby mode.
- Confirm that the TV is on and this unit viewing channel is selected.

While the timer programming screen is on the television (→above),

- 1) Press [PROG/CHECK] repeatedly to highlight the program you want to cancel.
- 2) Press [CANCEL/RESET].

DATE	CH	ON	OFF	1/2
1 29SA	2	8:02PM	9:30PM	SP
2 SU-SA	125	10:30AM	11:00AM	A
3 SU	14	3:00PM	4:00PM	SP
4 19WE	5	10:15PM	11:30PM	VP
5 28FR	A1	8:02PM	9:30PM	SP
6 30SU	4	7:10PM	7:55PM	VP
7				
8				

PROG.:ENTER END:MENU

DATE	CH	ON	OFF	1/2
1				
2 SU-SA	125	10:30AM	11:00AM	A
3 SU	14	3:00PM	4:00PM	SP
4 19WE	5	10:15PM	11:30PM	VP
5 28FR	A1	8:02PM	9:30PM	SP
6 30SU	4	7:10PM	7:55PM	VP
7				
8				

PROG.:ENTER END:MENU

### To correct a program

- This unit must be turned on, or in timer recording standby mode.
- Confirm that the TV is on and this unit viewing channel is selected.

While the timer programming screen is on the television (→above),

- 1) Press [PROG/CHECK] repeatedly to highlight the program you want to correct and press [ENTER].
- 2) Select the item with [Cursor]◀▶ and correct it with [Cursor]▲▼.
- 3) Press [ENTER].

DATE	CH	ON	OFF	1/2
1 29SA	2	8:02PM	9:30PM	SP
2 SU-SA	125	10:30AM	11:00AM	A
3 SU	14	3:00PM	4:00PM	SP
4 19WE	5	10:15PM	11:30PM	VP
5 28FR	A1	8:02PM	9:30PM	SP
6 30SU	4	7:10PM	7:55PM	VP
7				
8				

SELECT: [Left] [Right] -/+ [Up] [Down]

To exit the On Screen Display Press [MENU].

#### Note:

- If timer recording is not completed (due to insufficient tape or cancellation by the user), the programmed timer recording data will be cancelled from the memory by 4 A.M. two days later. However, if the timer recording function is activated at that time, the programmed timer recording data will not be cancelled.
- After you cancel the programmed timer recording data, the current tape speed is displayed during the stop mode.

# Search Functions

## Saving Jet Navigator data

CR MENU.

Cursor]▲▼ and then

On Screen Display

OPTION	1/2
SELECT	•ON OFF
T120	•T160 T180
BACK	•ON OFF
NAVIGATOR	•ON OFF
DELETE NAVIDATA	•NO YES
SEARCH	x27 •x35
SELECT	: [ ] -/+ : [ ]
END	: MENU

## to find programs

Navigator list.

JET NAVIGATOR			
DATE	CH	ON	CATEGORY
/18	1	10:30PM	MUSIC 🎵
/19	124	3:00PM	SPORT 🏀
/21	5	10:15AM	
/23	A2	8:02PM	
/26	4	7:10AM	EDUCA 📖
/27	2	8:02AM	
/27	12	8:30PM	
SELECT : NAVI, [ ]		END : MENU	

programs are displayed on

been recorded for one  
sted for the first program

ack, playback stops and

select the program  
y back.

arch for the beginning of  
vil" start automatically.

10/27	2	8:02AM
10/27	12	8:30PM
SELECT : NAVI, [ ]		END : MENU

rogram shifts above.

want to search for the  
rogram, press [NAVI].  
or list appears.

## data of a single

re than 5 seconds while

or data stored in  
0)



### To Set the Category

The category setting allows you to find what kind of programs are recorded by the character and the icon indications.

Press **[Cursor]** while the Jet Navigator list appears. Then, select the desired category by pressing **[Cursor]**. Press **[MENU]**.

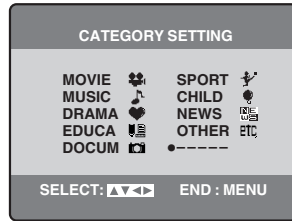

Category	Indication	Icon
MOVIE	MOVIE	
MUSIC	MUSIC	
DRAMA	DRAMA	
EDUCATION	EDUCA	
DOCUMENTARY	DOCUM	
SPORTS	SPORT	
CHILDREN	CHILD	
NEWS	NEWS	
OTHERS	OTHER	

**Notes:**

The Jet Navigator list is stored in each cassette. Signals approximately 10 seconds before and after the current tape position are checked. (During this checking, [CHECKING JET NAVIGATOR DATA] is displayed on the TV screen.) Checking cannot be performed properly where there are no signals, such as at unrecorded portions of the tape. In this case, press **[NAVI]** at a portion of the tape where a program has been recorded on this unit. This will allow signal checking to be performed more reliably. When a signal can still not be found, the message [CAN NOT FIND JET NAVIGATOR DATA] is displayed on the TV.

Up to 20 cassettes and 50 programs can be registered. If data for 50 recorded programs is already stored in memory and you attempt to store timer recording data for another program, the message [REMAINING PROGRAM 0 DELETE JET NAVIGATOR DATA] appears. If you attempt to make a new recording, this same message also appears after you insert the cassette and the Jet Navigator data is checked. As each timer recording or manual recording is finished, the program data is deleted, starting from the oldest data.

If a new program is attempted to be recorded when data for 20 cassettes are already stored in memory, [REMAINING CASSETTE 0 FOR JET NAVIGATOR DELETE JET NAVIGATOR DATA] is displayed. Programs recorded without deleting data as instructed are not registered in the list.

### When Recording Over the Same Location on a Tape:

- The originally recorded program is deleted from the list.
  - Program contents starting near the start and end of the newly recorded program (within 10 minutes in EP mode\* before the start and after the end of the newly recorded program) are also erased.
- (Although old program contents are also similarly erased in the case of ordinary recording, the newly recorded program is not registered in the list.)
- \*17 minutes in VP mode

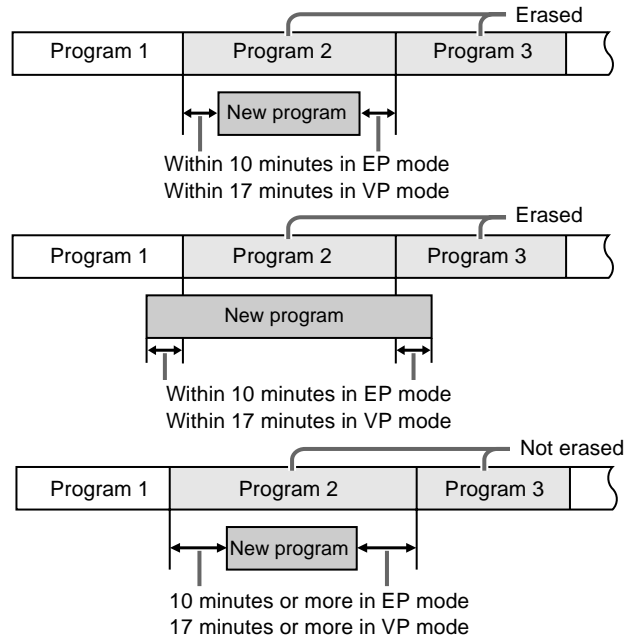

### To Demonstrate the Jet Navigator Function

Keep **[NAVI]** pressed for more than 5 seconds without inserting a cassette tape.

## To Find the Beginning of Each Recording (VHS Index Search System)

This unit automatically records special index signals on the tape every time a recording is started. The Index search function makes use of these index signals to let you find the beginning of a desired program quickly and easily.

### Preparations

- Display the unit's picture on the TV.
- Switch [VCR/TV/DVD] to "VCR".
- Insert a recorded video cassette.

### Example:

Searching for the 2nd recorded segment in the forward direction.

**While stopped or during play, Press [▶▶] twice.**

(This operation is performed while the unit is in the stop mode or normal playback mode.)

### Display Symbol



- After finding the specific recorded segment, playback starts automatically.

**To cancel the Index Search or to stop playback**  
Press [■].

### Notes:

- If you press [▶▶] too many times, simply press [◀◀] to correct it. In this way, you can reduce the displayed figure down to 1.
- Up to 20 index signals can be searched for in both directions.
- The figure on the display decreases by 1 each time an index signal is located.

### Recording Index Signals

Index signals are recorded in the following cases.

- When a recording is started by pressing [REC] (●REC/OTR).
- When [REC] on the remote controller is pressed during recording.
- When timer recording is activated.

### Note:

- This feature may not work correctly if the marks are too close together. Make recordings of at least 15 minutes (25 minutes in VP mode).

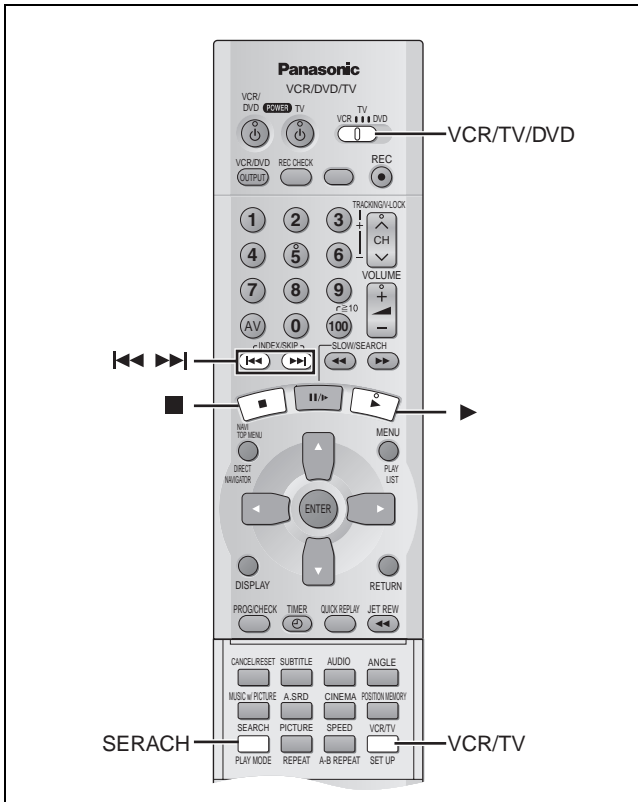

## To Check the Recorded Programming Data (Time Stamp Function)

When playback starts after searching with the Jet Navigator function or the index search function, recorded programming data (called Time Stamp) appears on the TV screen for approx. 5 seconds.

### Preparations

- Display the unit's picture on the TV.
- Switch [VCR/TV/DVD] to "VCR".
- Be sure to set "OSD" in the VCR MENU "OPTION" to "ON". (→page 30)

### On Screen Display

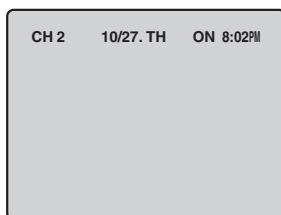

### Note:

- Time Stamp may not appear if the beginning of the Jet Navigator data is not recorded 25 minutes before and after the current tape position even when index signals are recorded.

## Searching while checking the video cassette contents (Intro-Jet Scan)

The approximate beginnings of each recorded program are played in succession at high speed so that the program to be viewed can be located easily.

### Preparations

- Confirm that the TV is on and the unit viewing channel is selected.
- Switch [VCR/TV/DVD] to "VCR".
- Press [VCR/TV] to select the VCR mode.
- Load the pre-recorded video cassette.

### Operations

#### 1 Press [SEARCH].

(This operation is performed while this unit is in the stop mode or normal playback mode with this unit on.)

- The tape is rewound to the beginning, and played for about 10 seconds at high speed. It is then fast forwarded, the VISS (VHS Index Search System) signals are searched in succession, and each time the signals are found, the tape is played for about 10 seconds at high speed.

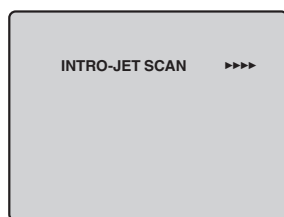
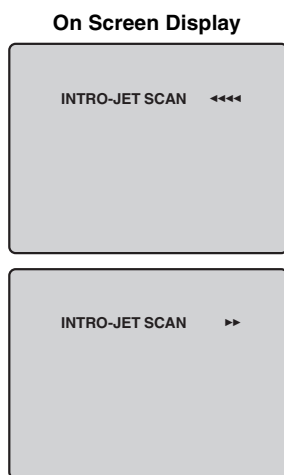

#### 2 When the program to be viewed is reached, press [▶](PLAY).

- Normal playback now commences.

### To stop the operation at any time

Press [■].

### Note:

- This function may not work properly when recorded programs run for 15 minutes (25 minutes in VP mode) or less.

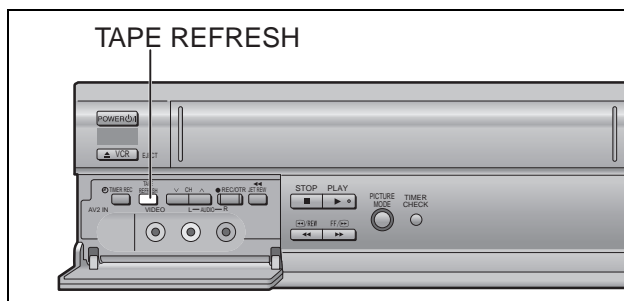

## To Delete all of a Cassette's Contents (Tape Refresh Function)

You can delete all of a cassette's contents (the picture, the sound and the Jet Navigator data) all at once.

### Operations

- When you want to delete all contents of a cassette that is recorded while setting "JET NAVIGATOR" in the VCR MENU "OPTION" to "ON"  
**Be sure to set "JET NAVIGATOR" to "ON" .**  
 (→page 30)

■ When you want to delete all contents of a cassette that is recorded while setting "JET NAVIGATOR" in the VCR MENU "OPTION" to "OFF" or is recorded on another VCR  
**Be sure to set "JET NAVIGATOR" to "OFF" .**  
 (→page 30)
- Insert a cassette that you want to delete the cassette's contents.
- Press [TAPE REFRESH] for 5 seconds or more to put this unit in tape refresh standby mode.

#### Display Symbol



#### On Screen Display



#### 4 Press [TAPE REFRESH] for 2 seconds or more to start the tape refresh function.

The tape is rewound to the beginning, and it is fast-forwarded with the tape refresh function.

"TAPE REF" and the remaining tape time are displayed alternately in the unit's display.

When the tape reaches the end, this unit automatically rewinds it to the beginning.

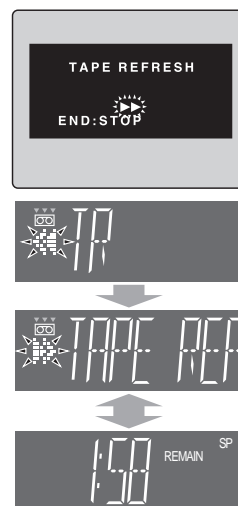

### Note:

- When a video cassette with a broken off erasure prevention tab is inserted, this function is not activated.

# Settings Using the On Screen Display

## Setting the Clock of your unit

The clock is set automatically after Plug in Auto Tuning (→page 15). Do the following if you want to set it again or if the time is not set correctly.

### Operations

While the VCR MENU is displayed

- 1 Select "CLOCK SET" by pressing [Cursor]▲▼ and then press [ENTER].

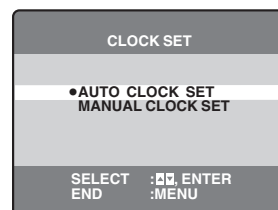

### AUTO CLOCK SET

- 2 Select "AUTO CLOCK SET" by pressing [Cursor]▲▼ and then press [ENTER].

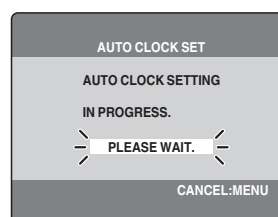

Auto setting starts. This can take some time, up to a few hours in some cases.

- The time is displayed on the unit's display when finished.

### To stop partway through

Press [MENU].

### Note:

- If the unit couldn't set the clock automatically, the MANUAL CLOCK SET screen appears. Set the time manually (→below).

### MANUAL CLOCK SET

- 2 Select "MANUAL CLOCK SET" by pressing [Cursor]▲▼ and then press [ENTER].

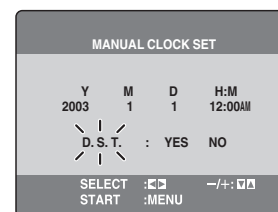

- 3 Press [Cursor]◀▶ to select the item you want to change and press [Cursor]▲▼ to change the setting.

- D.S.T. means Daylight Saving Time. If you set to "YES", Daylight Saving Time will be activated automatically.

- 4 Press [MENU] to start the clock and exit the setting screen.

### Note:

- The clock operates for at least 5 years on its backup system in the event of a power failure.

## Time Reset Function

If the clock is less than two minutes slow or fast, it can easily be reset to the proper time.

Example: Resetting the clock to 12:00.00

- 1) Select "CLOCK SET" from the VCR MENU and press [ENTER].
- 2) Press [Cursor]▲▼ to select "MANUAL CLOCK SET" and then press [ENTER].
- 3) When the current clock display on this unit is between 11:58.00 and 12:01.59, press [MENU] as soon as you hear the 12:00.00 signal. This resets the time to 12:00.00.

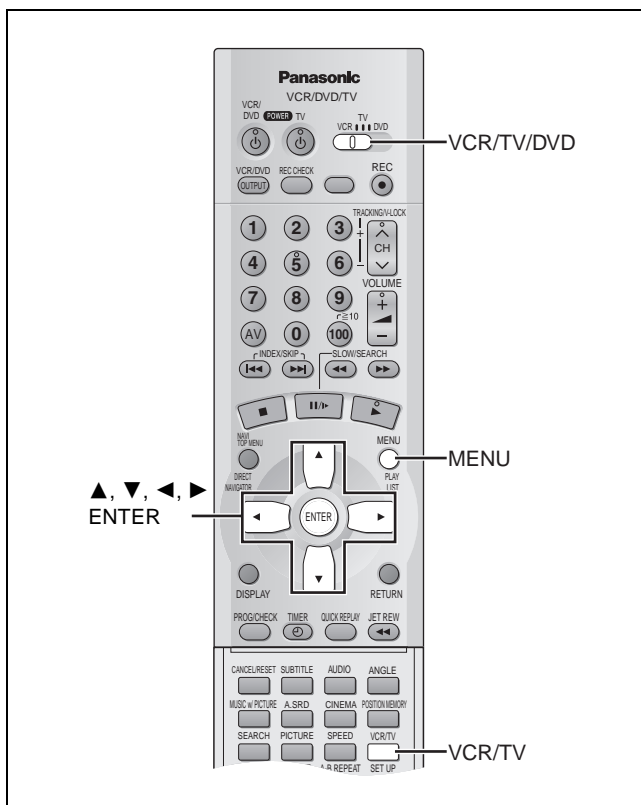

Change the settings to suit your preferences and to suit the unit to the environment in which it is being used. These settings are retained in memory until they are changed, even if the unit is turned off.

## Common procedure

### Preparations

- Confirm that the TV is on and the unit viewing channel is selected.
- Turn on the unit.
- Switch [VCR/TV/DVD] to "VCR".
- Press [VCR/TV] to select the VCR mode.

### Operation

Press [MENU] to show the VCR MENU.

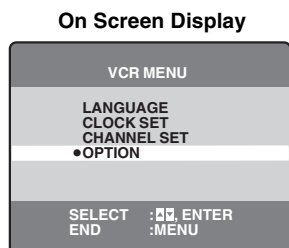

## To Select the Desired Language

Select the language for these menus and other on screen displays.

### Operations

While the VCR MENU is displayed

- 1 Select "LANGUAGE" by pressing [Cursor]▲▼ and then press [ENTER].
- 2 Select the desired language by pressing [Cursor]▲▼.
- 3 Press [MENU] twice to make the on screen display disappear.

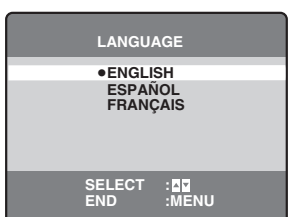

## Channel Set

The unit tunes automatically after you plug it in and turn it on for the first time (Plug in Auto Tuning →page 15), but you can start the process again if necessary.

### Preparations

- Select any program position except “A1” or “A2”.

### Operations

While the VCR MENU is displayed

- 1 Select “CHANNEL SET” by pressing [Cursor]▲▼ and then press [ENTER].

### ANTENNA SYSTEM

- 2 Select “ANTENNA SYSTEM” by pressing [Cursor]▲▼ and then press [ENTER].

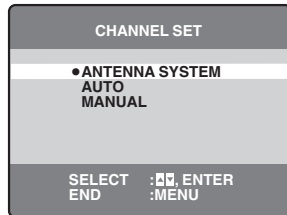

- 3 Press [Cursor]▲▼ to select “TV” or “CATV” to suit the type of antenna you are using.

- Channels set corresponding to the antenna system you select.  
This is set automatically when you do Plug in Auto Tuning.

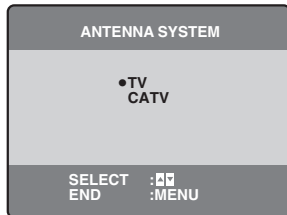

### To exit the on screen display

Press [MENU] three times .

### Auto Tuning

Auto tuning searches for TV stations from VHF minimum to UHF maximum and memorizes every tuned program position. Other program positions are skipped. (Channel plan →right)

- 2 Select “AUTO” by pressing [Cursor]▲▼ and then press [ENTER].

Auto tuning starts. It may take up to three or more minutes to complete.

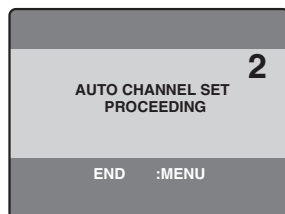

### To stop partway through

Press [MENU].

### Notes:

- When Auto Tuning is completed, the on screen display disappears and the lowest channel position at which a broadcast can be tuned in is received.
- If you have not set the clock, the unit will carry out Auto Clock Setting. The time is displayed on the unit’s display when finished.
- If the unit is not correctly tuned by Auto Tuning, follow the procedure on the right column.

### Manual Tuning

- 2 Select “MANUAL” by pressing [Cursor]▲▼ and then press [ENTER].

- 3 Press [Cursor]▲▼ to select “CH” and [Cursor]◀▶ to select the channel.

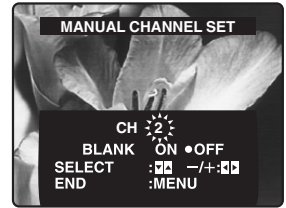

- 4 Press [Cursor]▲▼ to select “BLANK” and [Cursor]◀▶ to select “ON” or “OFF”.

- To select the blanking of a program position, select “ON”.
- To restore the channel again, select “OFF”.
- Repeat steps 3 and 4 for another unoccupied program positions to skip during the selection of the program positions.

### To exit the settings screen

Press [MENU] three times.

## Channel plan

### TV mode

CHANNEL DESIGNATIONS	CHANNEL RECEIVED OF THE AIR	CHANNEL SELECTION & INDICATION ON THE UNIT
VHF	2–13	2–13
UHF	14–69	14–69

### CATV mode

CHANNEL DESIGNATIONS	CHANNEL RECEIVED FROM CABLE	CHANNEL SELECTION & INDICATION ON THE UNIT
BROADCAST VHF	2–13	2–13
CATV LOW BAND	A-5–A-1	95–99
CATV MID/SUPER BANDS	A–W	14–36
CATV HYPER BAND	AA–EEE	37–65
ULTRA BAND	GGG–WWW WWW+1– WWW+12	66–94
		100–125
SPECIAL CATV CHANNEL	5A	1

## Option

### Operations

While the VCR MENU is displayed  
(Common procedure →page 28)

- 1 Select "OPTION" by pressing [Cursor]▲▼ and then press [ENTER].
- 2 Press [Cursor]▲▼ to select the item and press [Cursor]◀▶ to change the setting.

### On Screen Display

OPTION		1/2
OSD	●ON	OFF
TAPE SELECT	●T120	T160 T180
BLUE BACK	●ON	OFF
JET NAVIGATOR	ON	●OFF
DELETE NAVIDATA	●NO	YES
JET SEARCH	x27	●x35
SELECT	: [ENTER]	-/+ : [ENTER]
END	: [MENU]	

OPTION		2/2
MTS	●MAIN	SAP MONO
OUT1[VCR/DVD]	VCR	MANUAL ●AUTO
SELECT	: [ENTER]	-/+ : [ENTER]
END	: [MENU]	

To exit the settings screen

Press [MENU] twice.

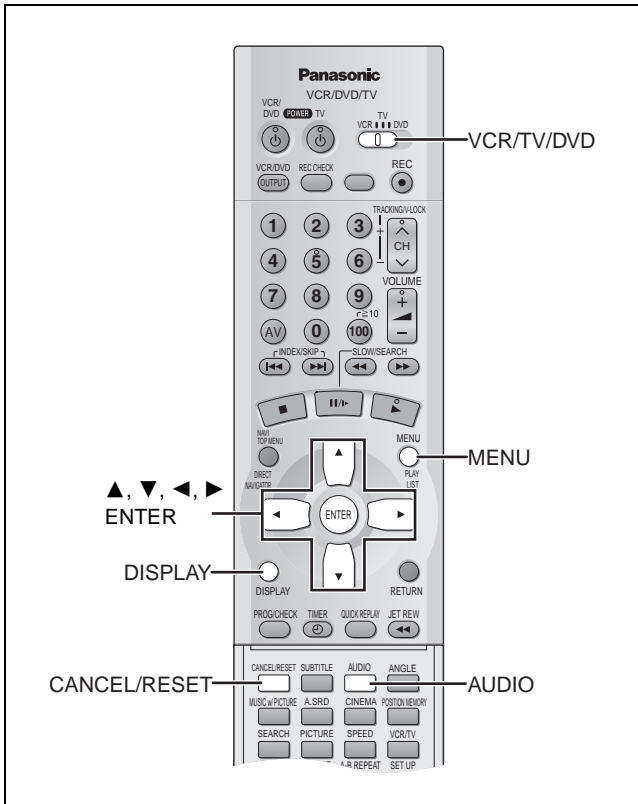

Items	Settings (Underlined items are the initial setting.)
<b>OSD (Onscreen display →page 31)</b>	<u>ON</u> : Messages appear on the television for about 5 seconds after you perform operations. ●The on screen display will always appear on the TV screen during rewind, Jet Rewind and fast forward. OFF: Messages do not appear.
<b>TAPE SELECT</b> Set the length of tape you are using so the unit can show the correct remaining time.	<u>T120</u> : T30, T60, T90, T120 tapes T160: T140, T160 tapes T180: T180 tapes
<b>BLUE BACK</b>	<u>ON</u> : The screen shows a blue background when you play unrecorded portions. OFF: The blue background function is deactivated.
<b>JET NAVIGATOR (→page 24)</b>	<u>ON</u> : Jet Navigator data automatically registered. <u>OFF</u> : Data not registered.
<b>DELETE NAVIDATA</b> Delete all the Navigation data registered in the unit. See page 24 to delete data on a single tape.	<u>NO</u> YES: Then press [ENTER] when you want to delete all the Jet navigator data.
<b>JET SEARCH (→page 18)</b> Set the speed for JET SEARCH when playing EP and VP tapes. ●It is possible to view the picture recorded in the EP and VP mode at approx. 27 or 35 times speed.	×27: <u>×35</u> : Select ×27 if the picture is poor at ×35.
<b>MTS (Changing audio →page 31)</b> Set the MTS (Multi-channel Television Sound Stereo) reception type.	<u>MAIN</u> : To receive stereo broadcasts. SAP: To receive SAP when being broadcast. MONO: To receive monaural broadcasts (e.g., when reception is poor).
<b>OUT1 [VCR/DVD] (→page 17)</b> You can set the unit so that the output is automatically switched to the device which starts playback.	VCR: Only VCR outputs. MANUAL: When the VCR output and DVD output are manually switched <u>AUTO</u> : VCR and DVD are automatically switched depending on the manipulation or the unit operation.



## Onscreen display

To see these displays, set the OSD item in the "OPTION" menu to "ON".

Press [DISPLAY].

The time and operation details appear on the screen for about 5 seconds.

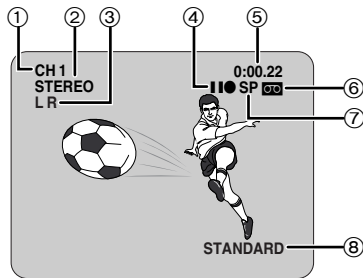

①	<b>Channel display</b> "CH" is displayed when using a television channel, and "C" is displayed when using a cable television channel.
②	<b>STEREO/SAP indication</b> Indicates when a program is broadcast in stereo or SAP. For further details about audio type (→right)
③	<b>L and R indicators</b> The Left (L) and Right (R) indicators show which sound mode is selected as follows: Stereo: Both the L and R indicators appear. L: The L indicator appears. R: The R indicator appears. Normal: Neither the L and R indicator appears.
④	<b>Status display</b> Shows operations taking place.
⑤	<b>Shows the time and tape counter</b> Press [DISPLAY]. The display changes as follows. Present time → Tape counter → Remaining tape time ↑ during Index search: "S 01" to "S 20" is displayed. during Jet Rewind : "J:REW" is displayed. ● Press [CANCEL/RESET] to reset the tape counter (elapsed time) to "0:00.00". The tape counter is automatically reset to "0:00.00" when a video cassette is inserted. ● The remaining time is approximate. It will be incorrect if you set the wrong tape time in the "TAPE SELECT" item in the "OPTION" menu and if the tape is of poor quality.
⑥	<b>Cassette-in indicator</b> Shows whether you have loaded a cassette.
⑦	<b>Tape speed indicator (→page 20)</b>
⑧	<b>Picture mode indicator (→page 19)</b>

**Notes:**

- These displays do not appear when paused or during slow play.
- The on screen display may be distorted depending on the playback tape or the input signal.

## Changing audio

When a stereo and/or SAP broadcast is received, "STEREO" and/or "SAP" light to show the type of broadcast.

**To change the audio**

Press [AUDIO].

The audio changes as follows:

- When playing a tape:  
Stereo → L → R → Normal audio track  
↑
- While watching the television:  
Stereo → L → R  
↑

The table below shows the TV broadcast type, "MTS" settings, and audio recording patterns.

TV broadcast	MTS setting	Audio track		
		Normal (Mono)	Hi-Fi (Stereo)	
			Left	Right
Mono	MAIN or SAP	Mono	Mono	Mono
Stereo	MAIN or SAP	L+R (Mixed)	Stereo left	Stereo right
Mono and SAP	MAIN	Mono	Mono	Mono
	SAP	Mono	Mono	SAP
Stereo and SAP	MAIN	L+R (Mixed)	Stereo left	Stereo right
	SAP	L+R (Mixed)	L+R (Mixed)	SAP

Be sure that "MTS" is set to "MAIN" or "SAP" (→page 30) to record on the Hi-Fi audio tracks.

**Notes:**

- If the sound of a stereo or SAP broadcast is impaired by noise due to weak reception, set "MTS" to "MONO" (→page 30). The TV broadcast is recorded monaurally for easier listening.
- To resume stereophonic recording, set "MTS" to "MAIN" or "SAP" (→page 30).

### Auto Bilingual Choice Function

When a stereo broadcast or SAP broadcast is recorded and played back on this unit, stereo sound will be automatically selected in this case of a stereo broadcast and SAP sound will be automatically selected in the case of a dual-sound broadcast (Mono and SAP or Stereo and SAP).

- The wrong choice may be made if the program is played back from an interim point. (In a case like this, press [AUDIO] and select the right sound.)
- This function works only for a cassette which has been recorded by a video recorder equipped with Panasonic's Auto Bilingual Choice function.
- The function will not work with a cassette which has been recorded using the external equipment.

# Playing discs

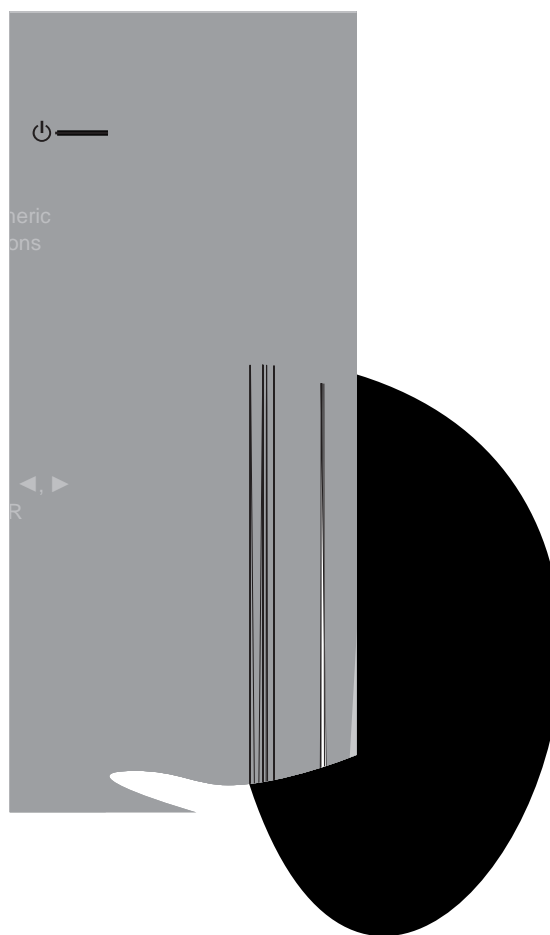

## ■ When a menu screen appears on the television

**DVD-V** | **VCD**

Press the numeric buttons to select the desired item.

Example: "03"; [3]

"10"; [≧10]→[1]→[0]

- Play of the selected item now begins.
- Some discs may take time for the menu screen, video or audio to be presented.
- Many Video CDs with playback control display a menu on the TV when played back. "PBC" is displayed in the unit's display.
- When playing DVDs, you can also use [Cursor]▲▼◀▶ to select items. Press [ENTER] to confirm your selection.
- Some discs allow the items to be selected by [◀◀], [▶▶], etc. The operation differs depending on the disc. Read the disc's instructions for further details about operation.
- Discs continue to rotate while menus are displayed. Press [■] when you have finished viewing to preserve the unit's motor and your television screen.

## To revert to the menu screen

Press [MENU].

For DVDs having two or more menus, the complete menu of the disc may be displayed by pressing [TOP MENU].

## To eject a disc

Press [▲DVD OPEN/CLOSE].

- The disc tray comes out.
- You can eject a disc even if the power is turned off.

## Notes:

- When the unit is first turned on and there is a disk loaded, it may start playing automatically.
- If " (Prohibit) indication appears on the television, the operation is prohibited by the unit or disc. In this case, either of the following marks is displayed:

## Basic play

**DVD-V** | **RAM** | **VCD** | **CD** | **MP3** | **WMA**

### Preparations

- To view the video on a DVD or Video CD, turn on the TV and confirm that the unit viewing channel is selected.
- Press [VCR/TV] to select the video input mode for this unit.
- Switch [VCR/TV/DVD] to "DVD".
- Press [DVD] to turn on the unit.
- When "OUT1 [VCR/DVD]" in the VCR MENU "OPTION" is set to "MANUAL", press [VCR/DVD OUTPUT] to switch it to disc video. (→page 17)

### Operations

**1 Press [▲DVD OPEN/CLOSE] to open the disc tray.**

**2 Place the disc with the label facing upward.**

- Load double-sided discs so the label for the side you want to play is facing up.

**3 Press [▶](PLAY).**

- The disc tray closes and play begins. It is normal for sound and pictures to take time to start.

**MP3** | **WMA** | **CDtext**

Track information appears on the television. Press [SUBTITLE] to turn the display on or off.

- If a disc cannot be played and "U11" appears in the unit's display, it is possible that fingerprints or dust is on the data side of the disc.
  - Clean the data side of the disc with a soft cloth. (→page 6)
  - If the disc is not dirty and "U11" is still displayed, the optical pick lens\* may have gotten dirty. In this case, contact your dealer.
- \*Lens built into this unit to read the data on the disc.



## To view with progressive output **DVD-V**

You can enjoy higher image quality than that output from the conventional video out terminal or S-video terminal (**Interlace and progressive output** →page 58).

### Preparations

- Connect the COMPONENT VIDEO OUT terminal on the rear side of this unit to the component video in terminal on the TV (→page 13).
- In the SET UP menu "Video", set "Progressive Out (Component)" to "Enable" (→page 49).

### Operation

Press **[PROGRESSIVE OUT]** on this unit before or during playback.



- The VCR video may not be progressive-output.

### To check whether progressive output is on or off

Press **[PROGRESSIVE OUT]**. "PR ON" (on) or "PR OFF" (off) appears on the unit's display.

### Notes:

- The television will be disrupted for a moment but this is normal.
- Output from this unit is interlace if you have connected to the television through VIDEO OUT or S-VIDEO OUT terminals, irrespective of the settings.
- When progressive output is on, closed captions will not be displayed.

## About the adjustment of the screen size for progressive output

If 4:3 (Standard) video is viewed on a 16:9 (Wide) screen TV, the picture may look extended towards the right and left because the screen sizes are different.

Also, the message is displayed on the TV screen for a few seconds.

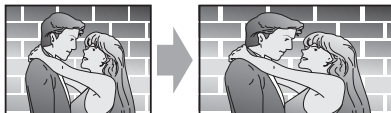

In this case:

- **Where the TV allows the screen to be adjusted for progressive video:**

Adjust it using the corresponding TV function. (Refer to the instructions for the TV.)

- **Where the TV does not allow the screen to be adjusted for progressive video:**

Press **[PROGRESSIVE OUT]** to cancel the progressive output. (This will cause the unit's display to indicate "PR OFF".)

## Starting play from where you stopped it

**DVD-V** **RAM** **VCD** **CD** **MP3** **WMA**

(When the elapsed play time is displayed)

### Operations

- 1 Press **[■]** while playing to stop playing.

Display Symbol



- When "▶" in the unit's display flashes, the Resume function (→below) is active.
- When the whole disc has finished playing, the unit automatically stops. Some discs present a menu screen.

### Resume function

To play from where you stopped it

- 2 While stopped (when "▶" in the unit's display flashes) Press **[▶](PLAY)** once.

### Chapter Preview **DVD-V**

After viewing the digest of all chapters previously played, the unit will start playing again at the point you stopped.

- 2 While stopped (when "▶" in the unit's display flashes)

On Screen Display

Press **[▶](PLAY)** twice.

Press PLAY to Preview Chapters

- The unit plays back the beginning portions of each chapter for approx. 5 seconds to the point where you stopped playing and starts playing there.
- This is operative for one title only.
- This does not apply to DVD-RAM.

### To cancel the position at which play stopped

Press **[■]** again.

- The Resume function is cancelled.
- The position is also cleared when you turn the unit off, select another source or open the disc tray.

## Position Memory function

**DVD-V** **RAM** **VCD** **CD** **MP3** **WMA**

(When the elapsed play time is displayed)

To turn off or replace a disc with the stop position memorized.

- 1 Press **[POSITION MEMORY]** during play.

- The message "Position Memorized" appears on the television.

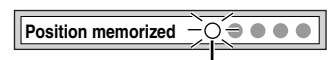

Flashes as you memorize a position.

- Press again to replace the position.
- The unit memorizes such a position: one per disc, up to 5 discs.  
If you set up 6 positions or more, the positions will be erased one after another, starting from the oldest one.
- This function may not work while playing some DVDs or play lists on DVD-RAM.

- 2 Turn off the unit or remove the disc.

- 3 Turn on the unit or set a disc for which the position is memorized and press **[▶](PLAY)**.

- Play starts from the memorized position and the position is cleared.
- When play starts, "Position cleared." is displayed and the position memory is cleared.

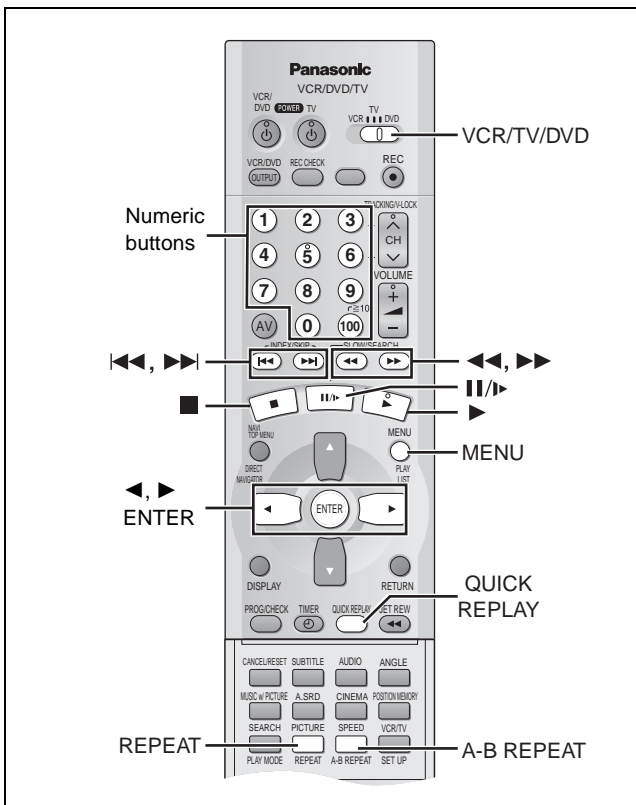

## To immediately access a specific scene or track

DVD-V | RAM | VCD | CD | MP3 | WMA

### Preparations

- To view the video on a DVD or Video CD, turn on the TV and select the video input for this unit.
- Switch [VCR/TV/DVD] to "DVD".

## Starting play from a selected title (track)

Enter the number of the title (track) to be played using the numeric buttons ([0] through [9] and [100]).

- The title (track) selected is played.

Example: "03"; [3]

"10"; [≥10]→[1]→[0]

MP3 | WMA "16"; [1]→[6]→[ENTER] or [▶](PLAY).

"125"; [1]→[2]→[5]→[ENTER] or [▶](PLAY).

### Notes:

- This works only when stopped with some discs.
- This may not work depending on the disc or the play status.

## Select a track number directly to play back a Video CD with playback control, without using the menu play.

- 1) Press [■] while in the stop mode (menu display) to erase "PBC" from the unit's display.
- 2) Press the numeric buttons.
  - To return to the menu play, press [MENU] to restore "PBC" in the unit's display.

## Skipping chapter(s)/track(s)

Press [◀◀] (backward) or [▶▶] (forward).

- Each press increases the number of skips.

### Notes:

- This works while stopping on some discs.
- After skipping, the unit returns to the previous state, play or pause.
- Pressing [◀◀] or [▶▶] may take you to a menu screen depending on the disc or the portion played (e.g. Video CDs). This may not work on some discs.

### How to specify a position to be accessed:

DVD-V | VCD | CD | MP3 | WMA

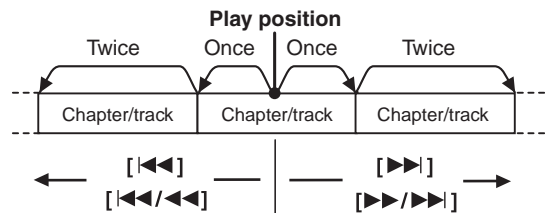

- Press [◀◀] once, and the header of the current chapter (track) is accessed. However, if you press [◀◀] when the header of a chapter (track) is being played, the previous chapter (track) is accessed.

### RAM

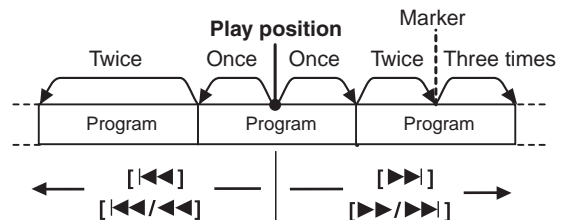

- The header of the program can be accessed, or if the marker is memorized, the marker position is accessed. Press [◀◀] once, and the header of the program played or the previous marker position is accessed. Playback automatically restarts there. However, if you press [◀◀] when the header of a program (or the header of a marker position) is being played, the header of the previous program (or the header of the previous marker position) is accessed.

# Other methods of play

DVD-V | RAM | VCD | CD | MP3 | WMA

## Preparations

To view the video on a DVD or Video CD, turn on the TV and select the video input for this unit.

Switch [VCR/TV/DVD] to "DVD".

## To view missed scenes (Quick Replay)

### During play

Press [QUICK REPLAY].

Each press: skip back the scene by 7 to 10 seconds within the current item (program, track or title) and plays it back.

### Notes:

The time a scene is skipped back varies depending on the recording status of the disc.

This may not work depending on the disc or the portion played.

## Search

### During play

Press [◀◀] (backward) or [▶▶] (forward).

Each press or hold accelerates the speed (5 steps).

### To cancel search for normal play

Press [▶](PLAY).

### Notes:

You will hear sound at the lowest speed in the five steps (only forward) when playing DVDs and Video CDs. You can turn this audio off if you want to. (SET UP menus "Audio" → "Audio during Search" → page 49)

Pressing [◀◀] or [▶▶] may take you to a menu screen depending on the disc or the portion played (e.g. Video CDs).

## To view a still picture (pause)

### During play

Press [II/▶].

The disc keeps rotating when showing a still picture (pausing).

## Frame-by-frame viewing

DVD-V | RAM | VCD

### While paused

Press [Cursor] ◀ (backward DVD-V | RAM) or ▶ (forward).

Each press shows the next or previous frame.

Pressing and holding shows successive frames forward (backward).

For forward only, pressing [II/▶] also shows frame by frame.

## Slow-motion play

DVD-V | RAM | VCD

### While paused

Press [◀◀] (backward DVD-V | RAM) or [▶▶] (forward).

There are 5 slow-motion speeds. Each press increases the slow-motion speed.

### To cancel still picture, frame-by-frame, slow-motion for normal play

Press [▶](PLAY).

## To play repeatedly (Repeat play)

DVD-V | RAM | VCD | CD | MP3 | WMA

(When the elapsed play time is displayed)

Press [REPEAT] during play.

Each press:

DVD-V

Chapter → Title → Off

e.g. DVD-V

On Screen Menu Icon

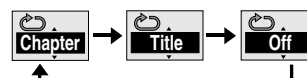

RAM

Program → All (whole disc) → Off

• While playing a play list

Scene → Playlist → Off

VCD | CD

Track → All (whole disc) → Off

MP3 | WMA

Track → Group → Off

## To repeat playing in the order programmed (Program Repeat Play)

Press [REPEAT] during program play (→ page 36).

Each press:

DVD-V

Chapter → All → Off

(Only chapter being played) (Whole title programmed)

VCD | CD | MP3 | WMA

Track → All → Off

(Only track being played) (Whole track programmed)

### Notes:

- This may not work on some DVDs.
- If a DVD has 2 or more titles, it does not allow the whole disc to be repeated.
- This does not work during menu play of a Video CD with playback control.

## Repeating a section between two specified points (A-B repeat play)

DVD-V | RAM | VCD | CD | MP3 | WMA

(When the elapsed play time is displayed)

You can repeat a section between points A and B within a title or track.

### 1 During play

Press [A-B REPEAT] to specify the start point (A).



2 Press [A-B REPEAT] to specify the finish point (B).



- A-B repeat starts when you specify point B.

### To cancel A-B repeat

Press [A-B REPEAT] again.



### Notes:

- This may not work on some DVDs.
- The unit automatically determines the end of a title/track as point B when the end of the title/track is reached.
- Some subtitles recorded around point A or B may fail to appear.
- Pressing [QUICK REPLAY] during A-B repeating cancels this mode.

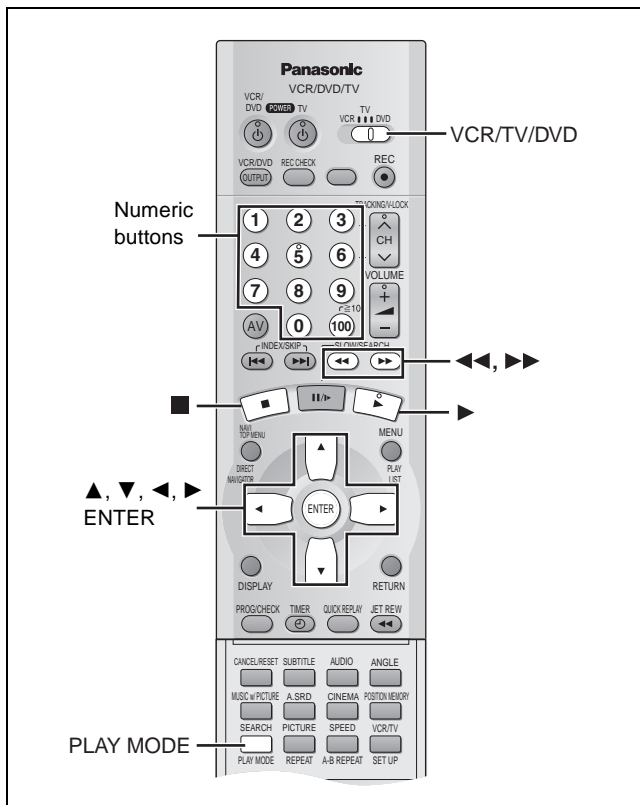

#### Preparations

- Switch [VCR/TV/DVD] to "DVD".

### To play chapters/tracks at random (Random play)

**DVD-V** **VCD** **CD** **MP3** **WMA**

Plays chapters in one DVD title or all tracks in a Video CD and audio CD at random.

- 1 Press [PLAY MODE] twice while stopped.

#### 2 **DVD-V**

Select the title number to be played at random with [Cursor]▲▼.

- The chapters in the selected title are played at random.

- 3 Press [▶](PLAY).

- Random play starts.
- When random play ends, the unit stops and the screen reverts to the random play display.

#### On Screen Display



e.g. **DVD-V**

#### To cancel random play

- 1) Press [■] during random play.
- 2) Press [PLAY MODE].

### To play in your favorite order (Program play)

**DVD-V** **VCD** **CD** **MP3** **WMA**

You can select up to 32 items to play in the order you choose.

- This does not apply to DVD-RAM. This may not work with some DVD discs.

- 1 While stopped Press [PLAY MODE].

- 2 Press [ENTER].

- 3 Use [Cursor]▲▼◀▶ to select a title, chapter, group or track and then press [ENTER] to register.

- Repeat this step to program other items.
- Select "ALL" to enter all the items in the selected disc, title or group.
- **DVD-V** Some items cannot be selected.
- You can also use the numeric buttons to select items.

Example: "03"; [3]

"10"; [≥10]→[1]→[0]

**MP3** **WMA** "16"; [1]→[6]→[ENTER]

"125"; [1]→[2]→[5]→[ENTER]

- 4 Press [▶](PLAY).

- Play starts in the programmed sequence.
- You may also select "Play" in [Cursor]▶ and press [ENTER] to start playing.
- When the Program play ends, the unit stops and the program entry screen appears.

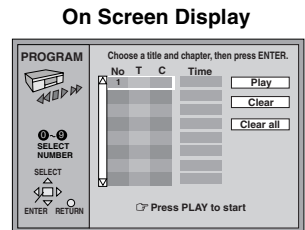

#### To interrupt Program play

- 1) Press [■] twice during Program play.
- 2) Press [PLAY MODE] twice.

- The program is retained.

Press [PLAY MODE] again, and the current program entry state appears.

#### To change a program

- 1) Select the program number to be changed with [Cursor]▲▼ and press [ENTER].
- 2) Carry out step 3 and change an item.

- Press [◀◀] or [▶▶], and the screen page is changed to allow the program number to be displayed more quickly.

#### To cancel a program

- 1) Select the program to be cancelled by [Cursor]▲▼.
- 2) Use [Cursor]▶▼ to select "Clear" and Press [ENTER].

- You may also cancel it by pressing [CANCEL/RESET].

#### To clear the whole program

- 1) Use [Cursor]▶▼ to select "Clear all".
- 2) Press [ENTER].

#### Notes:

- **DVD-V** **WMA** **MP3**

Times are not displayed while programming.

- "Total Time" may be slightly different from the total time of the tracks selected, and "Total Time" indicates the real play time.

- The program is cleared when you switch the unit to standby, open the disc tray, select another source.

# Playing the programs or play lists on DVD-RAM

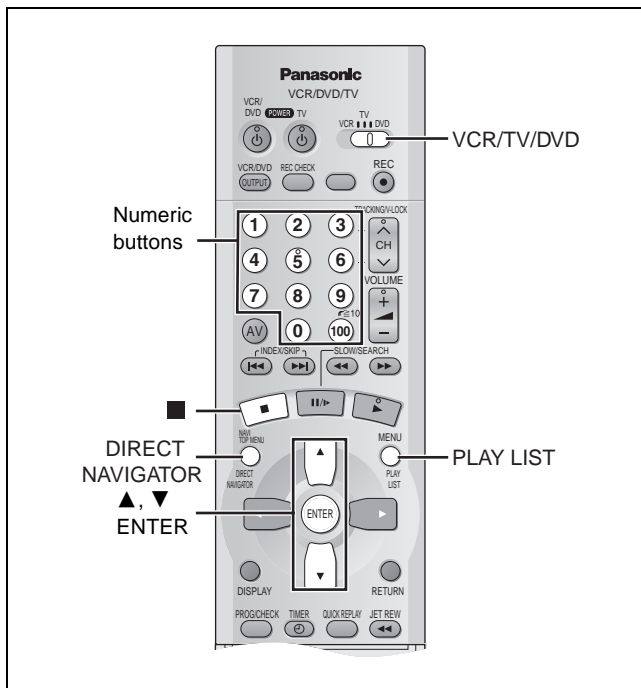

## Selecting a program to play (Direct Navigator)

**RAM**

You can search for a desired program in the list of the programs recorded by Panasonic DVD video recorders (optional) to play it.

### Preparations

- Turn on the TV and select the video input for this unit.
- Switch [VCR/TV/DVD] to "DVD"
- Insert a recorded DVD-RAM disc.

### 1 Press [DIRECT NAVIGATOR].

- Program numbers, dates of recording, times at which recording started, and program titles (where applicable) of the programs recorded on that disc are displayed.
- If pressed when stopped, playback automatically starts and this screen appears.

**On Screen Display**

No	Date	On	Program Title
1	11/1(MON)	11:02PM	Monday feature
2	11/1(TUE)	10:35PM	Auto action
3	11/1(TUE)	10:00PM	Cinema
4	11/1(THU)	9:30PM	Music
5	11/1(THU)	8:05PM	Baseball

Nov. 2002 Used 0:49:40

### 2 Press [Cursor]▲▼ to select the desired program.

- The program selected is played in the background.
- You can also select programs by entering a 2-digit number with the numeric buttons.

Example: "03"; [3]  
"10"; [≥10]→[1]→[0]

### 3 Press [ENTER].

- The list disappears and you can view the selected program.

### To stop play

Press [■].

### To clear the program list

Press [DIRECT NAVIGATOR] or [RETURN].

### Notes:

- The DIRECT NAVIGATOR program list displays up to 99 programs.
- You cannot change program and disc titles.
- This does not work for commercially available DVDs or CDs.

## To play back favorite scenes only (Play lists)

**RAM**

Play lists created on Panasonic DVD recorders (optional) can be played back.

### Play list:

It is a list of moving pictures edited on Panasonic DVD recorders (optional) by collecting only favorite scenes in programs or by replacing some scenes.

- This unit allows play lists created on Panasonic DVD recorders to be played back.

### Preparations

- Turn on the TV and select the video input for this unit.
- Switch [VCR/TV/DVD] to "DVD".
- Insert the DVD-RAM disc on which play lists were created.

### 1 Press [PLAY LIST].

- The play list screen appears.

### 2 Press [Cursor]▲▼ to select the play list.

- You can also select play lists by entering a 2-digit number with the numeric buttons.

Example: "03"; [3]  
"10"; [≥10]→[1]→[0]

### On Screen Display

No	Date	Length	Title
1	10/17	0:46:35	Clay Penguin
2	10/24	0:09:15	Ashley at Prom
3	11/29	0:12:32	Formula one
4	12/22	0:07:30	Soccer
5	12/23	0:30:20	Baseball
6	12/23	0:08:15	Neanderthal
7	12/24	0:15:30	Cartoons
8	12/24	0:20:30	Trilobites
9	12/25	0:20:00	White Dwarf
10	12/25	0:55:00	Discovery

### 3 Press [ENTER].

- The selected play list is played back.

### To stop play list play

Press [■].

- The play list screen appears.

### To clear the play list screen

Press [PLAY LIST] or [RETURN].

### Notes:

- When playing a play list, search, pause, and slow-motion play are operative as in normal playback.
- Up to 99 play lists can be displayed.
- This does not work for commercially available DVDs or CDs.

DVD



## ■ Viewing the text information on tracks

### CDtext

While the menu screen is displayed

- 1 To view the information for a track, select it with [Cursor]▲▼.
- 2 View the text information with [Cursor]▶.
  - To view the information of other tracks, press [Cursor]◀▶.

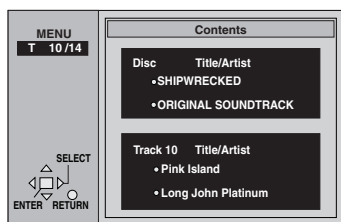

### To start playback

Press [ENTER].

### To get back to the previous screen.

Press [RETURN].

## To find a file by entering part of the title

You can find a file by entering part of the title.

Only uppercase characters can be entered, but corresponding lowercase characters are also searched.

**Example: To find tracks containing the term "LOVE"**

- 1 Call up the menu screen with [MENU] or [TOP MENU].
  - The order of tracks indicated on the menu screen may be different from that indicated on the personal computer display.
- 2 Select "Find" with [Cursor]▲▼ and press [ENTER].
- 3 Select "L" with [Cursor]▲▼ and press [ENTER].
  - Each press of [Cursor]▲ changes ["A" through "Z"], then ["0" through "9"].
  - Repeat this step to enter "O", "V", and "E".
  - If you select a wrong character, press [Cursor]◀, and the previous character appears.
- 4 Select "Find" with [Cursor]▶ and press [ENTER].
  - The result of the search is displayed.
  - If there are no tracks found as a result of the search, a message is displayed.
- 5 Select the track to be played with [Cursor]▲▼ and press [ENTER].

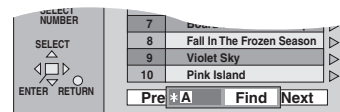

### To get back to the previous screen.

Press [RETURN].

### Notes:

- Only alpha-numeric characters can be entered. (Up to 8 characters can be entered.)
- You can also use the numeric buttons to enter the number.

### About "\*" (asterisk)

- Add "\*" at the beginning of the term to be searched for, all the tracks containing the term are retrieved.  
Example: [Love and peace], [We love Baseball], etc.
- If "\*" is not added, only the tracks having the term at the beginning of the titles are retrieved.  
Example: [Love and peace], [Love is mind], etc.  
In this case, [We love Baseball], etc. is not retrieved.



# To get more enjoyment from movies and music

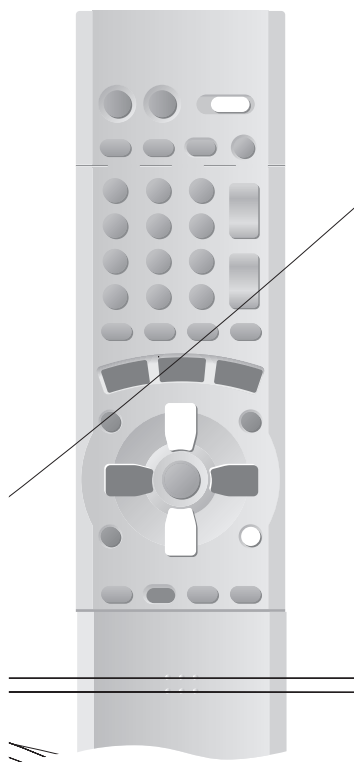

## To switch subtitle, audio or angle-view

### Preparations

- To view the video on a DVD or Video CD, turn on the TV and select the video input for this unit.
- Switch [VCR/TV/DVD] to "DVD".

### Subtitles

**DVD-V** (Discs with multiple subtitle languages)

You can change the subtitle language and turn the subtitles on and off.

**RAM** You can turn the subtitles on and off.

**During play, press [SUBTITLE].**

The number changes each time you press the button.

- It may take some time until the language selected actually appears.

### To clear/display the subtitles

Press [Cursor]▶ (DVD-V), then select "OFF" or "ON" with [Cursor]▲▼.

### Changing the position and brightness of the subtitles

**DVD-V**

- 1) While the subtitle icon is on the screen, press [Cursor]◀▶ to highlight "Subtitle Position" or "Subtitle Brightness".
  - 2) Press [Cursor]▲▼ to adjust.
- Adjust position between 0 and -60 in 2 unit steps.
  - For brightness, select "Auto" so the brightness adjusts automatically against the background, or level between 0 and -9.

## Soundtracks

**DVD-V** **RAM** **VCD** (Discs with multiple soundtracks)

**During play**

Press [AUDIO].

**DVD-V** The number changes each time you press the button.

**RAM** **VCD** Each press:

### Note:

- You can also use this button to turn the vocals on and off on karaoke discs. Read the disc's instructions for details.

## Angles

**DVD-V** (Discs with multiple angles)

**During play**

Press [ANGLE].

The angle number changes each time you press the button.

### To erase the on-screen display for subtitles, audio or angle-view

Press [RETURN].

### About subtitle, soundtrack and angle-view numbers:

- "—" or "—" is displayed instead of the language number in circumstances such as when no language is recorded on the disc.
- You may also select one using numeric buttons or [Cursor]▲▼.
- If there is only one recorded, the "▲" or "▼" mark does not appear.
- " " appears, you have selected a number not recorded on that disc.
- Some discs allow changes to subtitles, soundtracks and angles only by using the disc's menus.
- If you want to start a program played in your favorite language from the beginning, set "Subtitle" and "Audio" in the SET UP menus "Disc" (→page 49).
- There are some discs that allow the angle number to be specified beforehand. Refer to the instructions for the disc.



## To change the settings in accordance with the software

### Preparations

- To view the video on a DVD or Video CD, turn on the TV and select the video input for this unit.
- Switch [VCR/TV/DVD] to "DVD".

## ADVANCED SURROUND = V.S.S. (Virtual Surround Sound)

DVD-V | RAM | VCD (2-channel or over only)

You can enjoy a surround-like effect if you are using two front speakers (SP) or headphones (HP). The effect is broadened and the sound seems to come from virtual speakers on either side if the disc has surround signals recorded on it.

### Press [A.SRD].

Each press:

- **SP1/HP1:** Natural effect
- ↓
- SP2/HP2:** Emphasized effect
- ↓
- SP OFF/HP OFF:** Cancel (Initial Setting)



- To enjoy HP-V.S.S., connect the unit to equipment that has a headphone jack. Select "SP" by [Cursor]◀ while the icon on the above is displayed, then select "HP" with [Cursor]▲▼.

### Notes:

- To activate the Dolby Pro Logic surround effect, turn this "OFF".

### Effective listening using the front speakers only

- Listen at a distance from the speakers 3 to 4 times the distance between the right and left front speakers for best effects.
- If "SP1" or "SP2" is selected, only the front speakers sound.
- To activate, turn off the surround effects on other equipment.
- V.S.S. will not work, or will have less effect, with some discs.
- Turn V.S.S. off if it causes distortion.

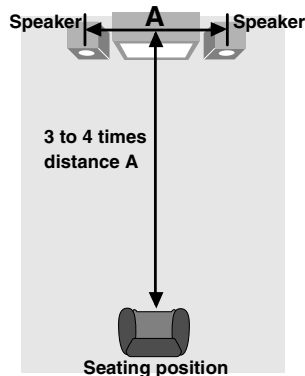

## CINEMA

DVD-V | RAM | VCD

You can change the picture quality for movie viewing.

### Press [CINEMA].



Each press:

- **Cinema 1:** Mellows images and enhances detail in dark scenes.
- ↓
- Cinema 2:** Sharpens images and enhances detail in dark scenes.
- ↓
- Normal:** Normal mode (Initial Setting)





- The function suppresses the glare feeling specific to cathode-ray tube TVs and provides soft and smooth pictures.
- Even during dark and unclear scenes, this function regenerates the contours on dark backgrounds for easy identification of persons.
- Press [CINEMA]. Then each press of [Cursor]▲▼ switches Cinema1 → Cinema2 → User → Normal. The "User" mode allows the picture quality to be adjusted to your liking by selecting "Picture Menu" → "Picture mode" on the Unit information of On-Screen Menu Icons (→page 46).

## DIALOGUE ENHANCER

DVD-V

(Dolby Digital, DTS, 3-channel or over, where the dialogue is recorded in the center channel)

This makes the dialogue in movies easier to hear.

- 1 Press [DISPLAY] several times and select the Unit information. (→page 43)
- 2 Press [Cursor]▲▼ to select the Audio menu.    
- 3 Press [Cursor]◀▶ to select "Dialogue Enhancer".
- 4 Press [Cursor]▲▼ to select "ON" or "OFF" (Initial Setting). 

### Note:

- Dialogue Enhancer will not work or will have less effect with some discs.

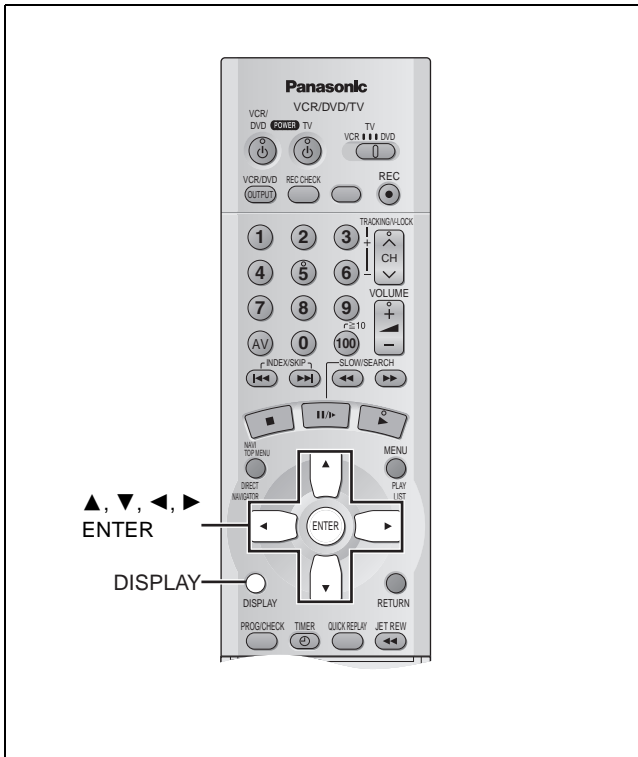

## Variable Zoom function

**RAM DVD-V VCD**

Change the zoom ratio so the pictures expands to the optimum size to fill the screen.

### Preparation

Change the setting "TV Aspect" to suit your television. (→page 49)

#### During play

**1 Press [DISPLAY] several times and select the Unit information.** (→page 43)

**2 Press [Cursor]▲▼ to select the Display Menu.**

On-Screen Menu Icon



**3 Press [Cursor]◀▶ to select "Zoom" and press [ENTER].**

**4 Press [Cursor]◀▶ to select the aspect ratio.**

Zoom display The zoom ratio changes each time you press the button.

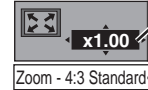

The popup shows the video format suited to the ratio.

Each press:

**4:3 Standard → European Vista → 16:9 Standard**

**Cinemascope2 ← Cinemascope1 ← American Vista**

- Refer to the disc's instructions and "Screen size" below for the aspect ratio of the picture.

**5 Press [ENTER].**

## Making fine adjustments to the zoom ratio

While the Zoom icon is displayed

Press [Cursor]▲▼.

The ratio changes in 0.01 units between 1.00 and 1.60 and in 0.02 units between 1.60 and 2.00.

### Notes:

- The ratio returns to 1.00 when you open the disc tray, change the source or switch the unit to standby.
- The ratio may return to 1.00 when a menu is displayed.

### Screen size:

Movies are made using a variety of screen sizes.

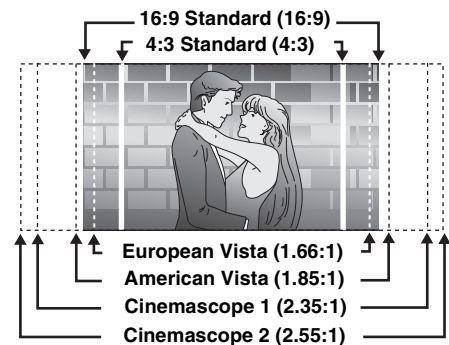

# Using On-Screen Menu Icons

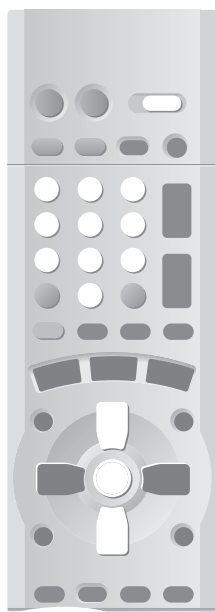

DVD-V RAM VCD CD MP3 WMA

On-Screen Menu Icons are menus that contain information about the disc or unit. These menus allow you to perform operations by changing this information.

## Preparations

- Turn on the TV and select the video input for this unit.
- Switch [VCR/TV/DVD] to "DVD".

## Common procedures

### 1 Press [DISPLAY] several times during play or when stopped.

Each press:

Disc information (→page 44) → Progress indicator (→page 44)

Original display ← Unit information (→page 45, 46)

Unit Information only:

While the leftmost icon is highlighted

Press [Cursor]▲▼ to select the menu.

- Each press:

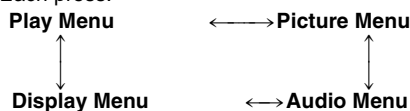

### 2 Press [Cursor]◀▶ to select the item.

### 3 Change the setting with [Cursor]▲▼.

- About the operation for each item (→page 44 to 46)
- If "▲", "▼" or both appear in each frame, you can select an item with [Cursor]▲▼.
- Some items require pressing numeric buttons or [ENTER] for selection.

## To cancel the menus

Press [DISPLAY] several times. Or press [RETURN].

## To change the position of the icons

If a DVD disc is played back with the [Automatic Picture Zoom] function activated on the TV, the icons may not be displayed in whole or in part. In this case, move the icons.

- 1) Press [Cursor]◀▶ to select the rightmost icon.
- 2) Press [Cursor]▲▼ to move the icons.  
(There are 5 positions.)

## Notes:

- The contents displayed differ depending on the disc.
- Some items may not be operated depending on the disc or the playback status (stopped, etc.).
- For details of items that can be operated by means other than the icons, see the respective pages.

Disc information

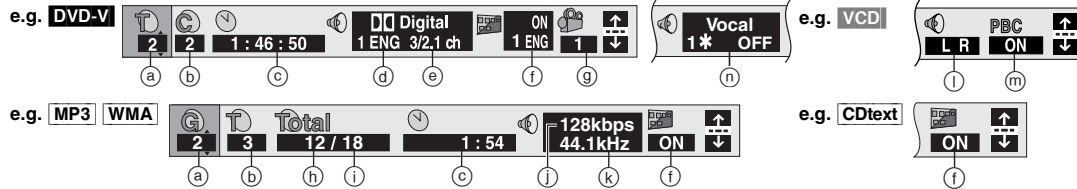

a	<b>PG:</b> Program number <b>RAM</b> <b>PL:</b> Play list number <b>RAM</b> <b>G:</b> Group number <b>MP3</b> <b>WMA</b> <b>T:</b> Title number <b>DVD-V</b> Track number <b>VCD</b> <b>CD</b>	[Cursor] ▲▼ [ENTER]
b	<b>T:</b> Track number in group <b>MP3</b> <b>WMA</b> <b>C:</b> Chapter number <b>DVD-V</b>	
c	<b>Time</b> <b>DVD-V</b> <b>RAM</b> Select a position to start play by specifying a time. Example: To start from one hour 46 minutes 50 seconds [1]→[4]→[6]→[5]→[0]→[ENTER] <b>Changing the time display</b> <b>DVD-V</b> <b>RAM</b> <b>VCD</b> <b>CD</b> → Elapsed play time for the program, play list, title or track ↓ ↑ Remaining time for the disc ( <b>VCD</b> <b>CD</b> only) ↓ ↑ Remaining time for the program, play list, title or track <b>Elapsed play time</b> <b>MP3</b> <b>WMA</b> (Display only, cannot be changed)	Numeric buttons ↓ [ENTER]  [Cursor] ▲▼
d	<b>Soundtrack</b> <b>DVD-V</b> <b>RAM</b> (→page 40)	
e	<b>Audio attributes</b> <b>DVD-V</b> <b>RAM</b> (Display only) <b>LPCM</b> , <b>Digital</b> , <b>DTS</b> , <b>MPEG</b> : Signal type <b>k:</b> Sampling frequency (kHz) <b>b:</b> Number of bits (bit) <b>ch:</b> Number of channels (→page 58)	Display only

f	<b>Subtitle language</b> <b>DVD-V</b> (→page 40) <b>Subtitles on/off</b> <b>DVD-V</b> <b>RAM</b> <b>Track information on/off</b> <b>MP3</b> <b>WMA</b> <b>CDtext</b>	[Cursor] ▲▼
g	<b>Angle number</b> <b>DVD-V</b> (→page 40)	
h	<b>Track number in disc</b> <b>MP3</b> <b>WMA</b>	[Cursor] ▲▼ ↓ [ENTER]
i	<b>Total number of tracks on disc</b> <b>MP3</b> <b>WMA</b>	Display only
j	<b>Current bitrate (kbps)</b> <b>MP3</b> <b>WMA</b>	
k	<b>Current sampling frequency (kHz)</b> <b>MP3</b> <b>WMA</b>	
l	<b>Audio mode</b> <b>RAM</b> <b>VCD</b> (→page 40) LR→L→R ↑	[Cursor] ▲▼
m	<b>Menu play</b> <b>VCD</b> (with playback control only)	Display only
n	<b>Karaoke vocal on/off</b> <b>DVD-V</b> (Karaoke DVD only) If a DVD title is a duet, select V1 or V2 to duet with the unit.	[Cursor] ▲▼

Audio/Subtitle language

ENG: English	SVE: Swedish	CHI: Chinese
FRA: French	NOR: Norwegian	KOR: Korean
DEU: German	DAN: Danish	MAL: Malay
ITA: Italian	POR: Portuguese	VIE: Vietnamese
ESP: Spanish	RUS: Russian	THA: Thai
NLD: Dutch	JPN: Japanese	*: Others

Progress indicator

Indicates how far you have played through an item.

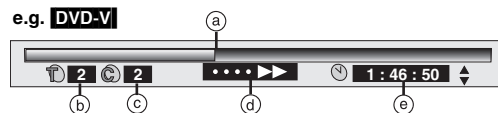

a	<b>Current position</b> <b>DVD-V</b> <b>RAM</b> <b>VCD</b> <b>CD</b> <b>MP3</b> <b>WMA</b>	Display only
b	<b>PG:</b> Program number <b>RAM</b> <b>PL:</b> Play list number <b>RAM</b> <b>T:</b> Title number <b>DVD-V</b> Track number <b>VCD</b> <b>CD</b> <b>G:</b> Group number <b>MP3</b> <b>WMA</b>	
c	<b>T:</b> Track number in group <b>MP3</b> <b>WMA</b> <b>C:</b> Chapter number <b>DVD-V</b>	
d	<b>Condition – play, pause, or slow/search</b> <b>DVD-V</b> <b>RAM</b> <b>VCD</b> <b>CD</b> <b>MP3</b> <b>WMA</b> <b>Play speed (→right)</b>	
e	<b>Changing the time display</b> <b>DVD-V</b> <b>RAM</b> <b>VCD</b> <b>CD</b> → Elapsed play time for the program, play list, title or track (or chapter during program/random play) ↓ ↑ Remaining time for the program, play list, title or track (or chapter during program/random play) <b>Elapsed play time</b> <b>MP3</b> <b>WMA</b> (Display only)	[Cursor] ▲▼

Changing play speed

You can change the slow-motion play speed.

Slow-motion play **DVD-V** **RAM** **VCD**

Backward slow-motion play **DVD-V** **RAM**

During still pause, press [Cursor] ◀ or ▶ to select the direction and slow-motion play speed.

Each press: the speed is changed in 5 steps.

To return to normal play

Press [▶](PLAY) or [ENTER].

Unit information

Play Menu

e.g. DVD-V

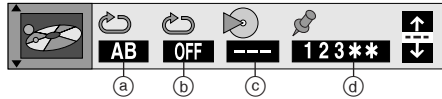

a	<b>A-B Repeat</b> (→page 35) DVD-V RAM VCD CD MP3 WMA →Specify point A ↓ Specify point B (A-B repeat starts) ↓ Normal playback (A-B repeat cancel)	[ENTER] ↓ [ENTER] ↓ [ENTER]
b	<b>Repeat mode</b> (→page 35) DVD-V RAM VCD CD MP3 WMA	[Cursor] ▲▼
c	<b>Play mode</b> (→page 36) DVD-V VCD CD MP3 WMA ---: Normal play PGM: Program play RND: Random play	Display only
d	<b>Marker</b> (→below) DVD-V RAM VCD CD MP3 WMA	

Marker

Stores the position from which playback will resume later.

- 1 Press [ENTER].
- 2 Press [ENTER] again at the position to be stored.

To mark another position

Up to 5 points (RAM only: up to 999 points)

- 1) Press [Cursor]▶ to select “\*”.
- 2) Press [ENTER] at the point.

To recall or erase a marker

- 1) Press [Cursor]◀ to select a marker.
- 2) Press [ENTER] to recall or press [CANCEL/RESET] to erase.

To mark the eleventh point and beyond RAM

- 1) Press [Cursor]◀ to select the marker pin icon.



- 2) Press [Cursor]▲▼ to select “11-20”.  
You can select the next group when the current group is full.
- 3) Press [Cursor]▶.
- 4) Press [ENTER] to mark a position.

Note:

- The markers are ordered by time. This means that the marker numbers can change when you add and erase markers.
- If places have been marked (e.g., with a DVD video recorder), they are displayed.
- You can clear existing markers, but they are restored when you open the disc tray, change the source or switch the unit to standby.
- This feature doesn't work while using a play list.
- This feature doesn't work during program and random play.
- Markers added with this unit clear when you turn the unit off, change the source, or open the disc tray.

Audio Menu

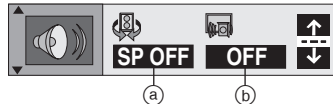

a	<b>Advanced surround</b> (→page 41) DVD-V RAM VCD V.S.S. mode: SP↔HP SP/HP level: 1→2→OFF	[Cursor] ▲▼
b	<b>Dialogue Enhancer on/off</b> (→page 41) DVD-V ON↔OFF	

Display Menu

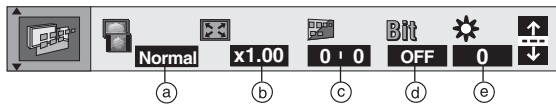

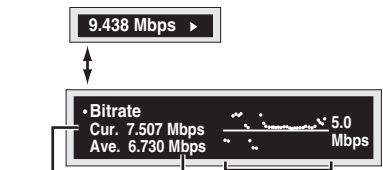
a	<b>4:3 Aspect</b> DVD-V RAM VCD Select how to show images made for 4:3 aspect screens on a 16:9 aspect television. <b>Normal:</b> Laterally stretches images made for a 4:3 screen. <b>Auto:</b> Expands suitable 4:3 letterbox images to fill more of the screen. Other images appear in full in the center of the screen. <b>Shrink:</b> Images appear in the center of the screen. <b>Zoom:</b> Expands all images to fill the screen. If your television has a similar feature, use it instead for a better effect.	
b	<b>Zoom</b> (→page 42) DVD-V RAM VCD	[ENTER] ↓ [Cursor] ◀▶ ↓ [ENTER]
c	<b>Making fine adjustments to the zoom ratio</b> (→page 42) DVD-V RAM VCD	[Cursor] ▲▼
d	<b>Subtitle position/Subtitle brightness</b> DVD-V (→page 40)	
e	<b>Bitrate display on/off</b> DVD-V RAM VCD When you select “ON”: During play: Shows the bitrate (approximate values) of the video being played While paused: Shows the data volume of the frame and type of picture (Glossary—I/P/B →page 58) While the display is on, press [Cursor]◀▶ to change the display:  Current bitrate      A record of bitrates for a sampling period. Average bitrate	[Cursor] ▲▼
e	<b>OSD brightness (-3 to +3)</b> Adjust the brightness of the on-screen displays.	[Cursor] ▲▼

DVD

Picture Menu **DVD-V** **RAM** **VCD**

When progressive output is on:

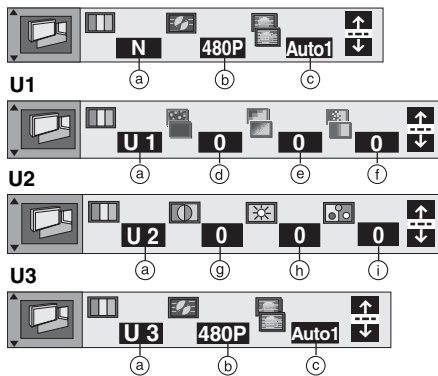

When progressive output is off:

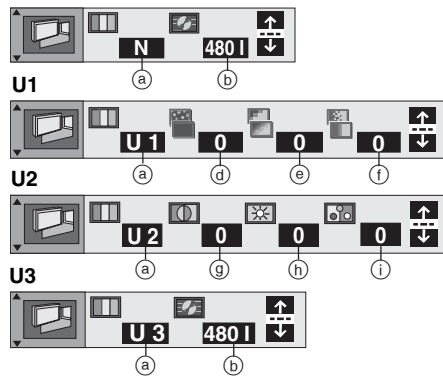

Unless otherwise indicated, select items with [Cursor]◀▶ and change with [Cursor]▲▼.

(a)	<p><b>Picture mode</b>  <b>N:</b> Normal mode  <b>C1:</b> Mellows images and enhances detail in dark scenes  <b>C2:</b> Sharpens images and enhances detail in dark scenes  <b>U1/U2/U3:</b> User mode (→ below)</p>
(b)	<p><b>Video output mode</b>  <b>480I:</b> Interlace video  <b>480P:</b> Progressive video                  • You can change the video output mode only when "Progressive Out (Component)" in the SETUP menu is set to "Enable" (→page 49)                  • When progressive output is on, closed captions will not be displayed.</p>
(c)	<p><b>Transfer mode</b>                  Select the method of conversion for progressive output to suit the type of material being played.  <b>Auto 1 (normal):</b> For viewing film material  <b>Auto 2:</b> For viewing film material (the same as Auto 1, but able to convert 30-frame-per-second progressive video)  <b>Video:</b> For video material</p>

**MPEG Digital Noise Reduction**

(d)	<p><b>3D-NR (0 to +4)/Dot NR (On)</b>                  Reduces overall noise/Reduces the dot noise that occurs at the borders between colors.                  • When the contours on the video get blurred, reduce the level.</p>
(e)	<p><b>Block NR (0 to +3)</b>                  Smoothes block noise.                  • When the contours on the video get blurred, reduce the level.</p>
(f)	<p><b>Mosquito NR (0 to +3)</b>                  Reduces the smudging that appears around contrasting sections of the picture.                  • When the contours on the video get blurred, reduce the level.</p>

**Picture Control**

(g)	<p><b>Contrast (-7 to +7)</b>                  Increases the contrast between light and dark parts of the picture.</p>
(h)	<p><b>Brightness (0 to +15)</b>                  Brightens the picture.</p>
(i)	<p><b>Color (-7 to +7)</b>                  Adjust the shade of the picture's color.</p>

When progressive output is on:

Define your favorite picture quality.

- 1) Select the Picture mode "U" with [Cursor]▲▼.
- 2) Press [Cursor]▶ to highlight the number.
- 3) Press [Cursor]▲▼ to select "1", "2" or "3".



**About the material (video information) of DVD video**

In general, there are two styles as follows:  
 This unit determines which of the styles is used for the video information recorded on the DVD and converts it into progressive output in the optimum manner.

• **Film material**

Film images are recorded in 24 frames/second. (Images in conventional movie films are recorded in 24 frames/second.)

• **Video material**

Video information is recorded in 30 frames/second.





# Changing settings

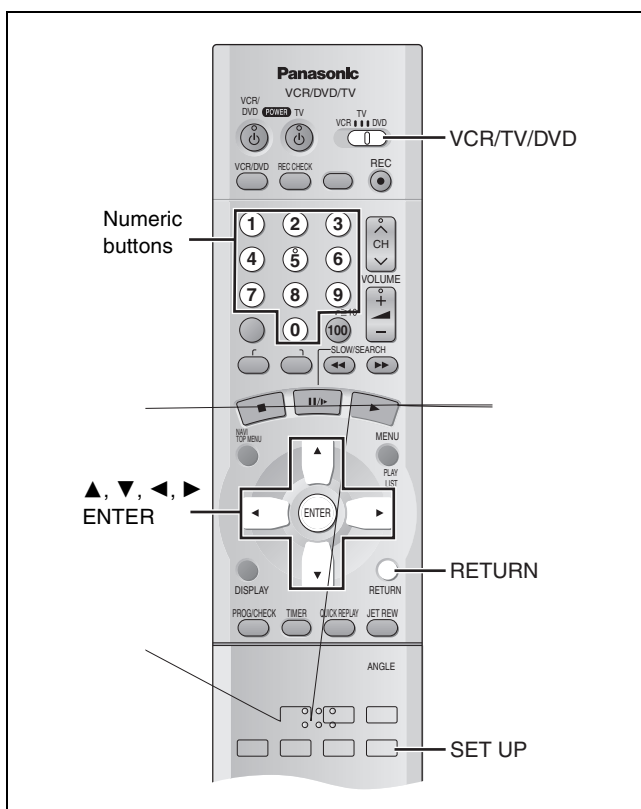

Change the settings to suit your preferences and to suit the unit to the environment in which it is being used. These settings are retained in memory until they are changed, even if the unit is turned off.

- See the right page for menu and option details.

## Common procedures

### Preparations

- Turn on the TV and select the video input for this unit.
- Switch [VCR/TV/DVD] to "DVD".

- 1 Press [SET UP] to show the menus.
- 2 Press [Cursor] ◀ ▶ to select the menu's tab.

### On Screen Display

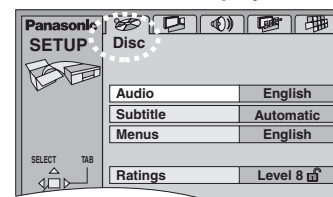

The screen changes to display the menu.

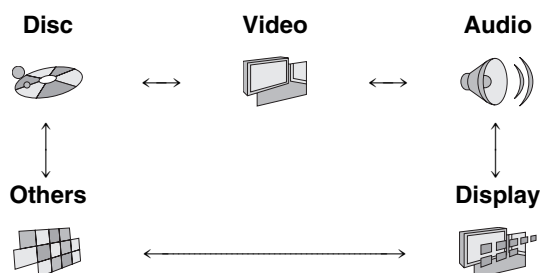

- 3 Press [Cursor] ▲ ▼ to select the item you want to change and press [ENTER].
- 4 Press [Cursor] ▲ ▼ to select the option and press [ENTER].

The screen now shows the menu again.

### To return to the previous screen

Press [RETURN].

### To exit the SET UP screen

Press [SET UP].

### Notes:





- Screens different from those described here may appear. In this case, follow the instructions shown on the screen.

## Language code list

Abkhazian: ..... 6566	Chinese: .....9072	Hausa: .....7265	Lithuanian: .....7684	Romanian: ..... 8279	Telugu: ..... 8469
Afar: ..... 6565	Corsican: .....6779	Hebrew: .....7387	Macedonian: .....7775	Russian: ..... 8285	Thai: ..... 8472
Afrikaans: ..... 6570	Croatian: .....7282	Hindi: .....7273	Malagasy: .....7771	Samoan: ..... 8377	Tibetan: ..... 6679
Albanian: ..... 8381	Czech: .....6783	Hungarian: .....7285	Malay: .....7783	Sanskrit: ..... 8365	Tigrinya: ..... 8473
Ameharic: ..... 6577	Danish: .....6865	Icelandic: .....7383	Malayalam: .....7776	Scots Gaelic: .....7168	Tonga: ..... 8479
Arabic: ..... 6582	Dutch: .....7876	Indonesian: .....7378	Maltese: .....7784	Serbian: ..... 8382	Turkish: ..... 8482
Armenian: ..... 7289	English: .....6978	Interlingua: .....7365	Maori: .....7773	Serbo-Croatian: 8372	Turkmen: ..... 8475
Assamese: ..... 6583	Esperanto: .....6979	Irish: .....7165	Marathi: .....7782	Shona: ..... 8378	Twi: ..... 8487
Aymara: ..... 6588	Estonian: .....6984	Italian: .....7384	Moldavian: .....7779	Sindhi: ..... 8368	Ukrainian: ..... 8575
Azerbaijani: ..... 6590	Faroese: .....7079	Japanese: .....7465	Mongolian: .....7778	Singhalese: ..... 8373	Urdu: ..... 8582
Bashkir: ..... 6665	Fiji: .....7074	Javanese: .....7487	Nauru: .....7865	Slovak: ..... 8375	Uzbek: ..... 8590
Basque: ..... 6985	Finnish: .....7073	Kannada: .....7578	Nepali: .....7869	Slovenian: ..... 8376	Vietnamese: ..... 8673
Bengali; Bangla: 6678	French: .....7082	Kashmiri: .....7583	Norwegian: .....7879	Somali: ..... 8379	Volapük: ..... 8679
Bhutani: ..... 6890	Frisian: .....7089	Kazakh: .....7575	Oriya: .....7982	Spanish: ..... 6983	Welsh: ..... 6789
Bihari: ..... 6672	Galician: .....7176	Kirghiz: .....7589	Pashto, Pushto: 8083	Sundanese: ..... 8385	Wolof: ..... 8779
Breton: ..... 6682	Georgian: .....7565	Korean: .....7579	Persian: .....7065	Swahili: ..... 8387	Xhosa: ..... 8872
Bulgarian: ..... 6671	German: .....6869	Kurdish: .....7585	Polish: .....8076	Swedish: ..... 8386	Yiddish: ..... 7473
Burmese: ..... 7789	Greek: .....6976	Laotian: .....7679	Portuguese: .....8084	Tagalog: ..... 8476	Yoruba: ..... 8979
Byelorussian: ... 6669	Greenlandic: .....7576	Latin: .....7665	Punjabi: .....8065	Tajik: ..... 8471	Zulu: ..... 9085
Cambodian: ..... 7577	Guarani: .....7178	Latvian, Lettish: ..7686	Quechua: ..... 8185	Tamil: ..... 8465	
Catalan: ..... 6765	Gujarati: .....7185	Lingala: .....7678	Rhaeto-Romance:8277	Tatar: ..... 8484	

## SET UP menus

• Underlined items are the initial setting.

Menus	Items	Options
 <b>DVD-V</b>	<b>Audio</b> Choose the preferred audio language. If the selected language is not recorded on the disc or a language has been predetermined on the disc, the language most prioritized on the disc is used for playback.	<u>English</u> French    Spanish    Original    Other **** Original:    The original language of each disc will be selected. Other ****: Input a code number with the numeric buttons (→ page 48).
	<b>Subtitle</b> Choose the preferred subtitle language. If the selected language is not recorded on the disc or a language has been predetermined on the disc, the language most prioritized on the disc is used for playback.	<u>Automatic</u> English    French    Spanish    Other **** Automatic:    If the language selected for "Audio" is not available, subtitles of that language will automatically appear if available on that disc. Other ****: Input a code number with the numeric buttons (→ page 48).
	<b>Menus</b> Choose the preferred language for disc menus.	<u>English</u> French    Spanish    Other **** Other ****: Input a code number with the numeric buttons (→ page 48).
	<b>Ratings (→page 51)</b> Set a ratings level to limit DVD-Video play. • The password screen is shown if you choose levels 0 to 7 or if you choose "Ratings" when levels 0 to 7 have been selected. • Select "Level 0" to prevent play of discs that do not have ratings levels recorded on them.	<b>Setting ratings (When level 8 is selected)</b> <u>8 No Limit</u> : All DVD-Video can be played. 1 to 7:    Prohibits play of DVD-Video with corresponding ratings recorded on them. 0 Lock All: Prohibits play of all DVD-Video.  <b>Changing ratings (When level 0–7 is selected)</b> Unlock Player            Change Password Change Level             Temporary Unlock
 <b>DVD-V</b> <b>RAM</b> <b>VCD</b>	<b>TV Aspect (→page 50)</b> Choose the setting to suit your television and preference.	<u>4:3 Pan&amp;Scan</u> 4:3 Letterbox    16:9
	<b>Progressive Out (Component) (→page 33)</b> Choose "Enable" to enable progressive output.	<u>Disable</u> : For TVs not supporting progressive output. Enable
	<b>Still Mode</b> Specify the type of picture shown when paused.	<u>Automatic</u> Field:    Less blurred field stills are shown. Select if jittering occurs when "Automatic" is selected. Frame:    Sharper frame stills are shown. Select if small text or fine patterns cannot be seen clearly when "Automatic" is selected.
	<b>Black Level Control</b> Change the black level of the picture if you connected a television through the COMPONENT VIDEO OUT terminals.	<u>Lighter</u> : when connected to a TV through the VIDEO OUT or S-VIDEO OUT terminal. Darker: when connected to a TV through the COMPONENT VIDEO OUT (Y/P <sub>B</sub> /P <sub>R</sub> ) terminals.
 <b>DVD-V</b> <b>RAM</b> <b>VCD</b>	<b>Digital Audio Output (→page 51)</b>	<u>On</u> Off
	<b>PCM Down Conversion (→page 51)</b>	<u>No</u> Yes
	<b>Dolby Digital (→page 51)</b>	<u>Bitstream</u> PCM
	<b>DTS Digital Surround (→page 51)</b>	<u>PCM</u> Bitstream
	<b>Dynamic Range Compression (Dolby Digital only)</b> Change the dynamic range for late night viewing.	<u>Off</u> On: For clear dialog when listening at low volume.
	<b>Audio during Search</b> Choose whether to have sound during search.	<u>On</u> Off This feature doesn't work for some discs.
	<b>Menu Language</b> Choose the preferred language for these menus and the on-screen messages.	<u>English</u> Français                    Español
	<b>On-Screen Messages</b> Choose whether to show on-screen messages or not.	<u>On</u> Off
	<b>Demo</b> A demonstration of the unit's on-screen displays starts when you select "On". The demonstration stops when you press a button and the setting reverts to "Off".	<u>Off</u> On
	<b>QUICK SETUP (→page 50)</b> Answer questions to make basic settings.	Yes: (Menu language, Audio language, Subtitle language, TV aspect, Progressive out) <u>No</u>

(continues on the next page)

## Quick Setup

The QUICK SETUP screen assists you to make basic settings for DVD.

While SET UP menus are displayed (→page 48)

### On Screen Display

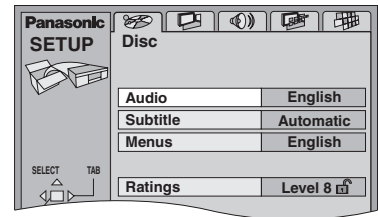

- 1 Press [Cursor]◀▶ to select “Others” tab.
- 2 Press [Cursor]▲▼ to select “QUICK SETUP” and then press [ENTER].
- 3 Press [Cursor]▲▼ to select “Yes” and press [ENTER].
- 4 Press [Cursor]▲▼ to select the item and press [ENTER].
  - Menu Language (→ page 49)
  - Audio Language (→ page 49)
  - Subtitle Language (→ page 49)
  - TV Aspect (→ below)
  - Progressive out (→ page 49)
- 5 Press [ENTER] and then [SETUP] settings.

To return to the previous screen  
Press [RETURN].

### TV Aspect

Choose the setting...  
If you have a region...  
on some discs...

- 4:3 Pan...
- Wide...
- S...

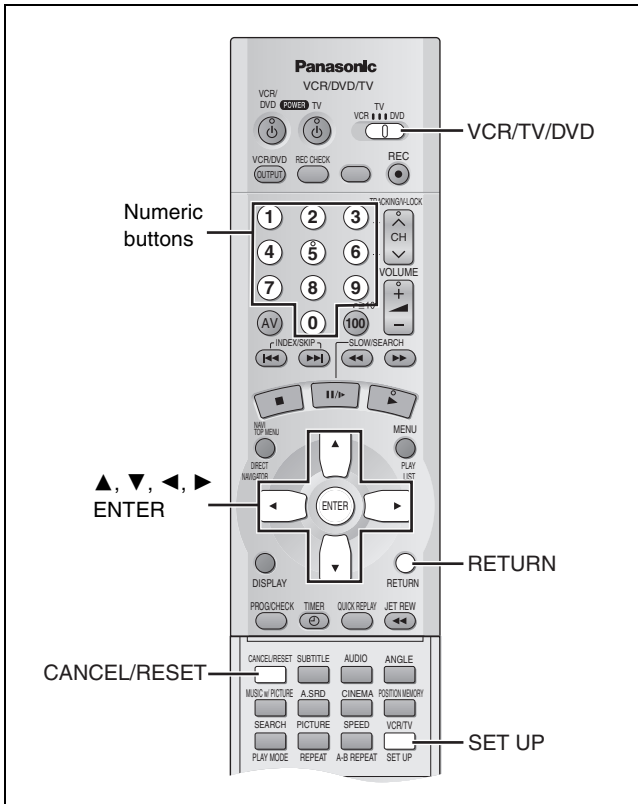

### Preparations

- Turn on the TV and select the video input for this unit.

## Entering a password (Ratings)

### DVD-V

While SET UP menus are displayed, select the "Disc" tab and then "Ratings" by following "Common procedures"

(→page 48, 49) to set a ratings level to limit DVD-Video play.

The password screen is shown when you select levels 0 to 7 (→page 49).

- 1) Input a 4-digit password with the numeric buttons and press [ENTER].
  - If you enter a wrong number, press [CANCEL/RESET] to erase it before you press [ENTER].
  - The lock symbol appears closed to show the rating is locked.
  - **Do not forget your password.**
- 2) Press [ENTER] to confirm the 4 digits.

Now, when you insert a DVD-Video that exceeds the ratings limit you set, a message appears on the television. Follow the on-screen instructions.

## Digital output

### DVD-V

Change the settings when you have connected equipment through this unit's OPTICAL DIGITAL AUDIO OUT terminal.

While SET UP menus are displayed, select the "Audio" tab and then "Digital Audio Output" by following "Common procedures" (→page 48, 49). Select "On" for "Digital Audio Output" to set up "PCM Down Conversion", "Dolby Digital" and "DTS Digital Surround".

### PCM Down Conversion

Select how to output audio with a sampling frequency of 96 kHz.

- Select "Yes" if the equipment you connect cannot process signals with a sampling frequency of 96 kHz.

**No** (Initial setting): Output as 96 kHz

**Yes:** Converted to 48 kHz

### Note:

- Signals are converted to either 48 kHz despite the above settings if the signals have a sampling frequency of over 96 kHz, or the disc has copy protection.

### Dolby Digital and DTS Digital Surround

**Bitstream** (Initial setting for Dolby Digital):

Select if the equipment you connected can decode the signal.

**PCM** (Initial setting for DTS Digital Surround):

Select if the equipment you connected cannot decode the signal.

### IMPORTANT

**If the equipment you connected cannot decode the signal, the setting must be changed to PCM. If not, signals the equipment cannot process will be output by this unit, causing high levels of noise which can damage your hearing and the speakers.**

# Editing

---

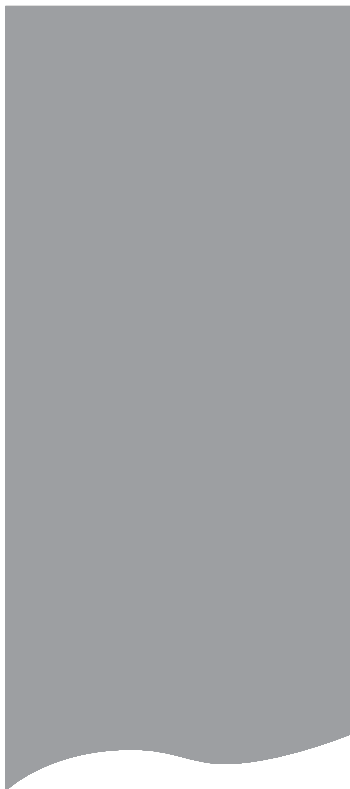

## Assemble Editing

This function can be used to make up an edited tape from other recordings or video sources.

A new scene can be added to the end of previous one.

### Preparations

- Connect a camera or another VCR to this unit as shown.
- Confirm that the TV is on and the unit viewing channel is selected.
- Switch [VCR/TV/DVD] to "VCR".
- Insert a recorded cassette tape with an intact erasure prevention tab.
- Select the audio source required by using [CH]▼▲ to set A1 or A2.

### Operations

- 1 Search for the end of the previous recording by pressing [▶](PLAY).
- 2 Press [II/▶].
- 3 Press [REC●] to switch this unit from the pause mode to the recording standby mode.
- 4 Start play on the other equipment.
- 5 Start the new recording by pressing [II/▶] again.

---

### To stop

Press [■].

### Note:

- The new sound will be recorded on both the normal and Hi-Fi sound tracks, only monaural sound recording is possible on the normal sound tracks.



# Error Messages

Before requesting service, check the following points once again.

## On Screen Display

### VCR

PLEASE PUT IN A VIDEO CASSETTE.	<ul style="list-style-type: none"> <li>● [REC●] (●REC/OTR) or [TIMER ⊖ ] ( ⊖ TIMER REC) has been pressed without a video cassette inserted. Insert a video cassette with an intact erasure prevention tab.</li> </ul>	20, 22
PLEASE STOP THE TAPE.	<ul style="list-style-type: none"> <li>● CHANNEL SET has been selected during playback. Stop the tape.</li> </ul>	29
PLEASE SET THE CLOCK.	<ul style="list-style-type: none"> <li>● [TIMER ⊖ ] ( ⊖ TIMER REC) or [PROG/CHECK] has been pressed when the clock is not set. Set the clock.</li> </ul>	28
PLEASE USE A CASSETTE WITH TAB.	<ul style="list-style-type: none"> <li>● [REC●] (●REC/OTR) or [TIMER ⊖ ] ( ⊖ TIMER REC) has been pressed without a video cassette with an intact erasure prevention tab. Use a video cassette with an intact erasure prevention tab.</li> </ul>	5
NO TIMER RECORDING HAS BEEN SET.	<ul style="list-style-type: none"> <li>● [TIMER ⊖ ] ( ⊖ TIMER REC) has been pressed with no timer programs. Set timer recording.</li> </ul>	22

### DVD

Cannot display group xx, picture xx	<ul style="list-style-type: none"> <li>● You are trying to display incompatible pictures.</li> </ul>	—
The progressive out is set to "Disable"	<ul style="list-style-type: none"> <li>● Go to "Video" in the SET UP menus, and select "Enable" in "Progressive Out (Component)".</li> </ul>	49

## Self-diagnostic Indications

This unit has a self-diagnosis and display function. If this unit detects trouble during installation or during use, the following indications automatically appear in the unit's display. Indications are in the form of a single English letter plus two numbers, such as [H01].

### VCR

H□□, F□□ (□□ stands for a number.)	<ul style="list-style-type: none"> <li>● An error has occurred. The number following "H" or "F" depends on the status of the unit. <b>Reset procedure:</b> Press [POWER ⊖ / I] to switch the unit to the standby mode and then back to ON. Alternatively, press [POWER ⊖ / I] to switch the unit to the standby mode, disconnect the AC power supply cord, and then reconnect it.</li> <li>● If the service numbers fail to clear, note the service number and contact a qualified service person.</li> </ul>	—
---------------------------------------	---	---

### DVD

U11	<ul style="list-style-type: none"> <li>● Disc is dirty. Wipe it clean.</li> </ul>	6
H□□, F□□ (□□ stands for a number.)	<ul style="list-style-type: none"> <li>● An error has occurred. The number following "H" or "F" depends on the status of the unit. <b>Reset procedure:</b> Press [POWER ⊖ / I] to switch the unit to the standby mode and then back to ON. Alternatively, press [POWER ⊖ / I] to switch the unit to the standby mode, disconnect the AC power supply cord, and then reconnect it.</li> <li>● If the service numbers fail to clear, note the service number and contact a qualified service person.</li> </ul>	—
No DISC	<ul style="list-style-type: none"> <li>● You haven't inserted a disc; insert one.</li> <li>● You haven't inserted the disc correctly; insert it correctly.</li> </ul>	— 32
No PLAY	<ul style="list-style-type: none"> <li>● You inserted a disc the unit cannot play.</li> <li>● You inserted a blank DVD-RAM.</li> <li>● A disc whose playback is restricted in the SET UP menus, "Disc" → "Ratings", is inserted. Change the "Ratings" setting.</li> </ul>	6 — 49
ERROR	<ul style="list-style-type: none"> <li>● Incorrect operation performed. Read the instructions and try again.</li> </ul>	—



# Before Requesting Service

Before requesting service, check the following points once again.

## General

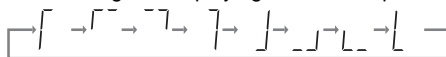
<b>No power.</b>	<ul style="list-style-type: none"> <li>● Insert the AC power supply cord and system cable securely.</li> </ul>	<b>12</b>
<b>No response when buttons pressed.</b>	<ul style="list-style-type: none"> <li>● Some operations may be prohibited by the disc.</li> <li>● The unit may not be operating properly due to lightning, static electricity or some other external factor.</li> </ul> <p><b>Reset procedure:</b> Press <b>[POWER ⏻/I] (VCR/DVD ⏻)</b> to switch the unit to the standby mode and then back to ON.</p> <p>Alternatively, press <b>[POWER ⏻/I] (VCR/DVD ⏻)</b> to switch the unit to the standby mode, disconnect the AC power supply cord, and wait for 1 minute. Reconnect the AC power supply cord.</p> <ul style="list-style-type: none"> <li>● Check the batteries are installed correctly.</li> <li>● The batteries are depleted: Replace them with new ones.</li> <li>● Point the remote control at the remote control sensor and operate.</li> </ul>	— — — <b>11</b> <b>11</b> <b>11</b>
<b>Cannot select alternative languages.</b>	<ul style="list-style-type: none"> <li>● This function depends on software availability.</li> <li>● Try selecting from the disc's menu if one is available.</li> </ul>	— <b>32</b>
<b>The SETUP menu cannot be accessed.</b>	<ul style="list-style-type: none"> <li>● Switch <b>[VCR/TV/DVD]</b> to [DVD] .</li> <li>● Cancel all program and random play.</li> </ul>	— <b>36</b>
<b>Cannot operate the VCR.</b>	<ul style="list-style-type: none"> <li>● Switch <b>[VCR/TV/DVD]</b> to [VCR] when operating VCR.</li> <li>● The unit is in timer recording standby ("⏻" is on on the unit's display). Press <b>[TIMER ⏻]</b> to operate the VCR manually.</li> </ul>	— <b>22</b>
<b>Cannot operate the TV.</b>	<ul style="list-style-type: none"> <li>● Switch <b>[VCR/TV/DVD]</b> to [TV] when operating TV.</li> </ul>	—
<b>Cannot operate the DVD.</b>	<ul style="list-style-type: none"> <li>● Switch <b>[VCR/TV/DVD]</b> to [DVD] when operating DVD.</li> </ul>	—
<b>Television reception worsens after connecting the unit.</b>	<ul style="list-style-type: none"> <li>● This can occur because the signals are being divided between the unit and the television. It can be solved by using a signal booster, available from audio-visual suppliers. Consult your dealer if reception does not improve.</li> </ul>	—
<b>Cannot eject cassette.</b>	<ul style="list-style-type: none"> <li>● The unit is in timer recording standby or actually recording. If you need to eject the tape, press <b>[TIMER ⏻]</b> first so "⏻" goes out.</li> </ul>	<b>22</b>
<b>No on-screen display.</b>	<ul style="list-style-type: none"> <li>● Go to "OPTION" in the VCR MENU, and select "ON" for "OSD".</li> <li>● Go to "Display" in the SETUP menus, and select "On" for "On-Screen Messages".</li> </ul>	<b>30</b> <b>49</b>
<b>The menu is displayed in a different language.</b>	<ul style="list-style-type: none"> <li>● Go to "LANGUAGE" in the VCR MENU, and select the desired language for menus.</li> <li>● Go to "Disc" in the SETUP menus, and select the preferred language for "Menus".</li> </ul>	<b>28</b> <b>49</b>
<b>The tape counter isn't changing.</b>	<ul style="list-style-type: none"> <li>● The tape counter does not change while playing unrecorded parts.</li> </ul>  <ul style="list-style-type: none"> <li>● The display also appears like this if the tape is dirty or damaged. Consult your dealer if this is the case.</li> </ul>	— —
<b>On-Screen Menu Icons not displayed or only partially displayed on the television.</b>	<ul style="list-style-type: none"> <li>● Press <b>[Cursor]▲▼</b> while the rightmost icon is highlighted to move them down.</li> </ul>	<b>43</b>

## Sound

<b>No sound.</b>	<ul style="list-style-type: none"> <li>● Check the connections.</li> </ul>	<b>12</b>
<b>Distorted sound.</b>	<ul style="list-style-type: none"> <li>● Turn the volume up.</li> <li>● Ensure that the input settings on the other equipment are correct.</li> <li>● Turn ADVANCED SURROUND off if it causes distortion.</li> <li>● Output from this unit will be in stereo (2 channels) when ADVANCED SURROUND is on. Turn ADVANCED SURROUND off if you are using three or more speakers.</li> <li>● Noise may occur when playing WMA files.</li> </ul>	— — <b>41</b> <b>41</b>
<b>Piercing noise comes from the speakers.</b>	<ul style="list-style-type: none"> <li>● If you have connected this unit to other equipment through the DIGITAL AUDIO OUT terminal, ensure you have selected the correct settings for "Dolby Digital" and "DTS Digital Surround" in the SET UP menu's "Audio" menu.</li> </ul>	<b>47, 51</b>
<b>There is noise when playing a video tape.</b>	<ul style="list-style-type: none"> <li>● Adjust the tracking.</li> <li>● The tape is old or damaged.</li> </ul>	<b>19</b> —
<b>Effects do not work.</b>	<ul style="list-style-type: none"> <li>● DIALOGUE ENHANCER and ADVANCED SURROUND do not work when the unit is outputting bitstream signals.</li> </ul>	—

Picture

No picture.	<ul style="list-style-type: none"> <li>• Check the connection.</li> <li>• Make sure the television is on.</li> <li>• Ensure the television's video input setting is correct.</li> </ul> <p><b>When the audio/video cable is connected,</b> Ensure the input is switched on the TV. (e.g. Video 1)</p> <p><b>When the audio/video cable is not connected,</b> Ensure the video exclusive channel (e.g. Channel 3 or Channel 4) is selected. Also adjust Channel 3 or Channel 4 on the TV. (Also refer to the instructions for the TV.)</p>	12 — —
The picture shown on the television is not normal. (The sides of the picture are cut off, the picture is stretched horizontally, or black bands appear at the top and bottom of the screen.)	<ul style="list-style-type: none"> <li>• Go to "Video" in the SETUP menus, and change "TV Aspect" to suit your television.</li> <li>• Use the television to change the aspect to the correct one.</li> </ul> <p><b>If your television cannot change the aspect when input is progressive,</b> try changing "4:3 Aspect" with the on-screen menu icons.</p> <ul style="list-style-type: none"> <li>• Ensure that the unit is connected directly to the television, and is not connected through an A/V selector or other equipment.</li> <li>• Connect to the component video input terminals on a 480P compatible television. (Video will not be displayed correctly if connected to an incompatible television.)</li> <li>• Change the size with the variable zoom function.</li> </ul>	49 45 — 13 42
The picture on the television disappears or stripes appear on the screen.	<ul style="list-style-type: none"> <li>• Mobile telephone chargers can cause some disturbance.</li> <li>• The television antenna cable is too close to the unit. Separate the antenna cable of the television from the unit.</li> </ul>	— —

VCR picture

The picture is noisy or is in black and white. Horizontal bars or lines run down the screen.	<ul style="list-style-type: none"> <li>• Adjust the tracking.</li> <li>• The TV has not been tuned to the unit. Tune the TV to the unit.</li> <li>• Make sure the television's input setting is correct.</li> <li>• The video heads are dirty: clean them with a head-cleaning cassette.</li> <li>• The video heads are worn: consult your dealer.</li> <li>• The tape is old or damaged.</li> <li>• You cannot correctly play tapes recorded with other systems (e.g., PAL).</li> </ul>	19 15 — 5 — — —
Picture is distorted when stilled or during slow-motion.	<ul style="list-style-type: none"> <li>• Some distortion is normal with tapes recorded using VP mode.</li> </ul>	—
The blue back appears during play.	<ul style="list-style-type: none"> <li>• You are playing a blank or poor quality part of the tape.</li> <li>• You can damage the unit if you play dirty or damaged tapes and this can cause the blue back to appear. Consult your dealer.</li> </ul>	— —
The picture jiggles.	<ul style="list-style-type: none"> <li>• Adjust the vertical hold.</li> <li>• Adjust the television's vertical hold. Refer to your television's operating instructions.</li> </ul>	19 —
The blue background does not appear.	<ul style="list-style-type: none"> <li>• Go to "OPTION" in the VCR MENU, and select "ON" for "BLUE BACK".</li> </ul>	30

Disc picture

Picture distorted.	<ul style="list-style-type: none"> <li>• Some distortion is normal during SEARCH.</li> </ul>	—
There is ghosting when progressive output is on.	<ul style="list-style-type: none"> <li>• Press <b>[PROGRESSIVE OUT]</b> to turn off progressive output. This problem is caused by the editing method or material used on DVD-Video, but should be corrected if you use interlace output.</li> </ul>	33
Picture quality is poor.	<ul style="list-style-type: none"> <li>• Check the settings in the On-Screen Menu Icons' "Picture Menu".</li> </ul>	46
Menus not displayed correctly.	<ul style="list-style-type: none"> <li>• Change the zoom ratio to "×1.00".</li> <li>• Set the subtitle position to 0.</li> <li>• With the on-screen menu icon, change "4:3 Aspect" to "Normal".</li> </ul>	42 40 45
Screen size is wrong.	<ul style="list-style-type: none"> <li>• Check the settings on your television.</li> <li>• Check the settings for "4:3 Aspect" in the on-screen menu icon, "TV Aspect" in the SET UP menus.</li> </ul>	— 45, 49
There is ghosting.	<ul style="list-style-type: none"> <li>• Change the settings for "3D NR", "Block NR", and "Mosquito NR" to "0".</li> </ul>	46

Recording

The picture is recorded with noise or a blank screen.	<ul style="list-style-type: none"> <li>• The antenna or antenna cable is defective. Check the antenna connection to the unit. Check your normal TV picture. If there is no picture, check your antenna.</li> <li>• The unit is not correctly tuned. Retune the unit.</li> <li>• A1 or A2 has been selected. Select the required TV program.</li> </ul>	12 — 16 —
Timer recording doesn't record a program correctly.	<ul style="list-style-type: none"> <li>• Check the clock and calendar. (Note that this is a 12-hour clock.)</li> <li>• Set the channel and start and end times correctly.</li> <li>• Be sure to press <b>[TIMER ⏸]</b> after programming to put the unit in timer recording standby.</li> <li>• Program times may be overlapped.</li> </ul>	28 22 22 —
"  " flashes when I try to start recording. Cannot record.	<ul style="list-style-type: none"> <li>• If the erasure prevention tab has been removed, cover the hole with adhesive tape.</li> </ul>	5, 20

**Disc play**

<b>Play doesn't start (or stops immediately) when you press [▶] (PLAY).</b>	<ul style="list-style-type: none"> <li>• Condensation has formed: Wait 1 to 2 hours for it to evaporate.</li> <li>• This unit cannot play discs other than the ones listed in these operating instructions.</li> <li>• This unit cannot play DVD-Video with a region number other than "1", "ALL" or multiple region numbers including "1".</li> <li>• The disc may be dirty and may require cleaning.</li> <li>• Ensure that the disc is installed with the label of the side to be played facing upwards.</li> <li>• Check that the DVD-RAM has something recorded on it.</li> </ul>	— 6 6 6 32 —
<b>No menu play.</b>	<ul style="list-style-type: none"> <li>• This function depends on software availability.</li> </ul>	—
<b>No subtitles.</b>	<ul style="list-style-type: none"> <li>• This function depends on software availability.</li> <li>• Subtitles are cleared from the television. Display the subtitles.</li> <li>• Subtitles position is wrong. Adjust the position.</li> </ul>	— 40 40
<b>The position of the subtitles is incorrect.</b>	<ul style="list-style-type: none"> <li>• Change the position of the subtitles with "Subtitle Position" in the on-screen menu icon.</li> </ul>	40
<b>Soundtrack and/or subtitle language is not the one selected with the SETUP menus.</b>	<ul style="list-style-type: none"> <li>• This function depends on software availability.</li> </ul>	—
<b>Cannot change angle.</b>	<ul style="list-style-type: none"> <li>• This function depends on software availability. Even if a disc has a number of angles recorded, these angles may be recorded for specific scenes only.</li> </ul>	—
<b>Cannot add markers.</b>	<ul style="list-style-type: none"> <li>• You cannot add markers while playing a play list or if the disc's play time doesn't appear on the unit's display.</li> </ul>	—
<b>There are already markers on a disc. <b>RAM</b></b>	<ul style="list-style-type: none"> <li>• The unit reads and displays the markers added with a DVD recorder. You can clear them but reappear when you switch the unit to standby, change the source, or open the disc tray.</li> </ul>	45
<b>Marker numbers I added are different when I call them up. <b>RAM</b></b>	<ul style="list-style-type: none"> <li>• The unit numbers markers by time so they change when you add and delete them.</li> </ul>	45
<b>Cannot select random or program play.</b>	<ul style="list-style-type: none"> <li>• You cannot select random or program play with some DVD-Video.</li> </ul>	—
<b>Folders deeper than the eighth layer on a data CD are not displayed correctly.</b>	<ul style="list-style-type: none"> <li>• Folders deeper than the eighth layer are displayed as the eighth layer.</li> </ul>	—
<b>You have forgotten your ratings password. Reset all the settings to Factory Preset.</b>	<ul style="list-style-type: none"> <li>• While stopped and "DVD" is the source, press and hold [REW◀◀] (VCR), [PLAY▶] (DVD) and [▲DVD OPEN/CLOSE] on the unit for about 3 seconds until "Initialized" disappears from the television. Turn the unit off and on again. All settings will return to the default values.</li> </ul>	—
<b>The progressive out indicator does not light.</b>	<ul style="list-style-type: none"> <li>• Go to "Video" in the SET UP menus, and select "Enable" in "Progressive Out (Component)".</li> </ul>	49

**Editing**

<b>Black bands appear in the recording.</b>	<ul style="list-style-type: none"> <li>• Move the other equipment away from the television as it may be picking up interference.</li> </ul>	—
<b>Recording video or audio from external equipment is not possible.</b>	<ul style="list-style-type: none"> <li>• The connections were done incorrectly. Check the connections to the other equipment.</li> <li>• The external input channel "A1" or "A2", to which the player is connected is not selected. Press [CH]▼▲ to select "A1" or "A2".</li> </ul>	52 52
<b>A video was dubbed, but the video is distorted or the colors are abnormal.</b>	<ul style="list-style-type: none"> <li>• Copy-protected material was dubbed. Copy-protected materials cannot be recorded normally. Most commercially available videotapes and DVD discs (including rental soft tapes/DVDs) are copy-protected so that illegal dubbing is impossible.</li> </ul>	—
<b>The audio level on the DVD section is not corresponding to that on the VCR after editing.</b>	<ul style="list-style-type: none"> <li>• Some discs may reproduce different audio levels. If the audio in particular parts, such as speech, is set to a low or high level, it may be recorded on a video cassette at a high or low level, respectively.</li> </ul>	—



Most video are produced with the intention that they be viewed on a widescreen television with an aspect ratio of 16:9. However, as you can view most material with the intended aspect ratio on a widescreen television. Material with this ratio will not fit onto a standard television with an aspect ratio of 4:3. Two styles of picture, "Pan&Scan" and "Letterbox", deal with this problem.

#### **Pan&Scan**

The sides are cut off so the picture fills the screen.

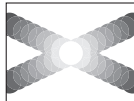

#### **Letterbox**

A black belt appears on top and bottom of the screen to present 16:9 aspect ratio video on the 4:3 aspect ratio screen.



#### **Playback control (PBC)**

On a Video CD has playback control, you can select scenes and information with menus.

In this manual, playing back of the contents of a Video CD using the menu screen is referred to as "Menu play" for Video CD.

#### **Sampling frequency**

This is the number of samples of sound taken per second during conversion to a digital signal. A high sampling frequency results in sound close to the original when played back.

#### **WMA (Windows Media Audio)**

One of compression formats developed by Microsoft Corporation. It achieves the same sound quality as MP3 with a file size that is smaller than that of MP3.

# Q&A

## Connection

### I have a TV equipped with both the S-video input and the component video inputs. Which one should be used?

- To view only the video on the DVD section, it is recommended to connect to the component video inputs. (→page 13)

The component video inputs allow the signals on a DVD to be output as they were recorded and reproduce colors with higher fidelity than using the S-video input terminal.

However, this connection does not output the video on the VCR.

To view the video on the VCR, connect the OUT1 (VCR/DVD) terminal to the video input terminal on the TV.

### I would like to enjoy Dolby Digital or 5.1-ch surround audio of DTS. What equipment is necessary?

- To enjoy the 5.1-ch surround audio, use an AV amplifier with a built-in decoder (with 5.1-ch audio input terminals) and 6 speakers.

## Video Cassette

### Can I use an S-VHS cassette to record and play?

- Yes, you can. However, the unit only records VHS, even on an S-VHS cassette. (→page 20)  
Cassettes recorded in S-VHS mode can be played back, but the S-VHS's original picture quality is not reproduced.

## VCR playback

### Can cassettes recorded overseas be played back?

Yes, if they were recorded in NTSC format in the SP, LP or EP mode.

### Can cassettes recorded in the VP mode of this unit be played back on other VCRs?

- No.  
Play back cassettes recorded in the VP mode on this unit.

## Recording

### Is it possible to only listen to the left-channel audio or right-channel audio for stereophonic broadcasting (only the main audio channel or sub audio channel for bilingual broadcasting) while recording?

- Yes, it is possible.  
Select the desired channel with [AUDIO]. (→page 31)

### Is it possible to record only the left-channel audio or right-channel audio for stereophonic broadcasting (only the main audio channel or sub audio channel for bilingual broadcasting)?

- No. It is not possible.  
Select the desired channel with [AUDIO] when playing back.

## Timer recording

### Is it possible to view programs on another cassette when the timer recording is set?

### Or is it possible to replace the cassette?

- It is possible when you cancel the timer recording set.

Press [TIMER ⏸] to turn off the indication "⏸" in the unit's display, then proceed with the operation. (→page 22)

### Is it necessary to turn on the TV?

- If only the timer recording is being set on this unit, it is not necessary to turn on the TV.

## Disc playback

### Can DVDs bought overseas be played back?

- If the DVDs have the region number, "ALL" or "1" and are recorded in NTSC format, they can be played back.  
Check this on the jacket of the DVDs.

### Can Video CDs bought overseas be played back?

- If the Video CDs are recorded in NTSC format, they can be played back.

### Can discs having no region number be played back?

- The DVD region number means that the DVD conforms to the Standards. Any DVDs not conforming to the Standards cannot be played back.

## VCR/DVD output switching

### Immediately after the unit is turned on, the output is sometimes switched to DVD automatically. Why?

- Some discs may automatically start to be played back when the unit is turned on when such a disc is inserted.  
If "OUT1 [VCR/DVD]" in the VCR MENU "OPTION" is set to "AUTO", the DVD video output is automatically selected when the disc starts to be played back. If you do not wish to automatically switch to the DVD in such cases, select "MANUAL" for "OUT1 [VCR/DVD]" in the VCR MENU "OPTION". (→page 30)  
If it is set to "AUTO", the DVD is not switched to when a unit with no disc is turned on.

# Specifications

AG-VP300P

<b>Power Supply:</b>	AC 120 V, 60 Hz
<b>Power Consumption:</b>	24 W
<b>Power Consumption When in Standby Mode:</b>	2.4 W

## ■ VCR SECTION

### Video Recording System:

2 rotary heads, helical scanning system

### Video Heads:

4 heads

### Tape Speed:

SP; 33.3 mm/s EP; 11.1 mm/s

### Tape Format:

VHS tape

### Record/Playback Time:

SP; 210 min with NV-T210

EP; 630 min with NV-T210

### FF/REW Time:

Approx. 54 s with NV-T120 (FF/REW)

Approx. 43 s with NV-T120 (JET REW)

## VIDEO

### Television System:

EIA; Standard (525 lines, 60 fields),

NTSC color signal

### Modulation System:

Luminance; FM azimuth recording

Color signal; converted subcarrier phase shift recording

### Input Level:

VIDEO IN (PHONO); 1.0 Vp-p, 75 ohm

### Output Level:

VIDEO OUT (PHONO); 1.0 Vp-p, 75 ohm

RF modulated; VHF channel 3 or 4, 75 ohm, terminated

### Antenna Reception Input:

VHF; 2 ch–13 ch, 75 ohm

UHF; 14 ch–69 ch, 75 ohm

CATV Channel; 5A and A-5 ch–EEE ch, 75 ohm

## AUDIO

### Input Level:

AUDIO IN (PHONO); 309 mVrms, 47 kohm

### Output Level:

AUDIO OUT (PHONO); 400 mVrms, 1 kohm

### Audio Track:

1 track (normal-mono only),

2 channels (Hi-Fi sound-stereo)

### Video Horizontal Resolution:

Color; more than 200 lines

### Signal-to-Noise Ratio:

Video; more than 40 dB/SP

Audio; more than 60 dB/Hi-Fi

### Dynamic Range:

Audio; more than 90 dB (Hi-Fi audio track)

### Audio Frequency Response:

20 Hz–20 kHz/Hi-Fi

### Wow and Flutter:

0.005% Wrms/Hi-Fi

## ■ DISC SECTION

### Playable Discs [8 cm (3") or 12 cm (5")]:

DVD-Video, DVD-RAM (DVD-VR compatible),  
DVD-R (DVD-Video compatible), CD audio (CD-DA), Video CD,  
CD-R/RW (CD-DA, Video CD, MP3, WMA formatted discs)  
(MP3/WMA: Maximum number of tracks and groups  
recognizable; 999 tracks and 99 groups, Compatible  
compression rate; between 32 kbps and 320 kbps/MP3,  
between 48 kbps and 192 kbps/WMA)

## VIDEO

**Signal System:** NTSC

### Output Level:

Composite video: 1.0 Vp-p, 75 ohm

S-VIDEO OUT: Y output level; 1.0 Vp-p, 75 ohm

C output level; 0.286 Vp-p, 75 ohm

COMPONENT VIDEO OUT(480P/480I);

Y output level; 1.0 Vp-p, 75 ohm

P<sub>B</sub>/C<sub>B</sub> output level; 0.7 Vp-p, 75 ohm

P<sub>R</sub>/C<sub>R</sub> output level; 0.7 Vp-p, 75 ohm

## AUDIO

### Output Level:

AUDIO OUT (PHONO); 2 Vrms, (1 kHz, 0 dB)

### Audio Performance:

#### ●Frequency response:

DVD (linear audio): 4 Hz–22 kHz (48 kHz sampling)

4 Hz–44 kHz (96 kHz sampling)

CD audio: 4 Hz–20 kHz

#### ●Signal-to-Noise ratio:

CD audio: 115 dB (OUT2/DVD ONLY)

#### ●Dynamic range:

DVD (linear audio): 98 dB

CD audio: 96 dB (OUT2/DVD ONLY)

#### ●Total harmonic distortion:

CD audio: 0.004 % (OUT2/DVD ONLY)

### Digital Audio Out:

Optical digital output: Optical terminal

### Pickup:

**Wave Length:** 658 nm/790 nm

**Laser Power:** CLASS II/CLASS I

## ■ GENERAL

**Operating Temperature:** 5 °C–35 °C (41 °F–95 °F)

**Operating Humidity:** 35 %–80 %

**Weight:** 4.0 kg (8.8 lbs.)

**Dimensions:** 430 (W)×89 (H)×266 (D) mm

[16<sup>15</sup>/<sub>16</sub>" (W)×3<sup>9</sup>/<sub>16</sub>" (H)×10<sup>1</sup>/<sub>2</sub>" (D)]

### Note:

Weight and dimensions shown are approximate.  
Specifications are subject to change without notice.



A series of horizontal lines, likely a list or a form structure.

# Index

- **A**
  - A-B repeat ..... 35, 45
  - Advanced Surround ..... 41
  - Angle ..... 40, 44
  - Antenna system ..... 29
  - Assemble editing ..... 52
  - Audio ..... 31
  - Audio attribute ..... 44
  - Auto Bilingual Choice ..... 31
  - Auto SP/EP Change ..... 23
- **B**
  - Battery ..... 11
  - Block NR ..... 46
  - Brightness ..... 46
- **C**
  - Category ..... 25
  - CATV ..... 14
  - CD text ..... 38
  - Channel Set ..... 29
  - Chapter Preview ..... 33
  - Checking a Timer Program ..... 23
  - CINEMA ..... 41
  - Cleaning ..... 5, 6
  - Clock ..... 28
  - Common output ..... 17
  - Connection ..... 12, 47
  - Contrast ..... 46
  - Cue ..... 17
- **D**
  - Dialogue Enhancer ..... 41, 45
  - Direct Navigator ..... 37
  - Dolby Digital ..... 51
  - DTS Digital Surround ..... 51
- **E**
  - EP ..... 20
  - Erasure protection ..... 5
- **F**
  - Fast-forward ..... 17
- **I**
  - Intro-Jet Scan ..... 27
- **J**
  - Jet Navigator ..... 24
  - Jet Rewind ..... 17
  - Jet Search ..... 18
- **L**
  - Language ..... 28, 44, 48, 49
- **M**
  - Manual Tuning ..... 29
  - Marker ..... 45
  - Mosquito NR ..... 46
  - MPEG-DNR ..... 46
  - MP3 ..... 32, 38
  - MUSIC WITH PICTURE ..... 53
- **O**
  - Onscreen display ..... 28, 31
  - On-Screen Menu Icon ..... 43
  - Option ..... 30
  - OTR ..... 21
- **P**
  - PCM Down Conversion ..... 51
  - Picture ..... 19, 46
  - Play list ..... 37
  - Playback Off Timer ..... 18
  - Plug in Auto Tuning ..... 15
  - Position Memory function ..... 33
  - Program play ..... 36
  - Progressive ..... 13, 33, 49
- **Q**
  - Quick Replay ..... 35
  - Quick Setup ..... 50
- **R**
  - Random play ..... 36
  - Ratings ..... 51
  - Record check ..... 21
  - Recording ..... 20
  - Remaining tape time ..... 20
  - Repeat ..... 18, 35
  - Resume function ..... 33
  - Review ..... 17
  - Rewind ..... 17
- **S**
  - SAP ..... 31
  - Search ..... 35
  - SET UP menu ..... 49
  - Skip ..... 34
  - Slow ..... 17, 35
  - Soundtrack ..... 40, 44
  - SP ..... 20
  - SQPB ..... 17
  - Still picture ..... 17, 35
  - Stop ..... 17, 33
  - Subtitle ..... 40, 44
- **T**
  - Tape length ..... 30
  - Tape Refresh ..... 27
  - Tape speed ..... 20
  - Time Stamp ..... 26
  - Timer Recording ..... 22
  - Tracking ..... 19
  - Transfer ..... 46
  - TV Aspect ..... 49
- **V**
  - Vertical Lock ..... 19
  - VISS ..... 26
  - VP ..... 20
- **W**
  - WMA ..... 32, 38
- **Z**
  - Zoom ..... 42
- **Numerics**
  - 3D-NR ..... 46

---

# Panasonic

## **PANASONIC BROADCAST & TELEVISION SYSTEMS COMPANY**

UNIT COMPANY OF MATSUSHITA ELECTRIC CORPORATION OF AMERICA

### **Executive Office:**

One Panasonic Way 4E-7, Secaucus, NJ 07094 (201) 348-7000

### **EASTERN ZONE:**

One Panasonic Way 4E-7, Secaucus, NJ 07094 (201) 348-7621

#### **Southeast Region:**

1225 Northbrook Parkway, Ste 1-160, Suwanee, GA 30024 (770) 338-6835

#### **Central Region:**

1707 N Randall Road E1-C-1, Elgin, IL 60123 (847) 468-5200

### **WESTERN ZONE:**

3330 Cahuenga Blvd W., Los Angeles, CA 90068 (323) 436-3500

### **Government Marketing Department:**

52 West Gude Drive, Rockville, MD 20850 (301) 738-3840

### **Broadcast PARTS INFORMATION & ORDERING:**

9:00 a.m.–5:00 p.m. (EST) (800) 334-4881/24 Hr. Fax (800) 334-4880

Emergency after hour parts orders (800) 334-4881

### **TECHNICAL SUPPORT:**

Emergency 24 Hour Service (800) 222-0741

### **Panasonic de Mexico S.A. de C.V.**

Av angel Urreaza Num. 1209 Col. de Valle 03100 Mexico, D.F. (52) 1 951 2127

### **Panasonic Sales Company**

#### **Division of Matsushita Electric of Puerto Rico Inc.**

San Gabriel Industrial Park, 65th Infantry Ave., Km. 9.5, Carolina, Puerto Rico 00630 (787) 750-4300

## Free Manuals Download Website

<http://myh66.com>

<http://usermanuals.us>

<http://www.somanuals.com>

<http://www.4manuals.cc>

<http://www.manual-lib.com>

<http://www.404manual.com>

<http://www.luxmanual.com>

<http://aubethermostatmanual.com>

Golf course search by state

<http://golfingnear.com>

Email search by domain

<http://emailbydomain.com>

Auto manuals search

<http://auto.somanuals.com>

TV manuals search

<http://tv.somanuals.com>