

# Panasonic

**DVC PRO**

Digital Video Cassette Player

**AJ-D440P**

Digital Video Cassette Recorder

**AJ-D450P**

## Operating Instructions

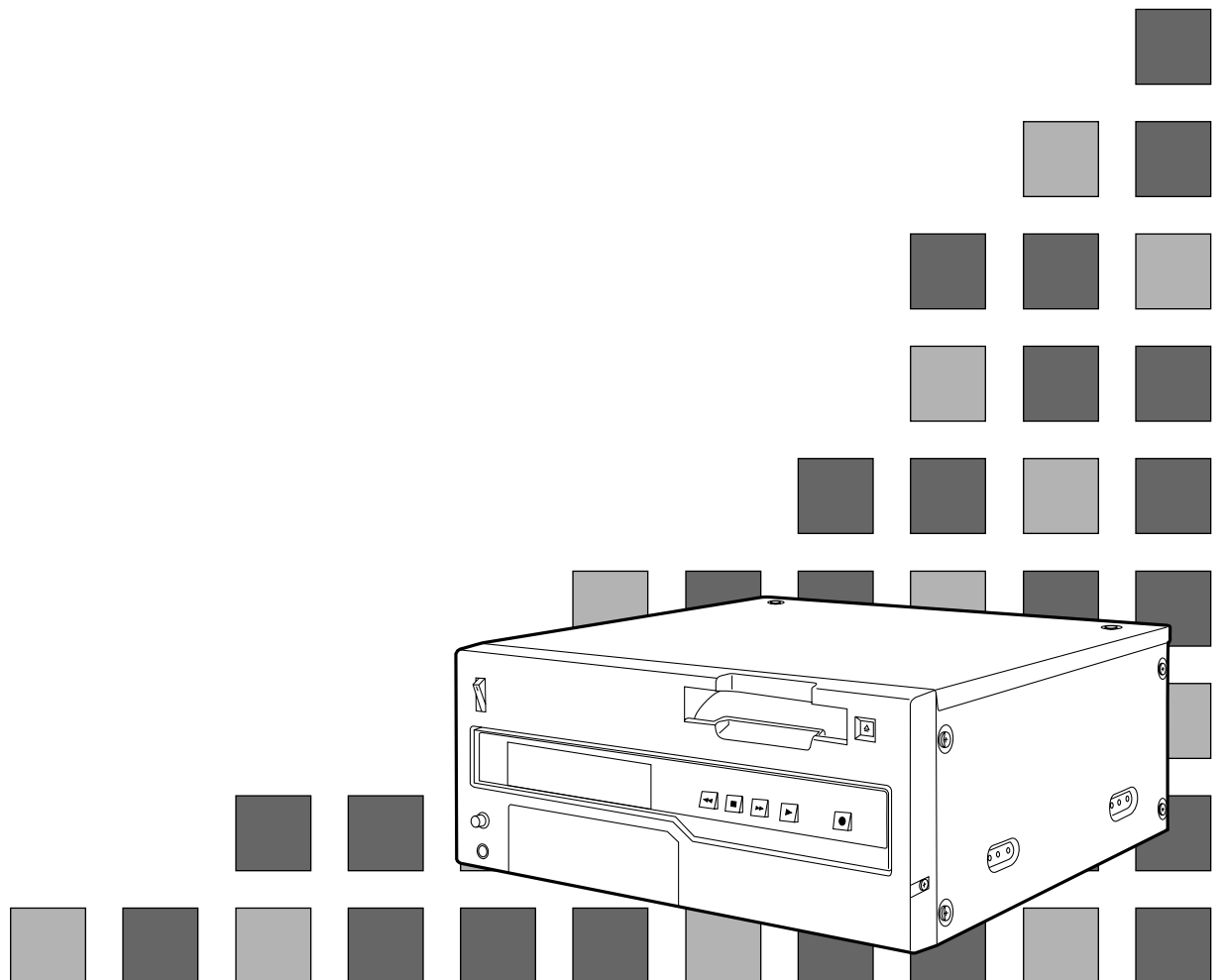

(The above illustration is AJ-D450)

## IMPORTANT

“Unauthorized recording of copyrighted television programs, video tapes and other materials may infringe the right of copyright owners and be contrary to copyright laws.”

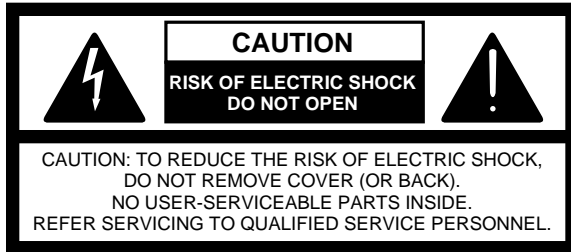

The lightning flash with arrowhead symbol, within an equilateral triangle, is intended to alert the user to the presence of uninsulated “dangerous voltage” within the product’s enclosure that may be of sufficient magnitude to constitute a risk of electric shock to persons.



The exclamation point within an equilateral triangle is intended to alert the user to the presence of important operating and maintenance (servicing) instructions in the literature accompanying the appliance.

### CAUTION:

To reduce the risk of fire or shock hazard and annoying interference, use the recommended accessories only.

### WARNING:

To reduce the risk of fire or shock hazard, do not expose this equipment to rain or moisture.

### CAUTION:

TO REDUCE THE RISK OF FIRE OR SHOCK HAZARD, REFER MOUNTING OF THE OPTIONAL INTERFACE BOARD TO AUTHORIZED SERVICE PERSONNEL.

### FCC Note:

This device complies with Part 15 of the FCC Rules. To assure continued compliance follow the attached installation instructions and do not make any unauthorized modifications.

This equipment has been tested and found to comply with the limits for a Class A digital device, pursuant to Part 15 of the FCC Rules. These limits are designed to provide reasonable protection against harmful interference when the equipment is operated in a commercial environment. This equipment generates, uses, and can radiate radio frequency energy and, if not installed and used in accordance with the instruction manual, may cause harmful interference to radio communications. Operation of this equipment in a residential area is likely to cause harmful interference in which case the user will be required to correct the interference at his own expense.

is the safety information.

- Do not insert fingers or any objects into the video cassette holder.
- Avoid operating or leaving the unit near strong magnetic fields. Be especially careful of large audio speakers.
- Avoid operating or storing the unit in an excessively hot, cold, or damp environment as this may result in damage both to the recorder and to the tape.
- Do not spray any cleaner or wax directly on the unit.
- If the unit is not going to be used for a length of time, protect it from dirt and dust.
- Do not leave a cassette in the recorder when not in use.
- Do not block the ventilation slots of the unit.
- Use this unit horizontally and do not place anything on the top panel.
- Cassette tape can be used only for one-side, one direction recording. Two-way or two-track recordings cannot be made.
- Cassette tape can be used for either Color or Black & White recording.
- Do not attempt to disassemble the recorder. There are no user serviceable parts inside.
- If any liquid spills inside the recorder, have the recorder examined for possible damage.
- Refer any needed servicing to authorized service personnel.

# Contents

---

General and Features	4
<b>Controls and their functions</b>	
Controls and their functions	6
• Front panel	7
• Connector area	11
Tapes	14
<b>Connections and settings</b>	
Connections	15
• When recording/playback using 1 unit	15
• When recording, playback and editing with 2 units	16
• When using an editing controller	17
Internal encoder adjustments	18
Printed circuit board	20
<b>Basic operations</b>	
Switching on the power/inserting the cassette	21
STOP mode	22
Recording (AJ-D450 only)	23
Playback	24
<b>Setup menus</b>	
Setup (default settings)	25
Setup (setting) menus	26
• System menu	30
• Basic menu	30
• Operation menu	32
• Interface menu	34
• Edit menu	35
• Tape protect menu	37
• Time Code menu	38
• Video menu	39
• Audio menu	41
• Menu menu	43

---

## Time code

Time code/user bit	44
• Recording internal/external time codes	45
• Reproducing the time code/user bit	46

---

## Functions

Superimpose screen	47
Servo reference	48
Audio V Fade Function (AJ-D450 only)	50

---

## Maintenance

Rack mounting	51
Head cleaning	52
Condensation	52
Error messages	53

---

## Specifications and others

RS-232C interface	57
Connector signals	64
Specifications	66

---

**Before operating this unit, check that all of its accessories are present and accounted for.**

Power cord....1 pc

### Option

- AJ-YA750P component serial interface board
- AJ-CS750P Cassette adaptor
- AJ-MA75P Rack mounting adaptor
- AJ-YA655P Digital Audio Interface Board
- AJ-YA752P Audio memory unit

# General and Features

---

This unit is a digital video cassette recorder which uses 1/4-inch tapes.

It incorporates digital compression technology so that the deterioration in picture quality and sound quality resulting from dubbing is significantly minimized compared with existing analog systems.

Furthermore, since it has a compact 4U size and light weight, the unit can be carried around or mounted in a 19-inch rack with ease.

The settings for the unit's setup can be performed while viewing the screen menus on the TV monitor. With the AJ-D450 unit, both assemble and insert editing are possible through external control.

## Features

### **Compact size and light weight**

This is a 4U size digital VTR. It can be mounted in a 19-inch rack with ease using the optional rack-mounting adaptors (AJ-MA75P).

### **Up to 184 minutes of recording**

Two sizes of cassette tapes can be used with this unit: M cassette (max. 66 minutes) and L cassette (max. 184 minutes). The width of the tapes measures 1/4 inch to achieve a compact design.

### **Compatibility with consumer products**

Consumer cassette tapes shot with digital cameras available on the consumer market can be played back on this unit using the optional cassette adaptor (AJ-CS750P).

#### **<Notes>**

- Slow motion playback is not possible with consumer cassette tapes.
- Consumer cassette tapes recorded in LP mode cannot be played back.

### **Digital slow motion/jog**

The slow motion playback images can be reproduced clearly at any of the speeds given below using commands from the external controller or other such device:  $-0.43/-0.3/-0.2/-0.1/-0.03/0/+0.03/+0.1/+0.2/+0.3/+0.5/+0.75$ .

#### **<Notes>**

- Some noise may occur when the slow motion speed is changed.
- When slow motion playback is used, the image shakes slightly in the vertical direction.

### **Dialy shuttle operation is possible through the external controller**

Shuttle operations enable the tape to be played back with color images at a speed of up to 60 times normal tape speed in either the forward or reverse direction.

### **Time codes**

This unit comes with a built-in time code generator\* (TCG)/time code reader (TCR). In addition to the internal time code, an external time code input or input signal VITC can be recorded in the machine as the LTC time code.

\* Applicable only to AJ-D450.

---

## Features

(continued)

### **Multi-function input/output interfaces** (AJ-D450 only for input)

- **Analog input/output**

Component (Y, P<sub>B</sub>, P<sub>R</sub>) and composite and S-VIDEO signal input and output connectors are provided.

- **Digital audio input/output**

AES/EBU audio input/output is possible when the optional digital audio interface board (AJ-YA655P) is used.

- **Serial digital input/output**

Serial digital (SMPTE 259M-C, 272M) input/output is possible when the optional component serial interface board (AJ-YA750P) is used.

**<Note>**

The AJ-YA655P board, sold separately, is necessary when using serial digital audio (SMPTE 272M).

- **9-pin (RS-422A)/(RS-232C) remote**

The standard 9-pin serial (RS-422A) connector or RS-232C connector is used.

### **2-channel high-sound-quality digital audio** (AJ-D450 only for recording)

Sound can be edited separately for two channels, and channel mixing capabilities are also available. One channel is provided for the analog cue track.

Information selected from audio CH1 and CH2 can be recorded in the cue track memory. (Set at the set up menu.)

- Cue track input and output connectors are not provided.

### **Automatic editing functions from the external controller** (only AJ-D450)

AJ-D450 allows both assemble and insert editing from the external controller.

### **Menu-driven setup**

The setup settings, which are conducted prior to operating the unit, are performed while viewing the setup menus either on the unit display or TV monitor.

# Controls and their functions

## Front panel

### Counter Display Section

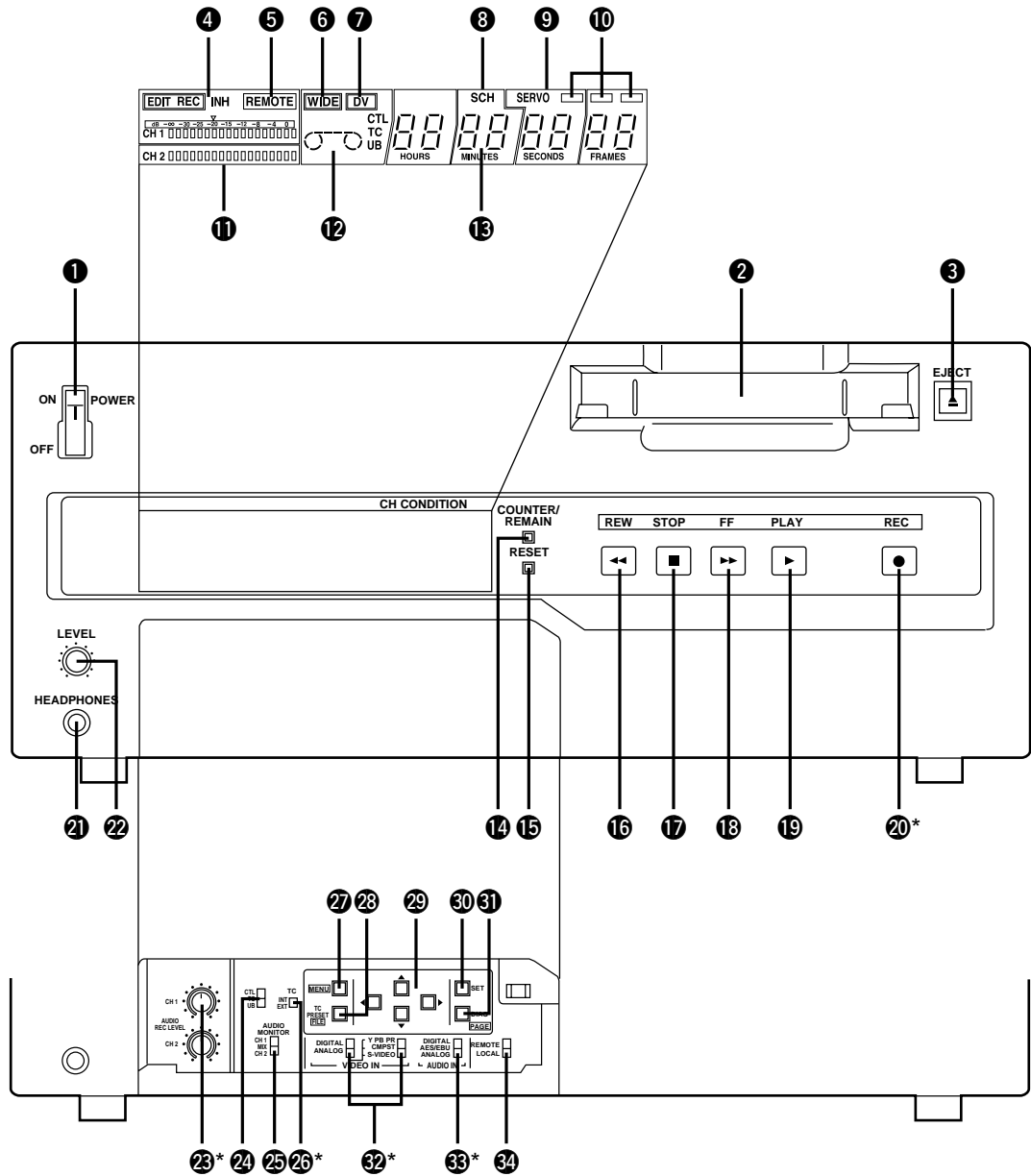

\* Applicable only to AJ-D450.

---

**① POWER switch**

When the ON side is pressed, the power is switched on, and the counter display lights up.

**② Cassette insertion slot**

The M cassette, L cassette and consumer cassette (S cassette) with adaptor are inserted into this slot.

Consumer cassettes can be played back only.

**③ EJECT button**

When this is pressed, the tape is unloaded and several seconds later the cassette is automatically ejected. When the counter display indicates "CTL", the display is reset.

**④ EDIT/EDIT REC/REC/REC INH lamps (AJ-D450 only)**

**EDIT:** This lights when the editing mode is chosen from the 9P remote control.

**EDIT REC:** This lights when editing from the 9P remote control.

**REC:** This lights during video recording.

**REC INH:** This lights when the accidental erasure prevention mode has been set for the cassette. In this state, neither recording nor editing is possible.

**⑤ REMOTE lamp**

This lights when the REMOTE/LOCAL switch has been set to the REMOTE position.

**⑥ WIDE lamp**

This lights when the unit is in 16:9 wide screen mode.

**⑦ Consumer cassette insertion display lamp**

This lights when a cassette recorded on a consumer DV device has been inserted.

**⑧ SCH lamp**

This lights when the SCH of the external sync signal is within a specific range.

**⑨ SERVO lamp**

This lights when the drum servo and capstan servo have locked.

**⑩ Channel condition lamps**

One of these lamps lights in accordance with the error rate status. (Green→blue→red)

**Green:** This lights when the error rates for the video and audio playback signals are both acceptable.

**Blue:** This lights when the error rate for the video or audio playback signals has deteriorated.

The playback picture will remain normal even when this lamp lights.

**Red:** This lights when the video or audio signals are subject to rectification or interpolation.

**⑪ Level meters**

These indicate the PCM audio signal CH1/CH2.

The audio signal indicates the input signal levels during recording and EE selection, and the output signal levels during playback.

**⑫ Cassette insertion display lamp**

This lights when a cassette has been inserted into the unit.

**⑬ Counter display**

This displays the TC and CTL count values, on-screen information and other messages.

### **COUNTER/REMAIN button**

This switches between the tape counter tape time indicator and the remaining tape indicator. [r \*\*\*] is displayed in the case of the remaining tape indicator. After the cassette tape is inserted, [r ----] (---- flashes) is displayed until remaining tape is calculated, and [r EJ] (EJ flashes) when ejecting the tape.

### **RESET button**

When this is pressed during CTL mode, the counter returns to the 00:00:00:00 display. During menu setup, initial setting values are restored when the RESET button is pressed.

### **REW button\*1**

The tape is rewound when this is pressed.

The unit goes into shuttle (SHTL) mode at  $-9.5 \times$  normal tape speed when this button is pressed together with the PLAY button.

### **STOP button**

When this is pressed, the tape stops traveling, and if the setup menu No. 111 (STOP EE SEL) is set to TAPE, still pictures can be monitored.

The drum continues to rotate even in the stop mode, and the tape remains in close contact with the drum.

If the stop mode continues for more than a certain period of time, the unit automatically switches to the standby OFF mode in order to protect the tape.

The stop mode is established immediately after a cassette has been inserted into the unit.

### **FF button\*1**

The tape is fast forwarded when this is pressed.

The unit goes into shuttle (SHTL) mode at  $+9.5 \times$  normal tape speed when this button is pressed together with the PLAY button.

### **PLAY button**

Playback commences when this button is pressed.

Recording commences when the button is pressed together with the REC button.

### **REC button (AJ-D450 only)**

Recording commences when this button is pressed together with the PLAY button.

When it is pressed during playback, search\*2, fast forward or rewind, EE mode images and audio signals can be monitored for as long as it is kept depressed.

When it is pressed in the stop mode, EE mode images and sound can be monitored.

When the STOP button is pressed, the original picture and sound are restored.

\*1 The FF/REW speed can be selected on the setup menu NO. 102 (FF. REW MAX), and it is set to the same speed.

\*2 No guarantee is made for the audio EE mode.



---

**21 Headphones jack**

The sound being recorded, played back or edited can be monitored on stereo headphones when they are connected to this jack.

**22 Volume control**

This is used to adjust the headphones volume.

**23 Audio recording level controls (AJ-D450 only)**

These are used to adjust the recording levels of the analog audio signal CH1/CH2.

**24 CTL/TC/UB switch**

Use this switch when selecting the counter display.

**CTL:** Tape timer (control signal) is displayed.

**TC:** Time code is displayed.

**UB:** User bit is displayed.

**25 MONITOR SELECT switch**

This is used to select the audio signals output to the monitor channel.

(With the No. 713 (MONI CH SEL) setting on the setup menu, the display may not match the monitor output.)

**26 INT/EXT switch (AJ-D450 only)**

**INT:** For using the built-in time code generator.

**EXT:** For using the time external code which is input from the time code input connector or the video signal VITC. The selection is set at the setup menu.

**27 MENU button**

When this is pressed, the setup menu appears on the TV monitor using VIDEO OUT 3 connector, and the setup menu No. appears on the display.

When it is pressed again, the setup mode is exited and the original operating mode is restored.

**28 TC PRESET (FILE) button (TC PRESET function: AJ-D450 only)**

When this is pressed, the time code setting mode is established.

User file can be selected when the cursor buttons (◀, ▶) are used during the setup menu mode. (For details, see setup menu items on page 26.)

**29 Cursor buttons (◀, ▶, ▲, ▼)**

These are used when setting time codes and settings at menu setup.

◀, ▶: These change the flashing digit in the time code indicators.

Each time they are pressed, the flashing indicator moves incrementally to the left or right.

◀ increments to the left; ▶ increments to the right.

▲, ▼: These change the flashing digit in the time code indicators.

Each time they are pressed, the indicated value increments and decrements.

▼ decrements the value; ▲ increments the value.

The flashing digit changes continuously when the button is continuously pressed.

For details about operation during setup menu mode, see setup menu items (page 25).

### 30 SET button

When this is pressed, the data which has been set on the setup menu is entered. After data entry, the setup mode is exited and the original operating mode is restored.

### 31 DIAG button

When this is pressed, VTR information is displayed. When it is pressed again, the original display is restored.

There are two types of VTR information: "HOURS METER" information and "WARNING" information. Switching between these types is enabled by pressing the cursor buttons (◀, ▶).

Indicated on the "HOUR METER" screen are the power-on time, drum rotation time, tape travel time, loading count, etc.

Indicated on the "WARNING" screen are the warnings.

### 32 VIDEO INPUT switch (AJ-D450 only)

This switches the video input signal.

**DIGITAL:** For selecting serial component digital video signal (SMPTE 259M-C) recording.\*

**ANALOG:** For selecting analog video signal recording.

Select the analog video signal as follows to correspond with the input signal.

**Y PB PR:** For recording an analog component video signal.

**CMPST:** For recording an analog composite video signal.

**S-VIDEO:** For recording a S-VIDEO signal.

\* The optional AJ-YA750P serial interface board is necessary.

### 33 AUDIO INPUT switch (AJ-D450 only)

This switches the audio input signal.

**DIGITAL:** For selecting serial digital audio signal (SMPTE 272M) recording.\*1

**AES/EBU:** For recording a digital audio signal.\*2

**ANALOG:** For recording an analog audio signal.

\*1 Both the optional AJ-YA750P serial interface board and the optional AJ-YA655P digital audio interface board are necessary.

\*2 The optional AJ-YA655P digital audio interface board is necessary.

### 34 REMOTE/LOCAL switch

This switch is set when the unit is to be controlled from an external source using the REMOTE connector or RS-232C connector.

**REMOTE:** Set to this position when controlling the unit by a device connected using the 9-pin REMOTE connector or RS-232C connector.

**LOCAL:** Set to this position when controlling the unit using the controls on its own operation panel.

## Connector area

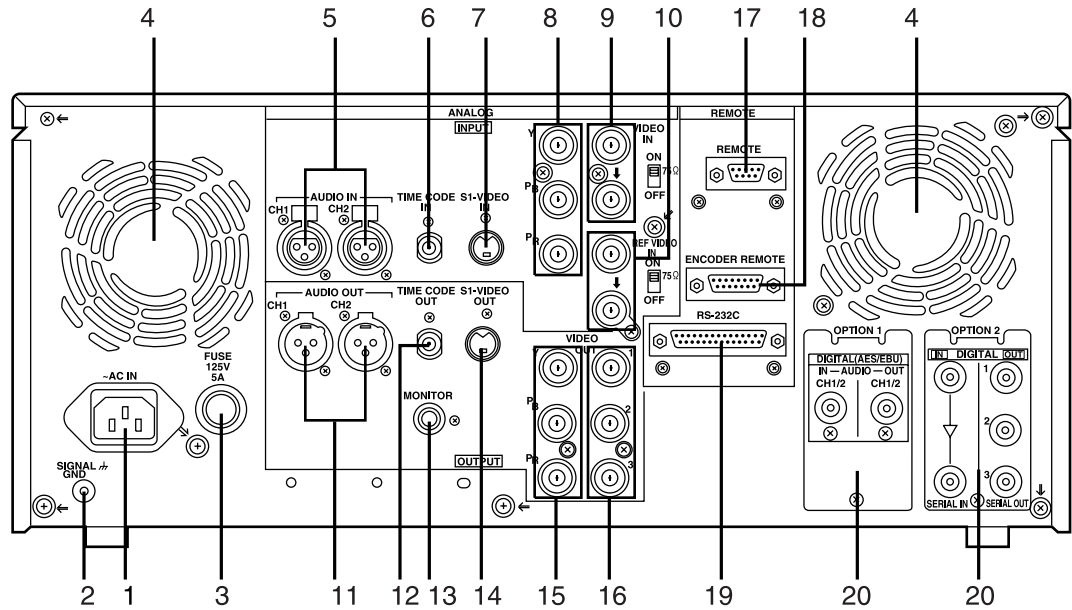

\* Applicable only to AJ-D450.

### <Connector area>

**① AC IN connector**

This is for connecting the unit to the power outlet using the power cord provided.

**② SIGNAL GND terminal**

This terminal is connected to the signal unit which is connected to the unit in order to reduce noise. It is not connected to ground for safety purposes.

**③ Fuse holder**

This contains a fuse.

**④ Fan motor**

This is for cooling the unit.

The error code is displayed on the counter when trouble has caused the fan motor to stop. If the unit is still operated in the warning status, the temperature inside the deck will rise, and when it exceeds the safety temperature, all the unit's operations will be shut down.

**⑤ ANALOG AUDIO IN connectors\***

These are the analog audio input connectors.

**⑥ TIME CODE IN connector\***

This is the connector for recording the external time code on the tape.

**⑦ S1-VIDEO IN connector\***

This is the S-VIDEO input connector.

**⑧ ANALOG COMPONENT VIDEO IN connector\***

The analog component video signal is supplied to this connector.

**⑨ ANALOG COMPOSITE VIDEO IN connectors and 75Ω termination switch\***

The analog composite video signal is supplied to these two connectors which are connected in a loop-through configuration. When the termination is required, set the switch to ON.

**⑩ REF VIDEO IN connectors and 75Ω termination switch**

These are the input connectors for the reference video signals. When the termination is required, set the switch to ON.

**⑪ ANALOG AUDIO OUT connectors**

The analog audio signals are output from these connectors.

**⑫ TIME CODE OUT connector**

The playback time code is output from this connector during playback.

During recording, the time code generated by the internal time code generator is output.

**⑬ MONITOR OUT connector**

The playback signals from the CUE track or PCM audio signal CH1/CH2 are output from this connector.

\* Applicable only to  
AJ-D450.

---

## <Connector area>

### ⑭ S1-VIDEO OUT connector

This is the S-VIDEO output connector.

### ⑮ ANALOG COMPONENT VIDEO OUT connector

The analog component video signal is output from this connector.

### ⑯ ANALOG COMPOSITE VIDEO OUT connectors

The analog composite video signals are output from these connectors.

The video signal with signals superimposed on it can be output from the VIDEO OUT3 connector.

The superimpose function can be set ON or OFF on the setup menu No. 006 (SUPER).

### ⑰ REMOTE connector

The unit can be controlled from an external source by connecting an external controller.

### ⑱ ENCODER REMOTE connector

The external encoder/controller is hooked up to this connector when the video output signal and other settings are to be adjusted from an external source.

### ⑲ RS-232C connector

### ⑳ DIGITAL AUDIO IN/OUT connector (optional AJ-YA655P required.)

This I/O connector is for digital audio signals which comply with the AES/EBU standard.

#### <Note>

Does not input with AJ-D440.

### ㉑ SERIAL DIGITAL COMPONENT AUDIO/VIDEO IN/OUT connector (optional AJ-YA750P interface board required)

This I/O connector is for digital component audio and video signals which comply with the SMPTE 259M-C/272M standard.

The optional AJ-YA655P is required for digital audio signal output on the AJ-YA750P board.

#### <Note>

Does not input with AJ-D440.

# Tapes

Type	Description
<b>Consumer cassette (S cassette)</b>	Tape designed exclusively for the camcorders used by consumers in general. Only playback is possible using the optional cassette adaptor (AJ-CS750P). However, please note that long-play cassette tapes (80-minute standard/120-minute LP mode) cannot be used. <b>Use of Panasonic consumer DV cassette tapes is recommended.</b> Note that inserting a cassette tape without using the cassette adaptor can damage the unit.
<b>M cassette</b>	Recording/playback tape with a maximum capacity of 66 minutes. (AJ-P12MP, AJ-P24MP, AJ-P33MP, AJ-P46MP, AJ-P66MP)
<b>L cassette</b>	Recording/playback tape with a maximum capacity of 184 minutes. (AJ-P34LP, AJ-P66LP, AJ-P94LP, AJ-P126LP, AJ-5P92LP)

Align the cassette with the center of the insertion slot and push it in gently. The cassette tape is loaded automatically.

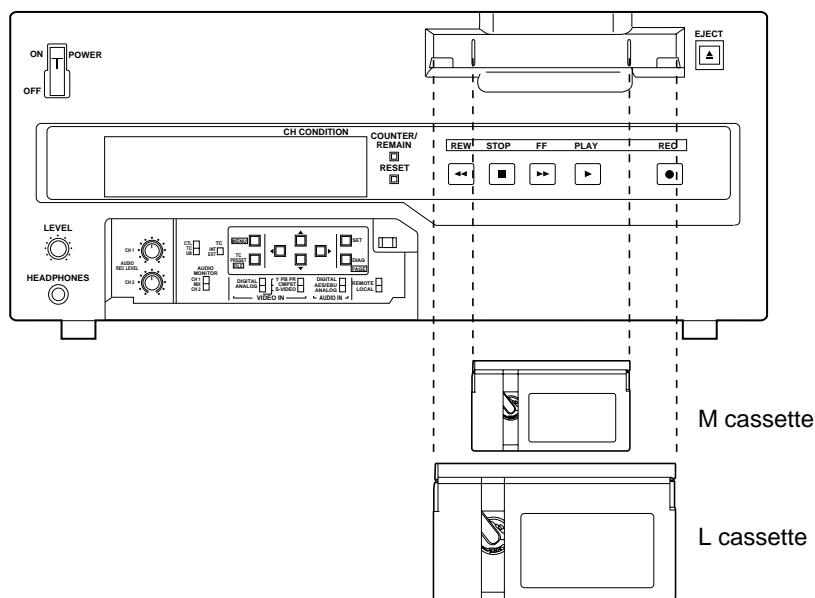

## <Note>

For AJ-5P92LP cassette tape, use a VTR supporting DVCPRO (25 Mbps) 184 minute tapes.

## <Cautions when playing back consumer DV tapes and DVCAM tapes>

- Consumer DV tapes and DVCAM tapes can be used for playback only.
- Consumer DV tapes which have been recorded in the LP mode cannot be played back.
- When materials which have been recorded on consumer DV tapes or DVCAM tapes are to be edited, record them onto a DVCPRO tape or tape of any other broadcasting VTR for use.
- Recordings cannot be made on consumer DV tapes and DVCAM tapes: this means that all functions related to recording, REC operation, TAPE/EE switching and other such operations are prohibited.
- The maximum transport speed for consumer DV tapes and DVCAM tapes is 32 times the normal tape speed.
- The maximum time for the STILL TIMER when consumer DV tapes or DVCAM tapes are used is set to 10 seconds, and the total STEP FWD time when the machine has been left standing in the STILL status is set to 1 minute.
- Slow-motion playback of consumer DV tapes and DVCAM tapes is not possible.
- In order to protect your tapes, it is recommended that repeated cue-up in the same location on a consumer DV tape or DVCAM tape be avoided as far as possible.
- Finally, check out the cautionary items for setup menu item No. 108 "FORMAT SEL".

# When recording/playback using 1 unit

Set the CONTROL switch on the front panel to LOCAL.

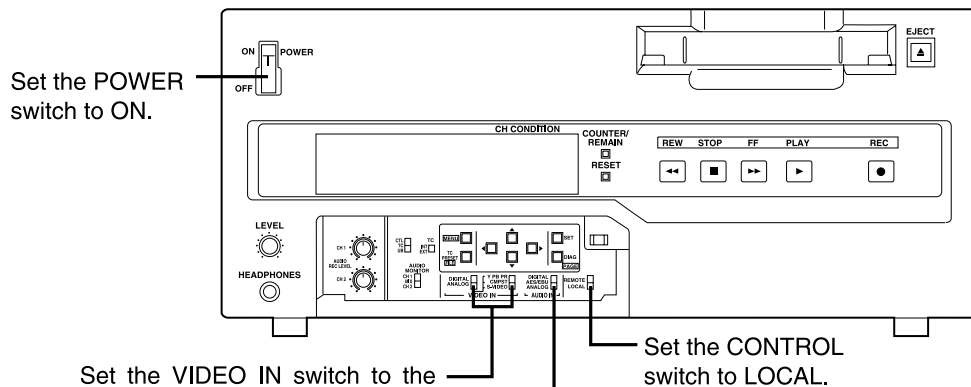
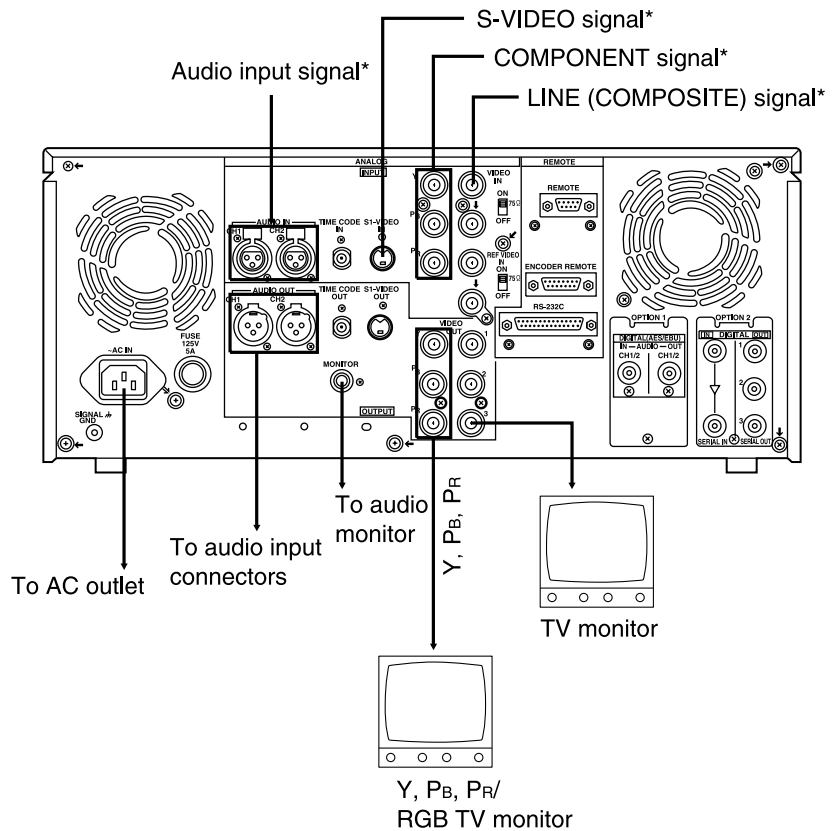

Set the VIDEO IN switch to the following position:

- "DIGITAL" for serial component digital video signal input.
- Set the VIDEO IN to ANALOG and select as following for the analog input:
  - "Y PB PR" for analog component video signal input.
  - "CMPST" for analog composite video signal input.
  - "S-VIDEO" for S-VIDEO signal input.

Set the AUDIO IN switch to the following position:

- "DIGITAL" for serial component digital audio signal input.
- "AES/EBU" for digital audio signal input.
- "ANALOG" for analog audio signal input.\*

\* Applicable only to AJ-D450.

## When recording, playback & editing with 2 units (deck to deck)

The CONTROL switch on the recorder must be set to the LOCAL position, and the CONTROL switch on the player must be set to the REMOTE position.

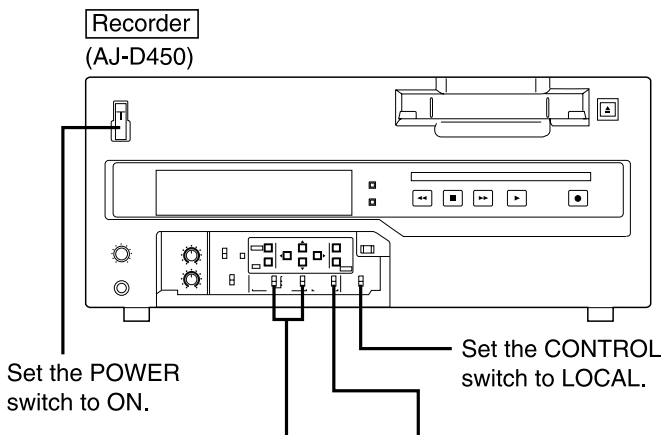
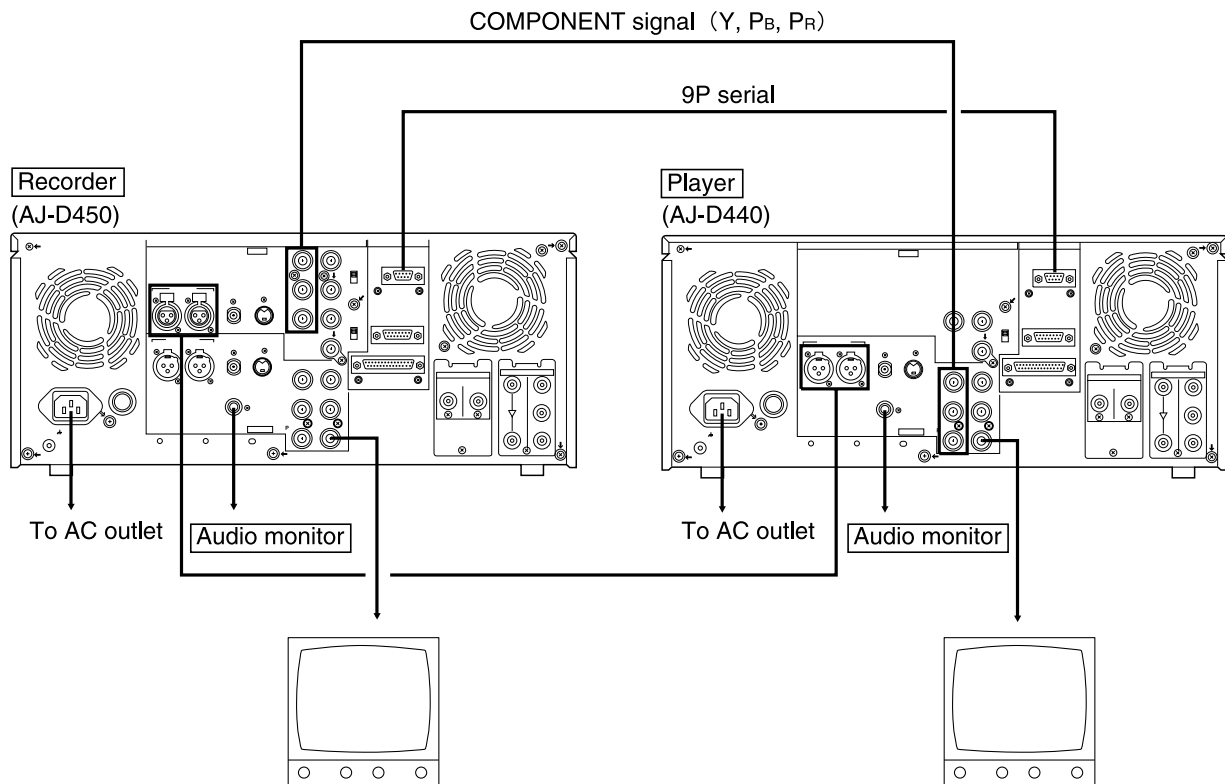

Set the VIDEO IN switch to the following position:

- "SERIAL I/F" for serial component digital video signal input.\*
- "Y PB PR" for analog component video signal input.
- "CMPST" for analog composite video signal input.

Set the AUDIO IN switch to the following position:

- "SERIAL I/F" for serial component digital audio signal input.
- "AES/EBU" for digital audio signal input.
- "ANALOG" for analog audio signal input.

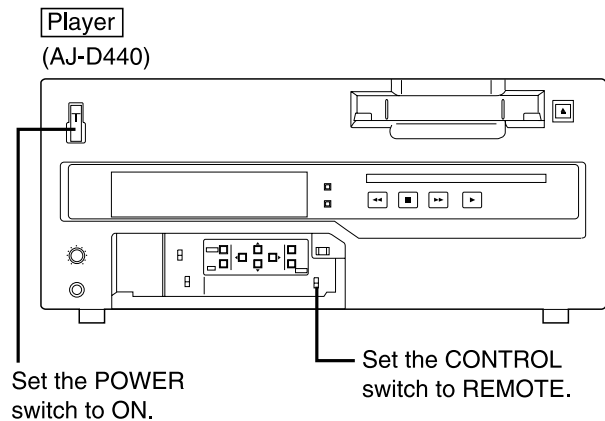



# When using an editing controller

Basic system

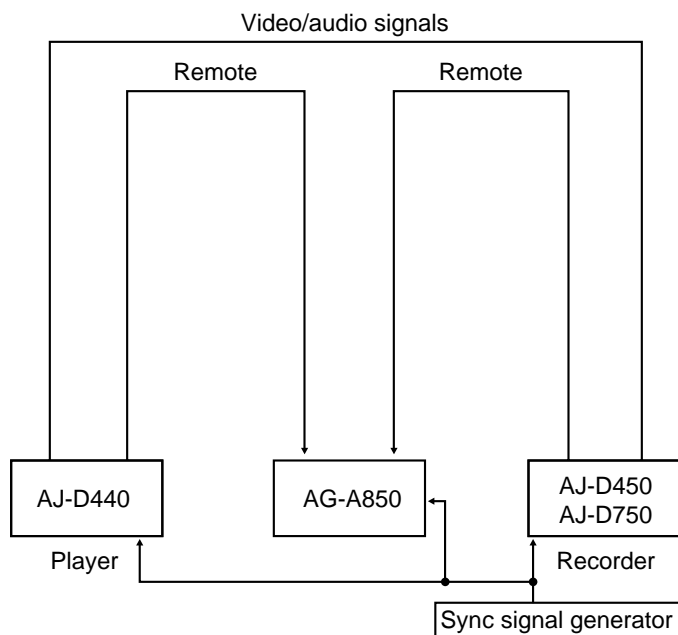

Camera/external input editing

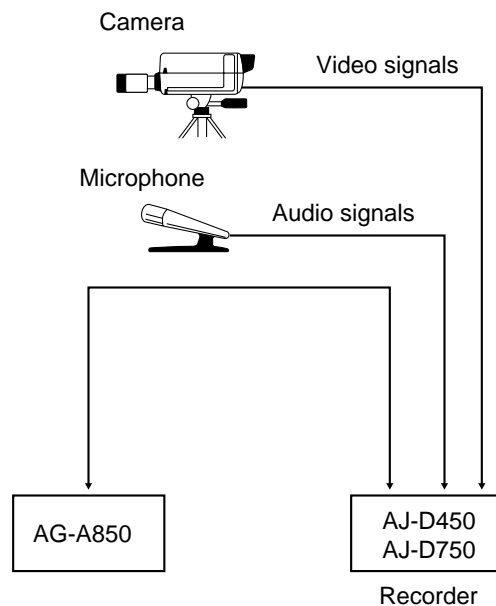

System using two players (AB roll editing)

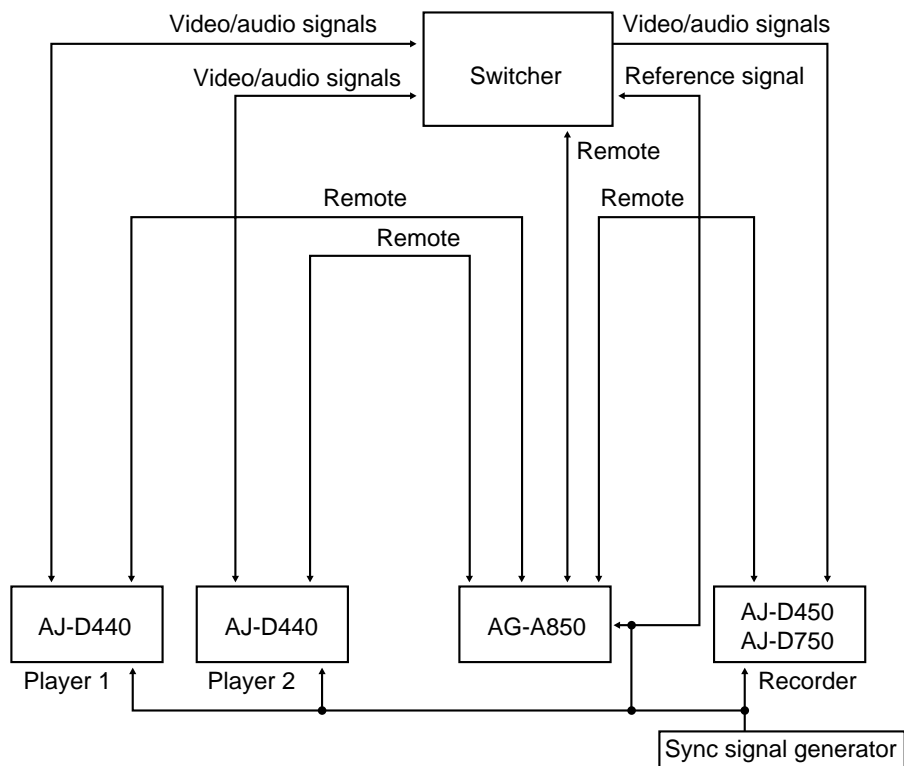

For further details, refer to the Operating Instructions of the AG-A850 editing controller (optional accessory).

# Internal encoder adjustments

In order to ensure error-free and accurate editing during AB roll editing (a method of editing using two source VTRs) using an editor, the ENCODER OUT controls must be adjusted after the system has been connected. (These controls must be re-adjusted each time the connecting cables are replaced or the connections are changed.)

Connect the equipment as shown in the figure below.

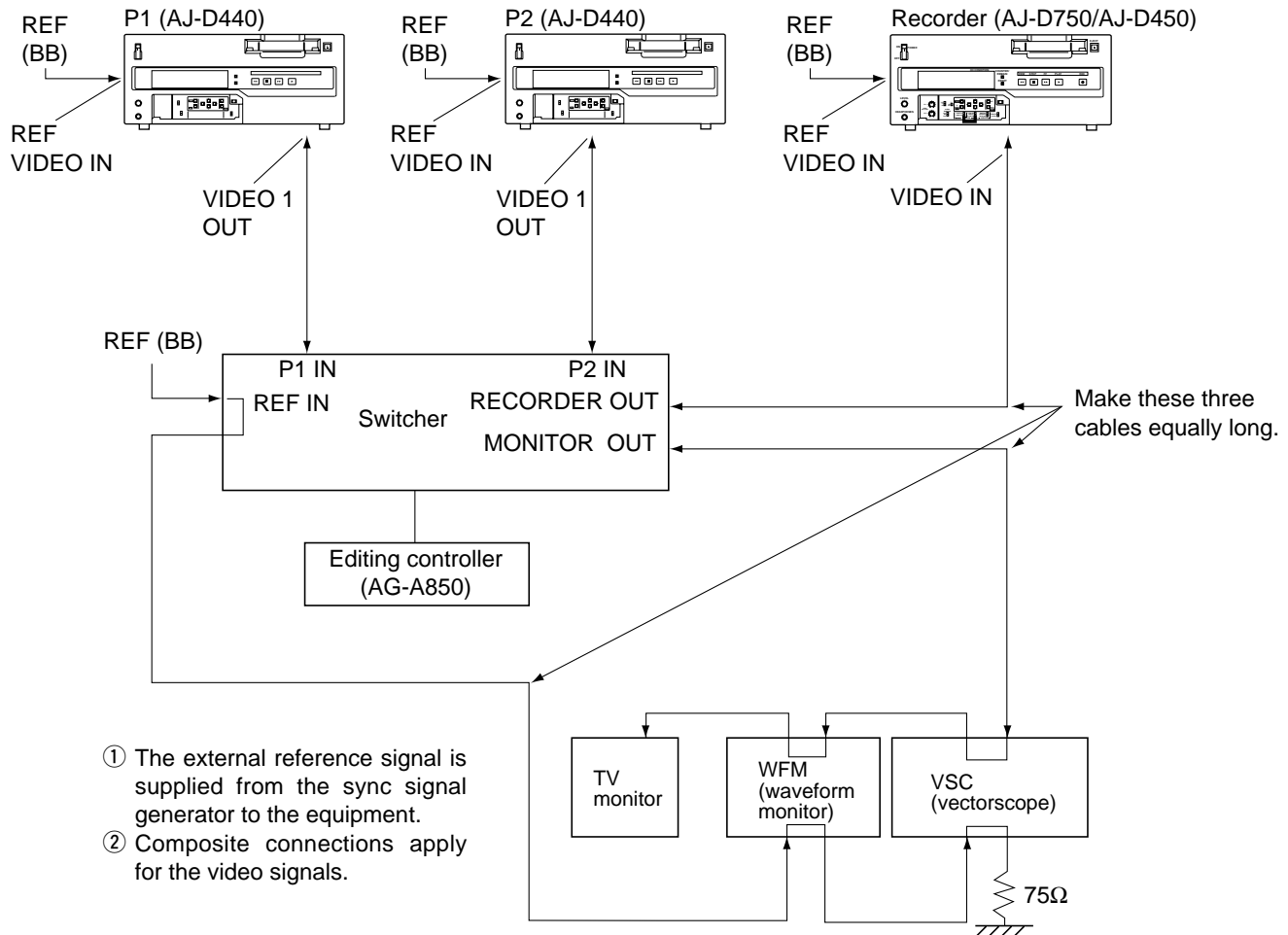

If a waveform monitor and vectorscope are not available, correct any color shifting while actually monitoring the picture on the TV monitor.

- 1** Check the connections. (see previous page.)
- 2** Select [OFF] on ENCODER SEL at the set up menu. (See page 30.)  
Select [ON] to operate the internal encoder externally.
- 3** Adjust the SYSTEM PHASE.
  - 3-1** On the P1 VTR, play back a cassette tape on which standard color bar signals have been recorded.
  - 3-2** Adjust P1 VTR SYS PHASE.  
Adjust the controls to the following with the waveform monitor (WFM).
    - 1) Expand WFM 0.1  $\mu$ s on the INT mode.
    - 2) Check the H SYNC position.
    - 3) In this status, select EXT mode for the WFM.
    - 4) In EXT mode, adjust the SYSTEM PHASE to H, SC COARSE, SC FINE, in this order, at the set up menu to set H SYNC to its previous position.

■Waveform on waveform monitor

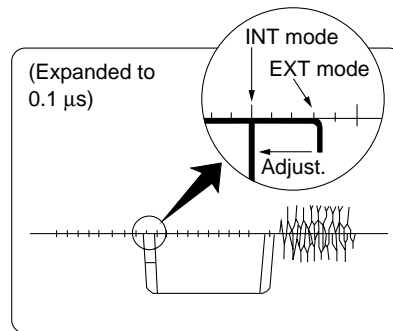

(Observe the SYNC fall.)

- 4** Adjust the connected P2 VTR in the same way.

# Printed circuit board

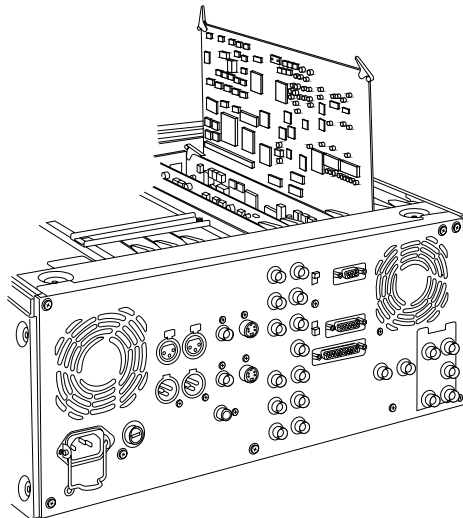

Printed circuit board	Abbr. name	Full name	Function	Factory setting
F8 board ADDA- CUE*	SW1	Audio Input Impedance SW	This sets the CH1 audio input impedance. HIGH/600Ω	HIGH
	SW61	Audio Input Impedance SW	This sets the CH2 audio input impedance. HIGH/600Ω	HIGH
F4 board	SW400	Component P <sub>B</sub> /P <sub>R</sub> Output level selector	This sets the component P <sub>B</sub> /P <sub>R</sub> output level when connecting with the editor. MII : MII level BETA : β-CAM level	BETA

**<Note>**

Component P<sub>B</sub>/P<sub>R</sub> input levels are selected at No. 600 in the setup menu.\*

**CAUTION:**

TO REDUCE THE RISK OF FIRE OF SHOCK HAZARD, REFER CHANGE OF SWITCH SETTING INSIDE THE UNIT TO AUTHORIZED SERVICE PERSONNEL.

\* Applicable only to AJ-D450.

# Switching on the power/inserting the cassette

Before starting to operate the unit, check whether the equipment has been connected properly.

- 1** Turn on the power.  
Check that the error indicator is not displayed on the counter.
- 2** Insert the cassette tape.  
Insert the tape at its proper position without force. (See page 14.)
- 3** Check that the STOP lamp is on.  
When the tape is inserted, the drum rotates automatically, the tape is loaded and the unit goes into the stop mode.

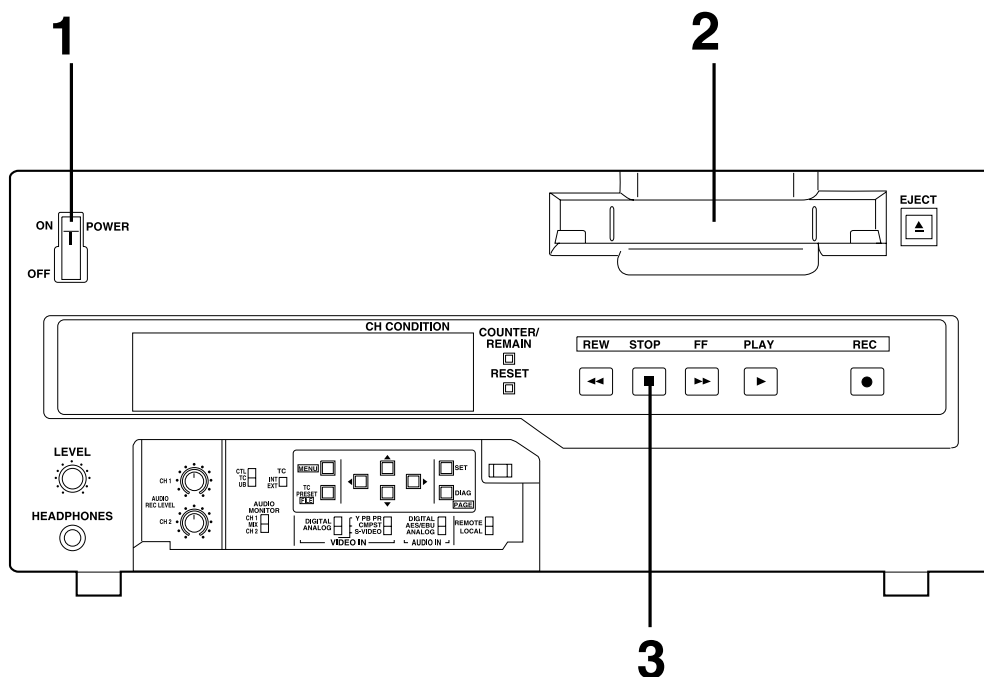

# STOP mode

- 1 When the STOP button is pressed, the unit goes into the stop mode. The STOP lamp lights and the tape stops traveling.
  - In order to protect the tape, the unit goes into the standby OFF mode after the time set by setup menu No. 400 (STILL TIMER) has elapsed. When the STOP, REW, FF or PLAY button is pressed, the unit will go into the appropriate mode.

## Still Timer Setting

In order to protect the tape and VTR helical heads, it is recommended that the Still Timer be set for automatic tape protection mode in 30 seconds or under.

Page 37 indicates the settings for menu item 400-Still Timer set. Still Timer settings 4 and below will best protect the tape.

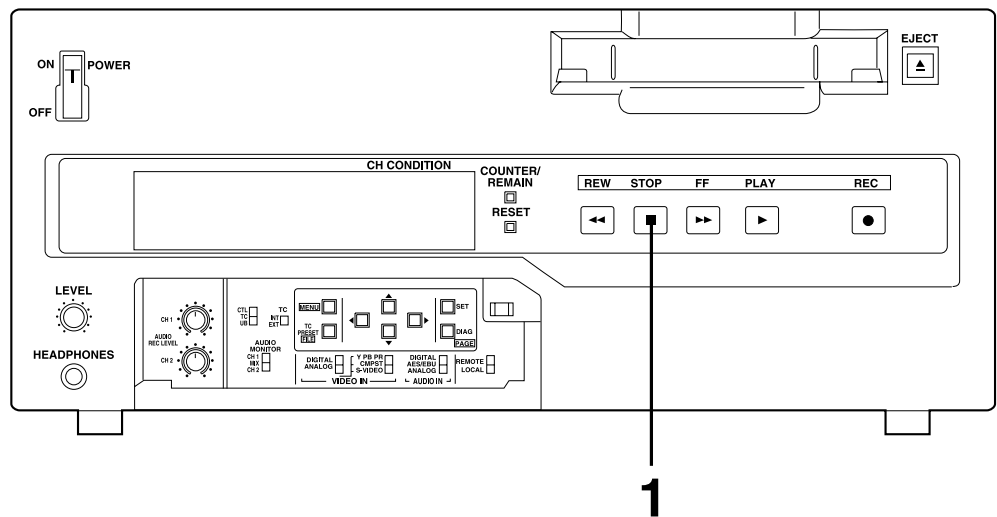

## Recording (AJ-D450 only)

---

- 1** Set the accidental erasure prevention tab on the cassette tape to the “recording” position and insert the tape.
- 2** Press the STOP button to place the unit in the stop mode.
- 3** Check that the REC INHIBIT lamp is off.
- 4** Select the video and audio input signals and adjust their levels.
  - 4-1 Selecting video/audio input signals**
    - 1** Connect the signals to be recorded.
    - 2** Select the input signals using the INPUT SELECT switches on the front panel.
  - 4-2 Adjusting the audio level**

Adjust the audio input signal levels of the analog audio CH1/CH2 signals. When set at the center position, audio signals will be recorded at the proper level.
- 5** Press the PLAY button while holding down the REC button. The REC and PLAY lamps light, and recording commences.
- 6** To end the recording, press the STOP button.

Recording is ended, and the unit goes into the stop mode.

### <Notes>

- Check that the SERVO lamp is lighted during recording. If it flashes or if it is off, the images played back will be disturbed.
- The sound and pictures to be recorded are offset from the playback pictures by 5 frames and recorded. When, for instance, recording sound at a particular timing while the playback pictures are monitored, the sound to be edited will be recorded at a position which is offset from the playback pictures by 5 frames.

# Playback

---

- 1** Insert the cassette tape, and place the unit in the stop mode.
- 2** Press the PLAY button.  
Regular playback is now commenced.
- 3** To end playback, press the STOP button.  
The VTR now goes into the stop mode.

**<Note>**

Check that the SERVO lamp is lighted during playback. If it flashes or if it is off, the images played back will be disturbed.



# Setup (default settings)

The unit's major settings are performed by making selections on menus.

The setting menus appear on the TV monitor when the TV monitor and VIDEO OUT 3 connector in the unit's connector area are hooked up.

## Changing the settings

- 1** Press the MENU button.  
The setup menu appears on the TV monitor and setup menu No. appears on the counter display. (If the setup has already been performed, the screen showing the changes made last will appear.)
- 2** Press the cursor buttons (▲, ▼) and select the item to be set.  
The cursor ( \* ) on the menu screen moves and the item No. on the display flashes.
  - When the ▼ button is pressed, the item No. is incremented for 001 → 002 → 003 → 004 → and so on; when the ▲ button is pressed, the item No. is decremented.
- 3** Press the cursor buttons (◀, ▶) at the position where the change is to be made.  
The menu screen and display setting No. now flashes.  
When the ▶ button is pressed, the setting No. is incremented; when the ◀ button is pressed, it is decremented.
- 4** Repeat steps 2 and 3 to change other items.
- 5** Press the SET button.  
The changes are now stored in the memory.
  - To return the items to the settings established before the changes were made, press the MENU button without pressing the SET button.

To return the setup settings to the factory (initial) settings, press the RESET button while the menu is displayed.

### The following message is displayed.

SETUP-MENU INIT SET  
YES<PLAY>/NO<STOP>

When the PLAY button is pressed, the factory settings are restored.

#### <Notes>

- When the RESET button is pressed to return to the factory settings, the factory settings are restored only for the user file currently being used and other user files are not affected.
- The changed SYSTEM menu contents are stored in the memory even if the MENU button is pressed.

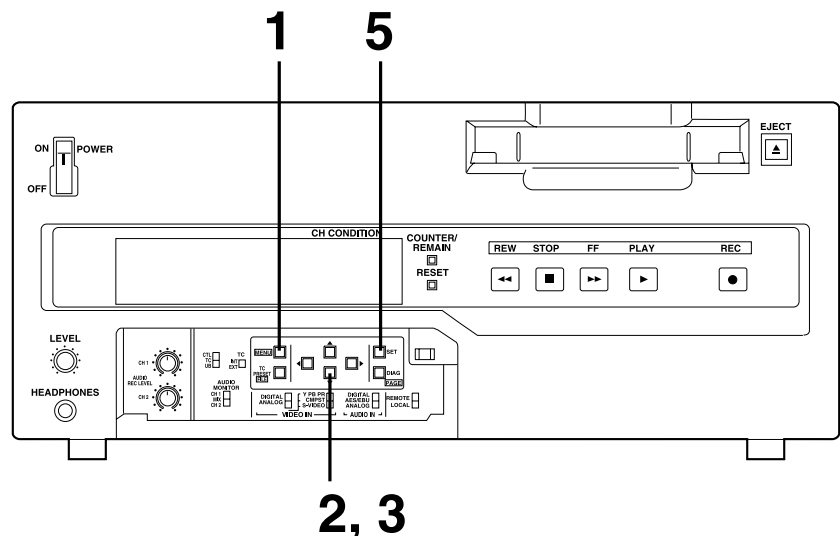



# Setup (setting) menus

---

This unit can store up to 5 user files (user 1 to user 5) containing different menu settings, and these files can be selected and used.

## Changing the file

- 1** Press the MENU button.
- 2** Hold down the FILE button and press the cursor button  to switch to the next user file.  
Hold down the FILE button and press the cursor button  to switch to the previous user file.

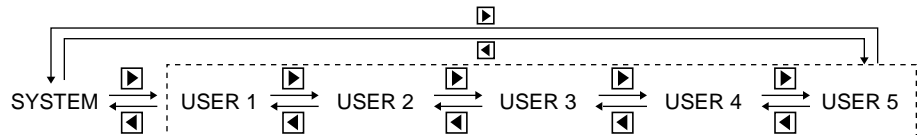

### USER FILE

Each user file contains the following items.

- BASIC
- OPERATION
- INTERFACE
- EDIT
- TAPE PROTECT
- TIME CODE
- VIDEO
- AUDIO
- MENU

- 3** Repeat the operation in step 2 to select the user file to be used and press the SET button. The user file is changed and stored in the memory.

### <Note>

SYSTEM menu items are not included in user files 1 to 5.

Therefore, after selecting the user file, switch to the SYSTEM file and set the SYSTEM menu items.

# Setup menus

---

Lock mode can be set to protect the settings in the system files and user files (USER2 – USER5). Settings can no longer be changed when this mode is set.

To set and release the lock mode for the system files and user files use setup item No. 30 (MENU LOCK) and setup menu item No. A03 (MENU LOCK), respectively.

## Setting and releasing the lock mode.

- 1** Press the MENU button.
- 2** While holding down the FILE button, press the ◀ or ▶ button, and select the file for which the lock mode is to be set or released.
- 3** Press the ▲ or ▼ button and move the cursor (\*) on the menu screen to setup item No. 30 (MENU LOCK) or setup menu item No. A03 (MENU LOCK) for the system or user file.
- 4** Press the ◀ or ▶ button, and select lock mode setting or release.  
**To set the lock:** Select the 0001 (ON) setting.  
**To release the lock:** Select the 0000 (OFF) setting.

When the lock has been set, "LOCKED" flashes on the menu screen. In addition, the counter display stops flashing and lights.

SETUP-MENU	LOCKED
<USER2>	NO.000 - 0005
*000 P-ROLL TIME	5s
001 CHARA H-POS	5
002 CHARA V-POS	23
003 DISPLAY SEL	T&STA
004 LOCAL ENA	ST&EJ
005 TAPE TIMER	±12h
006 SUPER	ON
007 CHARA TYPE	WHITE
101 SHTL MAX	X32

- 5** Press the SET button. The setting is now stored in the memory.

### <Notes>

- The lock mode cannot be set for the USER1 file settings.
- Even if the RESET button is pressed, the files which has been set to the lock mode cannot be reset to the factory settings.

# Setup menus

The contents of the USER2 – USER5 files can be copied (loaded) into the USER1 file. In addition, the contents of the USER1 file can be copied (saved) to the USER2 – USER5 files.

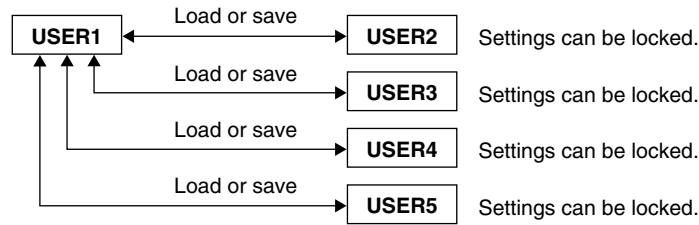

## Loading a user file

- 1** Press the MENU button.
- 2** While holding down the FILE button, press the ◀ or ▶ button, and select USER1.
- 3** Press the ▲ or ▼ button and move the cursor (\*) on the menu screen to setup item No. A00 (LOAD).

```

SETUP-MENU  MENU
<USER1>    NO.A00 - 0000
 725 CUE SLOW      STEP
*A00 LOAD          USER2
A01 SAVE          USER2
A02 P.ON LOAD     OFF
END
  
```

- 4** Press the ◀ or ▶ button and select the user file whose contents are to be loaded into USER1.
- 5** Press the SET button. The following messages appear on the menu screen and counter display.

Menu screen

```

SETUP-MENU LOAD

USER2 → USER1 OK?
YES<PLAY>/NO<STOP>
  
```

Counter display

```

L U2 -U1
  
```

The user file number selected in step 4 is displayed in the shaded area.

- 6** Press the PLAY button. The settings of the user file selected in step 4 are loaded, and the USER1 menu display appears. When the STOP button is pressed, the USER1 menu display appears while the settings remain unchanged.
- 7** Press the ▲ or ▼ button and move the cursor (\*) on the menu screen to any setup item except No. A00 (LOAD) and No. A01 (SAVE).
- 8** Press the SET button. The USER1 settings are now stored in the memory. If the USER1 settings are not going to be stored in the memory, do not press the SET button but press the MENU button.

---

## Saving a user file

- 1 Press the MENU button.
- 2 While holding down the FILE button, press the ◀ or ▶ button, and select USER1.
- 3 Press the ▲ or ▼ button and move the cursor (\*) on the menu screen to setup item No. A01 (SAVE).

```
SETUP-MENU  MENU
<USER1>    NO.A00 - 0000
723 DV PB ATT      OFF
A00 LOAD          USER2
*A01 SAVE          USER2
A02 P.ON LOAD      OFF
END
```

- 4 Press the ◀ or ▶ button and select the user file into which the USER1 contents are to be saved. User files which have been set to the lock mode are not displayed. When all the user files have been set to the lock mode, the “LOCKED” display appears and the contents cannot be saved.
- 5 Press the SET button. The following messages appear on the menu screen and counter display.

Menu screen

```
SETUP-MENU SAVE

USER1 → USER2 OK?
YES<PLAY>/NO<STOP>
```

Counter display

```
S U1 -U2
```

The user file number selected in step 4 is displayed in the shaded area.

- 6 Press the PLAY button. The contents of the USER1 file are saved in the user file which was selected in step 4 and stored in the memory. When the STOP button is pressed, the USER1 menu display appears while the settings remain unchanged.
- 7 Press the ▲ or ▼ button and move the cursor (\*) on the menu screen to any setup item except No. A00 (LOAD) and No. A01 (SAVE).
- 8 Press the SET button. The USER1 settings are now stored in the memory. If the USER1 settings are not going to be stored in the memory, do not press the SET button but press the MENU button.

## Automatic loading of user file when the power is turned on

When the user file to be loaded is selected in advance using setup menu item No. A02 (P.ON LOAD), it can be automatically loaded into USER1 when the power is turned on.

# Setup (setting) menus

## SYSTEM menu

<SYSTEM>

Item		Setting		Description
No.	Superimposed display	No.	Superimposed display	
00	SYS SC COAR.	<u>0000</u> 0001 0002 0003	<u>0</u> 90 180 270	System phase rough adjustment: 90j units <Note> If setting operation is performed, the setting value does not return to factory (default) setting.
01	SYS SC FINE	0000 ⋮ <u>0127</u> ⋮ 0255	-127 ⋮ <u>0</u> ⋮ 127	System phase fine adjustment: Total variable range: ±90j or more -: advanced +: delayed <Note> If setting operation is performed, the setting value does not return to factory (default) setting.
02	SYS H	0000 ⋮ <u>0112</u> ⋮ 0224	-112 ⋮ <u>0</u> ⋮ 112	System phase adjustment: ±2 msec (SC cycle phase) -: Advanced +: Delayed <Note> If setting operation is performed, the setting value does not return to factory (default) setting.
03	ENCODER SEL	<u>0000</u> 0001	<u>OFF</u> ON	This selects whether the ENCODER connector functions. 0: Does not functions. 1: Functions.
10	AV PHASE	0000 ⋮ <u>0128</u> ⋮ 0255	-128 ⋮ <u>0</u> ⋮ 127	This adjusts the audio output phase with respect to the video output: 20.8 ms steps -: The audio output phase is advanced with respect to the video output. +: The audio output phase is delayed with respect to the video output.
30	MENU LOCK	<u>0000</u> 0001	<u>OFF</u> ON	This selects whether the system file lock mode is to be engaged or released. 0: The lock is released (file data can be changed). 1: The lock is engaged (file data cannot be changed).

The underline on the setting item denotes the initial setting.

## USER menu

<BASIC>

Item		Setting		Description
No.	Superimposed display	No.	Superimposed display	
000	P-ROLL TIME	0000 ⋮ <u>0005</u> ⋮ 0015	0S ⋮ <u>5S</u> ⋮ 15S	This sets the preroll time which can be set from 0 to 15 seconds in 1-second increments. <Note> In the case of AJ-D450, the unit will not operate if the preroll time is set to 0 seconds when the unit is set to automatic editing (PREVIEW, AUTO EDIT COMMAND) from an external controller.

The underline on the setting item denotes the initial setting.

# Setup menus

## USER menu

### <BASIC> (continued)

Item		Setting		Description
No.	Superimposed display	No.	Superimposed display	
001	CHARA H-POS	0000 ⋮ <u>0005</u> ⋮ 0012	0 ⋮ <u>5</u> ⋮ 12	This sets the position of the characters on the horizontal plane for the time code and other super displays output to the VIDEO OUT 3 connector. <b>&lt;Notes&gt;</b> 1. When setting this item, the DISPLAY SEL status is output to VIDEO OUT 3 even if SUPER OFF has been set. However, when the menu is exited, operation complies with the SUPER OFF/ON setting. Also, CHARA TYPE is output to VIDEO OUT 3 according to the status set in the menu. 2. When the DISPLAY SEL setting causes characters to extend beyond the edges of the screen, the setting value is changed so that the characters are automatically displayed in a position on the screen.
002	CHARA V-POS	0000 ⋮ <u>0018</u> ⋮ 0022	0 ⋮ <u>18</u> ⋮ 22	This sets the position of the characters on the vertical plane for the time code and other super displays output to the VIDEO OUT 3 connector. <b>&lt;Notes&gt;</b> 1. When setting this item, the DISPLAY SEL status is output to VIDEO OUT 3 even if SUPER OFF has been set. However, when the menu is exited, operation complies with the SUPER OFF/ON setting. Also, CHARA TYPE is output to VIDEO OUT 3 according to the status set in the menu. 2. When the DISPLAY SEL setting causes characters to extend beyond the edges of the screen, the setting value is changed so that the characters are automatically displayed in a position on the screen.
003	DISPLAY SEL	0000 <u>0001</u> 0002	TIME <u>T&amp;STA</u> T&S&M	This selects what information is to be provided by the time code and other super displays output to the VIDEO OUT 3 connector. 0: Time only. 1: Time and status. 2: Time, status and mode. <b>&lt;Notes&gt;</b> • When T&S&M has been selected, one of the following displays appears on the third line of the superimposed display. In the DVCPRO mode: DVCPRO MODE In the DV mode: DV MODE In the DVCAM mode: DVCAM MODE • An error message is displayed when an warning or error occurs.
004	LOCAL ENA	0000 <u>0001</u> 0002	DIS <u>ST&amp;EJ</u> ENA	This selects the buttons which can be operated on the front panel when the REMOTE/LOCAL switch has been set to REMOTE. 0: No buttons can be operated. 1: Only the STOP and EJECT buttons can be operated. 2: All buttons can be operated.
005	TAPE TIMER	<u>0000</u> 0001	<u>±12h</u> 24h	This selects the 12 or 24 hour display for the CTL counter. 0: 12 hour display 1: 24 hour display
006	SUPER	0000 <u>0001</u>	OFF <u>ON</u>	This selects whether the time code and other super display which are output to the VIDEO OUT 3 connector is to shown. 0: Not shown. 1: Shown.
007	CHARA TYPE	<u>0000</u> 0001	<u>WHITE</u> W/OUT	This selects the display type for the super display output to the VIDEO OUT 3 connector as well as for displays such as the setting menu, etc. 0: White characters against a black background. 1: White characters with a black border.

The underline on the setting item denotes the initial setting.

# Setup menus

## USER menu

### <OPERATION>

Item		Setting		Description
No.	Superimposed display	No.	Superimposed display	
101	SHTL MAX	<u>0000</u> 0001 0002	× 16 × 32 × 60	This sets the maximum speed for shuttle operations. 0: 16 × normal speed 1: 32 × normal speed 2: 60 × normal speed <Note> During DV or DVCAM format, the maximum speed is 32 × normal speed even when 60 × is selected.
102	FF. REW MAX	<u>0000</u> 0001 0002	× 32 × 60 × 100	This sets the maximum speed for FF and REW operations. 0: 32 × normal speed 1: 60 × normal speed 2: 100 × normal speed <Note> During DV or DVCAM format, the maximum speed is 32 × normal speed regardless of this setting.
103	AUDIO MUTE	<u>0000</u> 0001	OFF ON	This sets the status until the audio signal is output when operation switches from the stop or search modes to the play mode. 0: The time until the audio is output is shortened. 1: The audio is output after the status stabilizes. <Note> When set to 0 (OFF), the sound in the initially output part is incomplete. Therefore, this setting is not recommended for broadcasts.
104	REF ALARM	<u>0000</u> 0001	OFF ON	This selects whether to warn the operator when the REF.VIDEO signal has not been connected. 0: Warning is not given. 1: Warning is given by the flashing STOP lamp.
106	PLAY DELAY	<u>0000</u> ⋮ 0015	0 ⋮ 15	This set the play delay time in frame increments.
107	CAP. LOCK	<u>0000</u> 0001	2F 4F	This selects the capstan lock mode. 0: 2F mode 1: 4F mode
108	FORMAT SEL	<u>0000</u> 0001 0002	<u>DVCPRO</u> DV DVCAM	These settings are for selecting the format when an L cassette or S cassette is used. 0: L cassette → DVCPRO mode S cassette → DV mode 1: L cassette/S cassette → DV mode 2: L cassette/S cassette → DVCAM mode <Notes> Bear in mind that, in addition to problems with playback, the trouble described below may occur when a tape which does not match the selected format is inserted. 1. If a DV or DVCAM tape is inserted when the DVCPRO mode setting has been selected, the recording operation will be conducted but no guarantee is given for the resulting performance, etc. Conversely, recording is not possible if a DVCPRO cassette tape is inserted when the DV or DVCAM mode setting has been selected. 2. The REMAIN display fails to appear properly. 3. The slow-down position near the tape start or end is not located accurately. 4. When a tape which does not match the selected format is inserted, no guarantee is given for the resulting performance, etc.

The underline on the setting item denotes the initial setting.



## USER menu

### <OPERATION> (continued)

Item		Setting		Description
No.	Superimposed display	No.	Superimposed display	
109*	EJECT EE SEL	<u>0000</u> 0001	<u>EE</u> BLACK	This selects whether EE mode or BLACK is to be used during EJECT status. 0: EE mode 1: Video blackens, audio mutes.
110*	F/R EE SEL	<u>0000</u> 0001	<u>EE</u> TAPE	This selects whether EE mode or playback mode is to be used during FF/REW operations. 0: EE mode 1: Playback mode
111*	STOP EE SEL	<u>0000</u> 0001	<u>EE</u> TAPE	This selects whether EE mode or playback mode is to be used during stop mode. 0: EE mode 1: Playback mode <b>&lt;Note&gt;</b> The STAND-BY OFF mode complies with the above selection. When TAPE is selected, however, the video becomes grey.
112	AUTO REW	<u>0000</u> 0001	<u>OFF</u> ON	This selects whether to rewind the tape automatically to the tape start when the tape end is detected. 0: The tape stops at the tape end. 1: The tape is rewound to the tape start.
113	MEMORY STOP	<u>0000</u> 0001	<u>OFF</u> ON	This selects whether the VTR is to stop automatically when the counter value reaches "0" during a fast forwarding or rewinding operation in the CTL mode. 0: The VTR does not stop. 1: The VTR stops automatically. <b>&lt;Notes&gt;</b> 1. The stop mode concerned is either the stop or the still-picture (SHTL STILL) mode depending on the setup menu No. 313 (AFTER CUE-UP) setting. 2. When both the AUTO REW function and MEMORY function have been selected at the same time, the AUTO REW function takes precedence.
114*	REC INHIBIT	<u>0000</u> 0001	<u>OFF</u> ON	This selects whether to allow (enable) or prohibit (disable) the recording of signals on the cassette tape. 0: Signals can be recorded on the cassette tape when the cassette's accidental erasure prevention mechanism is set to the recording enable position. 1: Recording on the cassette tape is prohibited. In this case, the REC INH lamp on the front panel lights.
115	STOP RESPNS	<u>0000</u> 0001	<u>NORMAL</u> QUICK	This selects the response when the mode is changed to STOP/STILL while the tape is traveling. 0: Priority is given to the output picture. 1: Priority is given to the response. <b>&lt;Notes&gt;</b> • At the 1 (QUICK) setting, the picture may not be as clear in the STOP/STILL mode as it would be at the 0 (NORMAL) setting. • CTL may shift by $\pm 2$ frames.

The underline on the setting item denotes the initial setting.

\* The Setup menu can only be displayed for the model AJ-D450.

# Setup menus

## USER menu

### <INTERFACE>

Item		Setting		Description
No.	Superimposed display	No.	Superimposed display	
201	9P SEL	<u>0000</u> 0001	OFF <u>ON</u>	This selects whether the 9P connector functions when the REMOTE/LOCAL switch has been set to REMOTE. 0: Do not function 1: Function
202	ID SEL	<u>0000</u> 0001	<u>OTHER</u> DVCPRO	This selects the ID information which is returned to the controller. 0: 20 25H 1: DVCPRO's, own ID is returned (F0 33H).
204	RS232C SEL	<u>0000</u> 0001	<u>OFF</u> ON	These settings are for selecting whether the RS-232C connector is to function when the REMOTE/LOCAL switch is set to REMOTE. 0: Connector does not function. 1: Connector functions.
205	BAUD RATE	0000 0001 0002 0003 0004 <u>0005</u>	300 600 1200 2400 4800 <u>9600</u>	These settings are for selecting the RS-232C communication speed (baud rate).
206	DATA LENGTH	0000 <u>0001</u>	7 <u>8</u>	These settings are for selecting the RS-232C data length. (Unit: bit)
207	STOP BIT	<u>0000</u> 0001	1 2	These settings are for selecting the RS-232C stop bit length. (Unit: bit)
208	PARITY	<u>0000</u> 0001 0002	<u>NON</u> ODD EVEN	These settings are for selecting the none, odd or even for the RS-232C parity bit. 0: Parity bit is not used. 1: An odd number of bits is used for the parity system. 2: An even number of bits is used for the parity system.
209	RETURN ACK	0000 <u>0001</u>	OFF <u>ON</u>	These settings are for selecting whether the ACK code is to be returned when a command is received from RS-232C. 0: ACK code is not returned. 1: ACK code is returned.

The underline on the setting item denotes the initial setting.

## USER menu

<EDIT>

Item		Setting		Description
No.	Superimposed display	No.	Superimposed display	
303*	STD/ NON-STD	<u>0000</u> 0001 0002	<u>AUTO</u> STD N-STD	This selects STD or NON-STD in accordance with the composite input signal. 0: Standard/non-standard signals are automatically identified and processed. 1: Standard signals are processed. (Forced STD) 2: Non-standard signals are processed. (Forced NON-STD)
304*	SERVO REF	<u>0000</u> 0001	<u>AUTO</u> EXT	This selects the video signal processing. 0: Servo is synchronized with the input signal during recording and editing, or with the REF signal during playback. 1: Servo is synchronized at all times with the REF signal.
305*	EDIT RPLCE1	<u>0000</u> <u>0001</u> 0002 0003	<u>N-DEF</u> CH1 CH2 CH1+2	This sets the channel assignments for the controller's analog audio preset when editing the digital audio of the VTR using a controller which does not have a digital audio edit preset control function. This selects the channel concerned when the VTR CH1 edit preset is set in compliance with the ON or OFF presetting for the analog audio signals designated by the controller. 0: Not set. 1: Compliance with analog CH1 edit preset. 2: Compliance with analog CH2 edit preset. 3: Compliance with either analog CH1 or CH2 edit preset.
306*	EDIT RPLCE2	<u>0000</u> 0001 <u>0002</u> 0003	<u>N-DEF</u> CH1 <u>CH2</u> CH1+2	This sets the channel assignments for the controller's analog audio preset when editing the digital audio of the VTR using a controller which does not have a digital audio edit preset control function. This selects the channel concerned when the VTR CH2 edit preset is set in compliance with the ON or OFF presetting for the analog audio signals designated by the controller. 0: Not set. 1: Compliance with analog CH1 edit preset. 2: Compliance with analog CH2 edit preset. 3: Compliance with either analog CH1 or CH2 edit preset.
307*	EDIT RPLCEC	<u>0000</u> 0001 0002 0003	<u>N-DEF</u> CH1 CH2 CH1+2	This sets the channel assignments for the controller's analog audio preset when editing the digital audio of the VTR using a controller which does not have a digital audio edit preset control function. This selects the channel concerned when the VTR CUE edit preset is set in compliance with the ON or OFF presetting for the analog audio signals designated by the editor or controller. 0: Not set. 1: Compliance with analog CH1 edit preset. 2: Compliance with analog CH2 edit preset. 3: Compliance with either analog CH1 or CH2 edit preset.
309*	AUD EDIT IN	<u>0000</u> <u>0001</u>	<u>CUT</u> <u>FADE</u>	This selects the connection method for the digital audio edit IN point. 0: Cut processing 1: V Fade processing
310*	AUD EDIT OUT	<u>0000</u> <u>0001</u>	<u>CUT</u> <u>FADE</u>	This selects the connection method for the digital audio edit OUT point. 0: Cut processing 1: V Fade processing

The underline on the setting item denotes the initial setting.

\* The Setup menu can only be displayed for the model AJ-D450.

# Setup menus

## USER menu

<EDIT> (continued)

Item		Setting		Description
No.	Superimposed display	No.	Superimposed display	
313	AFTER CUE-UP	<u>0000</u> 0001	<u>STOP</u> STILL	This selects the mode after cue-up operation is complete. 0: STOP mode 1: SHTL STILL mode
315*	AUD MEM UNIT	<u>0000</u> 0001 0002 0003	<u>OFF</u> MODE1 MODE2 MODE3	This selects the connection with the AJ-YA752 audio memory unit. 0: When the audio memory unit is not going to be used 1: When a voice-over operation is to be conducted 2: When audio cross channel editing is to be performed for CH2 3: When audio cross channel editing is to be performed for CH1 <Notes> • The RS-232C interface will function only when this menu item is set to 0 (OFF). • Refer to the Instruction Manual of the AJ-YA752 audio memory unit for details on how the modes are used.
316	VAR STEP	<u>0000</u> 0001	<u>FINE</u> COARSE	This selects the VAR speed during remote control operations. 0: The tape is played at the fine step speed. 1: The tape is played at a speed at which noise-less playback is possible in the $-0.43\times$ to $+1\times$ ( $-0.5\times$ to $+1\times$ ) range. <Notes> • The tape will be played at the speed given in parentheses in the DV/DVCAM mode. • At the 1(COARSE) setting, the phase cannot be synchronized from the editing controller.
317	VAR FWD MAX	<u>0000</u> 0001 0002 0003 0004 0005 0006 0007 0008	<u>+4.1</u> +1.85 +1 +0.75 +0.5 +0.3 +0.2 +0.1 +0.03	This sets the maximum VAR FWD speed. 0: $+4.1\times$ ( $+3.1\times$ ) speed 1: $+1.85\times$ ( $+1.85\times$ ) speed 2: $+1\times$ ( $+1\times$ ) speed 3: $+0.75\times$ ( $+0.5\times$ ) speed 4: $+0.5\times$ ( $+0.5\times$ ) speed 5: $+0.3\times$ ( $+0.3\times$ ) speed 6: $+0.2\times$ ( $+0.2\times$ ) speed 7: $+0.1\times$ ( $+0.1\times$ ) speed 8: $+0.03\times$ ( $+0.03\times$ ) speed <Notes> • The tape will be played at the speed given in parentheses in the DV/DVCAM mode. • At any speed setting other than 0 ( $+4.1\times$ ), the phase cannot be synchronized from the editing controller.
318	VAR REV MAX	<u>0000</u> 0001 0002 0003 0004 0005 0006 0007	<u>-4.1</u> -1.85 -1 -0.43 -0.3 -0.2 -0.1 -0.03	This sets the maximum VAR REV speed. 0: $-4.1\times$ ( $-3.1\times$ ) speed 1: $-1.85\times$ ( $-1.85\times$ ) speed 2: $-1\times$ ( $-1\times$ ) speed 3: $-0.43\times$ ( $-0.5\times$ ) speed 4: $-0.3\times$ ( $-0.3\times$ ) speed 5: $-0.2\times$ ( $-0.2\times$ ) speed 6: $-0.1\times$ ( $-0.1\times$ ) speed 7: $-0.03\times$ ( $-0.03\times$ ) speed <Note> The tape will be played at the speed given in parentheses in the DV/DVCAM mode.
319	JOG STEP	<u>0000</u> <u>0001</u>	<u>FINE</u> <u>COARSE</u>	This selects the JOG speed during remote control operations. 0: The tape is played at the fine step speed. 1: The tape is played at a speed at which noise-less playback is possible in the $-0.43\times$ to $+1\times$ ( $-0.5\times$ to $+1\times$ ) range. <Notes> • The tape will be played at the speed given in parentheses in the DV/DVCAM mode. • At the 1(COARSE) setting, the phase cannot be synchronized from an editing controller which synchronizes the phase using the JOG command.

The underline on the setting item denotes the initial setting.

\* The Setup menu can only be displayed for the model AJ-D450.

## USER menu

### <EDIT> (continued)

Item		Setting		Description
No.	Superimposed display	No.	Superimposed display	
320	JOG FWD MAX	0000 0001 <u>0002</u>	+4.1 +1.85 <u>+1</u>	This sets the maximum JOG FWD speed. 0: +4.1 × (+3.1 ×) speed 1: +1.85 × (+1.85 ×) speed 2: +1 × (+1 ×) speed <Notes> • The tape will be played at the speed given in parentheses in the DV/DVCAM mode. • At any speed setting other than 0 (+4.1 ×), the phase cannot be synchronized from an editing controller which synchronizes the phase using the JOG command.
321	JOG REV MAX	0000 0001 0002 <u>0003</u>	-4.1 -1.85 -1 <u>-0.43</u>	This sets the maximum JOG REV speed. 0: -4.1 × (-3.1 ×) speed 1: -1.85 × (-1.85 ×) speed 2: -1 × (-1 ×) speed 3: -0.43 × (-0.5 ×) speed <Note> The tape will be played at the speed given in parentheses in the DV/DVCAM mode.

The underline on the setting item denotes the initial setting.

## USER menu

### <TAPE PROTECT>

Item		Setting		Description
No.	Superimposed display	No.	Superimposed display	
400	STILL TIMER	0000 0001 0002 0003 0004 0005 0006 0007 <u>0008</u>	0.5s 5s 10s 20s 30s 40s 50s 1min <u>2min</u>	This selects the time to be taken until the unit goes into the tape protection mode when it is left standing in the stop mode. (Unit: s = second, min = minute) <Note> With the DV or DVCAM format, the maximum time which can be set is 10s even when a setting above 10s has been selected. The selection screen, however, will operate for up to 2 minutes.
401	SRC PROTECT	<u>0000</u> 0001	<u>STEP</u> <u>HALF</u>	This selects the operation during the tape protection mode when the unit is left standing in the still status in No. 400 protection mode. 0: STEP FWD. 1: HALF LOADING. <Note> When STEP FWD is selected, the unit automatically goes into the HALF LOADING mode when the total time for which the unit is left standing in the still status reaches 30 minutes (DVCPRO) or 1 minute (DV or DVCAM).
402	DRUM STDBY	0000 <u>0001</u>	OFF <u>ON</u>	This selects the drum operation in the STANDBY OFF mode. 0: The drum stops rotating. 1: The drum continues rotating.
403	STOP PROTECT	0000 <u>0001</u>	<u>STEP</u> <u>HALF</u>	This selects the operation in the tape protection mode when the unit has been left standing in the STOP mode. 0: STEP FWD 1: HALF LOADING <Note> When STEP FWD is selected, the unit is automatically transferred to the HALF LOADING mode when the total time during which it has been left standing in the STOP mode reaches 30 minutes (or 1 minute with a DV/DVCAM tape).

The underline on the setting item denotes the initial setting.

#### <Note>

In order to protect the tape and VTR helical heads, it is recommended that the Still Timer be set for automatic tape protection mode in 30 seconds or under.

# Setup menus

## USER menu

### <TIME CODE>

Item		Setting		Description
No.	Superimposed display	No.	Superimposed display	
500	VITC POS-1	0000	10L	This sets the position where the VITC signal is to be inserted. (The same line as for VITC POS-2 in 501 cannot be selected.)
		0001	11L	
		0002	12L	
		0003	13L	
		0004	14L	
		0005	15L	
		<u>0006</u>	<u>16L</u>	
		0007	17L	
		0008	18L	
		0009	19L	
		0010	20L	
501	VITC POS-2	0000	10L	This sets the position where the VITC signal is to be inserted. (The same line as for VITC POS-1 in 500 cannot be selected.)
		0001	11L	
		0002	12L	
		0003	13L	
		0004	14L	
		0005	15L	
		0006	16L	
		0007	17L	
		<u>0008</u>	<u>18L</u>	
		0009	19L	
		0010	20L	
502	VITC BLANK	0000	BLANK	This selects whether to output the VITC data to the positions selected by VITC POS-1 in 500 and VITC POS-2 in 501. 0: Data is not output. 1: Data is output.
		<u>0001</u>	<u>THRU</u>	
503*	TCG REGEN	<u>0000</u>	<u>TC&amp;UB</u>	This selects the signal to be regenerated when the time code generator (TCG) in the REGEN mode. 0: Both the time code and user bit are regenerated. 1: Only the time code is regenerated. 2: Only the user bit is regenerated.
		0001	TC	
		0002	UB	
504*	REGEN MODE	<u>0000</u>	<u>OFF</u>	This selects whether values used in the internal time code generator are preset from the front panel or remote controller or synchronized with time code values read from the tape. 0: Values are preset from the front panel or remote controller. (PRESET) 1: Values are synchronized with time code values read from the tape. (REGEN) <Note> When "1" is selected, values selected at set up menu No. 503 (TCG REGEN) are regenerated.
		0001	ON	
505*	EXT TC SEL	<u>0000</u>	<u>LTC</u>	This selects the time code to be used when an external time code is to be used. 0: The LTC of the TIME CODE IN connector is used. 1: The video signal VITC is used.
		0001	VITC	
506*	BINARY GP	<u>0000</u>	<u>000</u>	This sets the usage status of the user bit of the time code generated by the TCG. 0: NOT SPECIFIED (character set not specified) 1: ISO CHARACTER (8 bits character set based on ISO646, ISO2022) 2: UNASSIGNED 1 (undefined) 3: UNASSIGNED 2 (undefined) 4: UNASSIGNED 3 (undefined) 5: PAGE/LINE 6: UNASSIGNED 4 (undefined) 7: UNASSIGNED 5 (undefined)
		0001	001	
		0002	010	
		0003	011	
		0004	100	
		0005	101	
		0006	110	
		0007	111	

The underline on the setting item denotes the initial setting.

\* The Setup menu can only be displayed for the model AJ-D450.

## USER menu

### <TIME CODE> (continued)

Item		Setting		Description
No.	Superimposed display	No.	Superimposed display	
507	PHASE CORR	<u>0000</u> 0001	OFF ON	This selects whether to control the phase correction of the LTC generated by the TCG. 0: Phase correction control is not performed. 1: Phase correction control is performed.
508*	TCG CF FLAG	<u>0000</u> 0001	OFF ON	This selects whether the CF flag of the TCG is to ON. 0: CF flag is OFF. 1: CF flag is ON.
509	DF MODE	<u>0000</u> 0001	DF NDF	This selects the DF/NDF mode for CTL and TCG. 0: Drop frame mode. 1: Non-drop frame mode. No. 509 is valid when the CONTROL is LOCAL or LOCAL ENA of item 004 to "ENA".
510*	RUN MODE	<u>0000</u> 0001	REC FREE	This selects the time code generator run mode. 0: Generator runs only during recording. 1: Generator runs during usual operation. <b>&lt;Note&gt;</b> Even if "0" is selected, the time code generator runs during usual operation when "1" is selected at the setting menu No. 504 (REGEN MODE).
511*	TC OUT REF	<u>0000</u> 0001	V OUT TC IN	This is used to switch the phase of the time code, which is output from the TIME CODE OUT connector, for the external LTC input when the TC INT/EXT switch is at the EXT position. (In EE mode only) 0: Time code is synchronized with output video signal. 1: Time code is synchronized with external time code input.

### <VIDEO>

Item		Setting		Description
No.	Superimposed display	No.	Superimposed display	
600*	P <sub>B</sub> /P <sub>R</sub> IN LV	<u>0000</u> 0001	MII B-CAM	This selects the component input signal level. 0: MII level. 1: β cam level.
601*	INT BB SIG	<u>0000</u> 0001	OFF BB	This selects whether to generate the internal black burst signal. 0: Signal is not generated. 1: Signal is generated.
602*	INPUT C KILL	<u>0000</u> 0001	B/W AUTO	This selects color killer processing for the video input signals. 0: The signals are forcibly processed as B/W signals. 1: The signals are automatically processed.
603*	OUT VSYNC	<u>0000</u> 0001	N-VF VF	This selects whether to float the vertical sync position of the video output in order to align the video output phase with the input in the EE/record/edit modes. 0: Signals are not floated. 1: Signals are floated.
604	V-MUTE SEL	<u>0000</u> 0001	N-MUTE LOW_RF	This selects whether the video output signal is to be muted when the blank portion of the tape is detected during playback. 0: No muting (picture freezes). 1: Muting (picture turns grey).
605	CC (F1) BLANK	<u>0000</u> 0001	BLANK THRU	This selects ON or OFF for the closed capture signal in the first field. 0: Forced blanking performed. 1: Blanking not performed.

\* The Setup menu can only be displayed for the model AJ-D450.

The underline on the setting item denotes the initial setting.

# Setup menus

## USER menu

### <VIDEO> (continued)

Item		Setting		Description
No.	Superimposed display	No.	Superimposed display	
606	CC (F2) BLANK	<u>0000</u> 0001	BLANK <u>THRU</u>	This selects ON or OFF for the closed capture signal in the second field. 0: Forced blanking performed. 1: Blanking not performed.
608	FREEZE SEL	<u>0000</u> 0001	FIELD <u>FRAME</u>	This selects the freeze mode for still pictures. 0: Field freeze 1: Frame freeze <b>&lt;Note&gt;</b> When frame freeze is selected, the frame freeze mode is established even during slow motion.
611	EDH	<u>0000</u> 0001	OFF <u>ON</u>	This selects whether to superimpose EDH onto the serial output signals. 0: EDH is not superimposed. 1: EDH is superimposed. • This item setting is valid when the optional serial interface board has been installed.
612	WIDE SELECT	<u>0000</u> 0001 0002	<u>AUTO</u> WIDE NORMAL	This selects the operation to be conducted in response to the WIDE information. 0: During recording, if the Y/C input signals contain WIDE information, the WIDE information is recorded on the tape. During playback, if WIDE information is on the tape, it is added to the Y/C output signals. 1: During recording, the WIDE information is recorded on the tape regardless of whether the Y/C input signals contain the WIDE information. During playback, the WIDE information is added to the Y/C output signals regardless of whether the WIDE information is on the tape. → Forced WIDE ON 2: During recording, the WIDE information is not recorded on the tape regardless of whether the Y/C input signals contain the WIDE information. During playback, the WIDE information is not added to the Y/C output signals regardless of whether the WIDE information is on the tape. → Forced WIDE OFF <b>&lt;Note&gt;</b> This item is effective during recording at the start of the recording and during playback at all times. Therefore, when its setting has been changed during recording, the MENU contents will be changed but no change will occur in the actual operation.
613	VIN SETUP	<u>0000</u> 0001	<u>THRU</u> CUT	This selects whether the composite signal is to be recorded with setup or without setup. 0: When recording signals with no setup. 1: When recording signals with 7.5% setup. <b>&lt;Note&gt;</b> When recording composite signals, be sure to double-check whether the signals are to be recorded with or without setup.
614	VOUT SETUP	<u>0000</u> 0001	<u>THRU</u> ADD	This selects the composite output signal. 0: The signal is output without setup. 1: This signal is output with 7.5% setup.

The underline on the setting item denotes the initial setting.



## USER menu

### <AUDIO>

Item		Setting		Description
No.	Superimposed display	No.	Superimposed display	
700*	CH1 IN LV	<u>0000</u> 0001 0002 0003	4dB 0dB -20dB -60dB	This selects the audio input (CH1) reference level switching.
701*	CH2 IN LV	<u>0000</u> 0001 0002 0003	4dB 0dB -20dB -60dB	This selects the audio input (CH2) reference level switching.
703	CH1 OUT LV	<u>0000</u> 0001 0002	4dB 0dB -20dB	This selects the audio output (CH1) reference level switching.
704	CH2 OUT LV	<u>0000</u> 0001 0002	4dB 0dB -20dB	This selects the audio output (CH2) reference level switching.
713	MONI CH SEL	<u>0000</u> 0001 0002 0003	<u>AUTO 1</u> AUTO 2 AUTO 3 AUTO 4	<p>This selects the monitor output.</p> <p>0: In the tape speed range of <math>-0.43 \times (-0.5 \times)</math> to <math>+1 \times</math> normal speed, PCM AUDIO is output; at all other times, CUE is automatically output.</p> <p>1: In the PLAY mode, PCM AUDIO is output; at all other times, CUE is automatically output.</p> <p>2: In the PLAY mode, PCM AUDIO is output; in the tape speed range of <math>-0.43 \times (-0.5 \times)</math> to <math>+1 \times</math> normal speed, QUICK PCM AUDIO is output; at all other times, CUE is automatically output.</p> <p>3: In the tape speed range of <math>-0.2 \times</math> to <math>+0.2 \times</math> normal speed, QUICK PCM AUDIO is output; in the tape speed ranges of <math>-0.43 \times (-0.5 \times)</math> to <math>-0.2 \times</math> and <math>+0.2 \times</math> to <math>+1 \times</math> (excluding <math>-0.2 \times</math> and <math>+0.2 \times</math>) normal speed, PCM AUDIO is output; at all other times, CUE is automatically output.</p> <p>&lt;Notes&gt;</p> <ol style="list-style-type: none"> <li>The tape speed figures given above in parentheses apply when DV or DVCAM format tapes are used.</li> <li>PCM AUDIO complies with the AUDIO MONITOR SELECT SW setting and is set to CH1, CH2 or MIX (CH1+CH2).</li> <li>"QUICK PCM AUDIO" is a playback mode in which priority is given to aligning the video and audio phases during slowmotion playback. In this mode, the sound at <math>1 \times</math> normal speed is played back one frame at a time each time the video frame is updated. (During normal PCM AUDIO slow-motion playback, the sound is stretched out so that it is played back after the pictures.)</li> </ol>
714*	REC CH1	<u>0000</u> 0001 0002	CH1 CH2 CH1+2	<p>This selects the input signal to be recorded on the audio CH1 track.</p> <p>0: Audio input CH1 signal. 1: Audio input CH2 signal. 2: Mixed audio input CH1 and CH2 signal.</p>
715*	REC CH2	<u>0000</u> 0001 0002	CH1 CH2 CH1+2	<p>This selects the input signal to be recorded on the audio CH2 track.</p> <p>0: Audio input CH1 signal. 1: Audio input CH2 signal. 2: Mixed audio input CH1 and CH2 signal.</p>

The underline on the setting item denotes the initial setting.

\* The Setup menu can only be displayed for the model AJ-D450.

# Setup menus

## USER menu

### <AUDIO> (continued)

Item		Setting		Description
No.	Superimposed display	No.	Superimposed display	
716	REC CUE	<u>0000</u> 0001 0002	<u>CH1</u> CH2 CH1+2	This selects the input signal recorded in CUE. 0: The signal selected by SETUP-MENU No. 714 is recorded on CH1. 1: The signal selected by SETUP-MENU No. 715 is recorded on CH2. 2: The signal selected by SETUP-MENU No. 714 and No. 715 are mixed and recorded on CH1 and CH2.
718	DV OUTPUT	<u>0000</u> 0001 0002	<u>ST1</u> ST2 ST1+2	This selects the AUDIO CH1 and CH2 output signals during DV or DVCAM format playback. 0: The CH1 track signals are output to CH1 and the CH2 track signals to CH2. (Only the sound during shooting is output.) 1: The CH3 track signals are output to CH1 and the CH4 track signals to CH2. (Only the audio dubbing sound is output.) 2: The mixed CH1 and CH3 track signals are output to CH1 and the mixed CH2 and CH4 track signals to CH2. (The sound during shooting and audio dubbing sound are output simultaneously.)  <Note> This item setting is valid only when the tape recorded on the four channels of the DV or DVCAM format is played back.
719	PB FADE	<u>0000</u> 0001 0002	<u>AUTO</u> CUT FADE	This selects the processing method for the audio edit points (IN point, OUT point) during playback. 0: According to the status during recording. (Setup menus No. 309, 310) 1: Forced CUT 2: Forced FADE
720	EMBEDDED AUD	<u>0000</u> <u>0001</u>	<u>OFF</u> <u>ON</u>	This selects whether to superimpose the audio data onto the serial output. 0: Data is not superimposed. 1: Data is superimposed.  <Note> This item is valid when both optional serial interface and optional digital audio interface boards have been installed.
721	LINE CH SEL	<u>0000</u> 0001	<u>PCM</u> AUTO	This selects the audio output (LINE OUT). 0: PCM AUDIO or QUICK PCM AUDIO is output. 1: Whatever is selected by SETUP-MENU No. 713 (MONI CH SEL) output.  <Note> The PCM AUDIO or QUICK PCM AUDIO output is not affected by the AUDIO MONITOR SELECT SW, and CH1 and CH2 are output independently.
722*	INT SG	<u>0000</u> 0001	<u>OFF</u> <u>ON</u>	This selects whether the internal signal is to be used for the audio input signal. 0: The internal signal is not selected. 1: The internal signal is selected.  <Note> The internal signal has a frequency of 1 kHz.
723	DV PB ATT	<u>0000</u> 0001	<u>OFF</u> <u>ON</u>	This selects the audio output level for DV format playback. 0: The audio output level is not attenuated. 1: The audio output level is attenuated (reduced).  <Notes> As indicated below, whether the setting takes effect or not depends on the size of the cassette tape used. 1. When an "L" size cassette is used The setting takes effect only when "DV" has been selected as the setting for setup menu No. 108 (FORMAT SEL). 2. When an "M" size cassette is used The setting does not take effect. 3. When an "S" size cassette is used The setting takes effect only when "DV" has been selected as the setting for setup menu No. 108 (FORMAT SEL).

The underline on the setting item denotes the initial setting.

\* The Setup menu can only be displayed for the model AJ-D450.

## USER menu

### <AUDIO> (continued)

Item		Setting		Description
No.	Superimposed display	No.	Superimposed display	
725	CUE SLOW	<u>0000</u> 0001	<u>STEP</u> LINEAR	This selects the tape travel status (CUE track playback status) during SLOW playback. 0: Priority is given to the output picture, and tape travel is set to the step feed status. 1: Priority is given to CUE track playback, and the tape travel is set to the linear status.
<p>&lt;Notes&gt; When "1" (LINEAR) has been set:</p> <ul style="list-style-type: none"> <li>• It may not be possible to achieve as clear a picture as in the STEP mode.</li> <li>• The CTL counter may not operate properly.</li> </ul>				

### <MENU>

Item		Setting		Description
No.	Superimposed display	No.	Superimposed display	
A00	LOAD	<u>0000</u> 0001 0002 0003	<u>USER2</u> USER3 USER4 USER5	This selects the user file whose contents will be loaded into USER1. 0: The USER2 file contents are loaded. 1: The USER3 file contents are loaded. 2: The USER4 file contents are loaded. 3: The USER5 file contents are loaded. <b>&lt;Note&gt;</b> When the SET button is pressed after loading, the setting will be stored in the memory. When the MENU button is pressed, the setting will not be changed.
A01	SAVE	<u>0000</u> 0001 0002 0003 0004	<u>USER2</u> USER3 USER4 USER5 LOCKED	This selects the user file into which the USER1 settings will be saved. 0: The settings are saved in USER2. 1: The settings are saved in USER3. 2: The settings are saved in USER4. 3: The settings are saved in USER5. 4: This display appears when all the user files are in the change prohibit status. <b>&lt;Notes&gt;</b> • User files whose status have been set to change prohibit cannot be selected. • When all the user files are in the change prohibit status, the "LOCKED" display appears and the contents cannot be saved.
A02	P.ON LOAD	<u>0000</u> 0001 0002 0003 0004	<u>OFF</u> USER2 USER3 USER4 USER5	This loads the contents of the selected user file into USER1 and it starts operation with the USER1 settings when the power is turned on. 0: Operation is started with the settings of the previously set user file. 1: The contents of USER2 are loaded into USER1 and operation is started with the USER1 settings. 2: The contents of USER3 are loaded into USER1 and operation is started with the USER1 settings. 3: The contents of USER4 are loaded into USER1 and operation is started with the USER1 settings. 4: The contents of USER5 are loaded into USER1 and operation is started with the USER1 settings.
A03	MENU LOCK	<u>0000</u> 0001	<u>OFF</u> ON	This selects whether to set or release the user file (USER2 – USER5) lock mode. 0: The lock is released (changes can be made). 1: The lock is set (changes are prohibited). <b>&lt;Note&gt;</b> The lock cannot be set for USER1.

The underline on the setting item denotes the initial setting.

#### <Notes>

- No. A00 (LOAD), No. A01 (SAVE) and No. A02 (P.ON LOAD) are the menu items which can be set only for USER1. They are not displayed with the USER2 – USER5 files.
- No. A03 (MENU LOCK) is the menu item which can be set only for the USER2 – USER5 files. It is not displayed with USER1.

# Time code/user bit

---

## Time code

The time code is used when the time code signal generated by the time code generator (time code signal generator) is to be recorded on the tape, its values are to be read by the time code reader (time code signal reader), and the absolute position of the tape is to be displayed in increments of hours, minutes, seconds and frames.

The time code is written in the sub-code area (data area) of the helical track. This enables insert editing to be conducted independently using the time code alone. In addition, the VTR's playback speed can be read from the stop mode to slow-motion playback up to high-speed play (approx. 100X normal speed).

The time code values are indicated using the display and superimpose functions.

TCR 00 : 07 : 04 : 24  
          ↑      ↑      ↑      ↑  
      Hours | Minutes Seconds Frames

**<Note>**

Time code reader values normally appear on the superimposed display.

Values appear as shown below on the front display.

Playback: Time code reader values

REC, EE: Time code generator values

Time code generator values can be checked when the REC button is pressed even during playback.

## User bit

“User bit” refers to the 32-bit (8-digit) data frame among the time code signals which has been released to users. It enables operator numbers values to be recorded.

The alphanumeric characters which can be used for the user bit are the figures 0 to 9 and the letters A to F.

# Recording internal/external time codes

---

## 1. Setting the internal time code

- 1** Place the VTR in the stop mode.
- 2** Set the CTL/TC/UB switch to TC.
- 3** Set the TC INT/EXT switch to INT. (Internal time code selected)
- 4** Set the RUN MODE. (setup menu No. 510)  
**REC (RUN):** The time code runs at the same time as the recording proceeds.  
**FREE (RUN):** The time code runs in the same way as the time regardless of the VTR's operation.
- 5** Set the REGEN MODE. (setup menu No. 504)  
**ON (REGEN):** Continuity is maintained with the recorded time code before editing. (Detailed settings are also possible using the menu settings. See the menu items below.)  
Setting menu No. 503 (TCG REGEN)  
**OFF (PRESET):** Recording starts from the value set with the TC PRESET button.
- 6** Set the TC PRESET button.  
Use the TC PRESET button to set the start number of the time code or user bit.
  - 1** The leftmost digit flashes.  
Align the flashing light and the digit to be set with the cursor buttons (◀, ▶).
  - 2** Press the cursor button ▲ or ▼ to change the value.  
Each time the button is pressed, the number changes. The setting range is given below.
    - **When using the time code and user bit in real time**  
00:00:00:00 – 23:59:59:29
    - **User bit**  
00 00 00 00 – FF FF FF FF
  - 3** Repeat steps 1 and 2 to change the value.
  - 4** When the setting of the start number is completed, press the SET button. In the FREE RUN mode, the time code now starts running.
  - 5** Proceed with the recording or editing.

## 2. Setting the external time code (TC switch → EXT)

- 1** Place the VTR in the stop mode.
- 2** Set the TC/CTL/UB switch to TC.
- 3** Set the TC INT/EXT switch to EXT. (External time code selected)
- 4** Setup menu No. 505 (EXT TC SEL) can be set as follows.  
**LTC:** The LTC signal input to the TIME CODE IN connector (BNC) on the rear jack panel is recorded as the time code.  
**<Note>** The LTC signal must be synchronized with the video signal.  
**VITC:** The input video signal's VITC is recorded as the time code.

# Reproducing the time code/user bit

---

- 1** Place the unit in the stop mode.
- 2** Set the CTL/TC/UB switch to TC or UB.  
**TC:** The time code is displayed.  
**UB:** The user bit is displayed.
  - When it is no longer possible to read the time code, it is interpolated using the CTL signal.
- 3** Press the PLAY button.  
Playback now commences, and the time code appears on the display.  
When setup menu No.006 (SUPER) is ON, the time code value is superimposed onto the video signal from the VIDEO OUT 3 connector.

## <Notes>

- The colon between the seconds and frames changes to a period when the drop frame time code is read.
- When the time code signal cannot be read, the time code is automatically interpolated by the CTL signal.

The superimposed appears as shown below.

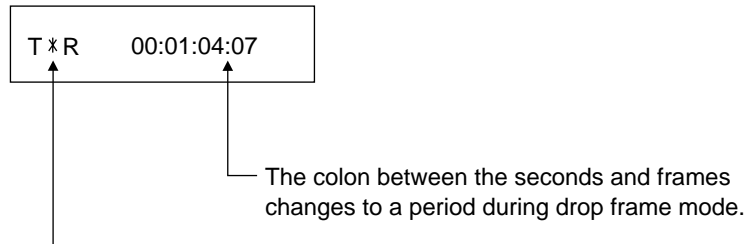

When the time code signal cannot be read,  
an asterisk (\*) is displayed on the superimposed TV monitor.

# Superimpose screen

---

The control signals, time code, etc. are displayed using abbreviations.

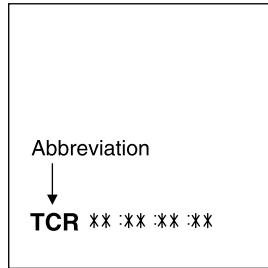

CTL = control signal  
TCR = TC time code reading  
UBR = TC user bit reading

TV monitor

## Characters displayed

The background of characters superimposed on the display can be changed using setup menu No. 007 (CHARA TYPE).

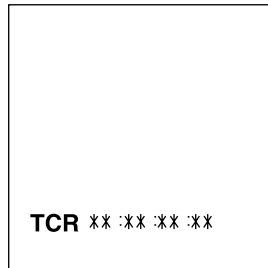

TV monitor

## Display position

The position of the characters superimposed on the display can be changed using setup menus No. 001 (CHARA H-POS) and No. 002 (CHARA V-POS).

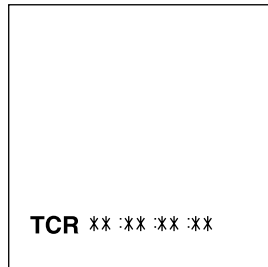

TV monitor

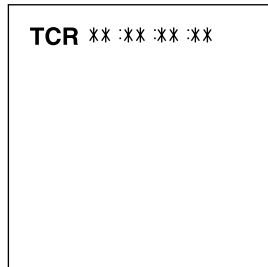

TV monitor

## Operation mode

The VTR's operation mode can also be displayed using setup menu No. 003 (DISPLAY SEL).

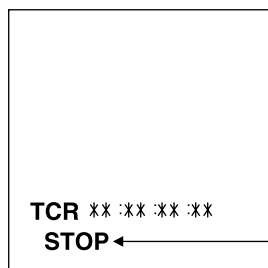

VTR operation mode

TV monitor

# Servo reference

This unit automatically selects the input video signal selected by the INPUT switch, the reference video signal supplied from the REF VIDEO input connector or the internal sync signal as the servo reference signal.

When the signal is selected, the unit's mode and servo reference stand in the relationship shown in the flowchart presented below.

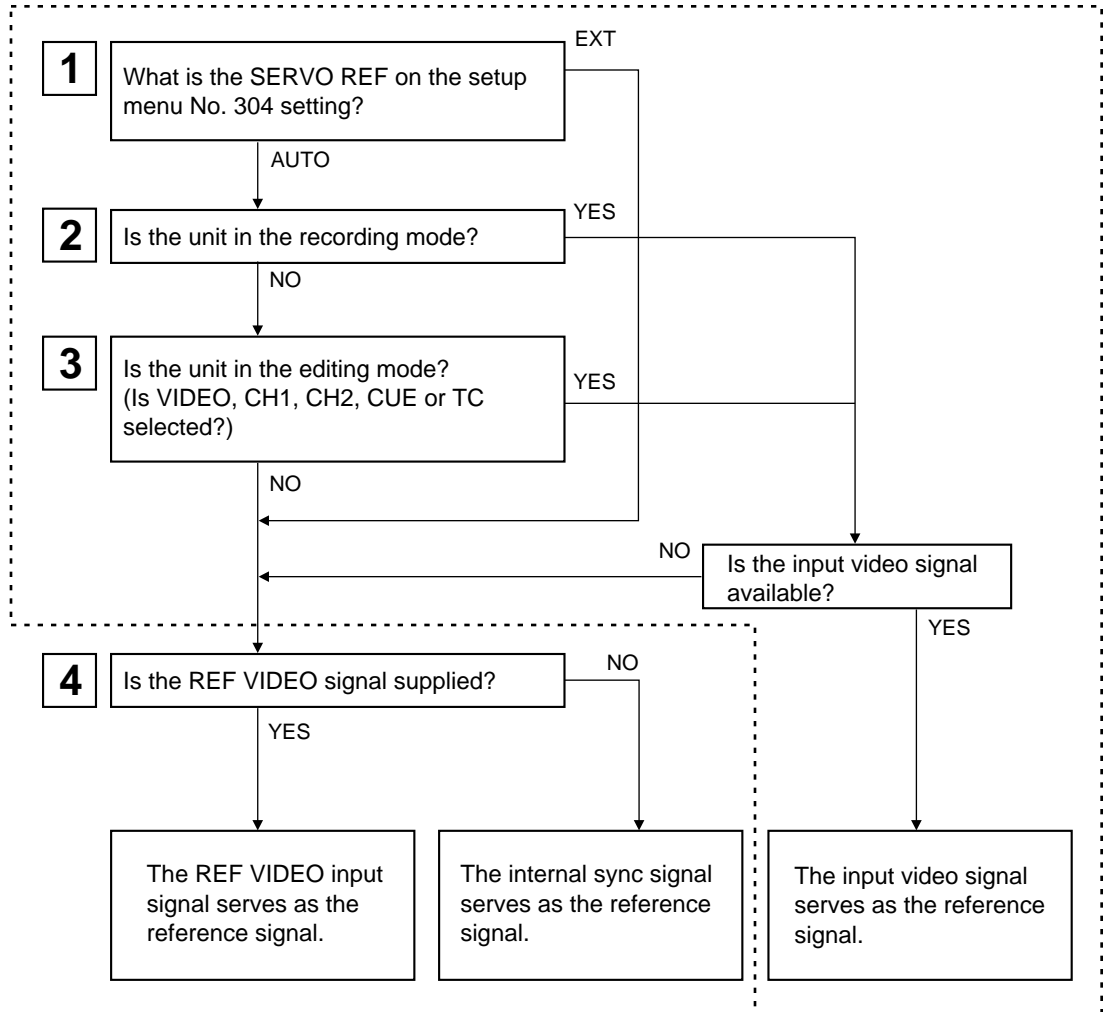

☐ Applicable only to AJ-D450.



# Servo reference setting tables

The servo reference signal is switched as shown in the tables below depending on the servo reference setting, deck mode and what input signal is available. When the mode is transferred to editing or recording/playback, the image may be disturbed and the transfer may be delayed if the references during playback and recording do not match.

## ■ During playback or special playback (AJ-D450 only)

SERVO REF on the setup menu No. 304 position	Input signal status		Reference signal (servo reference)
	VIDEO IN signal	REF IN signal	
AUTO	○	○	REF IN signal
	○	×	Internal sync signal
	×	○	REF IN signal
	×	×	Internal sync signal
EXT	○	○	REF IN signal
	○	×	Internal sync signal
	×	○	REF IN signal
	×	×	Internal sync signal

## ■ Playback or special playback (AJ-D440 only)

Input signal status REF IN signal	Reference signal
○	REF IN signal
×	Internal sync signal

## ■ During recording or editing (AJ-D450 only)

SERVO REF on the setup menu No. 304 position	Input signal status		Reference signal (servo reference)
	VIDEO IN signal	REF IN signal	
AUTO	○	○	VIDEO IN signal
	○	×	VIDEO IN signal
	×	○	REF IN signal
	×	×	Internal sync signal
EXT	○	○	REF IN signal
	○	×	Internal sync signal
	×	○	REF IN signal
	×	×	Internal sync signal

“○” denotes that the signal is supplied; “×” denotes that the signal is not supplied.

## Audio V Fade Function (AJ-D450 only)

---

When editing tapes, the edit point splicing selection (setup menu No. 309 and 310) information is recorded on the tape. This information is then sensed during playback, and V fade or cut processing is automatically performed for these sections. [However, only when the playback fade selection (No. 719) is AUTO.]

When the edit point splicing selection (setup menu No. 309 and 310) is CUT

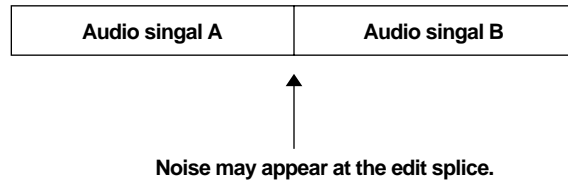

When the edit point splicing selection (setup menu No. 309 and 310) is FADE

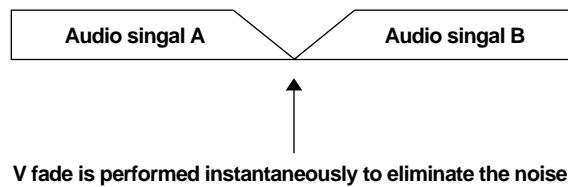

### <Notes>

- When the playback fade selection (No. 719) is CUT, cut processing is performed for all splices.
- When the playback fade selection (No. 719) is FADE, V fade processing is performed for all splices.

# Rack mounting

The unit can be mounted into a 19-inch standard rack if the optional rack-mounting adaptors (AJ-MA75P) are used. For the installation rails, it is recommended that the rail and bracket for 18" length (model number CC3001-99-0400) of CHASSIS TRAK be used. (The complete slide rail and bracket unit is not available from Panasonic) For further details, consult with your dealer.

- 1** Remove the screws on the left and right sides of the unit.
- 2** Use the removed screw to attach the inner members of the slide rails.

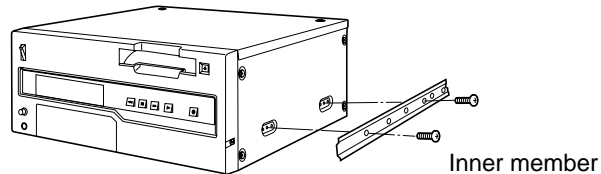

The length of the screws used is subject to restriction. If some of the mounting screws have been lost or misplaced, use screws which are less than 4" long in their place. Use four screws to secure each inner member.

- 3** Attach the outer member brackets to the rack. Check that the height is the same for the left and right brackets.
- 4** Attach the AJ-MA75P rack-mounting adaptors with included 4 screws.

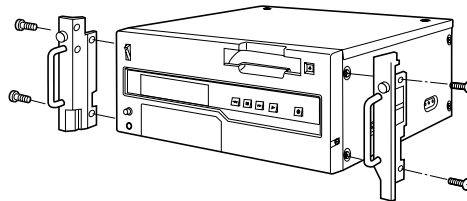

- 5** Remove the 4 rubber legs from the bottom of the unit, and install the unit in the rack. After the unit has been installed, check that it moves smoothly along the rails.

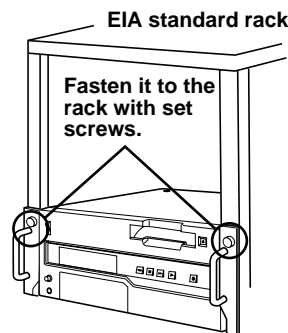

## <Notes>

- Keep the temperature inside the rack to between +41°F (5°C) and +104°F (40°C).
- Bolt the rack securely to the floor so that it will not topple over when the VTR is drawn out.

## Video head cleaning

---

This unit has an auto head cleaning function which automatically reduces the dirt on the heads. However, to further increase the unit's reliability, it is recommended that its video heads be cleaned every day.

Use the cleaning fluid designated by Panasonic.

## Condensation

---

Condensation occurs due to the same principle involved when droplets of water form on a window pane of a heated room. It occurs when the unit or tape is moved between places where the temperature or humidity varies greatly or when, for instance:

- It is moved to a very humid place full of steam or a room immediately after it has been heated up.
- It is suddenly moved from a cold location to a hot or humid location.

When moving the unit to locations such as these, leave it standing for about 10 minutes rather than switching on the power immediately.

If condensation has formed on or in the unit, the "E-20" code flashes in the counter display and the cassette tape is automatically ejected.

Keep the power supplied and simply wait until the "E-20" code goes off.

# Error messages

When a warning occurs in this unit, an error number appears at the counter display. Opening the DIAG menu will display the error description on the monitor. Also, when an abnormal operation is detected in this unit, an error number flashes on the counter display.

## DIAG menu

This display the VTR information.

VCR information includes “WARNING” information and “HOURS METER” (usage time) information. A DIAG menu appears on the monitor when the monitor is connected to the VIDEO OUT 3 connector on the connector section.

## Displaying the DIAG menu

- 1** Press the DIAG button.  
The DIAG menu screen is displayed on the monitor, and the error number is displayed on the counter display.
- 2** The “WARNING” information and “HOURS METER” information can be switched by pressing the cursor buttons (◀, ▶).
- 3** Press the DIAG button again to return to the original display.

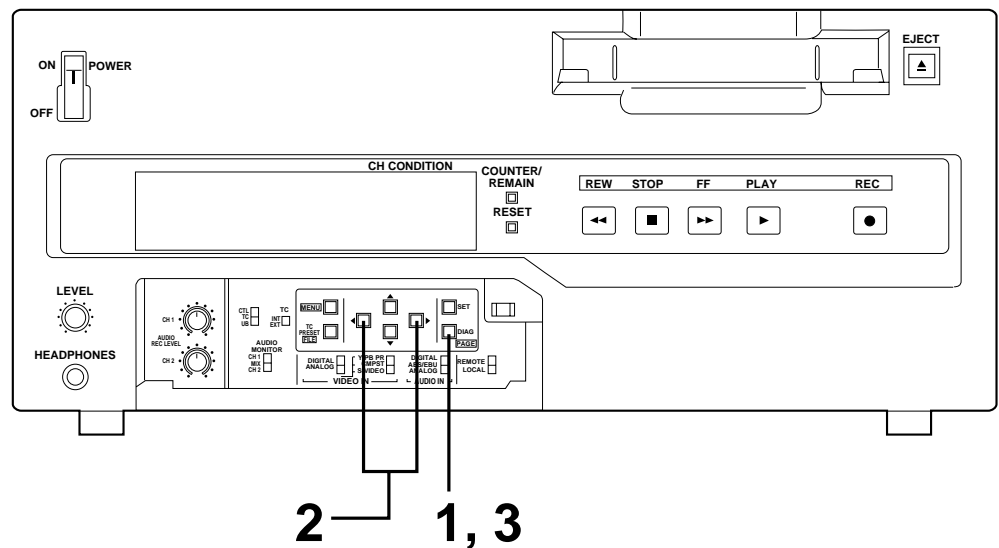

### “WARNING” information display

- A warning message is displayed on the monitor whenever a warning occurs. When warnings have not been detected, “NO WARNING” is displayed on the monitor, and “Err-” is displayed on the counter display.
- When multiple warning occur, the descriptions for each warning can be checked by using the cursor buttons (▲, ▼).

# Error messages

## Displaying the “HOURS METER” information

Press the cursor buttons (▲, ▼) to move the cursor ( \* ).

The number for the item where the cursor is located is shown on the counter display.

Item No.	Item	Description
H00	OPERATION	Displays the time that the power has been supplied in one-hour units (10-hour units at the counter display).
H01	DRUM RUN	Displays the time that the drum has been rotating in one-hour units (10-hour units at the counter display).
H02	TAPE RUN	Displays the time that the tape has been running during FF, REW, PLAY, SEARCH (JOG, VAR, SHTL), REC, and EDIT modes (except for STILL in the JOG, VAR or SHTL mode) in one-hour units (10-hour units at the counter display).
H03	THREADING	Displays the number of times for threading/unthreading in single units (10-count units at the counter display).
H11	DRUM RUN r	Displays the time that the drum has been rotating in one-hour units (10-hour units at the counter display). (Can be reset)
H12	TAPE RUN r	Displays the time that the tape has been running during FF, REW, PLAY, SEARCH (JOG, VAR, SHTL), REC, and EDIT modes (except for STILL in the JOG, VAR or SHTL mode) in one-hour units (10-hour units at the counter display). (Can be reset)
H13	THREADING r	Displays the number of times for threading/unthreading in single units (10-count units at the counter display). (Can be reset)

### <Note>

The resettable items in the “HOURS METER” information are reset by the service personnel when performing maintenance or other work.

If T&S&M is selected in the setup menu No. 003 (DISPLAY SEL), a message appears in the mode display whenever a warning or error occurs. When multiple events occur, the event with the highest priority is displayed.

Priority	Counter display and monitor display	Description
High ↑ ↓ Low	Error messages (See error message table)	When an abnormal operation is detected in this machine, an error number flashes on the counter display and an error message is displayed.
	INT SG*	If “BB” in No. 601 (INT BB SIG) in the setup menu is selected, pressing the REC button (E to E mode) will display “INT SG” for the first two seconds. In the AJ-D450, this is also displayed for the first two seconds when starting editing from the external controller.
	NO INPUT*	If there is no input signal (except for analog audio) to the connector selected using the INPUT SELECT switch, pressing the REC button (E to E mode) will display “NO INPUT” for the first two seconds. In the AJ-D450, this is also displayed for the first two seconds when starting editing from the external controller.
	Warning messages (See warning message table)	When a warning occurs in this unit, an error number appears at the counter display and warning message is displayed. When multiple warnings occur, the warning with the highest priority is displayed.

### <Note>

Items marked with an asterisk ( \* ) indicate AJ-D450 only.

## Warning

Priority	Error No.	TV monitor display*	Description	VTR operation
High ↑ ↓ Low	E-10* (Err-10)	FAN STOP	Error No. lights when a fan motor stops operating.	Continued
	E-00* (Err-00)	SERVO NOT LOCKED	Error No. lights when servo disturbances continue for 3 or more seconds during playback, recording or editing.	Continued
	E-01* (Err-01)	LOW RF	Error No. lights when envelope levels approx. 1/3 that of normal levels are detected for more than 1 sec. during playback, recording or editing.	Continued
	E-02* (Err-02)	HIGH ERROR RATE	Error No. lights when the error rate increases and correction/interpolation is performed on either the video or audio playback signal.	Continued

\* Displays when warning information is checked by pressing the DIAG button.

## AUTO OFF mode

The following error number flashes on the counter display section.

Error No.	TV monitor display	Descriptions	VTR operation (VTR measures)
E-20	DEW	When condensation is detected, the error no. display flashes, and the unit goes into EJECT mode. The drum rotates after the cassette tape is ejected to remove condensation. When the condensation has been removed, the error no. display disappears and the VTR may be used. <Notes> 1) The drum rotates as soon as condensation is detected when the unit is in EJECT mode. 2) When condensation is detected while a cassette tape is inserted, drum rotation stops, the cassette tape is ejected and the drum rotation begins again.	EJECT
E-29	FRONT LOAD MOTOR	The cassette does not move up even when 6 seconds have elapsed since the VTR was transferred to the eject mode. <Note> After inserting the cassette, the unit will go to EJECT mode if cassette is not loaded after six seconds.	Stop (POWER OFF→ON)
E-31	LOADING MOTOR	The unloading operation is not completed within 6 seconds. <Note> The unit will go to EJECT mode (unloading) if the loading operation is not completed within six seconds.	Stop (POWER OFF→ON)
E-35	SERVO CONTROL ERR	There is no response from the servo microcomputer for 1 or more seconds.	Stop (POWER OFF→ON)
E-36	SERVO ERROR	Only the servo microcomputer was reset in an instantaneous power failure.	Stop (POWER OFF→ON)
E-37	SERVO COMM ERROR	The servo microcomputer does not follow the instructions of the system control micorcomputer even when 10 seconds have elapsed.	Stop (POWER OFF→ON)

## Error messages

Error No.	TV monitor display	Descriptions	VTR operation (VTR measures)
E-51	FRONT LOAD ERROR	The take-up reel has been rotating idly for a fixed period of time while the start/end processing operation during loading (half position) is being performed.	Stop (POWER OFF→ON)
E-52	W-UP REEL NOT ROTA	After the cassette has been inserted, the tape take-up reel has not wound up the tape while the total tape amount is not detected and while the tape is traveling.	Stop (POWER OFF→ON)
E-53	WINDUP ERROR	After the total tape amount has been detected, the amount of tape wound up on the take-up reel and the amount of tape supplied by the supply reel differ to an abnormal extent while the tape is traveling.	Stop (POWER OFF→ON)
E-55	UNLOAD ERROR	The tape has not been wound up during unloading.	Stop (POWER OFF→ON)
E-57	S-FF/REW TIMEOVER	The start/end processing operation is not completed even after 10 or more seconds have elapsed.	Stop (POWER OFF→ON)
E-59	DRUM ROTA TOO SLOW	The cylinder motor speed is abnormally low.	Stop (POWER OFF→ON)
E-60	DRUM ROTA TOO FAST	The cylinder motor speed is abnormally high.	Stop (POWER OFF→ON)
E-61	CAP ROTA TOO SLOW	The capstan motor speed is abnormally low.	Stop (POWER OFF→ON)
E-64	S REEL TOO FAST	The supply reel motor speed is abnormally high.	Stop (POWER OFF→ON)
E-67	T REEL TOO FAST	The tape-up reel motor speed is abnormally high.	Stop (POWER OFF→ON)
E-69	T REEL TORQUE ERR	An abnormal torque applied to the take-up reel motor is detected.	Stop (POWER OFF→ON)
E-70	S REEL TORQUE ERR	An abnormal torque applied to the supply reel motor is detected or if an abnormal current flowing to the current-sensing resistor is detected.	Stop (POWER OFF→ON)
E-71	CAP TENSION ERROR	An abnormal tension at the supply side is detected in the capstan mode.	Stop (POWER OFF→ON)
E-72	REEL TENSION ERROR	An abnormal tension at the supply side is detected in the reel mode.	Stop (POWER OFF→ON)
E-73	REEL DIR UNMATCH	The reel motor at the take-up side is running in the reverse direction.	Stop (POWER OFF→ON)
E-FF	E-FF	Tape start and end are detected simultaneously during loading or after loading is completed.	Stop (POWER OFF→ON)



# RS-232C interface

## 1. Introduction

(1) The VTR can be operated by commands when the RS-232C interface is used.

(See command table on page 60 – 62.)

(2) Conditions for acknowledging commands from RS-232C interface

The front panel REMOTE/LOCAL switch must be at REMOTE.

The setup menu item No. 204 “RS232C SEL” must be ON.

If the above conditions are not met, [ACK] + [STX]ER001[ETX] is returned to the external unit.

Whether the [ACK] code is returned depends on the setting which has been selected for setup menu item No. 209 “RETURN ACK”.

## 2. Hardware specifications

### External interface specifications

#### 1) Connector specifications

Connector: D-SUB 25-pin (straight cable supported)

Pin No.	Signal	Circuit name	Description
1	FG	Protective ground	Frame ground
2	TXD	Transmitted data	Data is received from PC.
3	RXD	Received data	Data is sent to PC.
4	RTS	Request to send	Shorted with pin 5.
5	CTS	Clear to send	Shorted with pin 4.
6	DSR	Data set ready	+ voltage output after communication enable status
7	SG	Signal ground	Signal ground
20	DTR	Data terminal ready	No processing

#### 2) Example of connection with controller (PC)

##### ■ Using straight cable with D-SUB 25-pin connectors

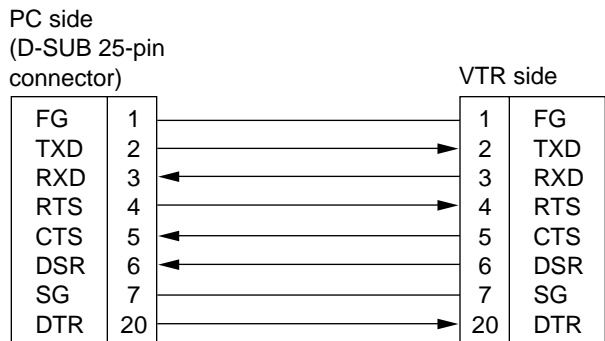

##### ■ Using straight cable with D-SUB 9-pin connectors and 25-pin connectors

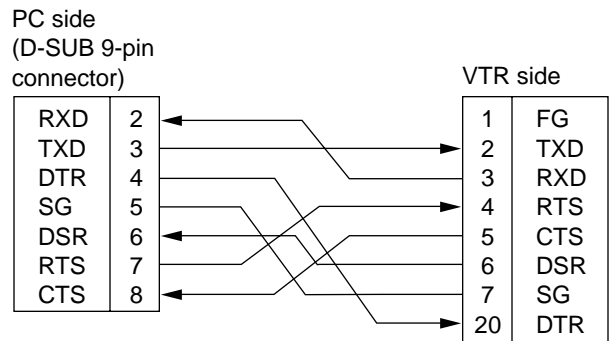

# RS-232C interface

## 3. Software specifications

### Protocol

#### 1) Communication parameters

Communication system	Asynchronous, full duplex
Communication speed	300/600/1200/2400/4800/ <u>9600</u>
Bit length	7 bit/ <u>8 bit</u>
Stop bit	<u>1 bit</u> /2 bit
Parity bit	<u>NONE</u> /ODD/EVEN
ACK code	ACK code returned/ <u>ACK code not returned</u> <b>&lt;Note&gt;</b> The ACK code is what is returned from the VTR to the controller when data has been successfully sent from the controller.

The underlining indicates the factory settings.

Any changes to the settings can be made using the setup menu items listed below.

Communication parameter	Setup menu item
Communication speed	No. 205 BAUD RATE
Bit length	No. 206 DATA LENGTH
Stop bit	No. 207 STOP BIT
Parity bit	No. 208 PARITY
ACK code	No. 209 RETURN ACK

#### 2) Send format [controller (PC) → VTR]

##### ■ Data format

[STX] [command] [:] [data] [ETX]

02h XX XX XX 3Ah XX-XX 03h ←(ASCII code: symbols, numbers upper-case letters)

20h<XX<7Fh

- [command]: Command identifier; a 3-byte identifier (ASCII code: symbols, numbers, upper-case letters) is sent as the command.
- [:]: This code serves as a delimiter between the command and data.
- [data]: Data (ASCII code: symbols, numbers, upper-case letters) can be added in the number of bytes required.

##### ■ Outline of send procedure from controller

1. The send command starts with STX (start of text = 02h). The command is then identified by COMMAND which follows and the data is added as required.  
The format ends with ETX (end of text = 03h).
2. When a different command is to be sent, a response is awaited from the VTR, and then the command is sent. (See page 59.)
3. If STX is sent again before ETX is sent, the receive data buffer inside the VTR is cleared. A command error is returned to the controller, and the data is newly processed with STX which was received again at the head.

---

### 3) Return format [VTR → controller (PC)]

The following responses are made to the command. If necessary, more than one response is made.

#### ■ When the communication has terminated normally

1. The receive completion message is returned.

[ACK]  
06h

2. The execution completion message is returned.

[STX] [command] [data] [ETX]  
02h XX XX XX XX-XX 03h

- [command]: This is the message (data) which is returned or the execution completion message identifier.
- [data]: This is the data to be returned. It can be omitted.

Example:      Send command              Return message (data)  
                 [STX] OPL [ETX]      →      [ACK] [STX] OPL [ETX]

#### ■ When the communication has terminated abnormally

[NACK]  
15h

#### ■ When processing is not possible due to incorrect data or trouble in the VTR

1. The receive completion message is returned.

[ACK]  
06h

2. An error code is returned.

[STX] E R N<sub>1</sub> N<sub>2</sub> N<sub>3</sub> [ETX]  
02h Error code 03h

## 4. Error code table

ER001: Invalid command

- Unsupported command received.
- Error in command execution

ER002: Parameter error

ER102: VTR mode error (front loading motor)

ER103: VTR mode error (loading motor)

ER104: VTR mode error (drum, capstan system)

ER105: VTR mode error (reel system)

ER106: VTR mode error (tension system)

ER108: VTR dew error

ER1FF: VTR system error

# RS-232C interface

## 5. Command table

### (1) Commands relating to operation control

<Notes>

- As for the return (completion) message, [ACK] is first returned when data is received, and the execution message is subsequently returned. It is only the execution message which is listed in this table.
- In the case of commands not listed in the table, ER001 (invalid command) is returned after [ACK] has been returned.

VTR operation	Send command	Return (completion) message	Supplementary notes
STOP	[STX] OSP [ETX]	[STX] OSP [ETX]	This command is for stopping the tape travel. The resulting output picture and sound statuses differ according to the settings selected for the setup menu No. 111 (STOP EE SEL).
EJECT	[STX] OEJ [ETX]	[STX] OEJ [ETX]	This command is for ejecting the cassette tape. The resulting output picture and sound statuses differ according to the settings selected for the setup menu No. 109 (EJECT EE SEL).
PLAY	[STX] OPL [ETX]	[STX] OPL [ETX]	This command is for starting playback.
REWIND	[STX] ORW [ETX]	[STX] ORW [ETX]	This command is for rewinding the tape. The resulting output picture and sound statuses differ according to the settings selected for the setup menu No. 110 (F/R EE SEL). The maximum tape speed differs according to the setting selected for setup menu No. 102 (FF. REW MAX).
FAST FORWARD	[STX] OFF [ETX]	[STX] OFF [ETX]	This command is for fast forwarding the tape. The resulting output picture and sound statuses differ according to the settings selected for the setup menu No. 110 (F/R EE SEL). The maximum tape speed differs according to the setting selected for setup menu No. 102 (FF. REW MAX).
REC*	[STX] ORC [ETX]	[STX] ORC [ETX]	This command is for starting the recording.
SHTL FORWARD	[STX] OSF:data [ETX]	[STX] OSF [ETX]	This is the forward direction shuttle command.  data = n: speed data 0: STILL 1: × 0.03 (DVCPRO), × 0.03 (DV, DVCAM) 2: × 0.1 (DVCPRO), × 0.1 (DV, DVCAM) 3: × 0.2 (DVCPRO), × 0.3 (DV, DVCAM) 4: × 0.5 (DVCPRO), × 0.5 (DV, DVCAM) 5: × 1 (DVCPRO), × 1 (DV, DVCAM) 6: × 1.85 (DVCPRO), × 1.85 (DV, DVCAM) 7: × 4.1 (DVCPRO), × 3.1 (DV, DVCAM) 8: × 9.5 (DVCPRO), × 9.5 (DV, DVCAM) 9: × 16 (DVCPRO), × 16 (DV, DVCAM) : This speed differs according to the setting selected for setup menu No. 101 (SHTL MAX). A: × 32 (DVCPRO), × 32 (DV, DVCAM) : This speed differs according to the setting selected for setup menu No. 101 (SHTL MAX).

\*Applicable only to AJ-D450.

VTR operation	Send command	Return (completion) message	Supplementary notes
SHTL REVERSE	[STX] OSR:data [ETX]	[STX] OSR [ETX]	This is the reverse direction shuttle command.
	data = n: speed data 0: STILL 1: × 0.03 (DVCPRO), × 0.03 (DV, DVCAM) 2: × 0.1 (DVCPRO), × 0.1 (DV, DVCAM) 3: × 0.2 (DVCPRO), × 0.3 (DV, DVCAM) 4: × 0.43 (DVCPRO), × 0.5 (DV, DVCAM) 5: × 1 (DVCPRO), × 1 (DV, DVCAM) 6: × 1.85 (DVCPRO), × 1.85 (DV, DVCAM) 7: × 4.1 (DVCPRO), × 3.1 (DV, DVCAM) 8: × 9.5 (DVCPRO), × 9.5 (DV, DVCAM) 9: × 16 (DVCPRO), × 16 (DV, DVCAM) : This speed differs according to the setting selected for setup menu No. 101 (SHTL MAX). A: × 32 (DVCPRO), × 32 (DV, DVCAM) : This speed differs according to the setting selected for setup menu No. 101 (SHTL MAX).		
STANDBY OFF	[STX] OBF [ETX]	[STX] OBF [ETX]	This command is setting the VTR to standby OFF.
STANDBY ON	[STX] OBN [ETX]	[STX] OBN [ETX]	This command is setting the VTR to standby ON.

# RS-232C interface

## (2) Commands relating to inquiries

<Notes>

- As for the return (completion) message, [ACK] is first returned when data is received, and the execution message is subsequently returned. It is only the execution message which is listed in this table.
- In the case of commands not listed in the table, ER001 (invalid command) is returned after [ACK] has been returned.

VTR operation	Send command	Return (completion) message	Supplementary notes
CTL/TC DATA REQUEST	[STX] QCD [ETX]	[STX] CD data [ETX]	This command is for inquiring about the counter value.  data = f w gh mm ss ff f = F w = S gh = CTL: g = SP (20h): for a plus display - (2Dh): for a minus display h = 0 – 9: hours TC: gh = 00 – 23: hours mm = 00 – 59: minutes ss = 00 – 59: seconds ff = 00 – 29: frames
STATUS REQUEST	[STX] QOP [ETX]	[STX] xxx [ETX]	This command is for inquiring about the VTR's operation mode.  xxx = OEJ: EJECT OFF: FAST FORWARD OPL: PLAY ORC: REC ORW: REWIND OSP: STOP (including the STANDBY ON) SRS: (IN/OUT) PREROLL OBF: STANDBY OFF OSF: SHTL FORWARD OSR: SHTL REVERSE OJG: JOG FORWARD/REVERSE OSW: VAR FORWARD/REVERSE EAE: AUTO EDIT EON: EDIT ON (MANUAL EDIT) EPV: PREVIEW ERV: REVIEW
ID (VTR No.) REQUEST	[STX] QID [ETX]	[STX] data [ETX]	This command is for inquiring about the VTR used.  data = AJ-D440, AJ-D450

---

### (3) Microsoft QuickBASIC sample program

```
CLS
STX$ = CHR$(&H2): ETX$ = CHR$ (&H3): NAK$ = CHR$(15): ACK$ = CHR$(&H6)
PRINT "*** RS-232C COMMUNICATION SAMPLE PROGRAM ***"
PRINT "Type Command 'QUIT' to quit."
PRINT

REM *** Communication Port Initial & Open ***
REM Port 1,9600Bps,No parity,8 bit data,1 stop bit
OPEN "COM1:9600,N,8,1" FOR RANDOM AS #1 LEN = 256

REM *** Input Command & Send Command ***
SendCmd:
INPUT "Input Command ="; SEND$
IF SEND$ = "QUIT" THEN GOTO ProgEnd
PRINT #1, STX$ + SEND$ + ETX$

REM *** Wait for Receive Command ***
WHILE LOC(1) = 0
    WAITKEY$ = INKEY$
    IF WAITKEY$ = "Q" THEN PRINT "**** Quit ****": GOTO ProgEnd
WEND

REM *** Receive Command ***
RecvCmd:
RCV$ = INPUT$(1, #1)
IF RCV$ = STX$ THEN RCV$ = "[Stx]"
IF RCV$ = ACK$ THEN RCV$ = "[Ack]"
IF RCV$ = NAK$ THEN RCV$ = "[Nak]"
IF RCV$ = ETX$ THEN BUFFER$ = BUFFER$ + "[Etx]": GOTO DispOut
BUFFER$ = BUFFER$ + RCV$
GOTO RecvCmd

REM *** Output Receive Command ***
DispOut:
PRINT "Receive Command ="; BUFFER$
PRINT
BUFFER$ = ""
GOTO SendCmd

REM *** End Program ***
ProgEnd:
CLOSE
END
```

MICROSOFT QUICKBASIC is a registered trade mark of Microsoft Corporation.

## Connector signals

### VIDEO IN

(AJ-D450 only)

SERIAL IN (DIGITAL)	BNC × 2	Active through (Option)
Y, P <sub>B</sub> , P <sub>R</sub> (ANALOG)	BNC × 3	
VIDEO IN	BNC × 2	Loop-through, 75Ω termination switch provided
REF VIDEO IN	BNC × 2	Loop-through, 75Ω termination switch provided
S1-VIDEO IN	4-pin × 1	

### VIDEO OUT

SERIAL OUT (DIGITAL)	BNC × 3	(Option)
Y, P <sub>B</sub> , P <sub>R</sub> (ANALOG)	BNC × 3	
VIDEO OUT	BNC × 3	
S1-VIDEO IN	4-pin × 1	

### AUDIO IN

(AJ-D450 only)

SERIAL IN (DIGITAL)	BNC × 2	(Option)
AUDIO IN (DIGITAL)	BNC × 1	CH1/CH2 AES/EBU format (Option)
AUDIO IN (ANALOG)	XLR × 2	CH1, CH2
TIME CODE IN	BNC × 1	

Pin No.	Signal
1	GND
2	HOT
3	COLD

### AUDIO OUT

SERIAL OUT (DIGITAL)	BNC × 3	(Option)
AUDIO OUT (DIGITAL)	BNC × 1	CH1/CH2 AES/EBU format (Option)
AUDIO OUT (ANALOG)	XLR × 2	CH1, CH2
TIME CODE OUT	BNC × 1	
MONITOR OUT	PHONO × 1	
HEADPHONES (front)	1/4" phone × 1	

### RS-422A REMOTE (9P)

#### RMOTE

Pin No.	Signal	Pin No.	Signal	Pin No.	Signal
1	FRAME GROUND	4	RECEIVE COMMON		TRANSMIT B
2	TRANSMIT A	5	—————	8	RECEIVE A
3	RECEIVE B	6	TRANSMIT COMMON	9	FRAME GROUND



## RS-232C REMOTE (25-pin D-SUB straight cable supported)

Pin No.	Abbreviation	Circuit	Description
1	FRAME GROUND	Protective ground	Frame ground
2	TxD	Transmitted data	Receives data from the PC.
3	RxD	Received data	Sends data to the PC.
4	RTS	Request to send	Shorted with pin 5.
5	CTS	Clear to send	Shorted with pin 4.
6	DSR	Data set ready	Positive power output after communication enable status
7	SG	Signal ground	Signal ground
20	DTR	Data terminal ready	No processing

## ENCODER REMOTE (15P)

Pin No.	Signal	Pin No.	Signal	Pin No.	Signal
1	_____	6	SYSTEM H	11	RET GND
2	SET UP	7	SYS.SC COARSE (2)	12	_____
3	C LEVEL	8	-12V	13	_____
4	GND	9	HUE	14	SYS.SC FINE
5	+12V	10	VIDEO LEVEL	15	SYS.SC COARSE (1)

# Specifications

## GENERAL

<b>Power supply:</b>	AC 120 V, 50 – 60 Hz
<b>Power consumption:</b>	AJ-D440; 120 W AJ-D450; 150 W

<b>Operating ambient temperature:</b>	41°F to 104°F (5°C to 40°C)
<b>Operating ambient humidity:</b>	10% to 90% (no condensation)
<b>Weight:</b>	AJ-D440; 33 lbs (15 kg) AJ-D450; 34.98 lbs (15.9 kg)
<b>Dimensions (W × H × D):</b>	16-3/4 × 6-15/16 × 16-3/8 inches (424 × 175 × 415 mm)
<b>Recording format:</b>	DVCPRO format
<b>Recording tracks:</b>	Digital video Recorded in sub-code area Time code; 2 channels Digital audio; 1 track Cue Track; 1 track Control (CTL);
<b>Tape speed:</b>	33.820 mm/sec
<b>Recording time:</b>	184 minutes (with AJ-5P92LP) 66 minutes (with AJ-P66MP)
<b>Tape:</b>	1/4-inch thin magnetic layer metal tape
<b>FF/REW time:</b>	Less than 3 min (with AJ-5P92LP) Less than 2 min (with AJ-P66MP)
<b>Editing accuracy*:</b>	±0 frame (using time code)
<b>Tape timer accuracy:</b>	±1 frame (using continuous CTL signal)
<b>Servo lock time:</b>	Less than 0.5 sec. (color framing/ standby ON)

## VIDEO

(Digital video)

<b>Sampling frequencies:</b>	Y; 13.5 MHz/Pb, Pr; 3.375 MHz
<b>Quantizing:</b>	8 bits
<b>Error correction:</b>	Reed-Solomon product code

(Digital IN/analog component OUT)

<b>Video bandwidth:</b>	Y; 30 Hz to 5.5 MHz (±1.0 dB) Pb, Pr; 30 Hz to 1.0 MHz (±1.0 dB)
<b>S/N ratio:</b>	Better than 56 dB
<b>K factor:</b>	Less than 2%

(Analog component IN/component OUT)

<b>Video bandwidth:</b>	Y; 30 Hz to 5.5 MHz (–1.5 dB to +1.0 dB) Pb, Pr; 30 Hz to 1.0 MHz (–2.0 dB to +1.0 dB)
<b>S/N ratio:</b>	Better than 55 dB
<b>K factor:</b>	Less than 2%

(Analog composite IN/composite OUT)

<b>Video bandwidth:</b>	Y; 30 Hz to 4.5 MHz (–1.5 dB to +1.0 dB)
<b>DG:</b>	Less than 4%
<b>DP:</b>	Less than 3°
<b>Y/C delay:</b>	Better than 20 ns
<b>K factor:</b>	Less than 3%
<b>S/N ratio:</b>	Better than 48 dB

(Video input connector)\*

<b>Analog component input*:</b>	BNC×3 (Y, Pb, Pr) Y; 1.0 Vp-p, 75Ω Pb, Pr; 0.486/0.7 Vp-p switchable, 75Ω (75% color bar, 7.5% setup)
---------------------------------	--

**Analog composite input\*:** BNC×2, loop-through, 75Ω on/off

**S VIDEO input\*:** S terminal (4-pin)×1  
Y; 1.0 Vp-p, 75Ω  
C; 0.286 Vp-p (burst), 75Ω

**Reference input:** Analog composite  
BNC×2, loop-through, 75Ω on/off

**Serial digital component input (option)\*:** Complies with SMPTE259M-C standard,  
BNC×2, active through

(Video output connector)

**Analog component output:** BNC×3 (Y, Pb, Pr)  
Y; 1.0 Vp-p, 75Ω  
Pb, Pr; 0.486/0.7 Vp-p switchable, 75Ω  
(75% color bar, 7.5% setup)

**Analog composite output:** BNC×3  
Video1/video2/video3 (superimpose on/off)

**S VIDEO output:** S terminal (4-pin)×1  
Y; 1.0 Vp-p, 75Ω  
C; 0.286 Vp-p (burst), 75Ω

**Serial digital component output (option):** Complies with SMPTE259M-C standard,  
BNC×3

(Video signals adjustment)

<b>Video output gain:</b>	±3 dB	} Control from ENCODER REMOTE connector
<b>Video output chroma gain:</b>	±3 dB	
<b>Video output hue:</b>	±30°	
<b>Video output setup:</b>	±15 IRE	
<b>Video output sync phase:</b>	±2 μs	
<b>Video output SC phase:</b>	±180°	

## AUDIO

(Digital audio)

<b>Sampling frequencies:</b>	48 kHz
<b>Quantizing:</b>	16 bits
<b>Frequency response:</b>	20 Hz to 20 kHz (±1.0 dB)
<b>Dynamic range:</b>	Better than 85 dB (1 kHz, emphasis OFF, "A" weighted)

**Distortion:** Less than 0.1% (1 kHz, emphasis OFF,  
standard level)

**Crosstalk:** Less than –80 dB (1 kHz, between  
2 channels)

**Wow & flutter:** Below measurable limits

**Headroom:** 20 dB

**De-emphasis:** T1=50 μs/T2=15 μs (on/off automatic)

(Cue track)

**Frequency response:** 300 Hz to 6 kHz ±3 dB

(Audio input connector)\*

**Analog input (CH1/CH2):** XLR×2, 600Ω/high impedance selectable,  
+4/0/–20/–60 dBu

**Digital input (CH1/CH2) (option):** BNC×1, AES/EBU format

**Serial digital input (option):** Complies with SMPTE259M-C, 272M  
standard (BNC)

(Audio output connector)

**Analog output (CH1/CH2):** XLR×2, low impedance, +4/0/–20 dBu

**Digital output (CH1/CH2)**

**(option):** BNC×1, AES/EBU format

**Serial digital output (option):** Complies with SMPTE259M-C, 272M  
standard (BNC)

**Monitor output:** Phono×1, 600 Ω, –8 dBV

**Headphones:** Variable level, 1/4" phone, 8Ω

## Other input/output connector

**Time code input\*:** BNC×1, 0.5 to 8 Vp-p

**Time code output:** BNC×1, 2.0 Vp-p

**RS-422A input/output:** D-sub 9-pin, RS-422A interface

**RS-232C:** D-sub 25-pin, RS-232C interface

**Encoder remote:** D-sub 15-pin

Weight and dimensions when shown are approximately.  
Specifications are subject to change without notice.

\* Items marked with an asterisk ( \* ) indicate AJ-D450 only.



---

# Panasonic

**PANASONIC BROADCAST & DIGITAL SYSTEMS COMPANY**  
DIVISION OF MATSUSHITA ELECTRIC CORPORATION OF AMERICA

**Executive Office:**

3330 Cahuenga Blvd W., Los Angeles, CA 90068 (323) 436-3500

**EASTERN ZONE:**

One Panasonic Way 4E-7, Secaucus, NJ 07094 (201) 348-7621

**Mid-Atlantic/New England:**

One Panasonic Way 4E-7, Secaucus, NJ 07094 (201) 348-7621

**Southeast Region:**

1225 Northbrook Parkway, Ste 1-160 Suwanee, GA 30024 (770) 338-6835

**Central Region:**

1707 N Randall Road E1-C-1, Elgin, IL 60123 (847) 468-5200

**WESTERN ZONE:**

3330 Cahuenga Blvd W., Los Angeles, CA 90068 (323) 436-3500

**Dallas Region:**

6226 Abington Way, Houston, TX 77008 (713) 802-2726

**No. CA/Northwest Region:**

5870 Stoneridge, #3, Pleasanton, CA 94588 (925) 416-5108

**Government Marketing Department:**

52 West Gude Drive, Rockville, MD 20850 (301) 738-3840

**PANASONIC CANADA INC.**

5770 Ambler Drive, Mississauga, Ontario L4W 2T3 (905) 624-5010

**PANASONIC SALES COMPANY**

**DIVISION OF MATSUSHITA ELECTRIC OF PUERTO RICO, INC.**

San Gabriel Industrial Park, 65th Infantry Ave., KM9.5 Carolina, Puerto Rico 00630 (787) 750-4300

## Free Manuals Download Website

<http://myh66.com>

<http://usermanuals.us>

<http://www.somanuals.com>

<http://www.4manuals.cc>

<http://www.manual-lib.com>

<http://www.404manual.com>

<http://www.luxmanual.com>

<http://aubethermostatmanual.com>

Golf course search by state

<http://golfingnear.com>

Email search by domain

<http://emailbydomain.com>

Auto manuals search

<http://auto.somanuals.com>

TV manuals search

<http://tv.somanuals.com>