

Panasonic



Digital Video Cassette Recorder

D640_P

AJ-D650_P

Operating Instructions

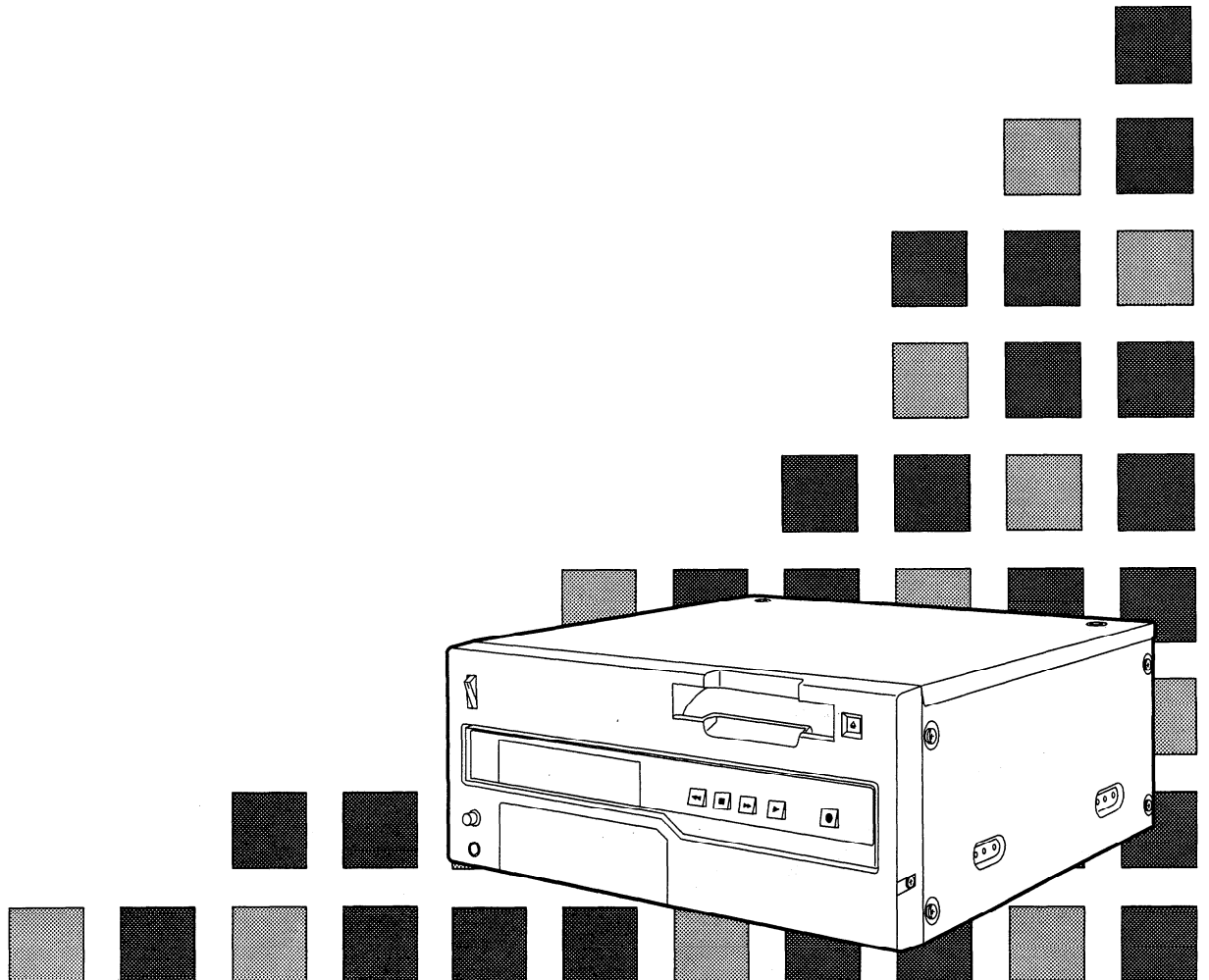

IMPORTANT

“Unauthorized recording of copyrighted television programs, video tapes and other materials may infringe the right of copyright owners and be contrary to copyright laws.”



The lightning flash with arrowhead symbol, within an equilateral triangle, is intended to alert the user to the presence of uninsulated “dangerous voltage” within the product’s enclosure that may be of sufficient magnitude to constitute a risk of electric shock to persons.



The exclamation point within an equilateral triangle is intended to alert the user to the presence of important operating and maintenance (servicing) instructions in the literature accompanying the appliance.

CAUTION:

To reduce the risk of fire or shock hazard and annoying interference, use the recommended accessories only.

WARNING:

To reduce the risk of fire or shock hazard, do not expose this equipment to rain or moisture.

CAUTION:

TO REDUCE THE RISK OF FIRE OR SHOCK HAZARD, REFER MOUNTING OF THE OPTIONAL INTERFACE BOARD TO AUTHORIZED SERVICE PERSONNEL.

FCC Note:

This device complies with Part 15 of the FCC Rules. To assure continued compliance follow the attached installation instructions and do not make any unauthorized modifications.

This equipment has been tested and found to comply with the limits for a Class A digital device, pursuant to Part 15 of the FCC Rules. These limits are designed to provide reasonable protection against harmful interference when the equipment is operated in a commercial environment. This equipment generates, uses, and can radiate radio frequency energy and, if not installed and used in accordance with the instruction manual, may cause harmful interference to radio communications. Operation of this equipment in a residential area is likely to cause harmful interference in which case the user will be required to correct the interference at his own expense.

is the safety information.

- Do not insert fingers or any objects into the video cassette holder.
- Avoid operating or leaving the unit near strong magnetic fields. Be especially careful of large audio speakers.
- Avoid operating or storing the unit in an excessively hot, cold, or damp environment as this may result in damage both to the recorder and to the tape.
- Do not spray any cleaner or wax directly on the unit.
- If the unit is not going to be used for a length of time, protect it from dirt and dust.
- Do not leave a cassette in the recorder when not in use.
- Do not block the ventilation slots of the unit.

- Use this unit horizontally and do not place anything on the top panel.
- Cassette tape can be used only for one-side, one direction recording. Two-way or two-track recordings cannot be made.
- Cassette tape can be used for either Color or Black & White recording.
- Do not attempt to disassemble the recorder. There are no user serviceable parts inside.
- If any liquid spills inside the recorder, have the recorder examined for possible damage.
- Refer any needed servicing to authorized service personnel.

Contents

General and Features.....4

Controls and their functions

Controls and their functions.....6
• Front panel.....7
• Connector area.....11
• Tapes.....14

Connections and settings

Connections.....15
• When recording/playback using 1 unit.....15
• When recording, playback and editing
with 2 units.....16
• When using an editing controller.....17
• Internal encoder adjustments.....18
• Printed circuit board.....20

Basic operations

Switching on the power/inserting the cassette.....21
STOP mode.....22
Recording.....23
Playback.....24

Setup menus

Setup (default settings).....25
Setup (setting) menus.....26
System menu.....27
Basic menu.....27
• Operation menu.....28
• Interface menu.....30
• Edit menu.....31
• Tape protect menu.....32
• Time Code menu.....33
• Video menu.....34
• Audio menu.....36

Time code

Time code/user bit.....38
Recording internal/external time codes.....39
Reproducing the time code/user bit.....40

Functions

Superimpose screen.....41
Servo reference.....42
Audio V Fade Function (AJ-D650 only).....44

Maintenance

Rack mounting.....45
Head cleaning.....46
Condensation.....46
Error messages.....47

Specifications and others

Connector signals.....49
Specifications.....51

Before operating this unit, check that all of its accessories are present and accounted for.

Power cord....1 pc

Option

- AJ-YA750P component serial interface board
- AJ-CS750P Cassette adaptor
- AJ-MA75P Rack mounting adaptor
- Digital Audio Interface Board AJ-YA655P

General and Features

This unit is a digital video cassette recorder which uses 1/4-inch tapes.

It incorporates digital compression technology so that the deterioration in picture quality and sound quality resulting from dubbing is significantly minimized compared with existing analog systems.

Furthermore, since it has a compact 4U size and light weight, the unit can be carried around or mounted in a 19-inch rack with ease.

The settings for the unit's setup can be performed while viewing the screen menus on the TV monitor. With the AJ-D650 unit, both assemble and insert editing are possible through external control.

Features

Compact size and light weight

This is a 4U size digital VTR. It can be mounted in a 19-inch rack with ease using the optional rack-mounting adaptors (AJ-MA75P).

Up to 123 minutes of recording

Two sizes of cassette tapes can be used with this unit: M cassette (max. 63 minutes) and L cassette (max. 123 minutes). The width of the tapes measures 1/4 inch to achieve a compact design.

Compatibility with consumer products

Consumer cassette tapes shot with digital cameras available on the consumer market can be played back on this unit using the optional cassette adaptor (AJ-CS750P).

<Notes>

- Slow motion playback is not possible with consumer cassette tapes.
- Consumer cassette tapes recorded in LP mode cannot be played back.

Digital slow motion/jog

The slow motion playback images can be reproduced clearly at any of the speeds given below using commands from the external controller or other such device: $-0.43/-0.3/-0.2/-0.1/-0.03/0/+0.03/+0.1/+0.2/+0.3/+0.5/+0.75$.

<Notes>

- Some noise may occur when the slow motion speed is changed.
- When slow motion playback is used, the image shakes slightly in the vertical direction.

Dialy shuttle operation is possible through the external controller

Shuttle operations enable the tape to be played back with color images at a speed of up to 60 times normal tape speed in either the forward or reverse direction.

Time codes

This unit comes with a built-in time code generator (TCG)/time code reader (TCR). In addition to the internal time code, an external time code input or input signal VITC can be recorded in the machine as the LTC time code.

Features

(continued)

Multi-function input/output interfaces

- **Analog input/output**

Component (Y, PB, PR) and composite and S-VIDEO signal input and output connectors are provided.

- **Digital audio input/output**

AES/EBU audio input/output is possible when the optional digital audio interface board (AJ-YA655P) is used.

- **Serial digital input/output**

Serial digital (SMPTE 259M-C, 272M) input/output is possible when the optional component serial interface board (AJ-YA750P) is used.

<Note>

The AJ-YA655P board, sold separately, is necessary when using serial digital audio (SMPTE 272M).

- **9-pin (RS-422A)/(RS-232C, option) remote**

The standard 9-pin serial (RS-422A) connector or an optional RS-232C connector is used.

2-channel high-sound-quality digital audio

Sound can be edited separately for two channels, and channel mixing capabilities are also available. One channel is provided for the analog cue track.

Information selected from audio CH1 and CH2 can be recorded in the cue track memory. (Set at the set up menu.)

- Cue track input and output connectors are not provided.

Automatic editing functions from the external controller (only AJ-D650)

AJ-D650 allows both assemble and insert editing from the external controller.

Menu-driven setup

The setup settings, which are conducted prior to operating the unit, are performed while viewing the setup menus either on the unit display or TV monitor.

Controls and their functions

Front panel

Counter Display Section

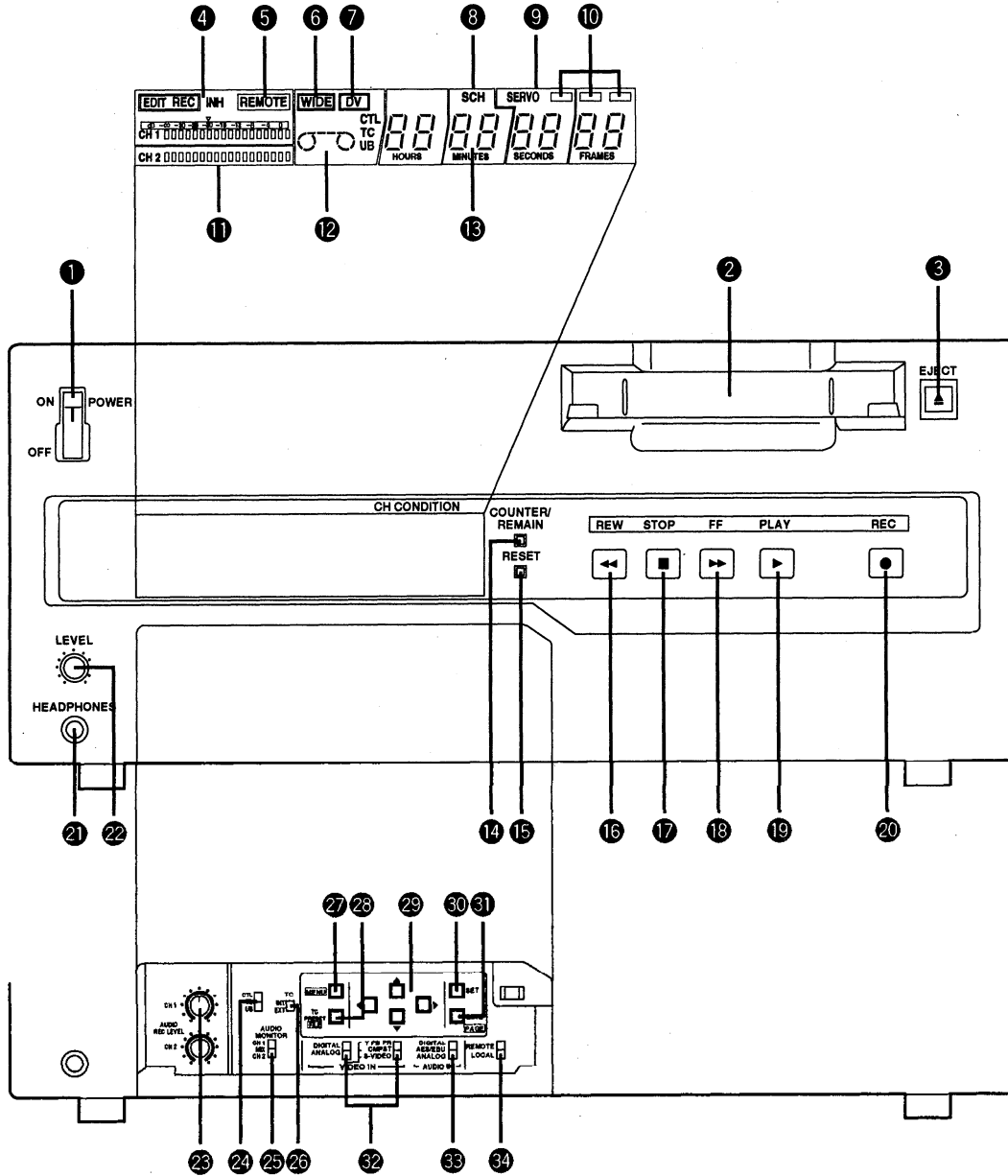

① POWER switch

When the ON side is pressed, the power is switched on, and the counter display lights up

② Cassette insertion slot

The M cassette, L cassette and consumer cassette (S cassette) with adaptor are inserted into this slot.

Consumer cassettes can be played back only.

③ EJECT button

When this is pressed, the tape is unloaded and several seconds later the cassette is automatically ejected. When the counter display indicates "CTL", the display is reset.

④ EDIT/EDIT REC/REC/REC INH lamps

EDIT: This lights when the editing mode is chosen from the 9P remote control.

EDIT REC: This lights when editing from the 9P remote control.

REC: This lights during video recording.

REC INH: This lights when the accidental erasure prevention mode has been set for the cassette. In this state, neither recording nor editing is possible.

⑤ REMOTE lamp

This lights when the REMOTE/LOCAL switch has been set to the REMOTE position.

⑥ WIDE lamp

This lights when the unit is in 16:9 wide screen mode.

⑦ Consumer cassette insertion display lamp

This lights when a cassette recorded on a consumer DV device has been inserted.

⑧ SCH lamp

This lights when the SCH of the external sync signal is within a specific range.

⑨ SERVO lamp

This lights when the drum servo and capstan servo have locked.

⑩ Channel condition lamps

One of these lamps lights in accordance with the error rate status. (Green→blue→red)

Green: This lights when the error rates for the video and audio playback signals are both acceptable.

Blue: This lights when the error rate for the video or audio playback signals has deteriorated.

Red: The playback picture will remain normal even when this lamp lights.

This lights when the video or audio signals are subject to rectification or interpolation.

⑪ Level meters

These indicate the PCM audio signal CH1/CH2.

The audio signal indicates the input signal levels during recording and EE selection, and the output signal levels during playback.

⑫ Cassette insertion display lamp

This lights when a cassette has been inserted into the unit.

⑬ Counter display

This displays the TC and CTL count values, on-screen information and other messages.

Controls and their functions (continued)

14 COUNTER/REMAIN button

This switches between the tape counter tape time indicator and the remaining tape indicator. [r ***] is displayed in the case of the remaining tape indicator. After the cassette tape is inserted, [r ---] (--- flashes) is displayed until remaining tape is calculated, and [r EJ] (EJ flashes) when ejecting the tape.

15 RESET button

When this is pressed during CTL mode, the counter returns to the 00:00:00:00 display. During menu setup, initial setting values are restored when the RESET button is pressed.

16 REW button ^{*1)}

The tape is rewound when this is pressed.

The unit goes into shuttle (SHTL) mode at -9.5 × normal tape speed when this button is pressed together with the PLAY button.

17 STOP button

When this is pressed, the tape stops traveling, and if the setup menu No. 111 (STOP EE SEL) is set to TAPE, still pictures can be monitored.

The drum continues to rotate even in the stop mode, and the tape remains in close contact with the drum.

If the stop mode continues for more than a certain period of time, the unit automatically switches to the standby OFF mode in order to protect the tape.

The stop mode is established immediately after a cassette has been inserted into the unit.

18 FF button ^{*1)}

The tape is fast forwarded when this is pressed.

The unit goes into shuttle (SHTL) mode at +9.5 × normal tape speed when this button is pressed together with the PLAY button.

19 PLAY button

Playback commences when this button is pressed.

Recording commences when the button is pressed together with the REC button.

20 REC button

Recording commences when this button is pressed together with the PLAY button.

When it is pressed during playback, search^{*2)}, fast forward or rewind, EE mode images and audio signals can be monitored for as long as it is kept depressed.

When it is pressed in the stop mode, EE mode images and sound can be monitored.

When the STOP button is pressed, the original picture and sound are restored.

*1) The FF/REW speed can be selected on the setup menu NO. 102 (FF, REW MAX), and it is set to the same speed.

*2) No guarantee is made for the audio EE mode.

21 Headphones jack

The sound being recorded, played back or edited can be monitored on stereo headphones when they are connected to this jack.

22 Volume control

This is used to adjust the headphones volume.

23 Audio recording level controls

These are used to adjust the recording levels of the analog audio signal CH1/CH2.

24 CTL/TC/UB switch

Use this switch when selecting the counter display.

CTL: Tape timer (control signal) is displayed.

TC: Time code is displayed.

UB: User bit is displayed.

25 MONITOR SELECT switch

This is used to select the audio signals output to the monitor channel.

(With the No. 713 (MONI CH SEL) setting on the setup menu, the display may not match the monitor output.)

26 INT/EXT switch

INT: For using the built-in time code generator.

EXT: For using the time external code which is input from the time code input connector or the video signal VITC. The selection is set at the setup menu.



27 MENU button

When this is pressed, the setup menu appears on the TV monitor using VIDEO OUT 3 connector, and the setup menu No. appears on the display.

When it is pressed again, the setup mode is exited and the original operating mode is restored.

28 TC PRESET (FILE) button

When this is pressed, the time code setting mode is established.

User file can be selected when the cursor buttons ( , ) are used during the setup menu mode. (For details, see setup menu items on page 26.)



29 Cursor buttons ( ,  ,  , )

These are used when setting time codes and settings at menu setup.



 ,  : These change the flashing digit in the time code indicators.

Each time they are pressed, the flashing indicator moves incrementally to the left or right.

 increments to the left;  increments to the right.

 ,  : These change the flashing digit in the time code indicators.

Each time they are pressed, the indicated value increments and decrements.

 decrements the value;  increments the value.

The flashing digit changes continuously when the button is continuously pressed.

For details about operation during setup menu mode, see setup menu items (page 25).

Controls and their functions (continued)

30 SET button

When this is pressed, the data which has been set on the setup menu is entered. After data entry, the setup mode is exited and the original operating mode is restored.

31 DIAG button

When this is pressed, VTR information is displayed. When it is pressed again, the original display is restored.

There are two types of VTR information: "HOURS METER" information and "WARNING" information. Switching between these types is enabled by pressing the cursor buttons (◀, ▶).

Indicated on the "HOUR METER" screen are the power-on time, drum rotation time, tape travel time, loading count, etc.

Indicated on the "WARNING" screen are the warnings.

32 VIDEO INPUT switch

This switches the video input signal.

DIGITAL: For selecting serial component digital video signal (SMPTE 259M-C)

ANALOG: recording.*

For selecting analog video signal recording.

Select the analog video signal as follows to correspond with the input signal.

Y PB PR: For recording an analog component video signal.

CMPST: For recording an analog composite video signal.

S-VIDEO: For recording a S-VIDEO signal.

*The optional AJ-YA750P serial interface board is necessary.

33 AUDIO INPUT switch

This switches the audio input signal.

DIGITAL: For selecting serial digital audio signal (SMPTE 272M) recording.*¹

AES/EBU: For recording a digital audio signal.*²

ANALOG: For recording an analog audio signal.

*¹ Both the optional AJ-YA750P serial interface board and the optional AJ-YA655P digital audio interface board are necessary.

*² The optional AJ-YA655P digital audio interface board is necessary.

REMOTE/LOCAL switch

This switch is set when the unit is to be controlled from an external source using the REMOTE connector or RS-232C connector (option).

REMOTE: Set to this position when controlling the unit by a device connected using the 9-pin REMOTE connector or RS-232C connector.

LOCAL: Set to this position when controlling the unit using the controls on its own operation panel.

Connector area

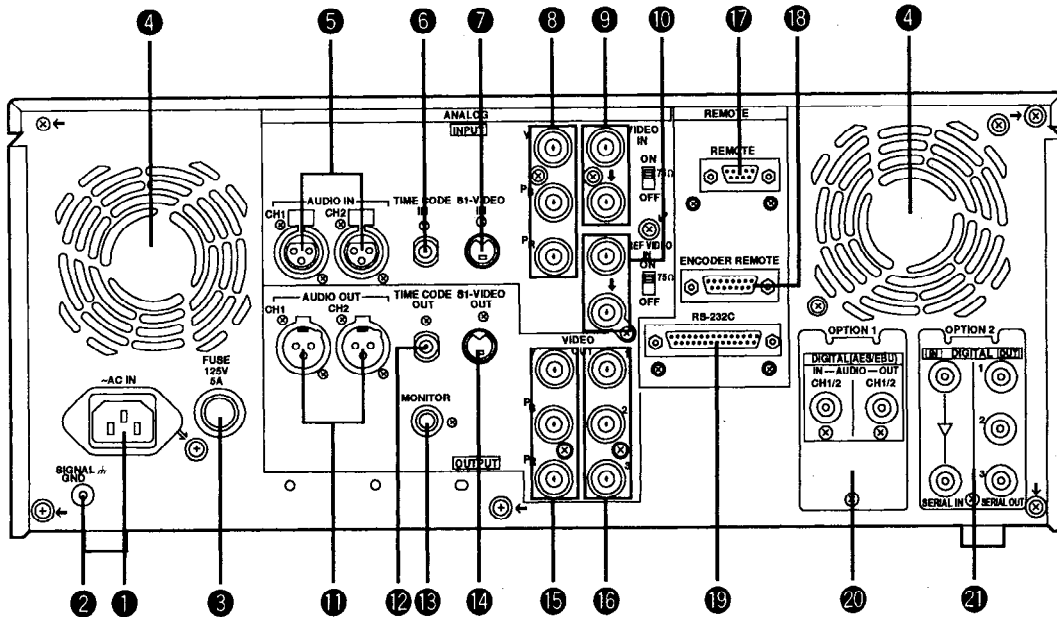

Controls and their functions (continued)

<Connector area>

① AC IN connector

This is for connecting the unit to the power outlet using the power cord provided.

② SIGNAL GND terminal

This terminal is connected to the signal unit which is connected to the unit in order to reduce noise. It is not connected to ground for safety purposes.

③ Fuse holder

This contains a fuse.

④ Fan motor

This is for cooling the unit.

The error code is displayed on the counter when trouble has caused the fan motor to stop. If the unit is still operated in the warning status, the temperature inside the deck will rise, and when it exceeds the safety temperature, all the unit's operations will be shut down.

⑤ ANALOG AUDIO IN connectors

These are the analog audio input connectors.

⑥ TIME CODE IN connector

This is the connector for recording the external time code on the tape.

⑦ S1-VIDEO IN connector

This is the S-VIDEO input connector.

⑧ ANALOG COMPONENT VIDEO IN connector

The analog component video signal is supplied to this connector.

⑨ ANALOG COMPOSITE VIDEO IN connectors and 75Ω termination switch

The analog composite video signal is supplied to these two connectors which are connected in a loop-through configuration. When the termination is required, set the switch to ON.

⑩ REF VIDEO IN connectors and 75Ω termination switch

These are the input connectors for the reference video signals. When the termination is required, set the switch to ON.

⑪ ANALOG AUDIO OUT connectors

The analog audio signals are output from these connectors.

⑫ TIME CODE OUT connector

The playback time code is output from this connector during playback.

During recording, the time code generated by the internal time code generator is output.

⑬ MONITOR OUT connector

The playback signals from the CUE track or PCM audio signal CH1/CH2 are output from this connector.

<Connector area>

14 S1/VIDEO OUT connector

This is the S-VIDEO output connector.

15 ANALOG COMPONENT VIDEO OUT connector

The analog component video signal is output from this connector.

16 ANALOG COMPOSITE VIDEO OUT connectors

The analog composite video signals are output from these connectors.

The video signal with signals superimposed on it can be output from the VIDEO OUT3 connector.

The superimpose function can be set ON or OFF on the setup menu No. 006 (SUPER).

17 REMOTE connector

The unit can be controlled from an external source by connecting an external controller.

18 ENCODER REMOTE connector

The external encoder/controller is hooked up to this connector when the video output signal and other settings are to be adjusted from an external source.

19 RS-232C connector (option)

20 DIGITAL AUDIO IN/OUT connector (optional AJ-YA655P required.)

This I/O connector is for digital audio signals which comply with the AES/EBU standard.

**21 SERIAL DIGITAL COMPONENT AUDIO/VIDEO IN/OUT connector
(optional AJ-YA750P interface board required)**

This I/O connector is for digital component audio and video signals which comply with the SMPTE 259M-C/272M standard.

The optional AJ-YA655P is required for digital audio signal output on the AJ-YA750P board.

Tapes

Three types of tapes can be used with the unit.

Type	Description
Consumer cassette (S cassette)	Tape designed exclusively for the camcorders used by consumers in general. Only playback is possible using the optional cassette adaptor. Use of Panasonic consumer DV cassette tapes is recommended. Note that inserting a cassette tape without using the cassette adaptor can damage the unit.
M cassette	Recording/playback tape with a maximum capacity of 63 minutes. (AJ-P12MP, AJ-P23MP, AJ-P33MP, AJ-P63MP)
L cassette	Recording/playback tape with a maximum capacity of 123 minutes. (AJ-P64LP, AJ-P94LP, AJ-P123LP)

Align the cassette with the center of the insertion slot and push it in gently. The cassette tape is loaded automatically.

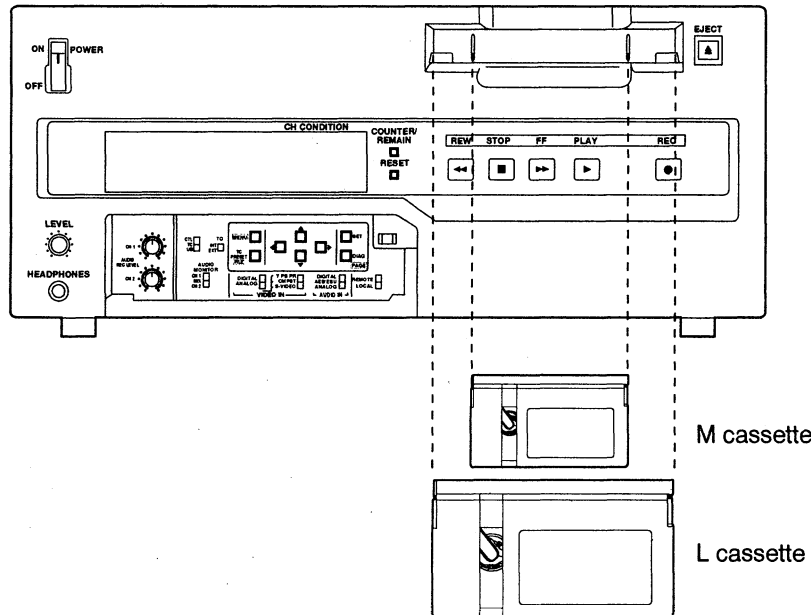

<Notes for playback of consumer DV cassette tape>

- Consumer tapes are for playback only, they cannot be recorded upon by the AJ-D640/AJ-D650.
- Consumer cassette tapes recorded in LP mode cannot be played back.
- Material recorded on consumer tape must be played back and edited to another professional VTR.
- The recording functions, recording, Tape/EE and others will not function when Consumer tape is inserted in the VTR.
- Consumer tape FF/REW speed is VTR limited to $\pm 32\times$. Slow motion playback is not possible with consumer cassette tapes.
- In order to protect the tape, the maximum STILL TIMER for consumer tape is 10 seconds, and the available time for leaving the tape in STILL mode during STEP FWD mode is set at 1 minute.
- Control (CTL) signals are not displayed when consumer tapes are used. Only the time code is displayed.

When recording/playback using 1 unit

Set the CONTROL switch on the front panel to LOCAL.

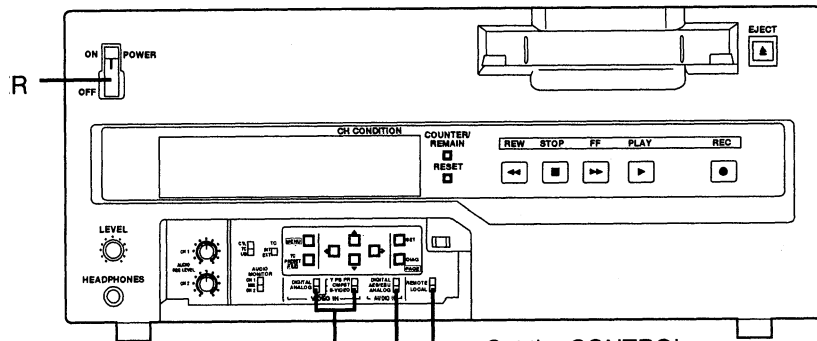
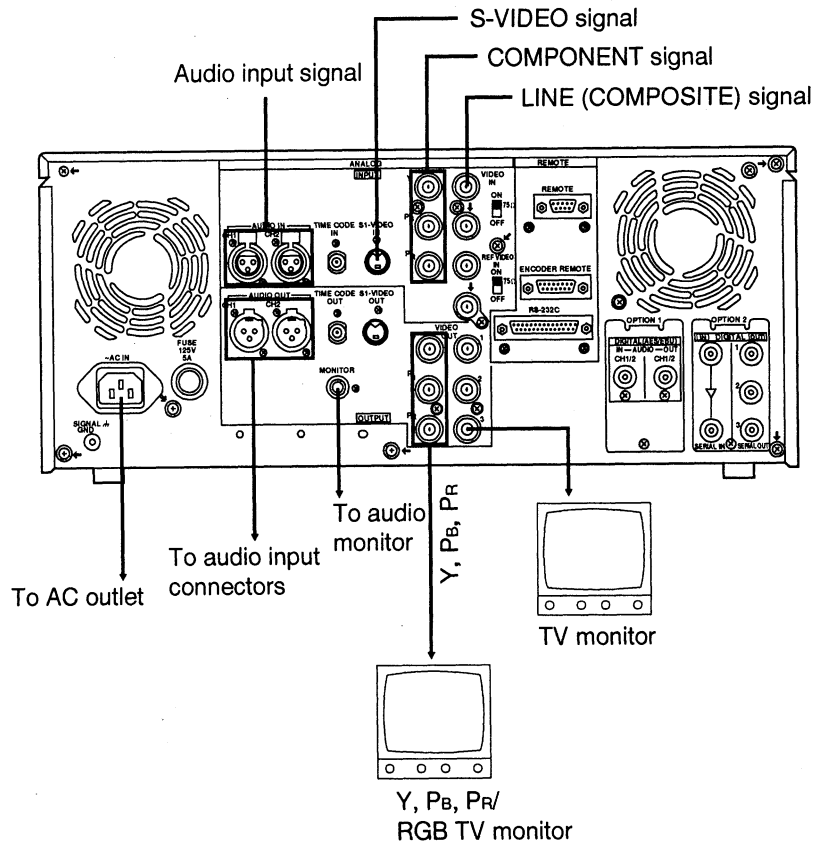

Set the VIDEO IN switch to the following position:

- "DIGITAL" for serial component digital video signal input.
- Set the VIDEO IN to ANALOG and select as following for the analog input:
- "Y PB PR" for analog component video signal input.
- "CMPST" for analog composite video signal input.
- "S-VIDEO" for S-VIDEO signal input.

Set the CONTROL switch to LOCAL.

Set the AUDIO IN switch to the following position:

- "DIGITAL" for serial component digital audio signal input.
- "AES/EBU" for digital audio signal input.
- "ANALOG" for analog audio signal input.

When recording, playback & editing with 2 units (deck to deck)

The CONTROL switch on the recorder must be set to the LOCAL position, and the CONTROL switch on the player must be set to the REMOTE position.

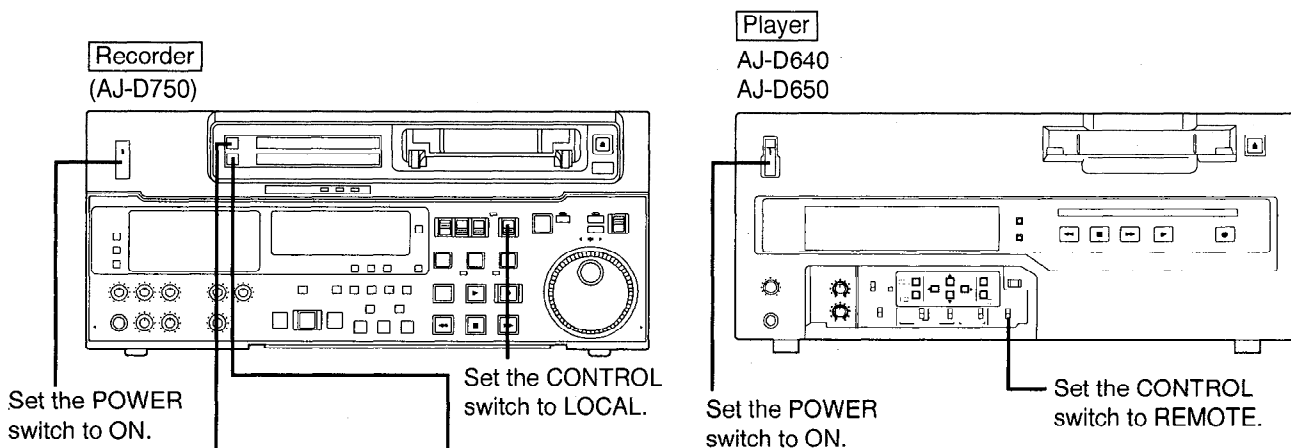
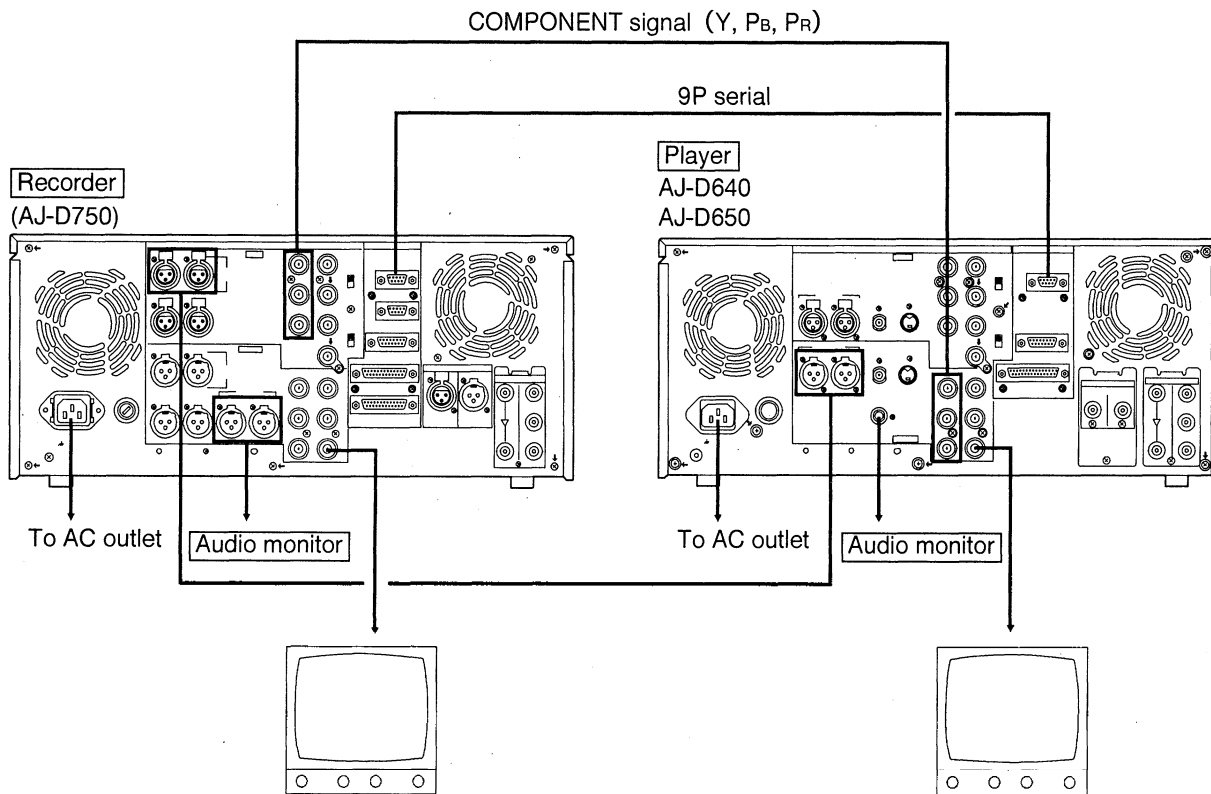

Set the VIDEO IN switch to the following position:

- "SERIAL I/F" for serial component digital video signal input.*
- "Y PB PR" for analog component video signal input.
- "CMPST" for analog composite video signal input.

Set the AUDIO IN switch to the following position:

- "SERIAL I/F" for serial component digital audio signal input.
- "AES/EBU" for digital audio signal input.
- "ANALOG" for analog audio signal input.

When using an editing controller

Basic system

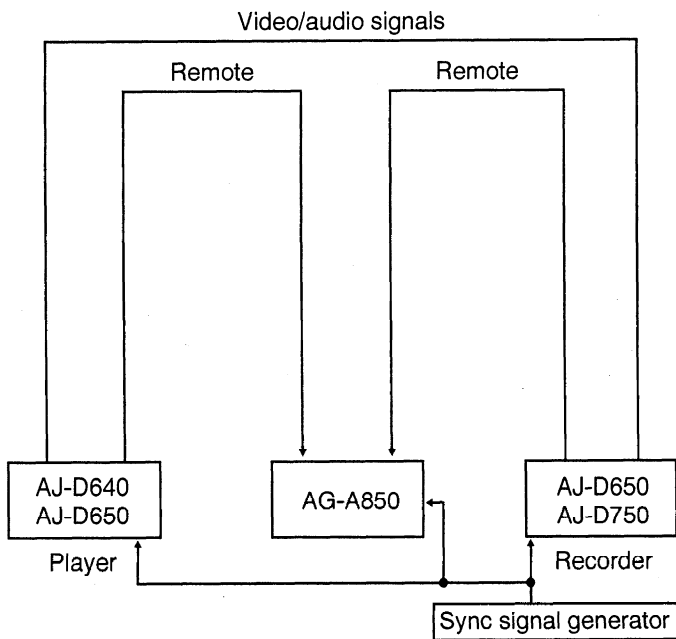

Camera/external input editing

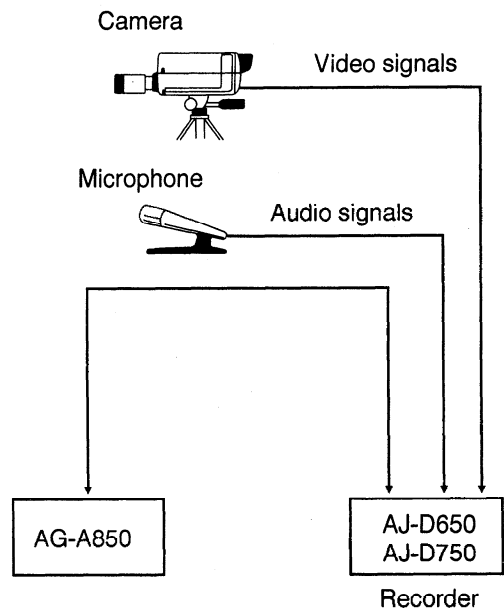

System using two players (AB roll editing)

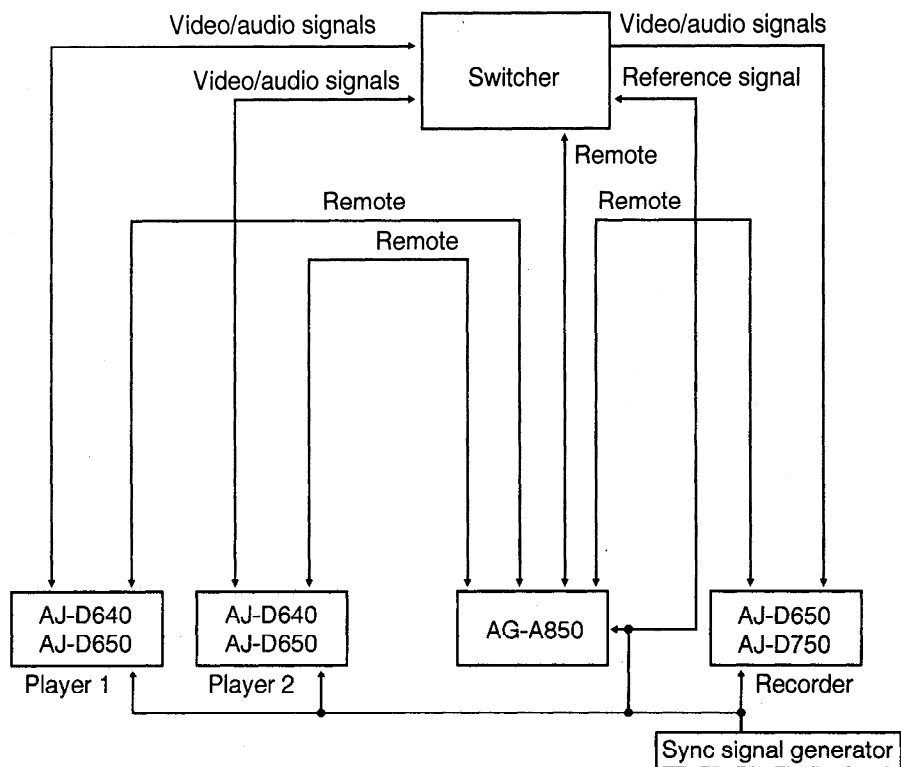

For further details, refer to the Operating instructions of the AG-A850 editing controller (optional accessory).

Internal encoder adjustments

In order to ensure error-free and accurate editing during AB roll editing (a method of editing using two source VTRs) using an editor, the ENCODER OUT controls must be adjusted after the system has been connected. (These controls must be re-adjusted each time the connecting cables are replaced or the connections are changed.)

Connect the equipment as shown in the figure below.

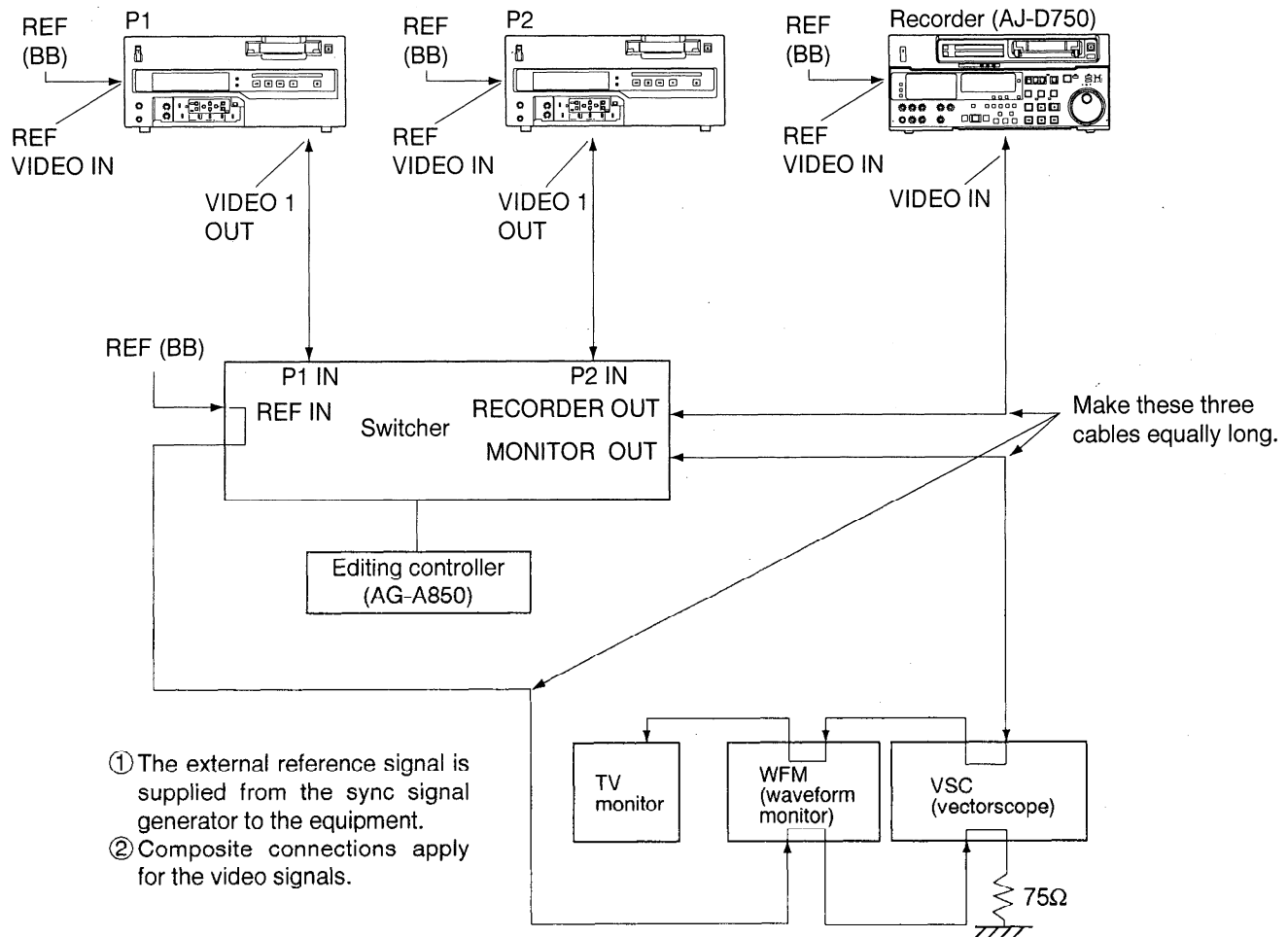

If a waveform monitor and vectorscope are not available, correct any color shifting while actually monitoring the picture on the TV monitor.

- 1** Check the connections. (see previous page.)
- 2** Select [OFF] on ENCODER SEL at the set up menu. (See page 27.)
Select [ON] to operate the internal encoder externally.
- 3** Adjust the SYSTEM PHASE.
 - 3-1** On the P1 VTR, play back a cassette tape on which standard color bar signals have been recorded.
 - 3-2** Adjust P1 VTR SYS PHASE.
Adjust the controls to the following with the waveform monitor (WFM).
 - 1) Expand WFM 0.1 μ s on the INT mode.
 - 2) Check the H SYNC position.
 - 3) In this status, select EXT mode for the WFM.
 - 4) In EXT mode, adjust the SYSTEM PHASE to H, SC COARSE, SC FINE, in this order, at the set up menu to set H SYNC to its previous position.

■ Waveform on waveform monitor

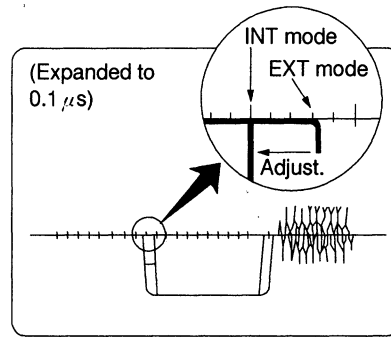

(Observe the SYNC fall.)

- 4** Adjust the connected P2 VTR in the same way.

Printed circuit board

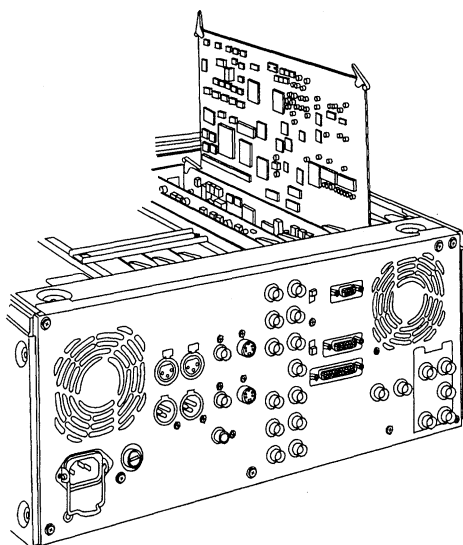

Printed circuit board	Abbr. name	Full name	Function	Factory setting
F8 board ADDA- CUE	SW1	Audio Input Impedance SW	This sets the CH1 audio input impedance. HIGH/600Ω	HIGH
	SW61	Audio Input Impedance SW	This sets the CH2 audio input impedance. HIGH/600Ω	HIGH
F4 board	SW400	Component PB/PR Output level selector	This sets the component PB/PR output level when connecting with the editor. MII : MII level BETA : β-CAM level	BETA

<Note>

Component PB/PR input levels are selected at No. 600 in the setup menu.

CAUTION:
TO REDUCE THE RISK OF FIRE OF SHOCK HAZARD, REFER CHANGE OF SWITCH SETTING INSIDE THE UNIT TO AUTHORIZED SERVICE PERSONNEL.

Switching on the power/inserting the cassette

Before starting to operate the unit, check whether the equipment has been connected properly.

- 1** Turn on the power.
Check that the error indicator is not displayed on the counter.
- 2** Insert the cassette tape.
Insert the tape at its proper position without force. (See page 14.)
- 3** Check that the STOP lamp is on.
When the tape is inserted, the drum rotates automatically, the tape is loaded and the unit goes into the stop mode.

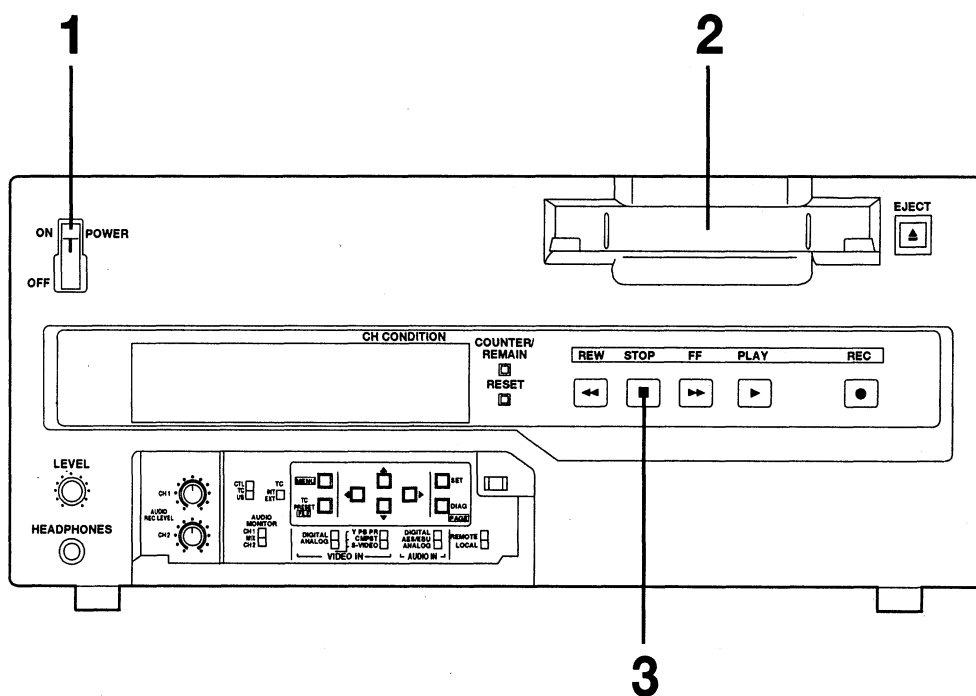

STOP mode

- 1 When the STOP button is pressed, the unit goes into the stop mode. The STOP lamp lights and the tape stops traveling.
 - In order to protect the tape, the unit goes into the standby OFF mode after the time set by setting menu No.400 (STILL TIMER) has elapsed. When the STOP, REW, FF or PLAY button is pressed, the unit will go into the appropriate mode.

Still Timer Setting

In order to protect the tape and VTR helical heads, it is recommended that the Still Timer be set for automatic tape protection mode in 30 seconds or under.

Page 32 indicates the settings for menu item 400-Still Timer set. Still Timer settings 4 and below will best protect the tape.

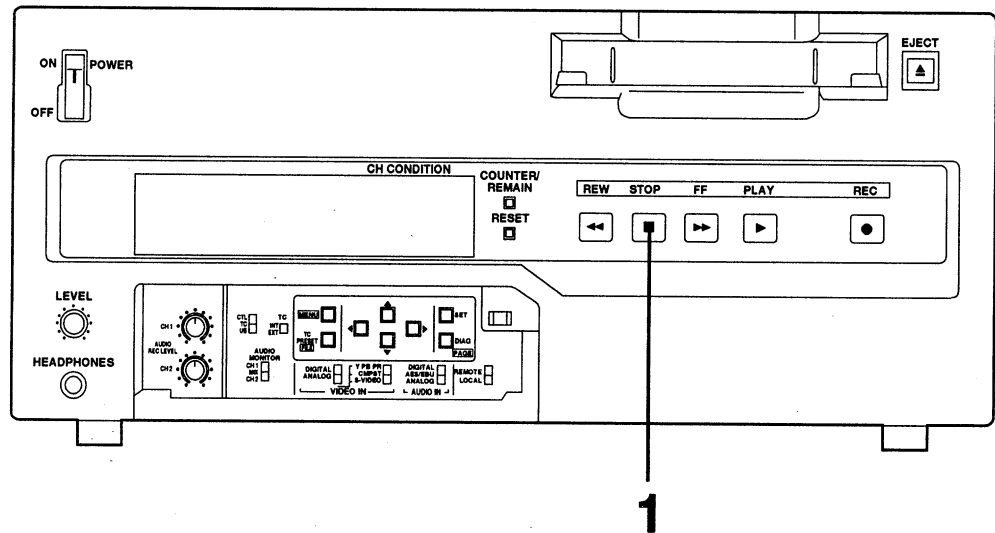

- 1** Set the accidental erasure prevention tab on the cassette tape to the “recording” position and insert the tape.
- 2** Press the STOP button to place the unit in the stop mode.
- 3** Check that the REC INHIBIT lamp is off.
- 4** Select the video and audio input signals and adjust their levels.
 - 4-1 Selecting video/audio input signals**
 - 1 Connect the signals to be recorded.
 - 2 Select the input signals using the INPUT SELECT switches on the front panel.
 - 4-2 Adjusting the audio level**

Adjust the audio input signal levels of the analog audio CH1/CH2 signals. When set at the center position, audio signals will be recorded at the proper level.
- 5** Press the PLAY button while holding down the REC button. The REC and PLAY lamps light, and recording commences.
- 6** To end the recording, press the STOP button.

Recording is ended, and the unit goes into the stop mode.

<Notes>

- Check that the SERVO lamp is lighted during recording. If it flashes or if it is off, the images played back will be disturbed.
- The sound and pictures to be recorded are offset from the playback pictures by 5 frames and recorded. When, for instance, recording sound at a particular timing while the playback pictures are monitored, the sound to be edited will be recorded at a position which is offset from the playback pictures by 5 frames.

Playback

- 1** Insert the cassette tape, and place the unit in the stop mode.
- 2** Press the PLAY button.
Regular playback is now commenced.
- 3** To end playback, press the STOP button.
The VTR now goes into the stop mode.

<Note>

- Check that the SERVO lamp is lighted during playback. If it flashes or if it is off, the images played back will be disturbed.

Setup (default settings)

The unit's major settings are performed by making selections on menus. The setting menus appear on the TV monitor when the TV monitor and VIDEO OUT 3 connector in the unit's connector area are hooked up.

Changing the settings

- 1** Press the MENU button.
The setup menu appears on the TV monitor and setup menu No. appears on the counter display. (If the setup has already been performed, the screen showing the changes made last will appear.)
- 2** Press the cursor buttons (▲, ▼) and select the item to be set.
The cursor (*) on the menu screen moves and the item No. on the display flashes.
 - When the ▼ button is pressed, the item No. is incremented for 001 → 002 → 003 → 004 → and so on; when the ▲ button is pressed, the item No. is decremented.
- 3** Press the cursor buttons (◀, ▶) at the position where the change is to be made.
The menu screen and display setting No. now flashes.
When the ▶ button is pressed, the setting No. is incremented; when the ◀ button is pressed, it is decremented.
- 4** Repeat steps 2 and 3 to change other items.
- 5** Press the SET button.
The changes are now stored in the memory.
 - To return the items to the settings established before the changes were made, press the MENU button without pressing the SET button.

To return the setup settings to the factory (initial) settings, press the RESET button while the menu is displayed.

The following message is displayed.

```
SETUP-MENU INIT SET
YES<PLAY>/NO<STOP>
```

When the PLAY button is pressed, the factory settings are restored.

<Notes>

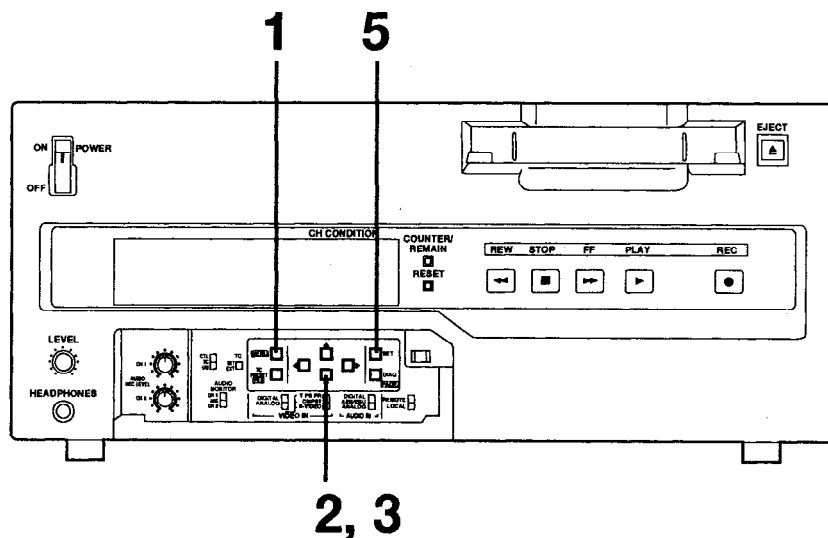

- When the RESET button is pressed to return to the factory settings, the factory settings are restored only for the user file currently being used and other user files are not affected.
- The changed SYSTEM menu contents are stored in the memory even if the MENU button is pressed.



Setup (setting) menus

This unit can store up to 5 user files (user 1 to user 5) containing different menu settings, and these files can be selected and used.

Changing the file

- 1** Press the MENU button.
- 2** Hold down the FILE button and press the cursor button  to switch to the next user file.
Hold down the FILE button and press the cursor button  to switch to the previous user file.

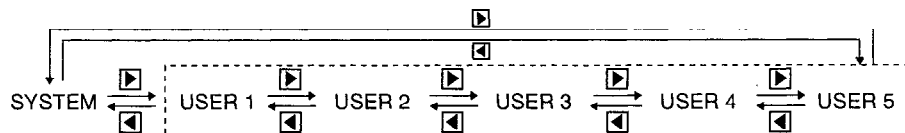

USER FILE

Each user file contains the following items.

- BASIC
- OPERATION
- INTERFACE
- EDIT
- TAPE PROTECT
- TIME CODE
- VIDEO
- AUDIO

- 3** Repeat the operation in step 2 to select the user file to be used and press the SET button. The user file is changed and stored in the memory.

<Note>

- SYSTEM menu items are not included in user files 1 to 5.
Therefore, after selecting the user file, switch to the SYSTEM file and set the SYSTEM menu items.

SYSTEM menu

<SYSTEM>

Item		Setting		Description
No.	Superimposed display	No.	Superimposed display	
00	SYS SC COAR.	<u>0000</u> 0001 0002 0003	<u>0</u> 90 180 270	System phase rough adjustment: 90° units <Note> When shipped from the factory, the setting values do not change even if setting operations are performed.
01	SYS SC FINE	0000 ⋮ <u>0127</u> ⋮ 0255	- 1 2 7 ⋮ <u>0</u> ⋮ 127	System phase fine adjustment: Total variable range:±90° or more -: advanced +: delayed
02	SYS H	0000 ⋮ <u>0112</u> ⋮ 0224	- 1 1 2 ⋮ <u>0</u> ⋮ 112	System phase adjustment: ±2μ sec (SC cycle phase) -: Advanced +: Delayed <Note> When shipped from the factory, the setting values do not change even if setting operations are performed.
00	ENCODER SEL	<u>0000</u> 0001	<u>OFF</u> ON	This selects whether the ENCODER connector functions. 0: Does not functions. 1: Functions.
10	AV PHASE	0000 ⋮ <u>0128</u> ⋮ 0255	- 1 2 8 ⋮ <u>0</u> ⋮ 127	This adjusts the audio output phase with respect to the video output: 20.8μs steps -: The audio output phase is advanced with respect to the video output. +: The audio output phase is delayed with respect to the video output.

The underline on the setting item denotes the initial setting.

USER menu

<BASIC>

Item		Setting		Description
No.	Superimposed display	No.	Superimposed display	
000	P-ROLL TIME	0000 ⋮ <u>0005</u> ⋮ 0015	0S ⋮ <u>5S</u> ⋮ 15S	This sets the preroll time which can be set from 0 to 15 seconds in 1-second increments. <Note> In the case of AJ-D640, the unit will not operate if the preroll time is set to 0 seconds when the unit is set to automatic editing (PREVIEW, AUTO EDIT COMMAND) from an external controller.
001	CHARA H-POS	0000 ⋮ <u>0005</u> ⋮ 0012	0 ⋮ <u>5</u> ⋮ 12	This sets the position of the characters on the horizontal plane for the time code and other super displays output to the VIDEO OUT 3 connector. <Note> 1. When setting this item, the DISPLAY SEL status is output to VIDEO 3 even if SUPER OFF has been set. However, when the menu is exited, operation complies with the SUPER OFF/ON setting. Also, CHARA TYPE is output to VIDEO 3 according to the status set in the menu. 2. When the DISPLAY SEL setting causes characters to extend beyond the edges of the screen, the setting value is changed so that the characters are automatically displayed in a position on the screen.

The underline on the setting item denotes the initial setting.

Setup (setting) menus

USER menu

<BASIC> (continued)

Item		Setting		Description
No.	Superimposed display	No.	Superimposed display	
002	CHARA V-POS	0000 : <u>0018</u> : 0022	0 : 18 : 22	This sets the position of the characters on the vertical plane for the time code and other super displays output to the VIDEO OUT 3 connector. <Note> 1. When setting this item, the DISPLAY SEL status is output to VIDEO 3 even if SUPER OFF has been set. However, when the menu is exited, operation complies with the SUPER OFF/ON setting. Also, CHARA TYPE is output to VIDEO 3 according to the status set in the menu. 2. When the DISPLAY SEL setting causes characters to extend beyond the edges of the screen, the setting value is changed so that the characters are automatically displayed in a position on the screen.
003	DISPLAY SEL	0000 <u>0001</u> 0002	TIME T&STA T&S&M	This selects what information is to be provided by the time code and other super displays output to the VIDEO 3 connector. 0: Time only. 1: Time and status. 2: Time, status and mode. <Note> The mode display is DVCPRO mode display during DVCPRO format and DV mode display during DV format.
004	LOCAL ENA	0000 <u>0001</u> 0002	DIS ST&EJ ENA	This selects the buttons which can be operated on the front panel when the REMOTE/LOCAL switch has been set to REMOTE. 0: No buttons can be operated. 1: Only the STOP and EJECT buttons can be operated. 2: All buttons can be operated.
005	TAPE TIMER	<u>0000</u> 0001	±12h 24h	This selects the 12 or 24 hour display for the CTL counter. 0: 12 hour display 1: 24 hour display
006	SUPER	0000 <u>0001</u>	OFF ON	This selects whether the time code and other super display which are output to the VIDEO OUT 3 connector is to be shown. 0: Not shown. 1: Shown.
007	CHARA TYPE	<u>0000</u> 0001	WHITE W/OUT	This selects the display type for the super display output to the VIDEO OUT 3 connector as well as for displays such as the setting menu, etc. 0: White characters against a black background. 1: White characters with a black border.

The underline on the setting item denotes the initial setting.

USER menu

<OPERATION>

Item		Setting		Description
No.	Superimposed display	No.	Superimposed display	
101	SHTL MAX	0000 <u>0001</u> 0002	×16 ×32 ×60	This sets the maximum speed for shuttle operations. 0: 16x normal speed 1: 32x normal speed 2: 60x normal speed <Note> During DV format, the maximum speed is 32x normal speed even when 60x is selected.

The underline on the setting item denotes the initial setting.

USER menu

<OPERATION> (continued)

Item		Setting		Description
No.	Superimposed display	No.	Superimposed display	
102	FF. REW MAX	<u>0000</u> 0001 0002	X 32 X 60 X 100	This sets the maximum speed for FF and REW operations. 0: 32x normal speed 1: 60x normal speed 2: 100x normal speed <Note> During DV format, the maximum speed is 32x normal speed regardless of this setting.
103	AUDIO MUTE	<u>0000</u> 0001	OFF ON	This sets the status until the audio signal is output when operation switches from the stop or search modes to the play mode. 0: The time until the audio is output is shortened. 1: The audio is output after the status stabilizes. <Note> When set to 0 (OFF), the sound in the initially output part is incomplete. Therefore, this setting is not recommended for broadcasts.
104	REF ALARM	<u>0000</u> 0001	OFF ON	This selects whether to warn the operator when the REF.VIDEO signal has not been connected. 0: Warning is not given. 1: Warning is given by the flashing STOP lamp.
106	PLAY DELAY	<u>0000</u> : 0015	0 : 15	This sets the play delay time in frame increments.
107	CAP. LOCK	<u>0000</u> 0001	2F 4F	This selects the capstan lock mode. 0: 2F mode 1: 4F mode
108	FORMAT SEL	<u>0000</u> 0001	DVCPRO DV	This selects the format which applies when the general purpose cassette is used. After selection, this status becomes effective only when the cassette is inserted after ejection. 0: DVCPRO mode 1: DV mode <Notes> Take care not to insert a tape whose format is the reverse of the one selected since the following trouble as well as playback trouble will occur. 1. A recording operation is initiated if a DV cassette is inserted when the DVCPRO mode is selected. No guarantees can be made for performance, etc. Conversely, no recording can be conducted if a DVCPRO cassette is inserted when the DV mode is selected. 2. The REMAIN display loses its accuracy. 3. The accuracy of the slowdown position near the start and end of the tape is lost.
109	EJECT EE SEL	<u>0000</u> 0001	EE BLACK	This selects whether EE mode or BLACK is to be used during EJECT status 0: EE mode 1: Video blackens, audio mutes.
110	F/R EE SEL	<u>0000</u> 0001	EE TAPE	This selects whether EE mode or playback mode is to be used during FF/REW operations. 0: EE mode 1: Playback mode
111	STOP EE SEL	<u>0000</u> 0001	EE TAPE	This selects whether EE mode or playback mode is to be used during stop mode. 0: EE mode 1: Playback mode <Note> The STAND-BY OFF mode complies with the above selection. When TAPE is selected, however, the video becomes grey.

The underline on the setting item denotes the initial setting.

Setup (setting) menus

USER menu

<OPERATION> (continued)

Item		Setting		Description
No.	Superimposed display	No.	Superimposed display	
112	AUTO REW	<u>0000</u> 0001	OFF <u>ON</u>	This selects whether to rewind the tape automatically to the tape start when the tape end is detected. 0: The tape stops at the tape end. 1: The tape is rewound to the tape start.
113	MEMORY STOP	<u>0000</u> 0001	OFF <u>ON</u>	This selects whether the VTR is to stop automatically when the counter value reaches "0" during a fast forwarding or rewinding operation in the CTL mode. 0: The VTR does not stop. 1 : The VTR stops automatically. <Notes> 1. The stop mode concerned is either the stop or the still-picture (SHTL STILL) mode depending on the setup menu No. 313 (AFTER CUE-UP) setting. 2. When both the AUTO REW function and MEMORY function have been selected at the same time, the AUTO REW function takes precedence.

The underline on the setting item denotes the initial setting.

USER menu

<INTERFACE>

Item		Setting		Description
No.	Superimposed display	No.	Superimposed display	
201	9P SEL	<u>0000</u> 0001	OFF <u>ON</u>	This selects whether the 9P connector functions when the REMOTE/LOCAL switch has been set to REMOTE. 0: Do not function 1: Function
202	ID SEL	<u>0000</u> 0001	<u>OTHER</u> DVCPRO	This selects the ID information which is returned to the controller. 0: 20 25H 1: DVCPRO's, own ID is returned (F0 33H).

The underline on the setting item denotes the initial setting.

USER menu <EDIT>

Item		Setting		Description
No.	Superimposed display	No.	Superimposed display	
300	VAR RANGE	<u>0000</u> 0001	<u>- 0.43 - 1</u> - 4 - +4	<p>This sets the VAR speed range.</p> <p>0: The tape is played in slow motion at a speed ranging from - 0.43x to +1x normal speed.</p> <p>1: The tape is played in the ±4.1x normal speed range.</p> <p><Note> Phase synchronization from the editing controller is no longer possible once this item has been set to "0".</p> <p>For DV format: When using the dial on the front panel, playback is always performed at - 0.5 to +1x normal speed regardless of the menu setting.</p> <p>When using the 9P: When 0 is selected, playback is performed at - 0.5 to +1x normal speed.</p> <p>When 1 is selected, playback is performed at - 3.1 to +3.1x normal speed.</p>
303	STD/ NON-STD	<u>0000</u> 0001 0002	<u>AUTO</u> STD N-STD	<p>This selects STD or NON-STD in accordance with the composite input signal.</p> <p>0: Standard/non-standard signals are automatically identified and processed.</p> <p>1: Standard signals are processed. (Forced STD)</p> <p>2: Non-standard signals are processed. (Forced NON-STD)</p>
304	SERVO REF	<u>0000</u> 0001	<u>AUTO</u> EXT	<p>This selects the video signal processing.</p> <p>0: Servo is synchronized with the input signal during recording and editing, or with the REF signal during playback.</p> <p>1: Servo is synchronized at all times with the REF signal.</p>
305*	EDIT RPLCE1	<u>0000</u> 0001 0002 0003	<u>N-DEF</u> CH1 CH2 CH1+2	<p>This sets the channel assignments for the controller's analog audio preset when editing the digital audio of the VTR using a controller which does not have a digital audio edit preset control function.</p> <p>This selects the channel concerned when the VTR CH1 edit preset is set in compliance with the ON or OFF presetting for the analog audio signals designated by the controller.</p> <p>0: Not set.</p> <p>1: Compliance with analog CH1 edit preset.</p> <p>2: Compliance with analog CH2 edit preset.</p> <p>3: Compliance with either analog CH1 or CH2 edit preset.</p>
306*	EDIT RPLCE2	<u>0000</u> 0001 <u>0002</u> 0003	<u>N-DEF</u> CH1 <u>CH2</u> CH1+2	<p>This sets the channel assignments for the controller's analog audio preset when editing the digital audio of the VTR using a controller which does not have a digital audio edit preset control function.</p> <p>This selects the channel concerned when the VTR CH2 edit preset is set in compliance with the ON or OFF presetting for the analog audio signals designated by the controller.</p> <p>0: Not set.</p> <p>1: Compliance with analog CH1 edit preset.</p> <p>2: Compliance with analog CH2 edit preset.</p> <p>3: Compliance with either analog CH1 or CH2 edit preset.</p>

The underline on the setting item denotes the initial setting.

* The Setup menu can only be displayed for the model AJ-D650.

USER menu

<EDIT> (continued)

Item		Setting		Description
No.	Superimposed display	No.	Superimposed display	
307*	EDIT RPLCEC	<u>0000</u> 0001 0002 0003	<u>N-DEF</u> CH1 CH2 CH1+2	This sets the channel assignments for the controller's analog audio preset when editing the digital audio of the VTR using a controller which does not have a digital audio edit preset control function. This selects the channel concerned when the VTR CUE edit preset is set in compliance with the ON or OFF presetting for the analog audio signals designated by the editor or controller. 0: Not set. 1: Compliance with analog CH1 edit preset. 2: Compliance with analog CH2 edit preset. 3: Compliance with either analog CH1 or CH2 edit preset.
309*	AUD EDIT IN	0000 <u>0001</u>	CUT <u>FADE</u>	This selects the connection method for the digital audio edit IN point. 0: Cut processing 1: V Fade processing
310*	AUD EDIT OUT	0000 <u>0001</u>	CUT <u>FADE</u>	This selects the connection method for the digital audio edit OUT point. 0: Cut processing 1: V Fade processing
313	AFTER CUE-UP	<u>0000</u> 0001	<u>STOP</u> STILL	This selects the mode after cue-up operation is complete. 0: STOP mode 1: SHTL STILL mode

The underline on the setting item denotes the initial setting.

* The Setup menu can only be displayed for the model AJ-D650.

USER menu

<TAPE PROTECT>

Item		Setting		Description
No.	Superimposed display	No.	Superimposed display	
400	STILL TIMER	0000 0001 0002 0003 0004 0005 0006 0007 <u>0008</u>	0.5s 5s 10s 20s 30s 40s 50s 1min <u>2min</u>	This selects the time to be taken until the unit goes into the tape protection mode when it is left standing in the stop mode. (Unit: s = second, min = minute) <Note> With the DV format, the maximum time which can be set is 10s even when a setting above 10s has been selected. The selection screen, however, will operate for up to 2 minutes.
401	SRC PROTECT	<u>0000</u> 0001	<u>STEP</u> HALF	This selects the operation during the tape protection mode when the unit is left standing in the still status in No. 400 protection mode. 0: STEP FWD. 1: HALF LOADING. <Note> When STEP FWD is selected, the unit automatically goes into the HALF LOADING mode when the total time for which the unit is left standing in the still status reaches 30 minutes (DVCPR) or 1 minute (DV).

The underline on the setting item denotes the initial setting.

<Note>

In order to protect the tape and VTR helical heads, it is recommended that the Still Timer be set for automatic tape protection mode in 30 seconds or under.

Setup (setting) menus

USER menu

<TIME CODE>

Item		Setting		Description
No.	Superimposed display	No.	Superimposed display	
500	VITC POS-1	0000 0001 0002 0003 0004 0005 <u>0006</u> 0007 0008 0009 0010	10L 11L 12L 13L 14L 15L 16L 17L 18L 19L 20L	This sets the position where the VITC signal is to be inserted. (The same line as for VITC POS-2 in 501 cannot be selected.)
501	VITC POS-2	0000 0001 0002 0003 0004 0005 0006 0007 <u>0008</u> 0009 0010	10L 11L 12L 13L 14L 15L 16L 17L 18L 19L 20L	This sets the position where the VITC signal is to be inserted. (The same line as for VITC POS-1 in 500 cannot be selected.)
502	VITC BLANK	0000 <u>0001</u>	BLANK <u>THRU</u>	This selects whether to output the VITC data to the positions selected by VITC POS-1 in 500 and VITC POS-2 in 501. 0: Data is not output. 1: Data is output.
503	TCG REGEN	<u>0000</u> 0001 0002	<u>TC&UB</u> TC UB	This selects the signal to be regenerated when the time code generator (TCG) in the REGEN mode. 0: Both the time code and user bit are regenerated. 1: Only the time code is regenerated. 2: Only the user bit is regenerated.
504	REGEN MODE	0000 <u>0001</u>	<u>OFF</u> ON	This selects whether values used in the internal time code generator are preset from the front panel or remote controller or synchronized with time code values read from the tape. 0: Values are preset from the front panel or remote controller. (PRESET) 1: Values are synchronized with time code values read from the tape. (REGEN) <Note> When "1" is selected, values selected at set up menu No.503 (TCG REGEN) are regenerated.
505	EXT TC SEL	<u>0000</u> 0001	<u>LTC</u> VITC	This selects the time code to be used when an external time code is to be used. 0: The LTC of the TIME CODE IN connector is used. 1: The video signal VITC is used.
506	BINARY GP	<u>0000</u> 0001 0002 0003 0004 0005 0006 0007	<u>000</u> 001 010 011 100 101 110 111	This sets the usage status of the user bit of the time code generated by the TCG. 0: NOT SPECIFIED (character set not specified) 1: ISO CHARACTER (8 bits character set based on ISO646, ISO2022) 2: UNASSIGNED 1 (undefined) 3: UNASSIGNED 2 (undefined) 4: UNASSIGNED 3 (undefined) 5: PAGE/LINE 6: UNASSIGNED 4 (undefined) 7: UNASSIGNED 5 (undefined)

The underline on the setting item denotes the initial setting.

USER menu

<TIME CODE> (continued)

Item		Setting		Description
No.	Superimposed display	No.	Superimposed display	
507	PHASE CORR	<u>0000</u> 0001	OFF ON	This selects whether to control the phase correction of the LTC generated by the TCG. 0: Phase correction control is not performed. 1: Phase correction control is performed.
508	TCG CF FLAG	<u>0000</u> 0001	OFF ON	This selects whether the CF flag of the TCG is to ON. 0: CF flag is OFF. 1: CF flag is ON.
509	DF MODE	<u>0000</u> 0001	DF NDF	This selects the DF/NDF mode for CTL and TCG. 0: Drop frame mode. 1: Non-drop frame mode. No.509 is valid when the CONTROL is LOCAL or LOCAL ENA of item 004 to "ENA".
510	RUN MODE	<u>0000</u> 0001	REC FREE	This selects the time code generator run mode. 0: Generator runs only during recording. 1: Generator runs during usual operation. <Note> Even if "0" is selected, the time code generator runs during usual operation when "1" is selected at the setting menu No.504 (REGEN MODE).
511	TC OUT REF	<u>0000</u> 0001	V OUT TC IN	This is used to switch the phase of the time code, which is output from the TIME CODE OUT connector, for the external LTC input when the TC INT/EXT switch is at the EXT position. (In EE mode only) 0: Time code is synchronized with output video signal. 1: Time code is synchronized with external time code input.

The underline on the setting item denotes the initial setting.

USER menu

<VIDEO>

Item		Setting		Description
No.	Superimposed display	No.	Superimposed display	
600	P B/P R IN LV	<u>0000</u> 0001	MII B-CAM	This selects the component input signal level. 0: MII level. 1: 0 cam level.
601	INT BB SIG	<u>0000</u> 0001	OFF BB	This selects whether to generate the internal black burst signal. 0: Signal is not generated. 1: Signal is generated.
602	INPUT C KILL	<u>0000</u> 0001	B/W AUTO	This selects color killer processing for the video input signals. 0: The signals are forcibly processed as B/W signals. 1: The signals are automatically processed.
603	OUT VSYNC	<u>0000</u> 0001	N-VF VF	This selects whether to float the vertical sync position of the video output in order to align the video output phase with the input in the EE/record/edit modes. 0: Signals are not floated. 1: Signals are floated.

The underline on the setting item denotes the initial setting.

Setup (setting) menus

USER menu

<VIDEO> (continued)

Item		Setting		Description
No.	Superimposed display	No.	Superimposed display	
604	V-MUTE SEL	<u>0000</u> 0001	N-MUTE <u>LOW-RF</u>	This selects whether the video output signal is to be muted in the event of a low RF or disengaged servo lock during playback. 0: No muting (picture freezes). 1: Muting (picture turns grey).
605	CC (F1) BLANK	<u>0000</u> 0001	BLANK <u>THRU</u>	This selects ON or OFF for the closed capture signal in the first field. 0: Forced blanking performed. 1: Blanking not performed.
606	CC (F2) BLANK	<u>0000</u> 0001	BLANK <u>THRU</u>	This selects ON or OFF for the closed capture signal in the second field. 0: Forced blanking performed. 1: Blanking not performed.
608	FREEZE SEL	<u>0000</u> 0001	<u>FIELD</u> FRAME	This selects the freeze mode for still pictures. 0: Field freeze 1: Frame freeze <Note> When frame freeze is selected, the frame freeze mode is established even during slow motion.
609	IN FRM DET	<u>0000</u> 0001	FORCED <u>AUTO</u>	This selects the conditions under which frame detection is to be performed when signals are input. 0: Frame detection is performed at all times. 1: Frame detection is prohibited only when non-standard signals are input.
611	EDH	<u>0000</u> 0001	OFF <u>ON</u>	This selects whether to superimpose EDH onto the serial output signals. 0: EDH is not superimposed. 1: EDH is superimposed. • This item setting is valid when the optional serial interface board has been installed.
612	WIDE SELECT	<u>0000</u> 0001 0002	<u>AUTO</u> WIDE NORMAL	This selects the operation to be conducted in response to the WIDE information. 0: During recording, if the Y/C input signals contain WIDE information, the WIDE information is recorded on the tape. During playback, if WIDE information is on the tape, it is added to the Y/C output signals. 1: During recording, the WIDE information is recorded on the tape regardless of whether the Y/C input signals contain the WIDE information. During playback, the WIDE information is added to the Y/C output signals regardless of whether the WIDE information is on the tape. → Forced WIDE ON 2: During recording, the WIDE information is not recorded on the tape regardless of whether the Y/C input signals contain the WIDE information. During playback, the WIDE information is not added to the Y/C output signals regardless of whether the WIDE information is on the tape. → Forced WIDE OFF <Note> This item is effective during recording at the start of the recording and during playback at all times. Therefore, when its setting has been changed during recording, the MENU contents will be changed but no change will occur in the actual operation.

The underline on the setting item denotes the initial setting.

USER menu

<AUDIO>

Item		Setting		Description
No.	Superimposed display	No.	Superimposed display	
700	CH1 IN LV	<u>0000</u> 0001 0002 0003	4dB 0dB -20dB -60dB	This selects the audio input (CH1) reference level switching.
701	CH2 IN LV	<u>0000</u> 0001 0002 0003	4dB 0dB -20dB -60dB	This selects the audio input (CH2) reference level switching.
703	CH1 OUT LV	<u>0000</u> 0001 0002	4dB 0dB -20dB	This selects the audio output (CH1) reference level switching.
704	CH2 OUT LV	<u>0000</u> 0001 0002	4dB 0dB -20dB	This selects the audio output (CH2) reference level switching.
713	MONI CH SEL	<u>0000</u> 0001 0002 0003	AUTO 1 AUTO 2 AUTO 3 AUTO 4	<p>This selects the monitor output.</p> <p>0: In the tape speed range of $-0.43\times$ ($-0.5\times$ to $\pm 1\times$ normal speed, PCM AUDIO is output; at all other times, CUE is automatically output.</p> <p>1: In the PLAY mode, PCM AUDIO is output; at all other times, CUE is automatically output.</p> <p>2: In the PLAY mode, PCM AUDIO is output; in the tape speed range of $-0.43\times$ ($-0.5\times$) to $\pm 1\times$ normal speed, QUICK PCM AUDIO is output; at all other times, CUE is automatically output.</p> <p>3: In the tape speed range of $-0.2\times$ to $+0.2\times$ normal speed, QUICK PCM AUDIO is output; in the tape speed ranges of $-1\times$ to $-0.2\times$ and $+0.2\times$ to $+1\times$ (excluding $-0.2\times$ and $+0.2\times$) normal speed, PCM AUDIO is output; at all other times, CUE is automatically output.</p> <p><Notes></p> <p>1. The tape speed figures given above in parentheses apply when DV format tapes are used.</p> <p>2. PCM AUDIO complies with the AUDIO MONITOR SELECT SW setting and is set to CH1, CH2 or MIX (CH1+CH2).</p> <p>3. "QUICK PCM AUDIO" is a playback mode in which priority is given to aligning the video and audio phases during slow-motion playback. In this mode, the sound at $1\times$ normal speed is played back one frame at a time each time the video frame is updated. (During normal PCM AUDIO slow-motion playback, the sound is stretched out so that it is played back after the pictures.)</p>
714	REC CH1	<u>0000</u> 0001 0002	CH1 CH2 CH1+2	<p>This selects the input signal to be recorded on the audio CH1 track.</p> <p>0: Audio input CH1 signal. 1: Audio input CH2 signal. 2: Mixed audio input CH1 and CH2 signal.</p>
715	REC CH2	<u>0000</u> 0001 0002	CH1 CH2 CH1+2	<p>This selects the input signal to be recorded on the audio CH2 track.</p> <p>0: Audio input CH1 signal. 1: Audio input CH2 signal. 2: Mixed audio input CH1 and CH2 signal.</p>

The underline on the setting item denotes the initial setting.

USER menu

<AUDIO> (continued)

Item		Setting		Description
No.	Superimposed display	No.	Superimposed display	
716	REC CUE	<u>0000</u> 0001 0002	<u>CH1</u> CH2 CH1+2	This selects the input signal recorded in CUE. 0: The signal selected by SETUP-MENU No.714 is recorded on CH1. 1: The signal selected by SETUP-MENU No.715 is recorded on CH2. 2: The signal selected by SETUP-MENU No.714 and No.715 are mixed and recorded on CH1 and CH2.
718	DV OUTPUT	<u>0000</u> 0001 0002	<u>ST1</u> ST2 ST1+2	This selects the AUDIO CH1 and CH2 output signals during DV format playback. 0: The CH1 track signals are output to CH1 and the CH2 track signals to CH2. (Only the sound during shooting is output.) 1: The CH3 track signals are output to CH1 and the CH4 track signals to CH2. (Only the audio dubbing sound is output.) 2: The mixed CH1 and CH3 track signals are output to CH1 and the mixed CH2 and CH4 track signals to CH2. (The sound during shooting and audio dubbing sound are output simultaneously.) <Note> This item setting is valid only when the tape recorded on the four channels of the DV format is played back.
719	PB FADE	<u>0000</u> 0001 0002	<u>AUTO</u> CUT FADE	This selects the processing method for the audio edit points (IN point, OUT point) during playback. 0: According to the status during recording. (Setup menus No.309, 310) 1: Forced CUT 2: Forced FADE
720	EMBEDDED AUD	<u>0000</u> <u>0001</u>	<u>OFF</u> <u>ON</u>	This selects whether to superimpose the audio data onto the serial output. 0: Data is not superimposed. 1: Data is superimposed. <Note> This item is valid when the optional serial interface board has been installed.
721	LINE CH SEL	<u>0000</u> 0001	<u>PCM</u> AUTO	This selects the audio output (LINE OUT). 0: PCM AUDIO or QUICK PCM AUDIO is output. 1: Whatever is selected by SETUP-MENU No.713 (MONI CH SEL) output. <Note> The PCM AUDIO or QUICK PCM AUDIO output is not affected by the AUDIO MONITOR SELECT SW, and CH1 and CH2 are output independently.
722	INT SG	<u>0000</u> 0001	<u>OFF</u> <u>ON</u>	This selects whether the internal signal is to be used for the audio input signal. 0: The internal signal is not selected. 1: The internal signal is selected. <Note> The internal signal has a frequency of 1 kHz.
723	DV PB ATT	<u>0000</u> 0001	<u>OFF</u> <u>ON</u>	This selects the audio output level for DV format playback. 0: The audio output level is attenuated (reduced). 1: The audio output level is not attenuated. <Notes> As indicated below, whether the setting takes effect or not depends on the size of the cassette tape used. 1. When an "L" size cassette is used The setting takes effect only when "DV" has been selected as the setting for setup menu No. 108 (FORMAT SEL). 2. When an "M" size cassette is used The setting does not take effect. 3. When an "S" size cassette is used The setting takes effect.

The underline on the setting item denotes the initial setting.

Time code/user bit

Time code

The time code is used when the time code signal generated by the time code generator (time code signal generator) is to be recorded on the tape, its values are to be read by the time code reader (time code signal reader), and the absolute position of the tape is to be displayed in increments of hours, minutes, seconds and frames.

The time code is written in the sub-code area (data area) of the helical track. This enables insert editing to be conducted independently using the time code alone. In addition, the VTR's playback speed can be read from the stop mode to slow-motion playback up to high-speed play (approx. 100x normal speed).

The time code values are indicated using the display and superimpose functions.

TC 00 : 07 : 04 : 24
↑ ↑ ↑ ↑
Hours | Minutes Seconds Frames

<Note>

Time code reader values normally appear on the superimposed display.

Values appear as shown below on the front display.

Playback: Time code reader values

REC, EE: Time code generator values

Time code generator values can be checked when the REC button is pressed even during playback.

User bit

"User bit" refers to the 32-bit (8-digit) data frame among the time code signals which has been released to users. It enables operator numbers values to be recorded.

The alphanumeric characters which can be used for the user bit are the figures 0 to 9 and the letters A to F.

Recording internal/external time codes

1. Setting the internal time code

- 1** Place the VTR in the stop mode.
- 2** Set the CTL/TC/UB switch to TC.
- 3** Set the TC INT/EXT switch to INT. (Internal time code selected)
- 4** Set the RUN MODE. (setup menu No. 510)
REC (RUN): The time code runs at the same time as the recording proceeds.
FREE (RUN): The time code runs in the same way as the time regardless of the VTR's operation.
- 5** Set the REGEN MODE. (setup menu No. 504)
OFF (REGEN): Continuity is maintained with the recorded time code before editing.
(Detailed settings are also possible using the menu settings. See the menu items below.)
Setting menu No. 503 (TCG REGEN)
ON (PRESET): Recording starts from the value set with the TC PRESET button.
- 6** Set the TC PRESET button.
Use the TC PRESET button to set the start number of the time code or user bit.
 - 1** The leftmost digit flashes.
Align the flashing light and the digit to be set with the cursor buttons (◀, ▶).
 - 2** Press the cursor button ▲ or ▼ to change the value.
Each time the button is pressed, the number changes. The setting range is given below.
 - **When using the time code and user bit in real time**
00:00:00:00 – 23:59:59:29
 - **User bit**
00 00 00 00 – FF FF FF FF
 - 3** Repeat steps 1 and 2 to change the value.
 - 4** When the setting of the start number is completed, press the SET button. In the FREE RUN mode, the time code now starts running.
 - 5** Proceed with the recording or editing.

2. Setting the external time code (TC switch → EXT)

- 1** Place the VTR in the stop mode.
- 2** Set the TC/CTL/UB switch to TC.
- 3** Set the TC INT/EXT switch to EXT. (External time code selected)
- 4** Setting menu No. 505 (EXT TC SEL) can be set as follows.
LTC: The LTC signal input to the TIME CODE IN connector (BNC) on the rear jack panel is recorded as the time code.
<Note> The LTC signal must be synchronized with the video signal.
VITC: The input video signal's VITC is recorded as the time code.

Reproducing the time code/user bit

- 1** Place the unit in the stop mode.
- 2** Set the CTL/TC/UB switch to TC or UB.
TC: The time code is displayed.
UB: The user bit is displayed.
 - When it is no longer possible to read the time code, it is interpolated using the CTL signal.
- 3** Press the PLAY button.
Playback now commences, and the time code appears on the display.
When setting menu No.006 (SUPER) is ON, the time code value is superimposed onto the video signal from the VIDEO OUT 3 connector.

<Notes>

- The colon between the seconds and frames changes to a period when the drop frame time code is read.
- When the time code signal cannot be read, the time code is automatically interpolated by the CTL signal.

The superimposed appears as shown below.

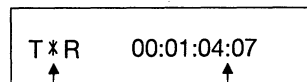

The colon between the seconds and frames changes to a period during drop frame mode.

When the time code signal cannot be read, an asterisk is displayed on the superimposed TV monitor.

Superimpose screen

The control signals, time code, etc. are displayed using abbreviations.

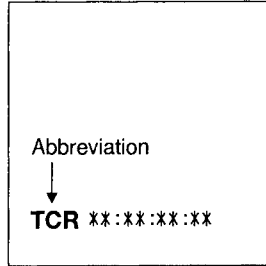

CTL = control signal
TCR = TC time code reading
UBR = TC user bit reading

TV monitor

Characters displayed

The background of characters superimposed on the display can be changed using menu No.007 (CHARA TYPE).

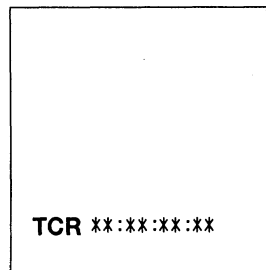

TV monitor

Display position

The position of the characters superimposed on the display can be changed using setting menus No.001 (CHARA H-POS) and No.002 (CHARA V-POS).

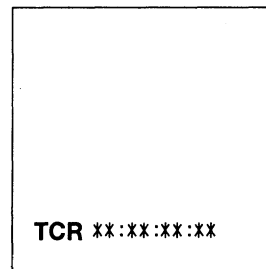

TV monitor

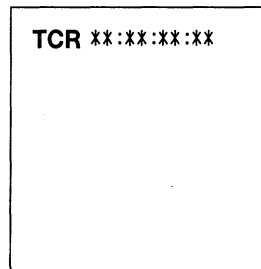

TV monitor

Operation mode

The VTR's operation mode can also be displayed using setting menu No.003 (DISPLAY SEL).

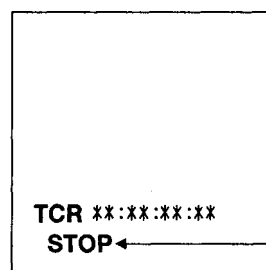

VTR operation mode

TV monitor

Servo reference

This unit automatically selects the input video signal selected by the INPUT switch, the reference video signal supplied from the REF VIDEO input connector or the internal sync signal as the servo reference signal.

When the signal is selected, the unit's mode and servo reference stand in the relationship shown in the flowchart presented below.

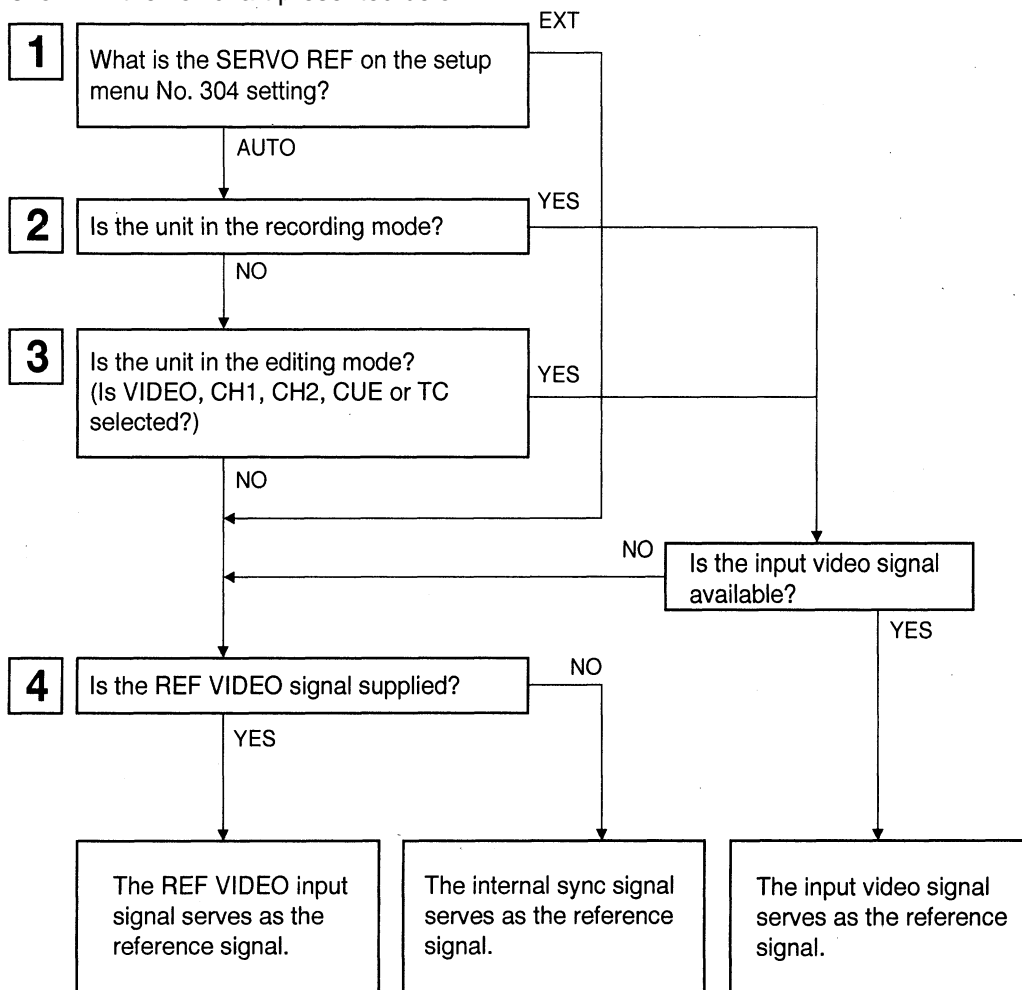

Servo reference setting tables

The servo reference signal is switched as shown in the tables below depending on the servo reference setting, deck mode and what input signal is available. When the mode is transferred to editing or recording/playback, the image may be disturbed and the transfer may be delayed if the references during playback and recording do not match.

■ During playback or special playback

SERVO REF on the setup menu No. 304 position	Input signal status		Reference signal (servo reference)
	VIDEO IN signal	REF IN signal	
AUTO	0	0	REF IN signal
	0	×	Internal sync signal
	×	0	REF IN signal
	×	×	Internal sync signal
EXT	0	0	REF IN signal
	0	×	Internal sync signal
	×	0	REF IN signal
	×	×	Internal sync signal

■ During recording or editing

SERVO REF on the setup menu No. 304 position	Input signal status		Reference signal (servo reference)
	VIDEO IN signal	REF IN signal	
AUTO	0	0	VIDEO IN signal
	0	×	VIDEO IN signal
	×	0	REF IN signal
	×	×	Internal sync signal
EXT	0	0	REF IN signal
	0	×	Internal sync signal
	×	0	REF IN signal
	×	×	Internal sync signal

“○” denotes that the signal is supplied: “×” denotes that the signal is not supplied.

Audio V Fade Function (AJ-D650 only)

When editing tapes, the edit point splicing selection (setting menu No. 309 and 310) information is recorded on the tape. This information is then sensed during playback, and V fade or cut processing is automatically performed for these sections. [However, only when the playback fade selection (No. 719) is AUTO.]

When the edit point splicing selection (setting menu No. 309 and 310) is CUT



↑
Noise may appear at the edit splice.

When the edit point splicing selection (setting menu No. 309 and 310) is FADE

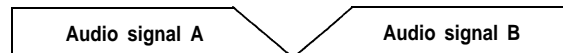

↑
V fade is performed instantaneously to eliminate the noise.

<Notes>

- When the playback fade selection (No. 719) is CUT, cut processing is performed for all splices.
- When the playback fade selection (No. 719) is FADE, V fade processing is performed for all splices.

Rack mounting

The unit can be mounted into a 19-inch standard rack if the optional rack-mounting adaptors (AJ-MA75P) are used. For the installation rails, it is recommended that the rail and bracket for 18" length (model number CC3001-99-0400) of SHASSIS TRAK be used. (The complete slide rail and bracket unit is not available from Panasonic) For further details, consult with your dealer.

- 1** Remove the screws on the left and right sides of the unit.
- 2** Use the removed screw to attach the inner members of the slide rails.

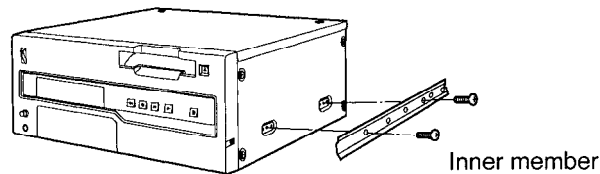

The length of the screws used is subject to restriction. If some of the mounting screws have been lost or misplaced, use screws which are less than 4" long in their place. Use four screws to secure each inner member.

- 3** Attach the outer member brackets to the rack. Check that the height is the same for the left and right brackets.
- 4** Attach the AJ-MA75P rack-mounting adaptors with included 4 screws.

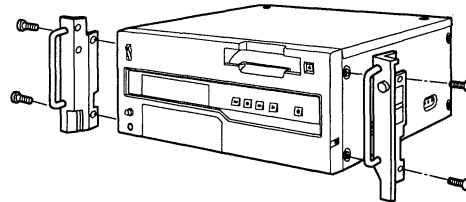

- 5** Remove the 4 rubber legs from the bottom of the unit, and install the unit in the rack. After the unit has been installed, check that it moves smoothly along the rails.

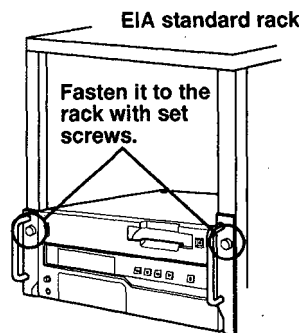

<Notes>

- Keep the temperature inside the rack to between +41°F (5°C) and +104°F (40°C).
- Bolt the rack securely to the floor so that it will not topple over when the VTR is drawn out.

Video head cleaning

This unit has an auto head cleaning function which automatically reduces the dirt on the heads. However, to further increase the unit's reliability, it is recommended that its video heads be cleaned every day.

Use the cleaning fluid designated by Panasonic.

Condensation

Condensation occurs due to the same principle involved when droplets of water form on a window pane of a heated room. It occurs when the unit or tape is moved between places where the temperature or humidity varies greatly or when, for instance:

- It is moved to a very humid place full of steam or a room immediately after it has been heated up.
- It is suddenly moved from a cold location to a hot or humid location.

When moving the unit to locations such as these, leave it standing for about 10 minutes rather than switching on the power immediately.

If condensation has formed on or in the unit, the "E-20" code flashes in the counter display and the cassette tape is automatically ejected.

Keep the power supplied and simply wait until the "E-20" code goes off.

Error messages

Warning

Error No.	TV monitor display*	Descriptions	VTR operation
E-00* (Err-00)	SERVO NOT LOCKED	Error No. lights when servo disturbances continue for 3 or more seconds during playback, recording or editing.	Continued
E-01* (Err-01)	LOW RF	Error No. lights when envelope levels approx. 1/3 that of normal levels are detected for more than 1 sec. during playback, recording or editing.	Stop
E-10* (Err-10)	FAN STOP	Error No. lights when a fan motor stops operating.	Stop

* Displays when warning information is checked by pressing the DIAG button.

AUTO OFF mode

The following error number flashes on the counter display section.

Error No.	Descriptions	VTR operation
E-20	When condensation is detected, the error no. display flashes, and the unit goes into EJECT mode. The drum rotates after the cassette tape is ejected to remove condensation. When the condensation has been removed, the error no. display disappears and the VTR may be used. <Note> 1) The drum rotates as soon as condensation is detected when the unit is in EJECT mode. 2) When condensation is detected while a cassette tape is inserted, drum rotation stops, the cassette tape is ejected and the drum rotation begins again.	EJECT
E-29	The cassette does not move up even when 6 seconds have elapsed since the VTR was transferred to the eject mode.	Stop
E-31	The unloading operation is not completed within 10 seconds.	Stop
E-35	There is no response from the servo microcomputer for 1 or more seconds.	Stop
E-36	Only the servo microcomputer was reset in an instantaneous power failure.	Stop
E-37	The servo microcomputer does not follow the instructions of the system control microcomputer even when 10 seconds have elapsed.	Stop
E-51	The message display flashes when the take-up reel has been rotating idly for a fixed period of time while the start/end processing operation during loading (half position) is being performed.	Stop
E-52	After the cassette has been inserted, the tape take-up reel has not wound up the tape while the total tape amount is not detected and while the tape is traveling at or above the normal tape speed in the forward or reverse direction.	Stop
E-53	After the total tape amount has been detected, the amount of tape wound up on the take-up reel and the amount of tape supplied by the supply reel differ to an abnormal extent while the tape is traveling.	Stop
E-55	The tape has not been wound up during unloading.	Stop

Error messages

Error No.	Descriptions	VTR operation
E-57	The start/end processing operation is not completed even after 10 or more seconds have elapsed.	Stop
E-59	The cylinder motor speed is abnormally low.	Stop
E-60	The cylinder motor speed is abnormally high.	Stop
E-61	The capstan motor speed is abnormally low.	Stop
E-67	The tape-up reel motor speed is abnormally high.	Stop
E-69	An abnormal torque applied to the take-up reel motor is detected.	Stop
E-70	An abnormal torque applied to the supply reel motor is detected or if an abnormal current flowing to the current-sensing resistor is detected.	Stop
E-71	An abnormal tension at the supply side is detected in the capstan mode.	Stop
E-72	An abnormal tension at the supply side is detected in the reel mode.	Stop
E-73	The reel motor at the take-up side is running in the reverse direction.	Stop
E-FF	Tape start and end are detected simultaneously during loading or after loading is completed.	Stop

Connector signals

VIDEO IN

SERIAL IN (DIGITAL)	BNC×2	Active through (Option)
Y, PB, PR (ANALOG)	BNC×3	
VIDEO IN	BNC×2	Loop-through, 75Ω termination switch provided
REF VIDEO IN	BNC×2	Loop-through, 75Ω termination switch provided
S1-VIDEO IN	4-pin × 1	

VIDEO OUT

SERIAL OUT (DIGITAL)	BNC × 3	(Option)
Y, PB, PR (ANALOG)	BNC × 3	
VIDEO OUT	BNC × 3	
S1-VIDEO IN	4-pin × 1	

AUDIO IN

SERIAL IN (DIGITAL)	BNC × 2	(Option)
AUDIO IN (DIGITAL)	BNC × 1	CH1/CH2 AES/EBU format (Option)
AUDIO IN (ANALOG)	XLR × 2	CH1, CH2
TIME CODE IN	BNC × 1	

Pin No.	Signal
1	GND
2	HOT
3	COLD

AUDIO OUT

SERIAL OUT (DIGITAL)	BNC × 3	(Option)
AUDIO OUT (DIGITAL)	BNC × 1	CH1/CH2 AES/EBU format (Option)
AUDIO OUT (ANALOG)	XLR × 2	CH1, CH2
TIME CODE OUT	BNC × 1	
MONITOR OUT	PHONO × 1	
HEADPHONES (front)	1/4" phone × 1	

RS-422A REMOTE (9P)

RMOTE

Pin No.	Signal	Pin No.	Signal	Pin No.	Signal
1	FRAME GROUND	4	RECEIVE COMMON	7	TRANSMIT B
2	TRANSMIT A	5	—————	8	RECEIVE A
3	RECEIVE B	6	TRANSMIT COMMON	9	FRAME GROUND

Connector signals

RS-232C REMOTE (25-pin D-SUB straight cable supported)

Pin No.	Abbreviation	Circuit	Description
1	FRAME GROUND	Protective ground	Frame ground
2	TxD	Transmitted data	Receives data from the PC.
3	RxD	Received data	Sends data to the PC.
4	RTS	Request to send	Shorted with pin 4.
5	CTS	Clear to send	Shorted with pin 5.
6	DSR	Data set ready	Positive power output after communication enable status
7	GND	Signal ground	Signal ground
20	DTR	Data terminal ready	No processing

• Example of connections with controller (PC) using a 25-pin D-SUB straight cable

PC end (D-SUB 25 pins)

VTR end (D-SUB 25 pins)

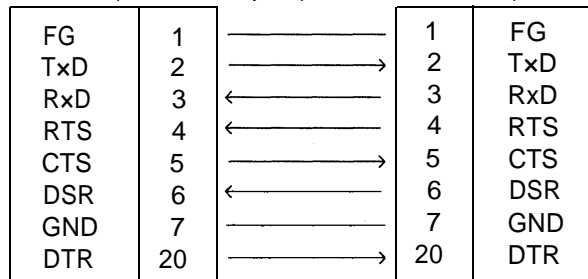

ENCODER REMOTE (15P)

Pin No.	Signal	Pin No.	Signal	Pin No.	Signal
1	_____	6	SYSTEM H	11	RET GND
2	SET UP	7	SYS.SC COARSE (2)	12	_____
3	C LEVEL	8	-12V	13	_____
4	GND	9	HUE	14	SYS.SC FINE
5	+12V	10	VIDEO LEVEL	15	SYS.SC COARSE (1)

Specifications

GENERAL

Power supply:	AC 120 V, 50–60 Hz
Power consumption:	150 W

Operating ambient temperature:	41°F to 104°F (5°C to 40°C)
Operating ambient humidity:	10% to 90% (no condensation)
Weight:	35.2 lbs (16 kg)
Dimensions (W×H×D):	16-3/4×6-15/16×16-3/8 inches (424×175×415 mm)
Recording format:	DVCPRO format
Recording tracks:	Digital video
	Time code Recorded in sub-code area
	Digital audio 2 channels
	Cue Track 1 track
	Control (CTL) 1 track
Tape speed:	33.820 mm/sec
Recording time:	123 minutes (with AJ-P123LP) 63 minutes (with AJ-P63MP)
Tape:	1/4-inch thin magnetic layer metal tape
FF/REW time:	Less than 3 min (with AJ-P123LP) Less than 2 min (with AJ-P63MP)
Search speed:	0 to ±60× normal speed (color)
Digital slow motion:	+0.75× normal speed in + direction –0.43× normal speed in – direction ±0 frame (using time code)
Editing accuracy:	±1 frame (using continuous CTL signal)
Tape timer accuracy:	Less than 0.5 sec. (color framing/ standby ON)

VIDEO

(Digital video)

Sampling frequencies:	Y: 13.5 MHz/Pb, PR: 3.375 MHz
Quantizing:	8 bits
Error correction:	Reed-Solomon product code

(Digital IN/analog component OUT)

Video bandwidth:	Y: 30 Hz to 5.5 MHz (±1.0 dB) Pb, PR: 30 Hz to 1.0 MHz (±1.0 dB)
S/N ratio:	Better than 60 dB
K factor:	Less than 2%

(Analog component IN/component OUT)

Video bandwidth:	Y: 30 Hz to 5.5 MHz (–1.5 dB to ±1.0 dB) Pb, PR: 30 Hz to 1.0 MHz (–2.0 dB to ±1.0 dB)
S/N ratio:	Better than 55 dB
K factor:	Less than 2%

(Analog composite IN/composite OUT)

Video bandwidth:	Y: 30 Hz to 4.5 MHz (–1.5 dB to ±1.0 dB)
Y/C delay:	Better than 20 ns
K factor:	Less than 3%

(Video input connector)

Analog component input:	BNC×3 (Y, Pb, PR) Y: ±1.0 Vp-p, 75Ω Pb, PR: 0.486/0.7 Vp-p switchable, 75Ω (75% color bar, 7.5% setup)
--------------------------------	---

Analog composite input:	BNC×2, loop-through, 75Ω on/off
--------------------------------	---------------------------------

S VIDEO input:	S terminal (4-pin)×1 Y: ±1.0 Vp-p, 75Ω C: 0.286 Vp-p (burst), 75Ω
-----------------------	---

Reference input:	Analog composite BNC×2, loop-through, 75Ω on/off
-------------------------	---

Serial digital component input (option):	Complies with SMPTE259M-C standard, BNC×2, active through
---	--

(Video output connector)

Analog component output:	BNC×3 (Y, Pb, PR) Y: ±1.0 Vp-p, 75Ω Pb, PR: 0.486/0.7 Vp-p switchable, 75Ω (75% color bar, 7.5% setup)
---------------------------------	---

Analog composite output:	BNC×3 Video1/video2/video3 (superimpose on/off)
---------------------------------	--

S VIDEO output:	S terminal (4-pin)×1 Y: ±1.0 Vp-p, 75Ω C: 0.286 Vp-p (burst), 75Ω
------------------------	---

Serial digital component output (option):	Complies with SMPTE259M-C standard, BNC×3
--	--

(Video signals adjustment)

Video output gain:	±3 dB	} Control from ENCODER REMOTE connector
Video output chroma gain:	±3 dB	
Video output hue:	±30°	
Video output setup:	±15 IRE	
Video output sync phase:	±2 μs	
Video output SC phase:	±180°	

AUDIO

(Digital audio)

Sampling frequencies:	48 kHz
Quantizing:	16 bits
Frequency response:	20 Hz to 20 kHz (–1.0 dB to +0.5 dB)
Dynamic range:	Better than 86 dB (1 kHz, emphasis OFF, “A” weighted)

Distortion:	Less than 0.1% (1 kHz, emphasis OFF, standard level)
--------------------	---

Crosstalk:	Less than –80 dB (1 kHz, between 2 channels)
-------------------	---

Wow & flutter:	Below measurable limits
---------------------------	-------------------------

Headroom:	20 dB
------------------	-------

De-emphasis:	T1=50 μT2=15 μs (on/off automatic)
---------------------	------------------------------------

(Cue track)

Frequency response:	300 Hz to 6 kHz ±3 dB
----------------------------	-----------------------

(Audio input connector)

Analog input (CH1/CH2):	XLR×2, 600Ω/high impedance selectable, +4/0/–20/–60 dBu
--------------------------------	--

Digital input (CH1/CH2) (option):	BNC×1, AES/EBU format
--	-----------------------

Serial digital input (option):	Complies with SMPTE259M-C, 272M standard (BNC)
---------------------------------------	---

(Audio output connector)

Analog output (CH1/CH2):	XLR×2, low impedance, +4/0/–20 dBu
---------------------------------	------------------------------------

Digital output (CH1/CH2) (option):	BNC×1, AES/EBU format
---	-----------------------

Serial digital output (option):	Complies with SMPTE259M-C, 272M standard (BNC)
--	---

Monitor output:	Phonox1, 600Ω, –8 dBV
------------------------	-----------------------

Headphones:	Variable level, 1/4" phone, 8Ω
--------------------	--------------------------------

Other input/output connector

Time code input:	BNC×1, 0.5 to 8 Vp-p
-------------------------	----------------------

Time code output:	BNC×1, 2.0 Vp-p
--------------------------	-----------------

RS-422A input/output:	D-sub 9-pin, RS-422A interface
------------------------------	--------------------------------

RS-232C (option):	D-sub 25-pin, RS-232C interface
--------------------------	---------------------------------

Encoder remote:	D-sub 15-pin
------------------------	--------------

Weight and dimensions when shown are approximately.
Specifications are subject to change without notice.

Panasonic

Broadcast & Television Systems Company

Division of Matsushita Electric Corporation of America

Executive Office:

One Panasonic Way (4B-7), Secaucus, NJ 07094

REGIONAL OFFICES:

EASTERN: New Jersey: One Panasonic Way, Secaucus, NJ 07094

Sales: Panazip 4B-7 (201) 348-7671

Washington, D.C. (703) 759-6900

SOUTHERN: 1225 Northbrook Parkway, Suite 107A, Suwanee, GA 30174

Sales: (404) 717-6772

CENTRAL: 1707 North Randall Road, Elgin, IL 60123 Panazip EIC-3

Sales: (708) 468-5160

WESTERN: 4001 W. Alameda Ave., Suite 100, Burbank, CA 91505

Sales: (818) 562-1501

PARTS INFORMATION & ORDERING:

9:00 a.m.–5:00 p.m. (EST) (800) 334-4881/24 Hr. Fax (800) 334-4880

TECHNICAL SUPPORT:

Emergency 24 Hour Parts & Service (800) 222-0741

TRAINING INFORMATION:

Digital System Products – (201) 392-6022

Panasonic Canada Inc.

5770 Ambler Drive, Mississauga, Ontario L4W 2T3 (905) 624-5010



Panasonic



■ Reference Guide

- Items supporting DVCPRO/DV/DVCAM tape playback
- Items supporting RS-232C

Applicable models

AJ-D750
AJ-D650
AJ-D640

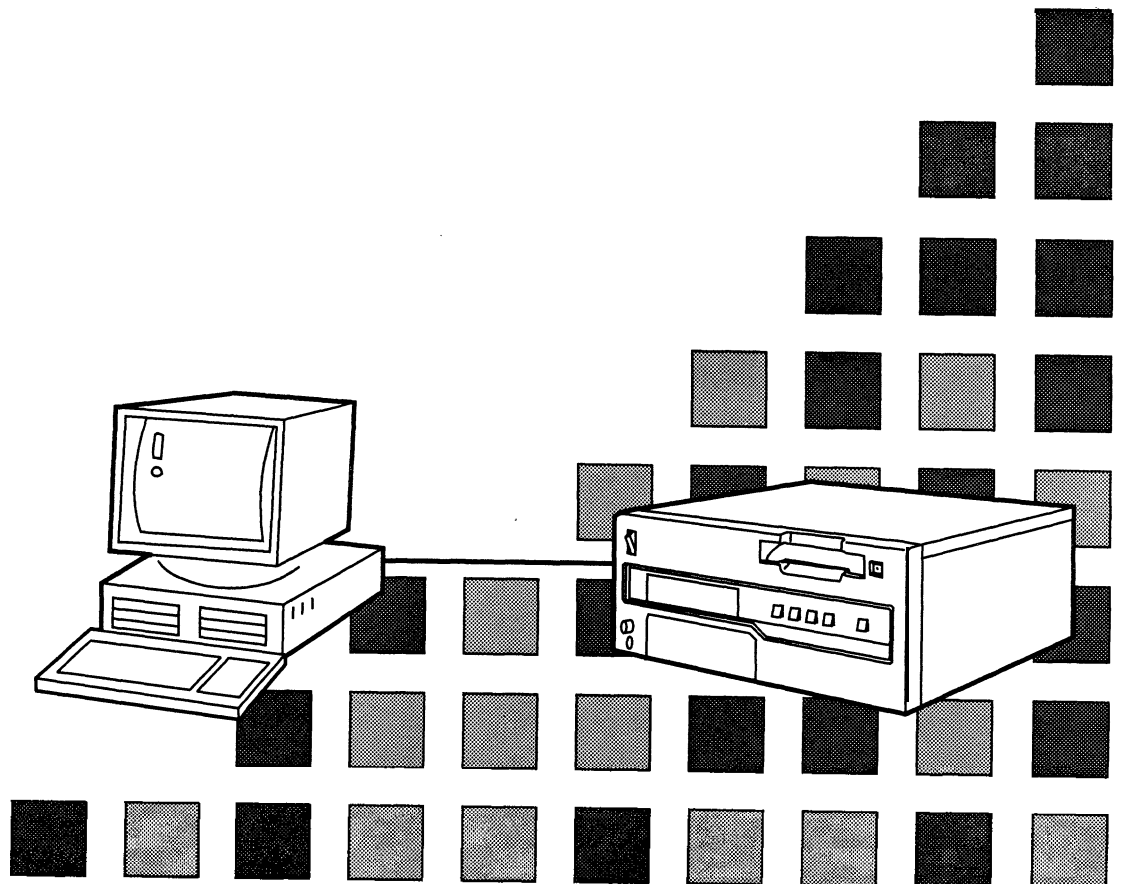

Thank you for purchasing this product.
This booklet describes the items which support both DVCPRO/DV/DVCAM tape playback and RS-232C.
Read it together with the Operating Instructions.

Contents

Items supporting DVCPRO/DV/DVCAM tape playback	E-2
Cautions when playing back consumer DV tapes and DVCAM tapes	E-2
DVCPRO/DV/DVCAM displays	E-2
Additional set-up menu items	E-3
Items supporting RS-232C	E-4
Additional set-up menu items	E-4
RS-232C interface	E-4
1. Introduction	E-4
2. Hardware specifications	E-5
3. Software specifications	E-7
4. Error code table	E-9
5. Command table	E-10

Items supporting DVCPRO/DV/DVCAM tape playback

Cautions when playing back consumer DV tapes and DVCAM tapes

- Consumer DV tapes and DVCAM tapes can be used for playback only.
- Consumer DV tapes which have been recorded in the LP mode cannot be played back.
- When materials which have been recorded on consumer DV tapes or DVCAM tapes are to be edited, record them onto a DVCPRO tape or tape of any other broadcasting VTR for use.
- Recordings cannot be made on consumer DV tapes and DVCAM tapes: this means that all functions related to recording, REC operation, editing selection and execution, TAPE/EE switching and other such operations are prohibited.
- The maximum transport speed for consumer DV tapes and DVCAM tapes is 32 times the normal tape speed.
- The maximum time for the STILL TIMER when consumer DV tapes or DVCAM tapes are used is set to 10 seconds, and the total STEP FWD time when the machine has been left standing in the STILL status is set to 1 minute.
- Slow-motion playback of consumer DV tapes and DVCAM tapes is not possible.
- In order to protect your tapes, it is recommended that repeated cue-up in the same location on a consumer DV tape or DVCAM tape be avoided as far as possible.
- Finally, check out the cautionary items for set-up menu item No.108 "FORMAT SEL."

DVCPRO/DV/DVCAM displays

Front panel displays

The DV indicator lamp on the front panel lights only during DV playback.

Superimpose display

When T&S&M has been selected for set-up menu item No.003 "DISPLAY SEL," one of the following displays appears on the third line of the superimposed display.

In the DVCPRO mode: DVCPRO MODE

In the DV mode: DV MODE

In the DVCAM mode: DVCAM MODE

Additional set-up menu items

USER menu

DVCPRO/DV/DVCAM tapes can be played back by selecting the item No.108 "FORMAT SEL" setting.

<OPERATION>

Item		Setting		Description of setting
No.	Superimposed display	No.	Superimposed display	
108	FORMAT SEL	<u>0000</u> 0001 0002	<u>DVCPRO</u> DV DVCAM	<p>These settings are for selecting the format when an L cassette or S cassette is used.</p> <p>The selected setting only becomes valid immediately after the cassette has been inserted. (If the setting is changed while the cassette remains inserted, the display will change but the setting will not be valid. In this case, the setting becomes valid when the cassette is ejected and re-inserted.)</p> <p>0: L cassette → DVCPRO mode S cassette → DV mode</p> <p>1: L cassette/S cassette → DV mode 2: L cassette/S cassette → DVCAM mode</p> <p><Notes> Bear in mind that, in addition to problems with playback, the trouble described below may occur when a tape which does not match the selected format is inserted.</p> <ol style="list-style-type: none"> 1.If a DV or DVCAM tape is inserted when the DVCPRO mode setting has been selected, the recording operation will be conducted but no guarantee is given for the resulting performance, etc. Conversely, recording is not possible if a DVCPRO cassette tape is inserted when the DV or DVCAM mode setting has been selected. 2.The REMAIN display fails to appear properly. 3.The slow-down position near the tape start or end is not located accurately. 4.When a tape which does not match the selected format is inserted, no guarantee is given for the resulting performance, etc.

The underlining indicates the factory settings.

Items supporting RS-232C

Additional set-up menu items

<INTERFACE>

Item		Setting		Description of setting
No.	Superimposed display	No.	Superimposed display	
204	RS232C SEL	<u>0000</u> 0001	<u>OFF</u> ON	These settings are for selecting whether the RS-232C connector is to function when the REMOTE/LOCAL switch is set to REMOTE. 0: Connector does not function. 1: Connector functions.
205	BAUD RATE	0000 0001 0002 0003 0004 0005	300 600 1200 2400 4800 <u>9600</u>	These settings are for selecting the RS232C communication speed (baud rate).
206	DATA LENGTH	0000 0001	7 <u>8</u>	These settings are for selecting the RS-232C data length. (Unit: bit)
207	STOP BIT	0000 0001	<u>1</u> 2	These settings are for selecting the RS-232C stop bit length. (Unit: bit)
208	PARITY	<u>0000</u> 0001 0002	<u>NON</u> ODE EVEN	These settings are for selecting the none, odd or even for the RS-232C parity bit. 0: Parity bit is not used. 1: An odd number of bits is used for the parity system. 2: An even number of bits is used for the parity system.
209	RETURN ACK	0000 <u>0001</u>	OFF <u>ON</u>	These settings are for selecting whether the ACK code is to be returned when a command is received from RS-232C. 0: ACK code is not returned. 1: ACK code is returned.

The underlining indicates the factory settings.

RS-232C interface

1. Introduction

1) The VTR can be operated by commands when the RS-232C interface is used.

(See command table on pages E-10 – E-12.)

2) Conditions for acknowledging commands from RS-232C interface

The front panel REMOTE/LOCAL switch must be at REMOTE.

The set-up menu item No.204 “RS232C SEL” must be ON.

If the above conditions are not met, [ACK] + [STX]ER001[ETX] is returned to the external unit. Whether the [ACK] code is returned depends on the setting which has been selected for set-up menu item No.209 “RETURN ACK.”

2. Hardware specifications

1) External interface specifications

■ For the model AJ-D750

(1) Connector specifications

Connector: D-SUB 25-pin (crossover cable supported)

Pin No.	Signal	Circuit name	Description
1	FG	Protective ground	Frame ground
2	RXD	Received data	Data is sent to PC.
3	TXD	Transmitted data	Data is received from PC.
4	CTS	Clear to send	Shorted with pin 5.
5	RTS	Request to send	Shorted with pin 4.
6	DTR	Data terminal ready	No processing
7	SG	Signal ground	Signal ground
20	DSR	Data set ready	+ voltage output after communication enable status

(2) Example of connection with controller (PC)

(Using crossover cable with D-SUB 25-pin connectors)

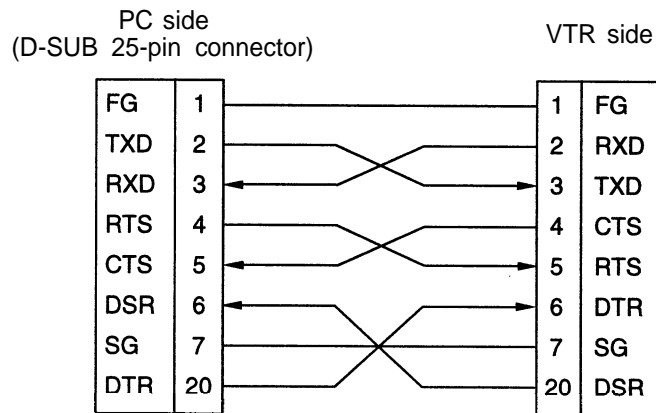

(Using crossover cable with D-SUB 9-pin and 25-pin connectors)

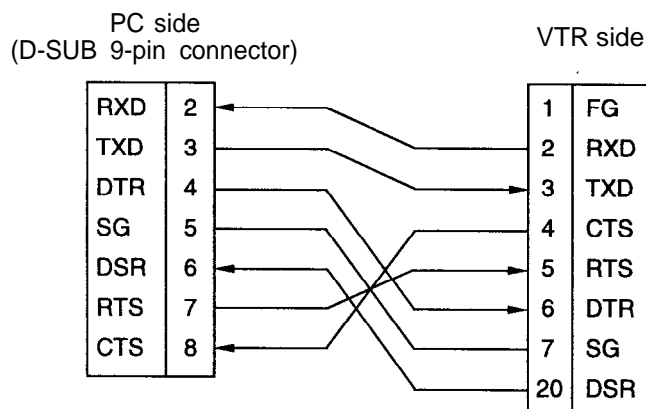

■ For the models AJ-D650 and AJ-D640

(1) Connector specifications

Connector: D-SUB 25-pin (straight cable supported)

Pin No.	Signal	Circuit name	Description
1	FG	Protective ground	Frame ground
2	TXD	Transmitted data	Data is received from PC.
3	RXD	Received data	Data is sent to PC.
4	RTS	Request to send	Shorted with pin 5.
5	CTS	Clear to send	Shorted with pin 4.
6	DSR	Data set ready	+ voltage output after communication enable status
7	SG	Signal ground	Signal ground
20	DTR	Data terminal ready	No processing

(2) Example of connection with controller (PC)

(Using straight cable with D-SUB 25-pin connectors)

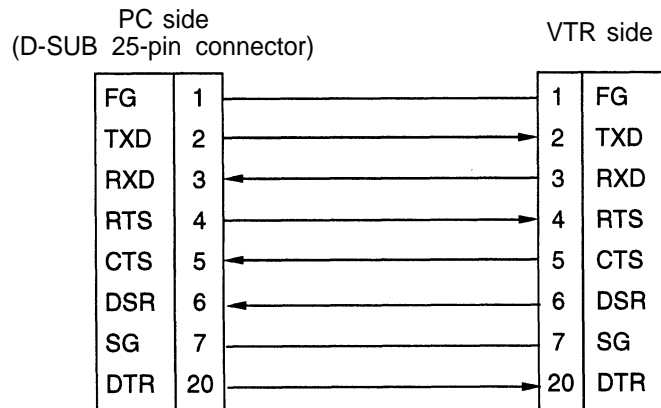

(Using straight cable with D-SUB 9-pin and 25-pin connectors)

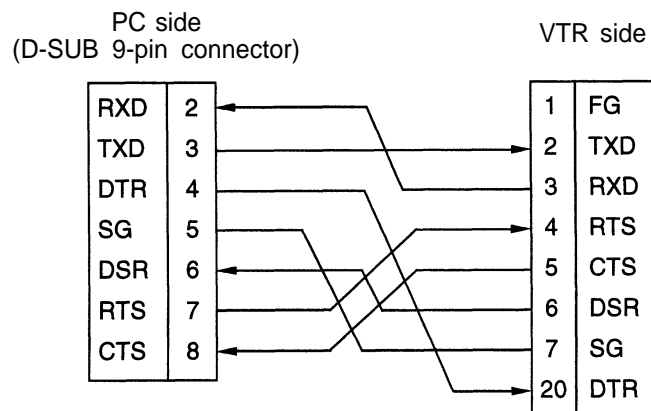

3. Software specifications

1) Protocol

(1) Communication parameters

Communication system	Asynchronous, full duplex
Communication speed	300/600/1200/2400/4800/ <u>9600</u>
Bit length	7 bit/ <u>8 bit</u>
Stop bit	<u>1 bit</u> /2 bit
Parity bit	<u>NONE</u> /ODD/EVEN
ACK code	ACK code returned/ <u>ACK code not returned</u> <Note> The ACK code is what is returned from the VTR to the controller when data has been successfully sent from the controller.

The underlining indicates the factory settings.

Any changes to the settings can be made using the set-up menu items listed below.

Communication parameter	Set-up menu item
Communication speed	No. 205 BAUD RATE
Bit length	No. 206 DATA LENGTH
Stop bit	No. 207 STOP BIT
Parity bit	No. 208 PARITY
ACK code	No. 209 RETURN ACK

(2) Send format [controller (PC) → VTR]

■ Data format

[STX] [command] [:] [data] [ETX]

02h XX XX XX 3Ah XX-XX 03h ← (ASCII code: symbols, numbers, upper-case letters)

20h<XX<7Fh

- [command] :Command identifier; a 3-byte identifier (ASCII code: symbols, numbers, upper-case letters) is sent as the command.
- [:] :This code serves as a delimiter between the command and data.
- [data] :Data (ASCII code: symbols, numbers, upper-case letters) can be added in the number of bytes required.

■ Outline of send procedure from controller

1. The send command starts with STX (start of text = 02h). The command is then identified by COMMAND which follows and the data is added as required.
The format ends with ETX (end of text = 03h).
2. When a different command is to be sent, a response is awaited from the VTR, and then the command is sent. (See page E-9)
3. If STX is sent again before ETX is sent, the receive data buffer inside the VTR is cleared. A command error is returned to the controller, and the data is newly processed with STX which was received again at the head.

(3) Return format [VTR → controller (PC)]

The following responses are made to the command. If necessary, more than one response is made.

■ When the communication has terminated normally

1. The receive completion message is returned.

[ACK]
06h

2. The execution completion message is returned.

[STX] [command] [data] [ETX]
02h XX XX XX XX-XX 03h

- [command] : This is the message (data) which is returned or the execution completion message identifier.
- [data] : This is the data to be returned. It can be omitted.

Example: Send command Return message (data)
 [STX] OPL [ETX] → [ACK] [STX] OPL [ETX]

■ When the communication has terminated abnormally

[NACK]
15h

■ When processing is not possible due to incorrect data or trouble in the VTR

1. The receive completion message is returned.

[ACK]
06h

2. An error code is returned.

[STX] E R N₁ N₂ N₃ [ETX]
02h Error code 03h

4. Error code table

ER001	: Invalid command
	• Unsupported command received.
	• Error in command execution
ER002	: Parameter error
ER102	: VTR mode error (front loading motor)
ER103	: VTR mode error (loading motor)
ER104	: VTR mode error (drum, capstan system)
ER105	: VTR mode error (reel system)
ER106	: VTR mode error (tension system)
ER108	: VTR dew error
ER1FF	: VTR system error

5. Command table

1) Commands relating to operation control

<Notes>

- As for the return (completion) message, [ACK] is first returned when data is received, and the execution message is subsequently returned. It is only the execution message which is listed in this table.
- In the case of commands not listed in the table, ER001 (invalid command) is returned after [ACK] has been returned.

VTR operation	Send command	Return (completion) message	Supplementary notes
STOP	[STX] OSP [ETX]	[STX] OSP [ETX]	This command is for stopping the tape travel. The resulting output picture and sound statuses differ according to the settings selected for the set-up menus given below. <ul style="list-style-type: none"> • AJ-D750: No.105 (AUTO EE SEL) • AJ-D650, AJ-D640: No.111 (STOP EE SEL) For further details, refer to the set-up menus.
EJECT	[STX] OEJ [ETX]	[STX] OEJ [ETX]	This command is for ejecting the cassette tape. The resulting output picture and sound statuses differ according to the settings selected for the set-up menus given below. <ul style="list-style-type: none"> • AJ-D750: No.105 (AUTO EE SEL) • AJ-D650, AJ-D640: No.109 (EJECT EE SEL) For further details, refer to the set-up menus.
PLAY	[STX] OPL [ETX]	[STX] OPL [ETX]	This command is for starting playback.
REWIND	[STX] ORW [ETX]	[STX] ORW [ETX]	This command is for rewinding the tape. The resulting output picture and sound statuses differ according to the settings selected for the set-up menus given below. <ul style="list-style-type: none"> • AJ-D750: No.105 (AUTO EE SEL) • AJ-D650, AJ-D640: No.110 (F/R EE SEL) The maximum tape speed differs according to the setting selected for set-up menu No.102 (FF. REW MAX). For further details, refer to the set-up menus.
FAST FORWARD	[STX] OFF [ETX]	[STX] OFF [ETX]	This command is for fast forwarding the tape. The resulting output picture and sound statuses differ according to the settings selected for the set-up menus given below. <ul style="list-style-type: none"> • AJ-D750: No.105 (AUTO EE SEL) • AJ-D650, AJ-D640: No.110 (F/R EE SEL) The maximum tape speed differs according to the setting selected for set-up menu No.102 (FF. REW MAX). For further details, refer to the set-up menus.
REC	[STX] ORC [ETX]	[STX] ORC [ETX]	This command is for starting the recording.

VTR operation	Send command	Return (completion) message	Supplementary notes
SHTL FORWARD	[STX] OSF:data [ETX]	[STX] OSF [ETX]	This is the forward direction shuttle command.
	<p>data = n: speed data 0: STILL 1: x0.03 (DVCPRO), x0.03 (DV, DVCAM) 2: x0.1 (DVCPRO), x0.1 (DV, DVCAM) 3: x0.2 (DVCPRO), x0.3 (DV, DVCAM) 4: x0.5 (DVCPRO), x0.5 (DV, DVCAM) 5: x 1 (DVCPRO), x1 (DV, DVCAM) 6: x1.85 (DVCPRO), x1.85 (DV, DVCAM) 7: x4.1 (DVCPRO), x3.1 (DV, DVCAM) 8: x9.5 (DVCPRO), x9.5 (DV, DVCAM) 9: x16 (DVCPRO), x16 (DV, DVCAM): This speed differs according to the setting selected for set-up menu No.101 (SHTL MAX). A: x32 (DVCPRO), x32 (DV, DVCAM): This speed differs according to the setting selected for set-up menu No.101 (SHTL MAX).</p>		
SHTL REVERSE	[STX] OSR:data [ETX]	[STX] OSR [ETX]	This is the reverse direction shuttle command.
	<p>data = n: speed data 0: STILL 1: x0.03 (DVCPRO), x0.03 (DV, DVCAM) 2: x0.1 (DVCPRO), x0.1 (DV, DVCAM) 3: x0.2 (DVCPRO), x0.3 (DV, DVCAM) 4: x0.5 (DVCPRO), x0.5 (DV, DVCAM) 5: x1 (DVCPRO), x1 (DV, DVCAM) 6: x1.85 (DVCPRO), x1.85 (DV, DVCAM) 7: x4.1 (DVCPRO), x3.1 (DV, DVCAM) 8: x9.5 (DVCPRO), x9.5 (DV, DVCAM) 9: x16 (DVCPRO), x16 (DV, DVCAM): This speed differs according to the setting selected for set-up menu No.101 (SHTL MAX). A: x32 (DVCPRO), x32 (DV, DVCAM): This speed differs according to the setting selected for set-up menu No.101 (SHTL MAX).</p>		
STANDBY OFF	[STX] OBF [ETX]	[STX] OBF [ETX]	This command is for setting the VTR to standby OFF.
STANDBY ON.	[STX] OBN [ETX]	[STX] OBN [ETX]	This command is for setting the VTR to standby ON.

2) Commands relating to inquiries

<Notes>

- As for the return (completion) message, [ACK] is first returned when data is received, and the execution message is subsequently returned. It is only the execution message which is listed in this table.
- In the case of commands not listed in the table, ER001 (invalid command) is returned after [ACK] has been returned.

VTR operation	Send command	Return (completion) message	Supplementary notes
CTL/TC DATA REQUEST	[STX] QCD [ETX]	[STX] CD data [ETX]	This command is for inquiring about the counter value.
		data = f w gh mm ss ff f = F w = S gh = CTL: g = SP (20h): for a plus display - (2Dh): for a minus display h = 0~9: hours TC: gh = 00~23: hours mm = 00~59: minutes ss = 00~59: seconds ff = 00~29: frames (NTSC) 00~24: frames (PAL)	CTL or TC is returned, whichever corresponds to the front display mode.
STATUS REQUEST	[STX] QOP [ETX]	[STX] xxx [ETX]	This command is for inquiring about the VTR's operation mode.
		xxx = O E J : EJECT OFF: FAST FORWARD OPL: PLAY ORC: R E C ORW: REWIND OSP: STOP (including the STANDBY ON) SRS: (IN/OUT) PREROLL OBF: STANDBY OFF OSF: SHTL FORWARD OSR: SHTL REVERSE OJG: JOG FORWARD/REVERSE OSW: VAR FORWARD/REVERSE EAE: AUTO EDIT EON: EDIT ON (MANUAL EDIT) EPV: PREVIEW ERV: REVIEW	
ID (VTR No.) REQUEST	[STX] QID [ETX]	[STX] data [ETX]	This command is for inquiring about the VTR used.
		data = for NTSC system: AJ-D750, AJ-D650, AJ-D640 for PAL system: AJ-D750E, AJ-D650E, AJ-D640E	

3) Microsoft QuickBASIC sample program

```
CLS
STX$ = CHR$(&H2): ETX$ = CHR$(&H3): NAK$ = CHR$(15): ACK$ = CHR$(&HG)
PRINT "*** RS-232C COMMUNICATION SAMPLE PROGRAM ***"
PRINT "Type Command 'QUIT' to quit."
PRINT

REM *** Communication Port Initial & Open ***
REM Port 1,9600Bps,No parity, 8 bit data,1 stop bit
OPEN "COM1:9600,N,8,1" FOR RANDOM AS #1 LEN = 256

REM *** Input Command & Send Command ***
SendCmd:
INPUT "Input Command ="; SEND$
IF SEND$ = "QUIT" THEN GOTO ProgEnd
PRINT #1, STX$ + SEND$ + ETX$

REM *** Wait for Receive Command ***
WHILE LOC(1) = 0
    WAITKEY$ = INKEY$
    IF WAITKEY$ = "Q" THEN PRINT "**** Quit ****": GOTO ProgEnd
WEND

REM *** Receive Command ***
RecvCmd:
RCV$ = INPUT$(1, #1)
IF RCV$ = STX$ THEN RCV$ = "[Stx]"
IF RCV$ = ACK$ THEN RCV$ = "[Ack]"
IF RCV$ = NAK$ THEN RCV$ = "[Nak]"
IF RCV$ = ETX$ THEN BUFFER$ = BUFFER$ + "[Etx]": GOTO DispOut
BUFFER$ = BUFFER$ + RCV$
GOTO RecvCmd

REM *** Output Receive Command ***
DispOut:
PRINT "Receive Command ="; BUFFER$
PRINT
BUFFER$ = ""
GOTO SendCmd

REM *** End Program ***
ProgEnd:
CLOSE
END
```

Free Manuals Download Website

<http://myh66.com>

<http://usermanuals.us>

<http://www.somanuals.com>

<http://www.4manuals.cc>

<http://www.manual-lib.com>

<http://www.404manual.com>

<http://www.luxmanual.com>

<http://aubethermostatmanual.com>

Golf course search by state

<http://golfingnear.com>

Email search by domain

<http://emailbydomain.com>

Auto manuals search

<http://auto.somanuals.com>

TV manuals search

<http://tv.somanuals.com>