

Panasonic

DVCPRO HD

Digital HD Video Cassette Recorder

AJ-**HD150**P

Operating Instructions

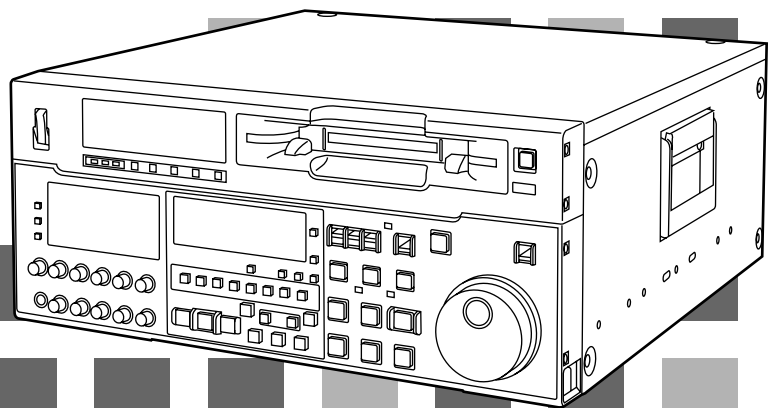

IMPORTANT

“Unauthorized recording of copyrighted television programs, video tapes and other materials may infringe the right of copyright owners and be contrary to copyright laws.”



The lightning flash with arrowhead symbol, within an equilateral triangle, is intended to alert the user to the presence of uninsulated “dangerous voltage” within the product’s enclosure that may be of sufficient magnitude to constitute a risk of electric shock to persons.



The exclamation point within an equilateral triangle is intended to alert the user to the presence of important operating and maintenance (servicing) instructions in the literature accompanying the appliance.

CAUTION:
TO REDUCE THE RISK OF FIRE OR SHOCK HAZARD AND ANNOYING INTERFERENCE, USE THE RECOMMENDED ACCESSORIES ONLY.

CAUTION:
Do not install or place this unit in a bookcase, built-in cabinet or in another confined space in order to keep well ventilation condition. Ensure that curtains and any other materials do not obstruct the ventilation condition to prevent risk of electric shock or fire hazard due to overheating.

WARNING:
TO REDUCE THE RISK OF FIRE OR SHOCK HAZARD, DO NOT EXPOSE THIS EQUIPMENT TO RAIN OR MOISTURE.

CAUTION:
TO REDUCE THE RISK OF FIRE OR SHOCK HAZARD, REFER MOUNTING OF THE OPTIONAL BOARD TO AUTHORIZED SERVICE PERSONNEL.

FCC Note:
This device complies with Part 15 of the FCC Rules. To assure continued compliance follow the attached installation instructions and do not make any unauthorized modifications.

This equipment has been tested and found to comply with the limits for a Class A digital device, pursuant to Part 15 of the FCC Rules. These limits are designed to provide reasonable protection against harmful interference when the equipment is operated in a commercial environment. This equipment generates, uses, and can radiate radio frequency energy and, if not installed and used in accordance with the instruction manual, may cause harmful interference to radio communications. Operation of this equipment in a residential area is likely to cause harmful interference in which case the user will be required to correct the interference at his own expense.

is the safety information.

- Do not insert fingers or any objects into the video cassette holder.
- Avoid operating or leaving the unit near strong magnetic fields. Be especially careful of large audio speakers.
- Avoid operating or storing the unit in an excessively hot, cold, or damp environment as this may result in damage both to the recorder and to the tape.
- Do not spray any cleaner or wax directly on the unit.
- If the unit is not going to be used for a length of time, protect it from dirt and dust.
- Do not leave a cassette in the recorder when not in use.
- Do not block the ventilation slots of the unit.

- Use this unit horizontally and do not place anything on the top panel.
- Cassette tape can be used only for one-side, one direction recording. Two-way or two-track recordings cannot be made.
- Cassette tape can be used for either Color or Black & White recording.
- Do not attempt to disassemble the recorder. There are no user serviceable parts inside.
- If any liquid spills inside the recorder, have the recorder examined for possible damage.
- Refer any needed servicing to authorized service personnel.

Contents

General and Features	4	Setup (default settings)	46
Controls and their functions	6	Setup menus	47
• Front panel	6	• SYSTEM menu	51
• Connector area	15	• USER menu	53
Operations using the front panel bottom controls	18	• BASIC menu	53
Operations using the front panel top controls	21	• OPERATION menu	56
Connections	24	• INTERFACE menu	59
• Connections when one unit is used	24	• EDIT menu	61
• Connections when 2 units are used (deck to deck)	25	• TAPE PROTECT menu	64
• Connections with editing controller	26	• TIME CODE menu	65
Tapes	27	• VIDEO menu	67
Switching on the power/inserting the cassette	28	• AUDIO menu	70
STOP/STAND BY mode	29	• MENU menu	77
Recording	30	Time code/user bit	78
Playback	31	Recording internal/external time codes	79
Jog/shuttle	32	Reproducing the time code/user bit	80
Manual editing	33	Superimpose screen	81
Preroll	34	Audio recording channel and monitor output selection	82
Automatic editing (deck to deck)	35	Printed circuit board	83
• Switch settings and adjustments	36	Rack mounting	84
• Selecting the editing mode	37	Video Head cleaning	85
• Entering the edit points	38	Condensation	85
• Checking the edit points	39	Error messages	86
• Modifying the edit points	40	Table of AUTO OFF Error messages	88
• Preview	41	RS-232C interface	90
• Executing automatic editing	42	Connector signals	97
• Review	43	Specifications	99
Audio split editing	44		

Before operating this unit, check that all of its accessories are present and accounted for.

Power cord....1 pc

Options

- AJ-MA75P Rack mounting adapter
- AJ-UDC150P HD-SD format converter

General and Features

This unit is a DVCPRO HD format HD digital video cassette recorder which is designed to use 1/4-inch wide compact cassette tapes.

It is a studio-use digital VTR which can record, play back and edit HD signals (1080i, 59.94 Hz/60 Hz), and can play back tapes recorded using the existing DVCPRO (25 Mbps/50 Mbps) format. Use of the HD-SD conversion facility of the optional format converter enables interfacing with existing SD systems and development into HD systems. This VTR with its high picture quality uses high-efficiency digital compression technology to reduce by a significant margin the degree of deterioration in the sound and picture quality which accompanies dubbing.

The unit features a compact 4U size and lightweight design to make it easier to carry around. It can also be easily installed in a 19-inch rack.

The settings for the unit's setup are performed interactively while viewing the display tube at the top front of the unit or the screen menus shown on a TV monitor. Both assemble and insert editing facilities are provided as editing functions.

Features

Compact size and light weight

This is a 4U digital VTR. Using the rack-mounting adapters (optional accessory: AJ-MA75P), it can also be easily housed in a 19-inch rack.

Up to 46 minutes of recording

The L-size cassettes (max. 46 minutes) are used for recording. The tape is 1/4-inch in width, which makes for a compact design.

High picture quality

The unit's high picture quality is achieved by 4:2:2 HD component signal recording using a recording rate (100 Mbps) which is 4 times higher than that of the existing DVCPRO format.

1080i, 59.94 Hz/60 Hz signal switching

By a process of automatic switching to match the video input signals, each type of signal can be recorded and played back.

SDI interface

The unit comes with an HD serial digital interface as a standard accessory.

Compatibility with DVCPRO

The unit can play back tapes which have been recorded using the existing DVCPRO (25 Mbps/50 Mbps) format.

Furthermore, consumer-use DV tapes (SP) can also be played back on the unit.

Digital slow motion/dial jog

Clear playback at speeds of -1× through to +1× are made possible with Panasonic's own digital-slow technology.

<Note>

Some noise may occur during slow playback (using the external controller) at speeds almost exactly +1× or -1×.

Search speed

Search speed enables the tape to be played back with color images at a speed of up to 50 times the forward and reverse direction.

General and Features

Features

(continued)

Time codes

This unit comes with a built-in time code generator (TCG)/time code reader (TCR). In addition to the internal time code, an external time code can also be recorded as the LTC on the unit's tape.

Multi-functional interfaces

- **Serial digital input and output connector**

The unit features a HD component serial interface input/output connector to enable HD component video signals and 8-channel digital audio signals to be interfaced using just the one BNC connector. (SMPTE292M/BTA S-004)

It is also possible to output SD component serial signals provided that the HD-SD format converter board (optional accessory) is installed. (SMPTE259M-C, 272M, 294M)

- **Analog video output connector**

Composite output connectors are provided as a standard feature. They output composite signals during DVCPRO reciprocal playback, DV playback or down-conversion. At all other times, they output the black burst signal.

- **AES/EBU audio input/output connectors**

Digital audio input/output connectors for 8 channels are featured as a standard accessory.

- **SDTI input/output connector**

Use of the SDTI board (optional accessory) enables interfacing with the compressed component signals still in their original form. (SMPTE 305M)

- **9-pin RS-422A and RS-232C remote control connectors**

In addition to the standard 9-pin serial remote (RS-422A) control connector, the unit is equipped with RS-232C and 50-pin parallel remote control connectors.

The RS-422A facility enables parallel operation if a loop connection has been performed between the unit and another VTR.

8-channel high-sound-quality digital audio

The 8-channel PCM audio allows for not only independent editing and mixing on all eight channels. One channel is provided for the analog CUE track.

Menu-driven setup

The setup settings, which are conducted prior to operating the unit are performed while viewing the setup menus either on the unit's display or a TV monitor.

Controls and their functions

Front panel

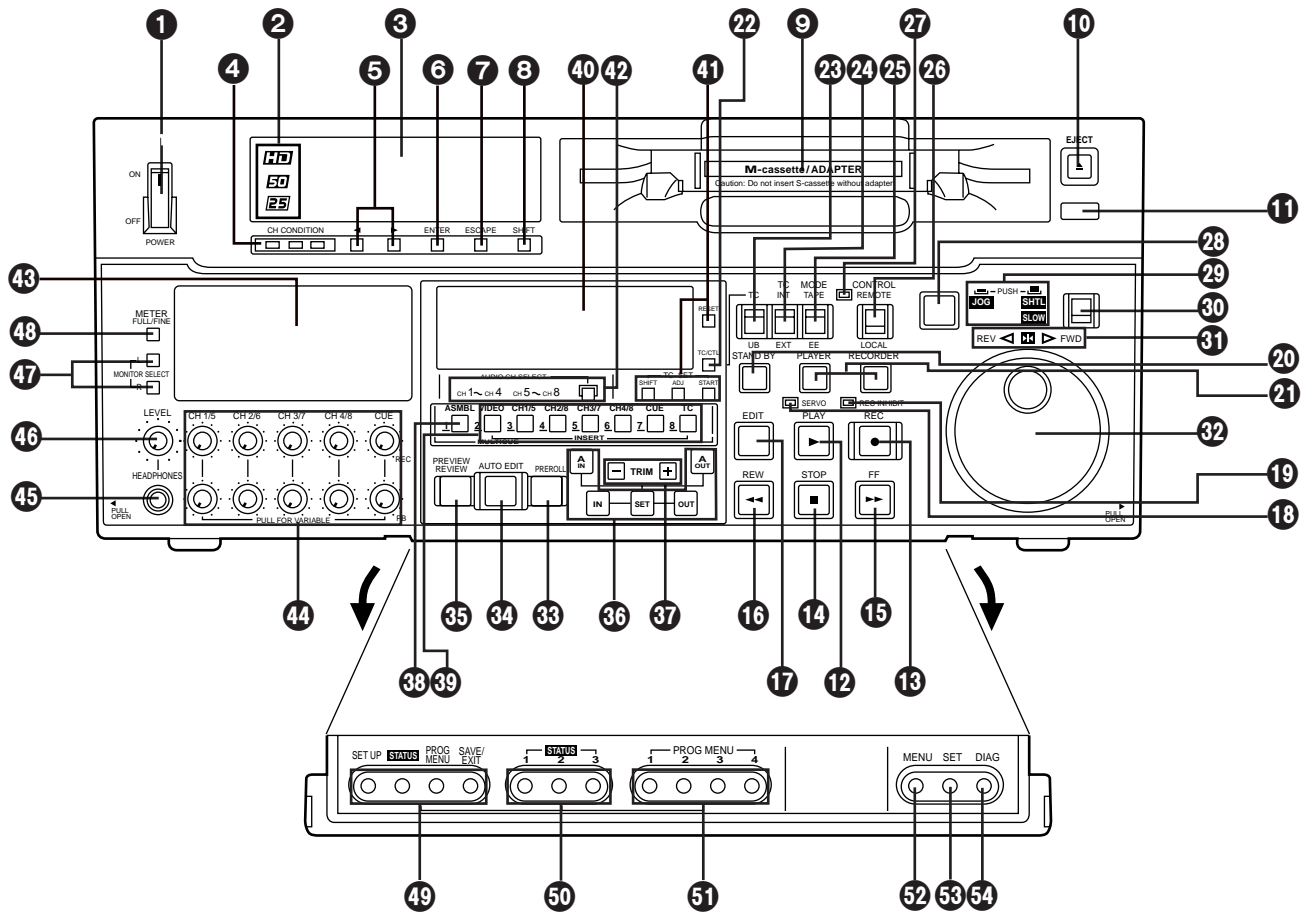

Controls and their functions

<Front Panel Top Section>

① POWER switch

② TV system/format displays

This shows the format during playback.

HD: This indicates that the tape is recorded or played back in the DVCPRO HD format.

50 M: This indicates that the tape is played back in the DVCPRO (50 Mbps) format.

25 M: This indicates that the tape is played back in the DV or DVCAM mode of the DVCPRO (25 Mbps) format.

③ VTR status display area

The VTR's statuses, programmable menus and setup menus appear in this display area.

<Status display>

This indicates the VTR statuses (format, field frequency, video/audio inputs, time code, etc.) which have been defined by the user on the front sub-panel.

<Programmable menu display>

The setup menus which have been defined by the user are displayed on the front sub-panel. Settings can be changed using the ⑤, ⑥, ⑦ and ⑧ buttons.

<Setup menu display>

The setup menus are displayed using the ⑤②, ⑤③ and ⑤④ buttons.

④ Channel condition lamps

One of these lamps lights in accordance with the error rate status. (Green→Amber→Red)

Green: This lights when the error rates for the video and audio playback signals are both acceptable.

Amber: This lights when the error rate for the video or audio playback signals has deteriorated.

The playback picture will remain normal even when this lamp lights.

Red: This lights when the video or audio signals are subject to rectification or interpolation.

⑤ Scroll buttons

These are used for left and right scrolling when the status is displayed in the VTR status display area.

They are used for up and down scrolling when the programmable menu is displayed in the VTR status display area.

⑥ ENTER button

Press this to enter the menu items or the settings when the programmable menu is displayed.

⑦ ESCAPE button

Press this to ignore or cancel the settings when the programmable menu is displayed.

⑧ SHIFT button

The values of programmable menu settings can be changed at high speed by pressing the scroll buttons while holding down the SHIFT button.

⑨ Cassette insertion slot

⑩ EJECT button

When this is pressed, the tape is unloaded and several seconds later the cassette is automatically ejected. When the counter display indicates "CTL", the display is reset.

⑪ AUTO OFF lamp

This lights when trouble has arisen in the deck's operation.

Controls and their functions

<Front Panel Center Section>

12 PLAY button

Playback commences when this button is pressed.

Recording commences when the button is pressed together with the REC button; manual editing commences when it is pressed together with the EDIT button during playback. However, manual editing will not be initiated if the servo is not locked.

Pressing only the PLAY button during manual editing will cut out the editing and establish the playback mode.

13 REC button

Recording commences when this button is pressed together with the PLAY button.

When it is pressed during playback, search^{*1)}, fast forward or rewind, EE mode images and audio signals can be monitored for as long as it is kept depressed.

When it is pressed in the stop mode, EE mode images and sound can be monitored.

When the STOP button is pressed, the original picture and sound are restored.

14 STOP button

When this is pressed, the tape stops traveling, and if the TAPE/EE selector switch is at TAPE, still pictures can be monitored.

The drum continues to rotate even in the stop mode, and the tape remains in close contact with the drum.

If the stop mode continues for more than a certain period of time, the unit automatically switches to the standby OFF mode in order to protect the tape.

The stop mode is established immediately after a cassette has been inserted into the unit.

15 FF button^{*2)}

The tape is fast forwarded when this is pressed.

16 REW button^{*2)}

The tape is rewound when this is pressed.

17 EDIT button

For manual editing, press both this button and the PLAY button together during playback.

When the button is pressed in the stop mode, the input mode signals selected by the ASMBL or INSERT button can be monitored in the EE mode.

The original picture and sound are restored when the STOP button is pressed.

When the button is pressed during playback, search^{*1)}, fast forward or rewind, the input signals of the mode selected by the ASMBL or INSERT button can be monitored in the EE mode for as long as the button is held down.

18 SERVO lamp

This lights when the drum servo and capstan servo have locked.

19 REC INHIBIT lamp

This lights when "1 (ON)" has been selected as the setup menu item No.113 (REC INH) setting or when the cassette has been set to the accidental erasure prevention status.

In this state, neither recording nor editing is possible.

*1) No guarantees are given for the audio playback sound in the search mode.

*2) The FF/REW speed can be selected on the setup menu No. 102 (FF. REW MAX), and it is set to the same speed.

Controls and their functions

<Front Panel Center Section>

20 **STAND BY button**

When this is pressed, the same tension as in the regular stop mode is applied to the tape, and while the head drum continues to rotate, the button's lamp lights to indicate that the standby ON mode is established.

In the standby OFF mode, the half-loading mode is established.

When this button is pressed in the stop mode, the standby OFF mode is established, the half-loading mode is established. The lamp in the button now goes off. When the unit remains in the stop mode for longer than a predetermined period, the standby OFF mode is automatically established in order to protect the tape.

When this button or the STOP button is pressed in the standby OFF mode, the standby ON mode is established.

When a button other than the STOP button is pressed, the mode corresponding to the button pressed is established.

On-screen settings are available for the transfer time to the standby OFF mode.

21 **PLAYER/RECORDER buttons**

These buttons are operated when editing operations are conducted using the unit as the recorder and a VTR equipped with an RS-422A serial interface remote control connector (9 pins). Neither button functions when the unit is used on its own.

PLAYER button: When this button is pressed, its lamp lights, and the player connected to the unit can be operated by remote control. The unit's editing and tape transport buttons now control the player's functions.

RECORDER button: When this button is pressed, its lamp lights, and the editing and tape transport buttons control the recorder's (= the unit's) functions.

Both lamps light, and the recorder functions as the master unit for Parallel Run operations if the PLAYER or RECORDER button is pressed while "ENA" has been selected for setup menu No. 200 (PARA RUN). [However, external control can no longer be exercised from the REMOTE connector (9-pin) when this setting has been made.]

22 **TC/CTL switch**

By pressing this switch, what appears on the counter display is changed between TC and CTL.

When TC is selected, either the TC or UB value is displayed depending on the position selected by the TC/UB switch.

23 **TC/UB switch**

This selector switch determines whether the value of TC or UB appears on the counter display when the TC/CTL switch has been set to TC.

24 **INT/EXT switch**

INT: For using the built-in time code generator.

EXT: At this position, the external time code which is input from the time code input connector is used.

25 **TAPE/EE switch**

<In the stop mode>

TAPE: For outputting the signals played back from the tape.

EE: For outputting the input signals selected by the setup menus No. 600 (VIDEO IN SEL) and No. 700 (AUDIO IN SEL).

<In the editing*/recording mode>

TAPE: For outputting the simultaneous playback signals.

EE: For outputting the input signals selected by the setup menus No. 600 (VIDEO IN SEL) and No. 700 (AUDIO IN SEL).

* The SETUP menu No. 302 (CONFI EDIT) setting is required.

Controls and their functions

<Front Panel Center Section>

26 REMOTE/LOCAL switch

This switch is set when the unit is to be controlled from an external source using the REMOTE connector, RS-232C connector or parallel connector.

REMOTE: Set to this position when controlling the unit by a device connected using the 9-pin REMOTE connector or RS-232C/parallel connector.

LOCAL: Set to this position when controlling the unit using the controls on its own operation panel.

27 REMOTE lamp

This lights when the REMOTE/LOCAL switch has been set to the REMOTE position.

28 Search button

This button is pressed to establish the search mode.

When the search dial is set to the shuttle mode and turned to a particular position, and this button is pressed, playback commences at the speed set by the search dial.

29 JOG/SHTL/SLOW lamps

These indicate the present status of the search dial and SHTL/SLOW switch.

JOG: This lights when the unit is in the JOG mode.

SHTL: This lights when the unit is in the SHTL mode.

SLOW: This lights when the unit is in the SLOW mode.

30 SHTL/SLOW switch

This selector switch is set when the search dial is used for SHTL or SLOW applications.

31 REV/STILL/FWD lamps

One of these lamps lights depending on the operation of the search dial.

REV: This lights when the dial is turned counterclockwise and the tape travels in the REV direction provided that the lamp in the search button has lighted.

STILL: This lights in the JOG mode while the dial is kept stationary, and the tape stops traveling provided that the lamp in the search button has lighted.

It lights in the SHTL mode provided that the dial is at the STILL position.

FWD: This lights when the dial is turned clockwise, and the tape travels in the FWD direction provided that the lamp in the search button has lighted.

32 Search dial

This is used to search for the edit points.

Each time it is pressed, the mode is alternately set to shuttle or jog, and one of the JOG, SHTL and SLOW lamps lights. When the power has been turned on, the dial will not function until it has first returned to the STILL position.

Shuttle mode: When the dial is turned and stopped at a particular position while the SHTL/SLOW switch is at SHTL, the tape can be played back at the speed corresponding to the dial's rotary angle position. A still picture appears at the dial's center position.

Slow mode: When the dial is turned all the way counterclockwise with the SHTL/SLOW switch at SLOW, the tape speed is set to $-4.1\times$ normal speed, when it is set to the center position, a still picture is produced, and when it is turned all the way clockwise, the tape speed is set to $+4.1\times$ normal speed. The speed for SLOW can be set using setup menu No. 308 (VAR FWD MAX) and No. 309 (VAR REV MAX).

Jog mode: The dial clickstops are cleared, and the tape is played back at the speed ($-1\times$ to $+1\times$ normal speed) corresponding to the speed at which the dial is turned.

Controls and their functions

<Front Panel Center Section>

33 PREROLL button

This is used for feeding and cueing the tape for manual editing.

When it is pressed, the tape travels to the preroll point where it stops.

The preroll time can be set on the setup menu No. 000 (P-ROLL TIME).

When this button is pressed together with the IN or OUT button, the tape can be cued to the IN or OUT point entered.

When the AUTO ENTRY on the setup menu No. 305 is set to "ENA", IN point has been entered at the point where the PREROLL button is pressed even if the IN point has not been entered.

34 AUTO EDIT button

Automatic editing is executed when this is pressed after an edit point has been entered.

When the AUTO EDIT button is pressed though the IN point has not been entered, automatic editing is executed using the point at which the button was pressed as the IN point.

35 PREVIEW/REVIEW buttons

PREVIEW: When this is pressed after an edit point has been entered, the tape travels, editing is not performed, and the preview can be activated on the screen connected to the recorder.

If it is pressed when the IN point has not been entered, the point at which the button was pressed is entered as the IN point, and preview is executed accordingly.

REVIEW: If this is pressed after a block has been edited, the now edited block can be played back and monitored on the screen connected to the recorder.

36 IN (A IN)/SET/OUT (A OUT) buttons

When IN (A IN) or OUT (A OUT) button is pressed together with the SET button, the IN (A IN) or OUT (A OUT) point is entered.

A IN and A OUT are used during audio split editing to enter an audio IN or OUT point that differs from the video In or OUT point.

While an IN (A IN) or OUT (A OUT) point is selected, the IN (A IN) or OUT (A OUT) button corresponding to the point entered lights. When this button is pressed after a point has been entered, the IN (A IN) /OUT (A OUT) point value appears on the counter display. When the IN (A IN) or OUT (A OUT) button is pressed together with the RESET button, the IN (A IN) or OUT (A OUT) point is cleared.

37 TRIM buttons

These buttons are used to trim IN or OUT point finely.

When the "+" or "-" button is pressed while the IN or OUT button is held down, the entered edit point can be trimmed in 1-frame increments. When the "+" button is pressed, the tape is advanced by one frame; when the "-" button is pressed, it is rewound by one frame.

38 ASMBL button

This is pressed for assemble editing.

The button is self-illuminating, and it is set ON (lamp lights) when it is pressed once and OFF (lamp goes off) when it is pressed again.

39 INSERT buttons

Press one of these five buttons to select the input signals to be edited during insert editing.

The buttons are self-illuminating, and they are set ON (lamp lights) when they are pressed once and OFF (lamp goes off) when they are pressed again.

The audio channels (CH1 to CH8) are allocated to CH1-4 or CH5-8 using the AUDIO CH SELECT button 42.

Controls and their functions

<Front Panel Center Section>

40 Counter display area

The TC and CTL count values, UB and messages are displayed in this area.

Cassette inserted display lamp:

This lamp lights when a cassette has been inserted into the unit.

DVCPRO format (25 Mbps/50 Mbps) cassette play display lamp:

This lights when a cassette which was recorded using the DVCPRO (25 Mbps/50 Mbps) format is being played back.

SCH lamp:

This lights when the SCH phase of the SD REF signal is within a fixed range.

CF lamp:

This lights when the color framing is locked.

TC/UB lamp:

This flashes when the TC or UB information cannot be read during tape playback; it remains lighted while the information is being read properly.

41 Time code buttons

These are used to set the TC or UB value.

SHIFT: When setting the TC or UB value, first press this button to stop the data running. Change the digit now flashing on the display.

Each time the button is pressed, the flashing moves to the right by one digit, and when it reaches the right-most digit, it returns to the left-most digit.

When it is kept depressed, the flashing moves consecutively.

ADJ: This is used to change the numeral of the digit now flashing on the display.

When the button is pressed once, the number is incremented by 1, and when it is kept depressed, the number is incremented consecutively.

START: This enters the data which has been changed by the SHIFT and ADJ buttons.

Also, Pressing this button when the TC or UB value are not set enables the TCG or UBG setting values to be confirmed.

RESET: When this button is pressed in the CTL mode, the display is reset to "00:00:00:00". In the CTL mode, the entered edit points are cleared.

In the TC/UB mode, the generator is reset when the button is pressed together with the SHIFT button.

42 Audio channel selector button

This button is used to switch the display and control of the CH1-CH4 or CH5-CH8 audio meter and volume and insert buttons.

43 Level meter

This displays the levels of the PCM audio signals for CH1, CH2, CH3 and CH4 (or for CH5, CH6, CH7 and CH8) and CUE track signals.

During recording and E-E selection, it displays the levels of the audio input signals; during playback, it displays the levels of the audio output signals.

44 Audio input/output level controls

These controls are used to adjust the recording and playback levels of the PCM audio signals (CH1/CH2/CH3/CH4/CH5/CH6/CH7/CH8) and the CUE track signal.

The upper controls are for adjusting the recording levels.

The lower controls are for adjusting the playback levels.

Each control is a "pull for variable" control, meaning that the level can be adjusted only when the control has been pulled up. The signal levels are set to the unity value (preset value) when the controls have been pushed down.

Furthermore, when the channels have been switched between CH1-4 and CH5-8 using the AUDIO CH SELECT button 42, the previous information is retained until the controls are next operated.

Controls and their functions

<Front Panel Center Section>

45 Headphones jack

The sound being recorded, played back or edited can be monitored on stereo headphones when they are connected to this jack.

46 Volume control

This is used to adjust the headphones volume and the monitor output volume.

Whether the headphones output and monitor output volumes are to be linked or kept separate can be set on the setup menu No. 713 (MONI OUT). (Note that the headphones output volume is normally linked.)

When the volumes are kept separate, the monitor output is set to the unity value (preset value).

47 MONITOR SELECT switches

These are used to select the audio signals output to the monitor L/R channels.

Each time the “L” button is pressed, the signals output to the monitor L channel are selected in turn in the following order: CH1, CH2, CH3, CH4, CH5, CH6, CH7, CH8, CUE and back to CH1.

[However, this switching is disabled when the channel except OFF has been selected for setup menu No. 734 (MONITOR MIX L).]

Each time the “R” button is pressed, the signals output to the monitor R channel are selected in turn in the following order: CH1, CH2, CH3, CH4, CH5, CH6, CH7, CH8, CUE and back to CH1.

[However, this switching is disabled when the channel except OFF has been selected for setup menu No. 735 (MONITOR MIX R).]

The L or R lamp on the level meter display lights to indicate which signal is now being selected. (When the unit is set to “AUTO” in No. 745 (MONI CH SEL) on the setup menu, then the display will change according to the monitor output.)

The lamp flashes if the channels selected by AUDIO CH SELECT do not appear on the display screen.

48 METER (FULL/FINE) selector switch

This is used to change the scale display (graduations) of the audio level meters.

FULL mode: Standard scale (from $-\infty$ to 0 dB)

FINE mode: The scale changes every 0.5 dB.

49 User assignment switch

This enables the VTR statuses and programmable menus to be registered.

Refer to page 18 for details.

50 Status selector switch

This enables the statuses to be registered by the user assignment switch in 3 ways.

Refer to page 18 for details.

51 Programmable menu selector switch

This enables the programmable menus to be registered by the user assignment switch in 4 ways.

Refer to page 18 for details.

52 MENU button

When this is pressed, the setup menu appears on the TV monitor (when the HD SDI OUT3, SD SDI OUT3 and VIDEO OUT3 connectors are being used).

The setup menu numbers and items are displayed on the unit's top front display area. Press the button again to exit the setup menu settings and return to the original status.

Controls and their functions

<Front Panel Bottom Section>

53 SET button

When this is pressed, the data which has been set on the setup menu is entered. After data entry, the setup menu setting mode is exited and the original operating mode is restored.

54 DIAG button

When this is pressed, VTR information is displayed on-screen. When it is pressed again, the original display is restored.

There are two types of VTR information: "HOURS METER" information and "WARNING" information. Switching between these types is enabled by pressing the search button.

Indicated on the "HOURS METER" screen are the power-on time, drum rotation time, tape travel time, loading count and power ON/OFF time, etc.

Indicated on the "WARNING" screen are the warning

Controls and their functions

Connector area

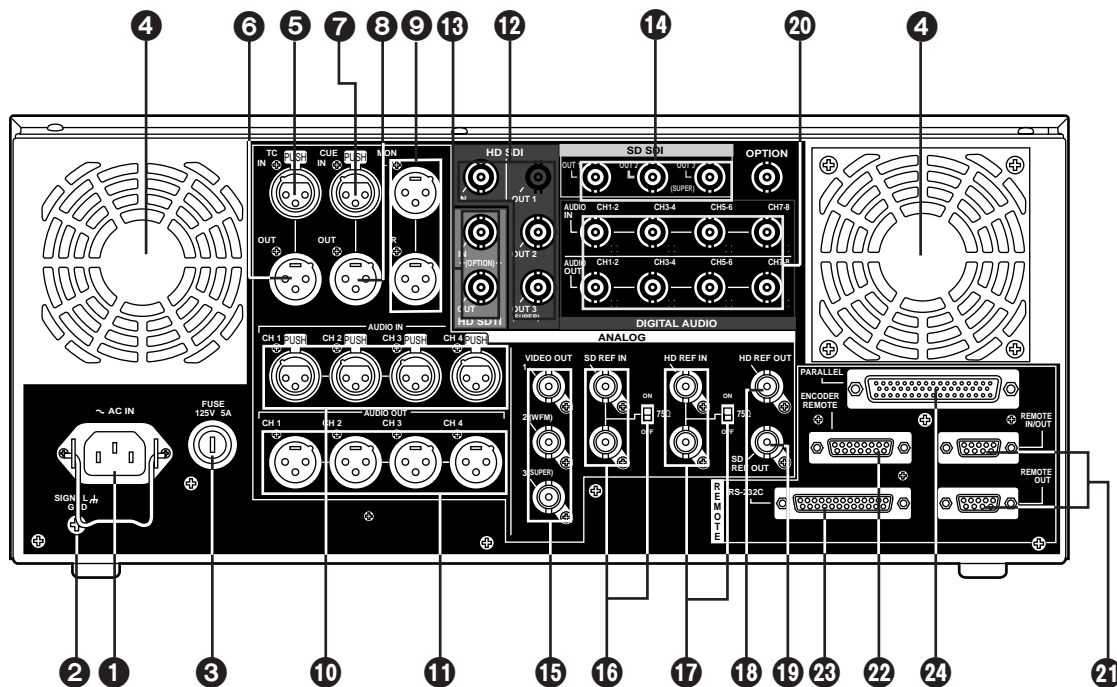

1 AC IN connector

This is for connecting the unit to the power outlet using the power cord provided.

2 SIGNAL GND terminal

This terminal is connected to the signal ground terminal of the connected unit in order to reduce noise. It is not connected to ground for safety purposes.

3 Fuse holder

This contains a fuse.

4 Fan motor

This is for cooling the unit.

The **W** lamp lights when trouble has caused the fan motor to stop. If the unit is still operated in the warning status, the temperature inside the deck will rise, and when it exceeds the safety temperature, all the unit's operations will be shut down.

Controls and their functions

<Connector area>

⑤ TIME CODE IN connector

This is the connector for recording the external time code on the tape.

⑥ TIME CODE OUT connector

The playback time code is output from this connector during playback.

During recording, the time code generated by the internal time code generator is output.

⑦ CUE IN connector

The analog signal to be recorded on the CUE track is supplied to this connector. The audio signals from a microphone can also be recorded by selecting the -60dB input mode on the setup menu No. 705 (CUE IN LV).

⑧ CUE OUT connector

The analog signal recorded on the CUE track is output from this connector.

⑨ MONITOR OUT connector

During playback, the playback signals from the CUE track or PCM audio signal CH1, CH2, CH3, CH4, CH5, CH6, CH7 and CH8 are output from this connector.

⑩ ANALOG AUDIO IN connectors

These are the input connectors for the analog audio signals (CH1, CH2, CH3, CH4).

⑪ ANALOG AUDIO OUT connectors

These are the output connectors for the analog audio signals (CH1, CH2, CH3, CH4).

⑫ HD SERIAL DIGITAL COMPONENT AUDIO VIDEO IN/OUT connectors

These are the input and output connectors for the HD digital component audio and video signals that comply with the SMPTE 292M standard.

The TC, menu or other information is output from the HD SDI OUT3 connector with the information superimposed onto the signals.

⑬ SDTI IN/OUT connectors (optional accessory)

These are the input/output signal connectors for the compressed data that complies with the SMPTE 305M standard.

⑭ SD SERIAL DIGITAL COMPONENT AUDIO VIDEO OUT connectors

These are the output connectors for the digital component audio and video signals that comply with the SMPTE 259M-C, 272M and 294M standards.

The signals are output during the playback of compatible DVCPRO25M, 50M, DV or DVCAM format tapes or during down-conversion output (optional accessory).

The TC, menu or other information is output from the SD SDI OUT3 connector with the information superimposed onto the signals.

⑮ ANALOG COMPOSITE VIDEO OUT connectors

These are the output connectors for the analog composite video signals.

The signals are output during the playback of compatible DVCPRO25M, 50M, DV or DVCAM format tapes or during down-conversion output (optional accessory).

Video signals with information superimposed onto them can be output from the VIDEO OUT3 connector.

Whether information is to be superimposed or not (ON/OFF) is selected by setting the setup menu No.005 (SUPER) item.

The VIDEO OUT2 connector can also be used as the WFM (waveform) OUT connector. TC, CTL, VIDEO, RF L/R and ENV L/R are the signals which can be selected on the menu.

Controls and their functions

<Connector area>

16 SD REF IN connectors and 75-ohm termination switch

These are the input connectors for the SD reference video signals.
Input the NTSC signals with color burst.
To terminate, set the switch to ON.

17 HD REF IN connectors and 75-ohm termination switch

This is the input connectors for the HD reference video signals.
Input tri-level sync signals with positive and negative polarities.
To terminate, set the switch to ON.

18 HD REF OUT connector

This is the output connector for the HD reference video signals used for external synchronization.
It outputs tri-level sync signals with positive and negative polarities.
The field frequency is synchronized with the input signals. (If no signals are input, the frequency follows the menu setting.)

19 SD REF OUT connector

This is the output connector for the NTSC external synchronization signal (black burst signal).

20 DIGITAL AUDIO IN/OUT connector

This I/O connector is for digital audio signals which comply with the AES/EBU standard.

21 Remote control connectors

The unit can be controlled from an external source by connecting the unit with another unit or an external controller.

There are two remote control connectors, one for IN/OUT uses and the other for OUT uses.

IN/OUT: For connection with an external controller.

For connection with deck-to-deck operation.

OUT: For connection with parallel running operations.

For use in a loop-through configuration.

22 ENCODER REMOTE connector

The external encoder/controller is hooked up to this connector when the video output signal and other settings are to be adjusted from an external source.

23 RS-232C connector

24 PARALLEL REMOTE connector

This is used when operating the unit from an external source.

Operations using the front panel bottom controls

The desired status information and setup menu items can be registered in the STATUS 1 to 3 buttons **50** and PROG MENU 1 to 4 buttons **51** by using the SETUP, STATUS, PROG MENU and SAVE/EXIT buttons **49**. Once the information has been registered, it can be indicated on the VTR status display area **3** by pressing the STATUS 1 to 3 buttons **50** or PROG MENU 1 to 4 buttons **51** concerned.

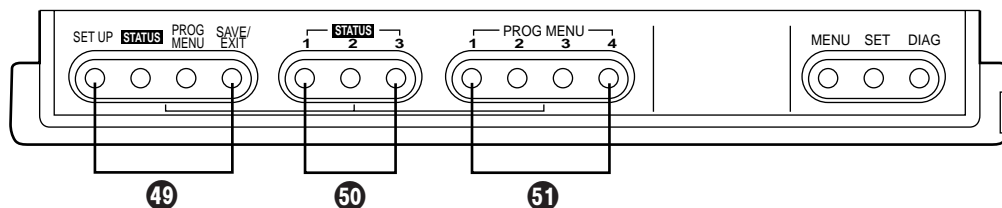

Items which can be registered

The following items can be registered in the buttons.

- **STATUS:** Up to 9 items including the recording format and playback format can be registered in these buttons. (Refer to the VTR status item table for descriptions of the items and contents.)
- **PROG MENU:** Up to 9 items from setup menus in the 000 range to 700 range can be registered in these buttons. However, the submenus of setup menu item No.680 (BLANK LINE) cannot be registered.

Registration method

The items are registered as they are selected by the menu-driven system. Connect the TV monitor to the VIDEO OUT3 connector in the unit's connector area and display the registration menu.

- 1** Press the SETUP button.
The message indicating that the registration steps can now be commenced appears on the TV monitor.

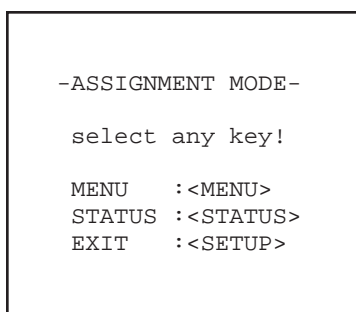

- 2** Select the button which corresponds to the objective.
 - **PROG MENU buttons:** The registration menu for registering the setup menu items in the PROG MENU 1 to 4 buttons is displayed.
 - **STATUS buttons:** The registration menu for registering the VTR status information in the STATUS 1 to 3 buttons is displayed.
 - **SETUP buttons:** This cancels the registration operation.

Operations using the front panel bottom controls

- 3** Turn the search dial and select the item to be registered.
The cursor (*) on the menu screen now moves.

■Example of the menu displayed for registering setup menu items

```
ASSIGN-MENU BASIC
<USER>      NO.000 - 1---
*000 P-ROLL TIME  1---
001 LOCAL ENA     -2--
002 TAPE TIMER    --3-
003 REMAIN SEL    ----
004 SYNCHRONIZE   ----
005 SUPER         ----
006 DISPLAY SEL   ----
007 CHARA H-POS   ----
008 CHARA V-POS   ----
```

■Example of the menu displayed for registering VTR statuses

```
ASSIGN-MENU
<STATUS>    NO.000 - 1---
*000 REC FORMAT  1---
001 REF OUT      -2--
002 PB FLD RATE  --3-
003 REC FLD RATE ----
004 HD OUT       ----
005 SD OUT       ----
006 UFC          ----
END             ----
```

- 4** **When registering setup menu items:** At the position of the item to be registered, select the PROG MENU button (1, 2, 3 or 4) in which the information is to be registered, and press it.
- When registering VTR statuses:** At the position of the item to be registered, select the STATUS button (1, 2 or 3) in which the information is to be registered, and press it.
- The number of the button corresponding to the button that was pressed is now displayed. When the same button is pressed again, the button number display is released.

- 5** To register more items, repeat steps 3 and 4.

- 6** Press the SAVE/EXIT button.
The registered information is now saved in the memory. (When more than one item has been registered, the information will be stored in sequence starting with the lowest item number.)
To return the registered information to the state prior to registration, press the STOP button.

Operations using the front panel bottom controls

■ To return the registered information to the factory settings (initial settings), press the RESET button while the registered menu item is displayed. The following message will appear.

■ Example of the menu displayed for resetting setup menu items which have been registered

```
ASSIGN-MENU INIT SET

select any key!

ALL      <PLAY>
MENU1    <MENU1>
MENU2    <MENU2>
MWNUS    <MENU3>
MENU4    <MENU4>
CANCEL   <STOP>
```

- PLAY button:** Whatever items have been registered in the PROG MENU 1 to 4 buttons **50** are reset to the factory settings.
- PROG MENU 1 to 4 buttons:** The button which was pressed is returned to the non-registration status.
- CANCEL button:** This is for canceling the reset operation.

■ Example of the operation menu displayed for resetting VTR statuses which have been registered

```
ASSIGN-MENU INIT SET

select any key!

ALL      <PLAY>
STATUS1  <STATUS1>
STATUS2  <STATUS2>
STATUS3  <STATUS3>
CANCEL   <STOP>
```

- PLAY button:** Whatever statuses have been registered in the STATUS 1 to 3 buttons **31** are reset to the factory settings.
- STATUS 1 to 3 buttons:** The button which was pressed is returned to the non-registration status.
- CANCEL button:** This is for canceling the reset operation.

Operations using the front panel top controls

What has been registered in the STATUS 1 to 3 buttons **50** and PROG MENU 1 to 4 buttons **51** located at the bottom of the panel can be called to the VTR status display area **3** by pressing the button concerned.

The called item can be operated using the buttons shown below.

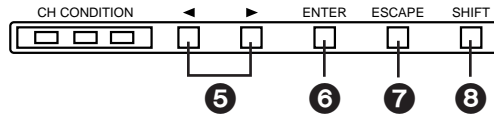

1-1 VTR status displays

When the power is turned on, the information registered in the STATUS 1 button appears on the display, and after this point what is displayed can be switched by pressing the STATUS 1 to 3 buttons **50**.

[Example of status display]

R	E	C	F	R	M		R	E	F	O	U	T
I	0	8	0	i			I	N	T	5	9	

- Each item consists of 6 characters. Three items can be displayed at the same time. The names of the items appear on the first line, and their statuses on the second line.
- When the number of registered items is 4 or more, press the SCROLL buttons **5** to scroll the display to the left or right.
- When the number of registered items is less than 3, “.....” appears in the sections where items have not been registered.

2-1 Registered menu item displays

The registered setup menu items are displayed by pressing the PROG MENU 1 to 4 buttons **51**.

[Example of registered menu item display]

*	P	_	R	O	L	L		T	I	M	E					5	s	
	L	O	C	A	L		E	N	A					S	T	&	E	J

Digit 1: Cursor (*) for selecting items/mark (!) indicating that a setting is being changed

Digits 2 to 13: Name of the menu item (12-character display)

Digit 14: Cursor for selecting item

Digits 15 to 20: Setting (6-character display)

- Two registered menu items can be displayed at the same time.
- When the number of registered items is 3 or more, press the SCROLL buttons **5** to scroll the display up or down.
- The data in the currently selected user file (USER1 to USER5) is reflected in the settings.

Operations using the front panel top controls

2-2 How to change a registered menu setting

Selecting the menu item: Press the SCROLL buttons **5** to move the item selection cursor (*) up or down, and select the menu item.

Transferring to the change mode: Press the ENTER button **6** to transfer to the setting change mode. Whether operation has transferred to the change mode is confirmed by the movement of the item selection marker to digit 14.

Changing the setting: Press the scroll buttons **5** to change the setting. When a change has been made to the current setting, the mark (!) indicating that a setting is being changed appears at digit 1 to indicate the status.

!	P	_	R	O	L	L		T	I	M	E	*				7	s	
	L	O	C	A	L		E	N	A					S	T	&	E	J

- Continue to press one of the SCROLL buttons **5** to increment or decrement the setting automatically. If the item allows for a wide range of variation in its setting, continue to press one of the SCROLL buttons **5** while holding down the SHIFT button **3**, and the setting can be incremented or decremented at a higher speed.

Entering the setting: Press the ENTER button **6** to enter the setting change and return to the menu selection status.

Canceling the change: Press the ESCAPE button **7** to cancel the setting change and return to the menu selection status.

Operations using the front panel top controls

VTR status item table

Name of registration menu item		Item as it appears on VTR status display	Description of display
000	REC FORMAT	REC FMT	This indicates the recording format. 1080i: The tape is recorded using the 1080i format.
001	REF OUT	REFOUT	This displays the output reference status. HD_59: The HD REF input signal has been selected as the reference. The field frequency is 59.94 Hz. HD_60: The HD REF input signal has been selected as the reference. The field frequency is 60 Hz. IN_59: The HD serial input signal has been selected as the reference. The field frequency is 59.94 Hz. IN_60: The HD serial input signal has been selected as the reference. The field frequency is 60 Hz. INT59: The signal from the internal generator (59.94 Hz) is selected as the reference. INT60: The signal from the internal generator (60 Hz) is selected as the reference. INTSC59: The SD REF input signal has been selected as the reference. The field frequency is 59.94 Hz. INT59N: SD REF has been selected by the OUT REF setting. Since the SD REF signal is not input, the signal from the internal generator (59.94 Hz) is used.
002	PB FLD RATE	PB_FLD	This indicates the field frequency at which the recording was made on the tape as ascertained from the tape's playback signals. 59.94: The tape has been recorded at a field frequency of 59.94 Hz. 60: The tape has been recorded with at a field frequency of 60 Hz.
003	REC FLD RATE	RECFLD	This indicates the field frequency at which the recording is to be made on the tape. 59.94: The recording will be made on the tape at a field frequency of 59.94 Hz. 60: The recording will be made on the tape at a field frequency of 60 Hz.
004	HD OUT	HD_OUT	This indicates the format of the HD serial output. 1080i: The HD serial output uses the 1080i format.
005	SD OUT	SD_OUT	This indicates the format of the SD output. 422i: The SD output is in the 422i format. 411i: The SD output is in the 411i format. DV: The SD output is in the DV format. DVCAM: The SD output is in the DVCAM format.
006	UFC	UFC	This indicates the status of HD-SD format converter board (AJ-UDC150P, sold separately). LN_CON: The line converter is operating. IP_CON: The ip converter is operating. UP_CON: The up-converter is operating. DW_CON: The down-converter is operating. NON: HD-SD format converter board (AJ-UDC150P, sold separately) is not installed.

Connections

Connections when one unit is used

Set the CONTROL switch on the front panel to LOCAL.

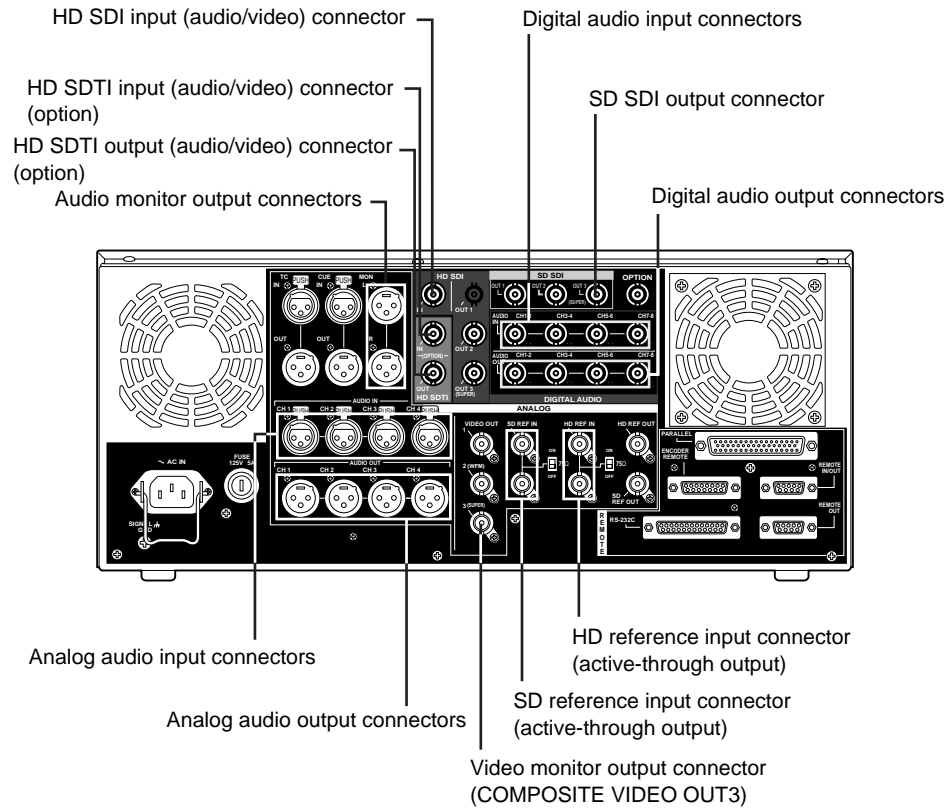

Connections

Connections when 2 units are used (deck to deck)

- Source machine:** • Set the CONTROL switch on the front panel to REMOTE.
Recorder: • Set the CONTROL switch on the front panel to LOCAL.

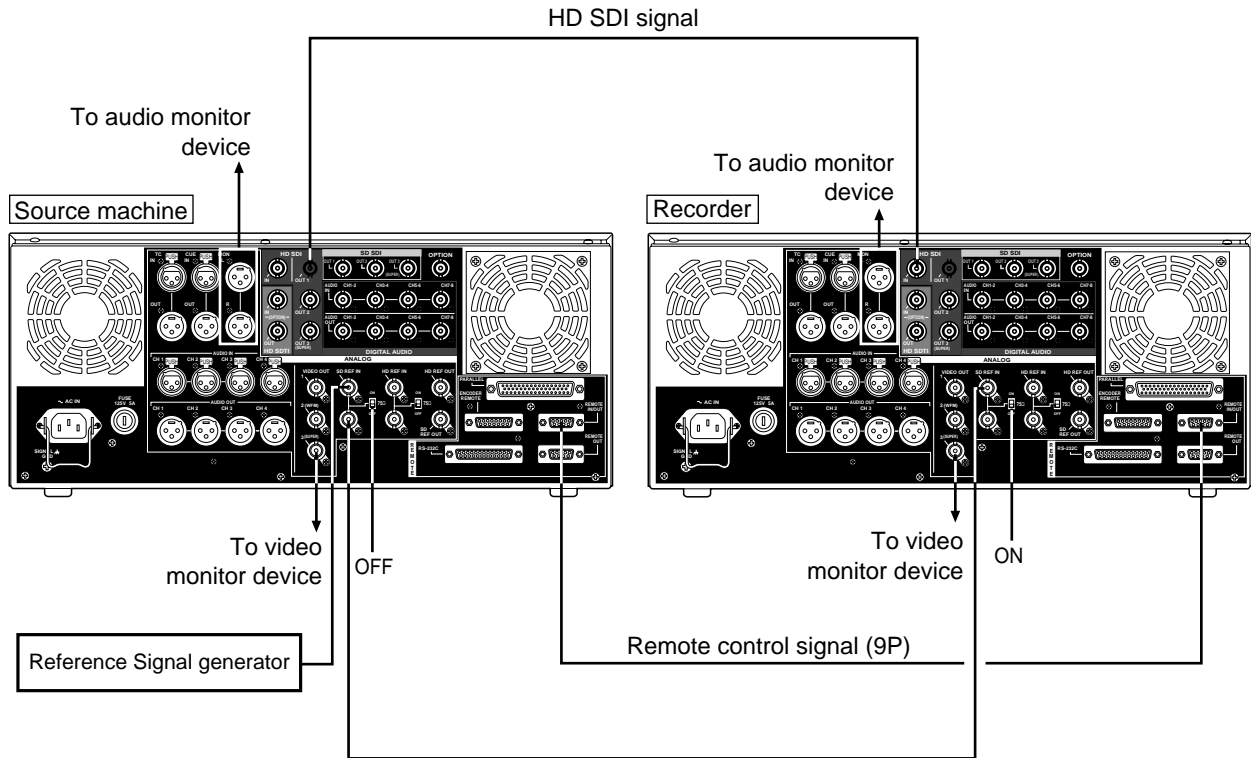

Connections

Connections with editing controller

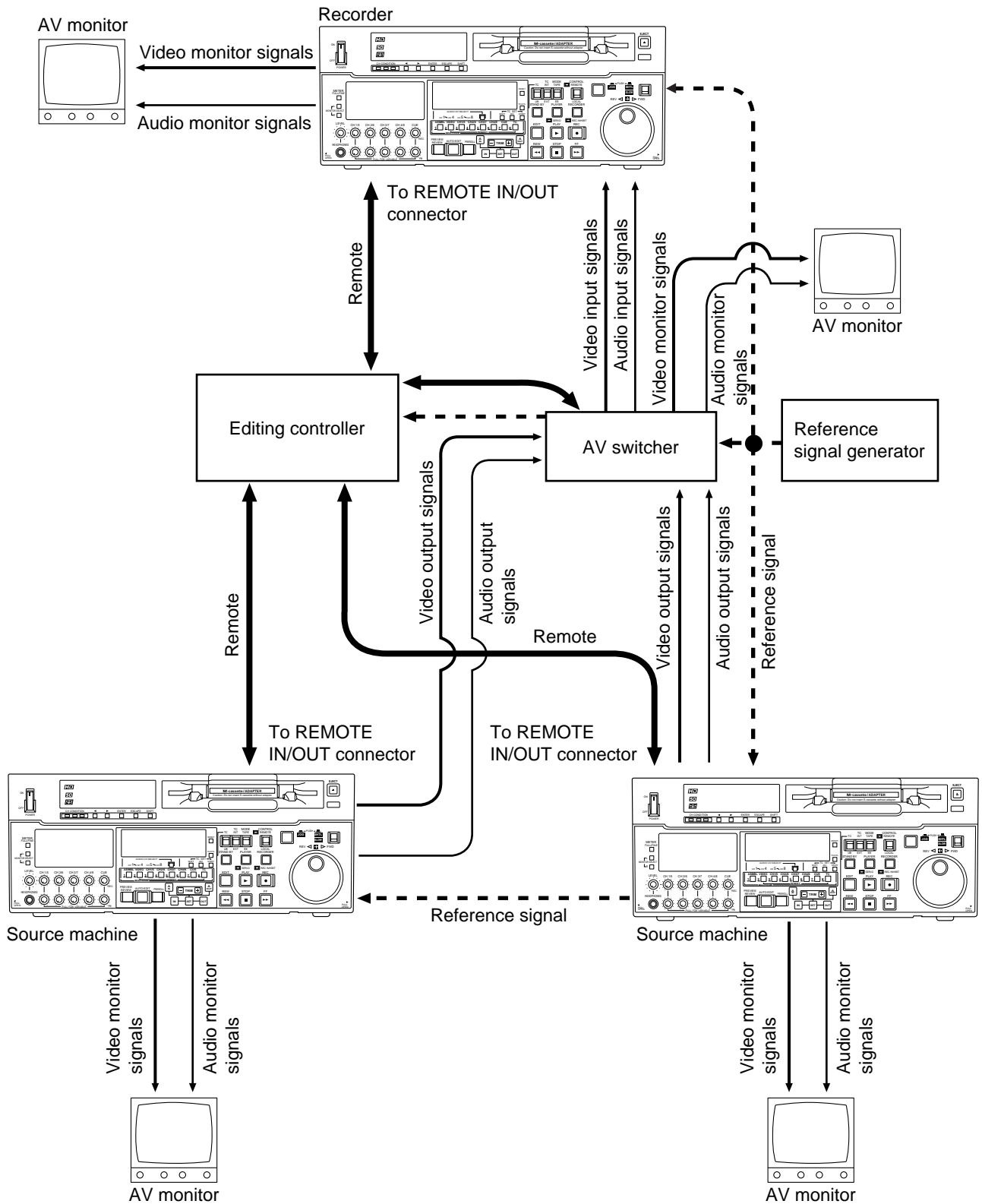

Tapes

Type		Description
Consumer cassette (S size cassette)		<p>These tapes are exclusively used with general consumer camera/recorder. They can be played back on the unit if a cassette adapter AJ-CS750P (available as an optional accessory) is used. However, bear in mind that long-playing cassette tapes (80 minutes in the standard mode; 120 minutes in the LP mode.) cannot be used.</p> <p>It is recommended that Panasonic's DV tapes for general consumer applications be used.</p> <p>Bear in mind that inserting one of these tapes without first installing the cassette adapter will cause malfunctioning.</p>
M size cassette		Tapes with a maximum playback time of maximum of 33 minutes. (AJ-5P23MP, AJ-5P33MP)
L size cassette	DVCPROHD (100 Mbps)	Tapes with a maximum recording/playback time of maximum of 46 minutes. (AJ-HP32LP, AJ-HP46LP)
	For consumer use	<p>Standard playback cassette tapes for consumer use.</p> <p>For playback, select DV as the setup menu No.022 (PB FORMAT) setting.</p> <p>Use of Panasonic's consumer-use DV tapes is recommended.</p>

Align the cassette tape with the center of the insertion slot, and gently push it inside. The cassette tape is automatically loaded.

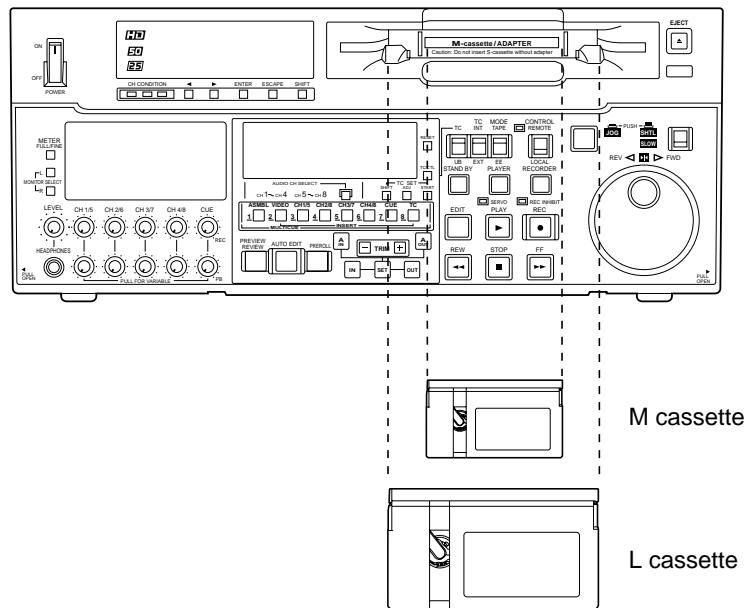

<Notes>

- General consumer tapes recorded in the LP mode cannot be played back.
- The maximum speed at which general consumer tapes can be advanced is 32 times the normal tape speed.
- The maximum STILL mode time for general consumer tapes is set to 10 seconds..
- Cueing up a general consumer tape at the same position should be kept to the minimum in order to protect the tape from damage.
- The maximum time for STILL TIMER when a general consumer tape is used is set to 10 seconds, and the total time during which such a tape may be left standing in the STILL mode is set to 1 minutes.

Switching on the power/inserting the cassette

Before starting to operate the unit, check whether the equipment has been connected properly.

- 1** Turn on the power.
- 2** Check that the AUTO OFF lamp is off.
When condensation has formed or some other trouble has occurred, the AUTO OFF lamp lights, and all operations are disabled.
- 3** Insert the cassette tape.
Insert the tape at its proper position without force.
- 4** Check that the STOP lamp is on.
When the tape is inserted, the cylinder rotates automatically, the tape is loaded and the unit goes into the stop mode. The EJECT lamp goes off.

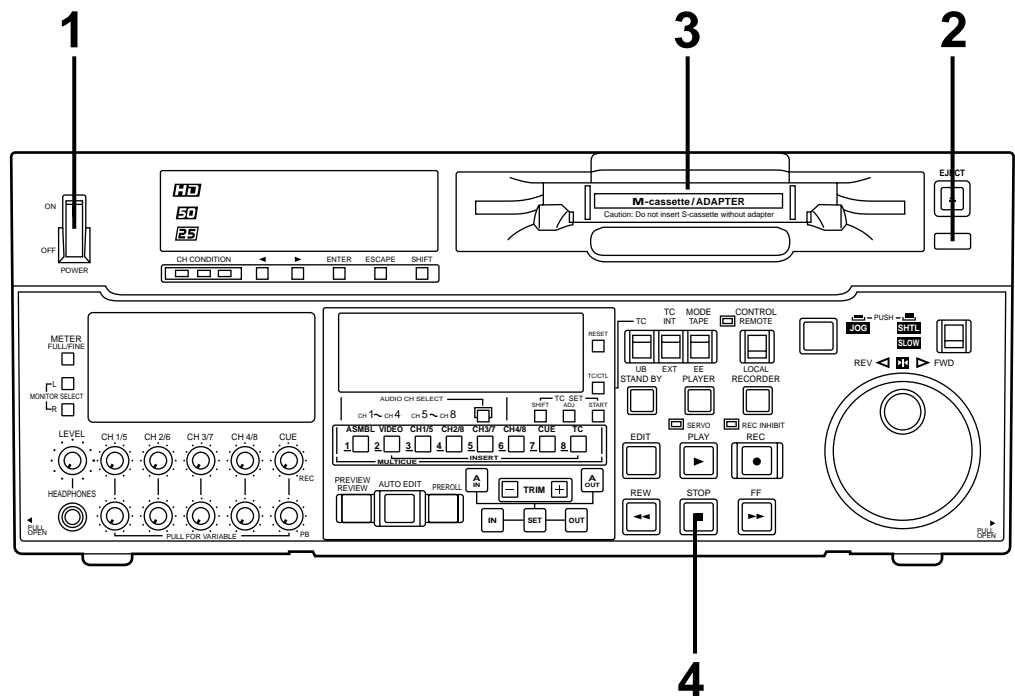

STOP/STAND BY mode

- 1** When the STOP button is pressed, the unit goes into the stop mode. The STOP lamp lights and the tape stops traveling.
 - In order to protect the tape, the unit goes into the standby OFF mode after the time set by setup menu No. 400 (STILL TIMER) has elapsed. When the STOP, REW, FF or PLAY button is pressed, the unit will go into the appropriate mode.
- 2** When the STAND BY button is pressed, the unit goes into the standby ON/OFF mode. When the button's lamp is lighted, the unit is in the standby ON mode. When the button is pressed during the stop mode, the unit goes into the standby OFF mode and half-loading mode and the lamp goes off. When the button is pressed during the standby OFF mode, the unit goes to the standby ON mode.

Still Timer Setting

Page 64 indicates the settings for menu item 400-Still Timer set. Still Timer settings 4 and below will best protect the tape.

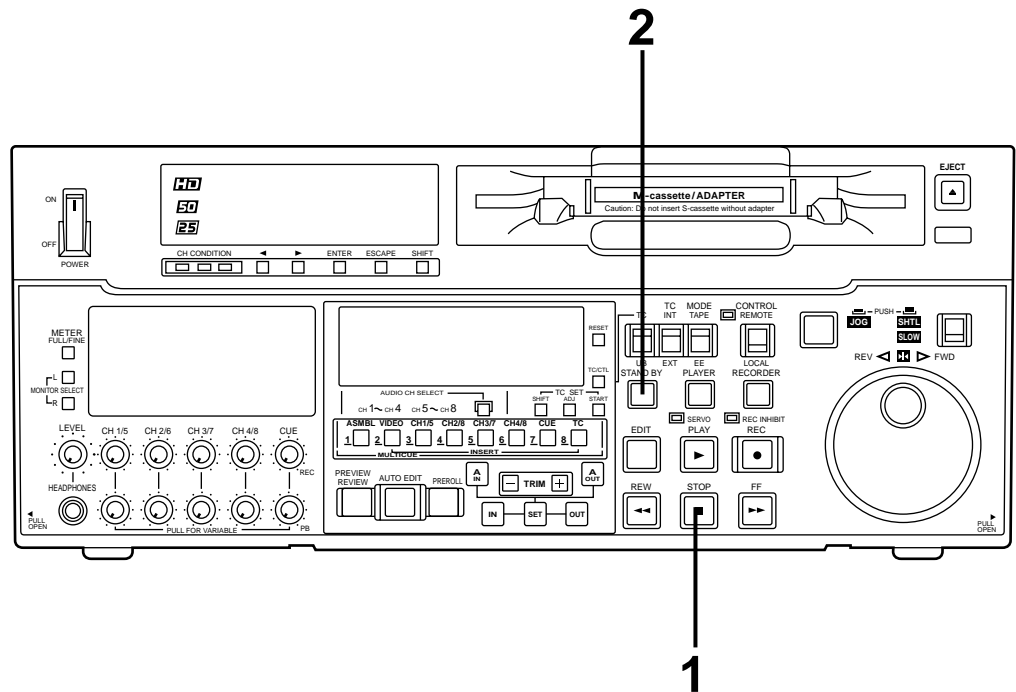

Recording

- 1** Set the accidental erasure prevention tab on the cassette tape to the "recording" position and insert the tape.
- 2** Press the STOP button to place the unit in the stop mode.
- 3** Set the TAPE/EE switch to EE.
EE images now appear on the TV monitor.
- 4** Check that the REC INHIBIT lamp is off.
If this lamp is lighted, set the REC INHIBIT switch to OFF.
- 5** Select the video and audio input signals and adjust their levels.
 - 5-1 Selecting video/audio input signals**
 - 1** Connect the signals to be recorded.
 - 2** Select the input signals on the setup menus No. 600 (VIDEO IN SEL) and NO.700 (AUDIO IN SEL).
 - 5-2 Adjusting the audio level**
 - 1** Adjust the levels of the audio input signals in the audio CH1, CH2, CH3, CH4, CH5, CH6, CH7, CH8 and analog cue channels selected by the setup menu item No.700 setting. Normally, keep the audio input/output level controls **4** pushed in (unity value).
The audio signals will be recorded at the proper level.
 - 2** To adjust the recording level, pull out the controls **4** and adjust them. With the CUE signal, adjust the control in such a way that -20 dB will not be exceeded.
- 6** Press the PLAY button while holding down the REC button. The REC and PLAY lamps light, and recording commences.
- 7** To end the recording, press the STOP button.
Recording is ended, and the unit goes into the stop mode.

<Note>

- Check that the SERVO lamp is lighted during recording. If it flashes or if it is off, the images played back will be disturbed.

Playback

- 1** Insert the cassette tape, and place the unit in the stop mode.
- 2** Press the PLAY button.
Regular playback is now commenced.
- 3** Adjust the audio playback level.
Pull out the audio level controls and turn them clockwise or counterclockwise to adjust the levels. Normally, they are kept in the pushed-in state (unity value).
- 4** To end playback, press the STOP button.
The VTR now goes into the stop mode.

<Note>

- Check that the SERVO lamp is lighted during playback. If it flashes or if it is off, the images played back will be disturbed.

Jog/shuttle

Jog mode

- 1** Push the search dial to the “in” position.
Be sure that the JOG lamp lights.
- 2** Rotate the search dial.
The dial's clickstops are cleared, and the tape is played back at the speed ($-1\times$ to $+1\times$ normal speed) corresponding to the speed at which the dial is turned. When the dial rotation is stopped, a still picture appears. The playback picture is noise-free.
- 3** To transfer from the jog mode to another mode, press the appropriate button.

Shuttle mode

- 1** Push the search dial to release it from the “in” position. The SHTL lamp lights, and the unit goes into the shuttle mode.
 - Immediately after the power has been turned on, rotate the search dial and set it to the center position.
- 2** Set the SHTL/SLOW switch to SHTL or SLOW.
- 3** Rotate the search dial.
When the SHTL/SLOW switch has been set to SHTL, the playback picture speed is varied from 0 to $\pm 32\times$ normal speed depending on the position of the dial. The playback picture speed can be switched to $\pm 8.4\times$, $\pm 16\times$ and $\pm 32\times$ normal speed with setting menu No. 101 (SHTL MAX).
The dial's center position is a clickstop where a still picture appears as the playback image. When the SHTL/SLOW switch has been set to SLOW, the playback picture speed is varied from -4.1 to $+4.1\times$ normal speed depending on the position of the dial. The maximum speed can be selected using the setup menu No. 308 (VAR FWD MAX) and No. 309 (VAR REV MAX). However, noise appears at speeds other than -1 to $+1\times$ normal speed.
The dial's center position is a clickstop where a still picture appears as the playback image. The playback picture is noise-free.
- 4** To transfer from the shuttle mode to another mode, press the STOP button or other button.

<Note>

- When the unit leaves the factory, its operation is set up so that it will be transferred to the shuttle or jog mode when the search dial is rotated. If it is inconvenient for operation to be transferred to the variable-speed mode directly, it can also be transferred through the search button.
Set setup menu No. 100 (SEARCH ENA) to KEY.

Manual editing

- 1** Select the editing mode.
ASSEMBLE: For assemble editing.
INSERT: For insert editing.
- 2** Select the editing channel.
In the case of insert editing, press the channel button corresponding to the signals to be edited, and check that its lamp is on.
- 3** Press the PLAY button.
- 4** Search for the position where the editing is to be commenced (IN point) while viewing the TV monitor, and press the PLAY and EDIT buttons together at the IN point.
- 5** Press the STOP or PLAY button at the position where editing is to be completed (OUT point) while viewing the TV monitor. The unit goes into the stop mode, and editing is completed.

Preroll

- 1** Press the PREROLL button.
The VTR now performs the preroll operation.
 - When the edit IN point has been entered, the tape is rewound from the edit IN point for the duration set by setup menu “000,” and the unit then goes into the stop mode.
 - When the edit IN point has not been entered, the tape is rewound for the duration set by setup menu “000” from the position where the button was pressed, and the unit then goes into the stop mode.

<Notes>

- The time code or CTL signal must be continuously recorded between the edit IN point and preroll point.
- When the IN point has not been entered, whether to enter the IN point and perform preroll or to perform preroll without entering the IN point can be selected at setup menu No. 305 (AUTO ENTRY).

Automatic editing (Deck to Deck)

Editing refers to the job of using a prerecorded tape to produce a complete recording by joining together separate cuts and deleting unnecessary parts.

The basic steps taken for editing are as follows.

- 1** Set the CONTROL switch to REMOTE on the player and to LOCAL on the recorder.
- 2** Select the editing mode.
- 3** Enter the edit points of the recorder and player.
- 4** Check and modify the edit points.
- 5** Check (Preview) before proceeding with the editing.
- 6** Proceed with the editing.
- 7** Check (Review) the recording that has resulted from the editing.

Automatic editing

Switch settings and adjustments

When the unit is used as the recorder:

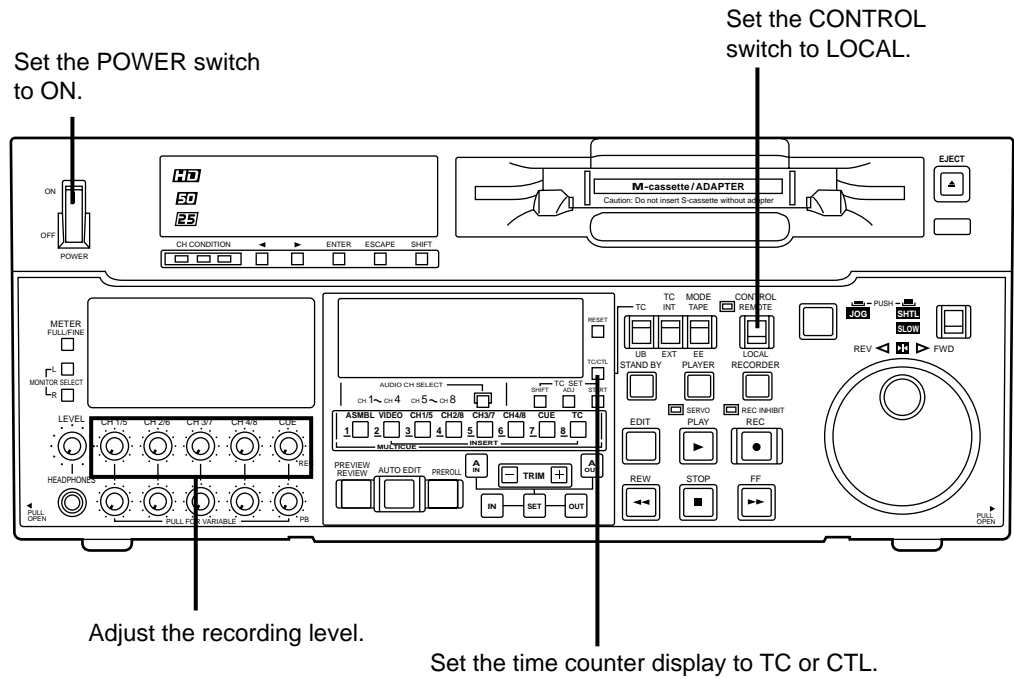

When the unit is used as the player:

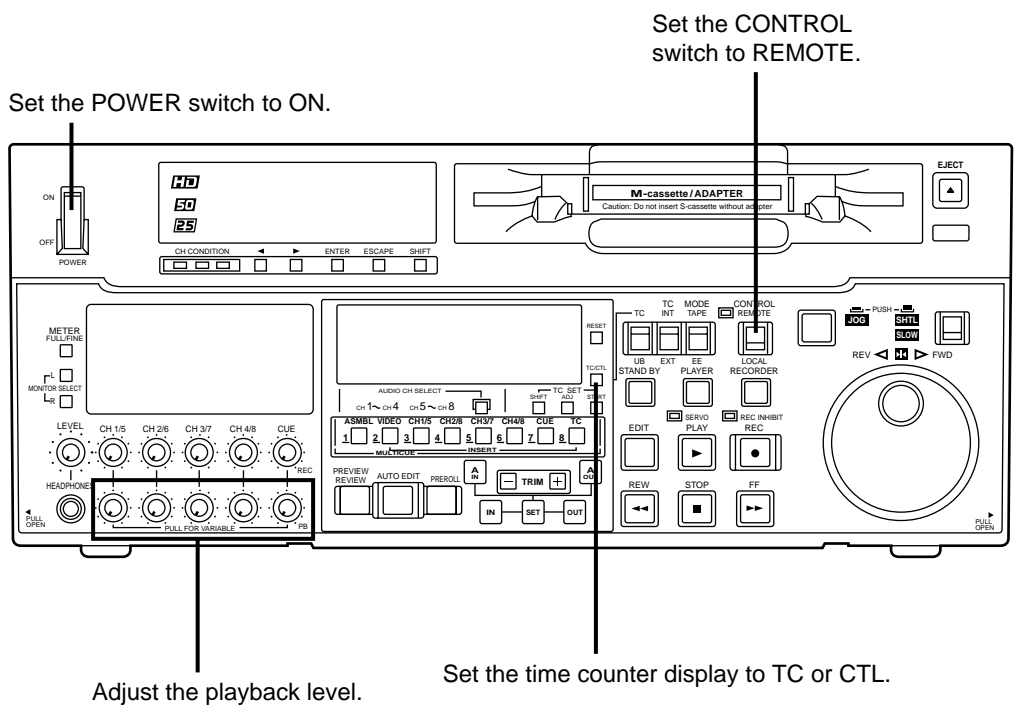

Automatic editing

Selecting the editing mode

- 1** Select the editing mode.
For assemble editing, press the ASMBL button.
For insert editing, press the INSERT button.
ASSEMBLE: The assemble editing mode (in which cuts are joined together) is established.
INSERT: The insert editing mode (in which cuts are inserted) is established.
- 2** Select the editing channel.
With assemble editing, the ASMBL lamp lights.
With insert editing, press the button of the channel whose signals are to be edited and light its lamp.
- 3** Select the VTR to be operated (this setting is performed when editing with 2 VTRs).
Press the PLAYER or RECORDER button to select the VTR.
PLAYER: Press this button to operate the player VTR and enter the edit points.
RECORDER: Press this button to operate the recorder VTR (this unit) and enter the edit points.

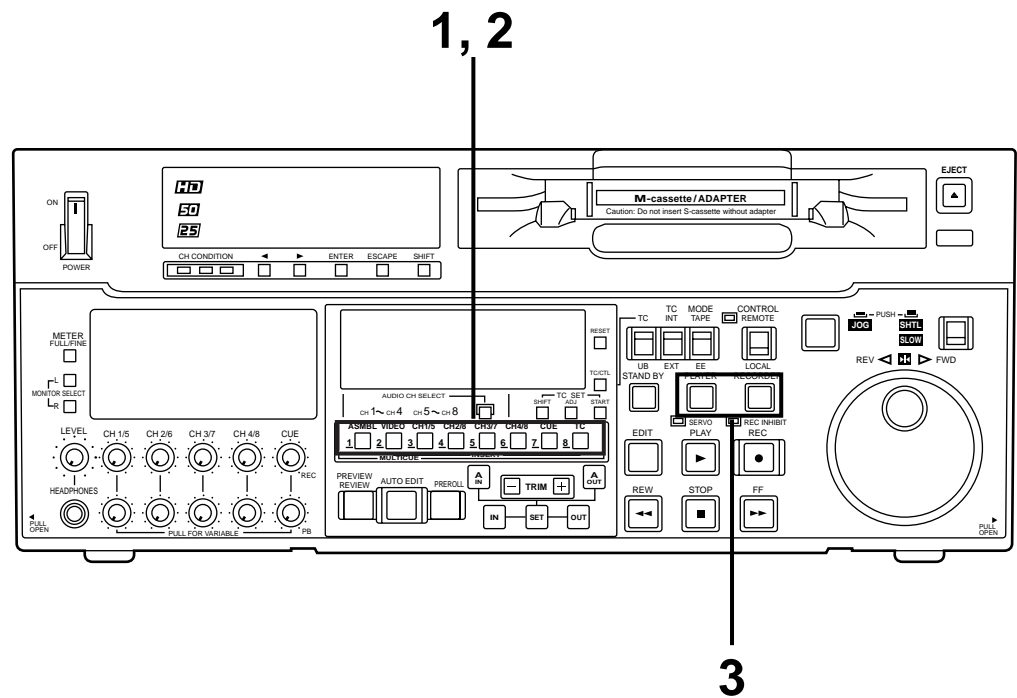

Automatic editing

Entering the edit points

- 1** Search for the edit IN point by performing the jog or shuttle operation. Establish the still picture mode at the desired position. Refer to page 32 for details on the jog/shuttle operations.
- 2** Press the IN and SET buttons together. The edit IN point is now entered. The edit IN point value now appears on the display.
- 3** Search for the edit OUT point by performing the jog or shuttle operation. Establish the still picture mode at the desired position. Refer to page 32 for details on the jog/shuttle operations.
- 4** Press the OUT and SET buttons together. The edit OUT point is now entered. The edit OUT point value now appears on the display.

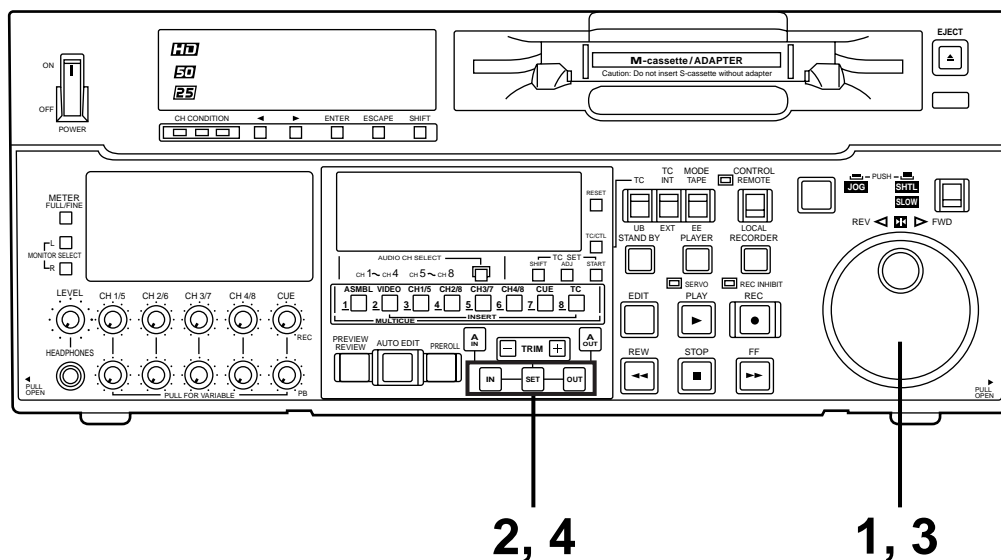

Match frame processing function

When using two VTRs for editing, a total of four edit points—namely, the player's IN and OUT points and the recorder's IN and OUT points—need to be entered. However, since the last edit point is calculated automatically, only three of these edit points must be entered.

Negative duration function

This function is used by combining setup menu No. 300 (IN/OUT DEL) and No. 301 (NEGA FLASH).

Automatic editing

Checking the edit points

- 1** Press the IN (or OUT) button to check the edit point.
The value of the entered edit point appears on the display.
- 2** Press the PREROLL button while holding down the IN (or OUT) button to check the image at the edit point.
The tape is cued at the edit IN (or OUT) point, and the still picture mode at that point is displayed.
 - The EE mode is established if the TAPE/EE switch has been set to the “EE” position when “STOP” has been selected for the setup menu No. 307 (AFTER CUE-UP).
- 3** Press the IN and OUT buttons together to check the edit duration.
The duration time appears on the display.

Calculating the duration

- When both edit points have been set, the duration between the two edit points.
- When only one edit point has been set, the duration between the set data and the current tape address.
- When neither edit point has been set, the duration of the previously edited interval.

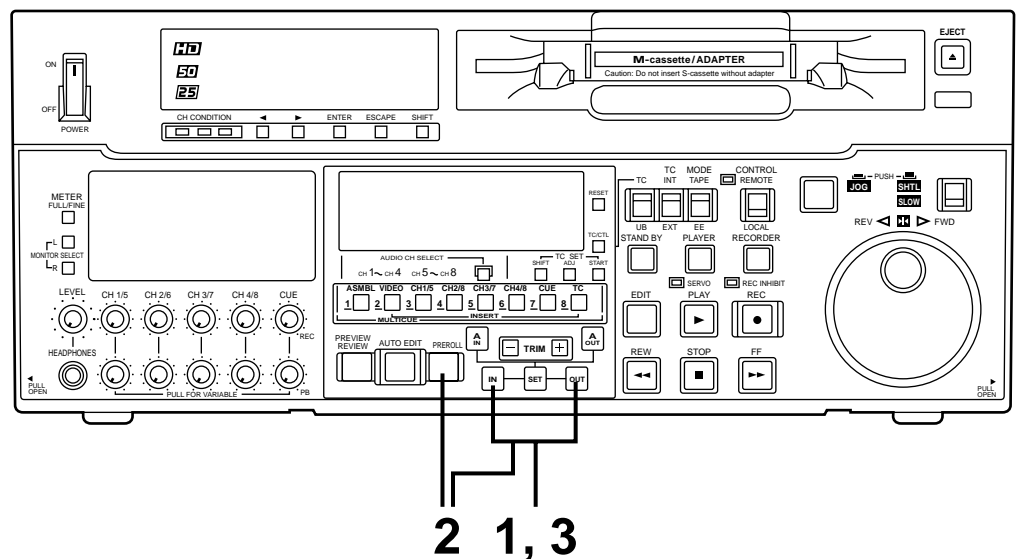

Automatic editing

Modifying the edit points

- 1** Re-entering the edit points
Search for the new edit point by performing the jog or shuttle operation, and press the IN (or OUT) and SET buttons together to re-enter the edit point.
- 2** Modifying the edit point in frame units (trim function)
Press the TRIM button while holding down the IN (or OUT) button.
The edit point is put ahead by 1 frame each time the + button is pressed.
The edit point is put back by 1 frame each time the – button is pressed.
- 3** Resetting the edit points
 - 3-1** Resetting both the edit IN and OUT points
 - Press the RESET button.
 - 3-2** Resetting either the edit IN or OUT point
 - Press the RESET button while holding down the IN (or OUT) button.

<Notes>

- Edit points can be reset only in the CTL mode.
- An edit OUT point can be reset even while editing is in progress.
- The IN and OUT points are automatically reset during the eject mode.

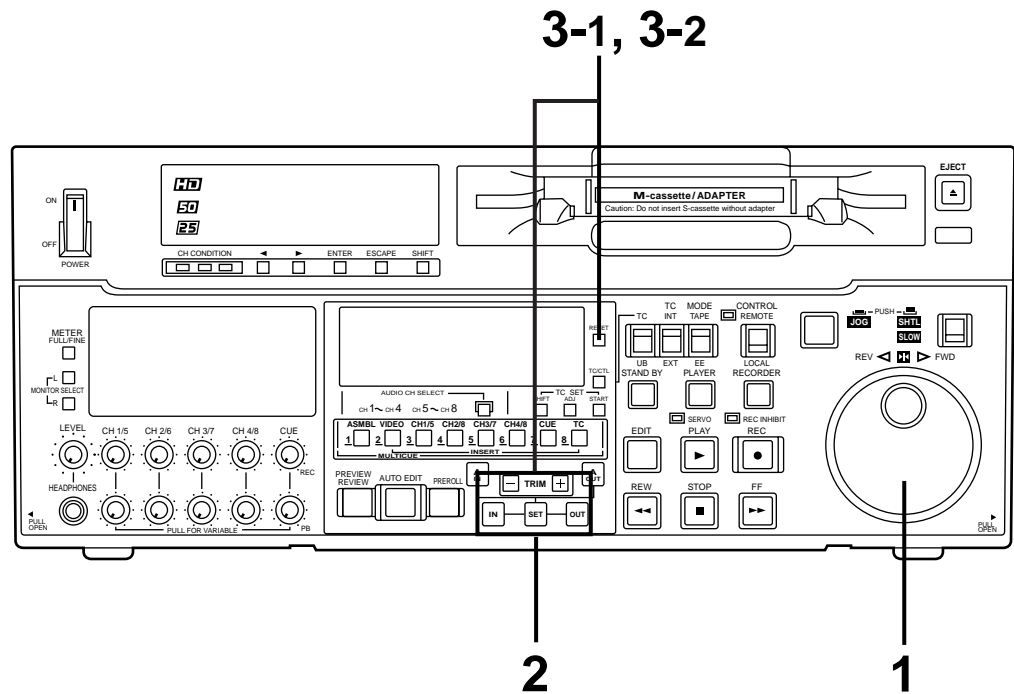

Automatic editing

Preview

- 1 After the edit IN point has been entered, press the PREVIEW button. Normal preview is now performed.

<Notes>

- If the edit IN point has not been entered, the position where the PREVIEW button was pressed will be entered at the edit IN point.
- To stop the preview at any time, press the STOP button.
- If the PREVIEW button is pressed again while preview is in progress after the IN point, preview will start again from the beginning.
- When the edit OUT point is reached, the unit automatically goes into the stop mode.

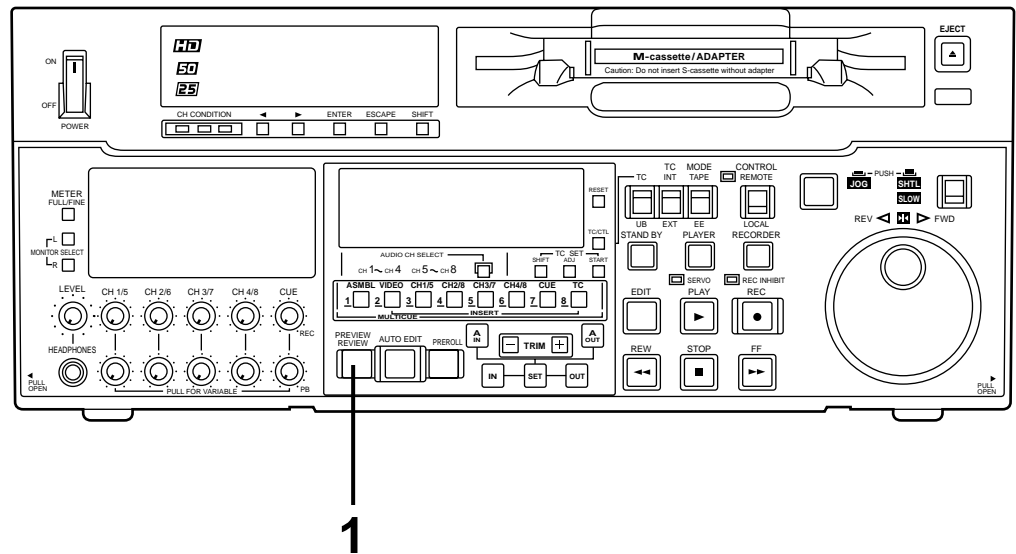

Automatic editing

Executing automatic editing

- 1 Press the AUTO EDIT button.
Automatic editing is now performed.
 - To stop the editing at any time, press the STOP button.
 - When the edit OUT point is reached, the unit goes into the stop mode after postrolling.

Postroll

With assemble editing, editing continues for approx. 2 seconds even after the edit OUT point has been passed, the tape is rewound to the OUT point, and the unit goes into the stop mode.

With insert editing, the unit goes into the play mode after the edit OUT point has been passed, the tape is rewound to the OUT point, and the unit goes into the stop mode.

Retry function

If the AUTO EDIT button is pressed again after the STOP button has been pressed to stop the editing, editing will start again from the beginning.

Auto tag editing

If the AUTO EDIT button is pressed when the next edit point has not yet been entered upon completion of editing, the previous edit OUT point will be entered as the IN point, and editing is performed accordingly.

To release the auto tag mode, press one of the tape transport buttons (PLAY, etc.).

<Note>

- The entered points are automatically cleared after editing is executed. However, the previous editing points can be recalled by pressing the TRIM+ (or TRIM-) and SET buttons together.

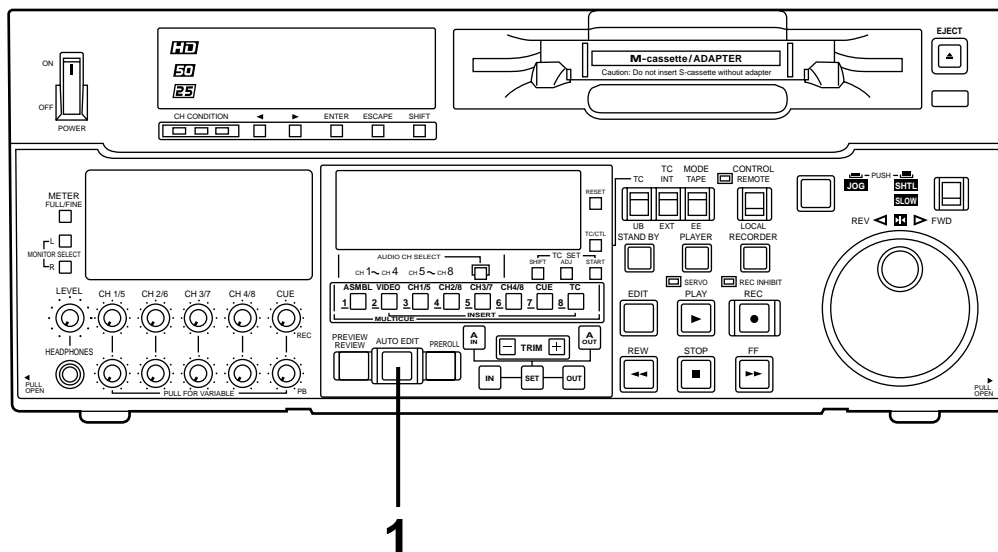

Automatic editing

Review

- 1 Upon completion of the editing, press the REVIEW button.
The review is started in the recorder.
 - To stop the review at any time, press the STOP button.
 - When the edit OUT point is reached, the unit goes into the stop mode after postrolling.

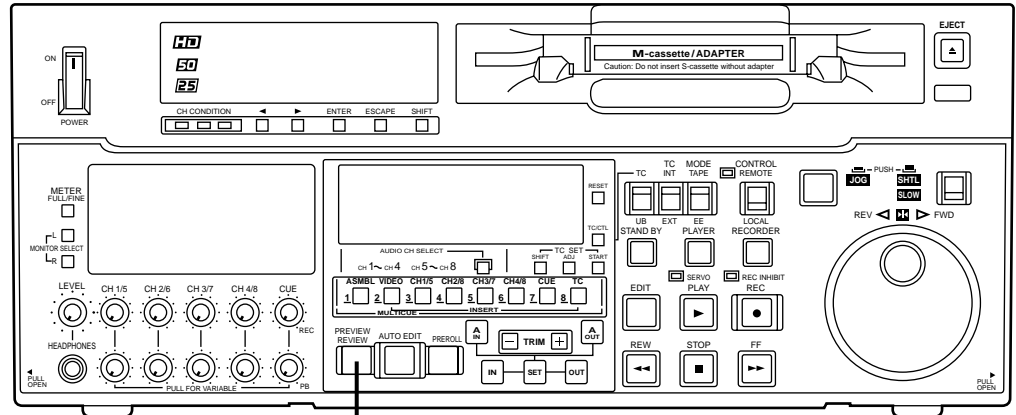

Audio split editing

The video edit points and audio edit points can be entered separately, and they can be offset from each other and edited.

The audio edit points cannot be entered when the assemble editing mode has been selected. After the edit points have been entered, follow the same operating procedure as that for insert editing.

■ Entering the edit points

- Video IN point: Press the SET button while holding down the IN button.
- Video OUT point: Press the SET button while holding down the OUT button.
- Audio IN point: Press the SET button while holding down the A-IN button.
- Audio OUT point: Press the SET button while holding down the A-OUT button.

■ Deleting the edit points

- Video IN point: Press the RESET button while holding down the IN button.
- Video OUT point: Press the RESET button while holding down the OUT button.
- Audio IN point: Press the RESET button while holding down the A-IN button.
- Audio OUT point: Press the RESET button while holding down the A-OUT button.

■ Modifying the edit points

- Video IN point: Press the TRIM+ or TRIM- button while holding down the IN button.
- Video OUT point: Press the TRIM+ or TRIM- button while holding down the OUT button.
- Audio IN point: Press the TRIM+ or TRIM- button while holding down the A-IN button.
- Audio OUT point: Press the TRIM+ or TRIM- button while holding down the A-OUT button.

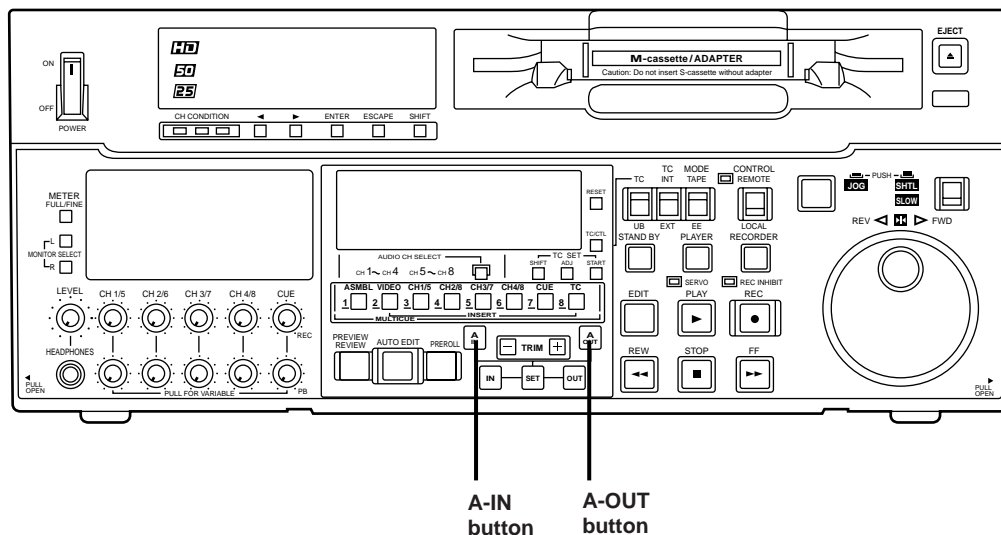

■ Displaying the audio split edit points

The edit points are displayed on the front panel as shown below. (The figure shows an audio IN point.)

Operations

Video IN point: Press the IN button.
Video OUT point: Press the OUT button.
Audio IN point: Press the A-IN button.
Audio OUT point: Press the A-OUT button.

<Note>

If the editing mode is switched to assemble editing after audio edit points have entered, these points will be deleted.

■ Cueing up the tape to the edit points

Cue-up to video IN point: Press the PREROLL button while holding down the IN button.
Cue-up to video OUT point: Press the PREROLL button while holding down the OUT button.
Cue-up to audio IN point: Press the PREROLL button while holding down the A-IN button.
Cue-up to audio OUT point: Press the PREROLL button while holding down the A-OUT button.

■ Duration display

The duration can be displayed on the front panel only.

Duration from video IN point to OUT point: Press the IN and OUT buttons simultaneously.

Duration from audio IN point to OUT point: Press the A-IN and A-OUT buttons simultaneously.

Match frame processing mechanism

When two VTRs are used for audio split editing operations, there will be a total of eight edit points: two pairs of video IN and OUT points, one for the player and the other for the recorder, and two pairs of audio IN and OUT points, one for the player and the other for the recorder. Since the remaining three points are automatically calculated when five of these eight edit points are entered, up to five edit points can be entered.

■ When a VTR without a split editing function is to be used as the player

When a VTR which does not have the ability to set the video and audio edit points separately is used as the player, split editing can still be performed by setting the audio IN and OUT points using the recorder and setting the data of three points as the video edit points.

<Note>

If, during audio split editing, only the video OUT point (or audio OUT point) is entered and automatic editing is executed without the audio OUT point (or video OUT point) having been entered, editing will continue until the audio OUT point (or video OUT point) is entered or the STOP button is pressed to suspend operation.

Setup (default settings)

The unit's major settings are performed by making selections on menus.

The setting menus appear on the TV monitor when the TV monitor and VIDEO OUT 3 connector in the unit's connector area are hooked up.

Changing the settings

- 1** Press the MENU button.
The setup menu appears on the TV monitor and setup menu No. appears on the counter display. (If the setup has already been performed, the screen showing the changes made last will appear.)
- 2** Rotate the search dial and select the item to be set.
The cursor (*) on the menu screen moves and the item No. on the display flashes.
 - When the dial is rotated clockwise, the item No. is incremented from 001→002→003→004 and so on; when it is rotated counterclockwise, the item No. is decremented.
 - The search dial should be used in jog mode if at all possible.
 - Hold down the PLAY button and press the FF (next major item) or REW (previous major item) buttons to select the menu by major item.
- 3** While holding down the search button, rotate the search dial at the position where the change is to be made.
The setting No. now flashes.
When the dial is rotated clockwise, the setting value is incremented; when it is rotated counterclockwise, it is decremented.
- 4** Release the search button when the setting is completed.
The setting value on the menu screen and display flashes.
 - During the SHTL mode, the item moves if the search dial is not at the STILL position.
- 5** Repeat steps 2 through 4 to change another item.
- 6** Press the SET button.
The changes are now stored in the memory.
 - To return the items to the settings established before the changes were made, press the MENU button.

To return the setup settings to the factory (default) settings, press the RESET button while the menu is displayed. **The following message will now appear:**

SETUP-MENU INIT SET
YES<PLAY>/NO<STOP>

When the PLAY button is pressed, the factory settings are restored.

<Note>

- When the RESET button is pressed to return to the factory settings, the factory settings are restored only for the user file currently being used and other user files are not affected.
- The changed SYSTEM menu contents are recorded even if the MENU button is pressed.

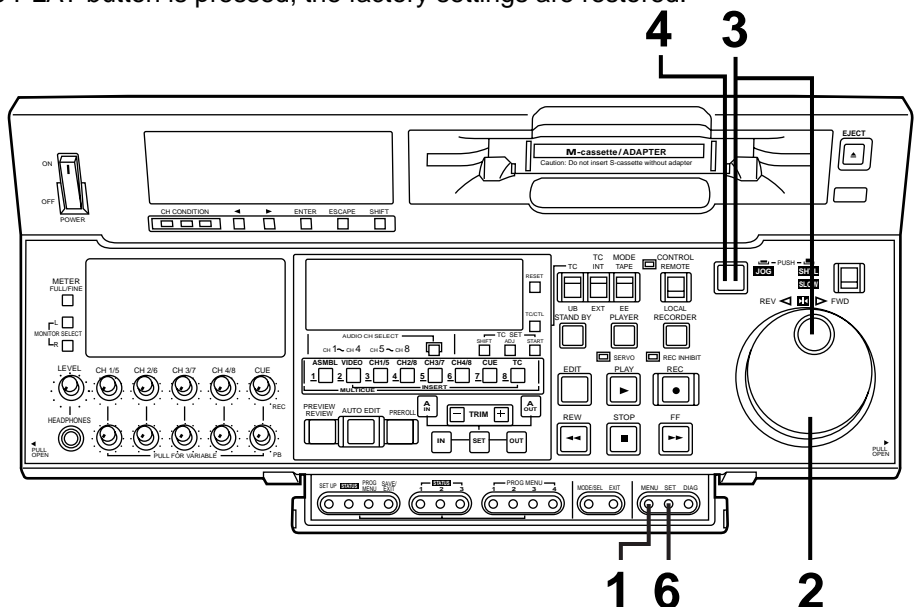

Setup menus

This unit can store up to 5 user files (user 1 to user 5) containing different menu settings, and these files can be selected and used.

Changing the file

- 1** Press the MENU button.
- 2** Hold down the STAND BY button and press the FF button to switch to the next user file. Hold down the STAND BY button and press the REW button to switch to the previous user file.

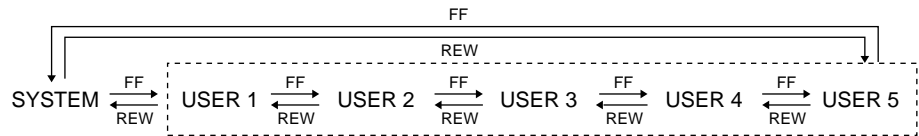

USER FILE

Each user file contains the following items.

- BASIC
- OPERATION
- INTERFACE
- EDIT
- TAPE PROTECT
- TIME CODE
- VIDEO
- AUDIO
- V BLANK
- MENU

- 3** Repeat the operation in step 2 to select the user file to be used and press the SET button. The user file is changed and stored in the memory.

<Note>

SYSTEM menu items are not included in user files 1 to 5.

Therefore, after selecting the user file, switch to the SYSTEM file and set the SYSTEM menu items.

Setup menus

Lock mode can be set to protect the settings in the system files and user files (USER2 – USER5). Settings can no longer be changed when this mode is set.

To set and release the lock mode for the system files and user files use setup item No. 30 (MENU LOCK) and setup menu item No. A03 (MENU LOCK), respectively.

Setting and releasing the lock mode.

- 1** Press the MENU button.
- 2** While holding down the STAND BY button, press the REW or FF button, and select the file for which the lock mode is to be set or released.
- 3** Turn the search dial and move the cursor (*) on the menu screen to setup item No. 30 (MENU LOCK) or setup menu item No. A03 (MENU LOCK) for the system or user file.
- 4** While holding down the search button, turn the search dial and select lock mode setting or release.
To set the lock: Select the 0001 (ON) setting.
To release the lock: Select the 0000 (OFF) setting.

When the lock has been set, “LOCKED” flashes on the menu screen.

SETUP-MENU	LOCKED
<USER2>	No.800 - 0005
*000 P-ROLL TIME	5s
001 LOCAL ENA	ST&EJ
002 TAPE TIMER	±12h
003 REMAIN SEL	OFF
004 SYNCHRONIZE	OFF
005 SUPER	ON
006 DISPLAY SEL	T&STA
007 CHARA H-POS	6
008 CHARA V-POS	23

- 5** Press the SET button. The setting is now stored in the memory.

<Note>

- The lock mode cannot be set for the USER1 file settings.
- Even if the RESET button is pressed, the files which has been set to the lock mode cannot be reset to the factory settings.

Setup menus

The contents of the USER2 – USER5 files can be copied (loaded) into the USER1 file. In addition, the contents of the USER1 file can be copied (saved) to the USER2 – USER5 files.

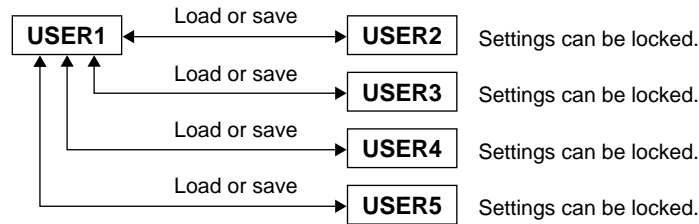

Loading a user file

- 1** Press the MENU button.
- 2** While holding down the STANDBY button, press the REW or FF button, and select USER1.
- 3** Turn the search dial and move the cursor (*) on the menu screen to setup item No. A00 (LOAD).

```
SETUP-MENU  MENU
<USER1>    NO.A00 - 0000
 759 REC PT MUTE      OFF
*A00 LOAD            USER2
A01 SAVE             USER2
A02 P.ON LOAD        OFF
END
```

- 4** While holding down the search button, turn the search dial and select the user file whose contents are to be loaded into USER1.
- 5** Press the SET button. The following messages appear on the menu screen and counter display.

Menu screen

```
SETUP-MENU LOAD

  USER2 → USER1 OK?
  YES<PLAY>/NO<STOP>
```

The user file number selected in step 4 is displayed in the shaded area.

- 6** Press the PLAY button. The settings of the user file selected in step 4 are loaded, and the USER1 menu display appears. When the STOP button is pressed, the USER1 menu display appears while the settings remain unchanged.
- 7** Turn the search dial and move the cursor (*) on the menu screen to any setup item except No. A00 (LOAD) and No. A01 (SAVE).
- 8** Press the SET button. The USER1 settings are now stored in the memory. If the USER1 settings are not going to be stored in the memory, do not press the SET button but press the MENU button.

Setup menus

Saving a user file

- 1** Press the MENU button.
- 2** While holding down the STAND BY button, press the REW or FF button, and select USER1.
- 3** Turn the search dial and move the cursor (*) on the menu screen to setup item No. A01 (SAVE).

```
SETUP-MENU  MENU
<USER1>     NO.A00 - 0000
 759 REC PT MUTE      OFF
A00 LOAD              USER2
*A01 SAVE             USER2
A02 P.ON LOAD        OFF
END
```

- 4** While holding down the search button, turn the search dial and select the user file into which the USER1 contents are to be saved. User files which have been set to the lock mode are not displayed. When all the user files have been set to the lock mode, the "LOCKED" display appears and the contents cannot be saved.
- 5** Press the SET button. The following messages appear on the menu screen and counter display.

Menu screen

```
SETUP-MENU SAVE
USER1 → USER2 OK?
YES<PLAY>/NO<STOP>
```

The user file number selected in step 4 is displayed in the shaded area.

- 6** Press the PLAY button. The contents of the USER1 file are saved in the user file which was selected in step 4 and stored in the memory. When the STOP button is pressed, the USER1 menu display appears while the settings remain unchanged.
- 7** Turn the search dial and move the cursor (*) on the menu screen to any setup item except No. A00 (LOAD) and No. A01 (SAVE).
- 8** Press the SET button. The USER1 settings are now stored in the memory. If the USER1 settings are not going to be stored in the memory, do not press the SET button but press the MENU button.

Automatic loading of user file when the power is turned on

When the user file to be loaded is selected in advance using setup menu item No. A02 (P.ON LOAD), it can be automatically loaded into USER1 when the power is turned on.

Setup menus

SYSTEM menu

<SYSTEM>

Item		Setting		Description
No.	Superimposed display	No.	Superimposed display	
00	WFM SEL	0000 0001 <u>0002</u> 0003 0004 0005 0006 0007	CTL TC <u>VIDEO</u> SYNC RF-L RF-R ENV-L ENV-R	This selects the signal to output from the VIDEO OUT 2 connector. 0: The CTL signal is output. 1: The TIME CODE signal is output. 2: The VIDEO OUT signal is output. 3: The SYNC signal is output. 4: The PB L RF signal is output. 5: The PB R RF signal is output. 6: The PB L ENV signal is output. 7: The PB R ENV signal is output. <Note> 1. The settings can be changed at any time regardless of the setup menu item No. 30 (MENU LOCK) setting. 2. The signals which are output during normal playback have approximately the levels given below. CTL: 0.1 to 0.3 Vp-p TC: 0.6 Vp-p VIDEO: 1.0 Vp-p
10	ENCODER REMOTE SEL	0000 <u>0001</u>	REMOTE <u>LOCAL</u>	This selects whether the video output signal is to be adjusted on the VTR or with the external encoder remote control. 0: Video output signals are adjusted with the external encoder remote control. 1: Video output signals are adjusted on the VTR.
11	SYS SC/H	<u>0000</u> 0001	<u>REMOTE</u> LOCAL	This sets whether the system phase is to be adjusted using the unit's controls or using the external encoder remote control. 0: The external encoder remote control is used to adjust the system phase. 1: The system phase is adjusted using the unit's controls. <Note> This setting has no effect when LOCAL has been selected as the SYSTEM menu item No.10 (ENCODER SEL).
12	SYS H (HD)*1	0000 : <u>1100</u> : 2200	-1100 : <u>0</u> : 1100	This enables the system phase to be adjusted in 13.5ns steps. -: The phase is advanced. +: The phase is delayed. <Note> If setting operation is performed, the setting value does not return to factory (default) setting.
13	V PHASE (HD)*1	0000 : <u>0500</u> : 1000	-500 : <u>0</u> : 500	This enables the video system phase to be adjusted in 27ns steps. -: The phase is advanced. +: The phase is delayed. <Note> In the case of the HD up-converter output from the SD playback tape (when the option has been installed), the video phase is fixed.
14	SYS SC (SD)*2	0000 : <u>0108</u> : 0216	-108 : <u>0</u> : 108	This enables the system phase to be adjusted in a total variable range of +/-180 degrees or more. -: The phase is advanced. +: The phase is delayed. <Note> If setting operation is performed, the setting value does not return to factory (default) setting.

The underline on the setting item denotes the initial setting.

*1: With the HD output (HD tape playback or up-conversion output)

*2: With the SD output (SD tape playback or down-conversion output)

Setup menus

SYSTEM menu

<SYSTEM> (continued)

Item		Setting		Description
No.	Superimposed display	No.	Superimposed display	
15	VO SYS H (SD)*1	0000 : <u>0429</u> : 0858	-429 : 0 : 429	This enables the system phase to be adjusted in 74ns steps. -: The phase is advanced. +: The phase is delayed. <Note> If setting operation is performed, the setting value does not return to factory (default) setting.
16	SDI SYS H (SD)*1	0000 : <u>0429</u> : 0858	-429 : 0 : 429	This enables the SDI OUT system phase to be adjusted in 74ns steps. -: The phase is advanced. +: The phase is delayed. <Note> If setting operation is performed, the setting value does not return to factory (default) setting.
17	V PHASE H (SD)*1	0000 : <u>0190</u> : 0380	-190 : 0 : 190	This enables the video system phase to be adjusted in 148ns steps. -: The phase is advanced. +: The phase is delayed. <Note> In the case of the SD down-converter output from the HD playback tape (when the option has been installed), the video phase is fixed.
18	SCH COAR H (SD)*1	<u>0000</u> 0001 0002 0003	0 90 180 270	This enables the SCH phase to be adjusted in 90-degree steps. -: The phase is advanced. +: The phase is delayed. (The SC phase changes but the H phase remains unchanged.)
19	SCH FINE (SD)*1	0000 : <u>0032</u> : 0064	-32 : 0 : 32	This enables the SCH phase to be adjusted in a total variable range of +/-45 degrees or more. -: The phase is advanced. +: The phase is delayed. (The SC phase changes but the H phase remains unchanged.)
20	AV PHASE	0000 : <u>0100</u> : 0200	-100 : 0 : 100	This enables the phase of the audio output to be adjusted to the video output by 20.8us. -: The audio output phase is moved ahead of the video output. +: The audio output phase is delayed from the video output.
30	MENU LOCK	<u>0000</u> 0001	OFF ON	This selects whether to establish or release the system file lock mode. 0: The system file lock is released (changes can be made). 1: The system files lock is engaged (no changes can be made).

The underline on the setting item denotes the initial setting.

*1: With the SD output (SD tape playback or down-conversion output)

Video output signal adjustments

A control matrix of the adjustments is shown below.

Settings		Item adjusted	
SYSTEM menu 10: ENCODER SEL	SYSTEM menu 11: SYS SC	SYSTEM menu SYS SC SYS H	SETUP menu VIDEO LEVEL CHROMA LEVEL SET UP/HUE
LOCAL	LOCAL	Unit	Unit
	REMOTE		
REMOTE	LOCAL	Unit	External encoder remote controller
	REMOTE	External encoder remote controller	

Setup menus

USER menu

<BASIC>

Item		Setting		Description
No.	Superimposed display	No.	Superimposed display	
000	P-ROLL TIME	0000 : <u>0005</u> : 0015	0S : <u>5S</u> : 15S	This sets the preroll time which can be set from 0 to 15 seconds in 1-second increments. <Note> When the unit is set to automatic editing [PREVIEW, AUTO EDIT], the unit will not operate if the preroll time is set to 0 seconds.
001	LOCAL ENA	0000 <u>0001</u> 0002	DIS <u>ST&EJ</u> ENA	This selects the buttons which can be operated on the front panel when the REMOTE/LOCAL switch has been set to REMOTE. 0: No buttons can be operated. 1: Only the STOP and EJECT buttons can be operated. 2: All buttons except for the RECORDER and PLAYER buttons can be operated.
002	TAPE TIMER	<u>0000</u> 0001	<u>±12h</u> 24h	This selects the 12 or 24 hour display for the CTL counter. 0: 12 hour display 1: 24 hour display
003	REMAIN SEL	<u>0000</u> 0001	<u>OFF</u> ON	This selects whether the REMAIN (remaining tape time) display is to be superimposed onto the HD SDI OUT3, SD SDI OUT3 and VIDEO OUT3 connector signals. 0: Display is not superimposed. 1: Display is superimposed. <Note> 1. Even when "1: ON" is selected, the remaining tape time will not be displayed while this is being calculated after a tape has been ejected or inserted. 2. The remaining tape time is not displayed when TIME has been selected as the setup menu item No.006 (DISPLAY SEL) setting.
004	SYNCHRONIZE	<u>0000</u> 0001	<u>OFF</u> ON	This sets whether the phase is to be synchronized between two decks. 0: The phase is not synchronized. The edit points will be off by several frames but editing can be entered more quickly. 1: The phase is synchronized. Error-free editing can be performed.
005	SUPER	0000 <u>0001</u>	OFF <u>ON</u>	This selects whether the time code and other displays are to be superimposed onto the HD SDI OUT3, SD SDI OUT3 and VIDEO OUT3 connector signals. 0: Displays are not superimposed. 1: Displays are superimposed.

The underline on the setting item denotes the initial setting.

Setup menus

USER menu

<BASIC> (continued)

Item		Setting		Description																		
No.	Superimposed display	No.	Superimposed display																			
006	DISPLAY SEL	0000 <u>0001</u> 0002	TIME T&STA T&S&M	<p>This selects what displays such as the time code are to be superimposed onto the HD SDI OUT3, SD SDI OUT3 and VIDEO OUT3 connector signals.</p> <p>0: Time only 1: Time and operation mode 2: Time, operation mode and mode</p> <p><Note> 1. The following modes are displayed in accordance with the format used.</p> <table style="margin-left: 40px;"> <tr> <td><Format></td> <td>→</td> <td><Display></td> </tr> <tr> <td>DVCPRO(HD)</td> <td>→</td> <td>DVCPRO_HD</td> </tr> <tr> <td>DVCPRO(50 bps)</td> <td>→</td> <td>DVCPRO_50</td> </tr> <tr> <td>DVCPRO(25 bps)</td> <td>→</td> <td>DVCPRO</td> </tr> <tr> <td>DV</td> <td>→</td> <td>DV</td> </tr> <tr> <td>DVCAM</td> <td>→</td> <td>DVCAM</td> </tr> </table> <p>2. With the 2 (T&S&M) setting, an error message is displayed when a warning or error has occurred.</p> <p>3. REC TIME and REC DATE are displayed only during playback of a DV or DVCAM format tape. The operation mode is displayed for the DVCPRO (HD), DVCPRO (50 Mbps) or DVCPRO (25 Mbps) format tapes.</p>	<Format>	→	<Display>	DVCPRO(HD)	→	DVCPRO_HD	DVCPRO(50 bps)	→	DVCPRO_50	DVCPRO(25 bps)	→	DVCPRO	DV	→	DV	DVCAM	→	DVCAM
<Format>	→	<Display>																				
DVCPRO(HD)	→	DVCPRO_HD																				
DVCPRO(50 bps)	→	DVCPRO_50																				
DVCPRO(25 bps)	→	DVCPRO																				
DV	→	DV																				
DVCAM	→	DVCAM																				
007	CHARA H-POS	0000 : <u>0006</u> : 0037	0 : <u>6</u> : 37	<p>This selects the horizontal position of the characters used for the time code and other displays which are superimposed onto the HD SDI OUT3, SD SDI OUT3 and VIDEO OUT3 connector signals.</p> <p><Note> 1. When this menu item is set, the displays are output to the VIDEO OUT3 connector in the DISPLAY SEL status even if SUPER OFF has been selected. However, when MENU is exited, the displays comply with the SUPER OFF or ON setting. CHARA TYPE is output to the VIDEO OUT3 connector in the status set on the MENU.</p>																		
008	CHARA V-POS	0000 : <u>0023</u> : 0032	0 : <u>23</u> : 32	<p>This selects the vertical position of the characters used for the time code and other displays which are superimposed onto the HD SDI OUT3, SD SDI OUT3 and VIDEO OUT3 connector signals.</p> <p><Note> 1. When this menu item is set, the displays are output to the VIDEO OUT3 connector in the DISPLAY SEL status even if SUPER OFF has been selected. However, when MENU is exited, the displays comply with the SUPER OFF or ON setting. CHARA TYPE is output to the VIDEO OUT3 connector in the status set on the MENU.</p>																		
009	CHARA TYPE	<u>0000</u> 0001	<u>WHITE</u> W/OUT	<p>This selects the display type for the SETUP MENU, etc. and the displays superimposed onto the HD SDI OUT3, SD SDI OUT3 and VIDEO OUT3 connector signals.</p> <p>0: White characters on a black background 1: White characters with black edges</p>																		
010	MONI CONTROL	0000 0001	<u>MANU</u> AUTO	<p>This sets whether the recorder is to be forcibly set to the EE status and the player's playback signals are to be output to the monitor by pressing the PLAYER button on the recorder when the monitor has been connected only to the recorder during deck-to-deck editing.</p> <p>0: The EE status is not forcibly established. 1: The EE status is forcibly established, and the player's playback signals are output.</p>																		

The underline on the setting item denotes the initial setting.

Setup menus

USER menu

<BASIC> (continued)

Item		Setting		Description
No.	Superimposed display	No.	Superimposed display	
022	PB FORMAT	<u>0000</u> 0001 0002 0003 0004	<u>1080i</u> 422 411 DV DVCAM	<p>This selects the playback tape format.</p> <p>0: For playing back a 1080i mode tape. 1: For playing back a DVCPRO50 422 mode tape. 2: For playing back a DVCPRO 411 mode tape. 3: For playing back a DV tape. 4: For playing back a DVCAM tape.</p> <p><Note> Before the PB FORMAT menu item setting is to be changed, eject the tape first and then proceed.</p>
030	HD FREQUENCY	<u>0000</u> 0001	<u>59.94</u> 60	<p>This selects the HD frequency.</p> <p>0: The 59.94 Hz frequency is selected. 1: The 60 Hz frequency is selected.</p> <p>The field frequency set here is used only when no signals corresponding to the OUT REF setting are input. If the corresponding signals are input, the field frequency matches the field frequency of the input.</p>
031	OUT REF	<u>0000</u> 0001 0002 0003	<u>AUTO</u> INPUT HD_REF SD_REF	<p>This selects the video output reference.</p> <p>0: When the HD REF input signal is present, this signal serves as the reference. When the HD REF input signal is not present but the SD REF input signal is present, the SD REF signal serves as the reference. When neither the HD REF input signal nor SD REF input signal is present, the HD serial signal serves as the reference. When none of the HD REF input, SD REF input and HD serial signals are present, the internal sync signal serves as the reference.</p> <p>1: When the HD serial input signal is present, this signal serves as the reference. 2: The signal which has been supplied to the HD REF IN connector serves as the reference. 3: The signal which has been supplied to the SD REF IN connector serves as the reference.</p>

The underline on the setting item denotes the initial setting.

Setup menus

USER menu

<OPERATION>

Item		Setting		Description
No.	Superimposed display	No.	Superimposed display	
100	SEARCH ENA	<u>0000</u> 0001	— DIAL KEY	This selects the direct search dial operation. 0: For direct search dial operations. 1: Operation is not transferred to the search mode unless the search button is pressed.
101	SHTL MAX	0000 <u>0001</u> 0002	×8.4 — ×16 ×32	This sets the maximum speed for shuttle operations. 0: 8.4× normal speed 1: 16× normal speed 2: 32× normal speed
102	FF. REW MAX	0000 0001 <u>0002</u> 0003 0004	×16 ×32 — ×50 ×60 ×100	This sets the maximum speed for FF and REW operations. 0: 16 × normal speed 1: 32 × normal speed 2: 50 × normal speed 3. 60 × normal speed 4. 100 × normal speed <Note> The maximum speed is automatically limited to 50X for DVCPRO-HD and 32X for DV or DVCAM.
104	REF ALARM	0000 <u>0001</u>	OFF — ON	This selects whether to warn the operator when the REF.VIDEO signal has not been connected. 0: Warning is not given. 1: Warning is given by the flashing STOP lamp.
105	AUTO EE SEL	<u>0000</u> 0001	— S/F/R STOP	This selects the VTR mode in which the EE status is to be established when the TAPE/EE switch has been set to EE. 0: The EE status is established in the stop, FF or REW mode. 1: The EE status is established in the stop mode only. <Note> The EE output with the DVCPRO (50 Mbps), DVCPRO (25 Mbps), DV or DVCAM format is characterized by a black picture and muted sound.
106	EJECT EE SEL	<u>0000</u> 0001 0002	— OFF BLACK GRAY	This selects the video and audio output statuses in the eject mode. 0: The EE status is always established regardless of the TAPE/EE switch position. 1: The statuses depend on the TAPE/EE switch position: EE: The EE status is established. TAPE: The video signals turn black; the audio signals are muted. 2: The statuses depend on the TAPE/EE switch position: EE: The EE status is established. TAPE: The video signals turn gray; the audio signals are muted. <Note> The EE output with the DVCPRO (50 Mbps), DVCPRO (25 Mbps), DV or DVCAM format is characterized by a black picture and muted sound.

The underline on the setting item denotes the initial setting.

Setup menus

USER menu

<OPERATION> (continued)

Item		Setting		Description
No.	Superimposed display	No.	Superimposed display	
107	EE MODE SEL	<u>0000</u> 0001	<u>NORMAL</u> THRU	This selects the EE mode output signals. 0: Signals are output with a delay equivalent to the length of internal signal processing. 1: Signals are output directly, without internal processing, and so are output with no delay. <Note> When editing mode is selected, SDTI is selected as the video input signal (when the optional board AJ-UDC150P has been installed), or INT SG is selected at either VIDEO or AUDIO, the internal operations are forcibly set to NORMAL.
108	PLAY DELAY	<u>0000</u> : 0015	<u>0</u> : 15	This set the play delay time in frame increments.
109	CAP.LOCK	<u>0000</u> 0001	<u>2F</u> 4F	This selects whether the playback framing is to be locked in 4-field or 2-field increments. 0: 2F mode 1: 4F mode
110	AUTO REW	<u>0000</u> 0001	<u>OFF</u> ON	This selects whether to rewind the tape automatically to the tape start when the tape end is detected. 0: The tape stops at the tape end. 1: The tape is rewound to the tape start.
111	MEMORY STOP	<u>0000</u> 0001	<u>OFF</u> ON	This selects whether the VTR is to stop automatically when the counter value reaches "0" during a fast forwarding or rewinding operation in the CTL mode. 0: The VTR does not stop. 1: The VTR stops automatically. <Notes> 1. The stop mode concerned is either the stop or the still-picture (SHTL STILL) mode depending on the setup menu No. 315 (AFTER CUE-UP) setting. 2. When both the AUTO REW function and MEMORY function have been selected at the same time, the AUTO REW function takes precedence.

The underline on the setting item denotes the initial setting.

Memory stop function

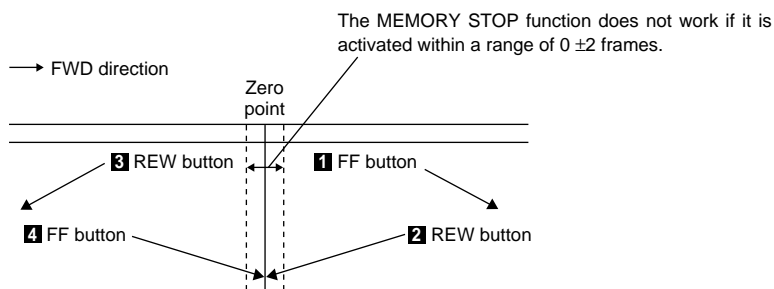

- 1 When the FF button is pressed, the VTR performs the regular fast forward operation since the zero point is not located in the direction of operation.
- 2 When the REW button is pressed, the PREROLL lamp lights (the SHTL lamp lights as well), the VTR proceeds with the preroll operation, and it automatically stops when it reaches the position where the counter reads "0."
- 3 When the REW button is pressed, the VTR performs the regular rewinding operation since the zero point is not located in the direction of operation.
- 4 When the FF button is pressed, the PREROLL lamp lights (the SHTL lamp lights as well), the VTR proceeds with the preroll operation, and it automatically stops when it reaches the position where the counter reads "0."

Setup menus

USER menu

<OPERATION> (continued)

Item		Setting		Description
No.	Superimposed display	No.	Superimposed display	
113	REC INH	<u>0000</u> 0001	— OFF ON	This selects whether to allow or inhibit recording on the cassette tape. 0: Recording on the tape is allowed when its accidental erasure prevention tab has been set to the recording enable position. 1: Recording on the tape is inhibited.
114	REC INH LAMP	<u>0000</u> 0001	— LIGHT FLASH	This selects whether to cause the REC INHIBIT lamp to flash or light up when the cassette's tab has been set to the recording inhibit position. 0: The lamp lights. 1: The lamp flashes <Note> When "1" (ON) has been selected as the setup menu item No.113 (REC INH) setting, the REC INHIBIT lamp lights all the time regardless of this setting.
115	EJECT SW INH	<u>0000</u> 0001	— REC OFF	This selects whether to enable or disable the operation of the eject button on the front panel. 0: The button's operation is inhibited in the recording mode. 1: The button can be operated in any mode.

The underline on the setting item denotes the initial setting.

Setup menus

USER menu

<INTERFACE>

Item		Setting		Description
No.	Superimposed display	No.	Superimposed display	
200	PARA RUN	<u>0000</u> 0001	DIS ENA	This selects whether two or more VTRs are to be operated in synchronization. 0: No operation in synchronization 1: Operation in synchronization <Note> When operating two or more VTRs in synchronization, set all the VTRs to 0001 (ENA).
201	9P SEL	0000 <u>0001</u>	OFF ON	This selects whether the 9P connector functions when the REMOTE/LOCAL switch has been set to REMOTE. 0: Do not function 1: Function
202	ID SEL	<u>0000</u> 0001 0002	OTHER DVCPRO ORIG	This selects the ID information which is returned to the controller. 0: 20 25H 1: The DVCPRO's original ID (F0 33H) is returned. 2: The unit's original ID (A0 50H) is returned. <Note> The 2(ORIG) setting should only be used when a Panasonic controller (AJ-A900 etc, sold separately) is connected.
203	50P SEL	0000 <u>0001</u>	OFF ON	This selects whether the PARALLEL (50P) connector functions when the REMOTE/LOCAL switch has been set to REMOTE. 0: Does not function 1: Functions
204	RS232C SEL	<u>0000</u> 0001	OFF ON	These settings are for selecting whether the RS-232C connector is to function when the REMOTE/LOCAL switch is set to REMOTE. 0: Connector does not function. 1: Connector functions.
205	BAUD RATE	0000 0001 0002 0003 0004 <u>0005</u>	300 600 1200 2400 4800 9600	These settings are for selecting the RS-232C communication speed (baud rate).
206	DATA LENGTH	0000 <u>0001</u>	7 8	These settings are for selecting the RS-232C data length. (Unit: bit)
207	STOP BIT	<u>0000</u> 0001	1 2	These settings are for selecting the RS-232C stop bit length. (Unit: bit)
208	PARITY	<u>0000</u> 0001 0002	NON ODD EVEN	These settings are for selecting the none, odd or even for the RS-232C parity bit. 0: Parity bit is not used. 1: An odd number of bits is used for the parity system. 2: An even number of bits is used for the parity system.
209	RETURN ACK	0000 <u>0001</u>	OFF ON	These settings are for selecting whether the ACK code is to be returned when a command is received from RS-232C. 0: ACK code is not returned. 1: ACK code is returned.
210	50P STBY CMD	<u>0000</u> 0001	OFF/ON ON	For selecting the method used to detect the STANDBY COMMAND signal input at the PARALLEL (50P) connector. 0: Each time active signals are detected, the STANDBY ON or STANDBY OFF mode is selected alternately. 1: When active signals are detected in the STANDBY OFF mode, the unit is transferred to the STANDBY ON mode. Nothing happens if they are detected during an operation in the STANDBY ON mode.

The underline on the setting item denotes the initial setting.

Setup menus

USER menu

<INTERFACE> (continued)

Item		Setting		Description
No.	Superimposed display	No.	Superimposed display	
211	LOCAL 50P	<u>0000</u> 0001	____ OFF ON	This selects whether the PARALLEL (50P) connector is to work when the REMOTE/LOCAL switch has been set to LOCAL. 0: The connector does not work. 1: The connector works.
212	MASTER PORT	<u>0000</u> 0001	____ IN/OUT OUT	This selects the remote control connector for controlling the slave machine when the unit is to be used as the master machine for deck-to-deck operations. 0: The IN/OUT connector is used. 1: The OUT connector is used. <Note> This setting takes effect only when the REMOTE/LOCAL switch has been set to LOCAL.

The underline on the setting item denotes the initial setting.

Setup menus

USER menu

<EDIT>

Item		Setting		Description
No.	Superimposed display	No.	Superimposed display	
300	IN/OUT DEL	<u>0000</u> <u>0001</u>	MANU AUTO	This selects the operation to be performed when an edit point has been set incorrectly (when the OUT point is before the IN point). 0: Editing is not executed unless the illegal edit point is cleared or set again properly. 1: The edit points already input are automatically cleared.
301	NEGA FLASH	<u>0000</u> 0001	OFF ON	This selects whether to show a negative display when the IN point is greater than the OUT point. 0: No negative display. 1: Negative display.
302	CONFI EDIT	<u>0000</u> 0001	OFF ON	This selects whether to conduct simultaneous playback while editing is in progress. 0: No simultaneous playback 1: Simultaneous playback <Note> Simultaneous playback is valid when the TAPE/EE switch is set to TAPE.
305	AUTO ENTRY	<u>0000</u> 0001	DIS ENA	This selects whether the IN point is to be entered using the PREROLL button when it has not been entered. 0: IN point is not entered. 1: IN point is entered.
306	CF ADJ SEL	<u>0000</u> 0001	PLAYER RECORD	This selects the CF adjustment deck with deck-to-deck editing. 0: The player's edit IN/OUT points are adjusted. (reference as the RECORDER side) 1: The recorder's edit IN/OUT points are adjusted. (reference as the PLAYER side)
307	AFTER CUE-UP	<u>0000</u> 0001	STOP STILL	This selects the mode after cue-up operation is complete. 0: STOP mode 1: SHTL STILL mode
308	VAR FWD MAX	<u>0000</u> 0001 0002	+4.1 +1.85 +1	This sets the maximum VAR FWD speed. 0: +4.1× speed 1: +1.85× speed 2: +1× speed <Note> At any speed setting other than 0 (+4.1×), the phase cannot be synchronized from the editing controller.
309	VAR REV MAX	<u>0000</u> 0001 0002	-4.1 -1.85 -1	This sets the maximum VAR REV speed. 0: -4.1× speed 1: -1.85× speed 2: -1× speed
310	JOG FWD MAX	0000 0001 <u>0002</u>	+4.1 +1.85 +1	This sets the maximum JOG FWD speed. 0: +4.1× speed 1: +1.85× speed 2: +1× speed <Notes> • The maximum speed is set to +1× when the dial on the front panel is operated. • At any speed setting other than 0 (+4.1×), the phase cannot be synchronized from an editing controller which synchronizes the phase using the JOG command.

The underline on the setting item denotes the initial setting.

Setup menus

USER menu

<EDIT> (continued)

Item		Setting		Description
No.	Superimposed display	No.	Superimposed display	
311	JOG REV MAX	0000 0001 0002 <u>0003</u>	-4.1 -1.85 -1 <u>-0.43</u>	This sets the maximum JOG REV speed. 0: -4.1× speed 1: -1.85× speed 2: -1× speed 3: -0.43× speed <Notes> • The maximum speed is set to -1× when the dial on the front panel is operated. • At any speed setting other than 1 (-4.1×), the phase cannot be synchronized from an editing controller which synchronizes the phase using the JOG command.
312	POSTROLL TM	0000 0001 <u>0002</u> 0003 0004 0005	0s 1s <u>2s</u> 3s 4s 5s	This sets the postroll time. Any time from 0 to 5 seconds can be set in 1-second units.
320	EDIT RPLCE1	0000 <u>0001</u> 0002 0003	N-DEF <u>CH1</u> CH2 CH1+2	This sets the channel assignments for the controller's analog audio preset when editing the digital audio of the VTR using a controller which does not have a digital audio edit preset control function. This selects the channel concerned when the VTR CH1 edit preset is set in compliance with the ON or OFF presetting for the analog audio signals designated by the controller. 0: Not set. 1: Compliance with analog CH1 edit preset. 2: Compliance with analog CH2 edit preset. 3: Compliance with either analog CH1 or CH2 edit preset.
321	EDIT RPLCE2	0000 0001 <u>0002</u> 0003	N-DEF CH1 <u>CH2</u> CH1+2	The same type of setting as setup menu No. 320. This selects the channel concerned when the CH2 edit preset is set in compliance with the ON or OFF presetting for the analog audio signals designated by the controller. 0: Not set. 1: Compliance with analog CH1 edit preset. 2: Compliance with analog CH2 edit preset. 3: Compliance with either analog CH1 or CH2 edit preset.
322	EDIT RPLCE3	<u>0000</u> 0001 0002 0003	<u>N-DEF</u> CH1 CH2 CH1+CH2	The same type of setting as setup menu No. 320. This selects the channel concerned when the CH3 edit preset is set in compliance with the ON or OFF presetting for the analog audio signals designated by the controller. 0: Not set. 1: Compliance with analog CH1 edit preset. 2: Compliance with analog CH2 edit preset. 3: Compliance with either analog CH1 or CH2 edit preset.
323	EDIT RPLCE4	<u>0000</u> 0001 0002 0003	<u>N-DEF</u> CH1 CH2 CH1+CH2	The same type of setting as setup menu No. 320. This selects the channel concerned when the CH4 edit preset is set in compliance with the ON or OFF presetting for the analog audio signals designated by the controller. 0: Not set. 1: Compliance with analog CH1 edit preset. 2: Compliance with analog CH2 edit preset. 3: Compliance with analog CH1 or CH2 edit preset.

The underline on the setting item denotes the initial setting.

Setup menus

USER menu

<EDIT> (continued)

Item		Setting		Description
No.	Superimposed display	No.	Superimposed display	
324	EDIT RPLGEC	<u>0000</u> 0001 0002 0003	— N-DEF CH1 CH2 CH1+2	The same type of setting as setup menu No. 320. This selects the channel concerned when the CUE edit preset is set in compliance with the ON or OFF presetting for the analog audio signals designated by the editor or controller. 0: Not set. 1: Compliance with analog CH1 edit preset. 2: Compliance with analog CH2 edit preset. 3: Compliance with either analog CH1 or CH2 edit preset.

The underline on the setting item denotes the initial setting.

Setup menus

USER menu

<TAPE PROTECT>

Item		Setting		Description
No.	Superimposed display	No.	Superimposed display	
400	STILL TIMER	0000 0001 0002 0003 0004 0005 0006 0007 <u>0008</u>	0.5s 5s 10s 20s 30s 40s 50s 1min <u>2min</u>	This selects the time to be taken until the unit goes into the tape protection mode when it is left standing in the stop or search still (JOG/VAR/SHTL) mode. (Unit: s = second, min = minute)
401	SRC PROTECT	<u>0000</u> 0001	<u>STEP</u> HALF	This selects the operation during the tape protection mode when the unit is left standing in the still status during the search mode (JOG/VAR/SHTL). 0: STEP FWD. 1: HALF LOADING. <Note> When STEP FWD is selected, the unit automatically goes into the HALF LOADING mode when the total time for which the unit is left standing in the still status reaches 30 minutes.
402	DRUM STDBY	0000 <u>0001</u>	OFF <u>ON</u>	This selects the drum operation in the STANDBY OFF mode. 0: The drum stops rotating. 1: The drum continues rotating.
403	STOP PROTECT	0000 <u>0001</u>	STEP <u>HALF</u>	This selects the operation in the tape protection mode when the unit has been left standing in the STOP mode. 0: STEP FWD 1: HALF LOADING <Note> When STEP FWD is selected, the unit is automatically transferred to the HALF LOADING mode when the total time during which it has been left standing in the STOP mode reaches 30 minutes.

The underline on the setting item denotes the initial setting.

<Note>

The cumulative standby time at the same tape position increases when transmitting programs or otherwise using identical materials repeatedly.

Setup menus

USER menu

<TIME CODE>

Item		Setting		Description
No.	Superimposed display	No.	Superimposed display	
500	VITC BLANK	0000 <u>0001</u>	BLANK ____THRU	For selecting whether to output the VITC signal at the positions selected by setup menu items No. 501 (VITC POS-1) and No. 502 (VITC POS-2). 0: VITC signals are not output. 1: VITC signals are output. For setting the position where the VITC signal is to be inserted.
501	VITC POS-1	0000 : <u>0006</u> : .0010	10L : ____16L : 20L	This sets the position where the VITC signal is to be inserted. <Notes> • The same line as the one used for the setup menu item No. 502 (VITC POS-2) setting cannot be set. • This setting takes effect only with the SD output.
502	VITC POS-2	0000 : <u>0008</u> : 0010	10L : ____18L : 20L	This sets the position where the VITC signal is to be inserted. <Note> • The same line as the one used for the setup menu item No. 501 (VITC POS-1) setting cannot be set. • This setting takes effect only with the SD output.
503	REGEN	<u>0000</u> 0001	____REGEN PRE	This sets the synchronization of the internal time code generator. 0: The time code reader is synchronized with the time code read from the tape. 1: What the time code generator will be synchronized with can be preset using either the operation panel controls or the remote controller.
504	RUN MODE	<u>0000</u> 0001	____REC FREE	This sets the operation mode in which the time code of the internal time code generator is to advance. 0: The time code advances only during recording. 1: It advances while the power is on regardless of the mode which has been established.
505	TCG REGEN	<u>0000</u> 0001 0002	____TC&UB TC UB	This selects the signal to be regenerated when the TCG (time code generator) is in the REGEN mode. 0: Both the time code and user's bit are regenerated. 1: Only the time code is regenerated. 2: Only the user's bit is regenerated.
506	REGEN MODE	<u>0000</u> 0001 0002 0003	____AS&IN ASSEM INSRT SW	This selects whether the time code is to be regenerated during automatic editing using the unit's control panel. 0: The time code is regenerated with assemble or insert editing. 1: The time code is regenerated with assemble editing. 2: The time code is regenerated with insert editing. 3: The setup menu item No.503 (REGEN) setting is followed.
508	BINARY GP	<u>0000</u> 0001 0002 0003 0004 0005 0006 0007	____000 001 010 011 100 101 110 111	This sets the usage status of the user bit of the time code generated by the TCG. 0: NOT SPECIFIED (character set not specified) 1: ISO CHARACTER (8 bits character set based on ISO646, ISO2022) 2: UNASSIGNED 1 (undefined) 3: UNASSIGNED 2 (undefined) 4: UNASSIGNED 3 (undefined) 5: PAGE/LINE 6: UNASSIGNED 4 (undefined) 7: UNASSIGNED 5 (undefined)

The underline on the setting item denotes the initial setting.

Setup menus

USER menu

<TIME CODE> (continued)

Item		Setting		Description
No.	Superimposed display	No.	Superimposed display	
509	PHASE CORR	<u>0000</u> 0001	— OFF ON	This selects whether to control the phase correction of the LTC generated by the TCG. 0: Phase correction control is not performed. 1: Phase correction control is performed.
510	TCG CF FLAG	<u>0000</u> 0001	— OFF ON	This selects whether the CF flag of the TCG is to ON. 0: CF flag is OFF. 1: CF flag is ON.
511	DF MODE	<u>0000</u> 0001	— DF NDF	This selects the DF/NDF mode for CTL and TCG. 0: Drop frame mode. 1: Non-drop frame mode. <Note> • The drop frame mode takes effect only when LOCAL is established or when ENA has been selected as the setup menu item No.111 (LOCAL ENA) setting.
512	TC OUT REF	<u>0000</u> 0001	— V OUT TC IN	This is used to switch the phase of the time code, which is output from the TIME CODE OUT connector, for the external LTC input when the TC INT/EXT switch is at the EXT position. (In EE mode only) 0: Time code is synchronized with output video signal. 1: Time code is synchronized with external time code input.

The underline on the setting item denotes the initial setting.

SBC (sub code data) area:

This area is separate from the video and audio data area on the helical track. The time codes, recording dates and times, and other tape control information complying with SMPTE/EBU standards are stored here. As with the conventional LTC (linear time code), the time code can be read even during rewinding or fast forwarding. It can also be read out when the tape has stopped.

VAUX (video auxiliary data) area:

This area is to be found in the video data area on the helical track. The additional information relating to the video data is stored here.

Setup menus

USER menu

<VIDEO>

Item		Setting		Description
No.	Superimposed display	No.	Superimposed display	
600	VIDEO IN SEL	<u>0000</u> 0001 0002	INT SG — SDI SDTI	This selects the video signals to be input. 0: The internal signals selected by the VIDEO INT SG menu item are generated. 1: The serial video signals supplied to the HD SDI IN connector are selected. 2: The compressed IF signals supplied to the SDTI IN connector are selected.
601	VIDEO INT SG	<u>0000</u> 0001 0002 0003	— OCB MB RAMP BLACK	This selects the type of internal signals. 0: The color bar signal is selected. 1: The multi burst signal is selected. 2: The ramp signal is selected. 3: The black signal is selected.
602	SDI IN MODE	<u>0000</u> 0001	— DR OFF DR ON	This selects the HD SDI input processing method. 0: After the lower 2 bits have been rounded off (rounded up for 5 or above, rounded down for 4 or below), the higher 8 bits are recorded. 1: The 8-bit signals which have been dynamically rounded are recorded.
603	V-MUTE SEL	<u>0000</u> 0001 0002 0003	N-MUTE — GRAY BLACK NOISE	This selects whether to mute the video output signals when LOW RF has been detected during playback. 0: The signals are not muted. (They are frozen.) 1: They are muted with gray. 2: They are muted with black. 3: They are muted with noise.
604	FREEZE SEL	<u>0000</u> 0001	— FIELD FRAME	This selects the freeze status for still pictures. 0: Field freeze 1: Frame freeze
605	INTERPOLATE	<u>0000</u> 0001	OFF — AUTO	Vertical interpolation is automatically conducted during slow playback to reduce the vertical movement of the playback pictures, but this setting enables the interpolation to be forcibly turned off. 0: Interpolation is forcibly turned off. 1: Interpolation is automatically turned on during slow playback.
620	DOWNCON MODE	<u>0000</u> 0001 0002 0003 0004	FIT_V — FIT_H FIT_HV 14:9 13:9	This selects the screen during down-conversion. 0: Side cut mode 1: Letterbox mode 2: Squeeze mode 3: Semi-letterbox 14:9 4: Semi-letterbox 13:9
621	UPCON MODE	<u>0000</u> 0001 0002 0003 0004	FIT_V — FIT_H FIT_HV 14:9 13:9	This selects the screen during up-conversion. 0: Side panel mode 1: Top and bottom in vertical direction cut off 2: Stretch mode 3: Semi-letterbox 14:9 4: Semi-letterbox 13:9
622	DC RESP HV	<u>0000</u> 0001 0002	WIDE — STAND NARROW	This selects the horizontal and vertical frequency band during down-conversion.
623	UC RESP HV	<u>0000</u> 0001 0002	WIDE — STAND NARROW	This selects the horizontal and vertical frequency band during up-conversion.

<Note>

Setup menu items No.620 to No.623 do not work if the AJ-UDC150P optional board has not been installed.

The underline on the setting item denotes the initial setting.

Setup menus

USER menu

<VIDEO> (continued)

Item		Setting		Description
No.	Superimposed display	No.	Superimposed display	
624	DC ENH HV	<u>0000</u> 0001 0002	____ 0dB +3dB +6dB	This selects the horizontal and vertical outline enhancement during down-conversion.
625	UC ENH HV	<u>0000</u> 0001 0002	____ 0dB +3dB +6dB	This selects the horizontal and vertical outline enhancement during up-conversion.
650	Y LEVEL	0000 : <u>4000</u> : 5A70	0000 : ____ 4000 : 5A70	This is for adjusting the Y level (- to 0 dB to +3 dB). dB=20 log (N/4000 hex)
651	PB LEVEL	0000 : <u>4000</u> : 5A70	0000 : ____ 4000 : 5A70	This is for adjusting the PB level (- to 0 dB to +3 dB). dB=20 log (N/4000 hex)
652	PR LEVEL	0000 : <u>4000</u> : 5A70	0000 : ____ 4000 : 5A70	This is for adjusting the PR level (- to 0 dB to +3 dB). dB=20 log (N/4000 hex)
653	BK LEVEL	0 : <u>150</u> : 300	-15.0% : ____ 0% : 15.0%	This is for adjusting the black level.
672	V OUT SETUP (SD)*1	<u>0000</u> 0001	____ THRU ADD	This selects the composite output signal. 0: The signal is output with no setup added. 1: The signal is output with a 7.5% setup added.
673	EDH (SD)*1	0000 <u>0001</u>	OFF ____ ON	This selects whether EDH is to be superimposed onto SERIAL OUT. 0: EDH is not superimposed. 1: EDH is superimposed.
674	ESR MODE (SD)*1	0000 <u>0001</u>	OFF ____ AUTO	This selects the edge subcarrier reduction (ESR) operation mode in the playback circuitry. 0: ESR is forcibly set to OFF. 1: ESR is automatically set to ON or OFF depending on the VTR operation.
675	CCR MODE (SD)*1	<u>0000</u> 0001	____ OFF ON	This selects the processing for cross color during playback. 0: The cross color is output as is. 1: The cross color can be reduced.

<Note>

Setup menu items No.624 and 625 do not work if the AJ-UDC150P optional board has not been installed.

The underline on the setting item denotes the initial setting.

*1: With the SD output (SD tape playback or down-conversion output)

Setup menus

USER menu

<VIDEO> (continued)

Item		Setting		Description
No.	Superimposed display	No.	Superimposed display	
680	V BLANK LINE	<u>0000</u> 0001 0002	<u>BLANK</u> THRU MANU	For selecting blanking ON or OFF for the vertical blanking period of the video signals. 0: Blanking is effected forcibly for all lines. 1: No blanking is effected for any of the lines. 2: Blanking ON or OFF is selected for each line. <Note> When setting "2 (MANU)" is selected and the STOP button is pressed, operation transfers to the sub-screen, and ON or OFF can be selected for each line. To return from the sub-screen, press the STOP button again.
Sub-screen of the setup menu No. 680 (BLANK LINE)				
00	LINE 10&273	<u>0000</u> 0001	<u>BLANK</u> THRU	0: Blanking is forcibly effected. 1: No blanking is effected.
01	LINE 11&274	<u>0000</u> 0001	<u>BLANK</u> THRU	0: Blanking is forcibly effected. 1: No blanking is effected.
02	LINE 12&275	<u>0000</u> 0001	<u>BLANK</u> THRU	0: Blanking is forcibly effected. 1: No blanking is effected.
03	LINE 13&276	<u>0000</u> 0001	<u>BLANK</u> THRU	0: Blanking is forcibly effected. 1: No blanking is effected.
04	LINE 14&277	<u>0000</u> 0001	<u>BLANK</u> THRU	0: Blanking is forcibly effected. 1: No blanking is effected.
05	LINE 15&278	<u>0000</u> 0001	<u>BLANK</u> THRU	0: Blanking is forcibly effected. 1: No blanking is effected.
06	LINE 16&279	<u>0000</u> 0001	<u>BLANK</u> THRU	0: Blanking is forcibly effected. 1: No blanking is effected.
07	LINE 17&280	<u>0000</u> 0001	<u>BLANK</u> THRU	0: Blanking is forcibly effected. 1: No blanking is effected.
08	LINE 18&281	<u>0000</u> 0001	<u>BLANK</u> THRU	0: Blanking is forcibly effected. 1: No blanking is effected.
09	LINE 19&282	<u>0000</u> 0001	<u>BLANK</u> THRU	0: Blanking is forcibly effected. 1: No blanking is effected.
10	LINE 20&283	<u>0000</u> 0001	<u>BLANK</u> THRU	0: Blanking is forcibly effected. 1: No blanking is effected.
11	LINE 21&284	<u>0000</u> 0001	<u>BLANK</u> THRU	0: Blanking is forcibly effected. 1: No blanking is effected.

The underline on the setting item denotes the initial setting.

Setup menus

USER menu

<AUDIO>

Item		Setting		Description
No.	Superimposed display	No.	Superimposed display	
700	AUDIO IN SEL	<u>0000</u> 0001 0002 0003 0004	— AES ANA SDI INT SG USRSET	This selects the audio input signals (for all channels simultaneously). 0: The AES input is selected. 1: The analog input is selected. 2: The serial input is selected. 3: The internally generated signal is selected. 4: The setup menu item No.714 to 721 settings are followed.
701	CH1 IN LV	0000 <u>0001</u> 0002	4dB — 0dB -20dB	This selects the audio input (CH1) reference level switching.
702	CH2 IN LV	0000 <u>0001</u> 0002	4dB — 0dB -20dB	This selects the audio input (CH2) reference level switching.
703	CH3 IN LV	0000 <u>0001</u> 0002	4 dB — 0dB -20 dB	This selects the audio input (CH3) reference level switching.
704	CH4 IN LV	0000 <u>0001</u> 0002	4 dB — 0dB -20 dB	This selects the audio input (CH4) reference level switching.
705	CUE IN LV	0000 <u>0001</u> 0002 0003	4dB — 0dB -20dB -60dB	This selects the CUE input reference level switching.
706	CH1 OUT LV	0000 <u>0001</u> 0002	4dB — 0dB -20dB	This selects the audio output (CH1) reference level switching.
707	CH2 OUT LV	0000 <u>0001</u> 0002	4dB — 0dB -20dB	This selects the audio output (CH2) reference level switching.
708	CH3 OUT LV	0000 <u>0001</u> 0002	4 dB — 0 dB -20 dB	This selects the audio output (CH3) reference level switching.
709	CH4 OUT LV	0000 <u>0001</u> 0002	4 dB — 0 dB -20 dB	This selects the audio output (CH4) reference level switching.
710	CUE OUT LV	0000 <u>0001</u> 0002	4dB — 0dB -20dB	This selects the CUE output reference level switching.
711	MONIL OUT LV	0000 <u>0001</u> 0002	4dB — 0dB -20dB	This selects the audio monitor output (Lch) reference level switching.
712	MONIR OUT LV	0000 <u>0001</u> 0002	4dB — 0dB -20dB	This selects the audio monitor output (Rch) reference level switching.
713	MONI OUT	0000 <u>0001</u>	UNITY — VAR	This selects the audio monitor output volume UNITY/ VARIABLE reference switching. 0: The volume is output at the preset value. 1: The volume is linked with the headphones volume control.

The underline on the setting item denotes the initial setting.

Setup menus

USER menu

<AUDIO> (continued)

Item		Setting		Description
No.	Superimposed display	No.	Superimposed display	
714	CH1 IN SEL	<u>0000</u> 0001	— ANA DIGI	This selects the CH1 input when USR SET has been selected as the setup menu item No.700 (AUDIO IN SEL) setting. 0: Analog input 1: Digital input
715	CH2 IN SEL	<u>0000</u> 0001	— ANA DIGI	This selects the CH2 input when USR SET has been selected as the setup menu item No.700 (AUDIO IN SEL) setting. 0: Analog input. 1: Digital input.
716	CH3 IN SEL	<u>0000</u> 0001	— ANA DIGI	This selects the CH3 input when USR SET has been selected as the setup menu item No.700 (AUDIO IN SEL) setting. 0: Analog input 1: Digital input
717	CH4 IN SEL	<u>0000</u> 0001	— ANA DIGI	This selects the CH4 input when USR SET has been selected as the setup menu item No.700 (AUDIO IN SEL) setting. 0: Analog input 1: Digital input
718	DIGI IN SEL12	<u>0000</u> 0001	— AES SDI	This selects the CH1 and CH2 digital input when USR SET has been selected as the setup menu item No.700 (AUDIO IN SEL) setting. 0: AES input 1: Serial input
719	DIGI IN SEL34	<u>0000</u> 0001	— AES SDI	This selects the CH3 and CH4 digital input when USR SET has been selected as the setup menu item No.700 (AUDIO IN SEL) setting. 0: AES input 1: Serial input
720	DIGI IN SEL56	<u>0000</u> 0001	— AES SDI	This selects the CH5 and CH6 digital input when USR SET has been selected as the setup menu item No.700 (AUDIO IN SEL) setting. 0: AES input 1: Serial input
721	DIGI IN SEL78	<u>0000</u> 0001	— AES SDI	This selects the CH7 and CH8 digital input when USR SET has been selected as the setup menu item No.700 (AUDIO IN SEL) setting. 0: AES input 1: Serial input
722	REC CH1	<u>0000</u> 0001 0002 0003 0004 0005	— CH1 CH2 CH3 CH4 CH1+2 CH3+4	This selects the input signal to be recorded on the audio CH1 track. 0: Audio input CH1 signal. 1: Audio input CH2 signal. 2: Audio input CH3 signal. 3: Audio input CH4 signal. 4: Mixed audio input CH1 and CH2 signal. 5: Mixed audio input CH3 and CH4 signal.
723	REC CH2	0000 <u>0001</u> 0003 0004 0005	CH1 — CH2 CH4 CH1+2 CH3+4	This selects the input signal to be recorded on the audio CH2 track. 0: Audio input CH1 signal. 1: Audio input CH2 signal. 2: Audio input CH3 signal. 3: Audio input CH4 signal. 4: Mixed audio input CH1 and CH2 signal. 5: Mixed audio input CH3 and CH4 signal.

The underline on the setting item denotes the initial setting.

Setup menus

USER menu

<AUDIO> (continued)

Item		Setting		Description
No.	Superimposed display	No.	Superimposed display	
724	REC CH3	0000 0001 <u>0002</u> 0003 0004 0005	CH1 CH2 <u>CH3</u> CH4 CH1+2 CH3+4	This selects the input signal to be recorded on the audio CH3 track. 0: Audio input CH1 signal. 1: Audio input CH2 signal. 2: Audio input CH3 signal. 3: Audio input CH4 signal. 4: Mixed audio input CH1 and CH2 signal. 5: Mixed audio input CH3 and CH4 signal.
725	REC CH4	0000 0001 0002 <u>0003</u> 0004 0005	CH1 CH2 <u>CH3</u> <u>CH4</u> CH1+2 CH3+4	This selects the input signal to be recorded on the audio CH4 track. 0: Audio input CH1 signal. 1: Audio input CH2 signal. 2: Audio input CH3 signal. 3: Audio input CH4 signal. 4: Mixed audio input CH1 and CH2 signal. 5: Mixed audio input CH3 and CH4 signal.
726	REC CH5	<u>0000</u> 0001 0002 0003 0004 0005	<u>CH5</u> CH6 CH7 CH8 CH5+6 CH7+8	This selects the input signal to be recorded on the audio CH5 track. 0: Audio input CH5 signal. 1: Audio input CH6 signal. 2: Audio input CH7 signal. 3: Audio input CH8 signal. 4: Mixed audio input CH5 and CH6 signal. 5: Mixed audio input CH7 and CH8 signal.
727	REC CH6	0000 <u>0001</u> 0002 0003 0004 0005	CH5 <u>CH6</u> CH7 CH8 CH5+6 CH7+8	This selects the input signal to be recorded on the audio CH6 track. 0: Audio input CH5 signal. 1: Audio input CH6 signal. 2: Audio input CH7 signal. 3: Audio input CH8 signal. 4: Mixed audio input CH5 and CH6 signal. 5: Mixed audio input CH7 and CH8 signal.
728	REC CH7	0000 0001 <u>0002</u> 0003 0004 0005	CH5 CH6 <u>CH7</u> CH8 CH5+6 CH7+8	This selects the input signal to be recorded on the audio CH7 track. 0: Audio input CH5 signal. 1: Audio input CH6 signal. 2: Audio input CH7 signal. 3: Audio input CH8 signal. 4: Mixed audio input CH5 and CH6 signal. 5: Mixed audio input CH7 and CH8 signal.
729	REC CH8	0000 0001 0002 <u>0003</u> 0004 0005	CH5 CH6 CH7 <u>CH8</u> CH5+6 CH7+8	This selects the input signal to be recorded on the audio CH8 track. 0: Audio input CH5 signal. 1: Audio input CH6 signal. 2: Audio input CH7 signal. 3: Audio input CH8 signal. 4: Mixed audio input CH5 and CH6 signal. 5: Mixed audio input CH7 and CH8 signal.

The underline on the setting item denotes the initial setting.

Setup menus

USER menu

<AUDIO> (continued)

Item		Setting		Description
No.	Superimposed display	No.	Superimposed display	
730	REC CUE	<u>0000</u> 0001 0002 0003 0004 0005 0006 0007 0008 0009 0010 0011 0012 0013	— CUE CH1 CH2 CH3 CH4 CH5 CH6 CH7 CH8 CH1+2 CH3+4 CH5+6 CH7+8 CH1-CH8	This selects the input signals to be recorded on CUE. 0: CUE IN 1: Audio input CH1 2: Audio input CH2 3: Audio input CH3 4: Audio input CH4 5: Audio input CH5 6: Audio input CH6 7: Audio input CH7 8: Audio input CH8 9: Audio input CH1 and CH2 mixed signals 10: Audio input CH3 and CH4 mixed signals 11: Audio input CH5 and CH6 mixed signals 12: Audio input CH7 and CH8 mixed signals 13: Audio input CH1 to CH8 mixed signals
732	EMBEDDED AUD	0000 <u>0001</u>	OFF — ON	This selects whether the audio data is to be superimposed onto the HD serial output. 0: The audio data is not superimposed. 1: The audio data is superimposed.
733	SD EMBD AUD	0000 <u>0001</u>	OFF — ON	This selects whether the audio data is to be superimposed onto the SD serial output. 0: The audio data is not superimposed. 1: The audio data is superimposed.
734	MONITOR MIX L	<u>0000</u> 0001 0002 0003 0004 0005 0006 0007 0008	— OFF CH1+2 CH3+4 CH1+3 CH2+4 CH5+6 CH7+8 CH5+7 CH6+8	This enables mixed signals to be selected for the headphone monitor left channel. 0: No mixing 1: The CH1 and CH2 signals are mixed. 2: The CH3 and CH4 signals are mixed. 3: The CH1 and CH3 signals are mixed. 4: The CH2 and CH4 signals are mixed. 5: The CH5 and CH6 signals are mixed. 6: The CH7 and CH8 signals are mixed. 7: The CH5 and CH7 signals are mixed. 8: The CH6 and CH8 signals are mixed.
735	MONITOR MIX R	<u>0000</u> 0001 0002 0003 0004 0005 0006 0007 0008	— OFF CH1+2 CH3+4 CH1+3 CH2+4 CH5+6 CH7+8 CH5+7 CH6+8	This enables mixed signals to be selected for the headphone monitor right channel. 0: No mixing 1: The CH1 and CH2 signals are mixed. 2: The CH3 and CH4 signals are mixed. 3: The CH1 and CH3 signals are mixed. 4: The CH2 and CH4 signals are mixed. 5: The CH5 and CH6 signals are mixed. 6: The CH7 and CH8 signals are mixed. 7: The CH5 and CH7 signals are mixed. 8: The CH6 and CH8 signals are mixed.

The underline on the setting item denotes the initial setting.

Setup menus

USER menu

<AUDIO> (continued)

Item		Setting		Description
No.	Superimposed display	No.	Superimposed display	
736	CUE SLOW	<u>0000</u> 0001	— STEP — LINEAR	For selecting the tape travel status (cue track playback status) during slow-motion playback. 0: The output picture takes precedence, and the tape travels at the STEP speed. 1: The cue track playback takes precedence and the tape travels at the linear playback speed. <Notes> When "1" (LINEAR) has been selected: • Set the TC/CTL switch to the TC position because the CTL counter may not function properly. • The picture may not appear as clearly as in the STEP mode.
737	CH1 CUE SEL	<u>0000</u> 0001	— OFF — ON	This selects whether the CUE signal is to be output to the main line of CH1 in the search mode. 0: The CUE signal is not output. 1: The CUE signal is output.
738	CH2 CUE SEL	<u>0000</u> 0001	— OFF — ON	This selects whether the CUE signal is to be output to the main line of CH2 in the search mode. 0: The CUE signal is not output. 1: The CUE signal is output.
739	CH3 CUE SEL	<u>0000</u> 0001	— OFF — ON	This selects whether the CUE signal is to be output to the main line of CH3 in the search mode. 0: The CUE signal is not output. 1: The CUE signal is output.
740	CH4 CUE SEL	<u>0000</u> 0001	— OFF — ON	This selects whether the CUE signal is to be output to the main line of CH4 in the search mode. 0: The CUE signal is not output. 1: The CUE signal is output.
741	CH5 CUE SEL	<u>0000</u> 0001	— OFF — ON	This selects whether the CUE signal is to be output to the main line of CH5 in the search mode. 0: The CUE signal is not output. 1: The CUE signal is output.
742	CH6 CUE SEL	<u>0000</u> 0001	— OFF — ON	This selects whether the CUE signal is to be output to the main line of CH6 in the search mode. 0: The CUE signal is not output. 1: The CUE signal is output.
743	CH7 CUE SEL	<u>0000</u> 0001	— OFF — ON	This selects whether the CUE signal is to be output to the main line of CH7 in the search mode. 0: The CUE signal is not output. 1: The CUE signal is output.
744	CH8 CUE SEL	<u>0000</u> 0001	— OFF — ON	This selects whether the CUE signal is to be output to the main line of CH8 in the search mode. 0: The CUE signal is not output. 1: The CUE signal is output.

The underline on the setting item denotes the initial setting.

Setup menus

USER menu

<AUDIO> (continued)

Item		Setting		Description
No.	Superimposed display	No.	Superimposed display	
745	MONI CH SEL	<u>0000</u> 0001 0002 0003 0004	<u>MANU</u> AUTO1 AUTO2 AUTO11 AUTO21	This selects the monitor output. 0: The output is as selected in MONITOR SELECT. 1: The cue signal is automatically output in all tape modes except that PCM AUDIO is output over the -1 to +1 range. 2: The cue signal is automatically output in all tape modes except in the play mode in which PCM AUDIO is output. 3: The cue input signal is automatically output when the unit is in the EE mode in addition to AUTO1. 4: The cue input signal is automatically output when the unit is in the EE mode in addition to AUTO2.
746	MONI AUTO SEL	<u>0000</u> 0001 0002	<u>L/R</u> L R	If a setting other than MANU has been selected for setup menu item No.745 (MONI CH SEL), the CUE signal is automatically sent to the monitor output in accordance with the operation mode but this item selects the monitor channel which will be automatically switched to CUE. 0: The CUE signal is output to both the left and right channels. 1: The CUE signal is output to the left channel only. 2: The CUE signal is output to the right channel only.
747	MONI SEL INH	<u>0000</u> 0001 0002	<u>OFF</u> ON ON1	This selects whether to enable or disable the MONITOR SELECT button on the front panel. 0: The button's operation is enabled. 1: The button's operation is disabled. 2: In the FULL display mode, the button's operation is disabled; operation is enabled in the FINE display mode only.
748	AUDIO PB VR	<u>0000</u> 0001	<u>DIS</u> ENA	This selects whether the playback level controls are to work in the EE mode when INT SG has been selected as the setup menu item No.700 (AUDIO IN SEL) setting. 0: The INT SG output level is fixed at UNITY. 1: The INT SG output level can be varied using the playback level controls.
749	ANA CH1 SEL	<u>0000</u> 0001	<u>CH1</u> CH5	This selects the signals to be output to analog output CH1. 0: The CH1 signals are output. 1: The CH5 signals are output.
750	ANA CH2 SEL	<u>0000</u> 0001	<u>CH2</u> CH6	This selects the signals to be output to analog output CH2. 0: The CH2 signals are output. 1: The CH6 signals are output.
751	ANA CH3 SEL	<u>0000</u> 0001	<u>CH3</u> CH7	This selects the signals to be output to analog output CH3. 0: The CH3 signals are output. 1: The CH7 signals are output.
752	ANA CH4 SEL	<u>0000</u> 0001	<u>CH4</u> CH8	This selects the signals to be output to analog output CH4. 0: The CH4 signals are output. 1: The CH8 signals are output.
753	SD SDI CH1 SEL	<u>0000</u> 0001	<u>CH1</u> CH5	This selects the signals to be output to SDI output CH1. 0: The CH1 signals are output. 1: The CH5 signals are output.
754	SD SDI CH2 SEL	<u>0000</u> 0001	<u>CH2</u> CH6	This selects the signals to be output to SDI output CH2. 0: The CH2 signals are output. 1: The CH6 signals are output.
755	SD SDI CH3 SEL	<u>0000</u> 0001	<u>CH3</u> CH7	This selects the signals to be output to SDI output CH3. 0: The CH3 signals are output. 1: The CH7 signals are output.
756	SD SDI CH4 SEL	<u>0000</u> 0001	<u>CH4</u> CH8	This selects the signals to be output to SDI output CH4. 0: The CH4 signals are output. 1: The CH8 signals are output.

The underline on the setting item denotes the initial setting.

Setup menus

USER menu

<AUDIO> (continued)

Item		Setting		Description
No.	Superimposed display	No.	Superimposed display	
757	JOG PROG	0000 <u>0001</u>	OFF ____ ON	This selects the slow signal processing for the digital audio output in the JOG, VAR or SHTL mode. 0: Sound which has not been subjected to the digital audio slow signal processing is output even in the STILL mode. 1: Sound which has been subjected to the digital audio slow signal processing is output.
758	DV PB ATT	<u>0000</u> 0001	____ OFF ON	This selects the audio output level during DV format playback. 0: The audio output level is not attenuated. 1: The audio output level is attenuated.
759	REC PT MUTE	<u>0000</u> 0001	____ OFF ON	This selects whether to mute the audio signals at the joins between recordings during DV or DVCAM format playback. 0: The audio signals are not muted. 1: The audio signals are muted.

The underline on the setting item denotes the initial setting.

Setup menus

USER menu

<MENU>

Item		Setting		Description
No.	Superimposed display	No.	Superimposed display	
A00	LOAD	<u>0000</u> 0001 0002 0003	<u>USER2</u> USER3 USER4 USER5	This selects the user file whose contents will be loaded into USER1. 0: The USER2 file contents are loaded. 1: The USER3 file contents are loaded. 2: The USER4 file contents are loaded. 3: The USER5 file contents are loaded. <Note> When the SET button is pressed after loading, the setting will be stored in the memory. When the MENU button is pressed, the setting will not be changed.
A01	SAVE	<u>0000</u> 0001 0002 0003 0004	<u>USER2</u> USER3 USER4 USER5 LOCKED	This selects the user file into which the USER1 settings will be saved. 0: The settings are saved in USER2. 1: The settings are saved in USER3. 2: The settings are saved in USER4. 3: The settings are saved in USER5. 4: This display appears when all the user files are in the change prohibit status. <Notes> • User files whose status have been set to change prohibit cannot be selected. • When all the user files are in the change prohibit status, the "LOCKED" display appears and the contents cannot be saved.
A02	P.ON LOAD	<u>0000</u> 0001 0002 0003 0004	<u>OFF</u> USER2 USER3 USER4 USER5	This loads the contents of the selected user file into USER1 and it starts operation with the USER1 settings when the power is turned on. 0: Operation is started with the settings of the previously set user file. 1: The contents of USER2 are loaded into USER1 and operation is started with the USER1 settings. 2: The contents of USER3 are loaded into USER1 and operation is started with the USER1 settings. 3: The contents of USER4 are loaded into USER1 and operation is started with the USER1 settings. 4: The contents of USER5 are loaded into USER1 and operation is started with the USER1 settings.
A03	MENU LOCK	<u>0000</u> 0001	<u>OFF</u> ON	This selects whether to set or release the user file (USER2 – USER5) lock mode. 0: The lock is released (changes can be made). 1: The lock is set (changes are prohibited). <Note> The lock cannot be set for USER1.

The underline on the setting item denotes the initial setting.

<Notes>

- No. A00 (LOAD), No. A01 (SAVE) and No. A02 (P.ON LOAD) are the menu items which can be set only for USER1. They are not displayed with the USER2 – USER5 files.
- No. A03 (MENU LOCK) is the menu item which can be set only for the USER2 – USER5 files. It is not displayed with USER1.

Time code/user bit

Time code

The time code is used when the time code signal generated by the time code generator (time code signal generator) is to be recorded on the tape, its values are to be read by the time code reader (time code signal reader), and the absolute position of the tape is to be displayed in increments of hours, minutes, seconds and frames.

The time code is written in the sub-code area (data area) of the helical track. This enables insert editing to be conducted independently using the time code alone. In addition, the VTR's playback speed can be read from the stop mode to slow-motion playback up to high-speed play (approx. 50× normal speed/approx. 100× when using DVCPRO tape).

The time code values are indicated using the display and superimpose functions.

TCR 00 : 07 : 04 : 24
↑ ↑ ↑ ↑
Hours | Minutes Seconds Frames

User bit

“User bit” refers to the 32-bit (8-digit) data frame among the time code signals which has been released to users. It enables operator numbers values to be recorded.

The alphanumeric characters which can be used for the user bit are the figures 0 to 9 and the letters A to F.

Recording internal/external time codes

1. Setting the internal time code

- 1** Place the VTR in the stop mode.
- 2** Set the TC/CTL switch to TC.
- 3** Set the TC INT/EXT switch to INT. (Internal time code selected)
- 4** Set the Setup menu No. 504 (RUN MODE).
REC RUN: The time code runs at the same time as the recording proceeds.
FREE RUN: The time code runs in the same way as the time regardless of the VTR's operation.
- 5** Set the Setup menu No. 503 (REGEN).
REGEN: Continuity is maintained with the recorded time code before editing. (Detailed settings are also possible using the menu settings. See the menu items below.)
Setup menu No. 505 (TCG REGEN)
Setup menu No. 506 (REGEN MODE)
PRESET: Recording starts from the value set with the TC SET button.
<Note>
During auto editing, REGEN will be selected by the setup menu No. 506 setting even if the switch has been set to the PRESET position.
- 6** Set the TC SET button.
Use the TC SET button to set the start number of the time code or user bit.
 - 1** Press the SHIFT button.
The leftmost digit flashes.
 - 2** Press the ADJ button to change the value.
Each time the button is pressed, the number changes. The setting range is given below.
 - **When using the time code and user bit in real time**
00:00:00:00 – 23:59:59:29
 - **User bit**
00 00 00 00 – FF FF FF FF
 - 3** Repeat steps 1 and 2 to change the value.
 - 4** When the setting of the start number is completed, press the START button. In the FREE RUN mode, the time code now starts running.
 - 5** Proceed with the recording or editing.

2. Setting the external time code (TC switch → EXT)

- 1** Place the VTR in the stop mode.
- 2** Set the TC/CTL switch to TC.
- 3** Set the TC INT/EXT switch to EXT. (External time code selected)

Reproducing the time code/user bit

- 1** Place the unit in the stop mode.
- 2** Set the TC/CTL button to TC.
- 3** Set the TC/UB switch to TC or UB.
TC: The time code is displayed.
UB: The user bit is displayed.
 - When it is no longer possible to read the time code, it is interpolated using the CTL signal.
- 4** Press the PLAY button.
Playback now commences, and the time code appears on the display.
When setup menu No. 005 (SUPER) is ON, the time code value is superimposed onto the video signal from the VIDEO OUT3 connector.

<Notes>

- The colon between the seconds and frames changes to a period when the drop frame time code is read.
- When the time code signal is missing, it is automatically compensated for using the CTL signal.

Superimpose screen

The control signals, time code, etc. are displayed using abbreviations.

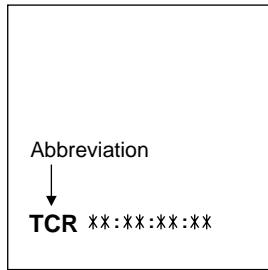

CTL = control signal
TCR = TC time code reading
UBR = TC user bit reading

TV monitor

Characters displayed

The background of characters superimposed on the display can be changed using setup menu No. 009 (CHARA TYPE).

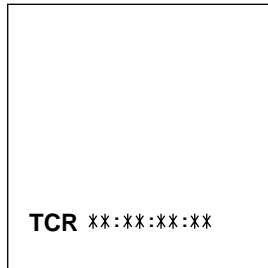

TV monitor

Display position

The position of the characters superimposed on the display can be changed using setup menus No. 007 (CHARA H-POS) and No. 008 (CHARA V-POS).

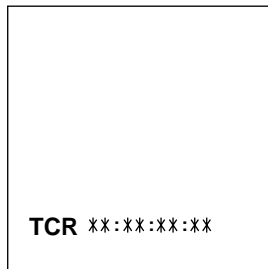

TV monitor

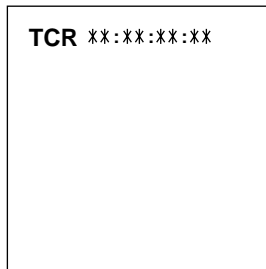

TV monitor

Operation mode

The VTR's operation mode can also be displayed using setup menu No. 006 (DISPLAY SEL).

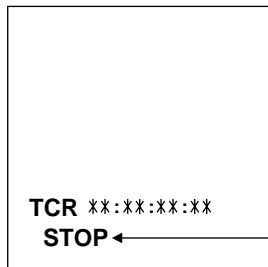

VTR operation mode

TV monitor

Audio recording channel and monitor output selection

Audio recording channel

The audio recording channels are selected on the AUDIO setup menu as shown below.

Recording track	Recording signal
CH1	CH1 input/CH2 input/CH1 input + CH2 input
CH2	CH1 input/CH2 input/CH1 input + CH2 input
CH3	CH3 input/CH4 input/CH3 input + CH4 input
CH4	CH3 input/CH4 input/CH3 input+ CH4 input
CH5	CH5 input/CH6 input/CH5 input+ CH6 input
CH6	CH5 input/CH6 input/CH5 input+ CH6 input
CH7	CH7 input/CH8 input/CH7 input+ CH8 input
CH8	CH7 input/CH8 input/CH7 input+ CH8 input
CUE	CH1 input/CH2 input/CH3 input/CH4 input/CH5 input/ CH6 input/CH7 input/CH8 input/CH1 input +CH2 input/ CH3 input + CH4 input/CH5 input +CH6 input/ CH7 input +CH8 input/CH1 input to CH8 input

Monitor output channel

The monitor output channel is selected with setup menu item No.734 (MONITOR MIX L), No.735 (MONITOR MIX R) and the MONITOR SELECT switch as shown below.

Monitor output	Output signal
L	CH1/CH2/CH3/CH4/CH5/CH6/CH7/CH8/CH1+CH2/CH3+ CH4/CH5+CH6/CH7+CH8/CUE
R	CH1/CH2/CH3/CH4/CH5/CH6/CH7/CH8/CH1+CH2/CH3+ CH4/CH5+CH6/CH7+CH8/CUE

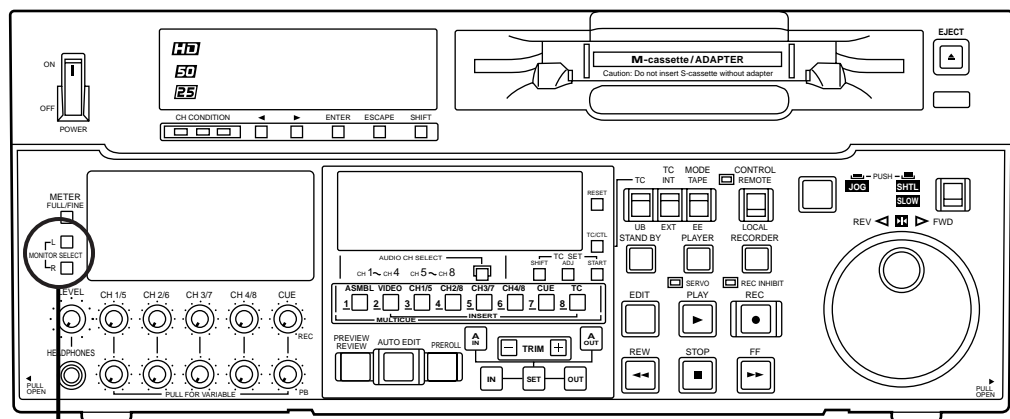

MONITOR SELECT switch

Printed circuit board

Printed circuit board	Abbr. name	Full name	Function	Factory setting
F1 board ADDA	SW1	Audio Input Impedance SW	This sets the CH1 audio input impedance. HIGH/600Ω	HIGH
	SW101	Audio Input Impedance SW	This sets the CH2 audio input impedance. HIGH/600Ω	HIGH
	SW 201	Audio Input Impedance SW	This sets the CH3 audio input impedance. HIGH/600Ω	HIGH
	SW 301	Audio Input Impedance SW	This sets the CH4 audio input impedance. HIGH/600Ω	HIGH
H3 board CUE	SW101	Cue Input Impedance SW	This sets the CUE input impedance.	HIGH

Rack mounting

The unit can be mounted into a 19-inch standard rack if the optional rack-mounting adapters (AJ-MA75P) are used. For the installation rails, it is recommended that the rail and bracket for 18" length (model number CC3061-99-0400) of Chassis Trak be used. If an even greater clearance is to be left between the VTR and rack when the VTR is pulled out, however, it is recommended that the 22" long Chassis Trak (model number CC-3001-99-0191) be used. (The complete slide rail and bracket unit is not available from Panasonic.) For further details, consult with your dealer.

- 1 Attach the inner members of the slide rails. Refer to Table 1 for the places where they are to be secured with the screws.

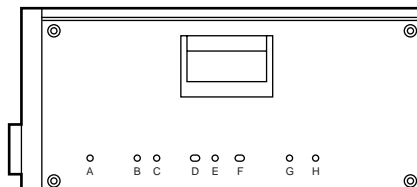

Table 1 Locations where the screws are secured on right (R) side of inner members of slide rails

	18" Chassis Trak	22" Chassis Trak
Part Number	CC3061-99-0400	CC3001-99-0191
Screw holes to be used	B, E, G	C, H

Attach the inner members at the same symmetrical positions on the left (L) side.

Note: The letters "A" to "H" are not actually marked on the side panels.

The length of the screws used is subject to restriction. Use screws which are less than 2/5" long in their place.

6 screws must be used to secure each inner member. When using the 22" long slide rails, secure the screws at 4 locations.

- 2 Attach the outer member brackets to the rack. Check that the height is the same for the left and right brackets.
- 3 Remove the four screws at the front for attaching the left and right side panels.
- 4 Attach the AJ-MA75P rack-mounting adapters with included 4 screws.

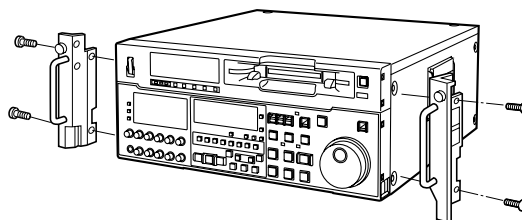

Rack-mounting adapters

- 5 Remove the 4 rubber legs from the bottom of the unit, and install the unit in the rack. After the unit has been installed, check that it moves smoothly along the rails.

EIA standard rack

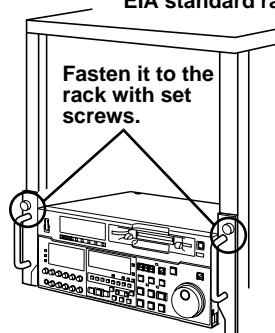

<Notes>

- Keep the temperature inside the rack to between +41°F (5°C) and +104°F (40°C).
- Bolt the rack securely to the floor so that it will not topple over when the VTR is drawn out.

Video head cleaning

This unit is equipped with an auto head cleaning function which automatically reduces the amount of dirt on the video heads. In order to maximize the unit's reliability, it is recommended that the video heads be cleaned as and when appropriate.

For further details on how to actually clean the heads, consult with one of our service companies or with your dealer.

Condensation

Condensation occurs due to the same principle involved when droplets of water form on a window pane of a heated room. It occurs when the unit or tape is moved between places where the temperature or humidity varies greatly or when, for instance:

- It is moved to a very humid place full of steam or a room immediately after it has been heated up.
- It is suddenly moved from a cold location to a hot or humid location.

When moving the unit to locations such as these, leave it standing for about 10 minutes rather than switching on the power immediately.

If condensation has formed on or in the unit, the AUTO OFF lamp lights and the cassette tape is automatically ejected.

Keep the power supplied and simply wait until the AUTO OFF lamp goes off.

■Maintenance

Before proceeding with maintenance, be absolutely sure to set the power switch to OFF and take hold of the power plug and unplug it from the power outlet.

Use a soft cloth to clean the cabinet. To clean off dirt, use a cloth moistened with water. Remove the dirt, and take up any remaining moisture using a dry cloth.

To remove stubborn dirt, dilute some kitchen detergent, dip a cloth into the solution, wring it out well, and wipe. In the same way, after having removed the dirt, take up any remaining moisture using a dry cloth.

<Note>

Do not use alcohol, benzine, paint thinners or other such solvents. They can discolor the external parts surfaces or remove the paint.

Error messages

When a warning occurs in this unit, the warning lamp lights up.

Opening the DIAG menu will display the warning description on the counter display and the monitor. Also, when an abnormal operation is detected in this unit, the AUTO OFF lamp lights up and a message appears on the counter display.

DIAG menu

This display the VTR information.

VTR information includes “WARNING” information and “HOURS METER” (usage time) information. A DIAG menu appears on the monitor when the monitor is connected to the VIDEO OUT3 connector on the connector section.

Displaying the DIAG menu

- 1** Press the DIAG button.
The DIAG menu screen is displayed on the monitor, and the message is displayed on the counter display.
- 2** The “WARNING” information and “HOURS METER” information can be switched by pressing the search buttons.
- 3** Press the DIAG button again to return to the original display.

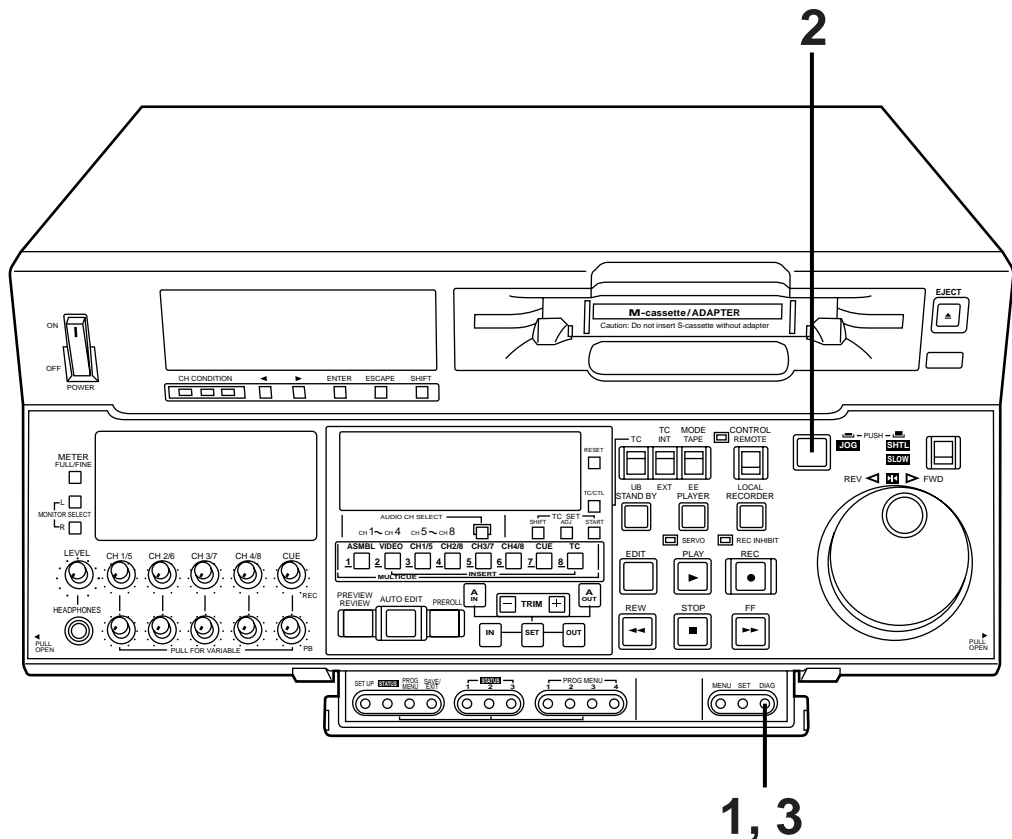

“WARNING” information display

- A warning message is displayed whenever a warning occurs (the warning lamp lights up). When warnings have not been detected, “NO WARNING” is displayed.
- When multiple warning occur, the descriptions for each warning can be checked by turning the search dial.

Error messages

Displaying the “HOURS METER” information

Turn the search dial to move the cursor (*). The description for the item where the cursor is located is shown on the counter display.

Item No.	Item	Description
H00	OPERATION	Displays the time that the power has been supplied in one-hour units.
H01	DRUM RUN	Displays the time that the drum has been rotating in one-hour units.
H02	TAPE RUN	Displays the time that the tape has been running during FF, REW, PLAY, SEARCH (JOG, VAR, SHTL), REC, and EDIT modes (except for STILL in the JOG, VAR or SHTL mode) in one-hour units.
H03	THREADING	The number of times for threading/unthreading is displayed in single units.
H11	DRUM RUN r	Displays the time that the drum has been rotating in one-hour units. (Can be reset)
H12	TAPE RUN r	Displays the time that the tape has been running during FF, REW, PLAY, SEARCH (JOG, VAR, SHTL), REC, and EDIT modes (except for STILL in the JOG, VAR or SHTL mode) in one-hour units. (Can be reset)
H13	THREADING r	The number of times for threading/unthreading is displayed in single units. (Can be reset)
H30	POWER ON	The number of times the power has been turned on is displayed in single units.

<Notes>

- The resettable items in the “HOURS METER” information are reset by the shop when performing maintenance or other work.
- The search buttons and the search dial cannot be operated while the DIAG menu is displayed.

If “T&S&M” is selected in the setup menu No. 006 (DISPLAY SEL), a message appears in the mode display whenever a warning or error occurs. When multiple events occur, the event with the highest priority is displayed.

Priority	Display	Description
High ▲ ↓ Low	Error messages (See error message table)	When an abnormal operation is detected in this unit, the AUTO OFF lamp lights up and an error message is displayed.
	INT SG	This appears at the commencement (of the EE mode) for 2 seconds if the REC button or EDIT button is pressed while the setup menu item No.600 (INT SG) has been selected. Similarly, it appears for 2 seconds at the commencement of editing.
	NO INPUT	This appears at the commencement (of the EE mode) for 2 seconds if the REC button or EDIT button is pressed when the quality of the signals—with the exception of analog audio signals—which are input to the connector selected by the INPUT SELECT switch is poor. Similarly, it appears for 2 seconds at the commencement of editing.
	Warning messages (See error message table)	When a warning occurs in this unit, the warning lamp lights up and a warning message is displayed. When multiple warnings occur, the warning with the highest priority is displayed.

Warning messages

Priority	Monitor display	Description	VTR operation
High ▲ ↓ Low	FAN STOP	This is displayed when the fan motor stops.	Operation continues
	NO RF	This appears when a blank part of the tape lasting for 1 or more seconds has been detected during playback. When all the following conditions have been met, it will be recognized as a blank part. · When no signals are output from any of the heads · When the playback data cannot be read · When CTL is not present	Operation continues
	SERVO NOT LOCKED	This is displayed when the servo is not locked for three or more seconds during playback, recording, or editing.	Operation continues
	LOW RF	This is displayed when envelope levels approximately 1/3 that of normal levels are detected for more than one second during playback, recording, or editing.	Operation continues
	HIGH ERROR RATE	This is displayed when the error rate increases and correction/interpolation is performed on either the video or audio playback signal.	Operation continues

Table of AUTO OFF Error messages

Counter display	Monitor display	Description	VTR operation (Restart condition)
CAP ROTATE TOO SLOW	CAP ROTA TOO SLOW	If the capstan motor speed is abnormally low, the AUTO OFF lamp lights, and the message display flashes.	STOP (POWER OFF→ON)
CAP TENSION ERROR	CAP TENSION ERROR	If an abnormal tension at the supply side is detected in the capstan mode, the AUTO OFF lamp lights, and the message display flashes.	STOP (POWER OFF→ON)
DEW	DEW	If condensation is detected, the AUTO OFF lamp lights, the message display flashes, and the VTR is transferred to the eject mode. After the tape is ejected, the drum rotates in order to eliminate the condensation. When the condensation has been eliminated, the AUTO OFF lamp and message display go off, and the VTR can be used. <Notes> 1) If condensation is detected in the eject mode, the drum starts rotating as soon as it is detected. 2) If condensation is detected when the cassette has been inserted, the drum rotation is stopped, and after the tape is ejected, the drum starts rotating.	EJECT (Normal operation resumed after condensation is eliminated)
DRUM ROTATE TOO FAST	DRUM ROTA TOO FAST	If the cylinder motor speed is abnormally high, the AUTO OFF lamp lights, and the message display flashes.	STOP (POWER OFF→ON)
DRUM ROTATE TOO SLOW	DRUM ROTA TOO SLOW	If the cylinder motor speed is abnormally low, the AUTO OFF lamp lights, and the message display flashes.	STOP (POWER OFF→ON)
E-FF	E-FF	If the tape start and tape end are detected simultaneously either during or after loading, the AUTO OFF lamp lights, and the message display flashes.	STOP (POWER OFF→ON)
FRONT LOAD ERROR	FRONT LOAD ERROR	The AUTO OFF lamp lights and the message display flashes when the take-up reel has been rotating idly for a fixed period of time while the start/end processing operation during loading (half position) is being performed.	STOP (POWER OFF→ON)
FRONT LOAD MOTOR	FRONT LOAD MOTOR	If the cassette does not move up even when 6 seconds have elapsed since the VTR was transferred to the eject mode, the AUTO OFF lamp lights, and the message display flashes. <Note> If the cassette does not move down inside the machine even when 6 seconds have elapsed since the cassette was inserted, the VTR is transferred to the eject mode.	STOP (POWER OFF→ON)
LOADING MOTOR	LOADING MOTOR	When the unloading operation is not completed within 6 seconds, the AUTO OFF lamp lights, and the message display flashes. <Note> When the loading operation is not completed within 6 seconds, the VTR is transferred to the eject (unloading) mode.	STOP (POWER OFF→ON)

Table of AUTO OFF Error messages

Counter display	Monitor display	Description	VTR operation (Restart condition)
REEL DIR UNMATCH	REEL DIR UNMATCH	If the reel motor at the take-up side is running in the reverse direction, the AUTO OFF lamp lights, and the message display flashes.	STOP (POWER OFF→ON)
REEL TENSION ERROR	REEL TENSION ERROR	If an abnormal tension at the supply side is detected in the reel mode, the AUTO OFF lamp lights, and the message display flashes.	STOP (POWER OFF→ON)
SERVO COMM ERROR	SERVO COMM ERROR	When the servo microcomputer does not follow the instructions of the system control microcomputer even when 10 seconds have elapsed, the AUTO OFF lamp lights, and the message display flashes.	STOP (POWER OFF→ON)
SERVO CONTROL ERROR	SERVO CONTROL ERR	When there is no response from the servo microcomputer for 1 or more seconds, the AUTO OFF lamp lights, and the message display flashes.	STOP (POWER OFF→ON)
SERVO ERROR	SERVO ERROR	When only the servo microcomputer was reset in an instantaneous power failure, the AUTO OFF lamp lights, and the message display flashes.	STOP (POWER OFF→ON)
S-FF/REW TIMEOVER	S-FF/REW TIMEOVER	If the start/end processing operation is not completed, the AUTO OFF lamp lights, and the message display flashes.	STOP (POWER OFF→ON)
S REEL ROTA TOO FAST	S REEL TOO FAST	If the supply reel motor should rotate at an abnormally fast rate, the AUTO OFF lamp lights, and the message display flashes.	STOP (POWER OFF→ON)
S REEL TORQUE ERROR	S REEL TORQUE ERR	If an abnormal torque applied to the supply reel motor is detected or if an abnormal current flowing to the current-sensing resistor is detected, the AUTO OFF lamp lights, and the message display flashes.	STOP (POWER OFF→ON)
T REEL ROTA TOO FAST	T REEL TOO FAST	If the take-up reel motor should rotate at an abnormally fast rate, the AUTO OFF lamp lights, and the message display flashes.	STOP (POWER OFF→ON)
T REEL TORQUE ERROR	T REEL TORQUE ERR	If an abnormal torque applied to the take-up reel motor is detected, the AUTO OFF lamp lights, and the message display flashes.	STOP (POWER OFF→ON)
UNLOAD ERROR	UNLOAD ERROR	If the tape has not been wound up during unloading, the AUTO OFF lamp lights, and the message display flashes.	STOP (POWER OFF→ON)
WINDUP ERROR	WINDUP ERROR	If, after the total tape amount has been detected, the amount of tape wound up on the take-up reel and the amount of tape supplied by the supply reel differ to an abnormal extent while the tape is traveling in the forward or reverse direction, the AUTO OFF lamp lights, and the message display flashes.	STOP (POWER OFF→ON)
WINDUP REEL NOT ROTA	W-UP REEL NOT ROTA	If, after the cassette has been inserted, the tape take-up reel has not wound up the tape while the total tape amount is not detected and while the tape is traveling in the forward or reverse direction, the AUTO OFF lamp lights, and the message display flashes.	STOP (POWER OFF→ON)

RS-232C interface

1. Introduction

(1) The VTR can be operated by commands when the RS-232C interface is used.

(See command table on page 93 – 95.)

(2) Conditions for acknowledging commands from RS-232C interface

The front panel REMOTE/LOCAL switch must be at REMOTE.

The setup menu item No. 204 “RS232C SEL” must be ON.

If the above conditions are not met, [ACK] + [STX]ER001[EXT] is returned to the external unit.

Whether the [ACK] code is returned depends on the setting which has been selected for setup menu item No. 209 “RETURN ACK”.

2. Hardware specifications

External interface specifications

1) Connector specifications

Connector: D-SUB 25-pin (crossover cable supported)

Pin No.	Signal	Circuit name	Description
1	FG	Protective ground	Frame ground
2	RXD	Received data	Data is sent to PC.
3	TXD	Transmitted data	Data is received from PC.
4	CTS	Clear to send	Shorted with pin 5.
5	RTS	Request to send	Shorted with pin 4.
6	DTR	Data terminal ready	No processing
7	SG	Signal ground	Signal ground
20	DSR	Data set ready	+ voltage output after communication enable status

2) Example of connection with controller (PC)

■ Using crossover cable with D-SUB 25-pin connectors

PC side
(D-SUB 25-pin connector)

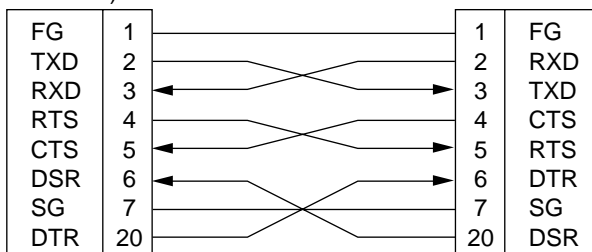

■ Using crossover cable with D-SUB 9-pin and 25-pin connectors

PC side
(D-SUB 9-pin connector)

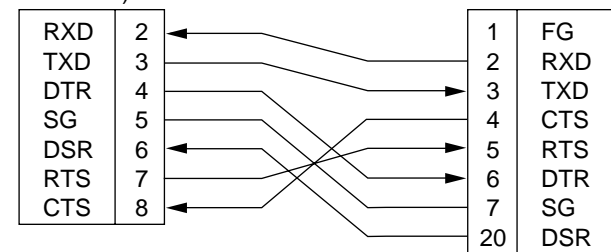

RS-232C interface

3. Software specifications

Protocol

1) Communication parameters

Communication system	Asynchronous, full duplex
Communication speed	300/600/1200/2400/4800/ <u>9600</u>
Bit length	7 bit/ <u>8 bit</u>
Stop bit	<u>1 bit</u> /2 bit
Parity bit	<u>NONE</u> /ODD/EVEN
ACK code	<u>ACK code returned</u> /ACK code not returned <Note> The ACK code is what is returned from the VTR to the controller when data has been successfully sent from the controller.

The underlining indicates the factory settings.

Any changes to the settings can be made using the setup menu items listed below.

Communication parameter	Setup menu item
Communication speed	No. 205 BAUD RATE
Bit length	No. 206 DATA LENGTH
Stop bit	No. 207 STOP BIT
Parity bit	No. 208 PARITY
ACK code	No. 209 RETURN ACK

2) Send format [controller (PC) → VTR]

■ Data format

[STX] [command] [:] [data] [ETX]

02h XX XX XX 3Ah XX-XX 03h ←(ASCII code: symbols, numbers upper-case letters)

20h<XX<7Fh

- [command]: Command identifier; a 3-byte identifier (ASCII code: symbols, numbers, upper-case letters) is sent as the command.
- [:]: This code serves as a delimiter between the command and data.
- [data]: Data (ASCII code: symbols, numbers, upper-case letters) can be added in the number of bytes required.

■ Outline of send procedure from controller

1. The send command starts with STX (start of text = 02h). The command is then identified by COMMAND which follows and the data is added as required.
The format ends with ETX (end of text = 03h).
2. When a different command is to be sent, a response is awaited from the VTR, and then the command is sent. (See page 92.)
3. If STX is sent again before ETX is sent, the receive data buffer inside the VTR is cleared. A command error is returned to the controller, and the data is newly processed with STX which was received again at the head.

RS-232C interface

3) Return format [VTR → controller (PC)]

The following responses are made to the command. If necessary, more than one response is made.

■ When the communication has terminated normally

1. The receive completion message is returned.

[ACK]
06h

2. The execution completion message is returned.

[STX] [command] [data] [ETX]
02h XX XX XX XX-XX 03h

- [command]: This is the message (data) which is returned or the execution completion message identifier.
- [data]: This is the data to be returned. It can be omitted.

Example: Send command Return message (data)
 [STX] OPL [ETX] → [ACK] [STX] OPL [ETX]

■ When the communication has terminated abnormally

[NACK]
15h

■ When processing is not possible due to incorrect data or trouble in the VTR

1. The receive completion message is returned.

[ACK]
06h

2. An error code is returned.

[STX] E R N₁ N₂ N₃ [ETX]
02h Error code 03h

4. Error code table

- ER001: Invalid command
- Unsupported command received.
 - Error in command execution
- ER002: Parameter error
- ER102: VTR mode error (front loading motor)
- ER103: VTR mode error (loading motor)
- ER104: VTR mode error (drum, capstan system)
- ER105: VTR mode error (reel system)
- ER106: VTR mode error (tension system)
- ER108: VTR dew error
- ER1FF: VTR system error

RS-232C interface

5. Command table

(1) Commands relating to operation control

<Notes>

- As for the return (completion) message, [ACK] is first returned when data is received, and the execution message is subsequently returned. It is only the execution message which is listed in this table.
- In the case of commands not listed in the table, ER001 (invalid command) is returned after [ACK] has been returned.

VTR operation	Send command	Return (completion) message	Supplementary notes
STOP	[STX] OSP [ETX]	[STX] OSP [ETX]	This command is for stopping the tape travel. The resulting output picture and sound statuses differ according to the settings selected for the setup menu No. 105 (AUTO EE SEL).
EJECT	[STX] OEJ [ETX]	[STX] OEJ [ETX]	This command is for ejecting the cassette tape. The resulting output picture and sound statuses differ according to the settings selected for the setup menu No. 105 (AUTO EE SEL).
PLAY	[STX] OPL [ETX]	[STX] OPL [ETX]	This command is for starting playback.
REWIND	[STX] ORW [ETX]	[STX] ORW [ETX]	This command is for rewinding the tape. The resulting output picture and sound statuses differ according to the settings selected for the setup menu No. 105 (AUTO EE SEL). The maximum tape speed differs according to the setting selected for setup menu No. 102 (FF. REW MAX).
FAST FORWARD	[STX] OFF [ETX]	[STX] OFF [ETX]	This command is for fast forwarding the tape. The resulting output picture and sound statuses differ according to the settings selected for the setup menu No. 105 (AUTO EE SEL). The maximum tape speed differs according to the setting selected for setup menu No. 102 (FF. REW MAX).
REC	[STX] ORC [ETX]	[STX] ORC [ETX]	This command is for starting the recording.
SHTL FORWARD	[STX] OSF:data [ETX]	[STX] OSF [ETX]	This is the forward direction shuttle command.
	data = n: speed data 0: STILL 1: ×0.03 2: ×0.1 3: ×0.2 4: ×0.5 5: ×1 6: ×1.85 7: ×4.1 8: ×9.5 9: ×16 : This speed differs according to the setting selected for setup menu No. 101 (SHTL MAX). A: ×32 : This speed differs according to the setting selected for setup menu No. 101 (SHTL MAX).		

RS-232C interface

VTR operation	Send command	Return (completion) message	Supplementary notes
SHTL REVERSE	[STX] OSR:data [ETX]	[STX] OSR [ETX]	This is the reverse direction shuttle command.
	data = n: speed data 0: STILL 1: ×0.03 2: ×0.1 3: ×0.2 4: ×0.5 5: ×1 6: ×1.85 7: ×4.1 8: ×9.5 9: ×16 : This speed differs according to the setting selected for setup menu No. 101 (SHTL MAX). A: ×32 : This speed differs according to the setting selected for setup menu No. 101 (SHTL MAX).		
STANDBY OFF	[STX] OBF [ETX]	[STX] OBF [ETX]	This command is setting the VTR to standby OFF.
STANDBY ON	[STX] OBN [ETX]	[STX] OBN [ETX]	This command is setting the VTR to standby ON.

RS-232C interface

(2) Commands relating to inquiries

<Notes>

- As for the return (completion) message, [ACK] is first returned when data is received, and the execution message is subsequently returned. It is only the execution message which is listed in this table.
- In the case of commands not listed in the table, ER001 (invalid command) is returned after [ACK] has been returned.

VTR operation	Send command	Return (completion) message	Supplementary notes
CTL/TC DATA REQUEST	[STX] QCD [ETX]	[STX] CD data [ETX]	This command is for inquiring about the counter value.
		data = f w gh mm ss ff f = F w = S gh = CTL: g = SP (20h): for a plus display - (2Dh): for a minus display h = 0-9: hours TC: gh = 00-23: hours mm = 00-59: minutes ss = 00-59: seconds ff = 00-29: frames (525 mode) = 00-24: frames (625 mode)	CTL or TC is returned, whichever corresponds to the front display mode.
STATUS REQUEST	[STX] QOP [ETX]	[STX] xxx [ETX]	This command is for inquiring about the VTR's operation mode.
		xxx = OEJ: EJECT OFF: FAST FORWARD OPL: PLAY ORC: REC ORW: REWIND OSP: STOP (including the STANDBY ON) SRS: (IN/OUT) PREROLL OBF: STANDBY OFF OSF: SHTL FORWARD OSR: SHTL REVERSE OJG: JOG FORWARD/REVERSE OSW: VAR FORWARD/REVERSE EAE: AUTO EDIT EON: EDIT ON (MANUAL EDIT) EPV: PREVIEW ERV: REVIEW	
ID (VTR No.) REQUEST	[STX] QID [ETX]	[STX] data [ETX]	This command is for inquiring about the VTR used.
		data = AJ-HD150	

RS-232C interface

(3) Microsoft QuickBASIC sample program

```
CLS
STX$ = CHR$(&H2): ETX$ = CHR$ (&H3): NAK$ = CHR$(15): ACK$ = CHR$(&H6)
PRINT "*** RS-232C COMMUNICATION SAMPLE PROGRAM ***"
PRINT "Type Command 'QUIT' to quit."
PRINT

REM *** Communication Port Initial & Open ***
REM Port 1,9600Bps,No parity,8 bit data,1 stop bit
OPEN "COM1:9600,N,8,1" FOR RANDOM AS #1 LEN = 256

REM *** Input Command & Send Command ***
SendCmd:
INPUT "Input Command ="; SEND$
IF SEND$ = "QUIT" THEN GOTO ProgEnd
PRINT #1, STX$ + SEND$ + ETX$

REM *** Wait for Receive Command ***
WHILE LOC(1) = 0
    WAITKEY$ = INKEY$
    IF WAITKEY$ = "Q" THEN PRINT "**** Quit ****": GOTO ProgEnd
WEND

REM *** Receive Command ***
RecvCmd:
RCV$ = INPUT$(1, #1)
IF RCV$ = STX$ THEN RCV$ = "[Stx]"
IF RCV$ = ACK$ THEN RCV$ = "[Ack]"
IF RCV$ = NAK$ THEN RCV$ = "[Nak]"
IF RCV$ = ETX$ THEN BUFFER$ = BUFFER$ + "[Etx]": GOTO DispOut
BUFFER$ = BUFFER$ + RCV$
GOTO RecvCmd

REM *** Output Receive Command ***
DispOut:
PRINT "Receive Command ="; BUFFER$
PRINT
BUFFER$ = ""
GOTO SendCmd

REM *** End Program ***
ProgEnd:
CLOSE
END
```

MICROSOFT QUICKBASIC is a registered trade mark of Microsoft Corporation.

Connector signals

VIDEO IN

HD SERIAL IN (DIGITAL)	BNC × 2	Active through
HD SDTI IN	BNC × 2	Loop-through, 75Ω termination switch provided
VIDEO IN	BNC × 2	Loop-through, 75Ω termination switch provided
HD SDTI IN	BNC × 1	(Board, option)

VIDEO OUT

HD SERIAL OUT (DIGITAL)	BNC × 3
SD SERIAL OUT (DIGITAL)	BNC × 3
VIDEO OUT	BNC × 3
HD REF OUT	BNC × 1
SD REF OUT	BNC × 1

AUDIO IN

SERIAL IN (DIGITAL)	BNC × 2	Active through
AUDIO IN (DIGITAL)	XLR × 4	CH1/CH2, CH3/CH4, CH5/CH6, CH7/CH8 AES/EBU format
AUDIO IN (ANALOG)	XLR × 4	CH1, CH2, CH3, CH4
CUE IN	XLR × 1	
TIME CODE IN	XLR × 1	

Pin No.	Signal
1	GND
2	HOT
3	COLD

AUDIO OUT

HD SERIAL OUT (DIGITAL)	BNC × 3	
AUDIO OUT (DIGITAL)	XLR × 4	CH1/CH2, CH3/CH4, CH5/CH6, CH7/CH8 AES/EBU format
AUDIO OUT (ANALOG)	XLR × 4	CH1, CH2, CH3, CH4
CUE OUT	XLR × 1	
TIME CODE OUT	XLR × 1	
MONITOR OUT	XLR × 2	
HEADPHONES (front)	1/4" Phone jack	

RS-422A REMOTE (9P)

REMOTE IN/OUT

Pin No.	Signal	Pin No.	Signal	Pin No.	Signal
1	FRAME GROUND	4	RECEIVE COMMON	7	TRANSMIT B
2	TRANSMIT A	5	—————	8	RECEIVE A
3	RECEIVE B	6	TRANSMIT COMMON	9	FRAME GROUND

REMOTE OUT

Pin No.	Signal	Pin No.	Signal	Pin No.	Signal
1	FRAME GROUND	4	TRANSMIT COMMON	7	RECEIVE B
2	RECEIVE A	5	—————	8	TRANSMIT A
3	TRANSMIT B	6	RECEIVE COMMON	9	FRAME GROUND

Connector signals

PARALLEL REMOTE (50P)

Pin No.	Signal	Pin No.	Signal	Pin No.	Signal
1	REC COMMAND	23	CUE COMMAND	34	ERR 2 STATUS*
2	PLAY COMMAND	24	ERR 1 STATUS*	41	CUE STATUS
3	FF COMMAND	26	+POWER	42	REMOTE STATUS
4	REW COMMAND	27	REC STATUS	46	STBY STATUS
5	STOP COMMAND	28	PLAY STATUS	47	GND
11	EJECT COMMAND	29	FF STATUS	49	GND
12	IN SET COMMAND	30	REW STATUS	50	GND
20	STBY ON/OFFCOMMAND	31	STOPSTATUS		
21	ERR 0 STATUS*	33	EJECT STATUS		

*50-pin error status table

Pin21/ ERROR 0	Pin24/ ERROR 1	Pin 34/ ERROR 2	AJ-HD150	
			Output priority sequence	VTR status
0	0	0	1	SERVO NOT LOCKED
0	0	1	4	SEVO LOCKED
0	1	0	3	HIGH ERROR (UMBER)
0	1	1	2	HIGH ERROR (RED)
1	0	0	----	
1	0	1	----	
1	1	0	----	
1	1	1	----	

RS-232C REMOTE (25-pin D-SUB crossover cable supported)

Pin No.	Abbreviation	Circuit	Description
1	FRAME GROUND	Protective ground	Frame ground
2	RxD	Received data	Sends data to the PC.
3	TxD	Transmitted data	Receives data from the PC.
4	CTS	Clear to send	Shorted with pin 5.
5	RTS	Request to send	Shorted with pin 4.
6	DTR	Data terminal ready	No processing
7	GND	Signal ground	Signal ground
20	DSR	Data set ready	Positive power output after communication enable status

ENCODER REMOTE (15P)

Pin No.	Signal
1	FRAME GROUND
2	REM (G)
3	REM REX (X) REMOTE CONTROL PROTOCOL RECEIVE
4	REM REX (X) REMOTE CONTROL PROTOCOL TRANSMIT
5	REM REX (Y) REMOTE CONTROL PROTOCOL RECEIVE
6	REM REX (X) REMOTE CONTROL PROTOCOL TRANSMIT

Specifications

GENERAL

Power supply:	AC 120 V, 50 – 60 Hz
Power consumption:	230 W

Operating ambient temperature: 41°F to 104°F (5°C to 40°C)
Operating ambient humidity: 10% to 90% (no condensation)
Weight: 44 lbs (20 kg)
Dimensions (W × H × D): 16-3/4" (max. 17-3/16") × 6-15/16" × 17-11/16"
(Not including the support legs, connectors, JOG dial and fan)
Recording format: DVCPRO HD
Recording video signal: 1080i, 59.94 Hz/60 Hz selectable
Recording audio signal: 48 kHz, 16 bits, 8 channels
Recording tracks: Digital video/audio: helical track
The time code is recorded in the sub-code area.
Cue track: 1 track
Control track: 1 track
Tape speed: 135.28 mm/sec
Recording time: 46 minutes (using the AJ-HP46LP)
32 minutes (using the AJ-HP32LP)
Tape: Metal tape
FF/REW time: Approx. 1 min (with AJ-HP46LP)
Search speed: ±50× speed (color)
Digital slow: Plus direction: 1× speed
Minus direction: -1× speed
Editing accuracy: ±0 frames (using the time code)
Tape timer accuracy: ±1 frame (using the continuous CTL signal)
Servo lock time: Less than 0.3 sec (standby ON)
Loading time: Approx. 3 sec
Audio split editing: YES

VIDEO

Sampling frequencies: Y: 74.25 MHz, P_B/P_R: 37.125 MHz
Quantizing: 8 bits
Video compression method: DCT + variable length code
Video compression rate: 1/6.7
Error correction: Reed-Solomon product code
Video recording bit rate: 100 Mbps
Sample × effective line: 1280 × 1080/frame
Video bandwidth Y: 20 MHz
P_B/P_R: 10 MHz

Video input connector

HD serial digital input: BNC×1, complies with SMPTE 292M standard
HD reference input: BNC×2, loop-through, 75Ω on/off
SD reference input: BNC×2, loop-through, 75Ω on/off
SDTI input (option): BNC×1, complies with SMPTE 305M/321M standard

Video Output Connector

HD serial digital output: BNC×3, complies with SMPTE 292M standard
OUT3 (superimpose on/off)
Serial digital component output: BNC×3, complies with SMPTE 259M-C/294M standard,
OUT3 (superimpose on/off)
HD reference output: BNC×1
SD reference output: BNC×1
Analog composite output: BNC×3, video 1, video 2 (WFM OUT), video 3 (superimpose on/off)
Output during SD playback or when the down-converter is installed
SDTI output (option): BNC×1, complies with SMPTE 305M/321M standard

Video Signal Adjustment

HD SDI Y output gain: -∞ to +3 dB
HD SDI P_B output gain: -∞ to +3 dB
HD SDI P_R output gain: -∞ to +3 dB
HD SDI Y black level: ±10%

Specifications

HD SDI output system phase:	±0.5H (1100 samples, 13.5 ns steps)
SD SDI Y output gain:	−∞ to +3 dB
SD SDI P _B output gain:	−∞ to +3 dB
SD SDI P _R output gain:	−∞ to +3 dB
SD SDI Y black level:	±10%
SD SDI output system phase:	±0.5H (429 samples, 74ns steps)
Composite video output gain:	−∞ to +3 dB
Composite chroma output gain:	−∞ to +3 dB
Composite chroma phase:	±30°
Composite video output setup:	±14 IRE
Composite video output system phase:	±0.5H (429 samples, 74ns steps)
Composite video output SC phase:	±180°
SD SDI and composite output video phase:	±0.44H (380 samples, 74ns steps)
HD SDI output video phase:	±0.45H (1000 samples, 27ns steps)

AUDIO

Digital Audio

Sampling frequencies:	48 kHz (synchronous with video)
Quantizing:	16 bits
Frequency response:	20 Hz to 20 kHz ± 1.0 dB (at the reference level)
Dynamic range:	Better than 90 dB (1 kHz, emphasis OFF)
Distortion:	Less than 0.05% (1 kHz, emphasis OFF, reference level)
Crosstalk:	Less than −80 dB (1 kHz, between 2 channels)
Wow & flutter:	Below measurable limit
Headroom:	20 dB

Cue Track

Frequency response:	300 Hz to 6 kHz ± 3 dB
---------------------	------------------------

Audio Input Connector

Analog input (CH1/CH2/CH3/CH4):	XLR×4, 600Ω/high impedance selectable, +4/0/−20 dBu selectable
Digital input (CH1/CH2, CH3/CH4, CH5/CH6, CH7/CH8):	BNC×4, AES/EBU format
Serial digital input:	BNC×1, complies with SMPTE 292M
Cue track input:	XLR×1, 600Ω/high impedance selectable, +4/0/−20/−60 dBu selectable

Audio Output Connector

Analog output (CH1/CH2/CH3/CH4):	XLR×4, low impedance, +4/0/−20 dBu selectable
Digital output (CH1/CH2, CH3/CH4, CH5/CH6, CH7/CH8):	BNC×4, AES/EBU format
Serial digital output:	BNC×3, complies with SMPTE 292M
Cue track output:	XLR×1, low impedance, +4/0/−20 dBu selectable
Monitor output:	XLR×2, low impedance, +4/0/−20 dBu selectable
Headphones:	1/4" phone jack, variable level, 8Ω

Other Input/Output Connectors

Time code input:	XLR×1, 0.5 to 8 V _{p-p} , 10 kΩ
Time code output:	XLR×1, low impedance, 2.0 V _{p-p} ±0.5V _{p-p}
RS-422A input:	D-sub 9-pin, RS-422A interface
RS-422A output:	D-sub 9-pin, RS-422A interface
RS-232C:	D-sub 25-pin, RS-232C interface
Parallel input/output:	D-sub 50-pin
Encoder remote:	D-sub 15-pin

Weight and dimensions when shown are approximate.
Specifications are subject to change without notice.



Panasonic

PANASONIC BROADCAST & DIGITAL SYSTEMS COMPANY
DIVISION OF MATSUSHITA ELECTRIC CORPORATION OF AMERICA

Executive Office:

3330 Cahuenga Blvd W., Los Angeles, CA 90068 (323) 436-3500

EASTERN ZONE

One Panasonic Way 4E-7, Secaucus, NJ 07094 (201)348-7621

Mid-Atlantic/New England:

One Panasonic Way 4E-7, Secaucus, NJ 07094 (201) 348-7621

Southeast Region:

1225 Northbrook Parkway, Ste 1-160, Suwanee, GA 30024 (770) 338-6835

Central Region:

1707 N Randall Road E1-C-1, Elgin, IL 60123 (847) 468-5200

WESTERN ZONE:

3330 Cahuenga Blvd W., Los Angeles, CA 90068 (323) 436-3500

Dallas Region:

6226 Abington Way, Houston, TX 77008 (713) 802-2726

No. CA/Northwest Region:

5870 Stoneridge, #3, Pleasanton, CA 94588 (925) 416-5108

Government Marketing Department:

52 West Gude Drive, Rockville, MD 20850 (301) 738-3840

PARTS INFORMATION & ORDERING:

9:00 a.m. – 5:00 p.m. (EST) (800) 334-4881/24 Hr. Fax (800) 334-4880

TECHNICAL INFORMATION:

Emergency 24 Hour Parts & Service (800) 222-0741

TRAINING INFORMATION:

Digital System Products - (201) 392-6852

Panasonic Canada Inc.

5770 Ambler Drive, Mississauga, Ontario L4W 2T3 (905) 624-5010

Panasonic de Mexico S.A. de C.V.

Av angel Urraza Num. 1209 Col. de Valle 03100 Mexico, D.F. (52) 1 951 2127

Printed in Japan
VQT8432

F0300H1040-100



Free Manuals Download Website

<http://myh66.com>

<http://usermanuals.us>

<http://www.somanuals.com>

<http://www.4manuals.cc>

<http://www.manual-lib.com>

<http://www.404manual.com>

<http://www.luxmanual.com>

<http://aubethermostatmanual.com>

Golf course search by state

<http://golfingnear.com>

Email search by domain

<http://emailbydomain.com>

Auto manuals search

<http://auto.somanuals.com>

TV manuals search

<http://tv.somanuals.com>