

# Panasonic®

## Digital HD Video Cassette Recorder

# Operating Instructions

---

Model AJ-**HD1700**<sup>PE</sup>

**DVCPRO HD EX**

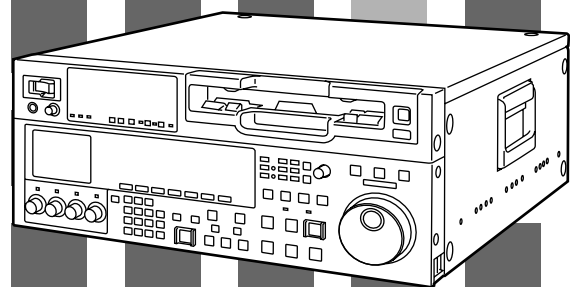

Thank you for purchasing this product.  
Before operating this product, please read the instructions carefully and save this manual for future use.

VQT0E88

**WARNING:**

- TO REDUCE THE RISK OF FIRE OR SHOCK HAZARD, DO NOT EXPOSE THIS EQUIPMENT TO RAIN OR MOISTURE.
- TO REDUCE THE RISK OF FIRE OR SHOCK HAZARD, KEEP THIS EQUIPMENT AWAY FROM ALL LIQUIDS—USE AND STORE ONLY IN LOCATIONS WHICH ARE NOT EXPOSED TO THE RISK OF DRIPPING OR SPLASHING LIQUIDS, AND DO NOT PLACE ANY LIQUID CONTAINERS ON TOP OF THE EQUIPMENT.

**CAUTION:**

Do not install or place this unit in a bookcase, built-in cabinet or any other confined space in order to maintain adequate ventilation. Ensure that curtains and any other materials do not obstruct the ventilation to prevent risk of electric shock or fire hazard due to overheating.

**CAUTION:**

THE AC OUTLET (MAINS SOCKET) SHALL BE INSTALLED NEAR THE EQUIPMENT AND SHALL BE EASILY ACCESSIBLE.

**THIS APPARATUS MUST BE GROUNDED**

To ensure safe operation the three-pin plug must be inserted only into a standard three-pin power outlet (socket) which is effectively grounded through the normal household wiring.

Extension cords used with the equipment must be three-core and be correctly wired to provide connection to the ground. Incorrectly wired extension cords can be extremely hazardous.

The fact that the equipment operates satisfactorily does not imply that it is grounded, and the installation is not necessarily safe. For your safety, if in any doubt about the effective grounding of the equipment or power outlet (socket), please consult a qualified electrician.

**CAUTION:**

TO REDUCE THE RISK OF FIRE OR SHOCK HAZARD AND ANNOYING INTERFERENCE, USE THE RECOMMENDED ACCESSORIES ONLY.

**CAUTION:**

TO REDUCE THE RISK OF FIRE OR SHOCK HAZARD, REFER MOUNTING OF THE OPTIONAL BOARD AND CHANGE OF SWITCH SETTINGS INSIDE THE UNIT TO QUALIFIED SERVICE PERSONNEL.

**CAUTION:**

EVEN WHEN THE POWER SWITCH IS IN THE OFF POSITION, A SMALL CURRENT FLOWS THE FILTER CIRCUIT.



 indicates safety information.

**Operating precaution**

Operation near any appliance which generates strong magnetic fields may give rise to noise in the video and audio signals. If this should be the case, deal with the situation by, for instance, moving the source of the magnetic fields away from the unit before operation.

# For your safety

## For U.S.A. and Canada

	<b>CAUTION</b> RISK OF ELECTRIC SHOCK DO NOT OPEN	
CAUTION: TO REDUCE THE RISK OF ELECTRIC SHOCK, DO NOT REMOVE COVER (OR BACK). NO USER SERVICEABLE PARTS INSIDE. REFER TO SERVICING TO QUALIFIED SERVICE PERSONNEL.		



The lightning flash with arrowhead symbol, within an equilateral triangle, is intended to alert the user to the presence of uninsulated "dangerous voltage" within the product's enclosure that may be of sufficient magnitude to constitute a risk of electric shock to persons.



The exclamation point within an equilateral triangle is intended to alert the user to the presence of important operating and maintenance (service) instructions in the literature accompanying the appliance.

### Notice (U.S.A. only):

This product has a fluorescent lamp that contains a small amount of mercury. It also contains lead in some components. Disposal of these materials may be regulated in your community due to environmental considerations. For disposal or recycling information please contact your local authorities, or the Electronics Industries Alliance: <<http://www.eiae.org>>

### FCC Note:

This device complies with Part 15 of the FCC Rules. To assure continued compliance follow the attached installation instructions and do not make any unauthorized modifications.

This equipment has been tested and found to comply with the limits for a class A digital device, pursuant to Part 15 of the FCC Rules. These limits are designed to provide reasonable protection against harmful interference when the equipment is operated in a commercial environment. This equipment generates, uses, and can radiate radio frequency energy and, if not installed and used in accordance with the instruction manual, may cause harmful interference to radio communications. Operation of this equipment in a residential area is likely to cause harmful interference in which case the user will be required to correct the interference at his own expense.

### CAUTION:

This apparatus can be operated at a voltage in the range of 100 – 240 V AC.

Voltage other than 120 V is not intended for U.S.A. and Canada.

### CAUTION:

Operation at a voltage other than 120 V AC may require the use of a different AC plug. Please contact either a local or foreign Panasonic authorized service center for assistance in selecting an alternate AC plug.

## For Europe

### CAUTION:

**DO NOT REMOVE PANEL COVER BY UNSCREWING**

To reduce the risk of electric shock, do not remove cover. No user serviceable parts inside.

 indicates safety information.

## Caution for AC Mains Lead

### FOR YOUR SAFETY PLEASE READ THE FOLLOWING TEXT CAREFULLY.

This product is equipped with 2 types of AC mains cable. One is for continental Europe, etc. and the other one is only for U.K.

Appropriate mains cable must be used in each local area, since the other type of mains cable is not suitable.

#### FOR CONTINENTAL EUROPE, ETC.

Not to be used in the U.K.

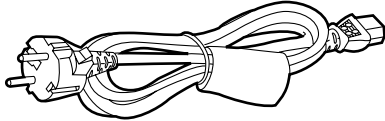

#### FOR U.K. ONLY

If the plug supplied is not suitable for your socket outlet, it should be cut off and appropriate one fitted.

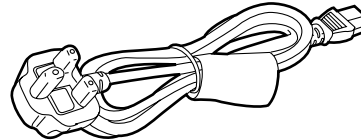

#### FOR U.K. ONLY

This appliance is supplied with a moulded three pin mains plug for your safety and convenience.

A 13 amp fuse is fitted in this plug.

Should the fuse need to be replaced please ensure that the replacement fuse has a rating of 13 amps and that it is approved by ASTA or BSI to BS1362.

Check for the ASTA mark  or the BSI mark  on the body of the fuse.

If the plug contains a removable fuse cover you must ensure that it is refitted when the fuse is replaced.

If you lose the fuse cover the plug must not be used until a replacement cover is obtained.

A replacement fuse cover can be purchased from your local Panasonic Dealer.

IF THE FITTED MOULDED PLUG IS UNSUITABLE FOR THE SOCKET OUTLET IN YOUR HOME THEN THE FUSE SHOULD BE REMOVED AND THE PLUG CUT OFF AND DISPOSED OF SAFELY. THERE IS A DANGER OF SEVERE ELECTRICAL SHOCK IF THE CUT OFF PLUG IS INSERTED INTO ANY 13 AMP SOCKET.

If a new plug is to be fitted please observe the wiring code as shown below.

If in any doubt please consult a qualified electrician.

**WARNING:** THIS APPLIANCE MUST BE EARTHED.

**IMPORTANT:** The wires in this mains lead are coloured in accordance with the following code:

Green-and-Yellow:	Earth
Blue:	Neutral
Brown:	Live

As the colours of the wires in the mains lead of this appliance may not correspond with the coloured markings identifying the terminals in your plug, proceed as follows:

- The wire which is coloured GREEN-AND-YELLOW must be connected to the terminal in the plug which is marked with the letter E or by the Earth symbol  or coloured GREEN or GREEN-AND-YELLOW.
- The wire which is coloured BLUE must be connected to the terminal in the plug which is marked with the letter N or coloured BLACK.
- The wire which is coloured BROWN must be connected to the terminal in the plug which is marked with the letter L or coloured RED.

#### How to replace the fuse

1. Open the fuse compartment with a screwdriver.

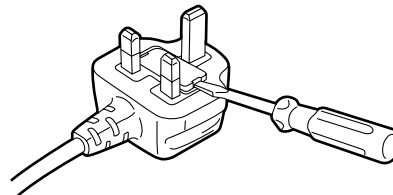

2. Replace the fuse.

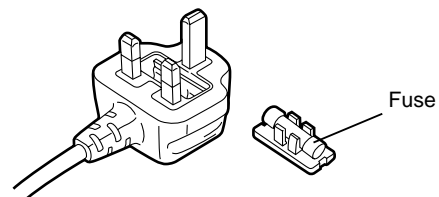

# Contents

<b>For your safety</b> .....	2
<b>General outline</b> .....	6
<b>Standard accessories</b> .....	6
<b>Features</b> .....	7
<b>Parts and Their Functions</b> .....	8
• Front panel .....	8
• Time code display .....	16
• Rear panel .....	18
<b>Connections</b> .....	20
• Example of connections performed for one VTR .....	20
• Example of connections performed for two VTRs (deck-to-deck) .....	20
• Example of system connections in 23/24 Hz or 25 Hz (HD) mode .....	21
• Example of system connections in 25 Hz (SD) mode .....	21
• Example of connections with an editing controller .....	22
<b>Concerning tapes</b> .....	23
<b>Turning on the power and inserting the cassette</b> .....	24
<b>STOP and STANDBY modes</b> .....	24
<b>Recording</b> .....	25
<b>Playback</b> .....	26
<b>Jog/shuttle</b> .....	27
<b>Manual editing</b> .....	28
<b>Preroll</b> .....	28
<b>Automatic editing (deck-to-deck)</b> .....	29
• Switch settings and adjustments .....	29
• Selecting the editing mode .....	30
• Registering the edit points .....	30
• Checking the edit points .....	31
• Modifying edit points .....	31
• Previewing .....	32
• Automatic editing .....	32
• Reviewing .....	33
<b>Audio split editing</b> .....	34
<b>Variable memory function</b> .....	36
<b>Function menus</b> .....	38
• General description .....	38
• Allocating the function keys .....	39
• How to switch the settings .....	40
• HOME .....	41
• VIDEO .....	47
• AUDIO .....	49
• TC .....	51
• CUE .....	52
• DIAG .....	55
• MENU .....	57
• ASSEMBLE .....	58
• INSERT .....	59
• SETUP MENU/SYSTEM MENU .....	60
• FILE .....	62
• PF1/PF2 .....	64
• CARD .....	69
• 50P IN/OUT ASSIGN .....	72
<b>System menus</b> .....	78
<b>Setup menus</b> .....	81
• BASIC .....	81
• OPERATION .....	84
• INTERFACE .....	87
• EDIT .....	88
• TAPE PROTECT .....	90
• TIME CODE .....	91
• VIDEO .....	93
• AUDIO .....	98
• MENU .....	104
• Connections with Dolby-E components .....	104
• How to switch the system frequency .....	105
• Selecting the recording/playback format and sync signals which support the operation mode .....	105
• Menu management accompanying switching the system frequency .....	106
<b>Time code and user's bit</b> .....	111
• Time code .....	111
• User's bit .....	111
• Setting the internal time code .....	111
• Setting the external time code .....	112
• Cue time registration, preroll and cue-up (These functions work only on the HOME, PF1 and PF2 screens.) .....	112
• Time code and user's bit playback .....	112
<b>Superimpose screen</b> .....	113
<b>Selecting the audio recording channels and monitor output</b> .....	114
<b>Display saving function</b> .....	115
<b>Rack mounting</b> .....	116
<b>Video head cleaning</b> .....	117
<b>Condensation</b> .....	117
<b>Maintenance</b> .....	117
<b>Error messages</b> .....	118
• DIAG menu .....	118
• Warning messages .....	120
• Error messages .....	120
<b>RS-232C interface</b> .....	122
<b>Connector signals</b> .....	128
<b>Printed circuit boards</b> .....	129
<b>Specifications</b> .....	130

## **General outline**

---

The model AJ-HD1700 is a DVCPRO HD-LP format HD digital video cassette recorder which uses 1/4" wide compact cassette tapes.

It can record, play back and edit 1080/59.94i (60i), 720/59.94p (60p) and 1080/50i HD signals and also play back existing DVCPRO (25 Mbps or 50 Mbps) tapes.

It is also capable of converting from sources with a 720/24p over 60p (720/25p over 60p) format recorded using a variable frame rate camera into a 1080/24psf (1080/25psf) format and outputting the resulting signals, thus fulfilling the needs of applications in the cinema film production field.

Further, the HD-SD conversion facility of its format converter, which is provided as a standard accessory, extends the uses of this VTR to encompass interfacing with existing SD systems and into configuring of HD systems.

By mobilizing highly efficient digital compression technology to assure a high picture quality, this VTR significantly minimizes deterioration in the picture quality and sound quality during the dubbing process.

It features a compact size of 4U and a lightweight design that enables it to be carried around with ease, and to be readily installed in a 19-inch rack.

The equipment is set up using an interactive system whereby the operator manipulates the function buttons on the front panel and observes the menu screens on the front panel's LED monitor.

In terms of the editing features, this VTR is capable of both assemble editing and insert editing.

## **Standard accessories**

---

<b>Power cord (AJ-HD1700P)</b> .....	<b>1</b>
<b>Power cord (AJ-HD1700E)</b> .....	<b>2</b>

# Features

---

## Compact size and light weight

This is a 4U digital VTR. Using the rack-mounting adapters (AJ-MA75P: optional accessory), it can also be easily housed in a 19-inch rack.

## Up to 126 minutes of recording

Using the DVCPRO HD-LP recording system, up to 126 minutes of material can be recorded on the newly developed 1/4" XL-size cassette tape.

## High picture quality

The VTR's high picture quality is achieved by 4:2:2 HD component signal recording using a recording rate (100 Mbps) which is 4 times higher than that of the existing DVCPRO format.

## 1080i/720p (\*1), 59.94 Hz/60 Hz/50 Hz signal switching

By making menu selections, the signals of the respective formats can be recorded and played back.

\*1: When the system frequency of 50 Hz has been selected, recording and playback using the 720p format are not possible.

## Frame rate conversion function

By making menu selections, the VTR can output signals after converting them to the 1080/24psf (25psf) format when it plays back a tape recorded by a variable frame rate camera at a frame rate of 24fps (25fps).

## SDI interface

The VTR comes with an HD serial digital interface as a standard accessory.

## Playback compatibility with DVCPRO systems

Besides DVCPRO HD-LP recording and playback, the VTR can also play back tapes which have been recorded using the existing DVCPRO HD, DVCPRO50 and DVCPRO systems.

Consumer-use DV tapes (SP) and DVCAM tapes can also be played back on this VTR.

## Digital slow motion/dial jog

Panasonic's unique digital slow motion technology enables clear playback (of tapes recorded using the DVCPRO HD-LP system) at speeds ranging from  $-1\times$  to  $+2\times$ .

### <Note>

Some noise may occur during slow playback (using an external controller) at speeds of almost exactly  $-1\times$  or  $+2\times$ .

## Search speed

Search speed enables tapes (recorded using the HD-LP system) to be played back with color images at speeds of up to 100 times in the forward or reverse direction.

## Time codes

This VTR comes with a built-in time code generator (TCG)/time code reader (TCR).

In addition to the internal time code, an external time code can also be input and recorded as the LTC on the VTR.

## Multi-functional interfaces

### • Serial digital input/output connector

The VTR comes with an HD component serial interface input/output connector. This one BNC connector enables HD component video signals and 8-channels digital audio signals to be interfaced. (SMPTE 292M, 299M, BTA S-004)

It is also equipped with an HD/SD format converter as a standard accessory so that SD component serial signals can also be output. (SMPTE 259M-C, 272M-A, 294M)

### • Analog video output connector

Composite signals are output during DVCPRO50- or DVCPRO-compatible playback, DV playback, DVCAM playback and down-conversion.

### • AES/EBU audio input/output connectors

Digital audio input/output connectors for 8 channels are featured as a standard accessory.

### • SDTI input/output connector

Use of the SDTI board (optional accessory) enables interfacing with the compressed component signals still in their original form. (SMPTE 305M, 321M)

### • SD signal up-conversion and recording

Using the input up-converter board (optional accessory), SD component serial signals (SMPTE 259M-C) can be up-converted and recorded as HD signals.

### • 9-pin RS-422A and RS-232C remote control connectors

In addition to the standard 9-pin serial remote (RS-422A) control connector, the VTR is provided with RS-232C and 50-pin parallel remote control connectors.

The RS-422A facility enables parallel operation if a loop connection has been established between the VTR and another VTR.

## 8-channel high-sound-quality digital audio

The 8-channel PCM audio feature allows for not only independent editing but mixing as well on all 8 channels. One channel is provided for the analog cue track.

## Menu-driven setup

The setup settings, which are conducted prior to operating the VTR, are performed while the operator views the setup menus either on the VTR's LCD monitor or on a TV monitor.

## Multi-functional front panel with LCD monitor

The front panel's multiple functions, including the LCD monitor for monitoring images, the function buttons and large-size display panel, are contained within the 4U dimensions and designed to improve operating ease.

# Parts and Their Functions

## Front panel

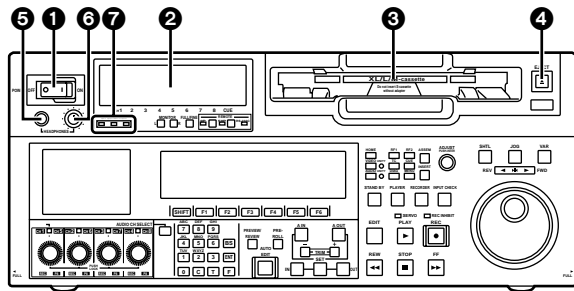

### 1 POWER switch

### 2 Audio level meter

The audio information is displayed here.

- The levels of the CH1, CH2, CH3, CH4, CH5, CH6, CH7 and CH8 PCM audio signals and level of the CUE track signal are displayed here.
- The levels of the input signals are displayed during recording and when E-E is selected. During playback, the levels of the playback signals are displayed. In the INPUT CHECK status, the levels of the input signals are displayed for CH1 to CH8.

- Input signal display for each of the channels  
The indicators for the selected input signals light. (SDI lights when the SD SDI input signal is selected.)

If an input signal has been selected but it has not actually been input, the AES, HDS DI, SDI or SDTI indicator will blink if a signal corresponding to one of these indicators was selected whereas the ANA indicator will remain lighted if it was an ANA signal that was selected.

When the internal signal (INT SG) has been selected, all the AES, ANA, HDS DI, SDI and SDTI indicators light.

All the indicator are off in the 23/24 Hz mode or 25 Hz (HD or SD) mode.

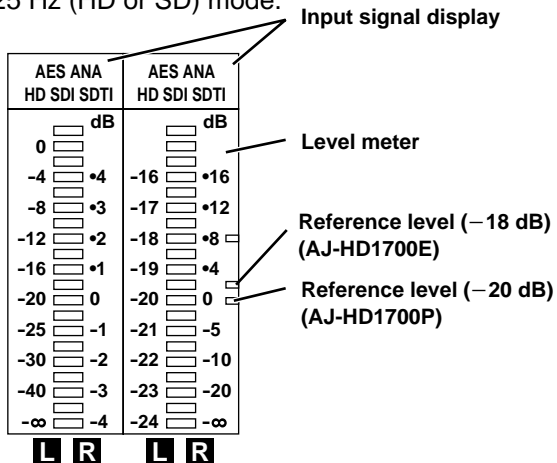

Left (L) and right (R) monitor channel displays

### 3 Cassette insertion slot

If the slot's orange plate is visible, it means that a cassette tape is already inserted.

### 4 EJECT button

When this button is pressed, the cassette is unloaded, and a few seconds later it is ejected automatically.

When CTL appears on the counter display, the display is reset.

### 5 Headphones jack

The sound heard during recording, playback or editing can be monitored through headphones when stereo headphones are connected to this jack.

### 6 Volume control dial

This control dial is used to adjust the volume level of the headphones and monitor output.

Whether the volume level of the monitor output is to be coupled together with that of the headphones to this dial or separated can be selected using the setup menu item No.712 (MONI OUT). (Note that the volume level of the headphones is coupled at all times.) When the volume levels have been separated, the UNITY value (prescribed value) applies to the monitor output.

### 7 Channel condition lamps

**These lamps light to indicate the error rate status.**

**(Green → amber → red)**

**Green:** This lights when the error rates for the video and audio playback signals are both at acceptable levels.

**Amber:** This lights when the error rate for either the video or audio playback signals has deteriorated. The playback picture and sound remain unaffected even while this lamp is lighted.

**Red:** This lights when correction or interpolation has been engaged for either the video or audio playback signals.



# Parts and Their Functions

## Front panel

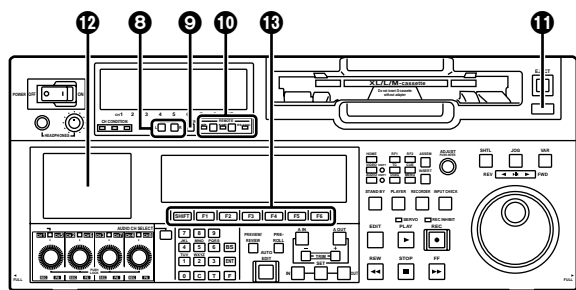

### ③ MONITOR SELECT buttons

These buttons are used to select the audio signals which are to be output to the monitor L and R connectors and headphones jack.

- When OFF has been selected as the **[F6] M MIX** setting on the <AUDIO SHIFT> menu (factory setting):

Each time the L (or R) button is pressed, the signal to be output to the monitor L (or R) connector is changed in the following sequence and displayed on the audio level meter: CH1 → CH2 → CH3 → CH4 → CH5 → CH6 → CH7 → CH8 → CUE → CH1, etc.

- When L, R or L/R has been selected as the **[F6] M MIX** setting on the <AUDIO SHIFT> menu:

At this setting, the signals of a multiple number of channels can be mixed and output.

When the number key corresponding to the channel whose signals are to be monitored is pressed while the L (or R) button is held down, that channel is selected and its signals are displayed on the audio level meter. (By performing the same operation, the selected channel can be de-selected.)

However, a maximum of only two channels from CH1 to CH4 and a maximum of only two channels from CH5 to CH8 can be selected.

Example of channels which can be selected:

CH1 + CH3 + CH5 + CH8 ▶ OK

CH1 + CH2 + CH4 ▶ NG

### ⑨ METER (FULL/FINE) selector button

This button is used to select the scale display for the audio level meter.

**FULL mode:** Depending on the setting selected for the setup menu item No.763 (METER SCALE)\*, either the  $-\infty$  to 0 dB (reference level:  $-20$  dB/ $-18$  dB\*\*) or  $-\infty$  to +20 dB (reference level: 0 dB) range is displayed.

**FINE mode:** Depending on the setting selected for the setup menu item No.763 (METER SCALE)\*, either the  $-24$  to  $-15$  dB (reference level:  $-20$  dB/ $-18$  dB\*\*) or  $-4$  to +5 dB (reference level: 0 dB) range is displayed on a scale with 0.5 dB increments.

\* This menu is not displayed for AJ-HD1700E.

\*\*  $-20$  dB is applied for AJ-HD1700P and  $-18$  dB is for AJ-HD1700E.

### ⑩ REMOTE buttons and RS-232C display

These buttons are used when this VTR is to be controlled from an external component using the REMOTE, RS-232C or parallel connector.

**9P:** When this button is pressed for 2 or more seconds, its LED lights, and the 9-pin REMOTE connector is selected.

**50P:** When this button is pressed for 2 or more seconds, its LED lights, and it is possible to control the VTR from a unit which has been connected using the 50-pin parallel mode connector.

**RS-232C display:** This LED lights when communication has been enabled between the VTR and the unit which has been connected to the RS-232C connector.

### ⑪ AUTO OFF lamp

This lamp lights when a problem has occurred with the VTR's operation, and details of the problem appear on the time code display.

### ⑫ LCD monitor

This monitor is used to check the tape's playback pictures and EE pictures.

When an HD tape is played back, the signals are down-converted and displayed in the letter-box screen format.

When an SD tape is played back, the signals are displayed using a 4:3 aspect ratio.

On-screen menus can also be displayed on the monitor.

If the VTR is left in a state where no controls on the front panel are operated or where the tape is not running, the monitor display is automatically turned off in order to protect the monitor. When the next VTR operation is started, the monitor display comes back on.

#### <Note>

Although the LCD monitor has been manufactured using technology with extremely high levels of precision, some pixels may be missing from parts of the screen or some pixels may remain lighted. These missing or lighted pixels will not be recorded. It should also be borne in mind that this is not indicative of a malfunction.

### ⑬ Function buttons

These buttons are used to perform the operations of the function menus (see page 38 for details) and setup menus.

**[SHIFT]** : This is used to switch the pages of the current function menu ( **[F1]** to **[F6]** ).

**[F1] to [F6]** : These are used to change the settings of the setting items enclosed in the frame at the bottom of the time code display.

To change a setting, keep pressing the corresponding function button ( **[F1]** to **[F6]** ) until the desired numerical value appears; alternatively, press the corresponding function button to highlight the setting of the setting item, and then turn the ADJUST dial until the desired numerical value is obtained.

# Parts and Their Functions

## Front panel

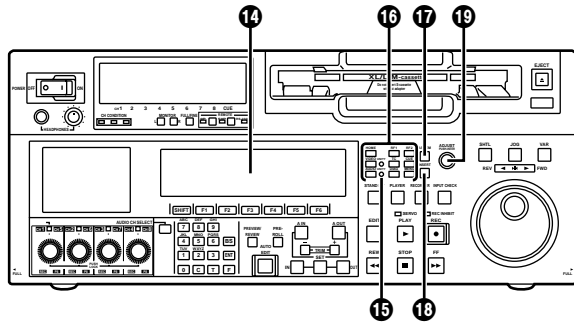

### 14 Time code display

The data, VTR status information, tape format information or warning information which corresponds to the direct menu buttons 16 appear on this display. (See page 16 for details of the displays.)

### 15 UNITY lamps

#### VIDEO UNITY lamp

This lights if the UNITY level applies for all the HD or SD output levels.

#### AUDIO UNITY lamp

This lights if the UNITY level applies for the PCM or CUE AUDIO input or output level. (The lighting of the lamp complies with the setting selected for setup menu item No.142 (AUDIO UNITY).)

### 16 Direct menu buttons

These buttons are used to switch directly to the function menus on the time code display.

**HOME:** The most basic settings of recording, playback and time code operations are selected on this menu.

**VIDEO:** The basic input and output settings for the video signals are selected on this menu. The level of the HD output signals can also be adjusted on this screen.

**AUDIO:** The basic input and output settings for the audio signals are selected on this menu.

**PF1:** This enables user-defined menu items to be registered in the function keys.

**PF2:** This enables user-defined menu items to be registered in the function keys.

**TC:** The settings related to the time code are selected on this menu. Superimposing the time code on the display can also be set on this screen.

**CUE:** This enables up to 60 cue points to be set. In the PAGE mode, 10 pages with 6 cue points on each page are provided so that the cue points can be managed on a page-by-page basis.

**DIAG:** This enables the warnings and hour meter displays to be checked. On the SHIFT screen, the error log files can be checked and deleted.

**MENU:** On this menu, it is possible to transfer operation to the screen on which operations (adjustments and saving data in or loading it from the internal memory and IC card) relating to the SYSTEM and SETUP menus are to be performed.

See page 38 and following for further details on each of the function menus.

### 17 ASSEM button

This button is used to perform assemble editing.

When it is pressed, the <ASSEMBLE> menu appears on the time code display. Setting ASSEM to ON using [F1] enables assemble editing, and the lamp of the ASSEM button lights.

Even after operation is transferred by another direct menu, the assemble mode will remain established while the ASSEM button lamp is lighted.

To release the assemble mode, select OFF as the [F1] ASSEM setting on the <ASSEMBLE> menu.

The ASSEM button lamp now goes off and the assemble mode is released.

### 18 INSERT button

This button is used to perform insert editing.

When it is pressed, the <INSERT> menu appears on the time code display, and the function menu for selecting the signals to be edited is displayed.

To select the signals to be edited, press the function key, and highlight the display. The highlighted display indicates that those signals are selected.

To release the selection, press the same function key again.

Use [F1] to [F6] to select the V, A1, A2, A3, A4 and CUE signals; use [SHIFT] + [F2] to [F6] to select the A5, A6, A7, A8 and TC signals.

### 19 ADJUST dial

This is used for the menu and other operations.

# Parts and Their Functions

## Front panel

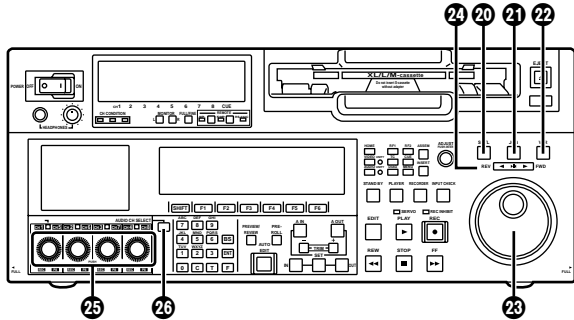

### 20 SHTL button

For shuttle playback, press this button and proceed with the operation using the search dial 23.

When the dial is turned to the desired position, the tape is played at the speed corresponding to the angle to which the dial has been turned. A still picture appears when the dial is set to the center position.

### 21 JOG button

For jog playback, press this button and proceed with the operation using the search dial 23.

The tape is played at a speed within the speed range set using setup menu items No.310 (JOG FWD MAX) and No.311 (JOG REV MAX) in accordance with the speed at which the dial is turned.

### 22 VAR button

For VAR playback, press this button and proceed with the operation using the search dial 23.

When the dial is turned all the way in the counterclockwise direction, the tape speed is set to  $-4.9\times$ , when it is set to the center position, it is set to still picture, and when it is turned all the way in the clockwise direction, it is set to  $+4.9\times$ .

The SLOW speed can be selected using setup menu items No.308 (VAR FWD MAX) and No.309 (VAR REV MAX).

### 23 Search dial

This dial is used to locate the edit points.

Whether the dial is to be enabled by pressing the SHTL, JOG or VAR button or whether searches are to be enabled simply by turning the dial can be selected using setup menu item No.100 (SEARCH ENA).

### 24 REV, STILL and FWD lamps

These lamps light to reflect the way in which the search dial is operated.

**REV:** This lights when the dial is turned counterclockwise, and the tape runs in the REV direction while the SHTL, JOG or VAR button lamp is lighted.

**STILL:** While the JOG button lamp is lighted, this lights when the dial rotation is stopped, and the tape also stops running.

In the SHTL or VAR mode, it lights when the dial is at the still-picture position.

**FWD:** This lights when the dial is turned clockwise, and the tape runs in the FWD direction while the SHTL, JOG or VAR button lamp is lighted.

### 25 Audio input and output level control dials

These are used to adjust the recording or playback levels of the CH1, CH2, CH3, CH4, CH5, CH6, CH7 and CH8 PCM audio signals.

#### • Switching between the LOCK or UNLOCK status for the volume level operations

When a dial is pressed, the LED above the dial either lights (LOCK) or goes off (UNLOCK).

In the LOCK (lighted) status, only the display segments corresponding to the current audio level light, and the audio level remains unchanged even when the dial is turned.

In the UNLOCK (off) status, the display segments corresponding to the current audio level and all the display segments below light, and the audio level can be changed.

#### • Switching between UNITY or VAR

UNITY or VAR can be selected when the dial knob is pressed while holding down the **[F]** key among the number keys in the UNLOCK status. The position of the segment lighted at the center indicates the UNITY level.

#### • Switching between REC or PB

The AUTO, REC or PB volume level function can be selected using **[F1]** of "AUDIO SHIFT2" on the AUDIO function menu.

With AUTO, the recording controls are automatically selected during recording or in the EE or INPUT CHECK status, and the playback controls are automatically selected during playback.

#### • Switching between CH1–CH4 and CH5–CH8

The AUDIO CH SELECT 26 is used to switch between these two sets of channels.

# Parts and Their Functions

## Front panel

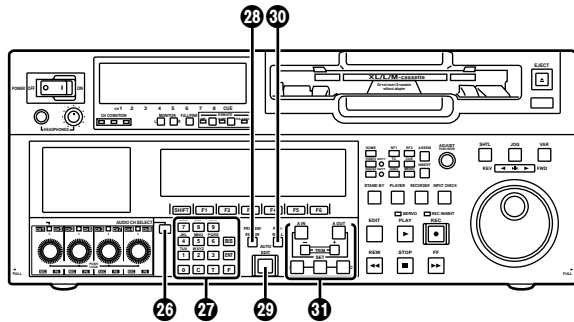

### 26 Audio channel selector button

Use this button to select whether the audio controls for channels CH1 to CH4 or for channels CH5 to CH8 are to be controlled.

Each time it is pressed, the channel display LED above the audio control is selected.

### 27 Number keys

Use these keys to input the numerical values of the CUE points, edit points, etc.

By pressing a number keys from [1] to [9] while the [F] key is held down, alphabet letters from A to F which are used for the user's bit or letters from A to Z which are used to compose filenames can be input.

Since a multiple number of letters are allocated to each number key, keep tapping the number key until the desired letter is selected. To change the input position, use the ADJUST dial, and then proceed with the input.

### 28 PREVIEW/REVIEW button

**PREVIEW:** When the button is pressed after an edit point has been registered, the tape travels and the editing can be previewed without actually performing the editing.

If the button is pressed when the IN point has not been registered, the point where it was pressed is registered as the IN point, and preview is executed using this IN point.

**REVIEW:** When the button is pressed after a section has been edited, the just edited section is played back, and it can be reviewed on the recorder's monitor.

### 29 AUTO EDIT button

When this button is pressed after the edit points have been registered, automatic editing is initiated.

If the button is pressed when the IN point has not been registered, automatic editing is initiated with the point where the button was pressed serving as the IN point.

### 30 PREROLL button

This button is used to locate where a transmission or manual editing starts on the tape.

When it is pressed, the tape travels to the preroll point and it stops there.

**When the cue time has been registered on the HOME, PF1 or PF2 screen:**

The tape is prerolled from the registered cue time using the preroll time which was set using [F1] (PREROL) on the <HOME SHIFT> menu.

**When the search mode is established on the CUE screen:**

The tape is prerolled from the selected cue point using the preroll time which was set using [F5] (CU-ROL) on the <CUE SHIFT> menu.

The preroll operation is not performed when the selected cue point has not been registered or when the cue point registration mode is established.

**In all other situations:**

The tape is prerolled from the registered IN point (or the current tape position when the IN point has not been registered) using the preroll time which was set using [F1] (PREROL) on the <HOME SHIFT> menu.

If the PREROLL button is pressed when the IN point has not been registered, the current tape position is automatically registered as the IN point (but only when ENA has been selected as the setup menu item No.305 (AUTO ENTRY) setting).

When the PREROLL button is pressed together with the IN (A IN) or OUT (A OUT) button, the tape can be cued up to the registered point concerned.

To cue up the tape for the cue time registered on the HOME, PF1 or PF2 screen, press the PREROLL button while holding down the [F] key among the number keys.

### 31 IN (A IN), SET and OUT (A OUT) buttons

When the IN (A IN) or OUT (A OUT) button is pressed together with the SET button, the IN (A IN) or OUT (A OUT) point is registered. The A IN and A OUT buttons are used to register audio IN and OUT points that differ from the corresponding video points during audio split editing.

When an IN (A IN) or OUT (A OUT) point has been registered, the lamp of the IN (A IN) or OUT (A OUT) button which has registered that point lights. When these buttons are pressed after points have been registered, the IN (A IN) or OUT (A OUT) point value appears on the counter display.

When the [C] button is pressed while holding down the IN (A IN) or OUT (A OUT) button, the registration of the IN (A IN) or OUT (A OUT) point is cleared.

# Parts and Their Functions

## Front panel

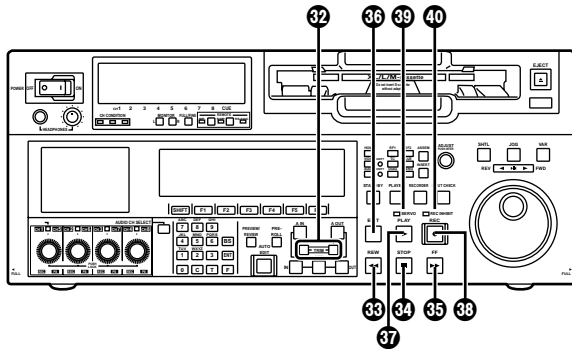

### 32 TRIM buttons

These buttons are used to make fine adjustments to the IN or OUT point.

By pressing the + or – button while the IN button or OUT button is held down, the registered edit point can be adjusted in 1-frame increments. When the + button is pressed, the point is moved ahead by one frame; conversely, when the – button is pressed, it is moved back by one frame.

The playback phase can be adjusted by pressing the + or – button while holding down the PLAY button.

### 33 REW button

When this button is pressed, the tape is rewind.

The rewinding speed can be selected using setup menu item No.102 (FF.REW MAX).

### 34 STOP button

When this button is pressed, the tape stops traveling, and if TAPE is selected as the [F1] OUTPUT setting on the <HOME> menu, still pictures can be monitored.

Even in the stop mode, the drum continues to rotate, and the tape remains tightly wound around the drum. Therefore, when the VTR is left in the stop mode beyond a specific period of time, it is automatically set to the standby OFF mode in order to protect the tape. The VTR is set to the stop mode immediately after the cassette has been installed.

### 35 FF button

When this button is pressed, the tape is fast forwarded.

The fast forwarding speed can be selected using setup menu item No.102 (FF.REW MAX).

### 36 EDIT button

This button is pressed together with the PLAY button during playback to initiate manual editing.

When the button is pressed in the stop mode, the input signals in the mode selected by the <ASSEMBLE> menu or <INSERT> menu can be monitored in the E-E mode.

When the STOP button is pressed, the original picture and sound are restored.

During playback, search, fast forwarding or rewinding, the input signals in the mode selected by the <ASSEMBLE> menu or <INSERT> menu can be monitored in the E-E mode while the button is held down.

#### <Note>

No guarantees are made for the sound played back in the search mode.

### 37 PLAY button

Press this button to start playback.

When this button is pressed together with the REC button, recording starts; when this button is pressed together with the EDIT button during playback, manual editing starts.

However, manual editing will not be initiated if the servo is not locked. When only the PLAY button is pressed during manual editing, editing is exited, and the playback mode is established.

### 38 REC button

When this button is pressed together with the PLAY button, recording starts.

### 39 SERVO lamp

This lamp lights when the drum servo or capstan servo locks.

### 40 REC INHIBIT lamp

This lights or goes off in accordance with the status of the accidental erasure prevention tab on the cassette tape and the setting which has been selected for [F6] REC INH on the <HOME> menu. Recording onto the tape is inhibited while the lamp is lighted.

Cassette tape's accidental erasure prevention tab status	REC INH menu setting	REC INHIBIT lamp status	Description of operation
Recording disabled	—	Lighted* (or blinks slowly).	All recording operations are inhibited.
	OFF	Off	All recording operations are permitted.
Recording enabled	ALL	Lighted	All recording operations are inhibited.
	PRE	Blinks rapidly	Recording operations involving the overwriting of existing material are inhibited.
	NORM	Blinks rapidly	Normal recording operations are inhibited. Editing is possible.
	V/CTL	Blinks rapidly	Recording of video signals and CTL signals are inhibited.

\* Whether the REC INHIBIT lamp is to light or blink is selected by the No.114 REC INH LAMP setup menu item setting.

# Parts and Their Functions

## Front panel

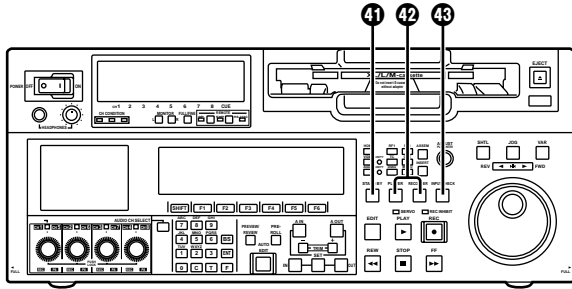

### 41 STANDBY button

The same tape tension is applied as in the regular stop mode. While the head drum is rotating, the button's lamp lights to indicate that the standby ON mode is now established.

If the button is pressed in the stop mode, the standby OFF mode is established followed by the half loading mode. At this time, its lamp goes off.

When the VTR is left in the stop mode beyond a specific period of time, it is automatically set to the standby OFF mode in order to protect the tape.

In the standby OFF mode, if this button or the STOP button is pressed, the VTR is set to the standby ON mode. If a button other than the STOP button is pressed, the VTR is set to the mode that corresponds to the button pressed.

The time taken by the VTR to transfer to the standby OFF mode can be selected using a setup menu item.

### 42 PLAYER and RECORDER buttons

These buttons are operated if the VTR is to be used as a recorder to conduct editing operations with a VTR equipped with an RS-422A serial interface remote control connector (9 pins). Neither button works when the VTR is used on its own.

**PLAYER:** When this button is pressed, its lamp lights to indicate that the player connected to the VTR can be operated by remote control. The VTR's editing and tape transport system buttons can now be used to control the player.

**RECORDER:** When this button is pressed, its lamp lights to indicate that the editing and tape transport system buttons can now be used to operate the recorder (this VTR).

- When the PLAYER button or RECORDER button is pressed while ENA has been selected as the setup menu item No.200 (PARA RUN) setting, the lamps of both buttons light to indicate that the VTR now serves as the master unit for parallel run operations. However, when this setting is used, it is no longer possible to perform external control from the REMOTE connector (9 pins).

### 43 INPUT CHECK button

Only while this button is held down are the input signals from the monitor output connector output to enable the input video and audio signals to be monitored.

The time code generator can be checked on the time code display.

Select LATCH as the setup menu item No.517 (TCG OUT) setting in order to continue displaying the time code generator value even after the INPUT CHECK button has been released.

#### <Note>

The INPUT CHECK function does not work for the CUE signal and SDTI signals. Input signals can be monitored in the E-E mode.

# Parts and Their Functions

## Front panel

### INPUT CHECK output specifications

#### VIDEO (59/60 Hz mode)

Input selection (MENU 600)	INT SG (59.94Hz/ 60Hz)	HD SDI (59.94Hz/ 60Hz)	SD SDI (59.94Hz)	SDTI (59.94 Hz)
Output system				
HD SDI (MONITOR) (59.94Hz/60Hz)	INT SG (selected signal)	HD SDI (input signal)	MUTE (BLACK)	Same as main system*
SD SDI (MONITOR) (59.94Hz)	MUTE (BLACK)	MUTE (BLACK)	SD SDI (input signal)	Same as main system*
LCD (MONITOR) (59.94Hz/60Hz)	INT SG (selected signal)	HD SDI (input signal)	SD SDI (input signal)	Same as main system*
VIDEO OUT3 (59.94Hz)	Same as main system*	Same as main system*	Same as main system*	Same as main system*

#### VIDEO (50 Hz mode)

Input selection (MENU 600)	INT SG (50Hz)	HD SDI (50Hz)	SD SDI (50Hz)
Output system			
HD SDI (MONITOR) (50Hz)	INT SG (selected signal)	HD SDI (input signal)	MUTE (BLACK)
SD SDI (MONITOR) (50Hz)	MUTE (BLACK)	MUTE (BLACK)	SD SDI (input signal)
LCD (MONITOR) (50Hz)	INT SG (selected signal)	HD SDI (input signal)	SD SDI (input signal)
VIDEO OUT3 (50Hz)	Same as main system*	Same as main system*	Same as main system*

#### <Notes>

- The AJ-UC1700G (optional accessory) is required to select the SD SDI input signals.
- The AJ-YAC150P (optional accessory) is required to select the SDTI input signals.
- When the INT SG input signal is selected, the signals are selected by menu item No.601.
- When the 23/24 Hz mode or 25 Hz (HD or SD) mode is selected, the INPUT CHECK operation is not performed.

\* When the SDTI input is selected, the INPUT CHECK operation is not performed.

#### AUDIO

Output system	MONITOR (L, R) selection	
	CH1 to CH8	CUE
MONITOR L	Audio input which has been set by the channels selected as L channels*2	Same as main system*1
MONITOR R	Audio input which has been set by the channels selected as R channels*2	Same as main system*1
HEAD PHONE L	Audio input which has been set by the channels selected as L channels*2	Same as main system*1
HEAD PHONE R	Audio input which has been set by the channels selected as R channels*2	Same as main system*1
HD SDI (MONITOR) (embedded audio)	Same as main system*1*3	
SD SDI (MONITOR) (embedded audio)	Same as main system*1*3	

\*1: The INPUT CHECK operation is not performed. The signals corresponding to the VTR operation mode are output.

\*2: This is set using setup menu items No.713 to 724. However, the INPUT CHECK operation is not performed when video input SDTI is selected.

\*3: Noise may occur if the video input and OUTREF signals are not synchronized.

# Parts and Their Functions

## Time code display

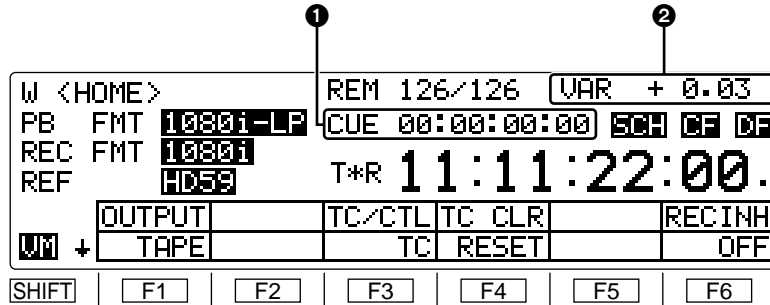

### ① Cue time display

The currently registered cue time appears here. (For details of the cue time operations, refer to “Cue time registration, preroll and cue-up” on page 112.) Cue time operations can be performed on the HOME, PF1 and PF2 screens only.

### ② Operation mode (speed) display

The current operation mode (including the speed display) appears here.

#### EJECT:

Eject mode

#### STANDBY OFF:

Standby OFF mode

#### T.RELEASE:

Tension release mode

#### STOP:

Stop mode

#### PREROLL:

Preroll mode

#### PLAY:

Playback mode

#### PLAY+:

Special playback (playback phase adjustment) mode (in FWD direction)

#### PLAY-:

Special playback (playback phase adjustment) mode (in REV direction)

#### REC:

Recording mode

#### JOG (REV/STILL/FWD):

Jog mode

#### VAR (speeds from -4.9× to +4.9×):

Variable mode

#### SHTL (speeds from -32.× to +32.0×):

Shuttle mode

#### FF:

Fast forwarding mode

#### REW:

Rewinding mode

#### EDIT:

Editing mode

#### AUTO EDIT:

Automatic editing mode

#### PREVIEW:

Preview mode

#### REVIEW:

Review mode

- When “ON” has been selected as the **F6** (VARMEM) setting on the <HOME SHIFT> menu:

#### DSPD (speeds from -1.0 to +2.0)

With the initial speed setting of the variable memory

#### DSMP (speeds from -1.0 to +2.0)

In the playback speed memory mode of the variable memory

#### DPLY (speeds from -1.0 to +2.0)

In the variable memory playback mode

#### DPRV (speeds from -1.0 to +2.0)

In the variable memory editing preview mode

#### DEDT (speeds from -1.0 to +2.0)

In the variable memory editing execution mode



# Parts and Their Functions

## Time code display

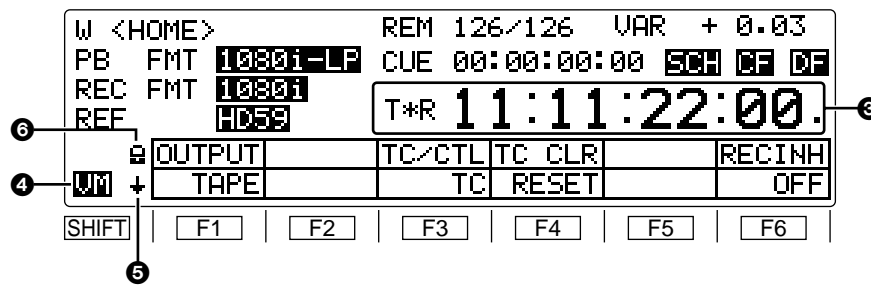

### 3 Time counter display

- CTL:** CTL counter data
- TCG:** Time code data of time code generator
- UBG:** User's bit data of time code generator
- tcg:** When the time code data of the time code generator is preset
- ubg:** When the user's bit data of the time code generator is preset
- TCR/T\*R:** Time code data of the time code reader
- UBR/U\*R:** User's bit data of the time code reader

If the time code data or user's bit data could not be read properly, "T\*R" or "U\*R" appears on the display and, if the CTL signal is present, the time code data is supplemented by this signal.

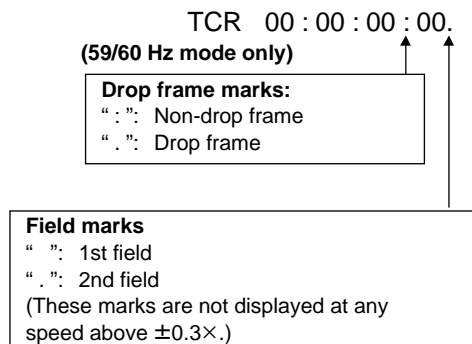

### 4 Variable memory mode indicator

This is displayed when "ON" has been selected as the [F6] (VARMEM) setting on the <HOME SHIFT> menu.

While VM is lighted, variable memory operations can be performed at any time. (For details, refer to the "Variable memory function" on page 36.)

### 5 Back page menu indicator

### 6 Function button operation inhibited indicator

This is displayed when the [BS] button is pressed while the [F] button is held down. When it appears, the operation of the function buttons can be inhibited. When the [BS] button is pressed again while the [F] button is held down, the display is cleared, and it becomes possible to operate the function buttons.

# Parts and Their Functions

## Rear panel

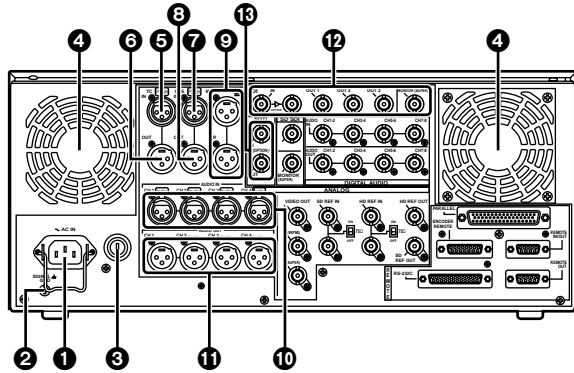

### 1 AC IN socket

Using the power cord supplied, connect one end to this socket and the other end to the power outlet.

### 2 SIGNAL GND terminal

This is connected to the signal ground terminal on the component connected to this VTR in order to minimize noise. It is not a safety ground.

### 3 Fuse holder

A fuse is inserted here.

### 4 Fan

The fan is used to cool down the VTR.  
If the fan has been stopped due to some kind of problem, "W" appears on the time code display and a beeping sound is heard.  
If the VTR is made to continue operating in the warning status, the temperature inside the deck rises, and when it exceeds the safety temperature, all the VTR's operations will be shut down.

### 5 TIME CODE IN connector

This connector is used to record an external time code onto the tape.

### 6 TIME CODE OUT connector

During playback, the playback time code is output through this connector. During recording, the time code generated by the internal time code generator is output.

### 7 CUE IN connector

The analog signals to be recorded on the CUE tracks are input through this connector.  
Audio signals from a microphone can also be recorded by selecting the -60 dB input mode for setup menu item No.704 (CUE IN LV).

### 8 CUE OUT connector

The analog signals recorded on the CUE tracks are output through this connector.

### 9 MONITOR OUT connectors

The CH1, CH2, CH3, CH4, CH5, CH6, CH7 and CH8 PCM audio signals or CUE signals are output through these connectors.

### 10 ANALOG AUDIO IN connectors

These are the analog audio input connectors (for CH1, CH2, CH3 and CH4).

### 11 ANALOG AUDIO OUT connectors

The analog audio signals (CH1, CH2, CH3 and CH4) are output through these connectors.

### 12 HD SERIAL DIGITAL COMPONENT AUDIO/VIDEO IN/OUT connector/ACTIVE THRU

The HD digital component audio and video signals complying with the SMPTE 292M and 299M standards are input and output through this connector.  
Signals with the time code, menu or other superimposed information are output from the HD SDI MONITOR.  
For INPUT CHECK, refer to the INPUT CHECK output table on page 15.

### 13 SDTI IN and OUT connectors (SDTI, optional accessory)\*1, SD SDI IN/ACTIVE THRU (SD up-converter, optional accessory)\*2

\*1: These connectors handle compressed data input and output signals complying with the SMPTE 305M and 321M standards.

\*2: These input connectors enable SD SDI signals complying with the SMPTE 259M-C standard to be up-converted to HD signals and recorded.

### <Notes>

- The optional AJ-UC1700G SD serial digital input board and optional AJ-YAC150P SDTI input board cannot be installed at the same time. Install one or the other.
- SDTI does not function when the 25 Hz (HD or SD) or 50 Hz mode has been selected as the system menu item No.25 (SYSTEM FREQ) setting.

# Parts and Their Functions

## Rear panel

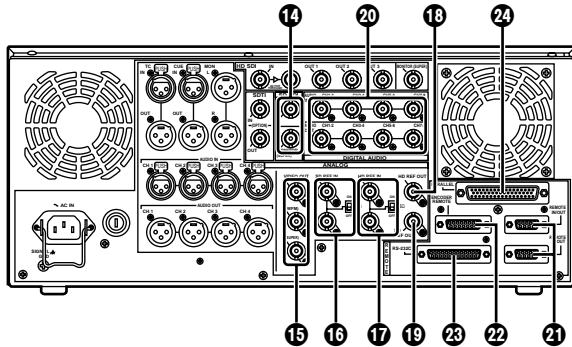

### 14 SD SERIAL DIGITAL COMPONENT AUDIO and VIDEO OUT connectors

The digital component audio and video signals complying with the SMPTE 259M-C, 272M-A or 294M standard are output from these connectors. They are output during DVCPRO25M, 50M, DV or DVCAM interchangeable playback or when signals are down-converted and output. Signals containing TC, menu or other superimposed information can be output from the SD SDI MONITOR.

Using setup menu item No.606 (SD MONI O SEL), it is also possible to make the SD SDI MONITOR output the same output as SD SDI OUT1 (no information superimposed).

When "SD SDI" has been selected as the **[F1]** (VID IN) setting on the <VIDEO> menu and "THRU" has been selected as the No.107 (EE MODE SEL) setting, no information is superimposed onto the SD SDI MONITOR output signals in the EE mode, and the same output as SD SDI OUT1 is delivered.

- The AJ-UC1700G optional board is required in order to select "SD SDI" as the **[F1]** (VID IN) setting on the <VIDEO> menu.
- For INPUT CHECK, refer to the INPUT CHECK output table on page 15. Note that the signals are muted during line conversion.

#### <Note>

In the 23/24 Hz mode, the system phase of the SD SDI output and analog composite video output is subject to change when the tape has been set to travel at the normal speed (1×) so that the HD SDI output and phase will be aligned.

### 15 ANALOG COMPOSITE VIDEO OUT connectors

The analog composite video signals are output through these connectors. They are output during DVCPRO25M, 50M, DV or DVCAM interchangeable playback or when signals are down-converted and output.

Video signals containing superimposed information can be output through the VIDEO OUT 3 connector. Whether the superimposing is to be set ON or OFF is selected using the setup menu item No.005 (SUPER).

The waveform monitor (WFM) signal can be output from the VIDEO OUT 2 connector.

The signals which can be switched using the menu items are the TC, CTL, video, RF L/R and ENV L/R signals. There is no INPUT CHECK function. The signals are muted during line conversion.

### 16 SD REF IN connectors and 75-ohm termination switches

These are the SD reference video signal input connectors. Input composite signal with color burst. For termination, set the termination switch to ON.

### 17 HD REF IN connectors and 75-ohm termination switches

These are the HD reference video signal input connectors. Input tri-level sync signals with both positive and negative polarities.

For termination, set the termination switch to ON.

### 18 HD REF OUT connector

This is the HD reference video signal output connector for external synchronization. Tri-level sync signals with both positive and negative polarities are output.

The output based on SYS FORMAT of menu item No.020 is delivered from the connector.

### 19 SD REF OUT connector

The composite signal used for external synchronization (black burst signal) is output from this connector.

### 20 DIGITAL AUDIO IN and OUT connectors

These are the input and output connectors of the digital audio signals that comply with the AES/EBU standards.

### 21 Remote control connectors

These connectors make it possible to use two of these VTRs or to connect this VTR to an external controller so that this VTR can be operated from an external component.

Two remote control connectors are provided: one for IN/OUT uses and the other for OUT uses only.

**IN/OUT:** For connection with an external controller

For connection during deck-to-deck operations

**OUT:** For connection during parallel run operations

For loop-through uses

### 22 ENCODER REMOTE connector

An external encoder remote controller is connected to this connector when the video output signal settings are to be adjusted from an external component.

### 23 RS-232C connector

### 24 PARALLEL REMOTE connector

This is used when the VTR is to be operated from an external component.

# Connections

## Example of connections performed for one VTR

### Player side:

Set the REMOTE LED ⑩ on the front panel to the off status (LOCAL mode).

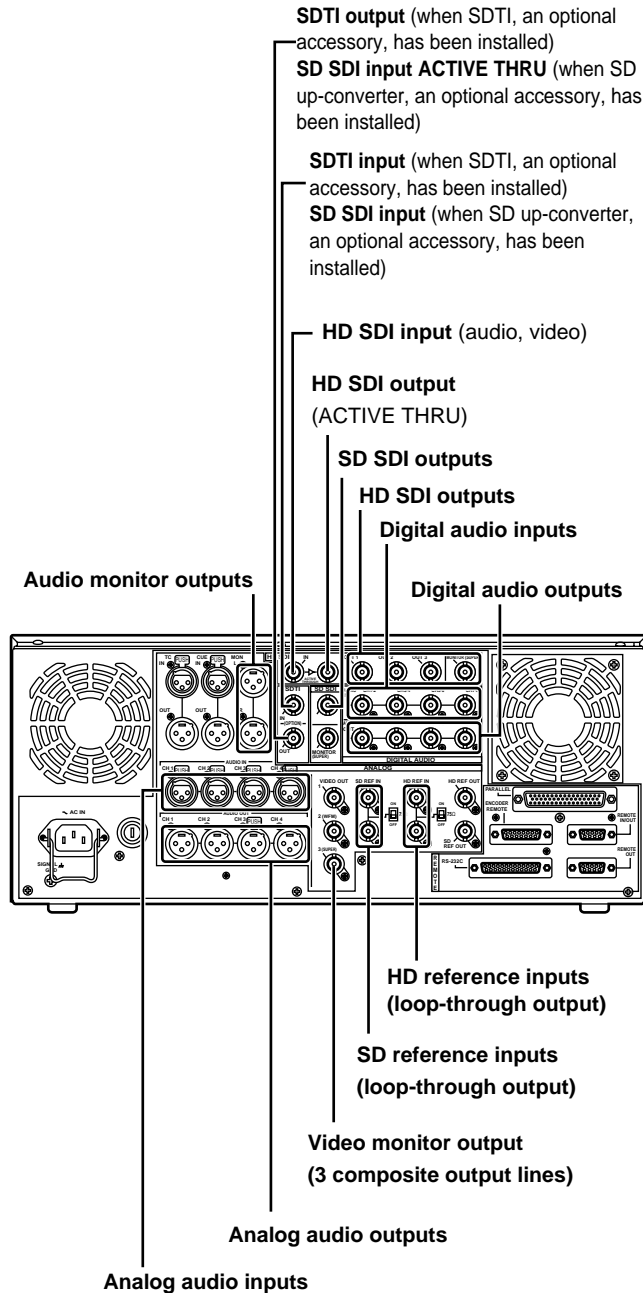

## Example of connections performed for two VTRs (deck-to-deck)

### Source side:

Press the "9P" REMOTE button on the front panel for 2 or more seconds to set the VTR to the REMOTE status. (The 9P LED lights.)

### Recorder side:

Set the REMOTE LED ⑩ on the front panel to the off status (LOCAL mode).

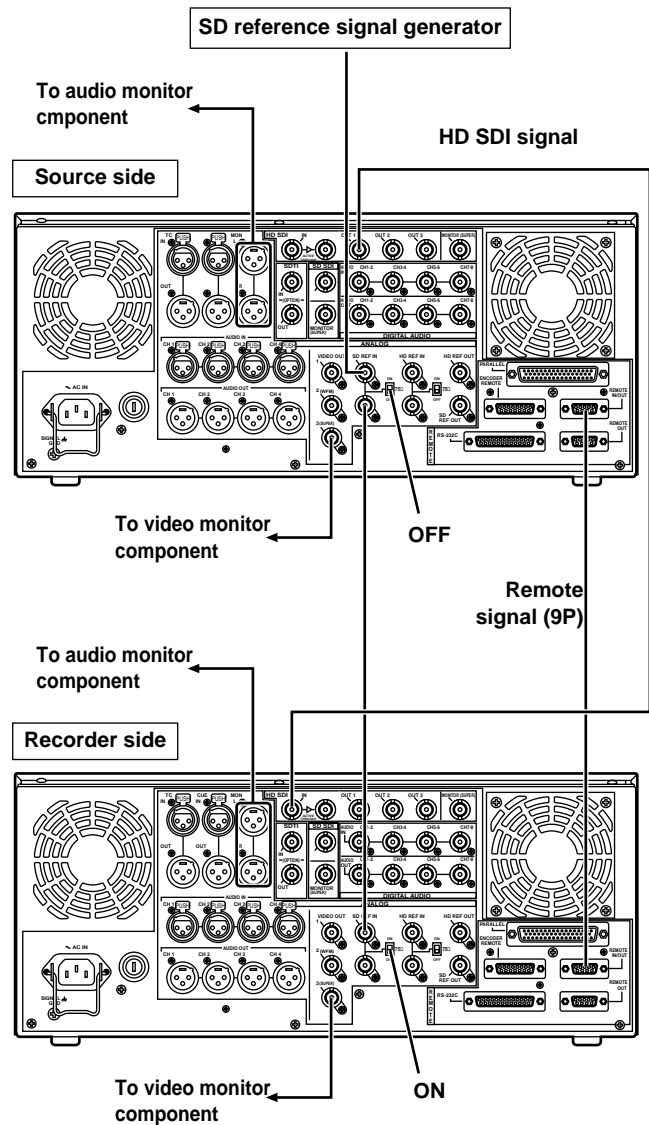

# Connections

## Example of system connections in 23/24 Hz or 25 Hz (HD) mode

When this VTR plays back a tape which was recorded at a frame rate of 24 fps (25 fps) using a variable frame rate camera, the signals on the tape can be output after converting them to 1080/24psf (1080/25psf) to enable direct editing together with the AJ-HD3700 series.

Shown in the figure below is an example of the deck-to-deck connections. Input the 48 Hz (or 50 Hz) reference signal to the HD REF input connector as the REF input.

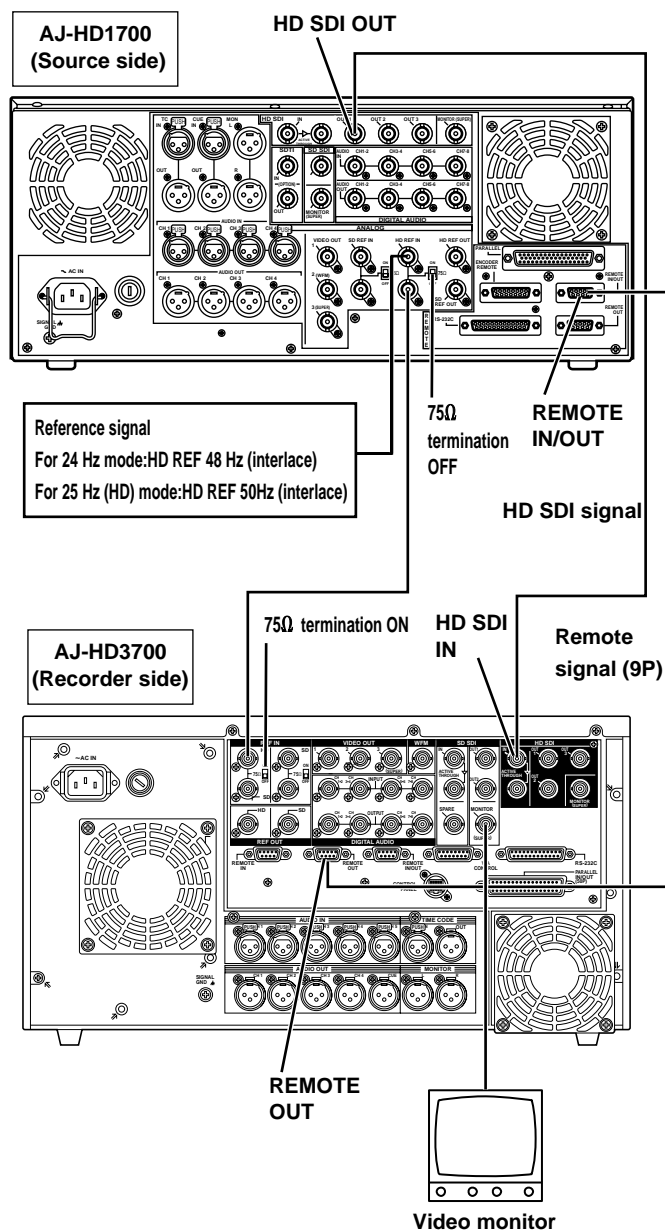

## Example of system connections in 25 Hz (SD) mode

When this VTR plays back a tape which was recorded at a frame rate of 25 fps using a variable frame rate camera, the signals on the tape can be output after converting them to 576/50i to enable direct editing together with the SD VTRs.

Shown in the figure below is an example of the deck-to-deck connections. Input the 50 Hz reference signal to the SD REF input connector as the REF input.

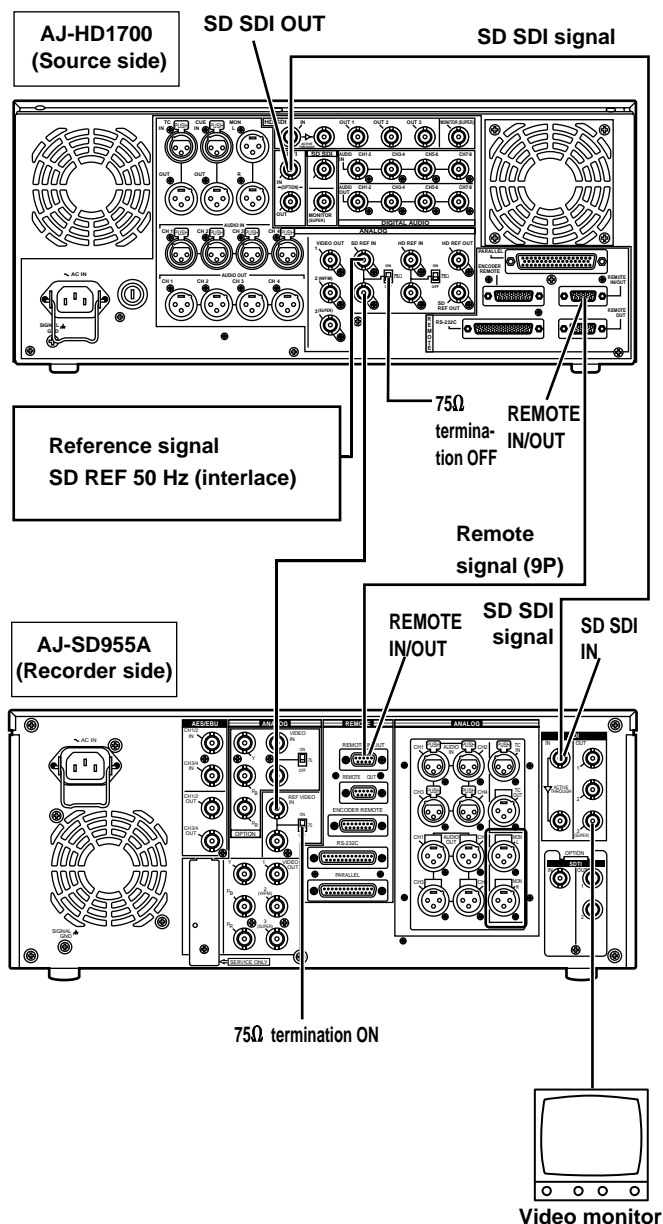

### <Notes>

- When the tape begins to travel at 1× speed, the video may be disturbed and the audio muted for several frames in order to synchronize the REF input with the tape.
- VITC signals are not output to the SD SDI and VIDEO OUT connectors in the 23/24 Hz mode.
- In the 25 (HD) Hz mode, the output video signals of the SD SDI and VIDEO OUT connectors are delayed by approximately 1 field in relation to the HD SDI output.
- HD SDI output is muted in the 25 (SD) Hz mode.

### Note concerning tapes played back by this VTR

- Use tapes which have been shot by a variable frame rate camera.
- Do not use tapes which are copies of shot tapes or edited tapes. Doing so will cause the tape management information to be lost, and normal conversion and playback may not be possible as a result.
- To convert a tape, which was recorded at a frame rate other than 24fps (25fps), to 1080/24psf (1080/25psf), use a frame rate converter (AJ-FRC27) which is available as an optional accessory.



# Concerning tapes

## Consumer-use DV and DVCAM cassettes

### S cassettes

These tapes are exclusively designed for consumer-use DV and DVCAM camera recorders. They can be played using a cassette adapter (optional accessory).

**However, bear in mind that long-duration cassette tapes (80 minutes in the standard mode and 120 minutes in the LP mode) cannot be used.**

It is recommended that tapes bearing the Panasonic brand be used as the consumer-use DV tapes.

- Bear in mind that inserting a cassette tape without the use of a cassette adapter will cause malfunctioning.

### M cassettes

#### DVCPRO HD LP:

Tapes capable of up to 32 minutes of recording and playback

#### DVCPRO 25/50/50P/HD playback tapes

### L cassettes

#### DVCPRO HD LP:

Tapes capable of up to 92 minutes of recording and playback

#### DVCPRO 25/50/50P/HD playback tapes

#### For consumer-use DV or DVCAM applications:

These are playback tapes in the standard consumer-use DV or DVCAM cassettes.

It is recommended that tapes bearing the Panasonic brand be used as the consumer-use DV tapes.

### XL cassettes

#### DVCPRO HD LP:

Tapes capable of up to 126 minutes of recording and playback

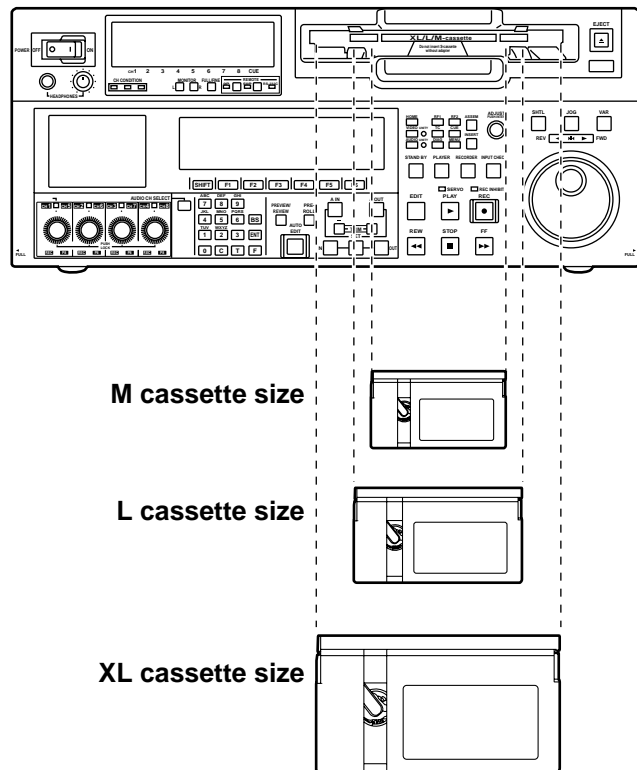

Align the cassette with the center of the insertion slot, and push it in gently.

The cassette tape will be loaded automatically.

#### <Precautions when playing back consumer-use DV and DVCAM tapes>

- It is not possible to play back consumer-use tapes which have been recorded in the LP mode.
- The maximum transport speed of a consumer-use DV or DVCAM cassette tape is 32x.
- The maximum still time for a consumer-use DV or DVCAM cassette tape is 10 seconds.
- From the perspective of protecting consumer-use DV and DVCAM cassette tapes, minimize the number of times the tapes are cued up at the same place as far as possible.
- When consumer-use DV and DVCAM cassette tapes are used, the maximum time for STILL TIMER is set to 10 seconds and the total time elapsing when the VTR is left standing in the STILL mode is set to 1 minute.
- When editing material which has been recorded onto a consumer-use DV or DVCAM cassette tape, first record the material onto a DVCPRO HD tape or another VTR used for broadcasting applications.
- Noise may occur when performing slow playback using consumer-use DV or DVCAM cassette tapes.

## Turning on the power and inserting the cassette

Before starting to operate the VTR, check whether the equipment has been connected properly.

- 1 Turn on the VTR's power.
- 2 Check that the AUTO OFF lamp is off.  
If condensation or some other problem has occurred, the AUTO OFF lamp lights, and no further operations can be performed.
- 3 Insert the cassette tape.  
Without forcing it, insert the cassette tape at the prescribed position.
- 4 Check that the STOP lamp is lighted.  
When the tape is inserted, the cylinder starts rotating automatically, the tape is loaded, and the VTR is set to the STOP mode. The EJECT lamp goes off.

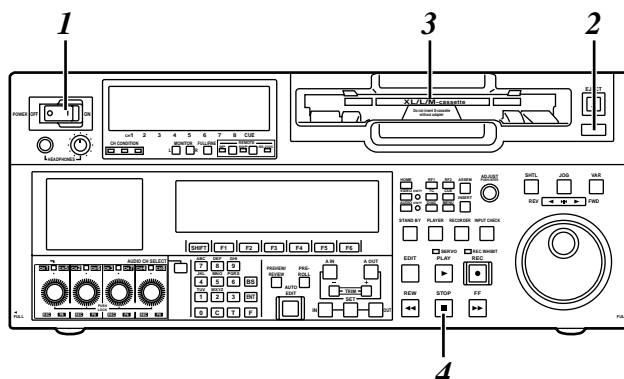

## STOP and STANDBY modes

- 1 The VTR is set to the STOP mode when its STOP button is pressed. The STOP lamp lights, and the tape stops running.
  - In order to protect the tape, the VTR is set to standby OFF after the time set by setup menu item No.400 (STILL TIMER) has elapsed. If the STOP, REW, FF or PLAY button is now pressed, the VTR will be set to the corresponding mode.
- 2 The VTR is set to the STANDBY ON/OFF mode when its STANDBY button is pressed. The standby ON mode is established while the button's lamp is lighted. When the button is pressed in the standby OFF mode, the VTR is set to the standby ON mode.  
When the button is pressed while the VTR is in the STOP mode, it is set to the standby OFF mode and the half-loading status, and the button's lamp goes off.

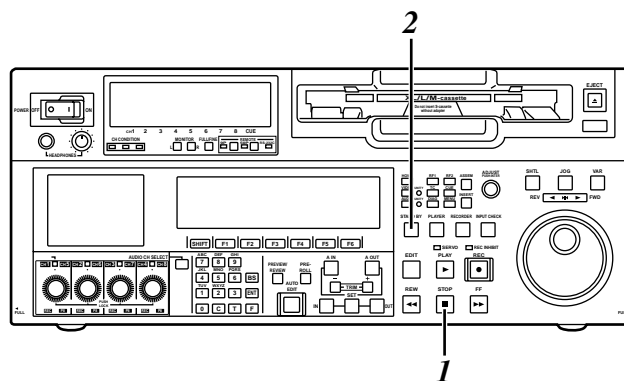

### <Precautions for STILL TIMER setting>

The cumulative total standby time at the same place increases when programs are transmitted or the same material is used repeatedly. In order to protect the tape, keep the standby time at the same place on the tape as short as possible by, for instance, selecting a maximum of 30 seconds or so as the setup menu item No.400 (STILL TIMER) setting.



# Recording

---

- 1** Set the accidental erasure prevention tab on the cassette tape to the “recording” position, and insert the tape.
- 2** Press the STOP button to set the VTR to the stop mode.
- 3** Select “EE” as the OUTPUT setting using **[F1]** on the <HOME> menu. E-E pictures now appear on the TV monitor.
- 4** Check that the REC INHIBIT lamp is off.  
If the lamp is lighted, select “OFF” as the R INH setting using **[F6]** on the <HOME> menu.  
If the inserted cassette has already been recorded on using a format other than DVCPRO HD-LP, the recording inhibited status (factory setting) will be set by setup menu item No.118.
- 5** Select the video and audio input signals, and adjust the audio levels.
- 6** Press the PLAY button while holding down the REC button.  
The REC and PLAY lamps light, and recording starts.
- 7** When the STOP button is pressed, the recording ends, and the VTR is set to the stop mode.

## <Notes>

- During recording, check that the SERVO lamp is lighted. The playback pictures will be disturbed if it is blinking or off.
- If analog signals (ANA1 to ANA4) have been selected as the CH5 to CH8 input signals on the AUDIO menu, their recording levels are tied in with the recording levels which have been set for the CH1 to CH4 signals.
- When SDTI has been selected as the video signals to be recorded, the audio signals which will be recorded are also automatically set to SDTI.

## Selecting the video and audio input signals

- ① Connect the signals to be recorded.
- ② Select the input signals using **[F1]** on the <VIDEO> menu and **[F1]** to **[F6]** on the <AUDIO> menu or <AUDIO SHIFT1> menu.

## Adjust the audio levels

- ① Adjust the audio input levels of the CH1, CH2, CH3, CH4, CH5, CH6, CH7, CH8 audio signals and analog cue signal selected on the AUDIO menu.  
When the audio UNITY lamp on the front panel is lighted, the audio signals will be recorded at the appropriate levels.
- ② Before adjusting the recording level, check that the REC LED is lighted and that the audio adjustment dial is in the unlocked status (LOCK LED off).  
If the dial is in the LOCK status (LOCK LED lighted), press it. The LOCK LED goes off, and the lock is released.  
In addition, the analog cue audio recording level is adjusted using setup menu item No.790 (CUE REC VOL) so that it will not exceed –20 dB.

# Playback

---

- 1** Insert the cassette tape, and set the VTR to the STOP mode.
- 2** Press the PLAY button.  
Normal playback commences.
- 3** Adjust the audio playback levels.  
Before adjusting the playback levels, check that the PB LED is lighted and that the audio adjustment dial is in the unlocked status. If the dial is locked (indicated by the lighted LOCK LED), press it. The LOCK LED goes off, and the lock is released. The analog cue audio level is adjusted using setup menu item No.791 (CUE PB VOL). Normally, the VTR is kept in the UNITY status (the segment display of the control lights at the center).
- 4** To end the playback, press the STOP button. The VTR is now set to the STOP mode.

## <Note>

During playback, check that the SERVO lamp is lighted. The playback pictures will be disturbed if the lamp is off or blinking.

## Playback phase adjustment function

If two VTRs are to be used to play the same program, the playback phase between the VTRs can be adjusted by changing the playback speed of one of the VTRs.

- 1** Press the TRIM button (“+” or “-” button) while holding down the PLAY button. Each time it is pressed, the playback speed is accelerated or decelerated in increments of the number of playback framing fields selected by the setup menu item No.109 (CAP.LOCK) setting.  
The SERVO lamp remains off while the tape is being played at the accelerated or decelerated speed.
- 2** Upon completion of the playback phase adjustment, release the PLAY button.  
The VTRs now return to the standard playback speed, and the SERVO lamp lights.

# Jog/Shuttle

---

## Jog mode

- 1** Press the JOG button.
- 2** Turn the search dial.  
The dial's click-stops are released, and the tape is played back at the speed corresponding to the speed at which the dial is turned.  
The maximum jog speed can be changed by selecting the setup menu item No.310 (JOG FWD MAX) and No.311 (JOG REV MAX) settings.  
When the dial is no longer turned, a still picture will appear.
- 3** To transfer the VTR from the jog mode to another mode, press the button that corresponds to the mode concerned.

## Shuttle mode

- 1** Press the SHTL button.
- 2** Turn the search dial.  
The playback picture speed changes from 0 up to  $\pm 32\times$  depending on the dial position.  
This speed can be switched to  $\pm 9.8\times$ ,  $\pm 16\times$  or  $\pm 32\times$  using setup menu item No.101 (SHTL MAX).  
The dial has a click-stop at the center position where a still picture will appear.
- 3** To transfer the VTR from the shuttle mode to another mode, press the STOP button or the button of the mode concerned.

## Variable mode

- 1** Press the VAR button.
- 2** Turn the search dial.  
The playback picture speed changes from  $-4.9\times$  to  $+4.9\times$  depending on the dial position.  
The maximum shuttle speed can be changed by selecting the setup menu item No.308 (VAR FWD MAX) and No.309 (VAR REV MAX) settings.  
Noise will be generated at all speeds other than  $-1\times$  to  $+2\times$ . (For all tapes other than DVCPRO HD-LP recorded ones, the noise-free speed range is  $-1.0\times$  to  $+1.1\times$ .)
- 3** To transfer the VTR from the variable mode to another mode, press the STOP button or the button of the mode concerned.

### <Note>

At the factory setting, the VTR is set to be transferred to the shuttle mode, jog mode or variable mode when the search dial is turned.

In cases where it is not convenient for the VTR to be transferred directly to the variable speed mode, it can be transferred via the search button. Select "KEY" as the setup menu item No.100 (SEARCH ENA) setting.

# Manual Editing

---

- 1** Select the editing mode.  
**ASSEM button:**  
Assemble (frame-to-frame continuity) editing is performed using this button.  
**INSERT button:**  
Insert editing is performed using this button.
- 2** On the time code display, select the channels to be edited.  
**ASSEM:**  
Set ASSEM to ON using the **[F1]** button.  
**INSERT:**  
To select V, A1, A2, A3, A4 and CUE channels, press the **[F1]** to **[F6]** buttons; to select A5, A6, A7, A8 and TC channels, press the **[SHIFT] + [F2]** to **[SHIFT] + [F6]** buttons. The highlighted channels will now be edited.
- 3** Press the PLAY button.
- 4** While monitoring the TV monitor, search the position where the editing is to be started (IN point), and press the PLAY and EDIT buttons together at this position.
- 5** Similarly, while monitoring the TV monitor, search the position where the editing is to be terminated (OUT point), and press the PLAY or STOP button at this position. The VTR is set to the PLAY or STOP mode, and the editing is terminated.

## Preroll

---

- 1** Press the PREROLL button.  
The VTR now performs the preroll operation.  
  
**When the cue time has been registered on the HOME, PF1 or PF2 screen:**  
The tape is prerolled from the registered cue time using the preroll time which was set using **[F1]** (PREROL) on the <HOME SHIFT> menu.  
  
**When the search mode is established on the CUE screen:**  
The tape is prerolled from the selected cue point using the preroll time which was set using **[F5]** (CU-ROL) on the <CUE SHIFT> menu.  
The preroll operation is not performed when the selected cue point has not been registered or when the cue point registration mode is established.  
  
**In all other situations:**  
The tape is prerolled from the registered IN point (or the current tape position when the IN point has not been registered) using the preroll time which was set using **[F1]** (PREROL) on the <HOME SHIFT> menu.  
If the PREROLL button is pressed when the IN point has not been registered, the current tape position is automatically registered as the IN point (but only when ENA has been selected as the setup menu item No.305 (AUTO ENTRY) setting).
- <Note>**  
The time code or CTL signal must be continuously recorded between the edit IN point and preroll point.

# Automatic Editing (deck-to-deck)

“Editing” refers to the work involved in using pre-recorded tapes to bring different contents together or delete unnecessary parts and bring together only the necessary parts.

The basic editing steps are as follows.

- 1 Using the REMOTE button, set the player to REMOTE and the recorder to LOCAL (ensure that the REMOTE LED is not lighted).
- 2 Select the editing mode (ASSEM or INSERT).
- 3 Register the edit points of the recorder and player.
- 4 Check and modify, if necessary, the edit points.
- 5 Preview the material before editing it.
- 6 Proceed with the editing.
- 7 Review the edited results.

## Switch settings and adjustments

### When using this VTR as the recorder

Set the VTR to the LOCAL status (which is indicated when the REMOTE LED is OFF).

Set the POWER switch to ON.

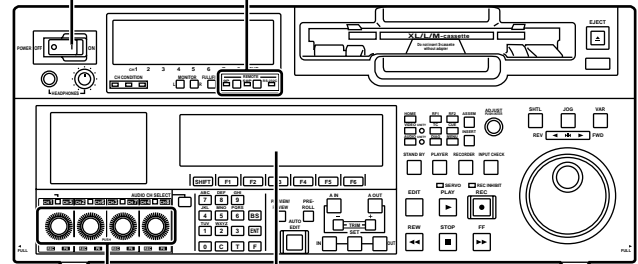

Adjust the recording levels.

Switch the time counter display to TC or CTL.

### When using this VTR as the player

Press the 9P button for 2 or more seconds to set the VTR to the REMOTE status which is indicated when the REMOTE LED is ON).

Set the POWER switch to ON.

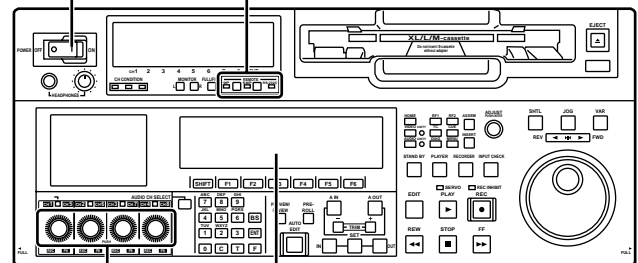

Adjust the playback levels.

Switch the time counter display to TC or CTL.

# Automatic Editing (deck-to-deck)

## Selecting the editing mode

- 1 Select the editing mode.  
**ASSEM button:**  
 Assemble (frame-to-frame continuity) editing is performed in this mode.  
**INSERT button:**  
 Insert editing is performed in this mode.
- 2 On the time code display, select the channels to be edited.  
**ASSEM:**  
 Set ASSEM to ON using the **[F1]** button.  
**INSERT:**  
 To select V, A1, A2, A3, A4 and CUE channels, press the **[F1]** to **[F6]** buttons; to select A5, A6, A7, A8 and TC channels, press the **[SHIFT]** + **[F2]** to **[SHIFT]** + **[F6]** buttons. The highlighted channels will now be edited.
- 3 Press the **PLAYER** or **RECORDER** button to select the VTR which is to be operated.  
 [Setting for editing using two VTRs]  
**PLAYER:**  
 Press this button if the player VTR is to be operated to register the edit points.  
**RECORDER:**  
 Press this button if the recorder VTR (this VTR) is to be operated to register the edit points.

### [ASSEM screen]

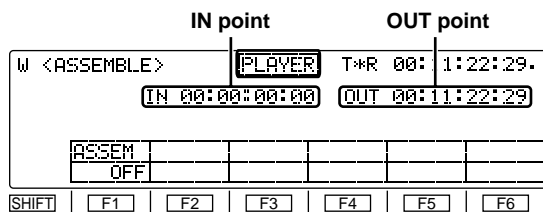

### [INSERT screen]

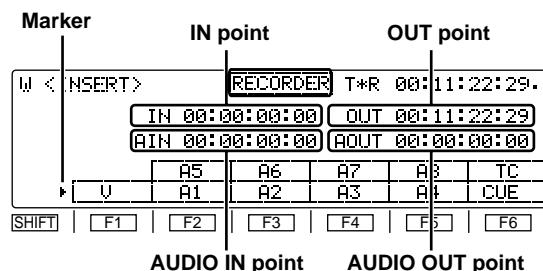

## Registering the edit points

- 1 Locate the edit IN point by performing the jog or shuttle operation. Set the tape to the still picture status at the desired position.  
 For a detailed description of the jog and shuttle operations, refer to page 27.
- 2 Press the IN button and SET button together.  
 The edit IN point is now registered.  
 The edit IN point value appears on the display.
- 3 Locate the edit OUT point by performing the jog or shuttle operation. Set the tape to the still picture status at the desired position.
- 4 Press the OUT button and SET button together.  
 The edit OUT point is now registered.  
 The edit OUT point value appears on the display.
- 5 The edit points can be registered directly using the number keys.
  1. Select the <ASSEMBLE> or <INSERT> menu.
  2. Press the **[T]** button to highlight the edit point. Turn the ADJUST dial to move the highlighting to the IN point or OUT point.
  3. Press the **[T]** button again, and input the desired edit point directly using the number keys. Turn the ADJUST dial to move from one digit to the next.
  4. Press the **[ENT]** button to register the point.  
 To abort the registration at any time, press the **[C]** button.  
 To reset a particular edit point (to 00:00:00:00), press the **[T]** button, align the highlighting with the edit point concerned, and press the **[T]** button again.  
 Next, press the **[F]** button and **[0]** button together.  
 Finally, press the **[ENT]** button to register the point.

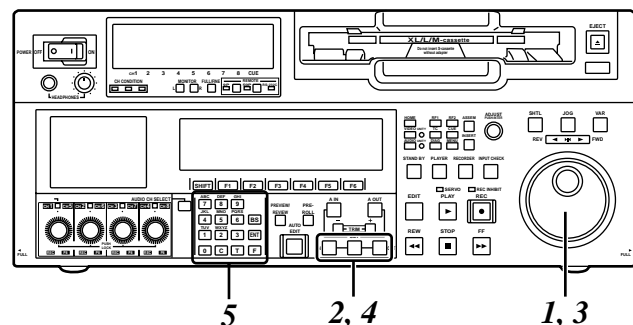

### Match frame processing function

When two VTRs are used to perform the editing operations, there will be a total of 4 edit points: the IN and OUT points for the player and the IN and OUT points for the recorder. However, the last point is automatically calculated so only three of the edit points need to be registered.

### Negative duration function

Use setup menu items No.300 (IN/OUT DEL) and No.301 (NEGA FLASH) in combination.

# Automatic Editing (deck-to-deck)

## Checking the edit points

**1** Press the IN (or OUT) button to check the edit point.  
The value of the registered edit point appears on the display.

**2** While holding down the IN (or OUT) button, press the PREROLL button to check the picture at the edit point.

The tape is cued up to the edit IN (or OUT) point, and a still picture of the point appears.

- If “STOP” has been selected as the setup menu item No.307 (AFTER CUE-UP) setting, the VTR is set to the E-E mode provided that EE has been selected as the <HOME> menu [F1] (OUTPUT) setting.

**3** By holding down the IN and OUT buttons at the same time, check the editing duration. The duration appears on the display.

### How the duration is calculated

- **When two edit points have been set**  
The duration between the two points is calculated.
- **When only one edit point has been set**  
The duration between the data which has been set and the current address is calculated.
- **When no edit points have been set**  
The duration of the previously edited section is calculated.

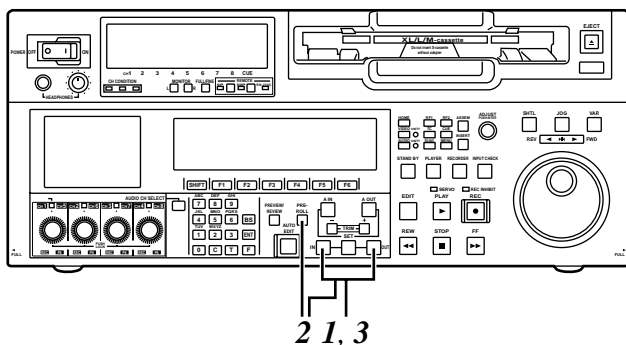

## Modifying edit points

### 1 Re-registering an edit point

Locate the new edit point by performing the jog or shuttle operation, and press the IN (or OUT) button and SET button at the same time to re-register the edit point.

### 2 Modifying an edit point in 1-frame increments (trimming function)

Press the TRIM button while holding down the IN (or OUT) button.

Each time the + button is pressed, the point is moved ahead by one frame.

Conversely, each time the – button is pressed, the point is moved back by one frame.

### 3 Resetting edit points

#### ① Resetting both an edit IN point and OUT point

Press [F4] (TC CLR = RESET) on the <HOME> menu.

(This takes effect only in the CTL mode.)

#### ② Resetting either an edit IN point or OUT point

Press the [C] button among the number keys while holding down the IN (or OUT) button.

### <Notes>

- An edit OUT point can be reset even while editing is in progress.
- In the eject mode, the IN and OUT points are automatically reset.

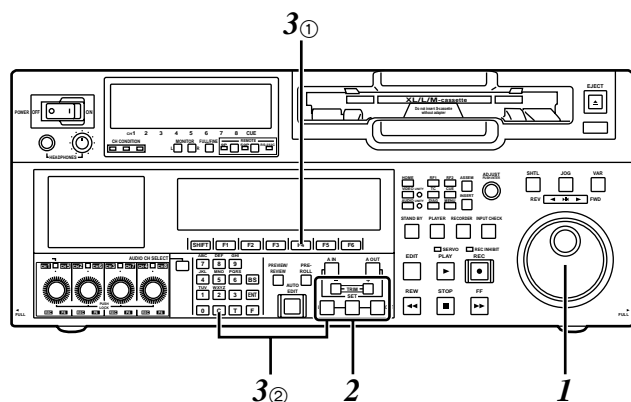

# Automatic Editing (deck-to-deck)

## Previewing

**I** After the edit points have been registered, press the PREVIEW button. Regular preview is now conducted.

### <Notes>

- If the edit IN point has not been registered, the position where the PREVIEW button was pressed is registered as the edit IN point.
- To stop the preview at any time, press the STOP button.
- When the PREVIEW button is pressed again after the IN point during the course of a preview, the preview will start again from the beginning.
- When the edit OUT point is reached, the tape is postrolled, after which it stops automatically.

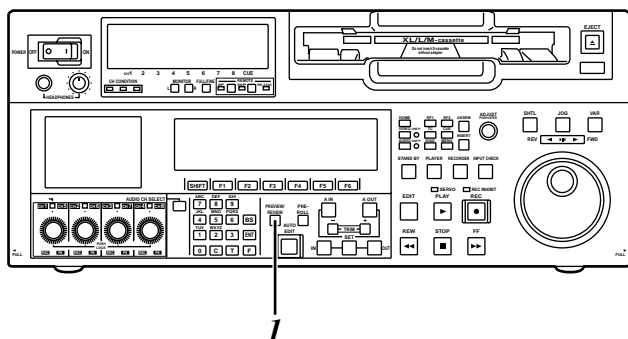

## Automatic editing

**I** Press the AUTO EDIT button. Automatic editing is now executed.

- To suspend editing at any time, press the STOP button.
- When the edit OUT point is reached, the tape is postrolled, after which it stops.

### Postrolling

In the case of assemble editing, editing continues for about 2 seconds after the edit OUT point is passed, and the tape is then returned to the OUT point, after which it stops.

In the case of insert editing, the PLAY mode is established after the edit OUT point has been passed, and the tape is then returned to the OUT point, after which it stops.

### Retry function

Even when the STOP button has been pressed to suspend editing, editing can be repeated from the beginning simply by pressing the AUTO EDIT button again.

### Auto tag function

If, upon completion of editing, when the AUTO EDIT button is pressed although the next edit point has not yet been registered, the previous edit OUT point is registered as the IN point, and editing is executed.

To release the auto tag mode, press one of the transport system buttons (such as the PLAY button).

### <Note>

The registered points are automatically cleared after editing has been executed. However, the previous edit points can be recalled by pressing the TRIM+ (or TRIM-) button and SET button at the same time.

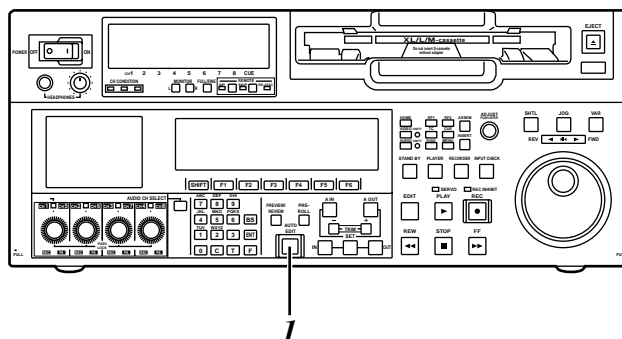



# Automatic Editing (deck-to-deck)

## Reviewing

**1** Upon completion of the editing, press the REVIEW button.

Review is now started by the recorder.

- To stop the review at any time, press the STOP button.
- When the edit OUT point is reached, the tape is postrolled, after which it stops.

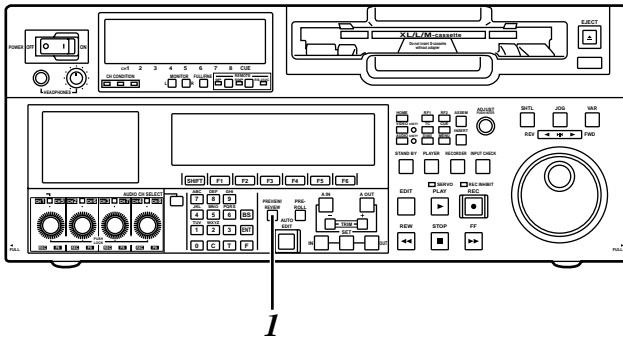

# Audio Split Editing

The video edit points and audio edit points can be registered independently, and editing can be executed with the video points offset from the audio points. Audio edit points cannot be registered when the assemble editing mode has been selected. After registering the edit points, proceed with the same operations as for insert editing.

## ■ Registering the edit points

### Video IN point:

While holding down the IN button, press the SET button.

### Video OUT point:

While holding down the OUT button, press the SET button.

### Audio IN point:

While holding down the A-IN button, press the SET button.

### Audio OUT point:

While holding down the A-OUT button, press the SET button.

### <Note>

If the editing mode is changed to assemble editing after the audio edit points have been registered, the audio edit points will be cleared.

## ■ Clearing the edit points

### Video IN point:

While holding down the IN button, press the **C** button among the number keys.

### Video OUT point:

While holding down the OUT button, press the **C** button among the number keys.

### Audio IN point:

While holding down the A-IN button, press the **C** button among the number keys.

### Audio OUT point:

While holding down the A-OUT button, press the **C** button among the number keys.

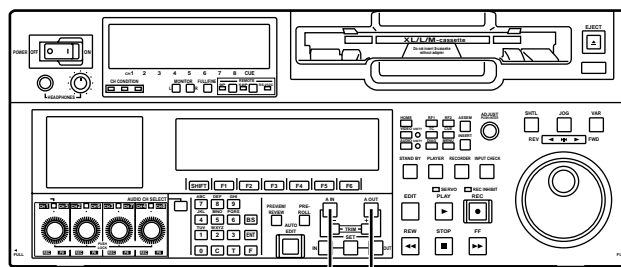

A-IN button A-OUT button

## ■ Modifying the edit points

### Video IN point:

While holding down the IN button, press the TRIM+ button or TRIM- button.

### Video OUT point:

While holding down the OUT button, press the TRIM+ button or TRIM- button.

### Audio IN point:

While holding down the A-IN button, press the TRIM+ button or TRIM- button.

### Audio OUT point:

While holding down the A-OUT button, press the TRIM+ button or TRIM- button.

## ■ Cueing the tape up to the edit points

### Cue-up to video IN point:

While holding down the IN button, press the PREROLL button.

### Cue-up to video OUT point:

While holding down the OUT button, press the PREROLL button.

### Cue-up to audio IN point:

While holding down the A-IN button, press the PREROLL button.

### Cue-up to audio OUT point:

While holding down the A-OUT button, press the PREROLL button.

# Audio Split Editing

---

## ■ Duration display

The duration can be indicated on the display.

### **Between the video IN and OUT points:**

Press the IN button and OUT button at the same time.

### **Between the audio IN and OUT points:**

Press the A-IN button and A-OUT button at the same time.

## **Match frame processing function**

When two VTRs are used to perform the audio split editing operations, there will be a total of 8 edit points: the video IN and OUT points for the player, the video IN and OUT points for the recorder, the audio IN and OUT points for the player, and the audio IN and OUT points for the recorder.

When five of the eight edit points are registered, the remaining three points are automatically calculated so only five of the edit points can be registered.

## ■ When a VTR not equipped with the split editing function is used as the player

When a VTR for which the video and audio edit points cannot be set independently is used as the player, split editing is still possible by setting the audio IN point and OUT point in the recorder and setting the data of three points as the video edit points.

### **<Note>**

If, during audio split editing, the video OUT point (or audio OUT point) only is registered without the audio OUT (or video OUT point) having been registered and automatic editing is then executed, editing will continue until either the audio OUT point (or video OUT point) is registered or the STOP button is pressed to suspend the editing operation.

# Variable memory function

## Variable memory function selection

The variable memory mode can be selected by setting **[F6]** (VARMEM) on the <HOME SHIFT> menu to "ON."

When **[F6]** (VARMEM) is set to "OFF," the variable memory mode is canceled, and the regular mode is established.

### <Note>

Bear in mind that when the 23/24 Hz or 25 Hz (HD or SD) mode has been selected as the system menu item No.25 (SYSTEM FREQ) setting, **[F6]** (VARMEM) will no longer appear on the display and the variable memory mode cannot be selected.

## Outline

This VTR is provided with two variable memory functions, as follows. These functions can be used in the variable memory mode.

### Variable memory playback:

Any section of the tape can be played back at variable speeds in the VAR mode, the changes in the speed can be stored in the memory, and the tape can be played back at the memorized speed.

### Variable memory editing:

Using the VTR as a controller (recorder in the deck-to-deck mode) to control the playback speed of the player, editing can be performed in the variable speed mode.

## Variable memory playback operation procedure

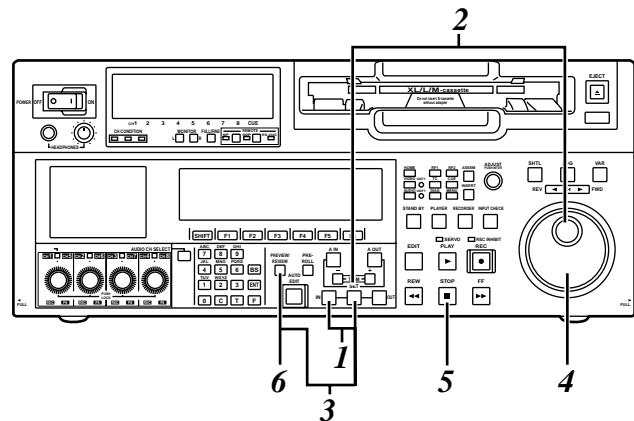

To perform variable memory playback operations, set the VTR to the variable memory mode, and take the steps below.

- 1 Register the IN point using the SET button and IN button. There is no need to set the OUT point for variable memory playback.
- 2 Set the initial speed ( $-1.0\times$  to  $+2.0\times$ ) using the search dial while holding down the SET button.
- 3 When the SET button and PREVIEW/REVIEW button are pressed at the same time, the tape is automatically prerolled and played back at the initial speed setting up to the IN point.
- 4 After the tape has passed the IN point, turn the search dial to store the playback speed in the memory.
- 5 Press the STOP button to stop the tape.
- 6 When the PREVIEW/REVIEW button is pressed, variable memory playback is performed at the memorized speed.

### <Notes>

- After passing the IN point, the tape is played back in accordance with the settings in the memory, and it continues to run at the last speed stored in the memory until the STOP button is pressed.
- Whatever is stored in the memory will be cleared when the VTR exits the variable memory mode. It is also cleared when the POWER switch is set to "OFF."

# Variable memory function

## Variable memory editing operation procedure

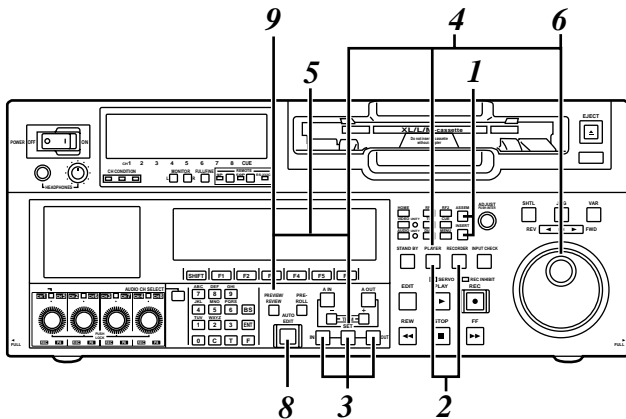

To perform variable memory editing operations, set this VTR, which is connected as the recorder to the variable memory mode, and take the steps below.

- 1** Select the editing mode on the <ASSEMBLE> or <INSERT> menu.
- 2** Select the VTR to be operated by pressing the RECORDER or PLAYER button.
- 3** Register the IN and OUT points using the SET button and IN and OUT buttons. The player's OUT point cannot be registered.
- 4** Press the PLAYER button to select the player VTR, and then set the initial speed using the search dial while holding down the SET button.
- 5** When the SET button and PREVIEW/REVIEW button are pressed at the same time, the tapes in both the player and recorder are automatically prerolled, and the player VTR plays back the tape at the initial speed setting up to the IN point.
- 6** After the tape has passed the IN point, turn the search dial to store the playback speed of the player VTR in the memory.
- 7** When the tape passes the OUT point that was set by the recorder, the storing of the playback speed in the memory ends.

**8** When the AUTO EDIT button is pressed, variable memory editing is executed. Once editing has been executed, the memorized speeds will be cleared except for the initial speed which is not cleared.

**9** By pressing the PREVIEW/REVIEW button, the edited results can be checked.

### <Notes>

- Whatever is stored in the memory will be cleared when the VTR exits the variable memory mode. It is also cleared when the POWER switch is set to "OFF."
- Phase synchronization is not performed during playback up to the IN point of the variable memory editing. Therefore, depending on the VTR used as the player and its speed setting, no guarantees are made for the accuracy of the IN point.
- When conducting variable memory editing in the speed range of  $-1.0\times$  to  $+2.0\times$ , use VTRs with which these speeds are guaranteed for both the recorder and player.

# Function menus

---

The function menus are used to set the functions which are frequently used. The function menus are selected directly using the direct menu buttons on the front panel.

## General description

### General menus

#### <HOME>, <HOME SHIFT>

The most basic settings for recording, playback and TC operations are set on these menu screens.

#### <VIDEO>, <VIDEO SHIFT>

The basic input/output settings for the video signals are performed and, moreover, the level of the HD output signals can also be adjusted on these menu screens.

#### <AUDIO>, <AUDIO SHIFT1>, <AUDIO SHIFT2>

The basic input/output settings for the audio signals are performed on these menu screens.

#### <TC>, <TC SHIFT>

The TC-related settings are performed on these menu screens.

The settings for superimposing time codes on the display can also be performed on these menu screens.

#### <PF1 FT>, <PF1 BK>, <PF2 FT>, <PF2 BK>

Up to 24 frequently used menu items which have been registered can be used on these menu screens.

#### <CUE>, <CUE SHIFT>

A maximum of 60 cue points can be set on these menu screens. In the PAGE mode, 10 pages with 6 cue points on each page are provided so that the cue points can be managed on a page-by-page basis.

#### <DIAG>, <DIAG SHIFT>

The warnings and hour-meter can be checked on these menu screens. On the SHIFT menu screen, error log files can be checked, deleted or saved onto or loaded from IC cards.

#### <MENU>, <MENU SHIFT>

These enable movement to the screens for operations (adjustments, saving data onto or loading it from the internal memory or IC cards) relating to the SYSTEM and SETUP menus.

#### <ASSEMBLE>

The ASSEMBLE editing mode is selected on this menu screen.

#### <INSERT>

The INSERT editing mode and editing channels are selected on this menu screen.

### Special menus

#### <<SYSTEM MENU>>

The SYSTEM menu is displayed on-screen, enabling various adjustments to be made.

#### <<SETUP MENU>>

The SETUP menu is displayed on-screen, enabling various adjustments to be made.

#### <<FILE>>

The current setting information, including the SETUP menu contents, can be provided with titles and either saved in or loaded from the backup memory in one of 4 variations.

#### <<PF1 FT ASSIGN>>, <<PF1 BK ASSIGN>>

#### <<PF2 FT ASSIGN>>, <<PF2 BK ASSIGN>>

The SETUP menu items which can be registered are displayed on-screen, and they can be registered into or deleted from the function buttons.

#### <<IC CARD MENU>>

The current setting information, including the SETUP menu contents, can be provided with titles and saved onto or loaded from the IC card memory in one of 8 variations.

#### <<IC CARD/ERR LOG>>

The contents of the error logs can be provided with titles and saved onto or loaded from the IC card memory in one of 8 variations.

#### <<IC CARD/MULTI CUE>>

The MULTI CUE menu items can be provided with titles and saved onto or loaded from the IC card memory in one of 8 variations.

#### <<50P IN ASSIGN>>, <<50P OUT ASSIGN>>

Using the front panel controls and on-screen menus, the functions are registered into the input pins of the parallel remote (50PIN) connector and the statuses are registered into its output pins.

# Function menus

## Allocating the function keys

Menu (6 types)	Menu hierarchy	Items allocated to function keys					
		F1	F2	F3	F4	F5	F6
<b>HOME</b>	1st	OUTPUT		TC/CTL	TC CLR		R INH
	2nd (SHIFT)	PREROL		OUTREF	CAPSTN		VARMEM
<b>VIDEO</b>	1st	VID IN	INT SG	WFM		UP CON	DW CON
	2nd (SHIFT)			V LV	C LV	HUE	SUP LV
	3rd (F+SHIFT)	BR	CT	R-BR	B-BR	R-CT	B-CT
<b>AUDIO</b>	1st	A1 IN	A2 IN	DIN 12	A3 IN	A4 IN	DIN 34
	2nd (SHIFT)	A5 IN	A6 IN	DIN 56	A7 IN	A8 IN	DIN 78
	3rd (SHIFT)	VOLUME		RECCUE			M MIX
<b>TC</b>	1st	TC SRC		TCG MD	TCG RG	RUN MD	DF MOD
	2nd (SHIFT)	SUPER	C HPOS	C VPOS	DISPLY	C TYPE	TIMER
<b>PF1</b>	1st	No factory settings (any items can be allocated to any keys).					
	2nd (SHIFT)						
<b>PF2</b>	1st						
	2nd (SHIFT)						
<b>CUE MULTICUE function</b>	1st	PREV	NEXT	MODE	CLR	AL CLR	
	2nd (SHIFT)		CARD	PAGE	ROTATE	CU-ROL	
<b>DIAG ERROR LOG function</b>	1st	WARN	HOURS				
	2nd (SHIFT)	STEP	CARD			AL CLR	
<b>MENU</b>	1st	FILE	CARD		SYSTEM	SETUP	
	2nd (SHIFT)	PF1 FT	PF1 BK	PF2 FT	PF2 BK	50P IN	50P OT
<b>ASSEM</b>		ASSEM					
<b>INSERT</b>			A5	A6	A7	A8	TC
		V	A1	A2	A3	A4	CUE
<b>SYSTEM SYSTEM MENU (ON SCREEN)</b>				CANCEL	RESET	SET	EXIT
<b>SETUP SETUP MENU (ON SCREEN)</b>		↑ PREV	↓ NEXT	CANCEL	RESET	SET	EXIT
<b>FILE USER FILE BACKUP function</b>		P.LOAD	LOAD ←	SAVE →		LOCK	EXIT
<b>PF1, PF2 MENU ASSIGN function</b>		↑ PREV	↓ NEXT	CANCEL	RESET	SET	EXIT
<b>CARD IC CARD function (MENU) IC CARD function (ERRLOG) IC CARD function (MULTI CUE)</b>		FORMAT	SAVE ←	LOAD →	DELETE	LOCK	EXIT
<b>50PIN 50-pin ASSIGN function</b>		↑ PREV	↓ NEXT	CANCEL	RESET	SET	EXIT

### Warning mark

When a warning occurs in this VTR, the warning mark (W) blinks. If the DIAG button is then pressed, the corresponding warning message is displayed on the screen. ( See DIAG screen.)

# Function menus

---

## How to switch the settings

### **Toggle:**

Each time a function button is pressed, the setting is changed or entered.

### **F + toggle\*:**

When a function button is pressed while the F button is held down, the setting can be changed or entered each time.

### **Toggle + ADJ:**

When a function button is pressed, the setting is highlighted, and the status in which the setting can be changed is established.

The ADJUST dial is used to change the setting.

When the same function button is pressed again and the highlighting is released, the setting is entered.

### **Press:**

When a function button is pressed, the setting can be changed while the button is held down or at the instant when it is pressed. When the function button is released, the original setting is restored.

### **F + press\*:**

When a function button is pressed while the F button is held down, the setting can be changed while the button is held down or at the instant when it is pressed. When the function button is released, the original setting is restored.

\* When only the function button is pressed, message display "Press **F** + **F5**" etc. blinks.



# Function menus

## <HOME>

The most basic settings for recording, playback and TC operations are set on this menu screen.

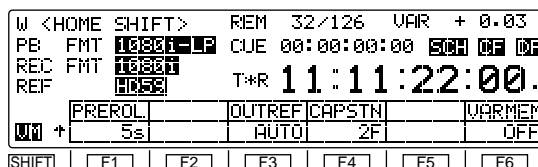
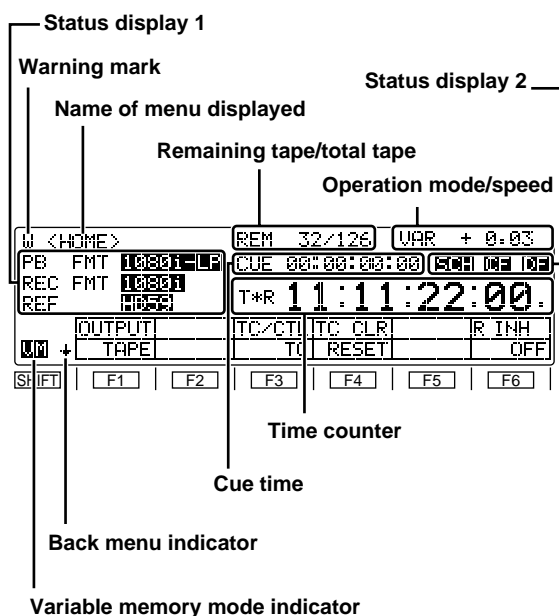

### System frequency display during 24 Hz, 25 Hz (HD and SD) modes

When 24 Hz mode or 25 Hz (HD or SD) mode has been selected for the system menu item No. 25 (SYSTEM FREQ), the selected system frequency contents are displayed for the F1 function button, making it possible to check the currently selected system frequency mode.

SYSTEM 23/24	<b>23/24</b>	The 23/24 Hz mode is selected.
F1	<b>25 (HD)</b>	The 25 (HD) Hz mode is selected.
	<b>25 (SD)</b>	The 25 (SD) Hz mode is selected.

## Status display 1

VTR	Description of settings		
PB FMT	Playback format This displays the format used for playback.	1080i LP	These settings indicate the DVCPRO HD-LP recording and playback mode.
		720p LP	
		1080i SP	These settings indicate the DVCPRO HD-SP playback mode.
		720p SP	
		422	These settings indicate the DVCPRO (50 Mbps format) playback mode.
		420p	
		411	
REC FMT*1	Recording format This displays the format used for recording.	DV	These settings indicate the DVCPRO (25 Mbps format), DV and DVCAM playback modes.
		DVCAM	
		1080i	The tape is recorded using the 1080i format.
TM INFO*2	Tape management information This displays the frame rate (shooting speed) information which is recorded on a tape shot by a variable frame rate camera.	720p	The tape is recorded using the 720p format.
		---	A cassette tape has not been inserted.
		24P	These settings indicate the recorded frame rate.
		24PA	
		25P	The tape management information is invalid. <b>&lt;Note&gt;</b> In some cases, the tape management information may be erroneously overwritten by insert editing or tape dubbing, and it may not be possible to perform editing properly.
INVALID			

\*1: This status is not displayed when the 23/24 Hz or 25 Hz (HD or SD) mode has been selected as the system menu item No.25 (SYSTEM FREQ) setting.

\*2: This status is not displayed when the 59/60 Hz or 50 Hz mode has been selected as the system menu item No.25 (SYSTEM FREQ) setting.

# Function menus

## Status display 1 (continued)

VTR	Description of settings		
REF	Output reference This displays the output reference status.	<b>HD23</b>	The HD REF input signal has been selected as the reference. The frame frequency is 23.98 Hz.
		<b>HD24</b>	The HD REF input signal has been selected as the reference. The frame frequency is 24 Hz.
		<b>HD25</b>	The HD REF input signal has been selected as the reference. The frame frequency is 25 Hz.
		<b>HD50</b>	The HD REF input signal has been selected as the reference. The field frequency is 50 Hz.
		<b>HD59</b>	The HD REF input signal has been selected as the reference. The field frequency is 59.94 Hz.
		<b>HD60</b>	The HD REF input signal has been selected as the reference. The field frequency is 60 Hz.
		<b>IN50</b>	The HD serial input signal has been selected as the reference. The field frequency is 50 Hz.
		<b>IN59</b>	The HD serial input signal has been selected as the reference. The field frequency is 59.94 Hz.
		<b>IN60</b>	The HD serial input signal has been selected as the reference. The field frequency is 60 Hz.
		<b>INT23</b>	The signal (23.98 Hz) from the internal generator has been selected as the reference.
		<b>INT24</b>	The signal (24 Hz) from the internal generator has been selected as the reference.
		<b>INT25</b>	The signal (25 Hz) from the internal generator has been selected as the reference.
		<b>INT50</b>	The signal (50 Hz) from the internal generator has been selected as the reference.
		<b>INT59</b>	The signal (59.94 Hz) from the internal generator has been selected as the reference.
		<b>INT60</b>	The signal (60 Hz) from the internal generator has been selected as the reference.
		<b>NTSC59</b>	The SD REF input signal has been selected as the reference. The field frequency is 59.94 Hz.
		<b>PAL50</b>	The SD REF input signal has been selected as the reference. The field frequency is 50 Hz.
		<b>INT59N</b>	The SD REF signal has been selected by the OUT REF setting. Since the SD REF signal is not input, the signal (59.94 Hz) from the internal generator is selected as the reference.
<b>INT50P</b>	The SD REF input signal has been selected by the OUT REF setting. Since the SD REF signal is not input, the signal (50 Hz) from the internal generator is selected as the reference.		

# Function menus

## <HOME>

### Playback reference signal (OutRef) specifications for tape playback

#### 59.94 Hz/60 Hz, 50 Hz mode

Input signal provided ("Yes")/not provided ("No")			OUTREF setting (menu 031)			
HD_REF_IN	SD_REF_IN	INPUT	AUTO	EXT_HD_REF	EXT_SD_REF	INPUT
Yes	Yes	Yes	HD_REF_IN	HD_REF_IN	SD_REF_IN	INPUT
		No	HD_REF_IN	HD_REF_IN	SD_REF_IN	Internal HD
	No	Yes	HD_REF_IN	HD_REF_IN	Internal SD	INPUT
		No	HD_REF_IN	HD_REF_IN	Internal SD	Internal HD
No	Yes	Yes	SD_REF_IN	Internal HD	SD_REF_IN	INPUT
		No	SD_REF_IN	Internal HD	SD_REF_IN	Internal HD
	No	Yes	INPUT	Internal HD	Internal SD	INPUT
		No	Internal HD	Internal HD	Internal SD	Internal HD

#### 23.98/24Hz, 25 Hz (HD) mode

Input signal provided ("Yes")/not provided ("No")		
HD_REF_IN		
Yes	HD_REF_IN	HD_REF_IN
No	Internal HD	Internal HD

#### 25 Hz (SD) mode

Input signal provided ("Yes")/ not provided ("No")		OUT REF setting (Menu 031)		
HD_REF_IN	SD_REF_IN	AUTO	HD_REF	SD_REF
Yes	Yes	HD_REF_IN	HD_REF_IN	SD_REF_IN
	No	HD_REF_IN	HD_REF_IN	Internal SD
No	Yes	SD_REF_IN	Internal HD	SD_REF_IN
	No	Internal HD	Internal HD	Internal SD

Internal HD: HD playback reference, 74MHzCLK operates at FreeRun setting.

Internal SD: SD playback reference, 4fscCLK operates at FreeRun setting.

### 59.94 Hz/60 Hz operation specifications for tape playback

Input signal provided ("Yes")/not provided ("No")			OUTREF setting (menu 031)			
HD_REF_IN	SD_REF_IN	INPUT	AUTO	EXT_HD_REF	EXT_SD_REF	INPUT
Yes	Yes	Yes	Complies with HD REF IN frequency.	Complies with HD REF IN frequency.	59.94Hz	Complies with INPUT frequency.
		No	Complies with HD REF IN frequency.	Complies with HD REF IN frequency.	59.94Hz	Complies with Menu 030 setting.
	No	Yes	Complies with HD REF IN frequency.	Complies with HD REF IN frequency.	59.94Hz	Complies with INPUT frequency.
		No	Complies with HD REF IN frequency.	Complies with HD REF IN frequency.	59.94Hz	Complies with Menu 030 setting.
No	Yes	Yes	59.94Hz	Complies with Menu 030 setting.	59.94Hz	Complies with INPUT frequency.
		No	59.94Hz	Complies with Menu 030 setting.	59.94Hz	Complies with Menu 030 setting.
	No	Yes	Complies with INPUT frequency.	Complies with Menu 030 setting.	59.94Hz	Complies with INPUT frequency.
		No	Complies with Menu 030 setting.	Complies with Menu 030 setting.	59.94Hz	Complies with Menu 030 setting.

Menu 030: HD FREQUENCY 59.94/60 selection

#### <Note>

Operation cannot be performed in the 60 Hz mode during SD tape playback.

# Function menus

## <HOME>

### Status display 2

Indicator	Description of setting
SCH	This lights when the SCH phase of the SDREF signal is within the prescribed range.
CF	This lights when color framing is locked.
DF	This lights during recording or playback in the drop frame mode. <b>&lt;Note&gt;</b> If the time code data could not be read properly ("T*R" is displayed), the display of the previous status is held.

### Operation mode (speed) display

This indicates the current operation mode (including the speed display).

Display	Operation mode
EJECT	Eject mode
STANDBY OFF	Standby OFF mode
T.RELEASE	Tension release mode
STOP	Stop mode
PREROLL	Preroll mode
PLAY	Playback mode
PLAY +	Special playback (playback phase adjustment) mode (FWD direction)
PLAY -	Special playback (playback phase adjustment) mode (REV direction)
REC	Recording mode
JOG REV/STILL/FWD	Jog mode
VAR (speed) [-4.9 to +4.9]	Variable mode
SHTL (speed) [-32.0 to +32.0]	Shuttle mode
FF	Fast forwarding mode
REW	Rewinding mode
EDIT	Editing mode
AUTO EDIT	Automatic editing mode
PREVIEW	Preview mode
REVIEW	Review mode
<b>When function F6 (VARMEM) on &lt;HOME SHIFT&gt; is "ON"</b>	
DSPD (speed) [-1.0 to +2.0]	Initial speed setting of variable memory
DSMP (speed) [-1.0 to +2.0]	Playback speed memory mode of variable memory
DPLY (speed) [-1.0 to +2.0]	Playback mode of variable memory
DPRV (speed) [-1.0 to +2.0]	Preview mode of variable memory editing
DEDT (speed) [-1.0 to +2.0]	Execution mode of variable memory editing

### Remaining tape/total tape display

The lengths of the remaining tape and total tape of the inserted cassette are displayed in increments of minutes.

Example: REM 10/ 92 (10 minutes remaining on a 92-minute tape)

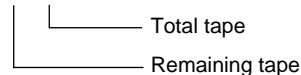

#### <Note>

Slight errors may occur. The remaining tape value blinks when less than 3 minutes of the tape remain.

### Cue time display

This displays the currently registered cue time. (For details on the cue time operation, refer to "Cue point registration, preroll and cue-up.")

Cue time operations can be performed on the HOME screen only.

### Time counter displays

Display	Description
CTL	CTL counter data
TCG	Time code data of time code generator
UBG	User's bit data of time code generator
tcg	When the time code data of time code generator is preset
ubg	When the user's bit data of time code generator is preset
TCR/T*R	Time code data of time code reader
UBR/U*R	User's bit data of time code reader

If the time code data or user's bit data could not be read out properly, "T\*R" or "U\*R" is displayed. If the CTL signal is present, the time code data is supplemented by CTL.

TCR 00:00:00:00. Field mark  
[1st field: " " / 2nd field: "."]  
(This does not appear when the +0.3× or -0.3× speed is exceeded.)  
Drop frame mark (59/60 Hz mode only)  
[Non-drop frame mode: ":" / drop frame mode: "."]

### Variable memory mode indicator

This is displayed when the **[F6]** (VARMEM) function button on <HOME SHIFT> is set to "ON." While **[VM]** is lighted, variable memory operations can be performed at any time.

(For details, refer to "Variable memory function.")

# Function menus

## <HOME>

### Registering TCG values

#### 1. Selecting the values

Press the **[F3]** TC/CTL button to select TC.  
Press the **[T]** button. The selected item (cue time or TC) is now highlighted.

Turn the ADJUST dial to select TC.

Again press the **[T]** button. A single digit is highlighted, and the mode for inputting numerical values is established.

##### <Notes>

- The UBG value and cue time can be registered in the same way. The CTL value cannot be registered.
- TC or UB can be registered only when the internal time code generator has been selected.

#### 2. Inputting numbers and letters

Press the **[0]** to **[9]** number keys to input numerical values.

Use the **[F] + [7]** buttons to input A, B and C, and the **[F] + [8]** buttons to input D, E and F.

To move the input digit, turn the ADJUST dial.

To input a minus sign, press the **[F]** and **[TRIM-]** buttons when the left-most digit is highlighted.

To input a plus sign, press the **[F]** and **[TRIM+]** buttons when the left-most digit is highlighted or press the **[0]** button.

(The display goes blank.)

To clear all the digits to zero, press the **[F]** and **[0]** buttons.

##### <Notes>

- When the **[7]** button is tapped while the **[F]** button is held down, the display changes in the following sequence: A → B → C → A → B and so on. The same applies when D, E and F are input using **[F]** and **[8]**.
- If, when "REV" has been selected as the setup menu item No.144 (TC INPUT) setting, the **[F]** button is released while a letter is being input, the displayed character will be entered.
- Letters can be input only while a UBG value is being registered.
- The input of a minus number is possible only while the cue time is being registered after "± 12h" is selected as the setup menu No.002 (TAPE TIMER) setting and CTL is selected by the **[F3]** TC/CTL button.
- If "REV" has been selected as the setup menu item No.144 (TC INPUT) setting, the input starts from the highest order digit (the display appears from the far right). However, turning the ADJUST dial once will restore the NORMAL input mode.

#### 3. Entering the input values

Press the **[ENT]** button. The value input is registered, and the normal display is restored.

##### <Notes>

- To cancel the registration, press the **[C]** button.
- If the input value is outside the registration enable range, the **[INVALID]** alarm blinks, and the value cannot be registered until it has been corrected.

# Function menus

## <HOME>

Function button/item	Switching method	Setting	Corresponding setup menu item	Description of setting
F1 OUTPUT	Toggle	<u>TAPE</u> <u>EE</u>	No. 140 OUTPUT	<b>For selecting the output signals.</b>  <In the STOP mode> <b>TAPE:</b> In the STOP mode, the signals played back from the tape are output. During recording or editing (*), simultaneous playback signals are output. *: Setup menu item No.302 (CONFI EDIT) must be set. <b>EE:</b> The input signals selected by the setup menu items No.600 (VIDEO IN SEL) and No.713 (CH1 IN SEL) to No.724 (D IN SEL 78) settings are output.
F2 _____	_____	_____	_____	_____
F3 TC/CTL*2	Toggle	<u>TC</u> <u>UB</u> <u>CTL</u>	_____	<b>For selecting the time counter display.</b>  <b>TC:</b> The time code value is displayed. <b>UB:</b> The user's bit value is displayed. <b>CTL:</b> The control signal (time data) is displayed.
F4 TC CLR*1	Press	<u>RESET</u>	_____	<b>For resetting the time counter display.</b> If the F4 button is pressed while the control signal (time data) is displayed on the time counter, it is reset to zero.
F5 _____	_____	_____	_____	_____
F6 R INH	F + toggle	<u>OFF</u> <u>ALL</u> <u>PRE</u> <u>NORM</u> <u>V/CTL</u>	No. 113 REC INH	Refer to the setup menu. <b>&lt;Note&gt;</b> The setting can be changed from OFF to ALL simply by operating the function button without pressing the F button.
F1 (SHIFT) PREROL	Toggle + ADJ	<u>0s --- 5s ---</u> <u>30s</u>	No. 000 P-ROLL TIME	Refer to the setup menu.
F2 (SHIFT) _____	_____	_____	_____	_____
F3 (SHIFT) OUTREF	F + toggle	<u>AUTO</u> <u>INPUT</u> <u>HD_REF</u> <u>SD_REF</u>	No. 031 OUT REF	Refer to the setup menu.
F4 (SHIFT) CAPSTN	F + toggle	<u>2F</u> <u>4F</u> <u>8F</u>	No. 109 CAP. LOCK	Refer to the setup menu.
F5 (SHIFT) _____	_____	_____	_____	_____
F6 (SHIFT) VARMEM*1	Toggle	<u>OFF</u> <u>ON</u>	_____	<b>For selecting the variable memory mode.</b>  <b>OFF:</b> The variable memory mode is not used. <b>ON:</b> The status is established in which variable memory playback or variable memory editing is enabled.

\*1: This item is not displayed when the 23/24 Hz or 25 Hz (HD or SD) mode has been selected as the system menu item No.25 (SYSTEM FREQ) setting.

\*2: CTL cannot be selected when the 23/24 Hz or 25 Hz (HD or SD) mode has been selected as the system menu item No.25 (SYSTEM FREQ) setting. TC is selected when the power is turned on.

\*The underlining (     ) denotes the factory setting mode.

# Function menus

## <VIDEO>

The basic input/output settings for the video signals are set, and the level of the HD output signals can also be adjusted on these menu screens.

### 1. Video signal input switching, internal signal source type changing, and up-converter aspect ratio conversion

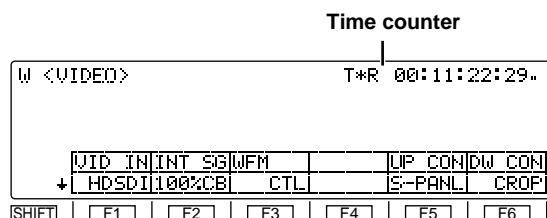

### 2. Video signal output level adjustments

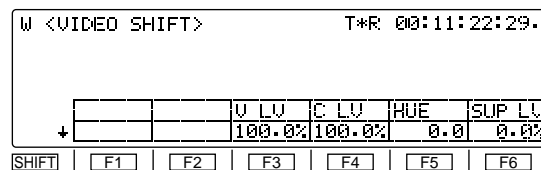

### 3. LCD monitor brightness and color adjustments

This display appears when the [F] + [SHIFT] buttons are pressed. Refer to setup menu items No.670 to 675.

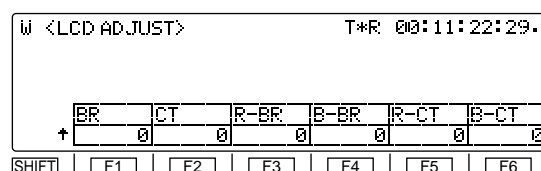

Function button/item	Switching method	Setting	Corresponding setup menu item	Description of setting
F1 VID IN	Toggle	INT SG HDSDI SDTI SDSDI	No. 600 VIDEO IN SEL	Refer to the setup menu. The SD SDI and SDTI settings will not appear if the optional boards have not been installed.
F2 INT SG	Toggle	100%CB 75%CB SMPTE ARIB MB RAMP BLACK PLL EQ	No. 601 VIDEO INT SG	Refer to the setup menu.
F3 WFM	Toggle	CTL TC VIDEO RF L RF R ENV L ENV R	No. 00 WFM SEL	Refer to the setup menu.
F4 _____	_____	_____	_____	_____
F5 UP CON	Toggle	FIT_V FIT_H FIT_HV	No. 621 UPCONV MODE	Refer to the setup menu.
F6 DW CON	Toggle	FIT_V FIT_H FIT_HV 14:9 13:9	No. 620 DOWNCON MODE	Refer to the setup menu.

\*The underlining (    ) denotes the factory setting mode.

# Function menus

## <VIDEO>

Function button/item	Switching method	Setting	Corresponding setup menu item	Description of setting
<b>When "CMPST" is selected as the setup menu item No.650 (STYLE) setting</b>				
F1 (SHIFT) _____	_____	_____	_____	_____
F2 (SHIFT) _____	_____	_____	_____	_____
F3 (SHIFT) V LV	Toggle + ADJ	<u>0.0%</u> --- <u>100.0%</u> --- 200.0%	No. 662 V LEVEL	Refer to the setup menu. To return to the UNITY (100.0%) level, use F + Press.
F4 (SHIFT) C LV	Toggle + ADJ	<u>0.0%</u> --- <u>100.0%</u> --- 141.3%	No. 663 C LEVEL	Refer to the setup menu. To return to the UNITY (100.0%) level, use F + Press.
F5 (SHIFT) HUE	Toggle + ADJ	-31.0 --- <u>0.0</u> --- +31.0	No. 664 HUE	Refer to the setup menu. To return to the UNITY (0.0) level, use F + Press.
F6 (SHIFT) SUP LV	Toggle + ADJ	-10.0% --- <u>0.0%</u> --- +10.0%	No. 665 SETUP LVL	Refer to the setup menu. To return to the UNITY (0.0%) level, use F + Press.
<b>When "CMPNT" is selected as the setup menu item No.650 (STYLE) setting</b>				
F1 (SHIFT) _____	_____	_____	_____	_____
F2 (SHIFT) _____	_____	_____	_____	_____
F3 (SHIFT) Y HD	Toggle + ADJ	<u>0.0%</u> --- <u>100.0%</u> --- 141.3%	No. 653 Y LVL(HD)	Refer to the setup menu. To return to the UNITY (100.0%) level, use F + Press.
F4 (SHIFT) Pb HD	Toggle + ADJ	<u>0.0%</u> --- <u>100.0%</u> --- 141.3%	No. 654 Pb LVL(HD)	Refer to the setup menu. To return to the UNITY (100.0%) level, use F + Press.
F5 (SHIFT) Pr HD	Toggle + ADJ	<u>0.0%</u> --- <u>100.0%</u> --- 141.3%	No. 655 Pr LVL(HD)	Refer to the setup menu. To return to the UNITY (100.0%) level, use F + Press.
F6 (SHIFT) BK HD	Toggle + ADJ	-10.0% --- <u>0.0%</u> --- +10.0%	No. 656 BK LVL(HD)	Refer to the setup menu. To return to the UNITY (0.0%) level, use F + Press.

\*The underlining (     ) denotes the factory setting mode.



# Function menus

## <AUDIO>

The basic input/output settings for the audio signals are set on these menu screens.

### 1. Audio signal input selection (CH1jCH4)

```

W <AUDIO> T*R 00:11:22:29..
+ A1 IN A2 IN DIN 12 A3 IN A4 IN DIN 34
  ANA DIGI AES ANA DIGI AES
SHIFT F1 F2 F3 F4 F5 F6
  
```

### 2. Audio signal input selection (CH5-CH8)

```

W <AUDIO SHIFT1> T*R 00:11:22:29..
+ A5 IN A6 IN DIN 56 A7 IN A8 IN DIN 78
  ANA1 DIGI AES ANA3 DIGI AES
SHIFT F1 F2 F3 F4 F5 F6
  
```

### 3. Audio volume control switching, CUE audio recording signal selection, and audio monitor mix switching

```

W <AUDIO SHIFT2> T*R 00:11:22:29..
+ VOLUME RECCUE M MIX
  PB CUE OFF
SHIFT F1 F2 F3 F4 F5 F6
  
```

Function button/item	Setting	Setting	Corresponding setup menu item	Description of setting
F1 A1 IN	Toggle	INT SG <u>DIGI</u> ANA	No. 713 CH1 IN SEL	Refer to the setup menu.
F2 A2 IN	Toggle	INT SG <u>DIGI</u> ANA	No. 714 CH2 IN SEL	Refer to the setup menu.
F3 DIN 12	Toggle	<u>AES</u> SDI	No. 721 D IN SEL 12	Refer to the setup menu.
F4 A3 IN	Toggle	INT SG <u>DIGI</u> ANA	No. 715 CH3 IN SEL	Refer to the setup menu.
F5 A4 IN	Toggle	INT SG <u>DIGI</u> ANA	No. 716 CH4 IN SEL	Refer to the setup menu.
F6 DIN 34	Toggle	<u>AES</u> SDI	No. 722 D IN SEL 34	Refer to the setup menu.
F1 (SHIFT1) A5 IN	Toggle	INT SG <u>DIGI</u> ANA1	No. 717 CH5 IN SEL	Refer to the setup menu.
F2 (SHIFT1) A6 IN	Toggle	INT SG <u>DIGI</u> ANA2	No. 718 CH6 IN SEL	Refer to the setup menu.
F3 (SHIFT1) DIN 56	Toggle	<u>AES</u> SDI	No. 723 D IN SEL 56	Refer to the setup menu.
F4 (SHIFT1) A7 IN	Toggle	INT SG <u>DIGI</u> ANA3	No. 719 CH7 IN SEL	Refer to the setup menu.
F5 (SHIFT1) A8 IN	Toggle	INT SG <u>DIGI</u> ANA4	No. 720 CH8 IN SEL	Refer to the setup menu.
F6 (SHIFT1) DIN 78	Toggle	<u>AES</u> SDI	No. 724 D IN SEL 78	Refer to the setup menu.

\*The underlining (    ) denotes the factory setting mode.

# Function menus

## <AUDIO>

Function button/item	Switching method	Setting	Corresponding setup menu item	Description of setting
<b>F1 (SHIFT2) VOLUME</b>	Toggle	<b>REC</b> <b>PB</b> <b>AUTO</b>	No. 141 VOLUME	Refer to the setup menu. For switching what is to be controlled by the audio volume controls. (The levels of all the CH1–CH8 channels are controlled.)
<b>F2 (SHIFT2)</b> _____	_____	_____	_____	_____
<b>F3 (SHIFT2) RECCUE</b>	Toggle	<b>CUE</b> <b>CH1</b> <b>CH2</b> <b>CH3</b> <b>CH4</b> <b>CH5</b> <b>CH6</b> <b>CH7</b> <b>CH8</b> <b>CH1+2</b> <b>CH3+4</b> <b>CH5+6</b> <b>CH7+8</b> <b>CH1–8</b>	No. 733 REC CUE	Refer to the setup menu.
<b>F4 (SHIFT2)</b> _____	_____	_____	_____	_____
<b>F5 (SHIFT2)</b> _____	_____	_____	_____	_____
<b>F6 (SHIFT2) M MIX</b>	Toggle	<b>OFF</b> <b>L</b> <b>R</b> <b>L/R</b>	No. 737 MONI MIX	Refer to the setup menu.

\*The underlining (    ) denotes the factory setting mode.

# Function menus

## <TC>

The TC-related settings are performed on these menu screens. Whether the TC is to be superimposed onto the display can also be set on this screen.

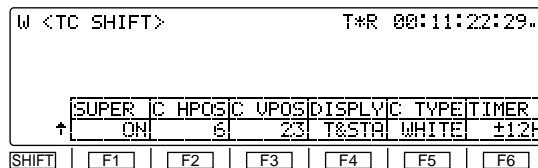
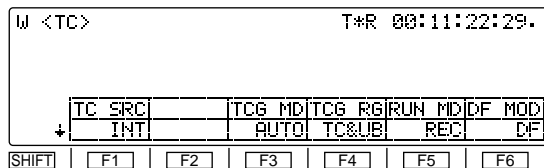

Function button/item	Switching method	Setting	Corresponding setup menu item	Description of setting
<b>F1</b> TC SRC	Toggle	When HD SDI, INT SG or SDTI is selected: <b>INT</b> EXT_L SLTC SVITC When SD SDI is selected: <b>INT</b> EXT_L VITC	No. 507 TC SOURCE	Refer to the setup menu.
<b>F2</b>	_____	_____	_____	_____
<b>F3</b> TCG MD	Toggle	<b>REGEN</b> PRE AUTO	No. 503 TCG MODE	Refer to the setup menu.
<b>F4</b> TCG RG	Toggle	<b>TC&amp;UB</b> TC UB	No. 505 TCG REGEN	Refer to the setup menu.
<b>F5</b> RUN MD	Toggle	<b>REC</b> FREE	No. 504 RUN MODE	Refer to the setup menu.
<b>F6</b> DF MOD	F + toggle	<b>DF</b> NDF	No. 511 DF MODE	Refer to the setup menu.
<b>F1 (SHIFT)</b> SUPER	Toggle	<b>OFF</b> <b>ON</b>	No. 005 SUPER	Refer to the setup menu.
<b>F2 (SHIFT)</b> C HPOS	Toggle + ADJ	<b>0 --- 6 --- 37</b>	No. 007 CHARA H-POS	Refer to the setup menu.
<b>F3 (SHIFT)</b> C VPOS	Toggle + ADJ	<b>0 --- 23 --- 32</b>	No. 008 CHARA V-POS	Refer to the setup menu.
<b>F4 (SHIFT)</b> DISPLY	Toggle	<b>TIME</b> <b>T&amp;STA</b> <b>T&amp;S&amp;M</b> <b>T&amp;RT</b> <b>T&amp;YMD</b> <b>T&amp;MDY</b> <b>T&amp;DMY</b>	No. 006 DISPLAY SEL	Refer to the setup menu.
<b>F5 (SHIFT)</b> C TYPE	Toggle	<b>WHITE</b> <b>W/OUT</b>	No. 009 CHARA TYPE	Refer to the setup menu.
<b>F6 (SHIFT)</b> TIMER	Toggle	<b>±12h</b> <b>24h</b>	No. 002 TAPE TIMER	Refer to the setup menu.

\*The underlining (     ) denotes the factory setting mode.

# Function menus

## <CUE>

A maximum of 60 cue points can be set on these menu screens. When "AUTO" has been selected as the [F3] (PAGE) setting on the AUTO PAGE mode <CUE SHIFT> menu, up to 10 pages of cue points with 6 cue points on each page can be managed on a page-by-page basis. The 60 cue points are indicated using the page number display and registered point display areas.

### <Note>

Cue points cannot be registered, prerolled, etc. if a setting other than "ENA" has been selected as the setup menu item No.001 (LOCAL ENA) setting in the REMOTE mode.

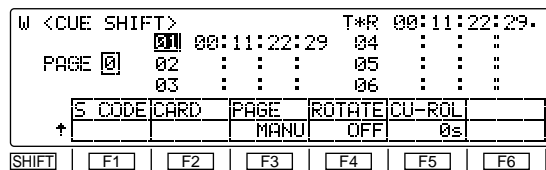
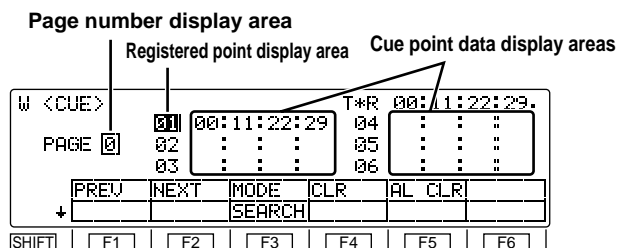

### Page number display area

The page number from 0 to 9 is indicated here.

### Registered point display area

On each page, six cue point data managed by registered point numbers are displayed. A point whose registered point number is highlighted is targeted for registration and search.

Shown below is the correlation between the page numbers and registered point numbers.

Page no.	Registered points	Page no.	Registered points
0	01-06	5	51-56
1	11-16	6	61-66
2	21-26	7	71-76
3	31-36	8	81-86
4	41-46	9	91-96

### Page operations

Pages can be scrolled in the forward or reverse direction using the [F1] (PREV) or [F2] (NEXT) function buttons.

- Depending on the setting selected for [F4] (ROTATE) on the <CUE SHIFT> menu, the following applies to scrolling pages in the forward direction.

#### When "OFF" is set:

Page 0 cannot be scrolled forward from page 9.

#### When "ON" is set:

Page 0 can be scrolled forward from page 9.

- In scrolling pages in the reverse direction, page 9 cannot be scrolled in reverse from page 0.

### Moving to registered points

The highlighting on the registered point display area is moved by turning the ADJUST dial. It is moved in the ascending order of points when the dial is turned clockwise and in the descending order of points when it is turned counterclockwise. When "AUTO" has been selected as the [F3] (PAGE) setting on the <CUE SHIFT> menu, the highlighting can be moved also to the previous or next page.

- Depending on the setting selected for [F4] (ROTATE) on the <CUE SHIFT> menu, the following applies to moving the highlighting in the ascending order of points.

#### When "OFF" is set:

The highlighting cannot be moved from page 9 to page 0.

#### When "ON" is set:

The highlighting can be moved from page 9 to page 0.

- In moving in the descending order of points, the highlighting cannot be moved from page 0 to page 9.

### Search point and registered point operations

Each time the [F3] (MODE) button of the <CUE> menu is pressed, the search mode and cue point registration mode are switched alternately. Perform the search point or registered point operations in the respective mode.

- When the power is turned on, the search point or registered point, whichever was established when the power was last turned off, is established.
- When the setting for [F3] (PAGE) or [F4] (ROTATE) on the <CUE SHIFT> menu has been changed, "01" (page 0/point no.1) is set for both the search and registered points.

### Cue point registration mode

It is possible to register points to which the tape is to be prerolled. When the display page has been changed using the [F1] (PREV) or [F2] (NEXT) button on the <CUE> menu, the following applies depending on the setting for [F3] (PAGE) on the <CUE SHIFT> menu.

#### When "MANU" is set:

Both the search and registered points move to the top of the changed page.

#### When "AUTO" is set:

Only the registered point moves to the top of the changed page; the search point does not move.

# Function menus

## <CUE>

### Search mode

The desired search point can be selected, and the tape can be prerolled to that point.

When the display page has been changed using the **[F1]** (PREV) or **[F2]** (NEXT) button on the <CUE> menu, the following applies depending on the setting for **[F3]** (PAGE) on the <CUE SHIFT> menu.

#### When “MANU” is set:

Both the search and registered points move to the top of the changed page.

#### When “AUTO” is set:

Only the search point moves to the top of the changed page; the registered point does not move.

### Cue point registration

Turn the ADJUST dial to highlight the point which is to be registered. When the **[SET]** button is pressed, the current tape position is registered as the cue point.

The following applies depending on the setting for **[F3]** (PAGE) on the <CUE SHIFT> menu.

#### When “MANU” is set:

Operations are performed on the selected page. Press the **[SET]** button to register the points in succession (CUE\*1 → CUE\*2 → ... → CUE\*6) on the selected page. (Any points already registered will be overwritten.)

The registration is automatically terminated when CUE\*6 is registered on the page. (\*1)

A change must be made to the points to be registered if more cue points are to be registered. Check that the cue point registration mode is established, change the page, and change the points to be registered. In this case, the search point will also move automatically to the top (CUE\*1) of the changed page.

(\*1) If “ON” is selected as the **[F4]** (ROTATE) setting on the <CUE SHIFT> menu, the registration of the cue points will rotate on the same page in the following order: CUE\*1 → CUE\*2 → ... → CUE\*6 → CUE\*1 → CUE\*2 → ...

#### When “AUTO” is set:

When a page becomes full during the cue point registration process, operation automatically moves to the next page, and registration continues. When CUE96 on the last page is reached, registration is automatically terminated. (\*2)

A change must be made to the points to be registered if more cue points are to be registered. Check that the cue point registration mode is established, change the page, and change the points to be registered. In this case, the search point will not be changed.

(\*2) If “ON” is selected as the **[F4]** (ROTATE) setting on the <CUE SHIFT> menu, the registration of the cue points will rotate from page 9 (CUE96) to page 0 (CUE01).

### When registering cue points by number

1. Turn the ADJUST dial to highlight the desired registered point display area.

2. Press the **[T]** button twice. Only the “10’s” hour digit of the selected cue point is now highlighted, and the change enable status is established.

#### <Note>

When “REV” has been selected as the setup menu item No.144 (TC INPUT) setting, the input of the number will start from the higher-order digit (it will be displayed starting from the far right).

3. Input the number using the number keys. Movement from one digit to the next is done automatically after one number has been input. The desired digit can also be selected by turning the ADJUST dial.

4. To enter the number, press the **[ENT]** button. When the display screen is switched or when the **[C]** button is pressed during the input process, the change enable status is released, and the setting is canceled.

# Function menus

## <CUE>

### Clearing registered points

#### ■ Clearing all the registered points together

When **[F5]** (AL CLR) on the <CUE> menu is pressed while the **[F]** button is held down, all the cue point data currently selected is cleared. The range of the points which are cleared is as follows depending on the setting for **[F3]** (PAGE) on the <CUE SHIFT> menu.

#### When “MANU” is set:

All the points on the currently selected page are cleared.

#### When “AUTO” is set:

All the points on all the pages are cleared.

After clearing, the search and registered points appear as follows depending on the setting for **[F3]** (PAGE) on the <CUE SHIFT> menu.

#### When “MANU” is set:

A return is made to the top (CUE\*1) of the page concerned.

#### When “AUTO” is set:

A return is made automatically to the top (CUE01) of the first page.

\* Points are cleared whether “ENTRY” (cue point registration mode) or “SEARCH” (search mode) is selected as the setting for **[F3]** (MODE) on the <CUE> menu.

#### ■ Clearing individual registered points

When the **[F4]** (CLR) button on the <CUE> menu is pressed, the currently selected cue point data is cleared.

\* The point is cleared only when “ENTRY” (cue point registration mode) is selected as the setting for **[F3]** (MODE) on the <CUE> menu.

### Search operations

Turn the ADJUST dial to highlight the desired registered point.

When the PREROLL button is pressed, the preroll operation is initiated. The tape will not be prerolled if no cue points have been registered.

Since the tape is not prerolled even if the PREROLL button is pressed when the cue point registration mode is established, be absolutely sure to check that the search mode is established.

(The time selected by the <CUE SHIFT> menu **[F5]** (CU-ROL) setting, which is different from the normal preroll time, takes effect as the preroll time in this mode.)

Function button/item	Switching method	Setting	Corresponding setup menu item	Description of setting
<b>F1</b> PREV	Press	_____	_____	For multi-cue page forward scrolling.
<b>F2</b> NEXT	Press	_____	_____	For multi-cue page reverse scrolling.
<b>F3</b> MODE	Toggle	<u>SEARCH</u> <u>ENTRY</u>	_____	For selecting the search or cue point registration mode.
<b>F4</b> CLR	Press	_____	_____	For clearing the currently selected cue data. ENTRY must be selected as the F3 (MODE) setting.
<b>F5</b> AL CLR	F+Press	_____	_____	When MANU is selected by SHIFT + F3 (PAGE): All the cue data on the currently displayed page is cleared. When AUTO is selected by SHIFT + F3 (PAGE): All the cue data on all the pages is cleared.
<b>F6</b> _____	_____	_____	_____	_____
<b>F2 (SHIFT)</b> CARD	F+Press	_____	_____	For calling the MULTI CUE file operation menu.
<b>F3 (SHIFT)</b> PAGE	Toggle	<u>MANU</u> <u>AUTO</u>	No. 131 PAGE MODE	Refer to the setup menu.
<b>F4 (SHIFT)</b> ROTATE	Toggle	<u>OFF</u> <u>ON</u>	No. 132 ROTA MODE	Refer to the setup menu.
<b>F5 (SHIFT)</b> CU-ROL	Toggle + ADJ	<u>0s --- 5s ---</u> <u>15s</u>	No. 011 CU-ROLL TIME	Refer to the setup menu.
<b>F6 (SHIFT)</b> _____	_____	_____	_____	_____

\* This item is not displayed when the 23/24 Hz or 25 Hz (HD or SD) mode has been selected as the system menu item No.25 (SYSTEM FREQ) setting.

\*The underlining (     ) denotes the factory setting mode.

# Function menus

## <DIAG>

The warnings and hour-meter can be checked on these menu screens. On the SHIFT menu screen, error log files can be checked, deleted or saved onto or loaded from IC cards.

### Warning mark

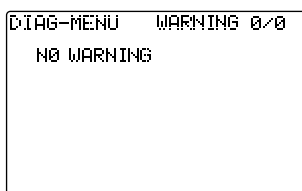
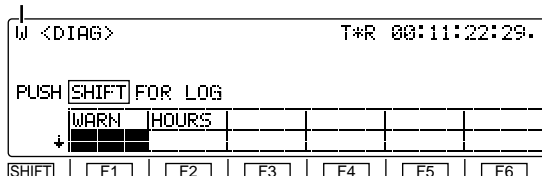

### Warning display

When a warning occurs in this VTR, the warning mark (W) blinks at the top left of the screen. If [F1] (WARN) is now pressed, the details of the warning can be checked out on the LCD monitor.

When more than one warning has occurred, turn the ADJ dial to scroll through the messages.

### Hour-meter display

When [F2] (HOURS) is pressed, the hour-meter information can be checked out on the LCD monitor.

### Error log function

The error log mode can be selected by pressing the [SHIFT] button and switching the screen to <DIAG SHIFT>.

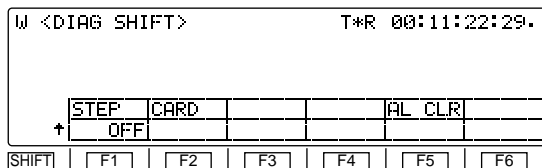

### General description

When the following warnings have occurred while the tape is running, the warning messages, time codes and operating modes are saved, and a list of this information can be read out on the LCD monitor. Up to 99 warnings which have occurred can be saved. If the storage capacity of 99 warnings is exceeded, the processing that is conducted as a result is based on the setup menu item No.015 (AUTO STEP) setting.

Warning messages which are saved	Description (Refer to page 118 and following.)
NO RF	A blank section on the tape lasting more than 1 second has been detected. (During normal playback)
SV NOT LOCKED	The servo has been disengaged for more than 3 seconds. (During recording, normal playback or editing)
LOW RF	An envelope level which is about 1/3 of normal or a CTL level which is about 1/6 of normal has been detected for more than 1 second. (During recording, normal playback or editing)
HIGH ERROR RATE	The error rate has deteriorated, and correction or compensation has been applied to the video or audio playback signals. (During normal playback)

## LCD monitor displays

### Operation mode display

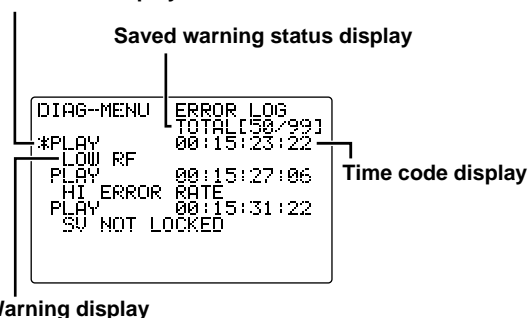

### Operation mode display

This indicates the operation mode at the point when the warning was saved.

### Warning display

This indicates the warning message which is saved.

### Saved warning status display

This indicates the number of the currently displayed warning which has been saved and the total number of warnings which have been saved.

### Time code display

This indicates the time code at the point when the warning was saved.

### Cueing up the tape to the warning point

The warning list displayed on the LCD monitor can be scrolled by turning the ADJ dial. When the warning occurrence point to be checked is selected and the PREROLL button is pressed, the tape is cued up to the position of the time code which has been saved.

# Function menus

## <DIAG>

Function button/item	Switching method	Setting	Corresponding setup menu item	Description of setting
F1 WARN	_____	_____	_____	For displaying the warning messages on the LCD monitor.
F2 HOURS	_____	_____	_____	For displaying the hour-meter on the LCD monitor.
F3 _____	_____	_____	_____	_____
F4 _____	_____	_____	_____	_____
F5 _____	_____	_____	_____	_____
F6 _____	_____	_____	_____	_____
F1 (SHIFT) STEP	Toggle	OFF ON	No. 015 AUTO STEP	Refer to the setup menu.
F2 (SHIFT) CARD	F+Press	_____	_____	For calling the error log file operation menu.
F3 (SHIFT) _____	_____	_____	_____	_____
F4 (SHIFT) _____	_____	_____	_____	_____
F5 (SHIFT) AL CLR	F+Press	_____	_____	For clearing error log files.
F6 (SHIFT) _____	_____	_____	_____	_____

### Concerning the setup menu item No.015 (AUTO STEP) setting (default: OFF)

Up to 99 warning messages can be saved by the error log function, and this setup menu item determines what kind of save processing is to be conducted when this storage capacity is exceeded.

**OFF:** 99 messages are set as the upper limit, and no further messages of warnings that occur will be saved.

**ON:** 99 messages are saved, and any further message of a warnings that occurs is saved in No.99. The warning messages already saved are each shifted down by one number in succession.

### Messages saved when ON is selected as the setting

No. in which message is saved	Saved warning		No. in which message is saved	Saved warning
1/99	Warning 1	→	1/99	Warning 2
2/99	Warning 2		2/99	Warning 3
⋮	⋮		⋮	⋮
⋮	⋮		⋮	⋮
99/99	Warning 99		99/99	Warning 100

When up to 99 messages have been saved and the 100th warning has occurred



# Function menus

## <MENU>

These enable movement to the menu screens for operations (adjustments, saving data onto or loading it from the internal memory or IC cards) relating to the SYSTEM and SETUP menus.

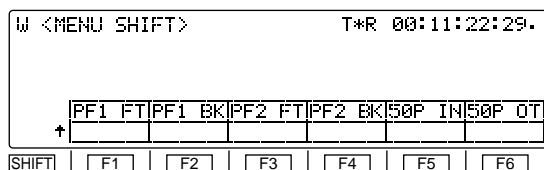
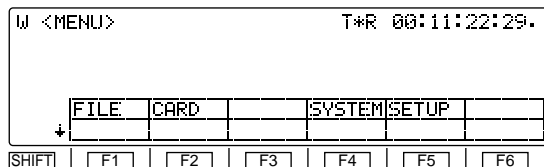

Function button/item	Switching method	Setting	Corresponding setup menu item	Description of setting
<b>F1</b> <b>FILE</b>	F+Press	_____	_____	For calling the operation menu for saving the SYSTEM and SETUP adjustment values (in the internal memory).
<b>F2</b> <b>CARD</b>	F+Press	_____	_____	For calling the operation menu for saving the SYSTEM and SETUP adjustment values (onto the IC card).
<b>F3</b> _____	_____	_____	_____	_____
<b>F4</b> <b>SYSTEM</b>	F+Press	_____	_____	For calling the SYSTEM adjustment operation menu.
<b>F5</b> <b>SETUP</b>	F+Press	_____	_____	For calling the SETUP adjustment operation menu.
<b>F6</b> _____	_____	_____	_____	_____
<b>F1 (SHIFT)</b> <b>PF1 FT</b>	F+Press	_____	_____	For calling the PF1/function button assignment operation menu.
<b>F2 (SHIFT)</b> <b>PF1 BK</b>	F+Press	_____	_____	For calling the PF1/function button assignment operation menu.
<b>F3 (SHIFT)</b> <b>PF2 FT</b>	F+Press	_____	_____	For calling the PF2/function button assignment operation menu.
<b>F4 (SHIFT)</b> <b>PF2 BK</b>	F+Press	_____	_____	For calling the PF2/function button assignment operation menu.
<b>F5 (SHIFT)</b> <b>50P IN</b>	F+Press	_____	_____	For calling the 50-pin (input pin) assignment operation menu.
<b>F6 (SHIFT)</b> <b>50P OT</b>	F+Press	_____	_____	For calling the 50-pin (output pin) assignment operation menu.

\*The underlining (    ) denotes the factory setting mode.

# Function menus

## <ASSEMBLE>

The ASSEMBLE editing mode is selected on this menu screen.

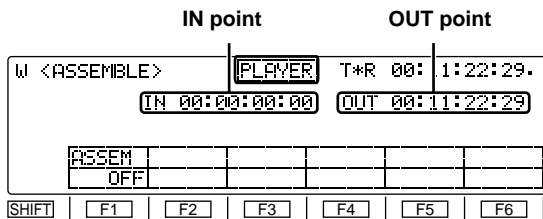

### Automatic editing and manual editing

- When the editing mode has been selected (the **ASSEM** button is lighted), automatic editing or manual editing can be performed even after the ASSEMBLE screen has been exited.
- After the edit IN and OUT points have been registered (the **IN** and **OUT** buttons are lighted), the tape can be prerolled to an IN point or cued up to an IN or OUT point even after the ASSEMBLE screen has been exited.

Function button/item	Switching method	Setting	Corresponding setup menu item	Description of setting
F1 ASSEM	Toggle	<u>OFF</u> ON	_____	For setting the editing mode to ON or OFF. When the display is highlighted, the ASSEMBLE editing mode is set to ON, and the ASSEM button lights.
F2 _____	_____	_____	_____	_____
F3 _____	_____	_____	_____	_____
F4 _____	_____	_____	_____	_____
F5 _____	_____	_____	_____	_____
F6 _____	_____	_____	_____	_____

\*The underlining (    ) denotes the factory setting mode.

# Function menus

## <INSERT>

The INSERT editing mode and editing channels are selected on this menu screen.

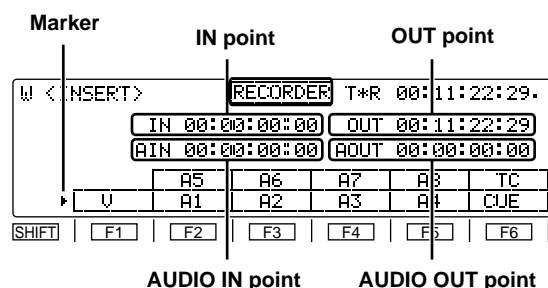

### Registering the edit points

After the edit IN and OUT points have been registered, the **IN** and **OUT** buttons light.

### Automatic editing and manual editing

- When the editing mode has been selected (the **INSERT** button is lighted), automatic editing or manual editing can be performed even after the INSERT screen has been exited.
- After the edit IN and OUT points have been registered (the **IN** and **OUT** buttons are lighted), the tape can be prerolled to an IN point or cued up to an IN or OUT point even after the INSERT screen has been exited.

Function button/item	Switching method	Setting	Corresponding setup menu item	Description of setting
F1 V	Toggle	_____	_____	<b>For setting the editing mode to ON or OFF and selecting the editing channels.</b>
F2 A5, A1				With the exception of the function button (F1), two channels are allocated.
F3 A6, A2				Use the SHIFT button to move the marker up or down, and while specifying the channels, press the function buttons to select them. Pressing the SHIFT button on other screens serves a different purpose (screen switching) from its use here.
F4 A7, A3				<b>For setting the editing mode to ON or OFF.</b>
F5 A8, A4				When one of the channel displays is highlighted, the INSERT editing mode is set to ON, and the INSERT button lights.
F6 T, CUE				

# Function menus

## <SETUP MENU/SYSTEM MENU>

When the SETUP MENU or SYSTEM MENU operation menu is selected, a menu list appears on the monitor, and the respective items can be set.

### SETUP menu

Change mark

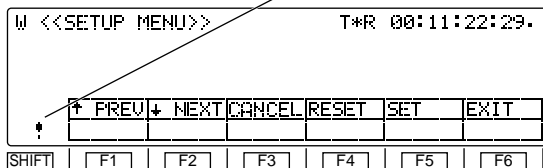

### SYSTEM menu

Change mark

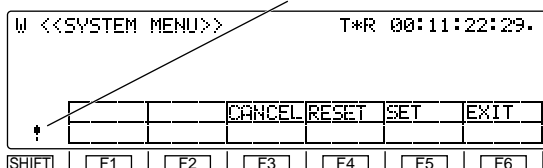

### Monitor display menu

Item selection cursor

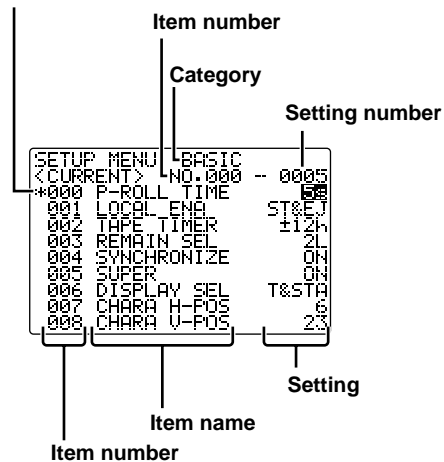

## Settings

### 1. Selecting the menu items

Select the menu item by turning the ADJ dial. (The cursor is moved down when the dial is turned clockwise and up when it is turned counterclockwise.)

- Forward or reverse page scrolling (SETUP menu only)

The menu list is organized by category, and the pages can be scrolled in the forward or reverse direction on a category by category basis.

[F1] (↑ PREV), [F2] (↓ NEXT)

#### <Note>

The screen may continue to scroll for a few moments after the ADJ dial has been turned.

### 2. Changing the settings

1. In the menu item selection status, press the ADJ dial.

At this time, the setting of the menu item indicated by the menu item selection cursor blinks on the monitor.

2. Turn the ADJ dial to select the setting. (Turn it clockwise to move up through the settings and counterclockwise to move down through the settings.)

When the ADJ dial is pressed again, the menu item selection status is restored.

#### <Notes>

- **Setting items which have submenus**

A submenu is opened by pressing the [SHIFT] button. The same operations as the ones described above are then used to change the settings.

- **Canceling individual items**

When [F3] (CANCEL) is pressed, the setting operation is canceled, and the item selection status is restored.

### 3. Entering settings

(After a setting has been entered, the menu operation is forcibly exited.)

Press [F5] (SET) to enter a setting.

### 4. Exiting the menu operation

When the [F6] (EXIT) button is pressed in the menu item selection status, the menu operation is exited, and the original operation screen is restored.

However, if the [F6] (EXIT) button is pressed after a setting has been changed without that setting having been entered, a confirmation message will be displayed.

### Confirmation message

Confirmation item	Description of setting
EXIT confirmation	
When an attempt has been made to exit the menu operation after a setting has been changed without that setting having been entered	EXIT? F3: CANCEL F5: SET(and EXIT) F6: EXIT(without SET)

#### <Note>

The "!" mark appears at the bottom left of the screen when a setting has been changed.

# Function menus

## <SETUP MENU/SYSTEM MENU>

### Flow of setting changes

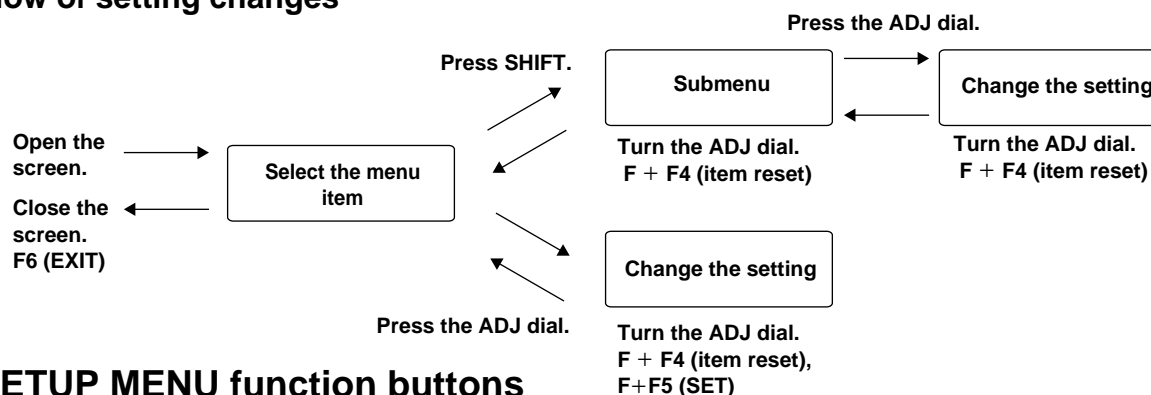

## SETUP MENU function buttons

Function button/item	Switching method	Setting	Corresponding setup menu item	Description of setting
F1 ↑ PREV	Press	_____	_____	For scrolling the on-screen menu pages in the forward direction.
F2 ↓ NEXT	Press	_____	_____	For scrolling the on-screen menu pages in the reverse direction.
F3 CANCEL	Press	_____	_____	_____
F4 RESET	Press	_____	_____	For resetting an item (while a setting is being changed).
F5 SET	Press	_____	_____	For entering what has been set.
F6 EXIT	Press	_____	_____	For exiting the special menu (and transferring to the original menu). (Confirmation message provided)
F1 (SHIFT) F2 (SHIFT) F3 (SHIFT) F4 (SHIFT) F5 (SHIFT) F6 (SHIFT) _____	_____	_____	_____	_____

## SYSTEM MENU function buttons

Function button/item	Switching method	Setting	Corresponding setup menu item	Description of setting
F1 F2 _____	_____	_____	_____	_____
F3 CANCEL	Press	_____	_____	_____
F4 RESET	Press	_____	_____	For resetting an item (while a setting is being changed).
F5 SET	Press	_____	_____	For entering what has been set.
F6 EXIT	Press	_____	_____	For exiting the special menu (and transferring to the original menu). (Confirmation message provided)
F1 (SHIFT) F2 (SHIFT) F3 (SHIFT) F4 (SHIFT) F5 (SHIFT) F6 (SHIFT) _____	_____	_____	_____	_____

# Function menus

## <FILE>

The current setting information, including the SETUP menu contents, can be provided with titles and either saved in or loaded from the backup memory in one of 4 variations.

When [F1] (FILE) is pressed while the [F] button is held down on the <MENU> screen, the following function menu is displayed.

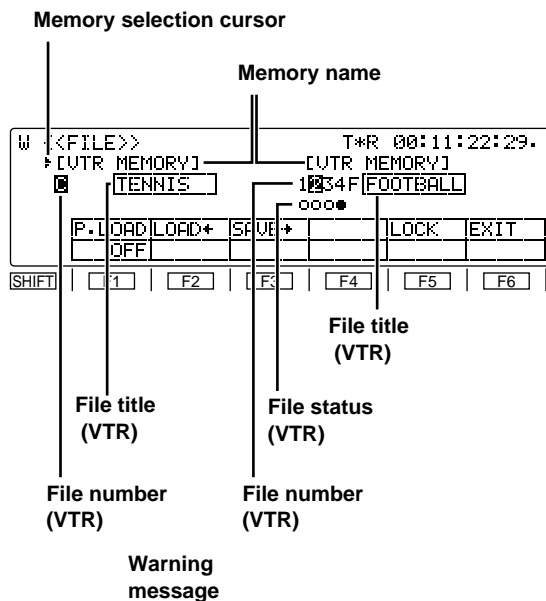

- This VTR comes with VTR MEMORY [C] for storing the current settings (\*) and VTR MEMORY [1] to [4] for storing these settings as a backup.
- Each VTR MEMORY can be provided with a title.
- Data can be saved and loaded and titles can be copied between VTR MEMORY [C] and VTR MEMORY [1] to [4].
- The file locking facility for preventing data from being overwritten can be engaged for VTR MEMORY [1] to [4].

\* The term "settings" used here refers to all the settings on the setup menus excluding the SYSTEM menu, what has been registered in the PF1 and PF2 menu items, and the contents of some of the function buttons.

Name of memory area	Initial title (up to 8 characters)
VTR MEMORY C	CURRENT
VTR MEMORY 1	USER1
VTR MEMORY 2	USER2
VTR MEMORY 3	USER3
VTR MEMORY 4	USER4

## Settings

### 1. Selecting the memory target

Press the [SHIFT] button.

The operation target switches alternately between VTR MEMORY [C] and VTR MEMORY [1] to [4].

### 2. Selecting the operation file in the selected memory

The number of the currently selected file is highlighted on the display. When the ADJ dial is turned, the highlighting moves to the left or right, enabling operation files to be selected.

### 3. Transferring files between memories

After selecting the operation file, press [F2] (LOAD).

The contents of files selected in VTR MEMORY [1] to [4] can be transferred to VTR MEMORY [C].

When [F] is selected and [F2] (LOAD) is pressed, the factory setting mode is established.

Alternatively, when [F3] (SAVE) is pressed, the contents of a file in VTR MEMORY [C] can be transferred to a file selected in VTR MEMORY [1] to [4]. (The titles are also transferred at the same time.)

### 4. Editing the title of the selected file

Press the ADJ dial after selecting the operation file.

The first digit of the title display area is highlighted, and the file title can be edited.

- To input a number, press the number keys.
- To input letters, tap the numbers keys until the letter to be input appears while holding down the [F] button.

More than one letter is allocated to each number key.

- Turn the ADJ dial to move from one digit to the next in the title display area.
- To enter the title, press the ADJ dial again.

#### <Notes>

- When the display screen has been switched or the [C] button has been pressed during title editing, the editing enable status is canceled, and the setting becomes invalid.
- A space can be input by pressing the [F] button and [3] button.

# Function menus

## <FILE>

### Settings

#### 5. File overwrite inhibit facility

It is possible to lock the overwrite inhibit facility for individual files in VTR MEMORY **1** to **4**. Select the file to be locked, and press **F5** (LOCK) to lock it.

If **F5** (LOCK) is pressed again, the facility is unlocked.

The locked or unlocked mode is displayed in the file status.

[○: Unlocked status, ●: locked status]

Function button/item	Switching method	Setting	Corresponding setup menu item	Description of setting
F1 P. LOAD	Press	OFF USER1 USER2 USER3 USER4	A02 P.ON LOAD	Refer to the setup menu.
F2 LOAD←	Press	_____	_____	For downloading data to the current file.
F3 SAVE→	Press	_____	_____	For downloading data to the backup file.
F4 _____	_____	_____	_____	_____
F5 LOCK	Press	_____	_____	For locking the backup file.
F6 EXIT	_____	_____	_____	_____
F1 (SHIFT) F2 (SHIFT) F3 (SHIFT) F4 (SHIFT) F5 (SHIFT) F6 (SHIFT) _____	_____	_____	_____	_____

\*The underlining (\_\_) denotes the factory setting mode.

# Function menus

## <PF1/PF2>

Up to 24 frequently used setup menu items can be registered. The items are registered on the function menu shown below. (No settings have been registered before the VTR leaves the factory.)

To display one of the function menus, press **[F1]** (PF1 FT), **[F2]** (PF1 BK), **[F3]** (PF2 FT) or **[F4]** (PF2 BK) while holding down the **[F]** button on the <MENU SHIFT> screen.

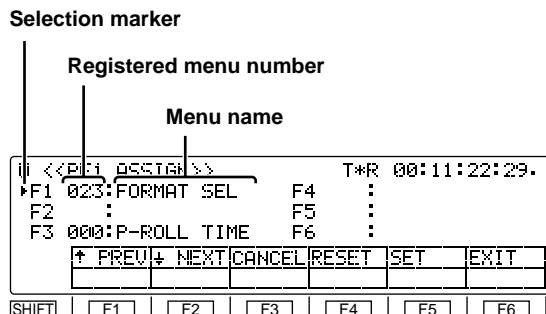

### Item selection cursor

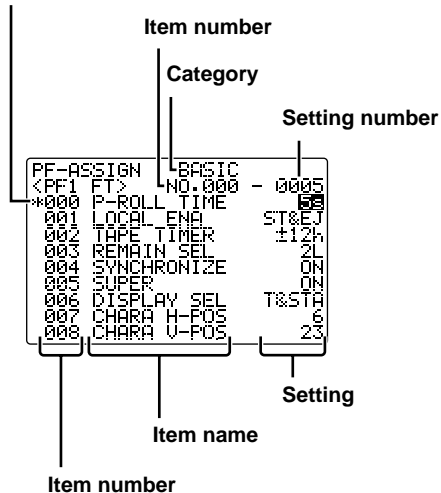

## Registration

### 1. Selecting the function buttons

Turn the ADJ dial to move the selection marker, and select one of the function buttons **[F1]** to **[F6]** into which the menu items are to be registered.

### 2. Entering the function button

Press the ADJ dial.

The display of the function button entered is highlighted.

### 3. Selecting menu items

Turn the ADJ dial, and select the menu item for the function button that was selected in step 1 above.

### 4. Entering the menu items.

Press the ADJ dial.

The target of the ADJ dial operation returns to the front panel. Whatever was selected in step 3 above is displayed for the registered menu number and name.

### 5. To select a menu item for another function button, repeat steps 1, 2, 3 and 4 above.

### 6. Saving the settings in a PF registration file

To save what has been set in the function buttons in a PF registration file, press **[F5]** (SET).

If **[F6]** (EXIT) is pressed without the settings having been saved, the settings will be canceled.

When menu items are registered, they can be called simply by pressing the PF1 or PF2 direct menu button.

**When [PF1] is pressed :**

<PF1 FT>

**When [SHIFT] is pressed after pressing [PF1] :**

<PF1 BK>

**When [PF2] is pressed :**

<PF2 FT>

**When [SHIFT] is pressed after pressing [PF2] :**

<PF2 BK>

## Clearing the menu items

1. Turn the ADJ dial to move the selection marker, and select one of the function buttons **[F1]** to **[F6]** whose menu items are to be cleared.

2. Press **[F4]** (RESET). The registered menu number and name displays will now go blank.

3. To clear the menu items from other function buttons, repeat steps 1 and 2 above.

4. To save what has been set in the function buttons in a PF registration file, press **[F5]** (SET).

If **[F6]** (EXIT) is pressed without the settings having been saved, the above settings will be canceled.

## Clearing all the function button settings

Press **[F4]** (RESET) while holding down the **[F]** button. All the registered menu number and name displays will now go blank.

All the contents of the PF registration file are cleared. (They cannot be restored.)



# Function menus

## <PF1/PF2>

### Flow of function button registration

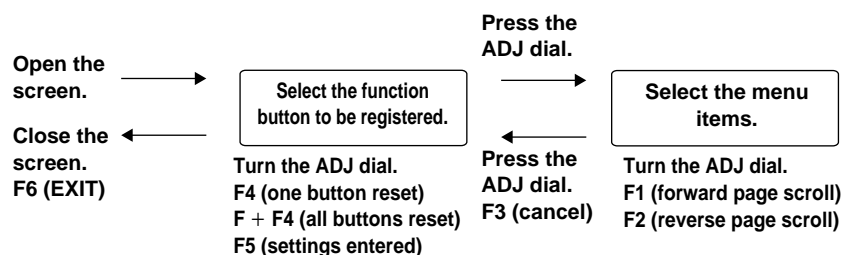

### PF1/PF2 function buttons

Function button/item	Switching method	Setting	Corresponding setup menu item	Description of setting
F1 ↑ PREV	Press	_____	_____	For scrolling the on-screen menu pages in the forward direction.
F2 ↓ NEXT	Press	_____	_____	For scrolling the on-screen menu pages in the reverse direction.
F3 CANCEL	Press	_____	_____	For releasing the menu item selection status.
F4 RESET	Press	_____	_____	For clearing one button: what has been selected for the pin by the individual reset selection marker is cleared.
	F+Press	_____	_____	For clearing all the buttons: what has been registered in all the pins is deleted from the PF registration files.
F5 SET	Press	_____	_____	For entering the settings. (No confirmation message provided)
F6 EXIT	Press	_____	_____	For exiting the special menu (and transferring to the original menu). (Confirmation message provided)
F1 (SHIFT) F2 (SHIFT) F3 (SHIFT) F4 (SHIFT) F5 (SHIFT) F6 (SHIFT) _____	_____	_____	_____	_____

# Function menus

## <PF1/PF2>

### PF1/PF2 function button names

When SETUP menu items have been registered in the function buttons, the names of these function buttons are displayed as set forth in the table below.

Setup menu item No.	Name of setup menu item	Function button name
000	P-ROLL TIME	PREROL
001	LOCAL ENA	L ENA
002	TAPE TIMER	TIMER
003	REMAIN SEL	REMAIN
004	SYNCHRONIZE	SYNCR
005	SUPER	SUPER
006	DISPLAY SEL	DISPLY
007	CHARA H-POS	C HPOS
008	CHARA V-POS	C VPOS
009	CHARA TYPE	C TYPE
010	MONI CONTROL	MONI C
011	CU-ROLL TIME	CU-ROL
012	REC ADJUST	REC AJ
013	DET STOP	DET ST
014	DET ADJUST	DET AJ
015	AUTO STOP	STEP
020	SYS FORMAT	SYS FT
022	PB FORMAT	PB FT
023	FORMAT SEL	FMT SL
030	HD FREQUENCY	HD FRQ
031	OUT REF	OUTREF
100	SEARCH ENA	SEARCH
101	SHTL MAX	STL MX
102	FF.REW MAX	F/R MX
104	REF ALARM	REF AL
105	AUTO EE SEL	AT EE
106	EJECT EE SEL	EJ EE
107	EE MODE SEL	EE MD
108	PLAY DELAY	PL DLY
109	CAP.LOCK	CAPSTN
110	AUTO REW	AT REW
111	MEMORY STOP	MEM ST
112	FRZ MODE SEL	FRZ MD
113	REC INH	R INH
114	REC INH LAMP	INH LP
115	EJECT SW INH	EJ SW
116	EJECT LAMP	INH LP
118	SP MODE INH	SP MD
131	PAGE MODE	PAGE

Setup menu item No.	Name of setup menu item	Function button name
132	ROTA MODE	ROTATE
133	KEY BEEP	KEY BP
134	ALARM BEEP	AL BP
135	DET BEEP	DET BP
140	OUTPUT	OUTPUT
141	VOLUME	VOLUME
142	AUDIO UNITY	A UNI
143	CASSTT LIGHT	CAS LT
144	TC INPUT	TC IN
145	FRONT LCD	F LCD
200	PARA RUN	PR RUN
202	ID SEL	ID SEL
204	RS232C SEL	RS232C
205	BAUD RATE	BAND R
206	DATA LENGTH	DATA L
207	STOP BIT	ST BIT
208	PARITY	PARITY
209	RETURN ACK	RET AK
212	MASTER PORT	MSTR P
300	IN/OUT DEL	HD FRQ
301	NEGA FLASH	OUTREF
302	CONFI EDIT	CONFI
303	AUD EDIT IN	AUD I
304	AUD EDIT OUT	AUD O
305	AUTO ENTRY	AT ENT
306	CF ADJ SEL	CF ADJ
307	AFTER CUE-UP	AF CUP
308	VAR FWD MAX	V F MX
309	VAR REV MAX	V R MX
310	JOG FWD MAX	J F MX
311	JOG REV MAX	J R MX
312	POSTROLL TM	POSROL
320	EDIT RPLCE1	RPLCE1
321	EDIT RPLCE2	RPLCE2
322	EDIT RPLCE3	RPLCE3
323	EDIT RPLCE4	RPLCE4
324	EDIT RPLCEC	RPLCEC

# Function menus

## <PF1/PF2>

Setup menu item No.	Name of setup menu item	Function button name
400	STILL TIMER	STILL
401	SRC PROTECT	SRC PT
402	DRUM STDBY	DRUM
403	STOP PROTECT	STP PT
500	VITC BLANK	VI BLK
501	VITC POS-1	VI PS1
502	VITC POS-2	VI PS2
503	TCG MODE	TCG MD
504	RUN MODE	RUN MD
505	TCG REGEN	TCG RG
506	REGEN MODE	REG MD
507	TC SOURCE	TC SRC
508	BINARY GP	BINARY
509	PHASE CORR	P CORR
510	TCG CF FLAG	TG CFF
511	DF MODE	DF MOD
512	TC OUT REF	TC REF
513	VITC OUT	VITC O
514	HD EMBD VITC	ENBD V
515	HD EMBD LTC	ENBD L
516	TC OUT ADV	TC ADV
517	TCG OUT	TCG O
600	VIDEO IN SEL	VID IN
601	VIDEO INT SG	INT SG
602	SDI IN MODE	SDI IN
603	V-MUTE SEL	V-MUTE
604	FREEZE SEL	FRZ SL
605	INTERPOLATE	INTPLT
606	SD MON O SEL	SD MOS
620	DOWNCON MODE	DW CON
621	UPCONV MODE	UP CON
622	D/C RESP H	D/C RH
623	D/C RESP V	D/C RV
624	U/C RESP H	U/C RH
625	U/C RESP V	U/C RV
626	D/C ENH H	D/C EH
627	D/C ENH V	D/C EV
628	U/C ENH H	U/C EH
629	U/C ENH V	U/C EV
630	1080i→HD_OUT	1080HO
631	1080i→SD_OUT	1080SO
632	720p→HD_OUT	720pHO
633	720p→SD_OUT	720pSO

Setup menu item No.	Name of setup menu item	Function button name
634	480p→HD_OUT	480pHO
635	480p→SD_OUT	480pSO
636	480i→HD_OUT	480iHD
637	480i→SD_OUT	480iSD
638	IN U/C MODE	IUC MD
639	I U/C RESP H	IUC RH
640	I U/C RESP V	IUC RV
641	I U/C ENH H	IUC EH
642	I U/C ENH V	IUC EV
650	STYLE	STYLE
651	HUE STYLE (SD)	HUE S
653	Y LVL (HD)	Y HD
654	Pb LVL (HD)	Pb HD
655	Pr LVL (HD)	Pr HD
656	BK LVL (HD)	BK HD
658	Y LVL (SD)	Y SD
659	Pb LVL (SD)	Pb SD
660	Pr LVL (SD)	Pr SD
661	BK LVL (SD)	BK SD
662	V LEVEL	V LV
663	C LEVEL	C LV
664	HUE (C PHASE)	HUE
665	SETUP (BK) LVL	SUP LV
670	BRIGHT	BR
671	R-BRIGHT	R-BR
672	B-BRIGHT	B-BR
673	CONTRAST	CT
674	R-CONTRAST	R-CT
675	B-CONTRAST	B-CT
676	BLK CLIP	B LIP
680	CC (F1) BLANK	CC1 BK
681	CC (F2) BLANK	CC2 BK
684	EDH (SD)	EDH SD
685	ESR MODE (SD)	ESR SD
686	CCR MODE (SD)	CCR SD
687	SDI INDEX O	SDI IX
688	CC REC	CC REC
695	BLANK LINE	BK L

# Function menus

## <PF1/PF2>

Setup menu item No.	Name of setup menu item	Function button name
700	CH1 IN LV	A1 ILV
701	CH2 IN LV	A2 ILV
702	CH3 IN LV	A3 ILV
703	CH4 IN LV	A4 ILV
704	CUE IN LV	AC ILV
705	CH1 OUT LV	A1 OLV
706	CH2 OUT LV	A2 OLV
707	CH3 OUT LV	A3 OLV
708	CH4 OUT LV	A4 OLV
709	CUE OUT LV	AC OLV
710	MONIL OUT LV	ML OLV
711	MONIR OUT LV	MR OLV
712	MONI OUT	MONI O
713	CH1 IN SEL	A1 IN
714	CH2 IN SEL	A2 IN
715	CH3 IN SEL	A3 IN
716	CH4 IN SEL	A4 IN
717	CH5 IN SEL	A5 IN
718	CH6 IN SEL	A6 IN
719	CH7 IN SEL	A7 IN
720	CH8 IN SEL	A8 IN
721	D IN SEL12	DIN 12
722	D IN SEL34	DIN 34
723	D IN SEL56	DIN 56
724	D IN SEL78	DIN 78
725	REC CH1	REC A1
726	REC CH2	REC A2
727	REC CH3	REC A3
728	REC CH4	REC A4
729	REC CH5	REC A5
730	REC CH6	REC A6
731	REC CH7	REC A7
732	REC CH8	REC A8
733	REC CUE	RECCUE
734	PB FADE	PB FD
735	HD EMBD AUD	HDEM A
736	SD EMBD AUD	SDEM A
737	MONI MIX	M MIX
738	CH1 CUE SEL	A1 CSL
739	CH2 CUE SEL	A2 CSL
740	CH3 CUE SEL	A3 CSL
741	CH4 CUE SEL	A4 CSL

Setup menu item No.	Name of setup menu item	Function button name
742	CH5 CUE SEL	A5 CSL
743	CH6 CUE SEL	A6 CSL
744	CH7 CUE SEL	A7 CSL
745	CH8 CUE SEL	A8 CSL
746	MONI CH SEL	MON CH
747	MON AUTO SEL	MON AT
748	MONI SEL INH	MS INH
749	AUDIO PB VR	APB VR
750	ANA CH1 SEL	AA1 SL
751	ANA CH2 SEL	AA2 SL
752	ANA CH3 SEL	AA3 SL
753	ANA CH4 SEL	AA4 SL
754	SD SDI CH1 SL	SSA1SL
755	SD SDI CH2 SL	SSA2SL
756	SD SDI CH3 SL	SSA3SL
757	SD SDI CH4 SL	SSA4SL
758	JOG PROC	JOG P
759	DV PB ATT	DV ATT
760	REC PT MUTE	R PTMT
761	AUDIO INT SG	A INSG
762	AUD RATE CON	A RC
763	METER SCALE	M SCL
790	CUE REC VOL	CR VOL
791	CUE PB VOL	CP VOL
A02	P.ON LOAD	P.LOAD

# Function menus

## <CARD>

The settings and information can be saved onto or loaded from the IC card memory. When [F2] (CARD) is pressed on the <MENU> screen while the [F] button is held down, the function menu shown below is displayed.

### [MENU/ERROR LOG/MULTI CUE]

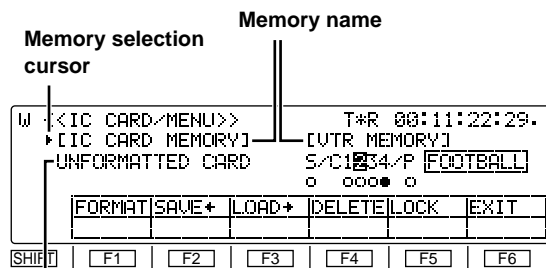

Warning message 1

### SYSTEM MENU/SETUP MENU/50PIN ASSIGN

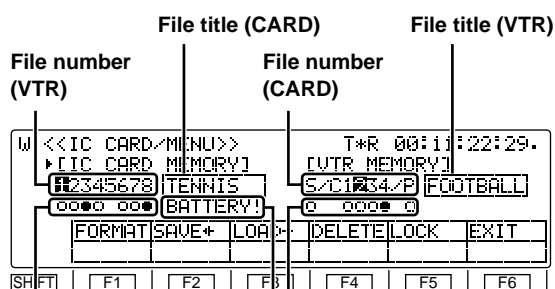

Warning message 2

### MULTI CUE

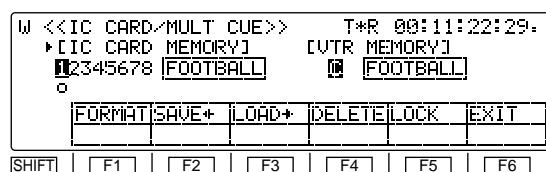

### ERROR LOG

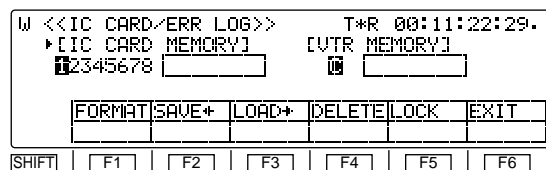

### <Notes>

- IC cards are not compatible with other VTR models.
- The IC cards which can be used are the 68-pin two-piece type of SRAM cards (64KB or more) with replaceable battery. Model number BN-064HSR is recommended.

### Warning message 1

Warnings concerning the IC card are displayed here.

#### NO CARD

The IC card has not been inserted.

#### UNFORMATTED CARD

The IC card is not formatted.

#### HD150 FORMAT!

This card was formatted by the AJ-HD150.

#### HD150 FORMAT!

This card was formatted by the AJ-HD1500.

### Warning message 2

#### BATTERY!

This appears when the battery inside the IC card has no charge left. It signifies that it is time to replace the battery.

#### PROTECT!

The IC card protection is set to ON.

### File status

	File status (CARD)	File status (VTR)
Blank	No storage files are present.	-----
○	Storage files are present. (Unlocked status)	The target file is in the unlocked status.
●	Storage files are present. (Locked status)	The target file is in the locked status.

# Function menus

## <CARD>

### [MENU/ERROR LOG/MULTI CUE]

IC card data layout	Lock		VTR memory data layout	Lock	
SETUP MENU	1	○ ↔	SETUP MENU (what has been registered for the PF1, PF2 menu items, contents of some function buttons)	Current	×
	2			USER1	○
	3			USER2	○
	4			USER3	○
	5			USER4	○
	6				
	7				
	8				
50 PIN ASSIGN	1	○ ↔	50 PIN ASSIGN	Current	○
	2				
	3				
	4				
	5				
	6				
	7				
	8				
SYSTEM MENU	1	○ ↔	SYSTEM MENU	Current	○
	2				
	3				
	4				
	5				
	6				
	7				
	8				

IC card data layout	Lock		VTR memory data layout	Lock	
MULTI CUE	1	○ ↔	MULTI CUE	Current	×
	2				
	3				
	4				
	5				
	6				
	7				
	8				
ERROR LOG	1	○ ↔	ERROR LOG	Current	×
	2				
	3				
	4				
	5				
	6				
	7				
	8				

- The SETUP MENU (current, USER1 to USER4) and SYSTEM MENU settings, 50PIN ASSIGN registration data, MULTI CUE registered points and ERROR LOG data in the VTR MEMORY in this VTR can be saved in and loaded from the IC cards.
- Titles can be provided for all the data files, and when the files are saved or loaded, the titles are also copied at the same time.
- For those data files which have been saved in the IC card, a file lock facility can be engaged to prevent the data in those files from being overwritten.

## Settings

### 1. Selecting the targeted memory

Press the **SHIFT** button.

The operation target is switched alternately between the IC CARD MEMORY and VTR MEMORY.

### 2. Selecting the operation files inside the selected memory

The number of the currently selected file is highlighted.

Turn the ADJ dial to select the file to be operated.

- For SYSTEM MENU, SETUP MENU and 50PIN ASSIGN

The details of the registration status display for the IC CARD MEMORY are automatically switched depending on whether S (SYSTEM MENU), C1234 (SETUP MENU) or P (50PIN ASSIGN) is selected at the VTR MEMORY side.

### 3. Transferring files between memories

- **VTR MEMORY → IC CARD MEMORY**

First select the operation file, and then press **F2** (SAVE).

- **IC CARD MEMORY → VTR MEMORY**

First select the operation file, and then press **F3** (LOAD).

#### <Note>

The title is also transferred at the same time.

# Function menus

## <CARD>

### 4. Editing the title of a selected file

First select the operation file, and then press the ADJ dial.

The first digit of the title display area is highlighted, indicating that the file title can now be edited.

- To input a number, press the number keys.
- To input letters, tap the numbers keys until the letter to be input appears while holding down the **[F]** button.

More than one letter is allocated to each number key.

- Press the ADJ dial to move from one digit to the next on the title display area.
- To enter the title, press the ADJ dial again.

#### <Notes>

- When the display screen has been switched or the **[C]** button has been pressed during title editing, the editing enable status is canceled, and the setting becomes invalid.
- A space can be input by pressing the **[F]** button and **[3]** button.

### 5. File overwrite inhibit facility

It is possible to lock the overwrite inhibit facility for individual files in the IC CARD MEMORY.

- **Locking a file**  
Select the file to be locked, and press **[F5]** (LOCK).
- **Unlocking a file**  
Press **[F5]** (LOCK) again.

#### <Note>

The locked or unlocked status is displayed in the file status.

[○]: Unlocked status, [●]: locked status]

Function button/item	Switching method	Setting	Corresponding setup menu item	Description of setting
F1 FORMAT	F+Press	_____	_____	For formatting the IC card.
F2 SAVE←	Press	_____	_____	For transferring data to the IC card files.
F3 LOAD→	Press	_____	_____	For transferring data from the IC card files.
F4 DELETE	F+Press	_____	_____	For deleting IC card files.
F5 LOCK	Press	_____	_____	For locking IC card files or VTR MEMORY files.a
F6 EXIT	_____	_____	_____	_____
F1 (SHIFT) F2 (SHIFT) F3 (SHIFT) F4 (SHIFT) F5 (SHIFT) F6 (SHIFT) _____	_____	_____	_____	_____

# Function menus

## <50P IN/OUT ASSIGN>

Using the front panel controls and on-screen menus, functions are registered into the input pins of the parallel remote (50PIN) connector and the statuses are registered into its output pins.

When [F5] (50P IN) or [F6] (50P OT) is pressed while the [F] button is held down on the <MENU SHIFT> menu, the function menu shown below appears, and functions can be registered or deleted.

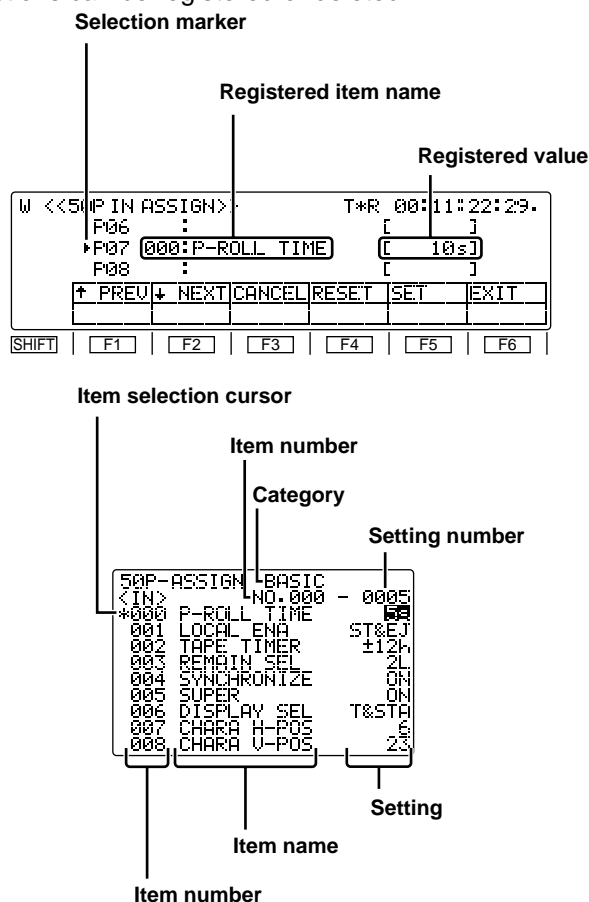

### Registered item names

Setup menu items and 50PIN special menu items can be registered in the parallel remote connector pins, and the names of these menu items are displayed.

### Registered values

One setting for the registered menu item is displayed in each of the pins.

When active signals are input to the IN pins in which the setup menu items mentioned above have been registered, the settings for the registered menu items take effect inside the VTR.

When the settings for the registered menu items tally with the registered values, active signals are output from the registered OUT pins.

### Pins in which functions can be registered

IN pins: Pins 6 to 20, 22, 23, 25

OUT pins: Pin 21, 24, pins 32 to 46, 48

All other pins are reserved and cannot be changed.

IN pins		OUT pins	
		21	Range of pins to which any items can be assigned
		24	
		26	
1	REC	27	REC
2	PLAY	28	PLAY
3	FF	29	FF
4	REW	30	REW
5	STOP	31	STOP
6	Range of pins to which any items can be assigned	32	Range of pins to which any items can be assigned
↑		↑	
↓		↓	
20		46	
22		48	
23			
25			
		47	<GND>
		49	<GND>
		50	<GND>

### Items which can be registered in the input and output pins

Items identical to the setup menu items can be registered in both the input and output pins. In addition, there are a set of special items can be also registered in the input pins and another set for the output pins.

#### <Note>

System menu and submenu items cannot be registered.

Item no.	Registration in input pins	Registration in output pins
000	Setup menu list	
100		
200		
300		
400		
500		
600		
700		
B00	Special IN menu list	<No display>
C00	<No display>	Special OUT menu list



# Function menus

## <50P IN/OUT ASSIGN>

### Registering functions in the input pins/Active inputs

### Registering functions in the output pins/Active outputs

#### 1. Selecting the 50-pin connector pins

Turn the ADJ dial to move the selection marker and select the pin of the 50-pin connector into which the menu item is to be registered.

#### 2. Entering the 50-pin connector pins

Press the ADJ dial.  
The entered 50-pin connector pin display is highlighted.

#### 3. Selecting the menu item

Turn the ADJ dial and select the menu item for the pin of the 50-pin connector which was selected in step 1 above.

#### 4. Entering the menu item

Press the ADJ dial.  
The on-screen setting display now blinks.

#### 5. Selecting the setting

Turn the ADJ dial and select the setting for the menu item which was selected in step 3 above.

#### 6. Entering the setting

Press the ADJ dial.  
What is to be operated by the ADJ dial returns to the front panel. Whatever was selected in step 3 is displayed as the registered item name and whatever was selected in step 5 is displayed as the registered value.

7. To select menu items and settings for other 50-pin connector pins, repeat steps 1 to 6.

#### 8. Saving the data in the 50-pin registration file

To save what has been set in the 50-pin connector in the 50-pin registration file, press **[F5]** (SET).  
If **[F6]** (EXIT) is pressed without the above settings have been saved, those settings will be canceled.

## Clearing

1. Turn the ADJ dial to move the selection marker and select the pin of the 50-pin connector whose menu item is to be cleared.

2. Press **[F4]** (RESET). The registered item name and registered value displays now go blank.

3. To clear the menu items in other 50-pin connector pins, repeat steps 1 and 2.

4. To save what has been set in the 50-pin connector in the 50-pin registration file, press **[F5]** (SET).  
If **[F6]** (EXIT) is pressed without the above settings have been saved, those settings will be canceled.

## Resetting all the items and values

Press **[F4]** (RESET) while holding down the **[F]** button. All the registered item names and registered values are now set to the factory settings. (These settings cannot be restored.)

### Special IN menu list

No. SUPER DISPLAY	Description of setting
<b>Functions not featured on the setup menu</b>	
<b>B00 STBY ON</b>	For transferring to the STANDBY ON mode.
<b>B01 STBY OFF</b>	For transferring to the STANDBY OFF mode.
<b>B02 STBY ONOFF</b>	For alternately transferring to the STANDBY ON and OFF mode.
<b>B03 EJECT</b>	For transferring to the EJECT mode.
<b>B04 CUE</b>	For prerolling the tape to the IN point when the IN point has been registered; for prerolling the tape to the current point when the IN point has not been registered.
<b>B05 IN SET</b>	For registering the edit IN point.
<b>B06 STILL</b>	For transferring to the still picture (STILL) mode.
<b>B07 422 REM ON</b>	The 9-pin connector functions.
<b>B08 422 REM OFF</b>	The 9-pin connector does not function.
<b>B09 TC EXT</b>	For returning TC SOURCE to the previous EXT mode. (No switching occurs if the EXT mode is currently established.)
<b>B10 TC INT AUTO</b>	For switching TC SOURCE to INT and TCG MODE to AUTO.
<b>B11 TC EXT_L REG</b>	For switching TC SOURCE to EXT_L and TCG MODE to REGEN.
<b>SRC PROTECT and STOP PROTECT settings switched simultaneously</b>	
<b>B20 PROTECT HALF</b>	For switching the tape protection mode operation to half-loading in the event that the VTR has been left standing in the STOP mode or the STILL mode while any of the search modes (JOG, VAR or SHTL) was established.
<b>B21 PROTECT T-REL</b>	For switching the tape protection mode operation to tension release when the VTR has been left standing in the STOP mode or the STILL mode while any of the search modes (JOG, VAR or SHTL) was established.

# Function menus

## <50P IN/OUT ASSIGN>

### Special IN menu list (continued)

No. SUPER DISPLAY	Description of setting
UPCON MODE and DOWNCON MODE settings switched simultaneously	
B22 UD FIT_V	For switching the picture angle during down-conversion to letter box and the picture angle during up-conversion to the top/bottom cut status in the vertical direction.
B23 UD FIT_H	For switching the picture angle during down-conversion to the side cut mode and the picture angle during up-conversion to the side panel mode.
B24 UD FIT_HV	For switching the picture angle during down-conversion to the squeeze mode and the picture angle during up-conversion to the stretch mode.

### Special OUT menu list

No. SUPER DISPLAY	Description of setting
C00 EJECT	EJECT status
C01 STBY ON	STANDBY ON status
C02 CUE	CUE-UP completed status
C03 STILL	STILL status
C04 PANEL STOP	Status in which the front panel STOP button is pressed down
C05 PRE CTL	Status of whether to inhibit overwrite during normal recording
C06 422 REM ON	9-pin connector function status
C07 REMOTE	50-pin connector function status
C08 REC INH1	Recording inhibit status 1
C09 REC INH2	Recording inhibit status 2
C10 CAS INH1	Tape recording inhibit status 1
C11 CAS INH2	Tape recording inhibit status 2
C12 TC SRC1	TC input status 1
C13 TC SRC2	TC input status 2
C14 DC1	Down-conversion status 1
C15 DC2	Down-conversion status 2

No. SUPER DISPLAY	Description of setting
C16 DC3	Down-conversion status 3
C17 UC1	Up-conversion status 1
C18 UC2	Up-conversion status 2
C19 UD1	Up-conversion/down-conversion status 1
C20 UD2	Up-conversion/down-conversion status 2
C21 UD3	Up-conversion/down-conversion status 3
C22 ERR0	Error status 0
C23 ERR1	Error status 1
C24 ERR2	Error status 2
C26 CH GREEN	Channel condition green LED
C27 CH AMBER	Channel condition amber LED
C28 CH RED	Channel condition red LED
C29 SERVO LOCK	Servo lock LED
C30 V UNITY	Video UNITY LED
C31 A UNITY	Audio UNITY LED

# Function menus

## <50P IN/OUT ASSIGN>

The statuses established by a multiple number of pins in the special OUT menu list are displayed. Pin status "1" signifies "active low" and "0" signifies "open."

### Error statuses

C22 ERR0	C23 ERR1	C24 ERR2	Error status
0	0	0	SERVO NOT LOCKED (priority level 1)
0	0	1	SERVO LOCKED (priority level 4)
0	1	0	HIGH ERROR (amber) (priority level 3)
0	1	1	HIGH ERROR (red) (priority level 2)

### TC input statuses

C12 TC SRC1	C13 TC SRC2	TC input status
0	0	External SLTC
0	1	External LTC
1	0	External SVITC (or external VITC with SD input)
1	1	INT

### Tape recording inhibit statuses

C10 CAS INH1	C11 CAS INH2	Tape recording inhibit status
0	0	Cassette recording enabled
0	1	Cassette accidental erasure prevented

### Recording inhibit statuses

C08 REC INH1	C09 REC INH2	Recording inhibit statuses
0	0	Overwriting prohibited during normal recording
0	1	All recording onto cassette prohibited
1	0	Recording inhibit mode other than the 2 above modes
1	1	Recording onto cassette enabled

### Down-conversion statuses

C14 DC1	C15 DC2	C16 DC3	Down-conversion status
0	0	0	Squeeze mode
0	1	0	Side cut mode
1	0	0	Letter box mode
1	1	0	14:9
1	1	1	13:9

### Up-conversion statuses

C17 UC1	C18 UC2	Up-conversion status
0	0	Stretch mode
0	1	Side panel mode
1	0	Top and bottom cut in vertical direction

### Up-conversion down-conversion statuses

C19 UD1	C20 UD2	C21 UD3	Down-conversion status	Up-conversion status
0	0	0	Squeeze mode	Stretch mode
0	1	0	Side cut mode	Side panel mode
1	0	0	Letter box mode	Top and bottom cut in vertical direction
1	1	1	Any other combination	

# Function menus

## <50P IN/OUT ASSIGN>

### Flow of registration

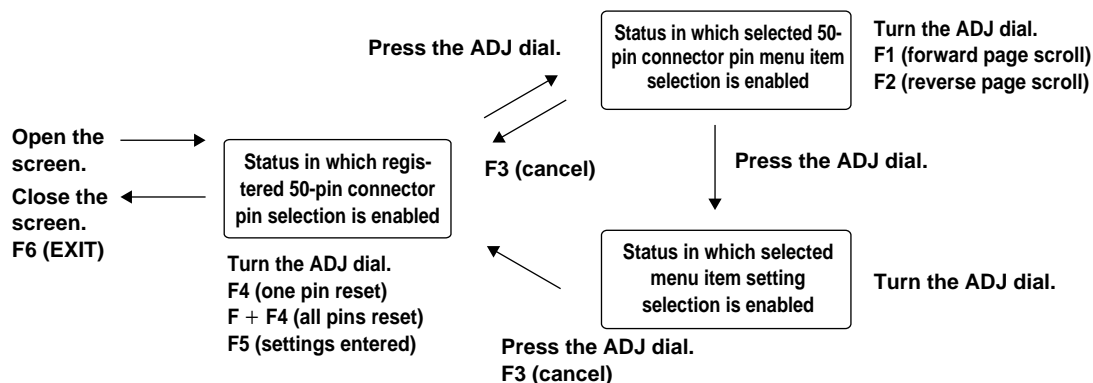

### 50P IN/OUT ASSIGN function buttons

Function button/item	Switching method	Setting	Corresponding setup menu item	Description of setting
F1 ↑ PREV	Press	_____	_____	For scrolling the on-screen menu pages in the forward direction.
F2 ↓ NEXT	Press	_____	_____	For scrolling the on-screen menu pages in the reverse direction.
F3 CANCEL	Press	_____	_____	For releasing the menu item selection status.
F4 RESET	Press	_____	_____	For resetting one pin: what has been selected for the pin selected by the individual reset selection marker is cleared.
	F+Press	_____	_____	For resetting all the pins: what has been registered in all the pins is set to the factory settings and set in the 50-pin registration file.
F5 SET	Press	_____	_____	For registering the file; all the function button settings are saved in the 50-pin registration file.
F6 EXIT	Press	_____	_____	For exiting the special menu (and transferring to the original menu).
F1 (SHIFT) F2 (SHIFT) F3 (SHIFT) F4 (SHIFT) F5 (SHIFT) F6 (SHIFT)	_____	_____	_____	_____

# Function menus

## <50P IN/OUT ASSIGN>

### 50-pin assignment factory settings

Pin no.	I/O	Setting item
1	I	REC
2	I	PLAY
3	I	FF
4	I	REW
5	I	STOP
6	I	_____
7	I	_____
8	I	422 REMOTE ON
9	I	422 REMOTE OFF
10	I	LOCAL ENABLE
11	I	EJECT
12	I	IN SET
13	I	REC INH ALL
14	I	REC INH PRE
15	I	LOCAL DISABLE
16	I	TC EXT
17	I	TC INT&TCG MODE AUTO
18	I	_____
19	I	_____
20	I	STNDBY ON/OFF
21	O	ERR0 STATUS
22	I	DET STOP ON
23	I	CUE
24	O	ERR1 STATUS
25	I	DET STOP OFF
26	Power	
27	O	REC STATUS
28	O	PLAY STATUS
29	O	FF STATUS
30	O	REW STATUS
31	O	STOP STATUS
32	O	422 REMOTE STATUS
33	O	EJECT STATUS
34	O	ERR2 STATUS
35	O	TC SRC1 STATUS
36	O	TC SRC2 STATUS
37	O	_____
38	O	_____
39	O	REC INH1 STATUS
40	O	REC INH2 STATUS

Pin no.	I/O	Setting item
41	O	CUE STATUS
42	O	REMOTE STATUS
43	O	DET STOP STATUS
44	O	PRE CTL DETECTED STATUS
45	O	LOCAL ENABLE STATUS
46	O	STANDBY ON STATUS
47	GND	
48	O	_____
49	GND	
50	GND	

“—” denotes that nothing is subject to control or to a status.

#### <Notes>

- For a command, input TTL level signals; for an active low edge, input an electrical signal of 100 ms or more.
- For a status, a maximum open collector and sink current of 6 mA is output.

# System menus

No./Item	Description of setting
00 WFM SEL	<p>This enables one of a number of different signals to be output from the VIDEO OUT 2 output connector.</p> <p>0000 CTL: The CTL signal is output.            0001 TC: The time code signal is output.            0002 VIDEO: The video output signal is output.            0003 RF_L: The PB L RF signal is output.            0004 RF_R: The PB R RF signal is output.            0005 ENV_L: The PB L ENV signal is output.            0006 ENV_R: The PB L ENV signal is output.</p> <p><b>&lt;Notes&gt;</b></p> <ul style="list-style-type: none"> <li>The setting can be changed at any time without being affected by the system menu item No.30 (MENU LOCK) setting.</li> <li>The output signals during normal playback virtually maintain the levels given below.            CTL: 0.1 to 0.3Vp-p TC: 0.6Vp-p            VIDEO: 1.0Vp-p</li> </ul>
05 ENCODER SEL	<p>For setting whether to perform the various adjustments for the video output signals using this VTR or using an external encoder remote controller.</p> <p>0000 REMOTE:            The various adjustments for the video output signals are performed by an external encoder remote controller.</p> <p>0001 LOCAL:            The various adjustments for the video output signals are performed using this VTR.</p> <p>0002 BOTH:            The various adjustments for the video output signals are performed using both this VTR and an external encoder remote controller.</p>
06 V LEVEL CTRL	<p>For selecting what is to be controlled when the video output level is to be adjusted by an external encoder remote controller.</p> <p>0000 HD:            The HD video output level can be adjusted.</p> <p>0001 SD:            The SD video output level can be adjusted.</p> <p>0002 BOTH:            Both the HD and SD video output levels can be adjusted.</p>

## Video output signal adjustments

The control matrix for the adjustments is shown in the table below.

When "CMPNT" has been selected as the setup menu item No.650 (STYLE) setting

Setting		Adjustment item	
05: ENCODER SEL	06: V LEVEL CTRL	653: Y LVL (HD) 654: Pb LVL (HD) 655: Pr LVL (HD) 656: BK LVL (HD)	658: Y LVL (SD) 659: Pb LVL (SD) 660: Pr LVL (SD) 661: BK LVL (SD)
REMOTE	HD	External encoder remote controller	No adjustments possible
	SD	No adjustments possible	External encoder remote controller
	BOTH	External encoder remote controller	External encoder remote controller
LOCAL	HD	AJ-HD1700	AJ-HD1700
	SD		
	BOTH		
BOTH	HD	External encoder remote controller/AJ-HD1700	AJ-HD1700
	SD	AJ-HD1700	External encoder remote controller/AJ-HD1700
	BOTH	External encoder remote controller/AJ-HD1700	External encoder remote controller/AJ-HD1700

**External encoder remote controller:** Only adjustments of the external encoder remote controller are performed.

**AJ-HD1700:** Only adjustments of the setup menu items are performed.

**External encoder remote controller/AJ-HD1700:** Adjustments can be performed from both the external encoder remote controller and setup menus.

**<Note>**

Use the AJ-ER50, an optional accessory, as the external encoder remote controller. However, its VIDEO PHASE and SYNC PHASE controls will not work.

When "CMPST" has been selected as the setup menu item No.650 (STYLE) setting

Setting		Adjustment item	
05: ENCODER SEL	06: V LEVEL CTRL	662: V LEVEL 663: C LEVEL 664: HUE ( or C PHASE) 665: SETUP LVL (or BK LVL)	
REMOTE	HD	External encoder remote controller	
	SD		
	BOTH		
LOCAL	HD	AJ-HD1700	
	SD		
	BOTH		
BOTH	HD	External encoder remote controller/AJ-HD1700	
	SD		
	BOTH		

**External encoder remote controller:** Only adjustments of the external encoder remote controller are performed.

**AJ-HD1700:** Only adjustments of the setup menu items are performed.

**External encoder remote controller/AJ-HD1700:** Adjustments can be performed from both the external encoder remote controller and setup menus.

**<Note>**

Use the MT-200 (manufactured by Musashi and recommended by Panasonic) as the external encoder remote controller. However, its VIDEO PHASE, SYNC PHASE and SC PHASE controls will not work.

The underlining (      ) denotes the factory setting mode.

# System menus

No./Item	Description of setting
<b>12</b> <b>SYS H (HD)*UP</b>	For adjusting the system phase of the HD SDI output. When the [SHIFT] button is pressed, the display transfers to the submenu screen; press the [SHIFT] button again to return the display from the submenu screen.
<b>Submenu screen</b>	
<b>00</b> <b>COARSE</b>	For adjusting the system phase of the HD SDI output in 1H steps. -: To advance the phase. +: To delay the phase. 0000 -5H : : <Note> 0005 0H This setting remains unchanged : : even when the factory setting 0010 5H operation is performed.
<b>01</b> <b>FINE</b>	For adjusting the HD SDI output system phase in 13.5ns steps. -: To advance the phase. +: To delay the phase.  <59/60Hz> <23/24Hz> <50Hz, 25Hz (HD,SD)> 0000 -1100 0000 -1375 0000 -1320 : : : : : : 1100 0 1375 0 1320 0 : : : : : : 2200 1100 2700 1375 2640 1320  <Note> This setting remains unchanged even when the factory setting operation is performed.
<b>14</b> <b>SYS SC (SD)*DW</b>	For adjusting the system phase over a total variable range of more than ±180°. -: To advance the phase. +: To delay the phase.  <59/60Hz, 23/24Hz> <50Hz, 25Hz (HD, SD)> 0000 -108 0000 -115 : : : : 0108 0 0115 0 : : : : 0216 108 0230 115  <Note> This setting remains unchanged even when the factory setting operation is performed.

No./Item	Description of setting
<b>15</b> <b>VO SYS H (SD)*DW</b>	For adjusting the system phase of the VIDEO OUT. When the [SHIFT] button is pressed, the display transfers to the submenu screen; press the [SHIFT] button again to return the display from the submenu screen.
<b>Submenu screen</b>	
<b>00</b> <b>COARSE</b>	For adjusting the VIDEO OUT system phase in 1H steps. -: To advance the phase. +: To delay the phase. 0000 -5H : : <Note> 0005 0H This setting remains unchanged : : even when the factory setting 0010 5H operation is performed.
<b>01</b> <b>FINE</b>	For adjusting the VIDEO OUT system phase in 37ns steps. -: To advance the phase. +: To delay the phase.  <59/60Hz, 23/24Hz> <50Hz, 25Hz (HD, SD)> 0000 -858 0000 -864 : : : : 0858 0 0864 0 : : : : 1716 858 1728 864  <Note> This setting remains unchanged even when the factory setting operation is performed.
<b>16</b> <b>SD SYS H (SD)*DW</b>	For adjusting the system phase of the SD SDI. When the [SHIFT] button is pressed, the display transfers to the submenu screen; press the [SHIFT] button again to return the display from the submenu screen.
<b>Submenu screen</b>	
<b>00</b> <b>COARSE</b>	For adjusting the SD SDI system phase in 1H steps. -: To advance the phase. +: To delay the phase. 0000 -5H : : <Note> 0005 0H This setting remains unchanged : : even when the factory setting 0010 5H operation is performed.
<b>01</b> <b>FINE</b>	For adjusting the SD SDI system phase in 37ns steps for 480i outputs and in 54ns steps for 480p outputs. -: To advance the phase. +: To delay the phase.  <59/60Hz, 23/24Hz> <50Hz, 25Hz (HD, SD)> 0000 -858 0000 -864 : : : : 0858 0 0864 0 : : : : 1716 858 1728 864  <Note> This setting remains unchanged even when the factory setting operation is performed.

The underlining (     ) denotes the factory setting mode.

\*UP: This is for HD outputs (during HD tape playback or up-conversion outputs).

\*DW: This is for SD outputs (during SD tape playback or down-conversion outputs).

# System menus

No./Item	Description of setting										
<b>18</b> <b>SCH (SD)*DW</b>	<b>For adjusting the SCH phase.</b> When the <b>SHIFT</b> button is pressed, the display transfers to the submenu screen; press the <b>SHIFT</b> button again to return the display from the submenu screen.										
<b>Submenu screen</b>											
<b>00</b> <b>COARSE</b>	<b>For adjusting the SCH phase in 90° steps</b> (The SC phase changes, and the H phase remains unchanged.) <b>0000:</b> <b>0</b> <b>0001:</b> <b>90</b> <b>0002:</b> <b>180</b> <b>0003:</b> <b>270</b>										
<b>01</b> <b>FINE</b>	<b>For adjusting the SCH phase over a total variable range of more than ±45°.</b> -: To advance the phase.   +: To delay the phase. (The SC phase changes, and the H phase remains unchanged.) <b>0000</b> <b>-32</b> : <b>0032</b> <b>0</b> : <b>0064</b> <b>32</b>										
<b>20</b> <b>AV PHASE</b>	<b>For adjusting the audio output phase in relation to the video output phase in 20.8µs steps.</b> -: The audio output phase is advanced in relation to the video output phase. +: The audio output phase is delayed in relation to the video output phase. <b>0000</b> <b>-100</b> : <b>0100</b> <b>0</b> : <b>0200</b> <b>100</b>										
<b>25</b> <b>SYSTEM FREQ*</b>	<b>For selecting the system frequency.</b> 0: The 59.94 Hz or 60 Hz system frequency is selected. 1: The 50 Hz system frequency is selected. 2: The 23.98 Hz or 24 Hz system frequency is selected. 3: The 25 Hz system frequency is selected. However, with SD SDI and video output signals, there is a delay of approximately one field compared with the HD SDI output. 4: The 25 Hz system frequency is selected. However, HD SDI output is muted. <b>0003</b> <b>59/60</b> <b>0001*</b> <b>50*</b> * The asterisk denotes the factory setting for AJ- <b>0002</b> <b>23/24</b> <b>HD1700E</b> <b>0003</b> <b>25 (HD)</b> <b>0004</b> <b>25 (SD)</b>										
<table border="1"> <tr> <td>59/60 Hz mode:</td> <td>Status in which "0" (59/60) has been selected</td> </tr> <tr> <td>50 Hz mode:</td> <td>Status in which "1" (50) has been selected</td> </tr> <tr> <td>23/24 Hz mode:</td> <td>Status in which "2" (23/24) has been selected</td> </tr> <tr> <td>25 Hz (HD) mode:</td> <td>Status in which "3" (25 (HD)) has been selected</td> </tr> <tr> <td>25 Hz (SD) mode:</td> <td>Status in which "4" (25(SD)) has been selected</td> </tr> </table>		59/60 Hz mode:	Status in which "0" (59/60) has been selected	50 Hz mode:	Status in which "1" (50) has been selected	23/24 Hz mode:	Status in which "2" (23/24) has been selected	25 Hz (HD) mode:	Status in which "3" (25 (HD)) has been selected	25 Hz (SD) mode:	Status in which "4" (25(SD)) has been selected
59/60 Hz mode:	Status in which "0" (59/60) has been selected										
50 Hz mode:	Status in which "1" (50) has been selected										
23/24 Hz mode:	Status in which "2" (23/24) has been selected										
25 Hz (HD) mode:	Status in which "3" (25 (HD)) has been selected										
25 Hz (SD) mode:	Status in which "4" (25(SD)) has been selected										
<b>&lt;Notes&gt;</b>											
<ul style="list-style-type: none"> <li>This setting remains unchanged even when the factory setting operation is performed.</li> <li>For the steps to take to switch the system frequency, refer to page 105.</li> </ul>											

No./Item	Description of setting
<b>30</b> <b>MENU LOCK</b>	<b>For selecting whether to set or release the system file lock mode.</b> <b>0000</b> <b>OFF:</b> Lock released (changes enabled) <b>0001</b> <b>ON:</b> Lock set (changes prohibited) <b>&lt;Note&gt;</b> Even when "ON" is selected, the data will be overwritten when the system file has been set to LOAD from the IC card.

### \*System switching

- Some of the system menu and setup menu items each have different settings for different operation modes (59/60 Hz, 50 Hz, 23/24 Hz and 25 Hz (HD or SD)). These settings are saved separately.  
(This concerns those items whose settings were described for each operation mode on the system menu and setup menu tables.)
- For further details, refer to "How to switch the system frequency" on page 105.
- Since this VTR becomes a playback-only unit when the 23/24 Hz or 25 Hz (HD or SD) mode has been selected, the functions relating to EE, recording and editing are all set to the inhibited status. Neither is it possible to select CTL in such a case.  
(The related menus and function buttons are not displayed, and operation is prohibited.)  
For the instant when the tape begins to run at the 1× speed such as when it starts playing from the STOP status, the image is disrupted and the sound is muted for several frames because the tape is being synchronized with the REF input.

The underlining (     ) denotes the factory setting mode.

\*DW: This is for SD outputs (during SD tape playback or down-conversion outputs).



# Setup menus

## <BASIC>

No./Item	Description of setting
000 P-ROLL TIME	<p><b>For setting the preroll time.</b> Any time from 0 to 30 seconds can be set in 1-second increments.</p> <p>0000 0s : : 0005 5s : : 0030 30s</p> <p>&lt;Notes&gt;  <ul style="list-style-type: none"> <li>During automatic editing (PREVIEW or AUTO EDIT), no operations are performed if the preroll time is set to 0 seconds.</li> <li>If the phases are to be synchronized between two decks for editing as per the setup menu item No.004 (SYNCHRONIZE) setting, set the preroll time to at least 2 seconds.</li> </ul> </p>
001 LOCAL ENA	<p><b>For selecting the transport system buttons which can be operated on the front panel in the REMOTE mode.</b></p> <p>0000 DIS: No buttons can be operated. 0001 ST&amp;EJ: Only the STOP and EJECT buttons can be operated.</p> <p>0002 ENA: All the buttons except for the RECORDER and PLAYER buttons can be operated.</p> <p>&lt;Note&gt; The following buttons and dials function at all times regardless of this setting: Audio input/output level control dials, audio channel selector buttons, number keys, function buttons, direct menu button, ASSEM button, INSERT button, ADJ dial, headphone volume control dial, MONITOR SELECT button, METER (FULL/FINE) selector switch, REMOTE button.</p>
002*1 TAPE TIMER	<p><b>For selecting the 12- or 24-hour system for the CTL counter display.</b></p> <p>0000 ±12h: 12-hour system display 0001 24h: 24-hour system display</p>
003 REMAIN SEL	<p><b>For selecting whether or not to display REMAIN (remaining tape time) on the superimposed display of the HD SDI MONITOR, SD SDI MONITOR and VIDEO OUT3 connectors.</b></p> <p>0000 OFF: The remaining tape time is not displayed.</p> <p>0001 2L: The remaining tape time is displayed on the second line.</p> <p>0002 1L: The remaining tape time is displayed on the first line.</p> <p>0003 R/TTL: The remaining tape time is displayed on the first line, and the total tape time is displayed on the second line.</p> <p>&lt;Notes&gt;  <ul style="list-style-type: none"> <li>When setting 1 (2L) has been selected, the remaining tape time is not displayed if 0 (TIME) is selected as the setup menu item No.006 (DISPLAY SEL) setting.</li> <li>When setting 3 (R/TTL) has been selected, the remaining tape time is not displayed if 0 (TIME) is selected as the setup menu item No.006 (DISPLAY SEL) setting.</li> </ul> </p>

No./Item	Description of setting
004*1 SYNCHRONIZE	<p><b>For setting whether or not to synchronize the phases between two decks.</b></p> <p>0000 OFF: The phases are not synchronized. The edit points will be off by several frames but editing will be commenced more promptly.</p> <p>0001 ON: The phases are synchronized. Error-free editing can be performed.</p>
005 SUPER	<p><b>For selecting whether or not to superimpose the display of the time code or other data onto the HD SDI MONITOR, SD SDI MONITOR and VIDEO OUT3 connectors.</b></p> <p>0000 OFF: The time code or other data is not displayed.</p> <p>0001 ON: The time code or other data is displayed.</p>
006 DISPLAY SEL	<p><b>For selecting the time code and other displays to be superimposed onto the HD SDI MONITOR, SD SDI MONITOR and VIDEO OUT3 connectors.</b></p> <p>0000 TIME: Only the time is displayed.</p> <p>0001 T&amp;STA: The time and operation mode are displayed.</p> <p>0002 T&amp;S&amp;M: The time, operation mode and mode are displayed.</p> <p>0003 T&amp;RT: The time and REC TIME are displayed.</p> <p>0004 T&amp;YMD: The time and REC DATE (year/month/day) are displayed.</p> <p>0005 T&amp;MDY: The time and REC DATE (month/day/year) are displayed.</p> <p>0006 T&amp;DMY: The time and REC DATE (day/month/year) are displayed.</p> <p>0007 T&amp;UB: Data and user's bit are displayed. However, when UB has been selected with the <u>F3</u> (TC/CTL) on the HOME menu, the time code is displayed after the user's bit.</p> <p>0008 T&amp;CTL: Data and CTL data are displayed. However, when CTL has been selected with the <u>F3</u> (TC/CTL) on the HOME menu, the time code is displayed after the CTL data.</p> <p>0009 T&amp;T: Data and time code are displayed.</p> <p style="text-align: right;">(See Notes on next page.)</p>

\*1: This item is not displayed when the 23/24 Hz or 25 Hz (HD or SD) mode has been selected as the system menu item.

The underlining (     ) denotes the factory setting mode.

# Setup menus

## <BASIC> (continued)

No./Item	Description of setting	No./Item	Description of setting																					
006 DISPLAY SEL	<p>&lt;Notes&gt;</p> <ul style="list-style-type: none"> <li>The following mode displays appear depending on the format used.</li> </ul> <table border="0"> <tr> <td>&lt;Format&gt;</td> <td></td> <td>&lt;Display&gt;</td> </tr> <tr> <td>DVCPRO HD-LP</td> <td>→</td> <td>DVCPRO_HD-LP</td> </tr> <tr> <td>DVCPRO HD</td> <td>→</td> <td>DVCPRO_HD</td> </tr> <tr> <td>DVCPRO50</td> <td>→</td> <td>DVCPRO_50</td> </tr> <tr> <td>DVCPRO</td> <td>→</td> <td>DVCPRO</td> </tr> <tr> <td>DV</td> <td>→</td> <td>DV</td> </tr> <tr> <td>DVCAM</td> <td>→</td> <td>DVCAM</td> </tr> </table> <ul style="list-style-type: none"> <li>When setting 2 (T&amp;S&amp;M) is selected, an error message appears if a warning or error has occurred.</li> <li>REC TIME and REC DATE are displayed only during DV or DVCAM format playback. The operation mode is displayed when the DVCPRO HD-LP, DVCPRO HD, DVCPRO50 or DVCPRO format is used.</li> </ul>	<Format>		<Display>	DVCPRO HD-LP	→	DVCPRO_HD-LP	DVCPRO HD	→	DVCPRO_HD	DVCPRO50	→	DVCPRO_50	DVCPRO	→	DVCPRO	DV	→	DV	DVCAM	→	DVCAM	009 CHARA TYPE	<p>For setting the display type for the superimposed displays and for the HD SDI MONITOR, SD SDI MONITOR and VIDEO OUT3 connectors as well as for the SETUP MENU, etc.</p> <p><u>0000</u> <u>WHITE</u>: White characters on a black background.</p> <p>0001 <u>W/OUT</u>: White characters with black borders.</p>
<Format>		<Display>																						
DVCPRO HD-LP	→	DVCPRO_HD-LP																						
DVCPRO HD	→	DVCPRO_HD																						
DVCPRO50	→	DVCPRO_50																						
DVCPRO	→	DVCPRO																						
DV	→	DV																						
DVCAM	→	DVCAM																						
007 CHARA H-POS	<p>For setting the horizontal positions of the characters for the time code and other superimposed displays of the HD SDI MONITOR, SD SDI MONITOR and VIDEO OUT3 connectors.</p> <table border="0"> <tr> <td>0000</td> <td>0</td> </tr> <tr> <td>:</td> <td>:</td> </tr> <tr> <td><u>0006</u></td> <td><u>6</u></td> </tr> <tr> <td>:</td> <td>:</td> </tr> <tr> <td>0037</td> <td>37</td> </tr> </table> <p>&lt;Note&gt;</p> <p>When this menu item has been set, the displays are output to the VIDEO OUT3 connector in the DISPLAY SEL status even when the SUPER OFF setting is established. However, if the menu has been exited, the SUPER OFF or ON setting is followed. Furthermore, CHARA TYPE is output to the VIDEO OUT3 connector as per the menu setting.</p>	0000	0	:	:	<u>0006</u>	<u>6</u>	:	:	0037	37	010*1 MONI CONTROL	<p>For setting whether to forcibly set the recorder to the EE mode and output the player's playback signals to the monitor if the PLAYER button on the recorder is pressed when the monitor is connected only to the recorder during deck-to-deck editing.</p> <p><u>0000</u> <u>MANU</u>: The recorder is not forcibly set to the EE mode.</p> <p>0001 <u>AUTO</u>: The recorder is forcibly set to the EE mode, and the player's playback signals are output.</p>											
0000	0																							
:	:																							
<u>0006</u>	<u>6</u>																							
:	:																							
0037	37																							
008 CHARA V-POS	<p>For setting the vertical positions of the characters for the time code and other superimposed displays of the HD SDI MONITOR, SD SDI MONITOR and VIDEO OUT3 connectors.</p> <table border="0"> <tr> <td>0000</td> <td>0</td> </tr> <tr> <td>:</td> <td>:</td> </tr> <tr> <td><u>0023</u></td> <td><u>23</u></td> </tr> <tr> <td>:</td> <td>:</td> </tr> <tr> <td>0032</td> <td>32</td> </tr> </table> <p>&lt;Note&gt;</p> <p>When this menu item has been set, the displays are output to the VIDEO OUT3 connector in the DISPLAY SEL status even when the SUPER OFF setting is established. However, if the menu has been exited, the SUPER OFF or ON setting is followed. Furthermore, CHARA TYPE is output to the VIDEO OUT3 connector as per the menu setting.</p>	0000	0	:	:	<u>0023</u>	<u>23</u>	:	:	0032	32	011 CU-ROLL TIME	<p>For setting the preroll time in the MULTI CUE mode.</p> <p>Any time from 0 to 15 seconds can be set in 1-second increments.</p> <table border="0"> <tr> <td><u>0000</u></td> <td><u>0s</u>:</td> </tr> <tr> <td>:</td> <td>:</td> </tr> <tr> <td>0005</td> <td>5s:</td> </tr> <tr> <td>:</td> <td>:</td> </tr> <tr> <td>0015</td> <td>15s:</td> </tr> </table>	<u>0000</u>	<u>0s</u> :	:	:	0005	5s:	:	:	0015	15s:	
0000	0																							
:	:																							
<u>0023</u>	<u>23</u>																							
:	:																							
0032	32																							
<u>0000</u>	<u>0s</u> :																							
:	:																							
0005	5s:																							
:	:																							
0015	15s:																							
		015 AUTO STEP	<p>For selecting the save processing to be conducted when the memory capacity, which enables up to 99 warning messages to be saved, has been exceeded while the error log function is operating.</p> <p><u>0000</u> <u>OFF</u>: 99 messages are set as the upper limit, and any more warning messages which subsequently occur are not saved in the memory.</p> <p>0001 <u>ON</u>: 99 messages are saved, and the next warning message that has subsequently occurred is saved as No.99. The warning messages already saved are each shifted down by one number in succession.</p>																					
		020*2 SYS FORMAT	<p>For selecting the VTR's recording format.</p> <p><u>0000</u> <u>1080i</u>: The 1080i format is selected.</p> <p>0001 <u>720p</u>: The 720p format is selected.</p>																					

\*1: This item is not displayed when the 23/24 Hz or 25 Hz (HD or SD) mode has been selected as the system menu item No.25 (SYSTEM FREQ) setting.

\*2: This item is not displayed when the 23/24 Hz, 25 Hz (HD or SD) or 50 Hz mode has been selected as the system menu item No.25 (SYSTEM FREQ) setting.

The underlining (     ) denotes the factory setting mode.

# Setup menus

## <BASIC> (continued)

No./Item	Description of setting
<b>022</b> <b>PB FORMAT</b>	<b>For selecting the format in which the tape is to be played back.</b> <b>0000 MANU:</b> The format is determined by the setting selected for setup menu item No.023 (FORMAT SEL). <b>0001 AUTO:</b> The tape is played back in the format in which it was recorded.
<b>023</b> <b>FORMAT SEL</b>	<b>For selecting the format when "MANUAL" has been selected as the setup menu item No.022 (PB FORMAT) setting.</b> If "AUTO" is selected as the setting, the format when playback starts is selected, and when the tape is played back, the format is automatically detected and matched with the format of the playback tape. <b>0000 HD-LP:</b> The DVCPRO HD-LP format is selected, and the setup menu item No.020 (SYS FORMAT) setting is followed. <b>0001 HD-SP:</b> The DVCPRO HD format is selected, and the setup menu item No.020 (SYS FORMAT) setting is followed. <b>0002 422:</b> The DVCPRO50 (422) format is selected. <b>0003 411:</b> The DVCPRO (411) format is selected. <b>0004 420p:</b> The DVCPROP (420p) format is selected. <b>0005 DV:</b> The DV format is selected. <b>0006 DVCAM:</b> The DVCAM format is selected.
<b>030*3</b> <b>HD FREQUENCY</b>	<b>0000 59/23:</b> The 59.94/23.98 Hz frequency is set. <b>0001 60/24:</b> The 60/24 Hz frequency is set. However, the field frequency set here is used only when there is no input signal which corresponds to the OUT REF setting. If there is a corresponding input signal, the field frequency is matched with that of the input signal.
<b>031*4</b> <b>OUT REF</b>	<b>Video output reference</b> <b>0000 AUTO:</b> When the HD REF input signal is supplied, it is used as the reference. If it is not supplied but the SD REF input signal is supplied, the SD REF signal serves as the reference instead. If neither the HD REF nor SD REF input signal is supplied, the HD serial signal serves as the reference. If none of the HD REF, SD REF and HD serial signals are supplied, the internal sync signal serves as the reference. <b>0001 INPUT:</b> When the serial input signal is supplied, it is used as the reference. <b>0002 HD_REF:</b> The signal which is input to the HD REF IN connector is used as the reference. <b>0003 SD_REF:</b> The signal which is input to the SD REF IN connector is used as the reference. <b>&lt;Note&gt;</b> If the 1 (INPUT) setting is selected when the 25 Hz (HD) mode has been selected as the system menu item No.25 (SYSTEM FREQ) setting, the system will construe this to mean that the 0 (AUTO) setting has been selected.

## Formats in which the tape is played back

022: PB FORMAT	020: SYS FORMAT	023: FORMAT SEL	Playback format
MANUAL	1080i	HD_LP	DVCPRO HD-LP(1080i)
		HD_SP	DVCPRO HD(1080i)
		422	DVCPRO50(422)
		411	DVCPRO(411)
		420p	DVCPROP(420p)
		DV	DV
		DVCAM	DVCAM
	720p	HD_LP	DVCPRO HD-LP(720p)
		HD_SP	DVCPRO HD(720p)
		422	DVCPRO50(422)
		411	DVCPRO(411)
		420p	DVCPROP(420p)
		DV	DV
		DVCAM	DVCAM
AUTO	—	—	DVCPRO HD-LP(1080i)/ DVCPRO HD(1080i)/ DVCPRO HD-LP(720p)/ DVCPRO HD(720p)/ DVCPRO50(422)/ DVCPRO(411)/ DVCPROP(420p)/DV/ DVCAM, automatic detection

### <Notes>

- In the EJECT mode, the format selected by the setup menu item No.020 (SYS FORMAT) setting applies.
- If "AUTO" has been selected as the setup menu item No.022 (PB FORMAT) setting, the setup menu item No.023 (FORMAT SEL) setting is used as the format when the format is not detected (when the tape has just been inserted). However, when "DV" or "DVCAM" has been selected, the VTR operation will be as if "HD-LP" has been selected.

\*3: This item is not displayed when the 50 Hz or 25 Hz (HD or SD) mode has been selected as the system menu item No.25 (SYSTEM FREQ) setting.

\*4: This item is not displayed when the 23/24 Hz or 25 Hz (HD or SD) mode has been selected as the system menu item No.25 (SYSTEM FREQ) setting.

The underlining (    ) denotes the factory setting mode.

# Setup menus

## <OPERATION>

No./Item	Description of setting
100 <b>SEARCH ENA</b>	<b>For selecting the direct search dial operation.</b> <b>0000 DIAL:</b> Direct search dial operations are performed. <b>0001 KEY:</b> Operation does not transfer to the search mode unless the SHTL, JOG or VAR button is pressed.
101 <b>SHTL MAX</b>	<b>For selecting the maximum speed of shuttle operations.</b> <b>0000</b> ×9.8: ×9.8 times normal speed <b>0001</b> ×16: ×16 times normal speed <b>0002</b> ×32: ×32 times normal speed <b>&lt;Note&gt;</b> Depending on the tape format, the actual tape running speed differs slightly from what is indicated by the superimposed display.
102 <b>FF. REW MAX</b>	<b>For setting the maximum speed of fast forward and rewind operations.</b> <b>0000</b> ×16: ×16 times normal speed <b>0001</b> ×32: ×32 times normal speed <b>0002</b> ×50: ×50 times normal speed <b>0003</b> ×60: ×60 times normal speed <b>0004</b> ×100: ×100 times normal speed <b>&lt;Note&gt;</b> The maximum speed is automatically limited to 50x for the DVCPRO HD and DVCPRO50 format and to 32x for the DV and DVCAM formats.
104 <b>REF ALARM</b>	<b>For selecting whether a warning is to be displayed when the REF VIDEO signal has not been connected.</b> <b>0000 OFF:</b> A warning is not displayed. <b>0001 ON:</b> A warning is displayed by the blinking STOP lamp.
105*1 <b>AUTO EE SEL</b>	<b>For selecting the VTR mode which is to be set to the EE mode when "0 (EE)" is selected as the setup menu item No.140 (OUTPUT) setting.</b> <b>0000 S/F/R:</b> The EE mode is established when the VTR is in the STOP, FF or REW mode. <b>0001 STOP:</b> The EE mode is established when the VTR is in the STOP mode only.

\*1: This item is not displayed when the 23/24 Hz or 25 Hz (HD or SD) mode has been selected as the system menu item No.25 (SYSTEM FREQ) setting.

The underlining (   ) denotes the factory setting mode.

No./Item	Description of setting
106 <b>EJECT EE SEL</b>	<b>For selecting the video and audio output statuses in the EJECT mode.</b> <b>0000 EE:</b> The EE mode is always established regardless of the setup menu item No.140 (OUTPUT) setting. <b>0001 BLACK:</b> When setup menu item No.140 (OUTPUT) is set to: "EE": The EE mode is established. "TAPE": The BLACK mode is established for the video signals, and the audio signals are muted. <b>0002 GRAY:</b> When setup menu item No.140 (OUTPUT) is set to: "EE": The EE mode is established. "TAPE": The GRAY mode is established for the video signals, and the audio signals are muted. <b>&lt;Note&gt;</b> If 0 (EE) is selected while the 23/24 Hz or 25 Hz (HD or SD) mode has been selected as the system menu item No.25 (SYSTEM FREQ) setting, the VTR construes that 1 (BLACK) has been selected.
107*1 <b>EE MODE SEL</b>	<b>For selecting what signals are to be output when the EE mode is established.</b> <b>0000 NORMAL:</b> Signals delayed by an amount equivalent to the time taken for the signals to be processed internally are output. <b>0001 THRU:</b> The signals are not processed internally but output in their original form with no delay. <b>&lt;Note&gt;</b> The internal operation forcibly sets "NORMAL" when an editing mode is selected or when SDTI is selected during video input signal selection.
108 <b>PLAY DELAY</b>	<b>For setting the play startup time in 1-frame increments.</b> <b>0000</b> <u>0</u> : : <b>0015</b> 15
109*1 <b>CAP. LOCK</b>	<b>For selecting whether to engage playback framing lock in 4-field increments or in 2-field increments.</b> <b>&lt;59/60Hz&gt;</b> <b>&lt;50Hz&gt;</b> <b>0000</b> <u>2F</u> <b>0000</b> <u>2F</u> <b>0001</b> 4F <b>0001</b> 4F <b>0002</b> 8F
110 <b>AUTO REW</b>	<b>For selecting whether the tape is to be automatically wound back to its beginning when the tape-end has been detected.</b> <b>0000 OFF:</b> The tape stops when it reaches the tape-end. <b>0001 ON:</b> The tape is rewound to its beginning.
111*1 <b>MEMORY STOP</b>	<b>For selecting whether to automatically stop the VTR when the counter value is at the "0" position during CTL mode FF and REW operations.</b> <b>0000 OFF:</b> The VTR does not stop. <b>0001 ON:</b> The VTR is automatically stopped. <b>&lt;Notes&gt;</b> <ul style="list-style-type: none"> <li>Either the stop or still picture (SHTL STILL or VAR STILL) mode, whichever has been set using setup menu item No.307 (AFTER CUE-UP), is established when the VTR is stopped.</li> <li>If both the AUTO REW function and MEMORY STOP function have been selected at the same time, the AUTO REW operation takes priority.</li> </ul>

# Setup menus

## <OPERATION> (continued)

No./Item	Description of setting
112 FRZ MODE SEL	<p><b>For selecting what playback images are to be output in the STANDBY OFF mode and EJECT mode.</b></p> <p><u>0000</u> <b>DIS:</b> The video output is muted.</p> <p><b>0001 STB OFF:</b> Only when the STANDBY OFF mode is established is the image which was being played back at that moment frozen and output.</p> <p><b>0002 SOF&amp;EJ:</b> When either the STANDBY OFF mode or the EJECT mode is established, the image which was being played back at that moment is frozen and output.</p> <p><b>&lt;Notes&gt;</b></p> <ul style="list-style-type: none"> <li>The status when the picture is frozen is determined by the setup menu item No.604 (FREEZE SEL) setting.</li> <li>In the EJECT mode, the frozen picture is output only when 1 (BLACK) or 2 (GRAY) has been selected as the setup menu item No.106 (EJECT EE SEL) setting.</li> <li>The picture freeze is forcibly released if a change has occurred in the output format of the HD serial output signals when operation has transferred to the EJECT mode.</li> </ul>

### Description of MEMORY STOP function

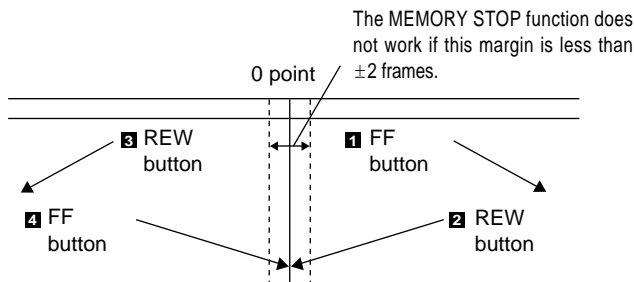

- 1 If the FF button is pressed, the normal FF operation is performed since there is no 0 point in the direction of this operation.
- 2 If the REW button is pressed, the PREROLL lamp lights (as does the SHTL lamp), the VTR prerolls the tape, and it automatically stops when the counter value is at the 0 position.
- 3 If the REW button is pressed, the normal REW operation is performed since there is no 0 point in the direction of this operation.
- 4 If the FF button is pressed, the PREROLL lamp lights (as does the SHTL lamp), the VTR prerolls the tape, and it automatically stops when the counter value is at the 0 position.

\*1: This item is not displayed when the 23/24 Hz or 25 Hz (HD or SD) mode has been selected as the system menu item No.25 (SYSTEM FREQ) setting.

The underlining (     ) denotes the factory setting mode.

No./Item	Description of setting
113*1 REC INH	<p><b>For selecting whether to allow or inhibit recording on the cassette tape.</b></p> <p><u>0000</u> <b>OFF:</b> Recording on the cassette tape is enabled when the cassette's accidental erasure prevention mechanism has been set to the recording enable position.</p> <p><b>0001 ALL:</b> All recording on the cassette tape is inhibited.</p> <p><b>0002 PRE:</b> Overwriting is inhibited during normal recording. This is the setting to activate the accidental erasure prevention function. While CTL is detected, the recording is inhibited, and when CTL cannot be detected, it is executed.</p> <p><b>0003 NORM:</b> Normal recording is inhibited. Use this setting when it is preferable to avoid using normal recording in all applications except for editing.</p> <p><b>0004 V/CTL:</b> The recording of the video and CTL signals is inhibited. Use this setting when it is preferable to avoid editing in all applications except for audio editing.</p> <p><b>&lt;Note&gt;</b> When the PRE, NORM or V/CTL setting has been selected, the REC INHIBIT lamp blinks (on for approx. 0.5 sec. and then off for approx. 0.5 sec.).</p>
114 REC INH LAMP	<p><b>For selecting whether the REC INHIBIT lamp is to blink or light when the cassette tape has been set to the accidental erasure protection mode.</b></p> <p><u>0000</u> <b>LIGHT:</b> The lamp lights.</p> <p><b>0001 FLASH:</b> The lamp blinks.</p> <p><b>&lt;Note&gt;</b> If 1 (ALL) has been selected as the setup menu item No.113 (REC INH) setting, the REC INHIBIT lamp will be lighted at all times regardless of the REC INH LAMP setting.</p>
115*1 EJECT SW INH	<p><b>For selecting whether to enable or disable the operation of the EJECT button on the VTR's front panel.</b></p> <p><u>0000</u> <b>REC:</b> Operation is disabled while the VTR is in the recording mode.</p> <p><b>0001 OFF:</b> Operation is enabled in all modes.</p>

### Accidental erasure protection function

This function is used to prevent parts already recorded on a tape from being recorded over. Accidental erasure of pre-recorded tapes is prevented by positioning the CTL signal rec/play heads as shown in the figure below so that whether a recording has been made can be determined by the presence or absence of the CTL signal. When the REC/PLAY button is pressed with a pre-recorded tape, the tape runs but the REC button lamp blinks, the beeping alarm is sounded, and no signals are recorded.

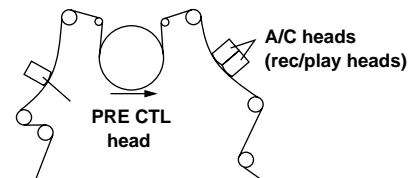

Rough sketch showing CTL head positions

# Setup menus

## <OPERATION> (continued)

No./Item	Description of setting
116 EJECT LAMP	<p>For selecting whether the EJECT lamp is to remain lighted or go off after the cassette tape has been ejected.</p> <p><u>0000</u> <u>MODE1</u>: The EJECT lamp remains lighted.</p> <p>0001 <u>MODE2</u>: The EJECT lamp goes off.</p>
118*1 SP MODE INH	<p>For selecting whether to allow or inhibit recording on a tape which has been written by a format other than DVCPRO HD-LP.</p> <p>0000 <u>OFF</u>: Recording on the cassette tape is allowed.</p> <p><u>0001</u> <u>ON</u>: Recording on the cassette tape is inhibited.</p> <p>&lt;Notes&gt;</p> <ul style="list-style-type: none"> <li>When 0 (OFF) has been selected, whether recording on the cassette tape is allowed or inhibited is determined by the setup menu item No.113 (REC INH) setting.</li> <li>The recording format is determined by the setup menu item No.020 (SYS FORMAT) setting.</li> </ul>
131 PAGE MODE	<p>For selecting what cue point operation is to be performed when the multi cue function has been set to ON.</p> <p><u>0000</u> <u>MANU</u>: Operation is confined within the selected page, and 6 cue points can be registered.</p> <p>0001 <u>AUTO</u>: When the page whose cue points are being registered becomes full, operation is automatically transferred to the next page, and registration is continued. A total of 60 cue points on up to 10 pages can be registered.</p>
132 ROTA MODE	<p>For selecting whether to perform the registration operation if all the cue points have already been registered when the multi cue function has been set to ON.</p> <p><u>0000</u> <u>OFF</u>: No further cue points are registered.</p> <p>0001 <u>ON</u>: The registration operation is continued. If "MANU" has been selected as the setup menu item No.131 (PAGE MODE) setting, the next cue point is registered at CUE*1 on the page concerned; if "AUTO" has been selected, it is registered at CUE01.</p>
133 KEY BEEP	<p>For setting the volume of the sound heard when the keys are touched.</p> <p><u>0000</u> <u>OFF</u> 0001 <u>LOW</u> 0002 <u>HIGH</u></p>
134 ALARM BEEP	<p>For setting the volume of the alarm tone.</p> <p><u>0000</u> <u>OFF</u> 0001 <u>LOW</u> 0002 <u>HIGH</u></p> <p>&lt;Note&gt; If the fan motor has shut down, the alarm tone is sounded at the HIGH volume level regardless of this setting.</p>

\*1: This item is not displayed when the 23/24 Hz or 25 Hz (HD or SD) mode has been selected as the system menu item No.25 (SYSTEM FREQ) setting.

The underlining (   ) denotes the factory setting mode.

No./Item	Description of setting
140*1 OUTPUT	<p>For selecting the output signals.</p> <p><u>0000</u> <u>EE</u>: &lt;In the STOP mode&gt;: The input signals selected by setup menu items No.600 (VIDEO IN SEL) and No.713 (CH1 IN SEL) to No.724 (D IN SEL 78) are output. &lt;During recording or editing&gt;: The input signals selected by setup menu items No.600 (VIDEO IN SEL) and No.713 (CH1 IN SEL) to No.724 (D IN SEL 78) are output.</p> <p>0001 <u>TAPE</u>: &lt;In the STOP mode&gt; The signals played back from the tape are output. &lt;During recording or editing&gt;: The simultaneous playback signals are output.</p> <p>&lt;Note&gt; In order to select the output signals during recording or editing, set setup menu item No.302 (CONFI EDIT).</p>
141*1 VOLUME	<p>For setting what is to be controlled by the audio volume controls on the front panel.</p> <p>0000 <u>REC</u>: The controls function as REC volume controls.</p> <p>0001 <u>PB</u>: The controls function as PB volume controls.</p> <p><u>0002</u> <u>AUTO</u>: Normally, the controls function as PB volume controls. However, during recording or in the EE/INPUT CHECK status, they automatically function as REC volume controls.</p>
142*1 AUDIO UNITY	<p>For selecting the conditions under which the AUDIO UNITY lamp on the front panel is to light.</p> <p>0000 <u>IN</u>: The lamp lights when all the audio input levels are set to the UNITY level.</p> <p>0001 <u>OUT</u>: The lamp lights when all the audio output levels are set to the UNITY level.</p> <p><u>0002</u> <u>IN/OUT</u>: The lamp lights when all the audio input and output levels are set to the UNITY level.</p>
143 CASSTT LIGHT	<p>For setting whether the lighting of the tape mechanism is to be set to ON or remain OFF.</p> <p>0000 <u>OFF</u>: The mechanism does not light even when a cassette is inserted.</p> <p>0001 <u>ON</u>: The mechanism lights when a cassette is inserted.</p>
144 TC INPUT	<p>For switching the preset registration method for the time code.</p> <p><u>0000</u> <u>NORMAL</u>: The time code is input starting with the left-most digit.</p> <p>0001 <u>REV</u>: The time code is input from the high-order digit but is displayed from the right-most digit.</p>
145 FRONT LCD	<p>For selecting whether the LCD monitor display on the front panel is to be turned on or off.</p> <p>0000 <u>OFF</u>: The display is turned off.</p> <p><u>0001</u> <u>ON</u>: The display is turned on or off in synchronization with the screen saver operation for the time code display area.</p>

# Setup menus

## <INTERFACE>

No./Item	Description of setting
200 PARA RUN	<p><b>For selecting whether to operate two or more VTRs in synchronization.</b></p> <p><u>0000</u> <b>DIS:</b> The VTRs are not operated in synchronization.</p> <p>0001 <b>ENA:</b> The VTRs are operated in synchronization.</p> <p>&lt;Note&gt; To operate the VTRs in synchronization, set all the VTRs to 1 (ENA). (Refer to pages 14 and 19.)</p>
202 ID SEL	<p><b>For setting what ID information is to be returned to the controller.</b></p> <p>0000 <b>OTHER</b></p> <p>0001 <b>DVCPRO</b></p> <p>0002 <b>ORIG</b></p> <p>&lt;Notes&gt;</p> <ul style="list-style-type: none"> <li>For 0 (OTHER), the ID information of VTRs other than DVCPRO models is set.</li> <li>Select 2 (ORIG) only when the VTR is connected to a Panasonic controller (such as the AJ-A900, an optional accessory).</li> <li>Select 1 (DVCPRO) or 2 (ORIG) if the 23/24 Hz mode has been selected by system menu item No.25 (SYSTEM FREQ).</li> </ul>
204 RS232C SEL	<p><b>For selecting whether the RS-232C connector is to function.</b></p> <p><u>0000</u> <b>OFF:</b> The RS-232C connector does not function.</p> <p>0001 <b>ON:</b> The RS-232C connector functions.</p>
205 BAUD RATE	<p><b>For setting the RS-232C data transfer speed (baud rate).</b></p> <p>0000 300</p> <p>0001 600</p> <p>0002 1200</p> <p>0003 2400</p> <p>0004 4800</p> <p><u>0005</u> 9600</p>
206 DATA LENGTH	<p><b>For setting the RS-232C data length.</b> (Unit: bits)</p> <p>0000 7</p> <p><u>0001</u> 8</p>
207 STOP BIT	<p><b>For setting the number of RS-232C stop bits.</b> (Unit: bits)</p> <p><u>0000</u> 1</p> <p>0001 2</p>
208 PARITY	<p><b>For setting whether the RS-232C parity bit is to be used and, if it is used, whether even or odd parity is to apply.</b></p> <p><u>0000</u> <b>NON:</b> The parity bit is not used.</p> <p>0001 <b>ODD:</b> The parity bit is used with an odd parity.</p> <p>0002 <b>EVEN:</b> The parity bit is used with an even parity.</p>

No./Item	Description of setting
209 RETURN ACK	<p><b>For setting whether or not to return the ACK code when a command is received from RS-232C.</b></p> <p>0000 <b>OFF:</b> The ACK code is not returned.</p> <p><u>0001</u> <b>ON:</b> The ACK code is returned.</p>
212 MASTER PORT	<p><b>For selecting the remote control connector for controlling the slave machine when this VTR is to be used as the master machine for deck-to-deck operations.</b></p> <p><u>0001</u> <b>IN/OUT:</b> The IN/OUT connector is used.</p> <p>0001 <b>OUT:</b> The OUT connector is used.</p> <p>&lt;Note&gt; This setting takes effect only when the 9P button has been set to LOCAL (LED off).</p>

The underlining (     ) denotes the factory setting mode.

# Setup menus

## <EDIT>

No./Item	Description of setting
300 IN/OUT DEL	<p>For selecting the operation to be performed when an edit point has been set incorrectly (when the OUT point comes before the IN point).</p> <p><u>0000</u> <b>MANU</b>: Editing is not performed unless the illegal edit point is cleared or set properly.</p> <p><u>0001</u> <b>AUTO</b>: The edit point which had already been input is cleared automatically.</p>
301 NEGA FLASH	<p>For selecting whether to show a negative display (time code display area) when the IN point is greater than the OUT point.</p> <p><u>0000</u> <b>OFF</b>: A negative display is not shown.</p> <p><u>0001</u> <b>ON</b>: A negative display is shown.</p>
302 CONFI EDIT	<p>For selecting whether to perform simultaneous playback during editing.</p> <p><u>0000</u> <b>OFF</b>: Simultaneous playback is not performed.</p> <p><u>0001</u> <b>ON</b>: Simultaneous playback is performed.</p> <p><b>&lt;Note&gt;</b> Simultaneous playback takes effect when TAPE is selected as the F1 key <b>OUTPUT</b> setting on the &lt;HOME&gt; menu. Refer to setup menu item No.140 as well.</p>
303*1 AUD EDIT IN	<p>For selecting how to connect the digital audio edit IN points.</p> <p><u>0000</u> <b>CUT</b>: Cut processing</p> <p><u>0001</u> <b>FADE</b>: V-fade processing</p>
304*1 AUD EDIT OUT	<p>For selecting how to connect the digital audio edit OUT points.</p> <p><u>0000</u> <b>CUT</b>: Cut processing</p> <p><u>0001</u> <b>FADE</b>: V-fade processing</p>
305 AUTO ENTRY	<p>For selecting whether to register the IN points using the PREROLL button in cases where the IN points have not been registered.</p> <p><u>0000</u> <b>DIS</b>: The IN points are not registered.</p> <p><u>0001</u> <b>ENA</b>: The IN points are registered.</p>
306*1 CF ADJ SEL	<p>For selecting the deck whose the color framing is to be adjusted during deck-to-deck editing.</p> <p><u>0000</u> <b>PLAYER</b>: The player's IN and OUT points are adjusted (using the recorder as the reference).</p> <p><u>0001</u> <b>RECORD</b>: The recorder's IN and OUT points are adjusted (using the player as the reference).</p>
307 AFTER CUE-UP	<p>For selecting the VTR's mode upon completion of the cue-up operation.</p> <p><u>0000</u> <b>STOP</b>: The VTR is set to the STOP mode.</p> <p><u>0001</u> <b>STILL</b>: The VTR is set to the still picture (SHTL STILL) mode.</p> <p><u>0002</u> <b>STILL2</b>: The VTR is set to the still picture (VAR STILL) mode.</p>

No./Item	Description of setting
308 VAR FWD MAX	<p>For setting the maximum speed of VAR FWD.</p> <p><u>0000</u> <b>+4.9</b>: +4.9 times normal tape speed</p> <p><u>0001</u> <b>+2</b>: +2 times normal tape speed (+1.85 times normal tape speed for formats other than DVCPRO HD-LP)</p> <p><u>0002</u> <b>+1</b>: +1 times normal tape speed</p> <p><b>&lt;Notes&gt;</b></p> <ul style="list-style-type: none"> <li>At any setting other than 0 (+4.9), phase adjustments cannot be conducted from the editing controller.</li> <li>Depending on the format used, the actual tape running speed differs slightly from what is indicated by the superimposed display.</li> </ul>
309 VAR REV MAX	<p>For setting the maximum speed of VAR REV.</p> <p><u>0000</u> <b>-4.9</b>: -4.9 times normal tape speed</p> <p><u>0001</u> <b>-2</b>: -2 times normal tape speed (-1.85 times normal tape speed for formats other than DVCPRO HD-LP)</p> <p><u>0002</u> <b>-1</b>: -1 times normal tape speed</p> <p><b>&lt;Note&gt;</b> Depending on the format used, the actual tape running speed differs slightly from what is indicated by the superimposed display.</p>
310 JOG FWD MAX	<p>For setting the maximum speed of JOG FWD.</p> <p><u>0000</u> <b>+4.9</b>: +4.9 times normal tape speed</p> <p><u>0001</u> <b>+2</b>: +2 times normal tape speed (+1.85 times normal tape speed for formats other than DVCPRO HD-LP)</p> <p><u>0002</u> <b>+1</b>: +1 times normal tape speed</p> <p><b>&lt;Notes&gt;</b> At any setting other than 0 (+4.9), phase adjustments cannot be conducted from the editing controller which performs these adjustments by the JOG command.</p>
311 JOG REV MAX	<p>For setting the maximum speed of JOG REV.</p> <p><u>0000</u> <b>-4.9</b>: -4.9 times normal tape speed</p> <p><u>0001</u> <b>-2</b>: -2 times normal tape speed (-1.85 times normal tape speed for formats other than DVCPRO HD-LP)</p> <p><u>0002</u> <b>-1</b>: -1 times normal tape speed</p>
312 POSTROLL TM	<p>For setting the postroll time.</p> <p>Any time from 0 to 5 seconds can be set in 1-second increments.</p> <p><u>0000</u> <b>0s</b></p> <p><u>0001</u> <b>1s</b></p> <p><u>0002</u> <b>2s</b></p> <p><u>0003</u> <b>3s</b></p> <p><u>0004</u> <b>4s</b></p> <p><u>0005</u> <b>5s</b></p>

\*1: This item is not displayed when the 23/24 Hz or 25 Hz (HD or SD) mode has been selected as the system menu item No.25 (SYSTEM FREQ) setting.

The underlining (     ) denotes the factory setting mode.



# Setup menus

## <EDIT> (continued)

No./Item	Description of setting
320* <sup>1</sup> EDIT RPLCE1	<p>For setting the allocation of the channels for the analog audio presets of a controller when a controller without a function to control the edit presets of the digital audio signals is used to edit the digital audio signals of the VTR.</p> <p>The VTR's CH1 edit presets are set to ON or OFF following the analog audio signals specified by the controller.</p> <p><u>0000</u> N-DEF: Not set.</p> <p><u>0001</u> CH1: The analog CH1 edit presets are followed.</p> <p><u>0002</u> CH2: The analog CH2 edit presets are followed.</p> <p><u>0003</u> CH1+2: The analog CH1 or CH2 edit presets are followed.</p>
321* <sup>1</sup> EDIT RPLCE2	<p>As with setup menu item No.320, the VTR's CH2 edit presets are set to ON or OFF following the analog audio signals specified by the controller.</p> <p><u>0000</u> N-DEF: Not set.</p> <p><u>0001</u> CH1: The analog CH1 edit presets are followed.</p> <p><u>0002</u> CH2: The analog CH2 edit presets are followed</p> <p><u>0003</u> CH1+2: The analog CH1 or CH2 edit presets are followed.</p>
322* <sup>1</sup> EDIT RPLCE3	<p>As with setup menu item No.320, the VTR's CH3 edit presets are set to ON or OFF following the analog audio signals specified by the controller.</p> <p><u>0000</u> N-DEF: Not set.</p> <p><u>0001</u> CH1: The analog CH1 edit presets are followed.</p> <p><u>0002</u> CH2: The analog CH2 edit presets are followed</p> <p><u>0003</u> CH1+2: The analog CH1 or CH2 edit presets are followed.</p>

No./Item	Description of setting
323* <sup>1</sup> EDIT RPLCE4	<p>As with setup menu item No.320, the VTR's CH4 edit presets are set to ON or OFF following the analog audio signals specified by the controller.</p> <p><u>0000</u> N-DEF: Not set.</p> <p><u>0001</u> CH1: The analog CH1 edit presets are followed.</p> <p><u>0002</u> CH2: The analog CH2 edit presets are followed.</p> <p><u>0003</u> CH1+2: The analog CH1 or CH2 edit presets are followed.</p>
324* <sup>1</sup> EDIT RPLCEC	<p>As with setup menu item No.320, the VTR's CUE edit presets are set to ON or OFF following the analog audio signals specified by the editor or controller.</p> <p><u>0000</u> N-DEF: Not set.</p> <p><u>0001</u> CH1: The analog CH1 edit presets are followed.</p> <p><u>0002</u> CH2: The analog CH2 edit presets are followed.</p> <p><u>0003</u> CH1+2: The analog CH1 or CH2 edit presets are followed.</p>

\*1: This item is not displayed when the 23/24 Hz or 25 Hz (HD or SD) mode has been selected as the system menu item No.25 (SYSTEM FREQ) setting.

The underlining (   ) denotes the factory setting mode.

# Setup menus

## <TAPE PROTECT>

No./Item	Description of setting
400 STILL TIMER	<p>For selecting the duration of the time taken after the VTR is left standing in the STOP or search STILL mode (JOG, VAR or SHTL) before the tape protection mode is established.</p> <p>(Units: s = seconds, min = minutes)</p> <p>0000 0.5s            0001 5s            0002 10s            0003 20s            0004 30s &lt;Note&gt;            0005 40s When a DV or DVCAM tape is            0006 50s used, the time is set to 10            0007 1min seconds even when a setting of            0008 2min 2 (10s) or longer is selected.</p>
401 SRC PROTECT	<p>For selecting the operation to be performed when the tape protection mode is established after the VTR has been left standing in the STILL status in a search mode (JOG, VAR or SHTL).</p> <p>0000 STEP: STEP FWD            0001 HALF: Half-loading            0002 T-REL: Tension release</p> <p>&lt;Notes&gt;</p> <ul style="list-style-type: none"> <li>When STEP FWD is selected, the VTR is automatically transferred to the standby OFF (half-loading) mode after it has been left standing in the STILL status for a total of 30 minutes (or 1 minute in the case of a DV or DVCAM tape).</li> <li>When, after tension release has been selected and the VTR has been transferred to the tension release mode, the VTR has been left standing in this mode for a total of 2 hours, it is automatically transferred to the standby OFF (half-loading) mode. However, in the case of a DV or DVCAM tape, the transfer to the tension release mode is inhibited, and the VTR operates as if STEP FWD has been selected.</li> </ul>
402 DRUM STDBY	<p>For selecting whether the drum is to operate in the standby OFF (half-loading) mode.</p> <p>0000 OFF: The drum stops rotating.            0001 ON: The drum continues to rotate.</p>

No./Item	Description of setting
403 STOP PROTECT	<p>For selecting the operation to be performed when the tape protection mode is established after the VTR has been left standing in the STOP mode.</p> <p>0000 STEP: STEP FWD            0001 HALF: Half-loading            0002 T-REL: Tension release</p> <p>&lt;Notes&gt;</p> <ul style="list-style-type: none"> <li>When STEP FWD is selected, the VTR is automatically transferred to the standby OFF (half-loading) mode after it has been left standing in the STOP mode for a total of 30 minutes (or 1 minute in the case of a DV or DVCAM tape).</li> <li>When, after tension release has been selected and the VTR has been transferred to the tension release mode, the VTR has been left standing in this mode for a total of 2 hours, it is automatically transferred to the standby OFF (half-loading) mode. However, in the case of a DV or DVCAM tape, the transfer to the tension release mode is inhibited, and the VTR operates as if STEP FWD has been selected.</li> </ul>

### <Precaution for STILL TIMER item setting>

The cumulative total standby time passed in the same location increases at such times when the same material is repeatedly used as is the case when programs are transmitted, for example.

The underlining (     ) denotes the factory setting mode.

# Setup menus

## <TIME CODE>

No./Item	Description of setting																								
500* <sup>4</sup> VITC BLANK	<p>For selecting whether or not to output the VITC signal at the positions selected by setup menu items No.501 (VITC POS-1) and No.502 (VITC POS-2).</p> <p>0000 BLANK: The VITC signal is not output. 0001 THRU: The VITC signal is output.</p> <p>&lt;Note&gt; Only the SD output takes effect at this setting.</p>																								
501* <sup>4</sup> VITC POS-1	<p>For setting the position where the VITC signal is to be inserted.</p> <table border="0"> <tr> <td colspan="2">&lt;59/60Hz&gt;</td> <td colspan="2">&lt;50Hz, 25Hz (SD)&gt;</td> </tr> <tr> <td>0000</td> <td>10L</td> <td>0000</td> <td>7L</td> </tr> <tr> <td>:</td> <td>:</td> <td>:</td> <td>:</td> </tr> <tr> <td>0006</td> <td>16L</td> <td>0004</td> <td>11L</td> </tr> <tr> <td>:</td> <td>:</td> <td>:</td> <td>:</td> </tr> <tr> <td>0010</td> <td>20L</td> <td>0015</td> <td>22L</td> </tr> </table> <p>&lt;Notes&gt;</p> <ul style="list-style-type: none"> <li>The same line as the one selected by the setup menu item No.502 (VITC POS-2) cannot be selected.</li> <li>Only the SD output takes effect at this setting.</li> </ul>	<59/60Hz>		<50Hz, 25Hz (SD)>		0000	10L	0000	7L	:	:	:	:	0006	16L	0004	11L	:	:	:	:	0010	20L	0015	22L
<59/60Hz>		<50Hz, 25Hz (SD)>																							
0000	10L	0000	7L																						
:	:	:	:																						
0006	16L	0004	11L																						
:	:	:	:																						
0010	20L	0015	22L																						
502* <sup>4</sup> VITC POS-2	<p>For setting the position where the VITC signal is to be inserted.</p> <table border="0"> <tr> <td colspan="2">&lt;59/60Hz&gt;</td> <td colspan="2">&lt;50Hz, 25Hz (SD)&gt;</td> </tr> <tr> <td>0000</td> <td>10L</td> <td>0000</td> <td>7L</td> </tr> <tr> <td>:</td> <td>:</td> <td>:</td> <td>:</td> </tr> <tr> <td>0008</td> <td>18L</td> <td>0006</td> <td>13L</td> </tr> <tr> <td>:</td> <td>:</td> <td>:</td> <td>:</td> </tr> <tr> <td>0010</td> <td>20L</td> <td>0015</td> <td>22L</td> </tr> </table> <p>&lt;Notes&gt;</p> <ul style="list-style-type: none"> <li>The same line as the one selected by the setup menu item No.501 (VITC POS-1) cannot be selected.</li> <li>Only the SD output takes effect at this setting.</li> </ul>	<59/60Hz>		<50Hz, 25Hz (SD)>		0000	10L	0000	7L	:	:	:	:	0008	18L	0006	13L	:	:	:	:	0010	20L	0015	22L
<59/60Hz>		<50Hz, 25Hz (SD)>																							
0000	10L	0000	7L																						
:	:	:	:																						
0008	18L	0006	13L																						
:	:	:	:																						
0010	20L	0015	22L																						
503* <sup>1</sup> TCG MODE	<p>For setting the synchronization of the internal time code generator.</p> <p>0000 REGEN: The time code reader is synchronized with the time code which is read from the tape.</p> <p>0001 PRE: Presetting is enabled at the operation panel or by the remote controller.</p> <p>0002 AUTO: The REGEN and PRE settings are automatically switched in accordance with the operation mode. In the editing mode: REGEN is selected. In all other modes: PRE is selected.</p>																								
504* <sup>1</sup> RUN MODE	<p>For setting when the internal time code generator is to advance depending on the operation mode.</p> <p>0000 REC: The time code generator is advanced during recording.</p> <p>0001 FREE: The time code generator is advanced while the power is on regardless of which operation mode is established.</p>																								

No./Item	Description of setting															
505* <sup>1</sup> TCG REGEN	<p>For selecting the regeneration signal when REGEN has been selected as the TCG (time code generator) mode.</p> <p>0000 TC&amp;UB: Regeneration applies to both the time code and user's bit.</p> <p>0001 TC: Regeneration applies only to the time code only.</p> <p>0002 UB: Regeneration applies only to the user's bit only.</p>															
506* <sup>1</sup> REGEN MODE	<p>For selecting the editing mode range when the VTR is operating in the REGEN mode while performing editing operations with "AUTO" selected as the setup menu item No.503 (TCG MODE) setting.</p> <p>0000 AS&amp;IN: Regeneration applies during assemble or insert editing.</p> <p>0001 ASSEM: Regeneration applies during assemble editing.</p> <p>0002 INSRT: Regeneration applies during insert editing.</p>															
507* <sup>1</sup> TC SOURCE	<p>For selecting the time code to be used when HD SDI or SD SDI has been selected as the setup menu item No.600 (VIDEO IN SEL) setting when an external time code is to be used.</p> <p>[When HD SDI has been selected]</p> <p>0000 INT: The time code of the internal time code generator is used.</p> <p>0001 EXT_L: LTC of the TIME CODE IN connector is used.</p> <p>0002 SLTC: The LTC information added to the serial signals which are input to HD SDI IN is used.</p> <p>0003 SVITC: The VITC information added to the serial signals which are input to HD SDI IN is used.</p> <p>[When SD SDI has been selected]</p> <p>0000 INT: The time code of the internal time code generator is used.</p> <p>0001 EXT_L: LTC of the TIME CODE IN connector is used.</p> <p>0002 VITC: The VITC information added to the serial signals which are input to SD SDI IN is used.</p> <p>&lt;Note&gt; If the VIDEO IN SEL input selection is changed, the time code is converted as shown below.</p> <table border="0"> <tr> <td>[HD_SDII]</td> <td></td> <td>[SD_SDII]</td> </tr> <tr> <td>INT</td> <td>↔</td> <td>INT</td> </tr> <tr> <td>EXT_L</td> <td>↔</td> <td>EXT_L</td> </tr> <tr> <td>SLTC</td> <td>↔</td> <td>EXT_L</td> </tr> <tr> <td>SVITC</td> <td>↔</td> <td>VITC</td> </tr> </table>	[HD_SDII]		[SD_SDII]	INT	↔	INT	EXT_L	↔	EXT_L	SLTC	↔	EXT_L	SVITC	↔	VITC
[HD_SDII]		[SD_SDII]														
INT	↔	INT														
EXT_L	↔	EXT_L														
SLTC	↔	EXT_L														
SVITC	↔	VITC														

\*1: This item is not displayed when the 23/24 Hz or 25 Hz (HD or SD) mode has been selected as the system menu item No.25 (SYSTEM FREQ) setting.

\*2: This item is not displayed when the 23/24 Hz or 25 Hz (HD) mode has been selected as the system menu item No.25 (SYSTEM FREQ) setting.

The underlining (     ) denotes the factory setting mode.

# Setup menus

## <TIME CODE> (continued)

No./Item	Description of setting
508*1 BINARY GP	<p>For setting how the user's bit of the time code generated by the TCG is to be used.</p> <p><u>0000</u> <u>000</u>: NOT SPECIFIED (no character set specified)</p> <p>0001 001: ISO CHARACTER (8-bit character set complying with ISO646, ISO2022 standards)</p> <p>0002 010: UNASSIGNED 1 (undefined)</p> <p>0003 011: UNASSIGNED 2 (undefined)</p> <p>0004 100: UNASSIGNED 3 (undefined)</p> <p>0005 101: PAGE/LINE</p> <p>0006 110: UNASSIGNED 4 (undefined)</p> <p>0007 111: UNASSIGNED 5 (undefined)</p>
509 PHASE CORR	<p>For selecting whether to exercise phase correction control over the LTC which is generated by the TCG.</p> <p><u>0000</u> <u>OFF</u>: Phase correction control is not exercised.</p> <p>0001 <u>ON</u>: Phase correction control is exercised.</p>
510*1 TCG CF FLAG	<p>For selecting whether to set the CF flag of the TCG to ON or OFF.</p> <p><u>0000</u> <u>OFF</u>: The CF flag is set to OFF.</p> <p>0001 <u>ON</u>: The CF flag is set to ON.</p>
511*2 DF MODE	<p>For selecting the drop frame or non-drop frame mode for CTL and TCG.</p> <p><u>0000</u> <u>DF</u>: The drop frame mode is selected.</p> <p>0001 <u>NDF</u>: The non-drop frame mode is selected.</p> <p>&lt;Note&gt; This DF mode setting takes effect only when LOCAL is selected or when "ENA" has been selected as the setup menu item No.001 (LOCAL ENA) setting.</p>
512*1 TC OUT REF	<p>For switching the phase of the time code, which is output from the TIME CODE OUT connector, in response to the external LTC input when a setting other than "INT" has been selected for setup menu item No.507 (TC SOURCE). (In EE mode only)</p> <p><u>0000</u> <u>V OUT</u>: The phase is aligned with the output image.</p> <p>0001 <u>TC IN</u>: The phase is aligned with the external time code input.</p>

### SBC (sub code data) area:

This is an area on the helical track, and it is separate from the video and audio data area. The time codes, recording dates and times and other tape control information complying with SMPTE/EBU standards are stored here. As with the conventional LTC (linear time code), the time code can be read even during rewinding or fast forwarding. It can also be read out when the tape has stopped.

### VAUX (video auxiliary data) area:

This area is to be found in the video data area on the helical track. The additional information relating to the video data is stored here.

\*1: This item is not displayed when the 23/24 Hz or 25 Hz (HD or SD) mode has been selected as the system menu item No.25 (SYSTEM FREQ) setting.

\*2: This item is not displayed when the 23/24 Hz, 25 Hz (HD or SD) or 50 Hz mode has been selected as the system menu item No.25 (SYSTEM FREQ) setting.

No./Item	Description of setting
513 VITC OUT	<p>For selecting how to output the VITC which is superimposed on the output video signal.</p> <p><u>0000</u> <u>SBC</u>: In the playback mode, the time code recorded in the SBC area is output.</p> <p>0001 <u>VAUX</u>: In the playback mode, the time code recorded in the VAUX area is output.</p> <p>&lt;Note&gt; The VITC information detected by the HD serial input is automatically recorded in the VAUX area when the video signals are recorded.</p>
514 HD EMBD VITC	<p>For selecting whether to superimpose the VITC information on the HD serial output.</p> <p><u>0000</u> <u>OFF</u>: The VITC information is not superimposed.</p> <p><u>0001</u> <u>ON</u>: The VITC information is superimposed.</p>
515 HD EMBD LTC	<p>For selecting whether to superimpose the LTC information on the HD serial output.</p> <p><u>0000</u> <u>OFF</u>: The LTC information is not superimposed.</p> <p><u>0001</u> <u>ON</u>: The LTC information is superimposed.</p>
516*1 TC OUT ADV	<p>For selecting the processing to align the phase of the time code which is output from the TIME CODE OUT connector.</p> <p>Normally, the time code which is output from the TIME CODE OUT connector is aligned with the output video and audio. If so required by the connection with an external component or for some other reason, this item makes it possible to set the mode for aligning the phase with the input.</p> <p><u>0000</u> <u>OFF</u>: The phase alignment processing is not conducted. The time code which is output from the TIME CODE OUT connector is aligned with the output video and audio.</p> <p>0001 <u>EDIT</u>: During playback when an editing mode has been selected and during editing, the time code which is output from the TIME CODE OUT connector is aligned with the input video and audio. In all other modes, it is aligned with the output video and audio.</p>
517*1 TCG OUT	<p>For selecting whether to latch the TCG display and LTC output during INPUT CHECK.</p> <p><u>0000</u> <u>MOMENT</u>: The INPUT CHECK mode is established only while the INPUT CHECK key is held down.</p> <p>0001 <u>LATCH</u>: When the INPUT CHECK key is pressed, the INPUT CHECK mode is established; even when it is released, the mode remains unchanged. The selection is released when the video output is set to a mode other than the EE mode.</p>

The underlining (     ) denotes the factory setting mode.

# Setup menus

## <VIDEO>

No./Item	Description of setting
600*1 VIDEO IN SEL	<p><b>For selecting the video signal which is to be input.</b></p> <p><b>0000 INT SG:</b> The internal signal selected by the VIDEO INT SG item is generated.</p> <p><b>0001 HSDSI:</b> The serial video signal which has been input to the HD SDI IN connector is selected.</p> <p><b>0002 SDTI: (In 59/60 Hz mode)</b> The compressed IF signal which has been input to the SDTI IN connector is selected. (This setting does not appear when the AJ-YAC15P optional board has not been installed.)</p> <p><b>0002 SD SDI:</b> The serial video signal which has been input to the SD SDI IN connector is selected. (This setting does not appear when the AJ-UC1700G optional board has not been installed.)</p>
601*1 VIDEO INT SG	<p><b>For selecting the type of internal signal.</b></p> <p><b>0000 100%CB:</b> A 100% color bar signal is selected.</p> <p><b>0001 75%CB:</b> A 75% color bar signal is selected.</p> <p><b>0002 SMPTE:</b> An SMPTE color bar signal is selected.</p> <p><b>0003 ARIB:</b> An ARIB color bar signal is selected.</p> <p><b>0004 MB:</b> A multiburst signal is selected.</p> <p><b>0005 RAMP:</b> A ramp signal is selected.</p> <p><b>0006 BLACK:</b> A black signal is selected.</p> <p><b>0007 PLL:</b> A PLL signal is selected.</p> <p><b>0008 EQ:</b> An EQ signal is selected.</p>
602*1 SDI IN MODE	<p><b>For selecting how to process the serial input.</b></p> <p><b>0000 DR OFF:</b> The 8 higher bits after rounding up the 2 lowest bits are recorded.</p> <p><b>0001 DR ON:</b> The signal with 8 higher bits, obtained by dynamic rounding, is recorded.</p>
603 V-MUTE SEL	<p><b>For selecting whether to mute the video output signals if LOW RF has been detected during playback.</b></p> <p><b>0000 N MUTE:</b> The signals are not muted. (They are frozen.)</p> <p><b>0001 GRAY:</b> The signals are muted with gray.</p> <p><b>0002 BLACK:</b> The signals are muted with black.</p> <p><b>0003 NOISE:</b> The signals are muted with noise.</p>
604*1 FREEZE SEL	<p><b>For selecting the freeze mode of the still pictures and slow playback mode.</b></p> <p><b>0000 FIELD:</b> Field freeze, field slow</p> <p><b>0000 FRAME:</b> Frame freeze, frame slow</p>

\*1: This item is not displayed when the 23/24 Hz or 25 Hz (HD or SD) mode has been selected as the system menu item.

\*4: This item is not displayed when the 23/24 Hz or 25 Hz (HD) mode has been selected as the system menu item No.25 (SYSTEM FREQ) setting.

\*5: This item is not displayed when the 25 Hz (HD or SD) mode has been selected as the system menu item No.25 (SYSTEM FREQ) setting.

The underlining (   ) denotes the factory setting mode.

No./Item	Description of setting
605*1 INTERPOLATE	<p>During field slow playback, vertical interpolation is conducted automatically to minimize the up/down movement of the playback pictures. However, this setting enables the interpolation operation to be forcibly set to OFF.</p> <p><b>0000 OFF:</b> The interpolation is forcibly set to OFF.</p> <p><b>0001 AUTO:</b> During slow playback, the interpolation is automatically set to ON.</p>
606 SD MONI O SEL	<p><b>For selecting the SD SDI or MONITOR output signal.</b></p> <p><b>0000 MONI:</b> The MONITOR signal is output.</p> <p><b>0001 SDI:</b> The same video signal as the one output from the SD SDI OUT1 connector is output</p> <p><b>&lt;Note&gt;</b> When 1 (SDI) is selected, the time code and other information are not superimposed on the display.</p>
620*4 DOWNCON MODE	<p><b>For selecting the picture frame during down-conversion.</b></p> <p><b>0000 FIT_V:</b> Side cut mode</p> <p><b>0001 FIT_H:</b> Letter box mode</p> <p><b>0002 FIT_HV:</b> Squeeze mode</p> <p><b>0003 14:9:</b> Semi letter box 14:9</p> <p><b>0004 13:9:</b> Semi letter box 13:9</p>
621*5 UPCON MODE	<p><b>For selecting the picture frame during up-conversion.</b></p> <p><b>0000 FIT_V:</b> Side panel mode</p> <p><b>0001 FIT_H:</b> Top and bottom cut in vertical direction</p> <p><b>0002 FIT_HV:</b> Stretch mode</p>
622 D/C RESP H	<p><b>For selecting the horizontal frequency band during down-conversion and line conversion (1080i ↔ 720p).</b></p> <p><b>0000 WIDE</b></p> <p><b>0001 STD</b></p>
623 D/C RESP V	<p><b>For selecting the vertical frequency band during down-conversion and line conversion (1080i ↔ 720p).</b></p> <p><b>0000 WIDE</b></p> <p><b>0001 STD</b></p>
624*5 U/C RESP H	<p><b>For selecting the horizontal frequency band during up-conversion and line conversion.</b></p> <p><b>0000 STD</b></p> <p><b>0001 NARROW</b></p>
625*5 U/C RESP V	<p><b>For selecting the vertical frequency band during up-conversion and line conversion.</b></p> <p><b>0000 STD</b></p> <p><b>0001 NARROW</b></p>
626 D/C ENH H	<p><b>For accentuating the horizontal contours during down-conversion and line conversion (1080i ↔ 720p).</b></p> <p><b>0000 0dB</b></p> <p><b>0001 +0.7dB</b></p> <p><b>0002 +1dB</b></p> <p><b>0003 +1.2dB</b></p> <p><b>0004 +1.5dB</b></p> <p><b>0005 +2dB</b></p> <p><b>&lt;Note&gt;</b> The numbers on the superimposed display are approximations only.</p>

# Setup menus

## <VIDEO> (continued)

No./Item	Description of setting												
627 D/C ENH V	For accentuating the vertical contours during down-conversion and line conversion (1080i ←→ 720p). 0000 0dB 0001 +0.7dB 0002 +1dB 0003 +1.2dB <Note> 0004 +1.5dB The numbers on the superimposed display are approximations only. 0005 +2dB												
628*5 U/C ENH H	For accentuating the horizontal contours during up-conversion. 0000 0dB 0001 +0.7dB 0002 +1dB 0003 +1.2dB <Note> 0004 +1.5dB The numbers on the superimposed display are approximations only. 0005 +2dB												
629*5 U/C ENH V	For accentuating the vertical contours during up-conversion. 0000 0dB 0001 +0.7dB 0002 +1dB 0003 +1.2dB <Note> 0004 +1.5dB The numbers on the superimposed display are approximations only. 0005 +2dB												
630*2 1080i→HD_ OUT	For selecting the HD output signal format during 1080i tape playback or in the 1080i EE mode. (See table below.) 0000 1080i 0001 720p 0002 1080i												
631*2 1080i→SD_ OUT	For selecting the SD output signal format during 1080i tape playback or in the 1080i EE mode. (See table below.) 0000 480i <Note> 0001 ----- There is no output in the 60 Hz mode. 0002 480p												
<b>Output connectors</b>													
	<table border="1" style="width: 100%; border-collapse: collapse;"> <thead> <tr> <th style="width: 33%;">HD SDI OUT</th> <th style="width: 33%;">SD SDI OUT</th> <th style="width: 33%;">VIDEO OUT</th> </tr> </thead> <tbody> <tr> <td>0000</td> <td>1080i (no conversion)</td> <td>480i (down-converted output)</td> </tr> <tr> <td>0001</td> <td>720p (line-converted output)</td> <td>480i (down-converted output)</td> </tr> <tr> <td>0002</td> <td>1080i (no conversion)</td> <td>480p* (down-converted output)</td> </tr> </tbody> </table>	HD SDI OUT	SD SDI OUT	VIDEO OUT	0000	1080i (no conversion)	480i (down-converted output)	0001	720p (line-converted output)	480i (down-converted output)	0002	1080i (no conversion)	480p* (down-converted output)
HD SDI OUT	SD SDI OUT	VIDEO OUT											
0000	1080i (no conversion)	480i (down-converted output)											
0001	720p (line-converted output)	480i (down-converted output)											
0002	1080i (no conversion)	480p* (down-converted output)											

No./Item	Description of setting												
632*2 720p→HD_ OUT	For selecting the HD output signal format during 720p tape playback or in the 720p EE mode. (See table below.) 0000 1080i 0001 720p 0002 720p												
633*2 720p→SD_ OUT	For selecting the SD output signal format during 720p tape playback or in the 720p EE mode. (See table below.) 0000 ----- <Note> 0001 480i There is no output in the 60 Hz mode. 0002 480p												
<b>Output connectors</b>													
	<table border="1" style="width: 100%; border-collapse: collapse;"> <thead> <tr> <th style="width: 33%;">HD SDI OUT</th> <th style="width: 33%;">SD SDI OUT</th> <th style="width: 33%;">VIDEO OUT</th> </tr> </thead> <tbody> <tr> <td>0000</td> <td>1080i (line-converted output)</td> <td>480i (down-converted output)</td> </tr> <tr> <td>0001</td> <td>720p (no conversion)</td> <td>480i (down-converted output)</td> </tr> <tr> <td>0002</td> <td>720p (no conversion)</td> <td>480p* (down-converted output)</td> </tr> </tbody> </table>	HD SDI OUT	SD SDI OUT	VIDEO OUT	0000	1080i (line-converted output)	480i (down-converted output)	0001	720p (no conversion)	480i (down-converted output)	0002	720p (no conversion)	480p* (down-converted output)
HD SDI OUT	SD SDI OUT	VIDEO OUT											
0000	1080i (line-converted output)	480i (down-converted output)											
0001	720p (no conversion)	480i (down-converted output)											
0002	720p (no conversion)	480p* (down-converted output)											
634*2 480p→HD_ OUT	For selecting the HD output signal format during 480p tape (DVCPRO50P) playback. (See table below.) 0000 1080i 0001 720p 0002 -----												
635*2 480p→SD_ OUT	For selecting the SD output signal format during 480p tape (DVCPRO50P) playback. (See table below.) 0000 480p 0001 480p 0002 480i												
<b>Output connectors</b>													
	<table border="1" style="width: 100%; border-collapse: collapse;"> <thead> <tr> <th style="width: 33%;">HD SDI OUT</th> <th style="width: 33%;">SD SDI OUT</th> <th style="width: 33%;">VIDEO OUT</th> </tr> </thead> <tbody> <tr> <td>0000</td> <td>1080i (up-converted output)</td> <td>480p* (no conversion)</td> </tr> <tr> <td>0001</td> <td>720p (up-converted output)</td> <td>480p* (no conversion)</td> </tr> <tr> <td>0002</td> <td>Muted</td> <td>480i (down-converted output)</td> </tr> </tbody> </table>	HD SDI OUT	SD SDI OUT	VIDEO OUT	0000	1080i (up-converted output)	480p* (no conversion)	0001	720p (up-converted output)	480p* (no conversion)	0002	Muted	480i (down-converted output)
HD SDI OUT	SD SDI OUT	VIDEO OUT											
0000	1080i (up-converted output)	480p* (no conversion)											
0001	720p (up-converted output)	480p* (no conversion)											
0002	Muted	480i (down-converted output)											
<b>&lt;Note&gt;</b> During SD tape playback, the VTR cannot be operated in the 60 Hz mode.													

\*1: This item is not displayed when the 23/24 Hz, 25 Hz (HD or SD) or 50 Hz mode has been selected as the system menu item No.25 (SYSTEM FREQ) setting.

\*2: This item is not displayed when the 25 Hz (HD or SD) mode has been selected as the system menu item No.25 (SYSTEM FREQ) setting.

\* Setup menu item No.107 and INPUT CHECK do not function, and the same signal as this signal line is output.

The underlining (     ) denotes the factory setting mode.

# Setup menus

## <VIDEO> (continued)

No./Item	Description of setting												
636*2 480i→HD_ OUT	For selecting the HD output signal format during 480i tape (DVCPRO50, DVCPRO, DV or DVCAM) playback. (See table below.) 0000 1080i 0001 720p 0002 -----												
637*2 480i→SD_ OUT	For selecting the SD output signal format during 480i tape (DVCPRO50, DVCPRO, DV or DVCAM) playback. (See table below.) 0000 480i 0001 480i 0002 480p												
<b>Output connectors</b>													
	<table border="1" style="width: 100%;"> <thead> <tr> <th>HD SDI OUT</th> <th>SD SDI OUT</th> <th>VIDEO OUT</th> </tr> </thead> <tbody> <tr> <td>0000</td> <td>1080i (up-converted output)</td> <td>480i (no conversion)</td> </tr> <tr> <td>0001</td> <td>720p (up-converted output)</td> <td>480i (no conversion)</td> </tr> <tr> <td>0002</td> <td>Muted</td> <td>480p* (up-converted output)</td> </tr> </tbody> </table>	HD SDI OUT	SD SDI OUT	VIDEO OUT	0000	1080i (up-converted output)	480i (no conversion)	0001	720p (up-converted output)	480i (no conversion)	0002	Muted	480p* (up-converted output)
HD SDI OUT	SD SDI OUT	VIDEO OUT											
0000	1080i (up-converted output)	480i (no conversion)											
0001	720p (up-converted output)	480i (no conversion)											
0002	Muted	480p* (up-converted output)											
<b>&lt;Note&gt;</b> During SD tape playback, the VTR cannot be operated in the 60 Hz mode.													
638*1 IN U/C MODE	For selecting the up-conversion picture frame when SD SDI input signals are supplied. 0000 FIT_V: Side panel mode 0001 FIT_H: Top and bottom cut in vertical direction 0002 FIT_HV: Stretch mode												
639*1 I U/C RESP H	For selecting the horizontal frequency band during the up-conversion of SD SDI input signals. 0000 STD 0001 NARROW												
640*1 I U/C RESP V	For selecting the vertical frequency band during the up-conversion of SD SDI input signals. 0000 STD 0001 NARROW												

\*1: This item is not displayed when the 23/24 Hz or 25 Hz (HD or SD) mode has been selected as the system menu item No.25 (SYSTEM FREQ) setting.

\*2: This item is not displayed when the 23/24 Hz, 25 Hz (HD or SD) or 50 Hz mode has been selected as the system menu item No.25 (SYSTEM FREQ) setting.

\*3: This item is not displayed when the 50 Hz or 25 Hz (HD or SD) mode has been selected as the system menu item No.25 (SYSTEM FREQ) setting.

\* Setup menu item No.107 and INPUT CHECK do not function, and the same signal as this signal line is output.

### <Note>

Setup menu items No.638, 639, 640, 641 and 642 do not function when the AJ-UC1700G optional board has not been installed.

The underlining (     ) denotes the factory setting mode.

\*UP: With HD output (HD tape playback or up-converted output)

\*DW: With SD output (SD tape playback or down-converted output)

No./Item	Description of setting
641*2 I U/C ENH H	For accentuating the horizontal contours during up-conversion of SD SDI input signals. 0000 0dB 0001 +0.7dB 0002 +1dB 0003 +1.2dB 0004 +1.5dB 0005 +2dB <b>&lt;Note&gt;</b> The numbers on the superimposed display are approximations only.
642*2 I U/C ENH V	For accentuating the vertical contours during up-conversion of SD SDI input signals. 0000 0dB 0001 +0.7dB 0002 +1dB 0003 +1.2dB 0004 +1.5dB 0005 +2dB <b>&lt;Note&gt;</b> The numbers on the superimposed display are approximations only.
650 STYLE	0000* <u>CMPNT</u> *: Level adjustment mode for the component style 0001 <u>CMPST</u> : Level adjustment mode for the composite style <b>* The asterisk denotes the factory setting for AJ-HD1700E.</b>
651*3 HUE STYLE (SD)*DW	For selecting the rotational axis of the chroma phase adjustment. 0000 <u>Pb-Pr</u> : The axis rotates in a perfect circle on the SDI (component style) vectorscope. 0001 <u>U-V</u> : The axis rotates in a perfect circle on the analog (composite style) vectorscope.
653 Y LVL (HD)*UP	For adjusting the Y level of the HD SDI output. (−∞ to 0 dB to +3 dB) 0000 0.0% : : <b>&lt;Note&gt;</b> 1000 100.0% This setting takes effect when : : "CMPNT" has been selected as the 1413 141.3% setup menu item No.650 setting.
654 Pb LVL (HD)*UP	For adjusting the PB level of the HD SDI output. (−∞ to 0 dB to +3 dB) 0000 0.0% : : <b>&lt;Note&gt;</b> 1000 100.0% This setting takes effect when : : "CMPNT" has been selected as the 1413 141.3% setup menu item No.650 setting.
655 Pr LVL (HD)*UP	For adjusting the PB level of the HD SDI output. (−∞ to 0 dB to +3 dB) 0000 0.0% : : <b>&lt;Note&gt;</b> 1000 100.0% This setting takes effect when : : "CMPNT" has been selected as the 1413 141.3% setup menu item No.650 setting.
656 BK LVL (HD)*UP	For adjusting the black level of the HD SDI output. 50 −10.0% : : <b>&lt;Note&gt;</b> 150 0.0% This setting takes effect when : : "CMPNT" has been selected as the 250 +10.0% setup menu item No.650 setting.

# Setup menus

## <VIDEO> (continued)

No./Item	Description of setting
658 Y LVL (SD)*DW	For adjusting the Y level of the SD SDI output and VIDEO output. (-∞ to 0 dB to +3 dB) 0000 0.0% : : <Note> <u>1000</u> <u>100.0%</u> This setting takes effect when : : "CMPNT" has been selected as the 1413 141.3% setup menu item No.650 setting.
659 Pb LVL (SD)*DW	For adjusting the PB level of the SD SDI output and VIDEO output. (-∞ to 0 dB to +3 dB) 0000 0.0% : : <Note> <u>1000</u> <u>100.0%</u> This setting takes effect when : : "CMPNT" has been selected as the 1413 141.3% setup menu item No.650 setting.
660 Pr LVL (SD)*DW	For adjusting the PR level of the SD SDI output and VIDEO output. (-∞ to 0 dB to +3 dB) 0000 0.0% : : <Note> <u>1000</u> <u>100.0%</u> This setting takes effect when : : "CMPNT" has been selected as the 1413 141.3% setup menu item No.650 setting.
661 BK LVL (SD)*DW	For adjusting the black level of the SD SDI output and VIDEO output. 50 -10.0% : : <Note> <u>150</u> <u>0.0%</u> This setting takes effect when : : "CMPNT" has been selected as the 250 +10.0% setup menu item No.650 setting.
662 V LEVEL	For adjusting the video level of the HD SDI output, SD SDI output and VIDEO output. (-∞ to 0 dB to +6 dB) 0000 0.0% : : <Note> <u>1000</u> <u>100.0%</u> This setting takes effect when : : "CMPST" has been selected as the 2000 200.0% setup menu item No.650 setting.
663 C LEVEL	For adjusting the chroma level of the HD SDI output, SD SDI output and VIDEO output. (-∞ to 0 dB to +3 dB) 0000 0.0% : : <Note> <u>1000</u> <u>100.0%</u> This setting takes effect when : : "CMPST" has been selected as the 1413 141.3% setup menu item No.650 setting.

\* This is the name of the menu item for AJ-HD1700E.

No./Item	Description of setting
664 HUE (C PHASE*)	For adjusting the chroma phase of the HD SDI output, SD SDI output and VIDEO output. (Approx. -30° to +30°) 0000 -31.0 : : <Note> <u>0062</u> <u>0.0</u> This setting takes effect when : : "CMPST" has been selected as the 0124 31.0 setup menu item No.650 setting. <Note> If 0 (50) or 3 [25 (HD)] or 4 [25 (SD)] has been selected as the system menu item No.25 (SYSTEM FREQ) setting: • The HD SDI output cannot be adjusted. • The SD SDI output and video output can be adjusted only when an SD format tape is being created.
665 SETUP LVL (BK LVL*)	For adjusting the setup (black*) level of the HD SDI output, SD SDI output and VIDEO output. (-10% to +10%) 50 -10.0% : : <Note> <u>150</u> <u>0.0%</u> This setting takes effect when : : "CMPST" has been selected as the 250 +10.0% setup menu item No.650 setting.
670 BRIGHT	For adjusting the brightness of the LCD monitor on the front panel. 0 -127 : : <u>127</u> <u>0</u> : : 254 127
671 R-BRIGHT	For adjusting the brightness (red) of the LCD monitor on the front panel. 0 -127 : : <u>127</u> <u>0</u> : : 254 127
672 B-BRIGHT	For adjusting the brightness (blue) of the LCD monitor on the front panel. 0 -127 : : <u>127</u> <u>0</u> : : 254 127
673 CONTRAST	For adjusting the contrast of the LCD monitor on the front panel. 0 -127 : : <u>127</u> <u>0</u> : : 254 127
674 R-CONTRAST	For adjusting the contrast (red) of the LCD monitor on the front panel. 0 -127 : : <u>127</u> <u>0</u> : : 254 127

The underlining (    ) denotes the factory setting mode.

\*DW: With SD output (SD tape playback or down-converted output)



# Setup menus

## <VIDEO> (continued)

No./Item	Description of setting
675 B-CONTRAST	For adjusting the contrast (blue) of the LCD monitor on the front panel. 0     -127 :     : <u>127</u> 0 :     : 254    127
676*3 BLK CLIP	This function clips the signals below the pedestal level for SD SDI OUT and composite OUT Y (luminance) signals. 0000 OFF: The signals are not clipped. 0001 ON: The signals are clipped.
680*2 CC (F1) BLANK*DW	For selecting ON or OFF for the closed caption signals in the first field. 0000 BLANK: The signals are forcibly blanked. 0001 THRU: The signals are not blanked.
681*2 CC (F2) BLANK*DW	For selecting ON or OFF for the closed caption signals in the second field. 0000 BLANK: The signals are forcibly blanked. 0001 THRU: The signals are not blanked.
682 VO SETUP (HD)*UP (This menu is not displayed for AJ-HD1700E.)	This selects the composite output signal in HD mode. 0000 THRU: The signal is output with no setup added. 0001 ADD22L: The signal is output from line 22 with a 7.5% setup added. 0002 ADD21L: The signal is output from line 21 with a 7.5% setup added. 0002 ADD20L: The signal is output from line 20 with a 7.5% setup added.
683 VO SETUP (SD)*DW (This menu is not displayed for AJ-HD1700E.)	This selects the composite output signal in SD mode. 0000 THRU: The signal is output with no setup added. 0001 ADD22L: The signal is output from line 22 with a 7.5% setup added. 0002 ADD21L: The signal is output from line 21 with a 7.5% setup added. 0002 ADD20L: The signal is output from line 20 with a 7.5% setup added.
684 EDH (SD)*DW	For selecting whether to superimpose EDH on the serial output signals. 0000 OFF: EDH is not superimposed. 0001 ON: EDH is superimposed.
685*2 ESR MODE (SD)*DW	For selecting the operation mode for edge subcarrier reduction (ESR) in the playback circuit. 0000 OFF: ESR is forcibly set to OFF. 0001 AUTO: ESR is automatically set to ON or OFF in accordance with the VTR operation.
686*2 CCR MODE (SD)*DW	For selecting the cross color processing during playback. 0000 OFF: The cross color is output as is. 0001 ON: The cross color can be reduced.
687*4 SDI INDEX 0 *DW	For selecting whether to superimpose the VIDEO INDEX signal on the SD SDI output signal. 0000 OFF: The VIDEO INDEX signal is not superimposed on the SD SDI output signal. 0001 ON: The VIDEO INDEX signal is superimposed on the SD SDI output signal.

No./Item	Description of setting
688*2 CC REC	For selecting whether to record the closed caption signals which are superimposed on the SD input signal. 0000 OFF: The closed caption signals are not recorded on the tape. 0001 ON: The closed caption signals are recorded on the tape if they are superimposed on the SD input signal. In this case, they are blanked, up-converted and then recorded. <b>&lt;Notes&gt;</b> • When SDTI has been selected as the input signal, the closed caption data superimposed on the compressed input signals is recorded on the tape in its original form regardless of this menu item's setting. • Setup menu item No.688 does not function when the AJ-UC1700G optional board has not been installed.
695*1 BLANK LINE	For selecting ON or OFF for blanking for the vertical blanking period of the video signals during SD tape playback. 0000 BLANK: All the lines are forcibly blanked. 0001 THRU: None of the lines are blanked. 0002 MANU: Blanking ON or OFF is selected on a line-by-line basis. <b>&lt;Note&gt;</b> When 2 (MANU) is set and the [SHIFT] button is pressed, the display transfers to the submenu screen where the ON or OFF can be set for each line. Press the [SHIFT] button again to return the display from the submenu screen.
<b>Submenu screen &lt;59/60 Hz&gt;</b>	
01 LINE 11&274 : : 12 LINE 22&285	0000 BLANK: The lines are forcibly blanked. 0001 THRU: The lines are not blanked.
<b>Submenu screen &lt;50Hz&gt;</b>	
00 LINE 7&320 : : 15 LINE 22&335	0000 BLANK: The lines are forcibly blanked. 0001 THRU: The lines are not blanked

\*1: This item is not displayed when the 23/24 Hz or 25 Hz (HD or SD) mode has been selected as the system menu item No.25 (SYSTEM FREQ) setting.

\*2: This item is not displayed when the 23/24 Hz, 25 Hz (HD or SD) or 50 Hz mode has been selected as the system menu item No.25 (SYSTEM FREQ) setting.

\*3: This item is not displayed when the 50 Hz or 25 Hz (HD or SD) mode has been selected as the system menu item No.25 (SYSTEM FREQ) setting.

\*4: This item is not displayed when the 23/24 Hz or 25 Hz (HD) mode has been selected as the system menu item No.25 (SYSTEM FREQ) setting.

The underlining (     ) denotes the factory setting mode.

\*UP: With HD output (HD tape playback or up-converted output)

\*DW: With SD output (SD tape playback or down-converted output)

# Setup menus

## <AUDIO>

No./Item	Description of setting
700* <sup>1</sup> CH1 IN LV	For selecting the audio input (CH1) reference level. 0000 4dB <u>0001</u> 0dB 0002 -20dB
701* <sup>1</sup> CH2 IN LV	For selecting the audio input (CH2) reference level. 0000 4dB <u>0001</u> 0dB 0002 -20dB
702* <sup>1</sup> CH3 IN LV	For selecting the audio input (CH3) reference level. 0000 4dB <u>0001</u> 0dB 0002 -20dB
703* <sup>1</sup> CH4 IN LV	For selecting the audio input (CH4) reference level. 0000 4dB <u>0001</u> 0dB 0002 -20dB
704* <sup>1</sup> CUE IN LV	For selecting the CUE input reference level. 0000 4dB <u>0001</u> 0dB 0002 -20dB 0003 -60dB
705 CH1 OUT LV	For selecting the audio output (CH1) reference level. 0000 4dB <u>0001</u> 0dB 0002 -20dB
706 CH2 OUT LV	For selecting the audio output (CH2) reference level. 0000 4dB <u>0001</u> 0dB 0002 -20dB
707 CH3 OUT LV	For selecting the audio output (CH3) reference level. 0000 4dB <u>0001</u> 0dB 0002 -20dB
708 CH4 OUT LV	For selecting the audio output (CH4) reference level. 0000 4dB <u>0001</u> 0dB 0002 -20dB
709 CUE OUT LV	For selecting the CUE output reference level. 0000 4dB <u>0001</u> 0dB 0002 -20dB

No./Item	Description of setting
710 MONIL OUT LV	For selecting the audio monitor output (Lch) reference level. 0000 4dB <u>0001</u> 0dB 0002 -20dB
711 MONIR OUT LV	For selecting the audio monitor output (Rch) reference level. 0000 4dB <u>0001</u> 0dB 0002 -20dB
712 MONI OUT	For selecting the audio monitor output UNITY or VARIABLE level. 0000 UNITY: The signals are output at a fixed level. <u>0001</u> VAR: The signal output is coupled with the headphones volume control.
713* <sup>1</sup> CH1 IN SEL	For selecting the CH1 input signal. 0000 INT SG: The internal signal is selected. <u>0001</u> DIGI: Digital input signals are selected. 0002 ANA: Analog input signals are selected.  <Note> When DIGI has been selected, whether serial or AES is selected for the input is determined by the setting selected for setup menu item No.721 (D IN SEL 12).
714* <sup>1</sup> CH2 IN SEL	For selecting the CH2 input signal. 0000 INT SG: The internal signal is selected. <u>0001</u> DIGI: Digital input signals are selected. 0002 ANA: Analog input signals are selected.  <Note> When DIGI has been selected, whether serial or AES is selected for the input is determined by the setting selected for setup menu item No.721 (D IN SEL 12).
715* <sup>1</sup> CH3 IN SEL	For selecting the CH3 input signal. 0000 INT SG: The internal signal is selected. <u>0001</u> DIGI: Digital input signals are selected. 0002 ANA: Analog input signals are selected.  <Note> When DIGI has been selected, whether serial or AES is selected for the input is determined by the setting selected for setup menu item No.722 (D IN SEL 34).
716* <sup>1</sup> CH4 IN SEL	For selecting the CH4 input signal. 0000 INT SG: The internal signal is selected. <u>0001</u> DIGI: Digital input signals are selected. 0002 ANA: Analog input signals are selected.  <Note> When DIGI has been selected, whether serial or AES is selected for the input is determined by the setting selected for setup menu item No.722 (D IN SEL 34).

\*1: This item is not displayed when the 23/24 Hz or 25 Hz (HD or SD) mode has been selected as the system menu item No.25 (SYSTEM FREQ) setting.

The underlining (    ) denotes the factory setting mode.

# Setup menus

## <AUDIO> (continued)

No./Item	Description of setting
717* <sup>1</sup> CH5 IN SEL	<p><b>For selecting the CH5 input signal.</b></p> <p><u>0000</u> INT SG: The internal signal is selected.</p> <p><u>0001</u> DIGI: Digital input signals are selected.</p> <p>0002 ANA: Analog input signals are selected. (CH1 input)</p> <p>&lt;Note&gt; When DIGI has been selected, whether serial or AES is selected for the input is determined by the setting selected for setup menu item No.723 (D IN SEL 56).</p>
718* <sup>1</sup> CH6 IN SEL	<p><b>For selecting the CH6 input signal.</b></p> <p><u>0000</u> INT SG: The internal signal is selected.</p> <p><u>0001</u> DIGI: Digital input signals are selected.</p> <p>0002 ANA: Analog input signals are selected. (CH2 input)</p> <p>&lt;Note&gt; When DIGI has been selected, whether serial or AES is selected for the input is determined by the setting selected for setup menu item No.723 (D IN SEL 56).</p>
719* <sup>1</sup> CH7 IN SEL	<p><b>For selecting the CH7 input signal.</b></p> <p><u>0000</u> INT SG: The internal signal is selected.</p> <p><u>0001</u> DIGI: Digital input signals are selected.</p> <p>0002 ANA: Analog input signals are selected. (CH3 input)</p> <p>&lt;Note&gt; When DIGI has been selected, whether serial or AES is selected for the input is determined by the setting selected for setup menu item No.724 (D IN SEL 78).</p>
720* <sup>1</sup> CH8 IN SEL	<p><b>For selecting the CH8 input signal.</b></p> <p><u>0000</u> INT SG: The internal signal is selected.</p> <p><u>0001</u> DIGI: Digital input signals are selected.</p> <p>0002 ANA: Analog input signals are selected. (CH4 input)</p> <p>&lt;Note&gt; When DIGI has been selected, whether serial or AES is selected for the input is determined by the setting selected for setup menu item No.724 (D IN SEL 78).</p>
721* <sup>1</sup> D IN SEL12	<p><b>For selecting the CH1 and CH2 digital input signals.</b></p> <p><u>0000</u> AES: AES/EBU</p> <p>0001 SDI: Serial</p>
722* <sup>1</sup> D IN SEL34	<p><b>For selecting the CH3 and CH4 digital input signals.</b></p> <p><u>0000</u> AES: AES/EBU</p> <p>0001 SDI: Serial</p>
723* <sup>1</sup> D IN SEL56	<p><b>For selecting the CH5 and CH6 digital input signals.</b></p> <p><u>0000</u> AES: AES/EBU</p> <p>0001 SDI: Serial</p>
724* <sup>1</sup> D IN SEL78	<p><b>For selecting the CH7 and CH8 digital input signals.</b></p> <p><u>0000</u> AES: AES/EBU</p> <p>0001 SDI: Serial</p>

No./Item	Description of setting
725* <sup>1</sup> REC CH1	<p><b>For selecting the input signals to be recorded on the audio CH1 track.</b></p> <p><u>0000</u> CH1: Audio input CH1 signals</p> <p>0001 CH2: Audio input CH2 signals</p> <p>0002 CH3: Audio input CH3 signals</p> <p>0003 CH4: Audio input CH4 signals</p> <p>0004 CH1+2: Audio input CH1 and CH2 mixed signals</p> <p>0005 CH3+4: Audio input CH3 and CH4 mixed signals</p>
726* <sup>1</sup> REC CH2	<p><b>For selecting the input signals to be recorded on the audio CH2 track.</b></p> <p><u>0000</u> CH1: Audio input CH1 signals</p> <p><u>0001</u> CH2: Audio input CH2 signals</p> <p>0002 CH3: Audio input CH3 signals</p> <p>0003 CH4: Audio input CH4 signals</p> <p>0004 CH1+2: Audio input CH1 and CH2 mixed signals</p> <p>0005 CH3+4: Audio input CH3 and CH4 mixed signals</p>
727* <sup>1</sup> REC CH3	<p><b>For selecting the input signals to be recorded on the audio CH3 track.</b></p> <p><u>0000</u> CH1: Audio input CH1 signals</p> <p>0001 CH2: Audio input CH2 signals</p> <p><u>0002</u> CH3: Audio input CH3 signals</p> <p>0003 CH4: Audio input CH4 signals</p> <p>0004 CH1+2: Audio input CH1 and CH2 mixed signals</p> <p>0005 CH3+4: Audio input CH3 and CH4 mixed signals</p>
728* <sup>1</sup> REC CH4	<p><b>For selecting the input signals to be recorded on the audio CH4 track.</b></p> <p><u>0000</u> CH1: Audio input CH1 signals</p> <p>0001 CH2: Audio input CH2 signals</p> <p>0002 CH3: Audio input CH3 signals</p> <p><u>0003</u> CH4: Audio input CH4 signals</p> <p>0004 CH1+2: Audio input CH1 and CH2 mixed signals</p> <p>0005 CH3+4: Audio input CH3 and CH4 mixed signals</p>
729* <sup>1</sup> REC CH5	<p><b>For selecting the input signals to be recorded on the audio CH5 track.</b></p> <p><u>0000</u> CH5: Audio input CH5 signals</p> <p>0001 CH6: Audio input CH6 signals</p> <p>0002 CH7: Audio input CH7 signals</p> <p>0003 CH8: Audio input CH8 signals</p> <p>0004 CH5+6: Audio input CH5 and CH6 mixed signals</p> <p>0005 CH7+8: Audio input CH7 and CH8 mixed signals</p>

\*1: This item is not displayed when the 23/24 Hz or 25 Hz (HD or SD) mode has been selected as the system menu item No.25 (SYSTEM FREQ) setting.

The underlining (     ) denotes the factory setting mode.

# Setup menus

## <AUDIO> (continued)

No./Item	Description of setting
730*1 REC CH6	<p>For selecting the input signals to be recorded on the audio CH6 track.</p> <p>0000 <u>CH5</u>: Audio input CH5 signals            0001 <u>CH6</u>: Audio input CH6 signals            0002 <u>CH7</u>: Audio input CH7 signals            0003 <u>CH8</u>: Audio input CH8 signals            0004 <u>CH5+6</u>: Audio input CH5 and CH6 mixed signals            0005 <u>CH7+8</u>: Audio input CH7 and CH8 mixed signals</p>
731*1 REC CH7	<p>For selecting the input signals to be recorded on the audio CH7 track.</p> <p>0000 <u>CH5</u>: Audio input CH5 signals            0001 <u>CH6</u>: Audio input CH6 signals            0002 <u>CH7</u>: Audio input CH7 signals            0003 <u>CH8</u>: Audio input CH8 signals            0004 <u>CH5+6</u>: Audio input CH5 and CH6 mixed signals            0005 <u>CH7+8</u>: Audio input CH7 and CH8 mixed signals</p>
732*1 REC CH8	<p>For selecting the input signals to be recorded on the audio CH8 track.</p> <p>0000 <u>CH5</u>: Audio input CH5 signals            0001 <u>CH6</u>: Audio input CH6 signals            0002 <u>CH7</u>: Audio input CH7 signals            0003 <u>CH8</u>: Audio input CH8 signals            0004 <u>CH5+6</u>: Audio input CH5 and CH6 mixed signals            0005 <u>CH7+8</u>: Audio input CH7 and CH8 mixed signals</p>
733*1 REC CUE	<p>For selecting the input signals to be recorded on the CUE track.</p> <p>0000 <u>CUE</u>: CUE IN            0001 <u>CH1</u>: Audio input CH1 signals            0002 <u>CH2</u>: Audio input CH2 signals            0003 <u>CH3</u>: Audio input CH3 signals            0004 <u>CH4</u>: Audio input CH4 signals            0005 <u>CH5</u>: Audio input CH5 signals            0006 <u>CH6</u>: Audio input CH6 signals            0007 <u>CH7</u>: Audio input CH7 signals            0008 <u>CH8</u>: Audio input CH8 signals            0009 <u>CH1+2</u>:            Audio input CH1 and CH2 mixed signals            0010 <u>CH3+4</u>:            Audio input CH3 and CH4 mixed signals            0011 <u>CH5+6</u>:            Audio input CH5 and CH6 mixed signals            0012 <u>CH7+8</u>:            Audio input CH7 and CH8 mixed signals            0013 <u>CH1-8</u>:            Audio input CH1 to CH8 mixed signals</p>

No./Item	Description of setting
734*1 PB FADE	<p>For selecting how to process the audio edit points (IN points and OUT points) during playback.</p> <p>0000 <u>AUTO</u>: The status established during recording is followed.            0001 <u>CUT</u>: Forcibly cut            0002 <u>FADE</u>: Forcibly faded</p>
735 HD EMBD AUD	<p>For selecting whether to superimpose the audio data on the HD serial output.</p> <p>0000 <u>OFF</u>: The audio data is not superimposed.            0001 <u>ON</u>: The audio data is superimposed.</p>
736 SD EMBD AUD	<p>For selecting whether to superimpose the audio data on the SD serial output.</p> <p>0000 <u>OFF</u>: The audio data is not superimposed.            0001 <u>ON</u>: The audio data is superimposed.</p>
737 MONI MIX	<p>For selecting the mixed signals for the headphone monitor (Lch and/or Rch).</p> <p>0000 <u>OFF</u>: Neither the Lch nor Rch signals are mixed.            0001 <u>L</u>: Only the Lch signals are mixed.            0002 <u>R</u>: Only the Rch signals are mixed.            0003 <u>L/R</u>: Both the Lch and Rch signals are mixed.</p> <p>&lt;Notes&gt;</p> <ul style="list-style-type: none"> <li>At the OFF setting, the signals to be output to monitor L (or monitor R) are switched to CH1, CH2, CH3 and so on each time the "L" or "R" button is pressed. The selected signals are displayed below the audio level meter.</li> <li>At the L, R or L/R setting, the signals of a multiple number of channels can be mixed and output. When the number key corresponding to the channel whose signals are to be monitored is pressed while the "L" (or "R") button is held down, that channel is selected. The selected channel is displayed below the audio level meter. (Alternatively, the same steps can be taken to de-select a channel which has already been selected.) However, only up to 2 channels among the CH1-CH4 channels and up to 2 channels among the CH5 to CH8 channels can be selected.</li> </ul>
738 CH1 CUE SEL	<p>For selecting the CH1 output status of the main signal line in the search mode.</p> <p>0000 <u>OFF</u>:            The CUE signal is not output.            0001 <u>ON</u>:            The CUE signal is output.</p> <p>&lt;Note&gt;            For details on the audio output statuses, refer to "Audio outputs in the search mode" on page 103.</p>

\*1: This item is not displayed when the 23/24 Hz or 25 Hz (HD or SD) mode has been selected as the system menu item No.25 (SYSTEM FREQ) setting.

The underlining (   ) denotes the factory setting mode.

# Setup menus

## <AUDIO> (continued)

No./Item	Description of setting
739 CH2 CUE SEL	<p><b>For selecting the CH2 output status of the main signal line in the search mode.</b></p> <p><u>0000</u> OFF: The CUE signal is not output.</p> <p>0001 ON: The CUE signal is output.</p> <p>&lt;Note&gt; For details on the audio output statuses, refer to "Audio outputs in the search mode" on page 103.</p>
740 CH3 CUE SEL	<p><b>For selecting the CH3 output status of the main signal line in the search mode.</b></p> <p><u>0000</u> OFF: The CUE signal is not output.</p> <p>0001 ON: The CUE signal is output.</p> <p>&lt;Note&gt; For details on the audio output statuses, refer to "Audio outputs in the search mode" on page 103.</p>
741 CH4 CUE SEL	<p><b>For selecting the CH4 output status of the main signal line in the search mode.</b></p> <p><u>0000</u> OFF: The CUE signal is not output.</p> <p>0001 ON: The CUE signal is output.</p> <p>&lt;Note&gt; For details on the audio output statuses, refer to "Audio outputs in the search mode" on page 103.</p>
742 CH5 CUE SEL	<p><b>For selecting the CH5 output status of the main signal line in the search mode.</b></p> <p><u>0000</u> OFF: The CUE signal is not output.</p> <p>0001 ON: The CUE signal is output.</p> <p>&lt;Note&gt; For details on the audio output statuses, refer to "Audio outputs in the search mode" on page 103.</p>
743 CH6 CUE SEL	<p><b>For selecting the CH6 output status of the main signal line in the search mode.</b></p> <p><u>0000</u> OFF: The CUE signal is not output.</p> <p>0001 ON: The CUE signal is output.</p> <p>&lt;Note&gt; For details on the audio output statuses, refer to "Audio outputs in the search mode" on page 103.</p>
744 CH7 CUE SEL	<p><b>For selecting the CH7 output status of the main signal line in the search mode.</b></p> <p><u>0000</u> OFF: The CUE signal is not output.</p> <p>0001 ON: The CUE signal is output.</p> <p>&lt;Note&gt; For details on the audio output statuses, refer to "Audio outputs in the search mode" on page 103.</p>

No./Item	Description of setting
745 CH8 CUE SEL	<p><b>For selecting the CH8 output status of the main signal line in the search mode.</b></p> <p><u>0000</u> OFF: The CUE signal is not output.</p> <p>0001 ON: The CUE signal is output.</p> <p>&lt;Note&gt; For details on the audio output statuses, refer to "Audio outputs in the search mode" on page 103.</p>
746 MONI CH SEL	<p><b>For selecting the monitor output.</b></p> <p>0000 <u>MANU</u>: The signal selected by the MONITOR SELECT button is output.</p> <p>0001 <u>AUTO</u>: The PCM audio signal is output in the <math>-1.0\times</math> to <math>+2.0\times</math> speed range; the CUE signal is automatically output at all other speeds.</p> <p>0002 <u>PCM</u>: The PCM audio signal is output in the <math>-32\times</math> to <math>+32\times</math> speed range.</p> <p>&lt;Notes&gt;</p> <ul style="list-style-type: none"> <li>When "AUTO" is selected and a tape in any format except DVCPRO HD-LP is played back, the PCM audio signals are output in the <math>-1.0\times</math> to <math>+1.1\times</math> speed range.</li> <li>This setting takes effect when the L and R MONITOR SELECT switches on the VTR's front panel have selected a channel from CH1 to CH8. (If they have selected CUE, the CUE signal is output at all speeds regardless of this menu item's setting.)</li> </ul>
747 MON AUTO SEL	<p><b>For selecting the channel for the monitor output to be switched to CUE.</b></p> <p>When a setting other than "MANU" has been selected for setup menu item No.746 (MONI CH SEL), the CUE signal is automatically output to the monitor output in accordance with the operation mode, and the monitor channel to be switched to CUE is selected automatically.</p> <p><u>0000</u> <u>L/R</u>: The CUE signal is output both to the Lch and Rch.</p> <p>0001 L: The CUE signal is output to the Lch only.</p> <p>0002 R: The CUE signal is output to the Rch only.</p>
748 MONI SEL INH	<p><b>For selecting whether to enable or inhibit the operation of the MONITOR SELECT button on the front panel.</b></p> <p><u>0000</u> OFF: The button's operation is enabled.</p> <p>0001 ON: The button's operation is inhibited.</p> <p>0002 ON1: In the FULL display mode, operation is prohibited; in the FINE display mode only, operation is enabled.</p> <p>&lt;Note&gt; Whether to enable or inhibit the button's operation can be selected for channels whose signals have not been mixed by the setup menu item No.737 (MONI MIX) setting.</p>

The underlining (     ) denotes the factory setting mode.

# Setup menus

## <AUDIO> (continued)

No./Item	Description of setting	No./Item	Description of setting
749*1 AUDIO PB VR	For selecting whether the playback level adjustment controls are to function in the EE mode when INT SG has been selected on the <AUDIO> function menu. <u>0000</u> <b>DIS</b> : The INT SG output level is fixed at the UNITY level. 0001 <b>ENA</b> : The INT SG output level can be varied using the playback level adjustment controls.	757 SD SDI CH4 SL	For selecting the audio CH4 signal to be superimposed onto the SD SDI output 0000 <b>CH1</b> : The CH1 signal is output. 0001 <b>CH2</b> : The CH2 signal is output. 0002 <b>CH3</b> : The CH3 signal is output. <u>0003</u> <b>CH4</b> : The CH4 signal is output. 0004 <b>CH5</b> : The CH5 signal is output. 0005 <b>CH6</b> : The CH6 signal is output. 0006 <b>CH7</b> : The CH7 signal is output. 0007 <b>CH8</b> : The CH8 signal is output.
750 ANA CH1 SEL	For selecting the signal to be output to analog output CH1. <u>0000</u> <b>CH1</b> : The CH1 signal is output. 0001 <b>CH5</b> : The CH5 signal is output	758 JOG PROC	For selecting how to process the digital audio output slow signals in the JOG, VAR or SHTL mode. 0000 <b>OFF</b> : The sound without having the digital audio output slow signals processed is output even when the STILL mode is established. <u>0001</u> <b>ON</b> : The sound after having the digital audio output slow signals processed is output.
751 ANA CH2 SEL	For selecting the signal to be output to analog output CH2. <u>0000</u> <b>CH2</b> : The CH2 signal is output. 0001 <b>CH6</b> : The CH6 signal is output.	759 DV PB ATT	For selecting the audio output level during DV format playback. 0000 <b>OFF</b> : The audio output level is not attenuated. <u>0001</u> <b>ON</b> : The audio output level is attenuated.
752 ANA CH3 SEL	For selecting the signal to be output to analog output CH3. <u>0000</u> <b>CH3</b> : The CH3 signal is output. 0001 <b>CH7</b> : The CH7 signal is output.	760*1 REC PT MUTE	For selecting whether to mute the sound at the joins between recordings during DV or DVCAM format playback. <u>0000</u> <b>OFF</b> : The sound is not muted. 0001 <b>ON</b> : The sound is muted.
753 ANA CH4 SEL	For selecting the signal to be output to analog output CH4. <u>0000</u> <b>CH4</b> : The CH4 signal is output. 0001 <b>CH8</b> : The CH8 signal is output.	761*1 AUDIO INT SG	For selecting the type of internal signal. <u>0000</u> <b>TONE</b> : A sine wave signal is selected. 0001 <b>SILNCE</b> : A silent signal is selected.
754 SD SDI CH1 SL	For selecting the audio CH1 signal to be superimposed onto the SD SDI output. <u>0000</u> <b>CH1</b> : The CH1 signal is output. 0001 <b>CH2</b> : The CH2 signal is output. 0002 <b>CH3</b> : The CH3 signal is output. 0003 <b>CH4</b> : The CH4 signal is output. 0004 <b>CH5</b> : The CH5 signal is output. 0005 <b>CH6</b> : The CH6 signal is output. 0006 <b>CH7</b> : The CH7 signal is output. 0007 <b>CH8</b> : The CH8 signal is output.	762 AUD RATE CON	This item enables signals to be recorded and played back without passing them through the rate converter in the audio input/output section (without engaging the digital filter). 0000 <b>OFF</b> : The signals are recorded and played back without passing them through the rate converter. <u>0001</u> <b>ON</b> : The signals are recorded and played back after passing them through the rate converter. <Notes> • ON/OFF control is exercised at the same time for both recording and playback. It cannot be set differently for recording or playback. • ON/OFF control is exercised at the same time for CH1 to CH8. ON or OFF cannot be set independently for each channel. • When the rate converter is set to OFF, the video input signals and AES (EBU) input signals must be synchronized. Moreover, the video input signals and reference signal selected by OUT REF must also be synchronized. (Noise may occur if these signals are not synchronized.) • In the 60 Hz mode, noise may occur if OFF is set for the rate converter.
755 SD SDI CH2 SL	For selecting the audio CH2 signal to be superimposed onto the SD SDI output 0000 <b>CH1</b> : The CH1 signal is output. <u>0001</u> <b>CH2</b> : The CH2 signal is output. 0002 <b>CH3</b> : The CH3 signal is output. 0003 <b>CH4</b> : The CH4 signal is output. 0004 <b>CH5</b> : The CH5 signal is output. 0005 <b>CH6</b> : The CH6 signal is output. 0006 <b>CH7</b> : The CH7 signal is output. 0007 <b>CH8</b> : The CH8 signal is output.		
756 SD SDI CH3 SL	For selecting the audio CH3 signal to be superimposed onto the SD SDI output 0000 <b>CH1</b> : The CH1 signal is output. 0001 <b>CH2</b> : The CH2 signal is output. <u>0002</u> <b>CH3</b> : The CH3 signal is output. 0003 <b>CH4</b> : The CH4 signal is output. 0004 <b>CH5</b> : The CH5 signal is output. 0005 <b>CH6</b> : The CH6 signal is output. 0006 <b>CH7</b> : The CH7 signal is output. 0007 <b>CH8</b> : The CH8 signal is output.		

\*1: This item is not displayed when the 23/24 Hz or 25 Hz (HD or SD) mode has been selected as the system menu item No.25 (SYSTEM FREQ) setting.

The underlining (     ) denotes the factory setting mode.

# Setup menus

## <AUDIO> (continued)

No./Item	Description of setting
763 METER SCALE (This menu is not displayed for AJ-HD1700E.)	For selecting the scale display of the audio level meter. 0000 PEAK_0: [The audio level is displayed with 0 dB as the maximum level. 0001 REF_0: The audio level is displayed with 0 dB as the reference level.
790*5 CUE REC VOL	For adjusting the recording level of the CUE audio signal. (-∞ to 0 dB to +12 dB) 0032 16 : : 0016 0 : : 0000 -16 <b>&lt;Note&gt;</b> This item is not displayed when the 23/24 Hz mode has been selected as the system menu item No.25 (SYSTEM FREQ) setting.

No./Item	Description of setting
791 CUE PB VOL	For adjusting the playback level of the CUE audio signal. (-∞ to 0 dB to +12 dB) 0032 16 : : 0016 0 : : 0000 -16

The underlining (    ) denotes the factory setting mode.

### Audio outputs in the search mode

The table below lists the signals which are output to the monitor and main signal line and which are determined by how the settings of menu items No.738 to No.745, and No.746 and No.747 are combined.

738 CH1 CUE SEL: : 745 CH8 CUE SEL	746 MONI CH SEL	747 MON AUTO SEL	Monitor output		Main signal line output		
			Lch	Rch	CH1/CH3/CH5/CH7	CH2/CH4/CH6/CH8	
OFF	MANU	L/R	PC*1	PCM*1	PCM*1	PCM*1	
		L					
		R					
	AUTO	L/R	CUE*2	CUE*2			
		L	CUE*2	PCM*1			
		R	PCM*1	CUE*2			
	PCM	L/R	PCM*3	PCM*3	PCM*4	PCM*4	
		L					
		R					
ON	MANU	L/R	PCM*1	PCM*1	PCM*1	PCM*1	
		L					
		R					
	AUTO	L/R	CUE*2	CUE*2	CUE*2	CUE*2	
		L	CUE*2	PCM*1	CUE*2	PCM*1	
		R	PCM*1	CUE*2	PCM*1	CUE*2	
	PCM	L/R	PCM*3	PCM*3	PCM*3	PCM*3	PCM*3
		L					PCM*4
		R					PCM*3

### <Notes>

\*1: The PCM audio output is muted if the tape is played back at a speed in the -1.0× to +2.0× range (or at a speed in the -1.0× to +1.1× range for a format other than DVCPRO HD-LP).

\*2: In the case of the CUE audio output, the PCM signals are output if the tape is played back at a speed in the -j1.0× to +2.0× range (or at a speed in the -1.0× to +1.1× range for a format other than DVCPRO HD-LP).

\*3: During fast forwarding or rewinding, the CUE signal is output automatically.

\*4: During fast forwarding or rewinding, this signal is muted.

\*5: This item is not displayed when the 23/24 Hz mode or 25 Hz (HD or SD) mode has been selected as the system menu item No.25 (SYSTEM FREQ) setting.

# Setup menus

## <MENU>

No./Item	Description of setting
A02 P. ON LOAD	<p>This VTR is equipped with VTR MEMORY <u>C</u> for storing the current settings (*1) and VTR MEMORY <u>1</u> to <u>4</u> for backing up VTR MEMORY <u>C</u>. The data of a selected VTR MEMORY <u>1</u> to <u>4</u> can be loaded into VTR MEMORY <u>C</u> and operation started on the basis of this data when the power is turned on.</p> <p><u>0000</u> OFF: Operation is started using the previous settings.</p> <p><u>0001</u> USER1: The VTR MEMORY <u>1</u> data is loaded and operation started on the basis of this data.</p> <p><u>0002</u> USER2: The VTR MEMORY <u>2</u> data is loaded and operation started on the basis of this data.</p> <p><u>0003</u> USER3: The VTR MEMORY <u>3</u> data is loaded and operation started on the basis of this data.</p> <p><u>0004</u> USER4: The VTR MEMORY <u>4</u> data is loaded and operation started on the basis of this data.</p>

\*1: The term "settings" here denotes all the settings of the setup menus, what is registered in the PF1/PF2 menus, and the contents of some of the function buttons.

The underlining (  ) denotes the factory setting mode.

## <Connections with Dolby-E\* components>

When the VTR is to be connected to a Dolby-E encoder/decoder for recording or playing back Dolby-E data, set the audio input and output levels to UNITY, and select the following setup menu item settings.

No.303 AUD EDIT IN = CUT  
 No.304 AUD EDIT OUT = CUT  
 No.725 REC CH1 = CH1  
 No.726 REC CH2 = CH2  
 No.727 REC CH3 = CH3  
 No.728 REC CH4 = CH4  
 No.729 REC CH5 = CH5  
 No.730 REC CH6 = CH6  
 No.731 REC CH7 = CH7  
 No.732 REC CH8 = CH8  
 No.734 PB FADE = CUT  
 No.758 JOG PROC = OFF  
 No.762 AUD RATE CON = OFF

### <Notes>

- Dolby-E data cannot be recorded or played back in the 60 Hz mode.
- Adjust the timing with the video signals to cover the time taken by the Dolby-E component for encoding/decoding outside the VTR.
- Set the bit depth of the Dolby-E encoder/decoder to 16 bits.
- Noise will be output from the ANALOG AUDIO OUT connectors of the channels through which the Dolby-E data is passing.
- The audio level meter will deflect beyond the range of its markings for those channels through which the Dolby-E data is passing.
- Noise will be output when a tape on which Dolby-E data has been recorded is played back in the JOG or VAR mode.

\* Dolby and the Double D symbol  are trademarks of Dolby Laboratories Licensing Corporation.



# Setup menus

## <How to switch the system frequency>

Follow the steps below to switch the system frequency (59/60 Hz, 50 Hz, 23/24 Hz, 25 Hz (HD) or 25 Hz(SD)).

**1** Following the procedure for the <SETUP MENU/SYSTEM MENU> (page 60) to change the system menu item No.25 (SYSTEM FREQ) setting.

**2** Press **[F5]** (SET) to enter the setting, and after the function menu shown on the time code display area **14** has been cleared, the following message appears.

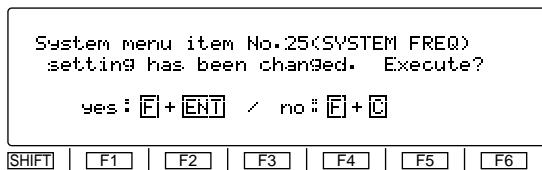

**3** To make the setting entered in step 2 valid, press the **[ENT]** button while holding down the **[F]** button. The system is restarted, and the VTR starts operating in the selected mode.

**4** To cancel the setting entered in step 2, press the **[C]** button while holding down the **[F]** button. The above message is cleared, and after the changed setting has been restored to the original system menu No.25 (SYSTEM FREQ) setting, operation returns to the SYSTEM menu operation screen.

### <Note>

If the system menu No.25 (SYSTEM FREQ) setting has been changed while a cassette is inserted in the VTR, the cassette is automatically ejected.

The same procedure as above is also followed when the system menu No.25 (SYSTEM FREQ) setting has been changed by loading the data from an IC card in accordance with the <CARD> procedure (page 69).

Note that even if the change being made to the system menu item No. 25 setting is cancelled, other system menu items affected by the change will be updated, as will the associated file names.

## <Selecting the recording/playback format and sync signals which support the operation mode>

No.25 SYSTEM FREQ	Format enabling recording	Format enabling playback	Sync signals
50/60	1080/59.94i (HD_LP) 1080/60.00i (HD_LP) 720/59.94p (HD_LP) 720/60.00p (HD_LP)	1080/59.94i (HD_LP, HD_SP) 1080/60i (HD_LP, HD_SP) 720/59.94p (HD_LP, HD_SP) 720/60.00p (HD_LP, HD_SP) 480/59.94p (480p) 480/59.94i (422, 411, DV, DVCAM)	HD_REF (59.94Hz, 60Hz) SD_REF (59.94Hz)  The setting selected for setup menu item No.031 (OUT REF) applies.
50	1080/50i (HD_LP)	1080/50i (HD_LP, HD_SP) 576/50i (422, 411, DV, DVCAM) 576/25p over 50i (422, 411, DV)	HD_REF (50Hz) SD_REF (50Hz)  The setting selected for setup menu item No.031 (OUT REF) applies.
23/24	None	720/23.98p over 59.94p (HD_SP/HD_SP) 720/24p over 60.00p (HD_SP/HD_SP) 480/23.98p over 59.94i [2:3 mode] 480/23.98p over 59.94i [2:3:3:2 advance mode]	HD_REF (47.96Hz, 48Hz)
25 (HD)	None	720/25p over 60p	HD_REF (50Hz) SD_REF (50Hz)  The setting selected for setup menu item No.031 (OUT REF) applies.
25 (SD)	None	720/25p over 60p	SD_REF (50Hz)

# Setup menus

## <Menu management accompanying switching the system frequency>

The system menu and setup menu have some items whose settings differ and other items with which no selection options are displayed and whose settings are fixed (indicated by the shading in the table below), depending on the switching of the operation mode in response to the setting selected for system menu item No.25 (SYSTEM FREQ). (Refer to the table below.)

### System menu and setup menu settings

- Each of the items whose settings differ is saved in the VTR MEMORY (current file and one of the backup files 1 to 4). The settings that correspond to each operation mode will be displayed so that the settings can be performed for each operation mode.

### Registration of the <PF1> and <PF2> function buttons

- When the items whose settings differ have been registered in the <PF1> and <PF2> function buttons, the settings that correspond to each operation mode will be displayed so that the settings can be performed for each operation mode.
- If items, whose selection options are not displayed due to the operation mode, have been registered in the <PF1> or <PF2> function button, when an operation mode in which these options are not displayed is selected, what has been registered is saved but the function button itself will become blank and cannot be operated. Bear in mind, however, that when the data is registered again, it is saved by overwriting the existing data so that the previously registered data will be lost.

### <50P IN/OUT> 50-pin connector registration

- When the items whose settings differ have been registered in the <50P IN/OUT> 50-pin connector pins, the settings corresponding to the operation modes are allocated to the IN and OUT pins on the basis of the setting numbers. However, when the upper limit value is exceeded, the value will be limited to this upper limit. What has been registered is saved, but bear in mind that when the data is registered again, it is saved by overwriting the existing data so that the previously registered data will be lost.
- If items, whose selection options are not displayed due to the operation mode, have been registered in the <50P IN/OUT> 50-pin connector, when an operation mode in which these options are not displayed is selected, what has been registered is saved but no operation is possible. Bear in mind, however, that when the data is registered again, it is saved by overwriting the existing data so that the previously registered data will be lost.

## System menu

No.	Menu item		System menu No.25 (SYSTEM FREQ)				
			59/60	23/24	50	25 (HD)	25 (SD)
12	SYS H (HD)	COARSE	-5H to 0H to 5H	-5H to 0H to 5H	-5H to 0H to 5H		
		FINE	-1100 to 0 to 1100	-1375 to 0 to 1375	-1320 to 0 to 1320		
14	SYS SC (SD)		-108 to 0 to 108		-115 to 0 to 115		
15	VO SYS H (SD)	COARSE	-5H to 0H to 5H		-5H to 0H to 5H		
		FINE	-858 to 0 to 858		-864 to 0 to 864		
16	SD SYS D (SD)	COARSE	-5H to 0H to 5H		-5H to 0H to 5H		
		FINE	-858 to 0 to 858		-864 to 0 to 864		

## Setup menus

No.	Menu item		System menu No.25 (SYSTEM FREQ)				
			59/60	23/24	50	25 (HD)	25 (SD)
109	CAP.LOCK		<u>2F/4F</u>	2F	<u>2F/4F/8F</u>	2F	2F
501	VITC POS-1		10L to <u>16L</u> to 20L		7L to <u>11L</u> to 22L		7L to <u>11L</u> to 22L
502	VITC POS-2		10L to <u>18L</u> to 20L		7L to <u>13L</u> to 22L		7L to <u>13L</u> to 22L
600	VIDEO IN SEL		INTSG <u>HSDI</u> SDTI SDSDI		INTSG <u>HSDI</u> SDSDI		

The underlining (   ) denotes the factory setting mode.

(Continued on next page)

# Setup menus

## Setup menus

No.	Menu item	System menu No.25 (SYSTEM FREQ)					
		59/60	23/24	50	25 (HD)	25 (SD)	
002	TAPE TIMER	<u>±12h</u> 24h		Same as for 59/60			
004	SYNCHRONIZE	OFF <u>ON</u>					
010	MONI CONTROL	<u>MANU</u> AUTO					
012	REC ADJUST	0s to <u>3s</u> to 5s					
013	DET STOP	OFF <u>ON</u>					
014	DET ADJUST	-8f to <u>0f</u> to 3s10f					
020	SYS FORMAT	<u>1080i</u> 720p	720p	1080i	720p	720p	
030	HD FREQUENCY	<u>59/23</u> 60/24	Same as for 59/60		60/24	60/24	
031	OUT REF	<u>AUTO</u> INPUT HD_REF SD_REF	HD_REF	Same as for 59/60	Same as for 59/60	SD_REF	
105	AUTO EE SEL	<u>S/F/R</u> STOP					
107	EE MODE SEL	<u>NORMAL</u> THRU					
111	MEMORY STOP	OFF <u>ON</u>					
113	REC INH	OFF ALL PRE NORMAL <u>V/CTL</u>	ALL			ALL	ALL
115	EJECT SW INH	<u>REC</u> OFF					
118	SP MODE INH	OFF <u>ON</u>			Same as for 59/60		
135	DET BEEP	OFF LOW HIGH					
140	OUTPUT	<u>EE</u> TAPE	TAPE			TAPE	TAPE
141	VOLUME	REC PB <u>AUTO</u>	PB			PB	PB
142	AUDIO UNITY	IN OUT <u>IN/OUT</u>	OUT			OUT	OUT
303	AUD EDIT IN	CUT <u>FADE</u>					
304	AUD EDIT OUT	CUT <u>FADE</u>					
306	CF ADJ SEL	<u>PLAYER</u> RECORDER					

The underlining (     ) denotes the factory setting mode.

# Setup menus

## Setup menus

No.	Menu item	System menu No.25 (SYSTEM FREQ)				
		59/60	23/24	50	25 (HD)	25 (SD)
320	EDIT RPLCE1	N-DEF CH1 CH2 CH1+3		Same as for 59/60		
321	EDIT RPLCE2					
322	EDIT RPLCE3					
323	EDIT RPLCE4					
324	EDIT RPLCEC					
500	VITC BLANK	BLANK THRU	BLANK		BLANK	Same as for 59/60
503	TCG MODE	REGEN PRE AUTO	PRE		PRE	PRE
504	RUN MODE	REC FREE				
505	TCG REGEN	TC&UB TC UB				
506	REGEN MODE	AS&IN ASSEM INSRT				
507	TC SOURCE	INT EXT_L SLTC SVITC				
508	BINARY GP	000 to 111				
510	TCG CF FLAG	OFF ON				
511	DF MODE	DF NDF	NDF		NDF	NDF
512	TC OUT REF	V OUT TC IN				
516	TC OUT ADV	OFF EDIT				
517	TCG OUT	MOMENT LATCH				
601	VIDEO INT SG	100%CB to EQ				
602	SDI IN MODE	DR OFF DR ON				
604	FREEZE SEL	FIELD FRAME				
605	INTERPOLATE	OFF AUTO	OFF		OFF	OFF
620	DOWNCON MODE	FIT_V FIT_H FIT_HV 14:9 13:9				Same as for 59/60
621	UPCON MODE	FIT_V FIT_H FIT_HV	Same as for 59/60			
624	U/C RESP H	STD NARROW				

The underlining (    ) denotes the factory setting mode.

# Setup menus

## Setup menus

No.	Menu item	System menu No.25 (SYSTEM FREQ)				
		59/60	23/24	50	25 (HD)	25 (SD)
625	U/C RESP V	<u>STD</u> NARROW	Same as for 59/60	Same as for 59/60		
628	U/C ENH H	0 dB to <u>+1 dB</u> to 2 dB				
629	U/C ENH V	0 dB to <u>+1 dB</u> to 2 dB				
630	1080i → HD OUT	<u>1080i</u> 720p 1080i				
631	1080i → SD OUT	<u>480i</u> --- 480p				
632	720p → HD OUT	<u>1080i</u> <u>720p</u> 720p				
633	720p → SD OUT	--- <u>480i</u> 480p				
634	480p → HD OUT	<u>1080i</u> 720p ---				
635	480p → SD OUT	<u>480p</u> 480p 480i				
636	480i → HD OUT	<u>1080i</u> 720p ---				
637	480i → SD OUT	<u>480i</u> 480i 480p				
638	IN U/C MODE	<u>FIT_V</u> FIT_H FIT_HV		Same as for 59/60		
639	I U/C RESP H	<u>STD</u> NARROW				
640	I U/C RESP V	<u>STD</u> NARROW				
641	I U/C ENH H	0 dB to <u>+1 dB</u> to 2 dB				
642	I U/C ENH V	0 dB to <u>+1 dB</u> to 2 dB				
651	HUE STYLE	<u>Pb-Pr</u> <u>U-V</u>	Same as for 59/60			
676	BLK CLIP	<u>OFF</u> ON				
680	CC (F1) BLANK	<u>BLANK</u> <u>THRU</u>	BLANK		BLANK	BLANK
681	CC (F2) BLANK	<u>BLANK</u> <u>THRU</u>	BLANK		BLANK	BLANK
682 (525 system only)	VO SETUP (HD)	<u>THRU</u> <u>ADD22</u> ADD21 ADD20	Same as for 59/60			
683 (525 system only)	VO SETUP (SD)	<u>THRU</u> <u>ADD22</u> ADD21 ADD20				

The underlining (     ) denotes the factory setting mode.

# Setup menus

## Setup menus

No.	Menu item	System menu No.25 (SYSTEM FREQ)				
		59/60	23/24	50	25 (HD)	25 (SD)
686	CCR MODE	<u>OFF</u> ON				
687	SDI INDEX O	<u>OFF</u> ON		Same as for 59/60		Same as for 59/60
688	CC REC	<u>OFF</u> ON				
695	BLANK LINE	<u>BLANK</u> THRU MANU				
700	CH1 IN LV	<u>4dB</u> 0dB -20dB		Same as for 59/60		
701	CH2 IN LV					
702	CH3 IN LV					
703	CH4 IN LV					
704	CUE IN LV	<u>4dB</u> 0dB -20dB -60dB				
713	CH1 IN SEL	<u>INT SG</u> DIGI ANA				
714	CH2 IN SEL					
715	CH3 IN SEL					
716	CH4 IN SEL					
717	CH5 IN SEL					
718	CH6 IN SEL					
719	CH7 IN SEL					
720	CH8 IN SEL					
721	D IN SEL 12	<u>AES</u> SDI				
722	D IN SEL 34					
723	D IN SEL 56					
724	D IN SEL 78					
725	REC CH1	CH1 to CH3+4				
726	REC CH2					
727	REC CH3					
728	REC CH4					
729	REC CH5	CH5 to CH7+8				
730	REC CH6					
731	REC CH7					
732	REC CH8					
733	REC CUE	<u>CUE</u> to CH1-8				
734	PB FADE	<u>AUTO</u> CUT FADE	CUT		CUT	
749	AUDIO PB VR	<u>DIS</u> ENA				
760	REC PT MUTE	<u>OFF</u> ON				
761	AUDIO INT SG	<u>TONE</u> SILNCE	SILNCE		SILNCE	
790	CUE REC VOL	16 to <u>0</u> to -16				

# Time code and user's bit

## Time code

The time code is used when the time code signal generated by the time code generator (time code signal generator) is to be recorded on the tape, its values are to be read by the time code reader (time code signal reader), and the absolute position of the tape is to be displayed in increments of hours, minutes, seconds and frames.

The time code is written in the sub-code area (data area) of the helical track. This enables insert editing to be conducted independently using the time code alone. In addition, the VTR's playback speed can be read from the stop mode to the slow motion playback up to high-speed playback (approx. 50× normal speed or approx. 100× normal speed when using a DVCPRO tape).

The time code values are indicated on the display and superimposed display.

TCR 00 : 07 : 04 : 23  
↑    ↑    ↑    ↑  
Hours Minutes Seconds Frames

## User's bit

The "user's bit" refers to the 32-bit (8-digit) data frame among the time code signals which has been released to users. It enables operator numbers and other values to be recorded.

The alphanumerics which can be used for the user's bit are number 0 to 9 and letters A to F.

## Setting the internal time code

- 1 Set the VTR to the stop mode.
- 2 Set **[F3]** TC/CTL on the <HOME> menu to TC.
- 3 Set **[F1]** SOURCE on the <TC> menu to INT (for selecting the internal time code).

### 4 Setting **[F5]** RUN MD on the <TC> menu

#### REC:

The time code advances simultaneously with the recording.

#### FREE:

The time code advances, like time, irrespective of the VTR operation.

### 5 Setting **[F3]** TCG MD on the <TC> menu

#### REGEN:

The continuity of the underlying time code in place prior to editing is maintained.

#### PRE:

The time code can be preset using the operation panel controls or remote controller.

#### AUTO:

The time code is automatically switched to REGEN or PRE depending on the VTR's operation mode: during editing, REGEN is selected; at all other times, PRE is selected.

### 6 Registering the TC preset values

Display the <HOME> menu.

#### <TC/UB>

##### • Preset (in the preset enable status)

- ① When **[T]** among the number keys is pressed, the TC display switches to TCG (UBG), and the TCG value characters (all digits) are highlighted.
- ② When **[T]** is pressed again, one digit is highlighted, and the change enable status is established.
- ③ Input the desired value using the number keys. The entire input value can be cleared by pressing **[0]** while holding down **[F]**.
- ④ To input the letters used with the user's bit, press the same number key (toggle by tapping **[7]** or **[8]**) while holding down **[F]**. To move from one digit to another, turn the ADJ dial.
- ⑤ To enter the value, press the **[ENT]** key.
- ⑥ When the display screen has been changed during the input process or if the **[C]** button has been pressed, the change enable status is released, and the setting is canceled.

#### <CTL>

##### • Reset

Press **[F4]** (TC CLR).

# Concerning the time code and user's bit

## Setting the external time code

- 1 Set the VTR to the stop mode.
- 2 Set **[F3]** TC/CTL on the <HOME> menu to TC.
- 3 If the video input has been set to HD SDI input or INT SG, set **[F1]** TC SRC on the <TC> menu to EXT-L, SLTC or SVITC.
- 4 If the video input has been set to SD SDI (when the optional board has been installed), set **[F1]** TC SRC on the <TC> menu to EXT-L or VITC.

## Cue time registration, preroll and cue-up

(These functions work only on the HOME, PF1 and PF2 screens.)

- **Registration**  
Register the cue time by pressing the **[SET]** button while holding down the **[F]** button.
- **Presetting**  
When the **[T]** button is pressed, the characters of the cue time or TC/UB display are highlighted. Turn the ADJ dial to highlight the characters of the cue time. The subsequent steps in the registration procedure are the same as for TCG.
- **Prerolling**  
Press the PREROLL button to preroll the tape to the currently registered CUE point.
- **Cue-up**  
Press the PREROLL button while holding down the **[F]** button to cue the tape up to the currently registered CUE point.

## Time code and user's bit playback

- 1 Set the VTR to the stop mode.
- 2 Set **[F3]** TC/CTL on the <HOME> menu to TC or UB.  
**TC:**  
The time code is displayed.  
**UB:**  
The user's bit is displayed.
  - In the event that it has become impossible to read the time code, it is interpolated using the CTL signal.
- 3 Press the PLAY button. Playback starts, and the time code appears on the display. If **[F1]** (SUPER) on the <TC SHIFT> menu is set to ON, the time code value is superimposed onto the video signals from the VIDEO OUT3 connector.

### <Notes>

- While a drop frame time code is being read, the colon between the seconds and frames is replaced with a period.
- If the time code signal is missing, it is interpolated automatically using the CTL signal. The following appears on the display.

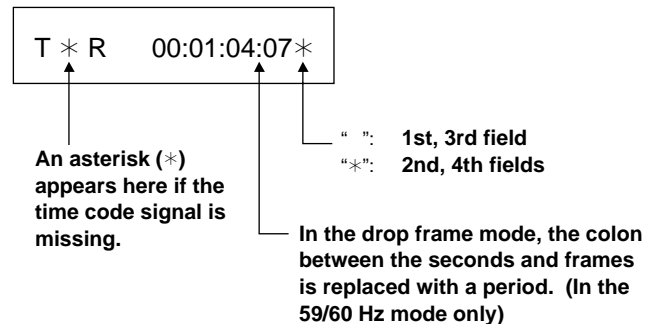



# Superimpose screen

The control signals, time code, etc. are displayed on this screen using abbreviations.

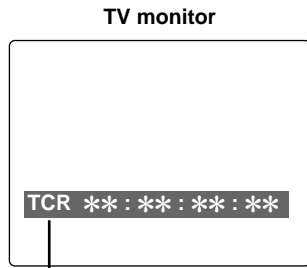

**Abbreviations**

- CTL:** Control signal count value
- TCR:** Time code data recorded in the SBC area
- TCR.:** Time code data recorded in the VAUX area
- UBR:** User's bit data recorded in the SBC area
- UBR.:** User's bit data recorded in the VAUX area
- TCG:** Time code data of the time code generator
- UBG:** User's bit data of the time code generator

**<Note>**

[T\*R], [T\*R.], [U\*R] or [U\*R.] is displayed when the data has not been read correctly from the tape.

**Characters displayed**

The background of the characters superimposed on the display screen can be changed using [F5] (C TYPE) on the <TC SHIFT> menu.



TV monitor

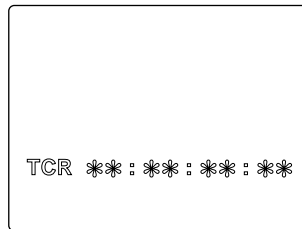

TV monitor

**<Note>**

When the 23/24 Hz mode has been selected as the system menu item No.25 (SYSTEM FREQ) setting, the time code and other information superimposed on the MONITOR and VIDEO OUT3 connectors are not displayed.

**Display position**

The position of the characters superimposed on the display can be changed using [F2] (C HPOS) and [F3] (C VPOS) on the <TC SHIFT> menu and the ADJ dial.



TV monitor



TV monitor

**Operation mode**

The VTR's operation mode can also be displayed using [F4] (DISPLY) on the <TC SHIFT> menu.



TV monitor

VTR operation mode

# Selecting the audio recording channels and monitor output

## Audio recording channels

The audio channels can be selected as shown below using the AUDIO setup menu items.

Recording track	Signals recorded
CH1	CH1 input, CH2 input, CH3 input, CH4 input, CH1+CH2 input, CH3+CH4 input
CH2	CH1 input, CH2 input, CH3 input, CH4 input, CH1+CH2 input, CH3+CH4 input
CH3	CH1 input, CH2 input, CH3 input, CH4 input, CH1+CH2 input, CH3+CH4 input
CH4	CH1 input, CH2 input, CH3 input, CH4 input, CH1+CH2 input, CH3+CH4 input
CH5	CH5 input, CH6 input, CH7 input, CH8 input, CH5+CH6 input, CH7+CH8 input
CH6	CH5 input, CH6 input, CH7 input, CH8 input, CH5+CH6 input, CH7+CH8 input
CH7	CH5 input, CH6 input, CH7 input, CH8 input, CH5+CH6 input, CH7+CH8 input
CH8	CH5 input, CH6 input, CH7 input, CH8 input, CH5+CH6 input, CH7+CH8 input
CUE	CUE input, CH1 input, CH2 input, CH3 input, CH4 input, CH5 input, CH6 input, CH7 input, CH8 input, CH1+CH2 input, CH3+CH4 input, CH5+CH6 input, CH7+CH8 input, CH1-CH8 input

## Monitor output channels

When **[F6]** (M MIX) on the <AUDIO SHIFT2> menu is set to L, R or L/R, the signals of a multiple number of channels can be mixed and output.

When the number key corresponding to the channel whose signals are to be monitored is pressed while the "L" (or "R") button is held down, that channel is selected, and its signals are displayed on the audio level meter. (The same steps can also be taken to de-select a channel which has already been selected.) However, only up to 2 channels among the CH1-CH4 channels and only up to 2 channels among the CH5-CH8 channels are selected.

(Examples: CH1 + CH3 + CH5 + CH8 can be selected but CH1 + CH2 + CH4 cannot be selected.)

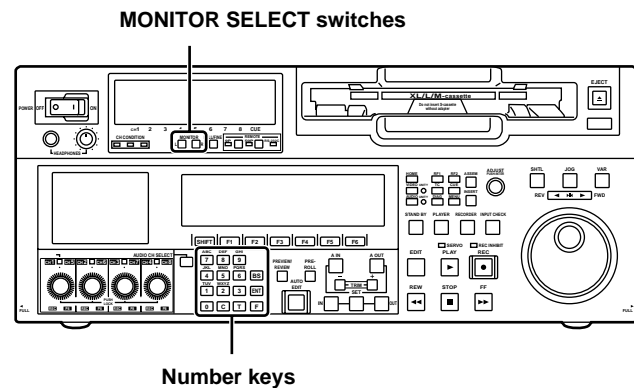

## ***Display saving function***

---

This function is provided to extend the service life of the LCD monitor. It starts up if none of the front panel controls have been operated or the cassette tape has not been run at all for about 5 minutes.

While the saving function is working, the LCD monitor display goes blank, and the "EX" symbol appears on the time code display area.

To release the saving function, operate a button or dial on the front panel or issue a tape transport command from the controller. The operation performed to release the function will be executed after the function is released.

# Rack mounting

The unit can be mounted into a 19-inch standard rack if the optional rack-mounting adapters (AJ-MA75P) are used. For the installation rails, it is recommended that the rail and bracket for 18-inch length (part number CC3061-99-0400) of Chassis Trak be used. If an even greater clearance is to be left between the VTR and rack when the VTR is pulled out, however, it is recommended that the 22-inch long Chassis Trak (part number CC-3001-99-0191) be used. (The complete slide rail and bracket unit is not available from Panasonic.) For further details, consult your dealer.

**1** Attach the inner members of the slide rails. Refer to the figure below for the positions where they are screwed into place.

Positions where the right (R) inner member is screwed into place

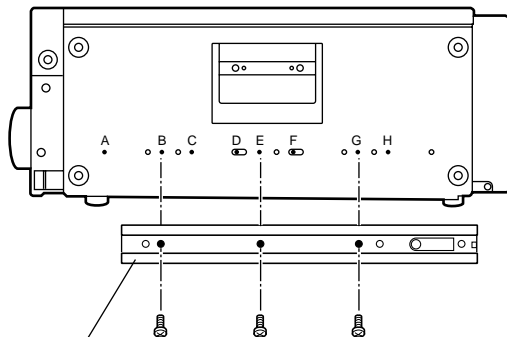

Inner member (18-inch rail)

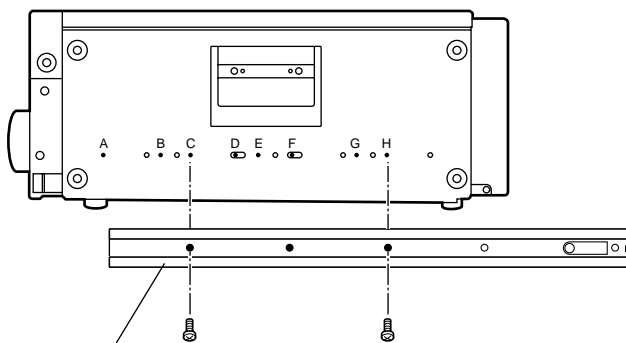

Inner member (22-inch rail)

## <Notes>

- The length of the screws used is subject to a restriction.
- Use screws which are less than 2/5" (10 mm) long.
- Attach the inner member at the same symmetrical positions on the left (L) side as well. Fix the members in place using 3 screws on each side (total: 6 screws). When using the 22-inch long slide rails, secure the screws at 4 locations.
- The letters shown in the figure are not actually marked on the side panels.

**2** Attach the outer member brackets to the rack. Check that the height is the same for the left and right brackets.

**3** Remove the four screws at the front used to attach the left and right side panels.

**4** Attach the AJ-MA75P rack-mounting adapters using the same four screws.

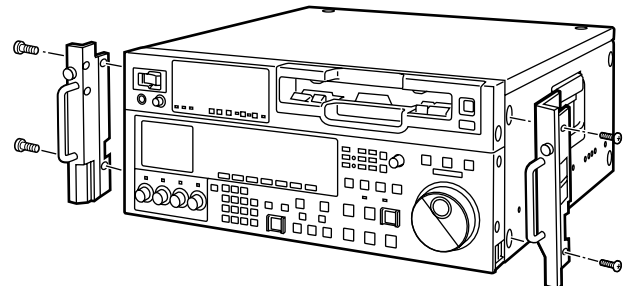

Rack-mounting adapters

**5** Remove the four rubber feet on the bottom panel of the VTR, and install the VTR in the rack. After the VTR has been installed, check that it moves smoothly along the rails.

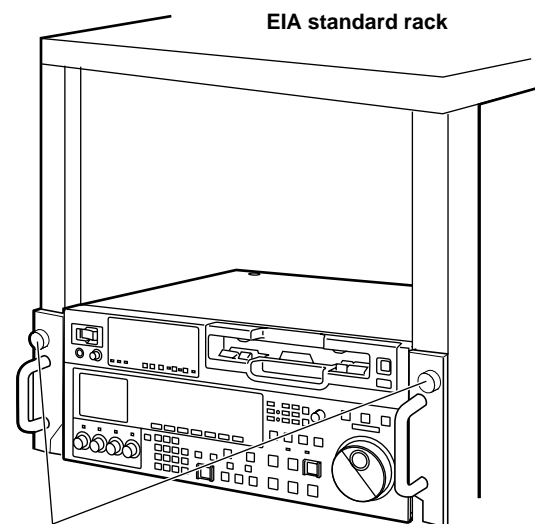

Fasten to rack with the fixing screws.

## <CAUTIONS>

- Keep the temperature inside the rack to between 41°F and 104°F (5°C and 40°C).
- Bolt the rack securely to the floor so that it will not topple over when the VTR is pulled out.

## ***Video head cleaning***

---

This VTR is equipped with an auto head cleaning function which automatically reduces the amount of dirt on the video heads. In order to maximize the VTR's reliability, however, it is recommended that the video heads be cleaned as and when appropriate.

For further details on how to actually clean the heads, consult with one of Panasonic's service companies or with your dealer.

## ***Condensation***

---

Condensation occurs due to the same principle which is involved when droplets of water form on a window pane of a heated room. It occurs when the VTR or tape is moved between places where the temperature or humidity varies greatly or when, for instance:

- It is moved to a very humid place full of steam or a room immediately after it has been heated up.
- It is suddenly moved from a cold location to a hot or humid location.

After moving the VTR to such a location, leave it standing for about 10 minutes rather than switching on its power immediately.

If condensation has formed on or in the VTR, the AUTO OFF lamp lights, and the cassette tape is automatically ejected. Keep the power supplied and simply wait until the AUTO OFF lamp goes off.

It is recommended that the video heads be cleaned after the AUTO OFF lamp has gone off.

## ***Maintenance***

---

Before proceeding with maintenance, be absolutely sure to set the power switch to OFF and take hold of the power plug and unplug it from the power outlet.

Use a soft cloth to clean the cabinet. To remove stubborn dirt, dilute some kitchen detergent, dip a cloth into the solution, wring it out well, and wipe. After having removed the dirt, take up any remaining moisture using a dry cloth.

### **<Note>**

Do not use alcohol, benzene, paint thinners or other solvents. They can discolor the external parts surfaces and remove the finish.

# Error messages

When a warning occurs in this VTR, the warning lamp lights up.

When the DIAG menu is opened, a description of the warning will appear on the front panel LCD area and TV monitor. Also, when an abnormal operation is detected in this VTR, the AUTO OFF lamp lights up, and a message appears on the time code display area.

## DIAG menu

This displays the VTR information.

The VTR information includes the warning information and hour-meter (usage time) information. The DIAG menu appears on the front panel LCD display or on a TV monitor when the TV monitor is connected to the VIDEO OUT3 connector in the VTR's connector area.

### ■ Displaying the DIAG menu

**1** Press the DIAG button.  
The DIAG menu screen is now displayed on the TV monitor.

**2** The warning information is displayed by pressing **F1** (WARN) on the time code display area, and the hour-meter information is displayed by pressing **F2** (HOURS) on this area.  
The display of the hour-meter information is scrolled using the ADJ dial.

**3** To exit the DIAG menu, press any other direct menu button.

### ■ Displaying the warning information

- A warning message is displayed whenever a warning occurs (the warning lamp lights up). When no warnings have been detected, "NO WARNING" is displayed.
- When a multiple number of warnings occur, the descriptions of each warning can be checked by turning the ADJ dial.

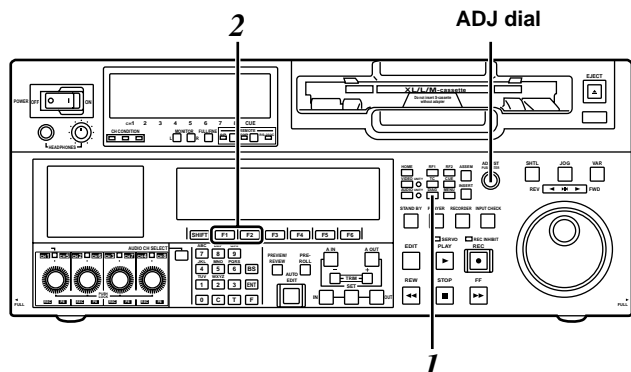

# Error messages

## ■ Displaying the hour-meter information

Turn the ADJ dial to move the cursor (\*), and the description for the item where the cursor is located is shown as a superimposed display.

No./Item	Description
<b>H00</b> <b>OPERATION</b>	Displays in 1-hour increments the time during which power has been supplied.
<b>H01</b> <b>DRUM RUN</b>	Displays in 1-hour increments the amount of time during which the drum has rotated.
<b>H02</b> <b>TAPE RUN</b>	Displays in 1-hour increments the amount of time during which the tape has been running in the FF, REW, PLAY, SEARCH (JOG, VAR and SHTL), REC and EDIT modes (but not in the JOG, VAR, SHTL or STILL mode).
<b>H03</b> <b>THREADING</b>	Displays in 1-time increments the number of times the tape has been threaded (loaded) and unthreaded (unloaded).
<b>H04</b> <b>F LOADING</b>	Displays in 1-time increments the number of front loading operations.
<b>H05</b> <b>LCD ON</b>	Displays in 1-hour increments the amount of time during which the LCD monitor has lighted.
<b>H11</b> <b>DRUM RUNr</b>	Displays in 1-hour increments the amount of time during which the drum has rotated. (Can be reset.)
<b>H12</b> <b>TAPE RUNr</b>	Displays in 1-hour increments the amount of time during which the tape has been running in the FF, REW, PLAY, SEARCH (JOG, VAR and SHTL), REC and EDIT modes (but not in the JOG, VAR, SHTL or STILL mode). (Can be reset.)
<b>H13</b> <b>THREADINGr</b>	Displays in 1-time increments the number of times the tape has been threaded (loaded) and unthreaded (unloaded). (Can be reset.)
<b>H14</b> <b>F LOADINGr</b>	Displays in 1-time increments the number of front loading operations. (Can be reset.)
<b>H15</b> <b>LCD ON r</b>	Displays in 1-hour increments the amount of time during which the LCD monitor has lighted. (Can be reset.)
<b>H30</b> <b>POWER ON</b>	Displays the number of times the power has been turned on.

### <Note>

The resettable table hour-meter information items will be reset by your dealer when maintenance or other work is performed.

If "T&S&M" has been selected as the setup menu item No.006 (DISPLAY SEL) setting, a message appears in the mode display area whenever a warning or error has occurred. When a multiple number of errors have occurred, the one with the highest priority is displayed.

Priority	Display and description
<b>Higher</b>	<p><b>Error messages (see error message table):</b> When any problem arises with the VTR's operation, the AUTO OFF lamp lights, and an error message is displayed.</p> <p><b>INT SG:</b> If, when "INT SG" has been selected as the audio input setting by [F1] (VID IN) on the &lt;VIDEO&gt; menu or by the [F1] (AUDIO) or &lt;AUDIO SHIFT1&gt; menu, and the EDIT button is pressed, this message is displayed for the first two seconds when editing is started. In the same way, it is displayed for the first two seconds when recording is started.</p> <p><b>NO INPUT:</b> If, when input signals (but not analog audio signals) are not supplied to the input connector selected by [F1] (VID IN) on the &lt;VIDEO&gt; menu or by the [F1] (AUDIO) or &lt;AUDIO SHIFT1&gt; menu, the EDIT button is pressed, this message is displayed for the first two seconds when editing is started. In the same way, it is displayed for the first two seconds when recording is started.</p> <p><b>Warning messages (see warning message table):</b> When a warning occurs in this VTR, the warning lamp lights, and a warning message is displayed. When a multiple number of warnings have occurred, the one with the highest priority is displayed.</p>
<b>Lower</b>	

[F1]

# Error messages

## Warning messages

Priority	<ul style="list-style-type: none"> <li>• Display</li> <li>• Description</li> <li>• VTR operation and remedial action</li> </ul>
<p style="text-align: center;">Higher</p> <p style="text-align: center;">↑</p> <p style="text-align: center;">↓</p> <p style="text-align: center;">Lower</p>	<p><b>FAN STOP</b></p> <p>This is displayed when the fan motor has stopped.</p> <p><b>VTR:</b> Operation continues (and a warning beep is sounded regardless of the menu setting.)</p> <ul style="list-style-type: none"> <li>• Check that no foreign matter has accumulated on the fan.</li> </ul>
	<p><b>NO RF</b></p> <p>This is displayed when a blank part of the tape lasting for 1 or more seconds has been detected during playback.</p> <p>When all of the following conditions have been met, it will be recognized as a blank part.</p> <ul style="list-style-type: none"> <li>• When no signals are output from any of the heads</li> <li>• When the playback data cannot be read</li> <li>• When the CTL signal is not present</li> </ul> <p><b>VTR:</b> Operation continues.</p> <ul style="list-style-type: none"> <li>• Check the tape. An unrecorded tape may have been inserted.</li> </ul>
	<p><b>SERVO NOT LOCKED</b></p> <p>This is displayed when the servo is not locked for 3 or more seconds during playback, recording or editing.</p> <p><b>VTR:</b> Operation continues.</p> <ul style="list-style-type: none"> <li>• Check the tape. A tape recorded using a system which does not allow playback may have been inserted.</li> </ul>
	<p><b>INVALID TC MODE (in 23/24 Hz or 25 Hz (HD or SD) mode)</b></p> <p>This is displayed during playback if the time code has been recorded in the drop frame mode. The video output is disturbed and the audio output is muted at the time code drop point.</p> <p><b>VTR:</b> Operation continues.</p> <ul style="list-style-type: none"> <li>• Check the tape. If a tape recorded using a variable frame rate camera is to be played back in this VTR, the time code must be recorded in the non-drop frame mode.</li> </ul>
	<p><b>TC SEQUENCE UNMATCH (in 23/24 Hz or 25 Hz (HD or SD) mode)</b></p> <p>This is displayed during playback if the correlation between the active frame information and time code is irregular. The video output may not be uniform (the movements may not be smooth).</p> <p><b>VTR:</b> Operation continues.</p> <ul style="list-style-type: none"> <li>• Check the tape. The active frame (first frame where the frame video is switched) information is recorded on a tape recorded using a variable frame rate camera. When such a tape is played back on this VTR, the 0 frame of the time code must be detected at the active frame position.</li> </ul>
	<p><b>LOW RF</b></p> <p>This is displayed when a state in which the envelope level has dropped to less than one-third of its normal level has been detected for 1 or more seconds or when a state in which the CTL signal level has dropped to less than one-sixth of its normal level has been detected for 1 or more seconds during playback, recording or editing.</p> <ul style="list-style-type: none"> <li>• The CTL signal level is not detected during DV or DVCAM playback.</li> <li>• During recording or editing, the envelope level of only the video simultaneous play heads is detected.</li> </ul> <p><b>VTR:</b> Operation continues.</p> <ul style="list-style-type: none"> <li>• Clean the video heads and A/C head.</li> </ul>
	<p><b>HIGH ERROR RATE</b></p> <p>This is displayed when the error rate increases and correction or interpolation is performed for either the video or audio signals.</p> <p><b>VTR:</b> Operation continues.</p> <ul style="list-style-type: none"> <li>• Clean the video heads.</li> </ul>

## Error messages

Display	<ul style="list-style-type: none"> <li>• Description</li> <li>• VTR operation and remedial action</li> </ul>
<b>CAP ROTA TOO SLOW</b>	<p>If the rotational speed of the capstan motor is abnormally slow, the AUTO OFF lamp lights, and the message display blinks.</p> <p><b>VTR:</b> Stops.</p> <ul style="list-style-type: none"> <li>• Set the POWER switch to OFF and then back to ON again.</li> </ul>
<b>CAP TENSION ERROR</b>	<p>If an abnormal tension is detected at the supply side in the capstan mode, the AUTO OFF lamp lights, and the message display blinks.</p> <p><b>VTR:</b> Stops.</p> <ul style="list-style-type: none"> <li>• Set the POWER switch to OFF and then back to ON again.</li> </ul>
<b>DEW</b>	<p>When condensation has been detected, the AUTO OFF lamp lights, the message display blinks, and the VTR transfers to the EJECT mode. After the tape has been ejected, the drum continues to rotate in order to dry out the condensation.</p> <p>When the condensation has cleared, the AUTO OFF lamp goes off, the message display is cleared, and the VTR is ready for operation again.</p> <ul style="list-style-type: none"> <li>• When condensation is detected in the EJECT mode, the drum starts rotating as soon as it is detected.</li> <li>• When condensation is detected while a cassette is inserted, the drum stops rotating and starts rotating again after the tape has been ejected.</li> </ul> <p><b>VTR:</b> EJECT</p> <ul style="list-style-type: none"> <li>• Wait with the power on.</li> </ul>
<b>DRUM ROTA TOO FAST</b>	<p>If the rotational speed of the cylinder motor is abnormally high, the AUTO OFF lamp lights, and the message display blinks.</p> <p><b>VTR:</b> Stops.</p> <ul style="list-style-type: none"> <li>• Set the POWER switch to OFF and then back to ON again.</li> </ul>
<b>DRUM ROTA TOO SLOW</b>	<p>If the rotational speed of the cylinder motor is abnormally slow, the AUTO OFF lamp lights, and the message display blinks.</p> <p><b>VTR:</b> Stops.</p> <ul style="list-style-type: none"> <li>• Set the POWER switch to OFF and then back to ON again.</li> </ul>
<b>E-FF</b>	<p>If the tape start and tape end are detected at the same time either during or after loading, the AUTO OFF lamp lights, and the message display blinks.</p> <p><b>VTR:</b> Stops.</p> <ul style="list-style-type: none"> <li>• Set the POWER switch to OFF and then back to ON again.</li> </ul>
<b>FRONT LOAD ERROR</b>	<p>If the take-up reel has turned without engaging the tape for a specific period of time during the tape start or end processing operation while loading is being performed (at the half position), the AUTO OFF lamp lights, and the message display blinks.</p> <p><b>VTR:</b> Stops.</p> <ul style="list-style-type: none"> <li>• Set the POWER switch to OFF and then back to ON again.</li> </ul>



# Error messages

## Error messages

Display	<ul style="list-style-type: none"> <li>• Description</li> <li>• VTR operation and remedial action</li> </ul>
<b>FRONT LOAD MOTOR</b>	<p>If the cassette fails to move up even after 6 seconds have elapsed since the VTR transferred to the EJECT mode, the AUTO OFF lamp lights, and the message display blinks.</p> <p><b>&lt;Note&gt;</b> If the cassette fails to move down even after 6 seconds have elapsed since the cassette was inserted, the VTR transfers to the EJECT mode.</p> <p><b>VTR:</b> Stops.</p> <ul style="list-style-type: none"> <li>• Set the POWER switch to OFF and then back to ON again.</li> </ul>
<b>LOADING MOTOR</b>	<p>If the unloading operation fails to be completed within 6 seconds, the AUTO OFF lamp lights, and the message display blinks.</p> <p><b>&lt;Note&gt;</b> If the loading operation fails to be completed within 6 seconds, the VTR transfers to the EJECT mode (unloading mode).</p> <p><b>VTR:</b> Stops.</p> <ul style="list-style-type: none"> <li>• Set the POWER switch to OFF and then back to ON again.</li> </ul>
<b>REEL DIR UNMATCH</b>	<p>If the take-up reel motor is running in the reverse direction, the AUTO OFF lamp lights, and the message display blinks.</p> <p><b>VTR:</b> Stops.</p> <ul style="list-style-type: none"> <li>• Set the POWER switch to OFF and then back to ON again.</li> </ul>
<b>REEL TENSION ERROR</b>	<p>If an abnormal tension at the supply side is detected in the reel mode, the AUTO OFF lamp lights, and the message display blinks.</p> <p><b>VTR:</b> Stops.</p> <ul style="list-style-type: none"> <li>• Set the POWER switch to OFF and then back to ON again.</li> </ul>
<b>SERVO COMM ERROR</b>	<p>When the servo microcomputer does not follow the instructions of the system control microcomputer even after 10 seconds have elapsed, the AUTO OFF lamp lights, and the message display blinks.</p> <p><b>VTR:</b> Stops.</p> <ul style="list-style-type: none"> <li>• Set the POWER switch to OFF and then back to ON again.</li> </ul>
<b>SERVO CONTROL ERROR</b>	<p>When there is no response from the servo microcomputer for 1 or more seconds, the AUTO OFF lamp lights, and the message display blinks.</p> <p><b>VTR:</b> Stops.</p> <ul style="list-style-type: none"> <li>• Set the POWER switch to OFF and then back to ON again.</li> </ul>
<b>SERVO ERROR</b>	<p>When only the servo microcomputer was reset in an instantaneous power failure, etc., the AUTO OFF lamp lights, and the message display blinks.</p> <p><b>VTR:</b> Stops.</p> <ul style="list-style-type: none"> <li>• Set the POWER switch to OFF and then back to ON again.</li> </ul>

Display	<ul style="list-style-type: none"> <li>• Description</li> <li>• VTR operation and remedial action</li> </ul>
<b>S-FF/REW TIMEOVER</b>	<p>When the tape start or end processing operation is not completed, the AUTO OFF lamp lights, and the message display blinks.</p> <p><b>VTR:</b> Stops.</p> <ul style="list-style-type: none"> <li>• Set the POWER switch to OFF and then back to ON again.</li> </ul>
<b>S REEL ROTA TOO FAST</b>	<p>If the supply reel motor rotates at an abnormally fast rate, the AUTO OFF lamp lights, and the message display blinks.</p> <p><b>VTR:</b> Stops.</p> <ul style="list-style-type: none"> <li>• Set the POWER switch to OFF and then back to ON again.</li> </ul>
<b>S REEL TORQUE ERR</b>	<p>If an abnormal torque applied to the supply reel motor is detected or if an abnormal current flowing to the current-sensing resistor is detected, the AUTO OFF lamp lights, and the message display blinks.</p> <p><b>VTR:</b> Stops.</p> <ul style="list-style-type: none"> <li>• Set the POWER switch to OFF and then back to ON again.</li> </ul>
<b>T REEL ROTA TOO FAST</b>	<p>If the take-up reel motor rotates at an abnormally fast rate, the AUTO OFF lamp lights, and the message display blinks.</p> <p><b>VTR:</b> Stops.</p> <ul style="list-style-type: none"> <li>• Set the POWER switch to OFF and then back to ON again.</li> </ul>
<b>T REEL TORQUE ERR</b>	<p>If an abnormal torque applied to the take-up reel motor is detected, the AUTO OFF lamp lights, and the message display blinks.</p> <p><b>VTR:</b> Stops.</p> <ul style="list-style-type: none"> <li>• Set the POWER switch to OFF and then back to ON again.</li> </ul>
<b>UNLOAD ERROR</b>	<p>If the tape has not been wound up during unloading, the AUTO OFF lamp lights, and the message display blinks.</p> <p><b>VTR:</b> Stops.</p> <ul style="list-style-type: none"> <li>• Set the POWER switch to OFF and then back to ON again.</li> </ul>
<b>WINDUP ERROR</b>	<p>If, after the total tape amount has been detected, the amount of tape wound up onto the take-up reel and the amount of tape supplied by the supply reel differ to an abnormal extent while the tape is traveling, the AUTO OFF lamp lights, and the message display blinks.</p> <p><b>VTR:</b> Stops.</p> <ul style="list-style-type: none"> <li>• Set the POWER switch to OFF and then back to ON again.</li> </ul>
<b>W-UP REEL NOT ROTA</b>	<p>If, after the cassette has been inserted, the tape take-up reel has not wound up the tape while the total tape amount is not detected and while the tape is traveling, the AUTO OFF lamp lights, and the message display blinks.</p> <p><b>VTR:</b> Stops.</p> <ul style="list-style-type: none"> <li>• Set the POWER switch to OFF and then back to ON again.</li> </ul>

**If the error message display persists even after the VTR has been shut down and started up again, consult your dealer.**

# RS-232C interface

The VTR can be operated by commands when the RS-232C interface is used. (Refer to the command tables on page 125 and 126.)

## ■ Condition for acknowledging commands from RS-232C interface

Setup menu item No.204 (RS232C SEL): **ON**

If the above condition is not met, [ACK]+[STX]ER001[EXT] is returned to the external component. Whether [ACK] is returned depends on the setting which has been selected for setup menu item No.209 (RETURN ACK).

## Hardware specifications

### External interface specifications

- **Connector pin specifications**

Connector: D-SUB 25-pin  
(crossover cable supported)

Pin No.	Signal	Description
1	FG	Protective ground (frame ground)
2	RXD	Received data (data is sent to PC)
3	TXD	Transmitted data (data is received from PC)
4	CTS	Clear to send (shorted with pin 5)
5	RTS	Request to send (shorted with pin 4)
6	DTR	Data terminal ready (no processing)
7	SG	Signal ground
20	DSR	Data set ready (+ voltage output after communication enable status)

- **Example of connection with controller (PC)**

(Using crossover cable with D-SUB 25-pin connectors)

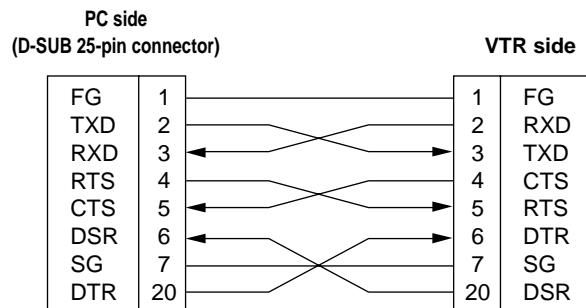

(Using crossover cable with D-SUB 9-pin and D-SUB 25-pin connectors)

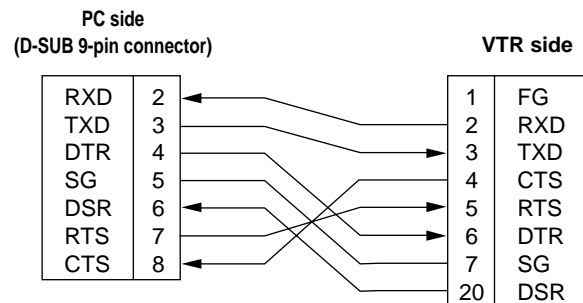

# RS-232C interface

## Software specifications (protocol)

### 1. Communication parameters

<b>Communication system</b>	Asynchronous, full duplex
<b>Transfer rate</b>	300, 600, 1200, 2400, 4800 or <u>9600</u> bps
<b>Bit length</b>	7 bits or <u>8 bits</u>
<b>Stop bit</b>	<u>1 bit</u> or 2 bits
<b>Parity bit</b>	<u>None</u> , odd or even
<b>ACK code</b>	<u>Returned</u> or not returned <b>&lt;Note&gt;</b> ACK is the code which is returned from the VTR to the controller when data has been successfully sent from the controller.

The underlining (     ) denotes the factory setting mode.

Any changes to the settings can be made using the setup menu items listed below.

Communication parameter	Setup menu item
<b>Transfer rate</b>	No.205 BAUD RATE
<b>Bit length</b>	No.206 DATA LENGTH
<b>Stop bit</b>	No.207 STOP BIT
<b>Parity bit</b>	No.208 PARITY
<b>ACK code</b>	No.209 RETURN ACK

### 2. Send format [controller (PC) → VTR]

#### ■ Data format

[STX] [command] [:] [data] [ETX]  
02h XX XX XX 3Ah XX……XX 03h

20H<XX<7FH

(XX=ASCII code: symbols, numbers, upper-case letters)

#### [command]:

This is the command identifier (3 bytes).

A 3-byte identifier (ASCII code: symbols, numbers, upper-case letters) is sent as the command.

#### [:]

The colon is the code serving as a delimiter between the command and data.

#### [data]:

Data (ASCII code: symbols, numbers, upper-case letters) can be added in the number of bytes required.

#### ■ Outline of procedure for sending data from controller

- ① The send command starts with STX (start of text = 02h). The command is then identified by COMMAND which follows, and the data is added as required.  
The command ends with ETX (end of text = 03h).
- ② When a different command is to be sent, a response is awaited from the VTR, and then the command is sent. (See page 124.)
- ③ If STX is sent again before ETX is sent, the receive data buffer inside the VTR is cleared. A command error is returned to the controller, and the data is newly processed with STX which was received again at the head.

# RS-232C interface

---

## 3. Return format

### [VTR → controller (PC)]

The following responses are made to the commands. If necessary, more than one response is made.

#### ■ When the communication has ended successfully

1. The receive completion message is returned.

[ACK]  
06h

2. The execution completion message is returned.

[STX] [command] [data] [ETX]  
02h XX XX XX XX.....XX 03h

#### [command]:

This is the message (data) which is returned or the execution completion message identifier.

#### [data]:

This is the data to be returned. It can be omitted.

Example:

Send command .....  
Return message (data)  
[STX] OPL [ETX] ..... →  
[ACK] [STX] OPL [ETX]

#### ■ When the communication has ended unsuccessfully

[NACK]  
15h

#### ■ When processing is not possible due to incorrect data or problem with the VTR

1. The receive completion message is returned.

[ACK]  
06h

2. An error code is returned.

[STX] [E R N<sub>1</sub> N<sub>2</sub> N<sub>3</sub>] [ETX]  
02h Error code 03h

## 4. Error code table

**ER001:** Invalid command

- Unsupported command received
- Command execution error

**ER002:** Parameter error

**ER102:** VTR mode error

(front loading motor)

**ER103:** VTR mode error (loading motor)

**ER104:** VTR mode error (drum, capstan system)

**ER105:** VTR mode error (reel system)

**ER106:** VTR mode error (tension system)

**ER108:** VTR condensation error

**ER1FF:** VTR system error

# RS-232C interface

## 5. Command table

### ■ Commands relating to operation control

#### <Notes>

- As the return (completion) message, [ACK] is returned when data is received, and only the execution message which is subsequently returned is listed in the table.
- If a command not listed in the table is received, ER001 (invalid command) is returned after [ACK].

VTR operation	Send command	Return (completion) message
STOP	[STX] OSP [ETX] ↔	[STX] OSP [ETX]
	This command is for stopping the tape transport. The resulting output picture and sound statuses differ according to the setting selected for the setup menu item No.105 (AUTO EE SEL). For details, refer to the setup menus.	
EJECT	[STX] OEJ [ETX] ↔	[STX] OEJ [ETX]
	This command is for ejecting the cassette tape. The resulting output picture and sound statuses differ according to the setting selected for the setup menu item No.105 (AUTO EE SEL). For details, refer to the setup menus.	
PLAY	[STX] OPL [ETX] ↔	[STX] OPL [ETX]
	This command is for starting playback.	
REWIND	[STX] ORW [ETX] ↔	[STX] ORW [ETX]
	This command is for rewinding the tape. The resulting output picture and sound statuses differ according to the setting selected for the setup menu item No.105 (AUTO EE SEL). The maximum speed differs according to the setting selected for the setup menu item No.102 (FF. REW MAX). For details, refer to the setup menus.	
FAST FORWARD	[STX] OFF [ETX] ↔	[STX] OFF [ETX]
	This command is for fast forwarding the tape. The resulting output picture and sound statuses differ according to the setting selected for the setup menu item No.105 (AUTO EE SEL). The maximum speed differs according to the setting selected for the setup menu item No.102 (FF. REW MAX). For details, refer to the setup menus.	
REC	[STX] ORC [ETX] ↔	[STX] ORC [ETX]
	This command is for starting recording.	

VTR operation	Send command	Return (completion) message
SHTL FORWARD	[STX] OSF:data [ETX] ↔	[STX] OSF [ETX]
	<p>This is the forward direction shuttle command.</p> <p>data = n: speed data</p> <p>0: STILL</p> <p>1: ×0.03</p> <p>2: ×0.1</p> <p>3: ×0.2</p> <p>4: ×0.5</p> <p>5: ×1</p> <p>6: ×2.0 (1.85× for formats other than DVCPROHD-LP)</p> <p>7: ×4.9</p> <p>8: ×9.8</p> <p>9: ×16</p> <p>A: ×32</p> <p>&lt;Note&gt; The 16× and 32× speeds differ according to the setting selected for setup menu item No.101 (SHTL MAX).</p>	
SHTL REVERSE	[STX] OSR:data [ETX] ↔	[STX] OSR [ETX]
	<p>This is the reverse direction shuttle command.</p> <p>data = n: speed data</p> <p>0: STILL</p> <p>1: ×0.03</p> <p>2: ×0.1</p> <p>3: ×0.2</p> <p>4: ×0.5</p> <p>5: ×1</p> <p>6: ×2.0 (1.85× for formats other than DVCPROHD-LP)</p> <p>7: ×4.9</p> <p>8: ×9.8</p> <p>9: ×16</p> <p>A: ×32</p> <p>&lt;Note&gt; The 16× and 32× speeds differ according to the setting selected for setup menu item No.101 (SHTL MAX).</p>	
STANDBY OFF	[STX] OBF [ETX] ↔	[STX] OBF [ETX]
	This command is for setting the VTR to standby OFF.	
STANDBY ON	[STX] OBN [ETX] ↔	[STX] OBN [ETX]
	This command is for setting the VTR to standby ON.	

# RS-232C interface

## ■ Commands relating to inquiries

### <Notes>

- In terms of the return (completion) message, [ACK] is returned when data is received, and only the execution message which is subsequently returned is listed in the table.
- In the case of commands not listed in the table below, ER001 (invalid command) is returned after [ACK].

VTR operation	Send command	Return (completion) message
<b>CTL/TC DATA REQUEST</b>	[STX] QCD [ETX]	↔ [STX] CD data [ETX]
	<p>This command is for inquiring about the counter value.</p> <p>data = f w gh mm ss ff            f = F            w = S            gh =</p> <p>With CTL:            g = SP(20h): for a plus display            –(2Dh): for a minus display            h = 0 to 9: hours</p> <p>With TC:            gh = 00 to 23: hours            mm = 00 to 59: minutes            ss = 00 to 59: seconds            (525i system)            ff = 00 to 29: frames</p> <p>&lt;Note&gt;            CTL or TC is returned, whichever corresponds to the front display mode.</p>	
<b>STATUS REQUEST</b>	[STX] QOP [ETX]	↔ [STX] *** [ETX]
	<p>This command is for inquiring about the VTR's operation mode.</p> <p>*** = OEJ: EJECT            OFF: FAST FORWARD            OPL: PLAY            ORC: REC            ORW: REWIND            OSP: STOP (including STANDBY ON)            SRS: (IN/OUT) PREROLL            OBF: STAND BY OFF            OSF: SHTL FORWARD            OSR: SHTL REVERSE            OJG: JOG FORWARD/REVERSE            OSW: VAR FORWARD/REVERSE            EAE: AUTO EDIT            EON: EDIT ON (MANUAL EDIT)            EPV: PREVIEW            ERV: REVIEW</p>	
<b>ID (VTR No.) REQUEST</b>	[STX] QID [ETX]	↔ [STX] data [ETX]
	<p>This command is for inquiring about the VTR used.</p> <p>data = AJ-HD1700</p>	

# RS-232C interface

---

## ■ Microsoft QuickBASIC sample program

```
CLS
STX$ = CHR$(&H2): ETX$ = CHR$ (&H3): NAK$ = CHR$(15): ACK$ = CHR$(&H6)
PRINT "*** RS-232C COMMUNICATION SAMPLE PROGRAM ***"
PRINT "Type Command 'QUIT' to quit."
PRINT

REM *** Communication Port Initial & Open ***
REM Port 1,9600Bps,No parity,8 bit data,1 stop bit
OPEN "COM1:9600,N,8,1" FOR RANDOM AS #1 LEN = 256

REM *** Input Command & Send Command ***
SendCmd:
INPUT "Input Command ="; SEND$
IF SEND$ = "QUIT" THEN GOTO ProgEnd
PRINT #1, STX$ + SEND$ + ETX$

REM *** Wait for Receive Command ***
WHILE LOC(1) = 0
    WAITKEY$ = INKEY$
    IF WAITKEY$ = "Q" THEN PRINT "*** Quit ***": GOTO ProgEnd

WEND

REM *** Receive Command ***
RecvCmd:
RCV$ = INPUT$(1, #1)
IF RCV$ = STX$ THEN RCV$ = "[Stx]"
IF RCV$ = ACK$ THEN RCV$ = "[Ack]"
IF RCV$ = NAK$ THEN RCV$ = "[Nak]"
IF RCV$ = ETX$ THEN BUFFER$ = BUFFER$ + "[Etx]": GOTO DispOut
BUFFER$ = BUFFER$ + RCV$
GOTO RecvCmd

REM *** Output Receive Command ***
DispOut:
PRINT "Receive Command ="; BUFFER$
PRINT
BUFFER$ = ""
GOTO SendCmd

REM *** End Program ***
ProgEnd:
CLOSE
END
```

# Connector signals

## VIDEO IN

<b>HD SERIAL IN (DIGITAL)</b>	BNC × 1, active-through (BNC × 1)
<b>HD REF IN</b>	BNC × 2, loop-through, 75Ω termination switch provided
<b>SD REF IN</b>	BNC × 2, loop-through, 75Ω termination switch provided
<b>SD SERIAL IN (DIGITAL)</b>	BNC × 1, active-through (BNC × 1) (board, option)
<b>SDTI IN</b>	BNC × 1 (board, option)

## VIDEO OUT

<b>HD SERIAL OUT (DIGITAL)</b>	BNC × 4
<b>SD SERIAL OUT (DIGITAL)</b>	BNC × 2
<b>VIDEO OUT</b>	BNC × 3
<b>HD REF OUT</b>	BNC × 1
<b>SD REF OUT</b>	BNC × 1
<b>SDTI OUT</b>	BNC × 1 (board, option)

## AUDIO IN

<b>AUDIO IN (DIGITAL)</b>	BNC × 4 (CH1/CH2, CH3/CH4, CH5/CH6, CH7/CH8), AES/EBU format
<b>AUDIO IN (ANALOG)</b>	XLR × 4 (CH1, CH2, CH3, CH4)
<b>HD SERIAL IN (DIGITAL)</b>	BNC × 1, active-through (BNC × 1)
<b>SD SERIAL IN (DIGITAL)</b>	BNC × 1, active-through (BNC × 1) (board, option)
<b>CUE IN</b>	XLR × 1
<b>TIME CODE IN</b>	XLR × 1

## AUDIO OUT

<b>AUDIO OUT (DIGITAL)</b>	BNC × 4 (CH1/CH2, CH3/CH4, CH5/CH6, CH7/CH8), AES/EBU format
<b>AUDIO OUT (ANALOG)</b>	XLR × 4 (CH1, CH2, CH3, CH4)
<b>HD SERIAL OUT (DIGITAL)</b>	BNC × 4
<b>SD SERIAL OUT (DIGITAL)</b>	BNC × 2
<b>CUE OUT</b>	XLR × 1
<b>TIME CODE OUT</b>	XLR × 1
<b>MONITOR OUT</b>	XLR × 2 (L, R)
<b>HEADPHONES (front)</b>	1/4-inch (6.5 mm)

## RS-422A REMOTE (9P)

### ● REMOTE IN/OUT

Pin No.	Signal
1	FRAME GROUND
2	TRANSMIT A
3	RECEIVE B
4	RECEIVE COMMON
5	—————
6	TRANSMIT COMMON
7	TRANSMIT B
8	RECEIVE A
9	FRAME GROUND

### ● REMOTE OUT

Pin No.	Signal
1	FRAME GROUND
2	RECEIVE A
3	TRANSMIT B
4	TRANSMIT COMMON
5	—————
6	RECEIVE COMMON
7	RECEIVE B
8	TRANSMIT A
9	FRAME GROUND



# Connector signals

## PARALLEL REMOTE (50P)

Refer to 50P IN/OUT ASSIGN on the function menu (page 75) for the connection pin signals.

### RS-232C (D-SUB 25-pin, crossover cable supported)

Pin No.	Signal	Description
1	FG	Protective ground (frame ground)
2	RXD	Received data (data is sent to PC)
3	TXD	Transmitted data (data is received from PC)
4	CTS	Clear to send (shorted with pin 5)
5	RTS	Request to send (shorted with pin 4)
6	DTR	Data terminal ready (no processing)
7	SG	Signal ground
20	DSR	Data set ready (+ voltage output after communication enable status)

## ENCODER REMOTE(15P)

Pin No.	Signal
1	FRAME GROUND
4	REM (G)
7	REM RX (X) REMOTE CONTROL PROTOCOL RECEIVE
8	REM TX (X) REMOTE CONTROL PROTOCOL TRANSMIT
14	REM RX (Y) REMOTE CONTROL PROTOCOL RECEIVE
15	REM TX (Y) REMOTE CONTROL PROTOCOL TRANSMIT

# Printed circuit boards

## F1 board (ADDA)

Switch No.	What is set
SW1	<b>AUDIO INPUT IMPEDANCE SW</b> This sets the CH1 audio input impedance.  <u>HIGH/600Ω</u>
SW101	<b>AUDIO INPUT IMPEDANCE SW</b> This sets the CH2 audio input impedance.  <u>HIGH/600Ω</u>
SW201	<b>AUDIO INPUT IMPEDANCE SW</b> This sets the CH3 audio input impedance.  <u>HIGH/600Ω</u>
SW301	<b>AUDIO INPUT IMPEDANCE SW</b> This sets the CH4 audio input impedance.  <u>HIGH/600Ω</u>

## H3 board (CUE)

Switch No.	What is set
SW101	<b>CUE INPUT IMPEDANCE SW</b> This sets the CUE input impedance.  <u>HIGH/600Ω</u>

### CAUTION:

These servicing instructions are for use by qualified service personnel only. To reduce the risk of fire or electric shock do not perform any servicing other than that contained in the operating instructions unless you are qualified to do so.

The underlining (     ) denotes the factory setting mode.

# Specifications

## [GENERAL]

Power supply: AC 100–240V, 50–60 Hz (AJ-HD1700P) AC 100–240V, 50–60 Hz (AJ-HD1700E) Power consumption: 240W
---

 indicates the safety information.

### Operating ambient temperature:

41°F to 104°F (5°C to 40°C)

### Operating ambient humidity:

10% to 80% (no condensation)

### Weight:

Approx. 48.4 lbs (22 kg)

### Dimensions (W × H × D):

16-3/4 (max. 17-3/16) × 6-15/16 × 17-11/16 inches  
(not including supporting feet, jacks and connectors, JOG dial and fan)  
424 (max. 435.4) × 175.2 × 448.9 mm

### Recording format:

DVCPRO HD-LP

### Video signals recorded:

1080i (50/59.94/60 Hz switchable)  
720p (59.94/60 Hz switchable)  
480i/59.94 Hz  
576i/50 Hz (when optional board AJ-UC1700G is installed)

### Audio signals recorded:

48 kHz, 16 bits, 8 channels

### Recording tracks:

Digital video/audio:  
helical tracks  
(Time code is recorded in sub-code area.)  
Cue track:  
1 track  
Control track:  
1 track

### Tape speed:

67.64 mm/sec. (in 59.94 Hz mode)  
67.70 mm/sec. (in 60 or 50 Hz mode)

### Tape used:

Metal tape

### Recording time:

126 minutes (using XL cassette)  
92 minutes (using L cassette)  
32 minutes (using M cassette)

### FF/REW time:

Approx. 1 min. 30 sec. (when XL cassette is used and +100× or –100× speed is selected)

### Search speed:

±100×

### Digital slow:

–1× to +2× (when playing back tapes recorded using the DVCPRO HD-LP format)  
–1× to +1.1× (when playing back tapes recorded using any other format)

### Editing accuracy:

±0 frames (when time code is used, in 50 Hz, 59.94 Hz or 60 Hz mode)

### Tape timer accuracy:

±1 frame (when continuous CTL signal is used)

### Servo lock time:

Less than 0.3 sec. (from standby ON)

### Loading time:

Approx. 4 sec.

### Audio split editing:

Provided

## [VIDEO]

### Sampling frequencies:

Y: 74.25 MHz, Pb/Pr: 37.125 MHz

### Quantizing:

8 bits

### Video compression method:

DCT + variable length code

### Video compression rate:

1/6.7

### Error correction:

Reed-Solomon product code

### Video recording bit rate:

100 Mbps

## Video Input Connectors

### HD serial digital input:

BNC × 1 (complies with SMPTE 292M standard),  
BNC × 1 (active-through)

### SD serial digital input (option):

BNC × 1 (complies with SMPTE 259M-C standard),  
BNC × 1 (active-through)

### SDTI input (option):

BNC × 1 (complies with SMPTE 305M/SMPTE 321M standards)\*

### HD reference input:

BNC × 2 (loop-through), 75Ω ON/OFF selectable

### SD reference input:

BNC × 2 (loop-through), 75Ω ON/OFF selectable

## Video Output Connectors

### HD serial digital output:

BNC × 3 (complies with SMPTE 292M standard),  
BNC × 1 (monitor output with superimposed display)

### SD serial digital output:

BNC × 1 (complies with SMPTE 259M-C/SMPTE 294M standards),  
BNC × 1 (monitor output with superimposed display)

### SDTI output (option):

BNC × 1 (complies with SMPTE 305M/SMPTE 321M standards)

### HD reference output:

BNC × 1

### SD reference output:

BNC × 1

### Analog composite output:

BNC × 3, VIDEO 1, VIDEO 2 (WFM OUT), VIDEO 3 (superimposed ON/OFF), output during SD playback or during down-conversion

\* The optional AJ-UC1700G SD serial digital input board and optional AJ-YAC150P SDTI input board cannot be installed at the same time. Install one or the other.

# Specifications

## [VIDEO]

### Video signal adjustment ranges

#### • Component style

**HD/SD SDI, composite output Y gain:**  
−∞ to + 3 dB

**HD/SD SDI, composite output Pb gain:**  
−∞ to + 3 dB

**HD/SD SDI, composite output Pr gain:**  
−∞ to + 3 dB

**HD/SD SDI, composite output Y black level:**  
±10%

#### • Composite style

**HD/SD SDI, composite output video gain:**  
−∞ to + 6 dB

**HD/SD SDI, composite output chroma gain:**  
−∞ to + 3 dB

**HD/SD SDI, composite output chroma phase (\*):**  
±30°

**HD/SD SDI, composite output Y setup:**  
±10%

#### • System phase

##### HD SDI output system phase

±5.5 H (±12100 sample, 13.5 nS step, 59/60Hz)  
(±14520 sample, 50/25Hz)  
(±15125 sample, 23/24Hz)

##### SD SDI output system phase

±5.5 H (±9438 sample, 480i: 37nS step,  
480p: 54nS step)  
(±9504 sample, 576i)

##### Composite video output system phase

±5.5 H (±9438 sample, 37nS step, 59Hz)  
(±9504 sample, 37nS step, 50Hz)

##### Composite video output SC phase:

±180° or more

\*1: Only the SD SDI composite output of SD tape playback is valid in the 50 Hz or 25 Hz mode.

## [AUDIO]

### Digital Audio

#### Sampling frequency:

48 kHz (synchronized with video)

#### Quantizing:

16 bits

#### Frequency response:

20 Hz to 20 kHz ±10 dB (at reference level)

#### Dynamic range:

Better than 90 dB (1 kHz, emphasis OFF)

#### Distortion:

Less than 0.05% (1 kHz, emphasis OFF, reference level)

#### Crosstalk:

Less than −80 dB (1 kHz, between 2 channels)

#### Wow & flutter:

Below measurable limit

#### Headroom:

20 dB (AJ-HD1700P)

18 dB (AJ-HD1700E)

## [AUDIO]

### Cue Track

#### Frequency response:

300 Hz to 6 kHz ±3 dB

### Audio Input Connectors

#### Analog input (CH1 to CH4)

XLR × 4, 600Ω/high impedance (selectable), +4, 0, −20 dBu selectable

#### Digital input (CH1/CH2, CH3/CH4, CH5/CH6, CH7/CH8)

BNC × 4, AES/EBU format

#### HD serial digital input

BNC × 1 (complies with SMPTE 292M/SMPTE 299M standards)

BNC × 1 (active-through)

#### SD serial digital input (option)

BNC × 1 (complies with SMPTE 259M-C/SMPTE 272M-A standards)

BNC × 1 (active-through)

#### Cue track input

XLR × 1, 600Ω/high impedance (selectable), +4, 0, −20, −60 dBu selectable

### Audio output Connectors

#### Analog output (CH1 to CH4)

XLR × 4, low impedance, +4, 0, −20 dBu selectable

#### Digital output (CH1/CH2, CH3/CH4, CH5/CH6, CH7/CH8)

BNC × 4, AES/EBU format

#### HD serial digital output

BNC × 4 (complies with SMPTE 292M/SMPTE 299M standards)

#### SD serial digital output

BNC × 2 (complies with SMPTE 259M-C/SMPTE 294M/SMPTE 272M-A standards)

#### Cue track output

XLR × 1, low impedance (selectable), +4, 0, −20 dBu selectable

#### Monitor output

XLR × 2, low impedance (selectable), +4, 0, −20 dBu selectable

#### Headphone output

1/4-inch phone (6.5 mm), 8Ω, variable level

### Audio level adjustment range

−∞ to + 12 dB

# Specifications

---

## [OTHER INPUT/OUTPUT SIGNALS]

### **Time code input**

XLR × 1, 0.5 to 8.0 Vp-p, 10 k $\Omega$

### **Time code output**

XLR × 1, low impedance

2.0  $\pm$ 0.5 Vp-p, (with 600 $\Omega$  load)

### **RS-422A input**

D-sub 9-pin, RS-422A interface

### **RS-422A output**

D-sub 9-pin, RS-422A interface

### **RS-232C**

D-sub 25-pin, RS-232C interface

### **Parallel input/output**

D-sub 50-pin

### **Encoder remote**

D-sub 15-pin

## [OPTIONAL ACCESSORIES]

### **Rack-mounting adapters:**

AJ-MA75P

### **SD-HD format converter board:**

AJ-UC1700G

### **Encoder/decoder board supporting DVCPRO HD bank data:**

AJ-VNC150P

### **SDTI interface board:**

AJ-YAC150P

Weight and dimensions shown are approximate.  
Specifications are subject to change without notice.



---

# Panasonic

**PANASONIC BROADCAST & TELEVISION SYSTEMS COMPANY**  
UNIT COMPANY OF MATSUSHITA ELECTRIC CORPORATION OF AMERICA

**Executive Office:**

One Panasonic Way 4E-7, Secaucus, NJ 07094 (201) 348-7000

**EASTERN ZONE:**

One Panasonic Way 4E-7, Secaucus, NJ 07094 (201) 348-7621

**Southeast Region:**

1225 Northbrook Parkway, Ste 1-160, Suwanee, GA 30024 (770) 338-6835

**Central Region:**

1707 N Randall Road E1-C-1, Elgin, IL 60123 (847) 468-5200

**WESTERN ZONE:**

3330 Cahuenga Blvd W., Los Angeles, CA 90068 (323) 436-3500

**Government Marketing Department:**

52 West Gude Drive, Rockville, MD 20850 (301) 738-3840

**Broadcast PARTS INFORMATION & ORDERING:**

9:00 a.m. – 5:00 p.m. (EST) (800) 334-4881/24 Hr. Fax (800) 334-4880

Emergency after hour parts orders (800) 334-4881

**TECHNICAL SUPPORT:**

Emergency 24 Hour Service (800) 222-0741

**Panasonic Canada Inc.**

5770 Ambler Drive, Mississauga, Ontario L4W 2T3 (905) 624-5010

**Panasonic de Mexico S.A. de C.V.**

Av angel Urraza Num. 1209 Col. de Valle 03100 Mexico, D.F. (52) 1 951 2127

**Panasonic Sales Company**

**Division of Matsushita Electric of Puerto Rico Inc.**

San Gabriel Industrial Park, 65th Infantry Ave., Km. 9.5, Carolina, Puerto Rico 00630 (787) 750-4300

---

## Panasonic Broadcast Europe

Panasonic Broadcast Europe Ltd

West Forest Gate, Wellington Road, Wokingham, Berkshire RG40 2AQ U.K. Tel: 0118 902 9200

## Panasonic Broadcast Europe GmbH

Hagenauer Str. 43, 65203 Wiesbaden-Biebrich Deutschland Tel: 49-611-1816-0

Printed in Japan

F0703H1 

## Free Manuals Download Website

<http://myh66.com>

<http://usermanuals.us>

<http://www.somanuals.com>

<http://www.4manuals.cc>

<http://www.manual-lib.com>

<http://www.404manual.com>

<http://www.luxmanual.com>

<http://aubethermostatmanual.com>

Golf course search by state

<http://golfingnear.com>

Email search by domain

<http://emailbydomain.com>

Auto manuals search

<http://auto.somanuals.com>

TV manuals search

<http://tv.somanuals.com>