

# Panasonic®

## Operating Instructions

---

### Digital Video Cassette Recorder

Model No. AJ-SD965P

**DVCPRO 50**

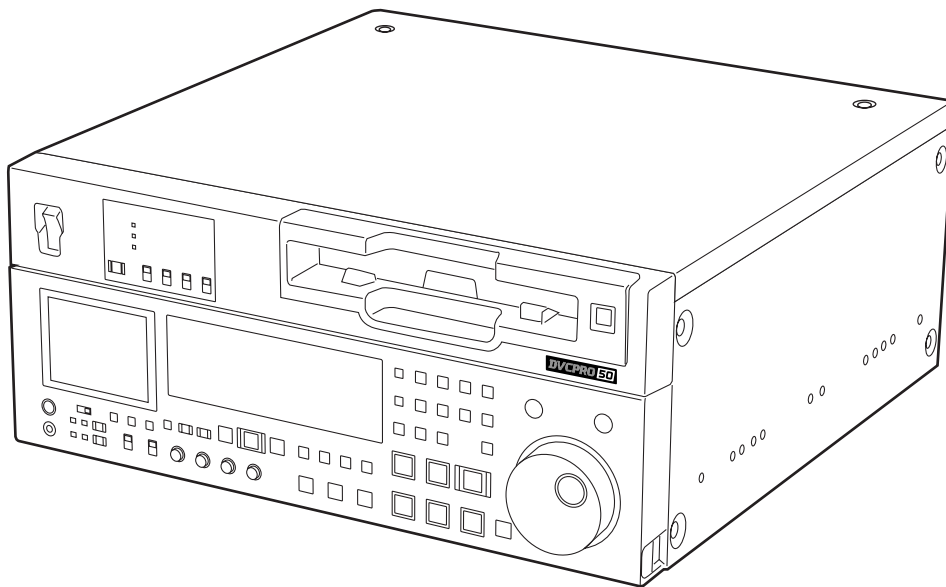



Before operating this product, please read the instructions carefully and save this manual for future use.

## IMPORTANT

“Unauthorized recording of copyrighted television programs, video tapes and other materials may infringe the right of copyright owners and be contrary to copyright laws.”

## Operating precaution

Operation near any appliance which generates strong magnetic fields may give rise to noise in the video and audio signals. If this should be the case, deal with the situation by, for instance, moving the source of the magnetic fields away from the unit before operation.

	<b>CAUTION</b> RISK OF ELECTRIC SHOCK DO NOT OPEN	
CAUTION: TO REDUCE THE RISK OF ELECTRIC SHOCK, DO NOT REMOVE COVER (OR BACK). NO USER SERVICEABLE PARTS INSIDE. REFER TO SERVICING TO QUALIFIED SERVICE PERSONNEL.		



The lightning flash with arrowhead symbol, within an equilateral triangle, is intended to alert the user to the presence of uninsulated “dangerous voltage” within the product’s enclosure that may be of sufficient magnitude to constitute a risk of electric shock to persons.



The exclamation point within an equilateral triangle is intended to alert the user to the presence of important operating and maintenance (service) instructions in the literature accompanying the appliance.

### ■ THIS EQUIPMENT MUST BE GROUNDED

To ensure safe operation, the three-pin plug must be inserted only into a standard three-pin power outlet which is effectively grounded through the normal household wiring.

Extension cords used with the equipment must have three cores and be correctly wired to provide connection to the ground. Wrongly wired extension cords are a major cause of fatalities.

The fact that the equipment operates satisfactorily does not imply that the power outlet is grounded or that the installation is completely safe. For your safety, if you are in any doubt about the effective grounding of the power outlet, please consult a qualified electrician.

### WARNING:

- TO REDUCE THE RISK OF FIRE OR SHOCK HAZARD, DO NOT EXPOSE THIS EQUIPMENT TO RAIN OR MOISTURE.
- TO REDUCE THE RISK OF FIRE OR SHOCK HAZARD, KEEP THIS EQUIPMENT AWAY FROM ALL LIQUIDS-USE AND STORE ONLY IN LOCATIONS WHICH ARE NOT EXPOSED TO THE RISK OF DRIPPING OR SPLASHING LIQUIDS, AND DO NOT PLACE ANY LIQUID CONTAINERS ON TOP OF THE EQUIPMENT.

### CAUTION:

TO REDUCE THE RISK OF FIRE OR SHOCK HAZARD AND ANNOYING INTERFERENCE, USE THE RECOMMENDED ACCESSORIES ONLY.

### CAUTION:

TO REDUCE THE RISK OF FIRE OR SHOCK HAZARD, REFER MOUNTING OF THE OPTIONAL INTERFACE BOARD TO AUTHORIZED SERVICE PERSONNEL.

### CAUTION:

TO REDUCE THE RISK OF FIRE OR SHOCK HAZARD, REFER CHANGE OF SWITCH SETTING INSIDE THE DECK TO QUALIFIED SERVICE PERSONNEL.

### CAUTION:

Do not install or place this deck in a bookcase, built-in cabinet or any other confined space in order to maintain adequate ventilation. Ensure that curtains and any other materials do not obstruct the ventilation to prevent risk of electric shock or fire hazard due to overheating.

### CAUTION:

- Keep the temperature inside the rack to between 41°F to 104°F (5°C to 40°C).
- Bolt the rack securely to the floor so that it will not topple over when the deck is drawn out.

### CAUTION:

THE AC RECEPTACLE (MAINS SOCKET OUTLET) SHALL BE INSTALLED NEAR THE EQUIPMENT AND SHALL BE EASILY ACCESSIBLE. TO COMPLETELY DISCONNECT THIS EQUIPMENT FROM THE AC MAINS, DISCONNECT THE POWER CORD PLUG FROM THE AC RECEPTACLE.

**FCC Note:**

This equipment has been tested and found to comply with the limits for a class A digital device, pursuant to Part 15 of the FCC Rules. These limits are designed to provide reasonable protection against harmful interference when the equipment is operated in a commercial environment. This equipment generates, uses, and can radiate radio frequency energy and, if not installed and used in accordance with the instruction manual, may cause harmful interference to radio communications.

Operation of this equipment in a residential area is likely to cause harmful interference in which case the user will be required to correct the interference at his own expense.

**Warning:**

To assure continued FCC emission limit compliance, the user must use only shielded interface cables when connecting to external units. Also any unauthorized changes or modifications to this equipment could void the user's authority to operate it.

**CAUTION:**

This apparatus can be operated at a voltage in the range of 100 – 240 V AC.

Voltage other than 120 V is not intended for U.S.A. and Canada.

**CAUTION:**

Operation at a voltage other than 120 V AC may require the use of a different AC plug. Please contact either a local or foreign Panasonic authorized service center for assistance in selecting an alternate AC plug.

**Notice (U.S.A. only):**

**This product has a fluorescent lamp that contains a small amount of mercury.**

**It also contains lead in some components. Disposal of these materials may be regulated in your community due to environmental considerations.**

**For disposal or recycling information please contact your local authorities, or the Electronics Industries Alliance:**

**<<http://www.eiae.org>>**

 indicates safety information.

# Contents

Introduction .....	4	Time code/user bit .....	62
Features .....	5	Superimpose screen .....	64
Parts and their functions .....	7	Video output signals and servo reference signal .....	65
Front panel .....	7	Audio V fade function .....	67
Display panel .....	16	Audio recording channel and monitor output selection .....	68
Rear panel .....	18	Printed circuit board .....	68
Connections .....	20	Rack mounting .....	69
Tapes .....	22	Video head cleaning .....	70
Jog/Shuttle .....	23	Condensation .....	70
Manual editing .....	24	Maintenance .....	70
Preroll .....	24	Error messages .....	71
Automatic editing (deck-to-deck) .....	25	RS-232C interface .....	76
Switch settings and adjustments .....	25	Connector signals .....	81
Selecting the editing mode .....	26	Specifications .....	83
Registering the edit points .....	26		
Checking and previewing edit points .....	27		
Modifying edit points .....	28		
Executing and reviewing automatic editing .....	29		
Audio split editing .....	30		
Variable memory editing .....	32		
PF (Programmable Function) functions .....	33		
Setup (initial settings) .....	34		
Setup menus .....	35		
SYSTEM menu .....	38		
USER menus .....	40		
<BASIC> .....	40		
<OPERATION> .....	42		
<INTERFACE> .....	45		
<EDIT> .....	46		
<TAPE PROTECT> .....	48		
<TIME CODE> .....	49		
<VIDEO> .....	51		
<AUDIO> .....	55		
<V BLANK> .....	58		
<LCD> .....	61		
<MENU> .....	61		

## Optional interface boards

- Analog Video Input Board  
AJ-YA932G (625i), AJ-YA931G (525i)
- Digital Video Interface Board (IEEE 1394)  
AJ-YAD955G

Use only the optional boards listed above.

**The AJ-YAD455P or AJ-YAD755G cannot be used with this unit.**

AJ-YAD455P: IEEE 1394 board for the AJ-D455  
AJ-YAD755G: IEEE 1394 board for the AJ-SD755

Never use the AJ-YAD455P or AJ-YAD755G with this unit as it will cause malfunctioning.

## Introduction

The AJ-SD965 is multi-purpose studio digital VTR which utilize small, 1/4-inch wide cassette tapes for high quality recording, playback and editing of video images recorded at a rate of 50 Mbps in addition to recording, playback and editing in DVCPRO (25 Mbps) format.

This VTR incorporate digital compression technology to dramatically reduce deterioration of picture quality and sound resulting from dubbing, thereby attaining high picture quality.

This unit also come equipped with a variety of functions, such as assemble and insert functions, which are necessary when performing editing operations with a VTR.

A 3.5-inch color LCD monitor is also featured to allow users to perform settings and monitor the display images with consummate ease.

# Features

---

## Light and compact

This unit is a 4U size digital VTR and can be easily mounted in a 19-inch rack by using the rack mounting adapters (AJ-MA75P, optional accessory).

## Up to 126 minutes of recording at the 50 Mbps rate

The cassette tapes used have 1/4-inch width to achieve a compact design.

M cassette (when AJ-P66MP is used)

50 Mbps: Max. 33 minutes

25 Mbps: Max. 66 minutes

L cassette (when AJ-5P92LP is used)

50 Mbps: Max. 92 minutes

25 Mbps: Max. 184 minutes

XL cassette (when AJ-5P126XG is used)

50 Mbps: Max. 126 minutes

25 Mbps: Max. 252 minutes

## Superior picture quality

Superior picture quality is achieved through 4:2:2 component signal recording at 2 times the recording rate of the existing DVCPRO (25 Mbps) format.

## Switching between 525i and 625i TV systems

By selecting the setting (setup menu item No. 070) that matches the video input signal TV system (525i or 625i), the signals of each TV system can be recorded and/or played back.

## SDI interface

A 4:2:2 serial digital interface is a standard feature.

## Compatibility with DVCPRO (25 Mbps) format

This unit can record, play back and edit material in the existing DVCPRO (25 Mbps) format.

## Compatibility with general consumer video equipment

DV cassette tapes containing material shot with a consumer digital camera or the like can be played back on this unit. A cassette adapter (AJ-CS455P) is necessary when a mini DV cassette tape is to be used.

## Digital slow motion/jog dial

Panasonic's original digital slow-motion technology makes it possible to attain clear pictures even during slow playback at speeds of  $-0.43$  to  $+0.43/+0.5/+0.75$ . (DVCPRO, DVCPRO50)

## Dial shuttle

Color images can be played back in forward and reverse directions up to a maximum of  $\times 32$  normal playback speed.

## Recording and playback of UMID information

Recording and playback of UMID (Unique Material Identifier) information complies with the SMPTE 330M standard.

UMID information can be checked on the DIAG menu.

UMID information cannot be played back correctly by VTRs that do not support the recording and playback of UMID information.

In addition, even if a VTR that does not support the recording and playback of UMID information is connected to this unit and recording performed, UMID information will not be recorded correctly.

## Time codes

This unit has a built-in TCG (time code generator)/TCR (time code reader).

In addition to the internal time code, external time code input or input signal VITC can be recorded on this VTR as the time code.

## Multi-function front panel with LCD monitor

The LCD panel for monitoring images, the large-size display panel and many function buttons are housed on the 4U size front panel, and this is a layout which makes for improved operability.

## Direct audio channel mixing

By operating the buttons on the front panel, the audio signals (CH1 to CH4) to be recorded can be switched directly.

## PF (Programmable Function) buttons

Four of the setup menu items which are used most frequently can be registered in four PF buttons.

The settings for the items registered can be changed directly using these buttons.

## Features (continued)

---

### Multifunctional interface

- **Serial digital input/output**

A component serial interface is provided as standard and enables interfacing of the serial digital component signals.

- **Analog video input/output**

Both composite and component signal outputs are provided as standard.

Use of an analog video input board (AJ-YA931G, optional accessory) enables interfacing of the component (Y, PB, PR) and composite signal input.

**Use the AJ-YA932G analog video input board when the AJ-SD965 is to be used with a 625i system.**

- **AES/EBU audio input/output**

Digital audio input/output connectors are provided.

- **IEEE1394 digital input/output**

Use of a digital video interface board (AJ-YAD955G, optional accessory) enables input/output interfacing of the digital signals with the IEEE1394 standard.

- **9-pin RS-422A/RS-232C remote**

In addition to the standard 9-pin serial remote (RS-422A), RS-232C and 25-pin parallel remote connectors are also provided.

The RS-422A enables another VTR to be operated in parallel with the unit if loop connection is used.

- **4-channel, high-sound-quality digital audio**

The 4-channel PCM audio enables independent editing for all four channels in addition to channel mixing.

- **Menu-based setup**

The setup settings, which are conducted prior to operating the unit, are performed while viewing the setup menus on the unit's display or a TV monitor.

# Parts and their functions

## Front panel

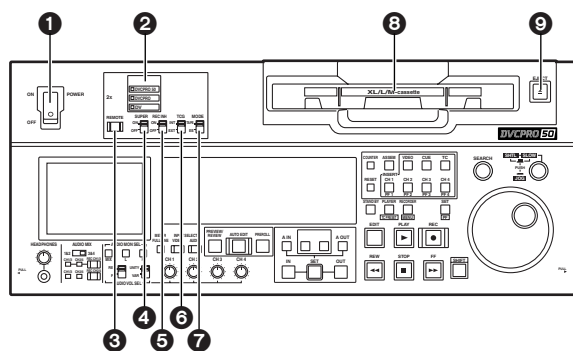

### 1 POWER switch

### 2 Format display area

The recording format and the format of the tape inserted in the unit are displayed here.

#### DVCPRO50:

This indicates recording and playback of DVCPRO50 (50 Mbps) format tapes.

#### DVCPRO:

This indicates recording and playback of DVCPRO (25 Mbps) format tapes.

#### DV:

This indicates playback of DV format tapes.

### 3 REMOTE button

Press this button to switch the mode when a device connected to the 9-pin REMOTE, RS-232C or PARALLEL connector is to be used to control this VTR.

#### Remote mode (lamp ON):

The unit can be controlled by the external device which has been set using the setup menu items below.

No.201 (9P SEL)

No.203 (25P SEL)

No.204 (RS232C SEL)

#### Local mode (lamp OFF):

The unit can be controlled using the controls on its own operation panel.

When ON is selected as the setup menu item No.211 (LOCAL 25P) setting, the unit can be controlled by the external device which has been connected to the PARALLEL connector.

### 4 SUPER switch

#### ON:

The setup menus and other information are superimposed onto the display of the TV monitor which is connected to the VIDEO OUT 3 connector or SDI OUT 3 connector.

#### OFF:

The menus and other information are not superimposed.

### 5 REC INH switch

This switch is used to enable or disable recording on the cassette tape.

#### ON:

Recording on the cassette tape is disabled (inhibited).

In this state, the REC INH lamp lights on the display panel.

#### OFF:

Recording on the cassette tape is enabled so long as the accidental erasure prevention mechanism on the cassette tape is set to enable recording.

### 6 TCG switch

#### INT:

The time code generated by the time code generator incorporated inside the unit is used.

#### EXT:

The external time code which is input from the time code input connector or video signal VITC is used. Which of the two is to be set is selected using setup menu No. 505 (EXT TC SEL).

### 7 MODE switch

#### <In the stop mode>

#### TAPE:

The signal which is played back from the tape is output.

#### EE:

The input signal selected by the INPUT SELECT button is output.

#### <During recording or editing>

#### TAPE:

The simultaneous playback signals are output. (The setup menu No.310 (CONFI EDIT) setting is necessary.)

#### EE:

The input signal selected by the INPUT SELECT button is output.

### 8 Cassette insertion slot

### 9 EJECT button

When this button is pressed, the tape is unloaded and the cassette is ejected automatically a few seconds later.

When CTL display has been selected for the counter display, the display is reset.

EJECT button operation can be enabled or disabled with setup menu No. 115 (EJECT SW INH).

## Parts and their functions (continued)

### Front panel

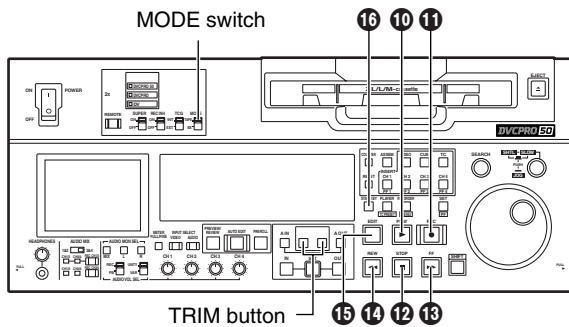

#### 10 PLAY button

Press this button to start playback.

When this button is pressed together with the REC button, recording starts.

When this button is pressed together with the EDIT button during playback, manual editing starts. However, manual editing will not be initiated if the servo is not locked. When only the PLAY button is pressed during manual editing, editing is exited, and the playback mode is established.

When the TRIM+ (or TRIM-) button is pressed while this button is held down, playback speed will be increased (or decreased) by the frame mode unit selected for the setup menu No. 108 (CAP. LOCK) setting each time one of the TRIM buttons is pressed.

#### <Note>

The servo lamp turns off while the speed is being increased or decreased. At this time, noise occurs in the playback audio signal.

#### 11 REC button

When this button is pressed together with the PLAY button, recording starts.

When it is pressed during playback, a search, fast forwarding or rewinding, the E-E mode pictures and audio signals can be monitored while it is held down.

When it is pressed in the stop mode, the E-E mode pictures and audio signals can be monitored. When the STOP button is pressed, the original pictures and sound are restored.

#### 12 STOP button

When this button is pressed, the tape stops traveling, and if the MODE switch is set to TAPE, still pictures can be monitored. Even in the stop mode, the drum continues to rotate, and the tape remains tightly wound around the drum.

When the VTR is left in the stop mode beyond a specific period of time (which can be selected using setup menu No. 400 to 403), it is automatically set to the standby OFF mode or STEP FWD mode in order to protect the tape. The VTR is set to the stop mode immediately after the cassette has been inserted.

#### 13 FF button

When this button is pressed, the tape is fast forwarded.

The fast forwarding speed can be selected using setup menu No.102 (FF. REW MAX).

#### 14 REW button

When this button is pressed, the tape is rewound.

The rewinding speed can be selected using setup menu No.102 (FF. REW MAX).

#### 15 EDIT button

This button is pressed together with the PLAY button during playback to initiate manual editing.

When it is pressed during playback, a search, fast forwarding or rewinding, the input signals in the mode selected by the ASSEM button or INSERT button can be monitored in the E-E mode while the button is held down.

When the button is pressed in the stop mode, the input signals in the mode selected by the ASSEM button or INSERT button can be monitored in the E-E mode.

When the STOP button is pressed, the original pictures and sound are restored.

#### 16 STAND BY button

In the standby ON mode, this button's lamp lights to indicate that the same tape tension is applied as in the regular stop mode and that the head drum is rotating.

In the standby OFF mode, the half loading mode is established by this button.

When the button is pressed in the stop mode, the standby OFF mode is established. At this time, its lamp goes off.

When the VTR is left in the stop mode beyond a specific period of time, it is automatically set to the standby OFF mode in order to protect the tape.

When this button or the STOP button is pressed in the standby OFF mode, the VTR is set to the standby ON mode.

When a button other than the STOP button is pressed, the VTR is set to the mode that corresponds to the button pressed. The time taken by the VTR to transfer to the standby OFF mode can be selected using setup menu No. 400 (STILL TIMER).



## Parts and their functions (continued)

### Front panel

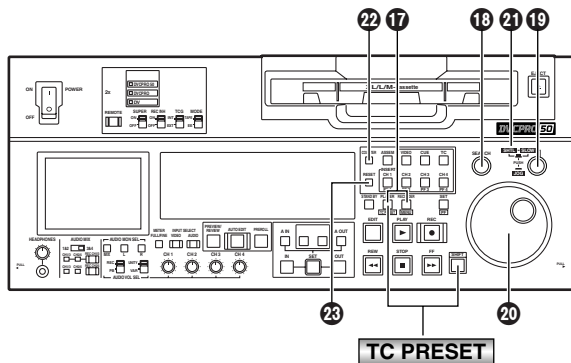

#### 17 PLAYER and RECORDER buttons

These buttons are operated if the VTR is to be used as a recorder to conduct editing operations with a VTR equipped with an RS-422A serial interface remote control connector (9 pins). Neither button works when the VTR is used on its own.

##### PLAYER:

When this button is pressed, its lamp lights to indicate that the player connected to the VTR can be operated by remote control. The VTR's editing and tape transport system buttons can now be used to control the player.

##### RECORDER:

When this button is pressed, its lamp lights to indicate that the editing and tape transport system buttons can now be used to operate the recorder (this VTR).

When the PLAYER button or RECORDER button is pressed while ENA has been selected as the setup menu No. 200 (PARA RUN) setting, the lamps of both buttons light to indicate that the VTR now serves as the master unit for parallel run operations. (However, when this setting is used, it is no longer possible to perform external control from the 9-pin REMOTE connector.)

#### 18 Search button

When this button is pressed, the search mode is established.

When it is pressed after the search dial has been set to the shuttle mode and turned to the desired position, playback starts at the speed which was set by the search dial.

#### 19 SHTL/SLOW button

This button is used to select whether the search dial is to be used for SHTL or SLOW applications. Each time it is pressed, the search dial is set alternately to SHTL or SLOW.

#### 20 Search dial

This dial is used to locate the edit points.

Each time it is pressed, it is set alternatively to the SHTL/SLOW mode or the JOG mode, and the JOG, SHTL or SLOW lamp lights.

When the power is turned on, the search dial will not operate unless it is first returned to the STILL position.

##### SHTL (shuttle) mode:

When the dial is turned and set to the desired position while the SHTL lamp among the JOG, SHTL and SLOW lamps is lit, the tape can be played at the speed corresponding to the angle at which the dial has been turned. A still picture appears when the dial is set to the center position.

##### SLOW mode:

When the dial is turned all the way in the counterclockwise direction while the SLOW lamp among the JOG, SHTL and SLOW lamps is lit, the tape speed is set to  $-4.1\times$ . Similarly, when it is set to the center position, it is set to still picture, and when it is turned all the way in the clockwise direction, it is set to  $+4.1\times$ . The SLOW speed in each direction can be selected using setup menu No. 320 (VAR FWD MAX) and No. 321 (VAR REV MAX).

##### JOG mode:

In this mode, the dial's click-stops are released, and the tape is played back at the speed ( $-1\times$  to  $+1\times$ ) corresponding to the speed at which the dial is turned.

The maximum speed can be set using setup menu No. 323 (JOG FWD MAX) and No. 324 (JOG REV MAX).

#### 21 JOG and SHTL/SLOW lamps

These lamps indicate the search dial mode.

##### JOG:

This lights in the JOG mode.

##### SHTL/SLOW:

This lights in the SHTL/SLOW mode.

#### 22 COUNTER button

Each time this button is pressed, the counter display on the display panel changes to the next setting in the following sequence: CTL  $\rightarrow$  TC  $\rightarrow$  UB.

#### 23 RESET button

When this button is pressed in the CTL mode, the counter display is reset to [00:00:00:00]. At the same time, any edit points that have been registered will also be cleared.

When this button is pressed while the **TC PRESET** (SHIFT+PLAYER) is held down in the TC or UB mode, the time code generator is reset.

## Parts and their functions (continued)

### Front panel

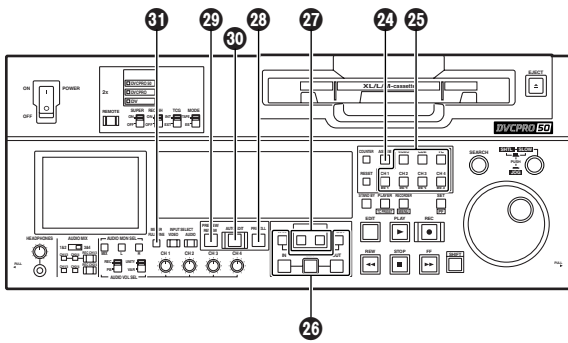

#### 24 ASSEM button

This button is pressed to proceed with assemble editing.

It has a self-illuminating lamp which comes ON when the button is pressed and goes OFF when it is pressed again.

#### 25 INSERT buttons

The input signals to be edited when insert editing is to be conducted are selected by pressing one of these seven buttons.

Each of these buttons has a self-illuminating lamp which comes ON when the button is pressed and goes OFF when it is pressed again.

#### 26 IN (A IN), SET and OUT (A OUT) buttons

When the SET button is pressed while the IN (A IN) or OUT (A OUT) button is held down, the IN (A IN) or OUT (A OUT) point is registered.

The A IN and A OUT buttons are used during audio split editing to register audio IN and OUT points that differ from the corresponding video points.

When an IN (A IN) or OUT (A OUT) point has been registered, the lamp of the IN (A IN) or OUT (A OUT) button which has registered that point lights.

When these buttons are pressed after points have been registered, the IN (A IN) or OUT (A OUT) point value appears on the counter display. When the IN (A IN) or OUT (A OUT) button is pressed together with the RESET button, the registration of the IN (A IN) or OUT (A OUT) point is cleared.

#### 27 TRIM buttons

These buttons are used to make fine adjustments to the IN (A IN) or OUT (A OUT) point.

By pressing the + or - button while the IN (A IN) button or OUT (A OUT) button is held down, the registered edit point can be adjusted in 1-frame increments. When the + button is pressed, the point is moved ahead by one frame; conversely, when the - button is pressed, it is moved back by one frame.

#### 28 PREROLL button

This button is used to locate where a transmission or manual editing starts on the tape.

When it is pressed, the tape travels to the preroll point and stops.

The preroll time can be set using setup menu No. 000 (P-ROLL TIME).

When the button is pressed while the IN (A IN) or OUT (A OUT) button is held down, the tape is cued up to the registered point concerned.

If this button is pressed when no IN point has been entered, the point where the button was pressed will automatically be entered as the IN point. (However, this is only the case if ENA has been selected as the setup menu No. 313 (AUTO ENTRY) setting.)

#### 29 PREVIEW/REVIEW button

##### PREVIEW:

When the button is pressed after an edit point has been registered, the tape travels and the editing can be previewed without actually performing the editing.

If the button is pressed when no IN point has been registered, the point where it was pressed is registered as the IN point, and preview is executed using this IN point.

##### REVIEW:

When the button is pressed after a section has been edited, the section that was just edited is played back and can be viewed on the recorder's monitor.

#### 30 AUTO EDIT button

When this button is pressed after the edit points have been registered, automatic editing is initiated.

If this button is pressed when no IN point has been entered, automatic editing is initiated with the point where the button was pressed serving as the IN point.

#### 31 METER (FULL/FINE) selector button

This button is used to select the scale display for the audio level meter.

##### FULL mode:

The standard scale ( $-\infty$  to 0 dB) is selected.

##### FINE mode:

The scale in 0.5 dB increments is selected.

The  $\blacksquare$  position indicates the standard audio level of -20 dB, and each of the dots (●) displayed indicates a 1 dB scale increment.

(See page 17)

## Front panel

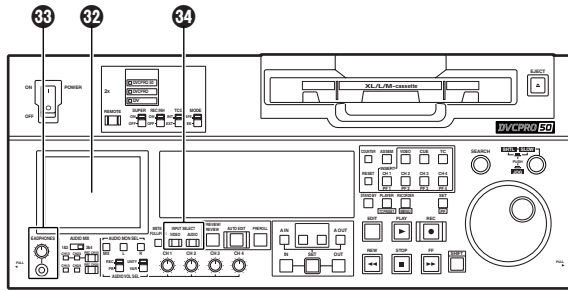

### 32 3.5-inch color LCD monitor

This monitor enables the output images and menu settings to be monitored. Information such as the time code is not displayed.

#### [Saving function of LCD monitor]

If none of the controls on the front panel are operated or the cassette tape does not move at all for about 5 minutes, the saving function is activated, and the display vanishes from the LCD monitor.

To release this function, either operate one of the buttons or the dial on the front panel or issue a tape transport instruction from the controller. The operation performed to release the saving function is executed without the user having to take another step.

- When OFF is set as the setup menu item No.900 (LCD PROTECT) setting, the saving function will not work.

#### <Note>

Although the LCD monitor has been manufactured using technology with extremely high levels of precision, some pixels may be missing from parts of the screen or some pixels may remain lighted. These missing or lighted pixels will not be recorded. It should also be borne in mind that this is not indicative of a malfunction.

### 33 Headphone jack and volume control

When stereo headphones are connected to the headphone jack, the sound during recording, playback or editing can be monitored using the headphones.

The volume level of the headphone output and monitor output can be adjusted using the volume control.

Whether the volume level of the monitor output is to be coupled to the volume control or not can be selected using the setup menu item No. 713 (MONI OUT). (Note that the volume level of the headphones is coupled at all times.)

When the volume of the monitor output is not coupled, it is fixed at a set level and is not affected by the position of the volume control.

### 34 INPUT SELECT buttons

These buttons switch the video and audio input signals. It is also possible to switch the input signals to the internal reference signal selected on setup menu No. 600 (INT SG).

#### VIDEO:

Each time the VIDEO button is pressed, the input video signal selection is switched in the order of Y PB PR → CMPST → SDI → SDTI/1394 → SG (SG/SG1/SG2).

- When SG has been selected, the signal is switched to the internal reference signal selected on setup menu No. 600 (INT SG).

#### AUDIO:

Each time the AUDIO button is pressed, the input audio signal selection is switched in the order of ANALOG → AES/EBU → USER SET → SDI → SDTI/1394 → SG.

- USER SET is a function which enables the input signals to be selected and recorded separately on PCM audio signal channels 1 through 4, and is used in conjunction with the setup menu.

#### Example:

##### Settings

AUDIO button  
USER SET  
Setup menus  
No.715 (CH1 IN SEL) : ANA  
No.716 (CH2 IN SEL) : DIGI  
No.717 (CH3 IN SEL) : DIGI  
No.718 (CH4 IN SEL) : ANA  
No.719 (D IN SEL12) : AES  
No.720 (D IN SEL34) : SIF

##### PCM audio signals to be recorded on the tape

CH1 : Analog input signals  
CH2 : AES/EBU digital signals  
CH3 : SDI input digital signals  
CH4 : Analog input signals

#### <Notes>

- It is possible to inhibit input switching operations (video and audio) of the INPUT SELECT buttons with setup menu No. 112 (V IN SEL INH) and No. 113 (A IN SEL INH).
- Y PB PR, CMPST and SDTI/1394 cannot be selected unless one of the optional boards (AJ-YA931G, AJ-YAD955G) has been installed.

# Parts and their functions (continued)

## Front panel

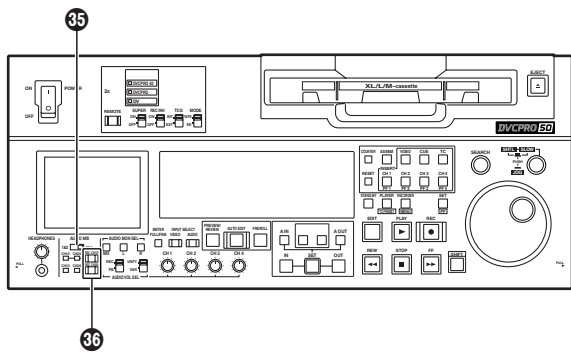

### 35 AUDIO MIX switch

This is used to switch the input signals to be recorded on the CH1, CH2, CH3 and CH4 audio channels in conjunction with the REC CH1/CH3 and REC CH2/CH4 buttons 36.

#### 1&2:

The audio input signals are switched to CH1 by the REC CH1/CH3 button.

The audio input signals are switched to CH2 by the REC CH2/CH4 button.

#### 3&4:

The audio input signals are switched to CH3 by the REC CH1/CH3 button.

The audio input signals are switched to CH4 by the REC CH2/CH4 button.

### 36 REC CH1/CH3 and REC CH2/CH4 buttons, and CH1/3 and CH2/4 lamps

These buttons are used to switch the input signals to be recorded on the CH1, CH2, CH3 and CH4 audio channels in conjunction with the AUDIO MIX switch 35.

**CH1/3, CH2/4 lamp displays**  
 ■: ON, □: OFF

#### When the AUDIO MIX switch is set to 1&2

- Each time the REC CH1/CH3 button is pressed, the setting status is switched in turn to A, B and C in this sequence.

	Lamp		Channel on which signals are recorded	Input channel
	CH1/3	CH2/4		
A	■	□	CH1	CH1
B	□	■	CH1	CH2
C	■	■	CH1	CH1+CH2

- Each time the REC CH2/CH4 button is pressed, the setting status is switched in turn to A, B and C in this sequence.

	Lamp		Channel on which signals are recorded	Input channel
	CH1/3	CH2/4		
A	□	■	CH2	CH2
B	■	■	CH2	CH1+CH2
C	■	□	CH2	CH1

#### When the AUDIO MIX switch is set to 3&4

- Each time the REC CH1/CH3 button is pressed, the setting status is switched in turn to A, B and C in this sequence.

	Lamp		Channel on which signals are recorded	Input channel
	CH1/3	CH2/4		
A	■	□	CH3	CH3
B	□	■	CH3	CH4
C	■	■	CH3	CH3+CH4

- Each time the REC CH2/CH4 button is pressed, the setting status is switched in turn to A, B and C in this sequence.

	Lamp		Channel on which signals are recorded	Input channel
	CH1/3	CH2/4		
A	□	■	CH4	CH4
B	■	■	CH4	CH3+CH4
C	■	□	CH4	CH3

## Parts and their functions (continued)

### Front panel

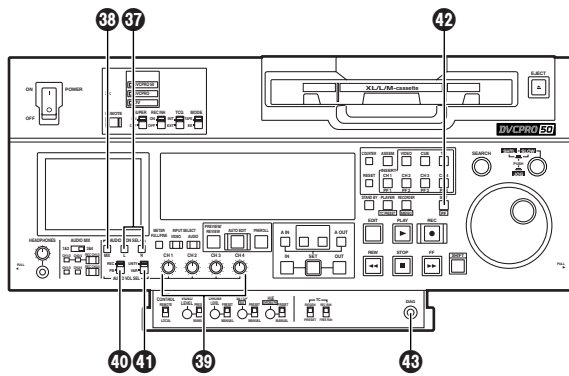

#### 37 AUDIO MON SEL (L and R) buttons

These buttons are used to select the audio signals which are to be output to the MONITOR L and R connectors.

Each time the L button is pressed, the signal to be output to the MONITOR L connector is changed in the following sequence: CH1 → CH2 → CH3 → CH4 → CUE.

Similarly, each time the R button is pressed, the signal to be output to the MONITOR R connector is changed in the following sequence: CH1 → CH2 → CH3 → CH4 → CUE.

Which signal has now been selected is displayed by the lighting of the L or R lamps on the level meter display.

When AUTO has been selected as the setup menu No. 721 (MONI CH SEL) setting, the display is switched in tandem with the monitor output. The channel to which monitor output is to be switched automatically can be selected using setup menu No. 735 (MON AUTO SEL).

#### 38 AUDIO MON SEL (MIX) button

This button is used to select the mixed signals which are to be output to the MONITOR L and R connectors.

Each time the AUDIO MON SEL (L) button is pressed while this button is held down, the signals to be output to the MONITOR L connector change in the following sequence: CH1 + CH2 → CH3 + CH4 → CH1 + CH3 → CH2 + CH4 → mixing release.

The mixed signals to be output to the MONITOR R connector are changed in the same way by the AUDIO MON SEL (R) button.

#### 39 Audio level control knobs

These knobs are used to adjust the recording and playback level of the PCM audio signals (CH1, CH2, CH3 and CH4).

Whether the recording level or the playback level is to be adjusted is selected using the AUDIO VOL SEL (REC/PB) switch 40.

#### 40 AUDIO VOL SEL (REC/PB) switch

This switches the function of the audio level control knobs 39 between recording and playback.

##### REC:

Adjustment of recording level

##### PB:

Adjustment of playback level

#### 41 AUDIO VOL SEL (UNITY/VAR) switch

##### UNITY:

At this position, the audio signals are recorded or played back at a fixed level regardless of the positions of the audio level control knobs 39.

##### VAR:

At this position, the audio signals are recorded or played back at the level adjusted by the audio level control knobs 39.

##### <Note>

It is not possible to set it so that both the recording level and playback level can be adjusted.

When REC LEVEL is selected, UNITY (fixed level) is set for the playback level; when PB LEVEL is selected, UNITY is set for the recording level.

#### 42 SET button

When this button is pressed, the data which has been set using the setup menu is entered.

After the data has been entered, the setup menu settings are exited, and the original status is restored.

When the internal time code has been set, the data which has been set is entered.

#### 43 DIAG button

When this button is pressed, the VTR information is displayed.

When it is pressed again, the original display is restored.

The VTR information consists of the "WARNING" information, "HOURS METER" information and "UMID" information.

Switching between the display of each type of information is accomplished by pressing the search button.

Displayed on the "WARNING" screen are details of the warnings.

Displayed on the "HOURS METER" screen are the deck's serial number, power-on time, drum rotation time, tape travel time, number of times a cassette has been loaded, number of times the power has been turned on and off, and so on.

Displayed on the "UMID INFO" screen are details of the UMID (Unique Material Identifier) information.

# Parts and their functions (continued)

## Front panel

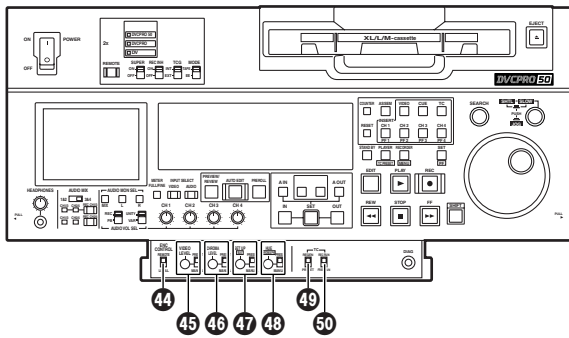

### 44 ENC CONTROL switch

#### REMOTE:

Set to this position to adjust the video output signals using a device which has been connected to the 9-pin REMOTE, RS-232C or PARALLEL connector.

#### LOCAL:

Set to this position to adjust the video output signals using the unit's controls (45, 46, 47, 48).

### 45 VIDEO LEVEL control and switch

These are used to adjust the video output level.

When the ENC CONTROL switch 44 is set to LOCAL and the VIDEO LEVEL switch is set to MANUAL, the video output level can be adjusted using the VIDEO LEVEL control.

The maximum adjustment range is  $\pm 3$  dB.

When the VIDEO LEVEL switch is set to PRESET, the video output level is fixed at 0 dB.

### 46 CHROMA LEVEL control and switch

These are used to adjust the chroma level.

When the ENC CONTROL switch 44 is set to LOCAL and the CHROMA LEVEL switch is set to MANUAL, the chroma level can be adjusted using the CHROMA LEVEL control.

The maximum adjustment range is  $\pm 3$  dB.

When the CHROMA LEVEL switch is set to PRESET, the chroma level is fixed at 0 dB.

### 47 SET UP (BLK) control and switch

These are used to adjust the setup (black) level.

When the ENC CONTROL switch 44 is set to LOCAL and the SET UP switch is set to MANUAL, the setup level can be adjusted using the SET UP control.

The maximum adjustment range is  $\pm 14$  IRE (100 mV).

When the SET UP switch is set to PRESET, the setup (black) level is fixed at 0 IRE (0 mV).

### 48 HUE (CHROMA PH) control and switch

These are used to adjust the hue (chroma phase).

When the ENC CONTROL switch 44 is set to LOCAL and the HUE switch is set to MANUAL, the hue can be adjusted using the HUE control.

The maximum adjustment range is  $\pm 30$  degrees.

When the HUE switch is set to PRESET, the hue (chroma phase) is fixed at 0 degree.

### 49 TC (REGEN/PRESET) switch

#### REGEN:

The internal time code generator is synchronized with the time code which the time code reader has read from the tape.

The signal that is to be used for regeneration is selected using setup menu No. 503 (TCG REGEN).

#### PRESET:

The time code generator can be preset on the operation panel or by remote control.

### 50 TC (REC RUN/FREE RUN) switch

This sets the operation mode which is to make the internal time code generator advance.

#### REC RUN:

The internal time code generator is advanced during recording.

The time code advances all the time when the TC (REGEN/PRESET) switch 49 is at the REGEN position.

#### FREE RUN:

When the power is on, the internal time code generator is advanced regardless of the operation mode.

# Parts and their functions (continued)

## Front panel

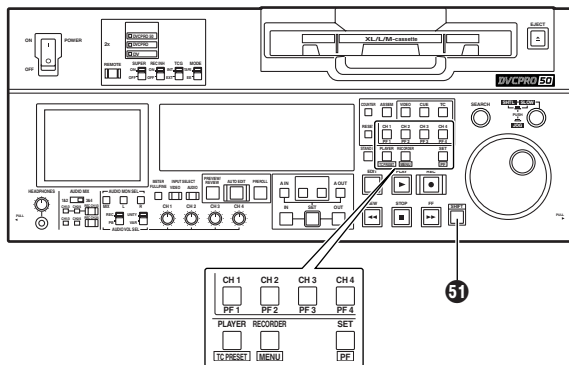

### 51 SHIFT button

When the SHIFT button is pressed together with the buttons shown below, other operations can be performed.

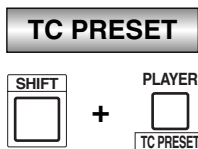

This combination is used to set the time code or user bit value.

Press the PLAYER button while holding down the SHIFT button to stop the advance of the time code or user bit, and change the value using the search dial.

- For further details, refer to the “Time code/user bit” section (page 62).

### MENU

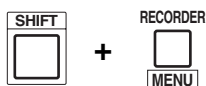

This combination is used to set the unit to the menu mode.

When the RECORDER button is pressed while holding down the SHIFT button, the setup menu screen is displayed on the LCD monitor, and the setup menu item number appears on the counter display. (The setup menu screen is also displayed on the TV monitor which has been connected to the VIDEO OUT 3 connector or SDI OUT 3 connector.)

- For further details, refer to the “Setup (initial settings)” section (page 34).

### PF

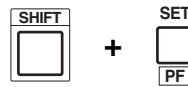

This combination is used to set the unit to the PF (Programmable Function) mode.

When the SET button is pressed while holding down the SHIFT button, the CH1, CH2, CH3 and CH4 INSERT buttons function as the **PF1**, **PF2**, **PF3** and **PF4** buttons.

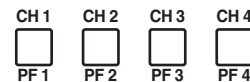

The setup menu items registered in the **PF1**, **PF2**, **PF3** and **PF4** buttons are displayed on the LCD monitor. (The setup menu screen is also displayed on the TV monitor which has been connected to the VIDEO OUT 3 connector or SDI OUT 3 connector.)

- For further details, refer to the “PF (Programmable Function) functions” section (page 33).

# Parts and their functions (continued)

## Display panel

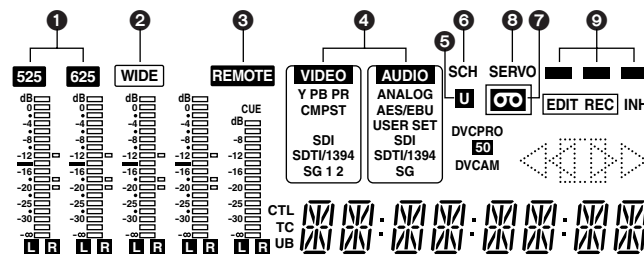

### 1 TV system displays

The selected TV system is displayed here. It is possible to switch between the 525 interlace and 625 interlace systems by setting setup menu item No. 070 (TV SYSTEM).

**525** : This lights when the 525 interlaced TV system has been selected.

**625** : This lights when the 625 interlaced TV system is selected.

### 2 WIDE lamp

This lamp lights when 16:9 wide-screen information is being recorded on a tape. Recording of wide-screen information can be selected on setup menu No. 645 (WIDE SELECT). This lights lamps during tape playback when wide-screen information has been recorded on the tape.

### 3 REMOTE lamp

This lights when the REMOTE button 3 (page 7) has been set to the remote mode.

### 4 INPUT SELECT display area

The characters corresponding to the selected input signals light. With all input signals except for analog audio signals, the fact that no signals have been selected is indicated by a flashing display.

#### VIDEO

- Y PB PR** : Analog component video signals (option)
- CMPST** : Analog composite video signals (option)
- SDI** : Serial digital video signals
- SDTI/1394** : IEEE 1394 compressed digital signals (option)
- SG/SG 1/SG 2** : Internal reference signals

#### AUDIO

- ANALOG** : Analog audio signals
- AES/EBU** : Digital audio signals
- USER SET** : Recording audio signal selection
- SDI** : Serial digital audio signals
- SDTI/1394** : IEEE 1394 compressed digital signals (option)
- SG** : Internal reference signals

### 5 U lamp

This lamp lights when UMID information is present on the input signal in E-E mode. This lamp lights during tape playback when UMID information has been recorded on the tape.

### 6 SCH lamp

This lamp lights when the SCH phase of the external synchronized signal (REF VIDEO) is inside the prescribed range. At all other times, the lamp is off.

### 7 [Cassette] lamp

This lamp lights when a cassette tape is inserted into the VTR. In the standby OFF mode, this lamp is flashing.

### 8 SERVO lamp

This lamp lights when the drum servo or capstan servo locks.

### 9 Channel condition lamps

These lamps light to indicate the error rate status. (green → white → red)

- Green** : This lights when the error rates for the video and audio playback signals are both at acceptable levels.
- White** : This lights when the error rate for the video or audio playback level has increased. The playback picture and sound remain unaffected even while this lamp is lit.
- Red** : This lights when the error rate for the video or audio playback level has increased to the extent that correction or interpolation was performed.



# Parts and their functions (continued)

## Display panel

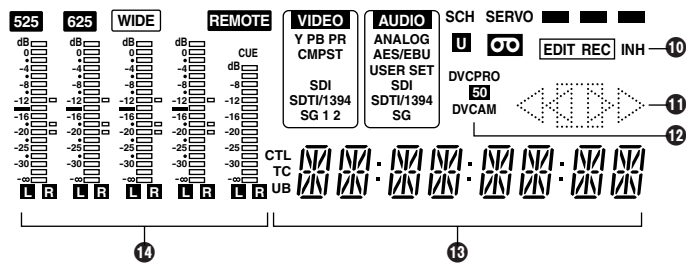

### 10 EDIT, EDIT REC, REC and REC INH lamps

#### EDIT:

This lights when an editing mode has been selected.

#### EDIT REC:

This lights when the edit recording mode has been established.

#### REC:

This lights when the recording mode has been established.

#### REC INH:

This lights in the recording inhibit status (when the REC INH switch at the bottom front panel is set to ON or the cassette is in the accidental erasure prevention status). In this status, recording and editing are not possible.

Whether the REC INH lamp is to light or flash when recording has been inhibited by the accidental erasure prevention tab on the cassette tape can be selected using setup menu No. 114 (REC INH LAMP).

### 11 Tape transport displays

The tape transport status is displayed here.

- ▷ : Normal playback or recording
- ◻▷ : Playback at a speed slower than 1×
- ◻▷▷ : Playback at a speed faster than 1×
- ▷▷ : Fast forwarding (FF)
- ◁ : Playback in the reverse direction at 1×
- ◁◻ : Playback in the reverse direction at a speed slower than 1×
- ◁◻◻ : Playback in the reverse direction at a speed faster than 1×
- ◁◁ : Rewinding (REW)
- ◻◻ : Pause/still

### 12 Format displays

The recording format and the format of the tape inserted in the unit are displayed here.

### 13 Counter display

The tape counter, time code, etc. are displayed here.

The type of value displayed is indicated by CTL, TC or UB.

### 14 Level meters

These meters indicate the levels of the CH1, CH2, CH3, CH4 and CUE tracks of the PCM audio signals.

During recording or while E-E is selected, the levels of the audio input signals appear; during playback, the levels of the audio output signals appear.

Using the METER selector button (13), the audio level display is switched from the FULL mode to the FINE mode or vice versa. (See page 10)

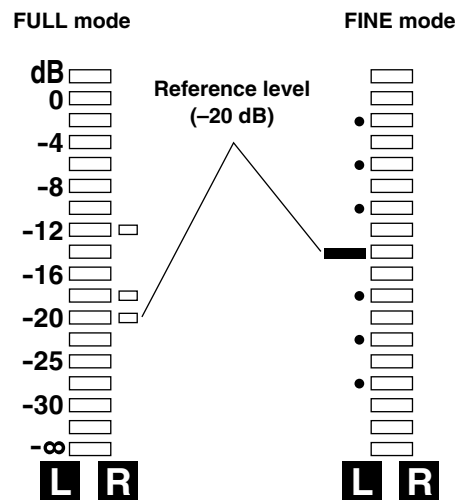

Each of the dots (•) indicates a 1 dB scale increment.

# Parts and their functions (continued)

## Rear panel

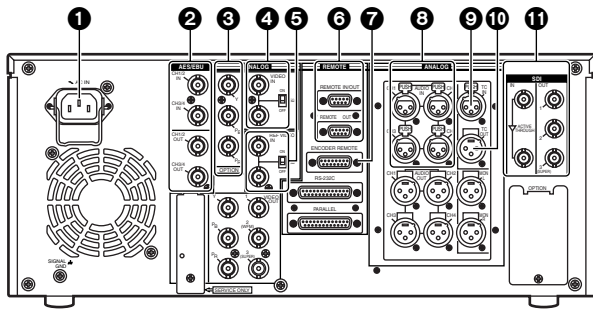

### 1 AC IN socket

Connect one end of the power cord supplied to this socket and the other end to the power outlet.

### 2 DIGITAL AUDIO IN and OUT connectors

These are the input and output connectors for digital audio signals that comply with the AES/EBU standards.

#### <Note>

The digital audio signals which are to be input to these connectors must be synchronized with the video input signals. Otherwise, noise will be generated in the audio output signals.

### 3 ANALOG COMPONENT VIDEO IN connectors (optional)

The analog component video signals are input to these connectors.

### 4 ANALOG COMPOSITE VIDEO IN connectors and 75 $\Omega$ termination switch (optional)

The analog composite video signals are input to these connectors. A loop-through configuration is featured for each pair of input connectors.

For termination at this VTR, set the termination switch to ON.

### 5 REF VIDEO IN connectors and 75 $\Omega$ termination switch

These are the input connectors of the reference video signals.

Input a reference signal with color burst.

For termination at this VTR, set the termination switch to ON.

#### <Note>

Video and audio output may be disturbed when the reference video signal is not input, so it is recommended that a system which inputs the reference video signal be used.

### 6 Remote control connectors

These connectors make it possible to use two of these VTRs or to connect this VTR to an external controller so that the VTR can be operated from an external component.

Two remote control connectors are provided: one for IN/OUT use and the other for OUT use only.

#### IN/OUT:

For connection with an external controller

For connection with deck-to-deck operations

#### OUT:

For connection with parallel run operations

For loop-through use

#### <Note>

If connection is to be made to the OUT connector for deck-to-deck operations where this VTR will serve as the recorder, which of the two connectors is to be used can be selected using setup menu No. 212 (MASTER PORT).

### 7 ENCODER REMOTE connector

An external encoder remote controller is connected to this connector when the video output signal settings are to be adjusted from an external component.

### 8 ANALOG AUDIO IN connectors

These are the analog audio input connectors.

### 9 TIME CODE IN connector

This connector is used to record an external time code onto the tape.

### 10 TIME CODE OUT connector

During playback, the playback time code is output through this connector.

During recording, the time code generated by the internal time code generator is output.

### 11 SERIAL DIGITAL COMPONENT AUDIO and VIDEO IN and OUT connectors

These are the input and output connectors for the digital component audio and video signals that comply with the ITU-R BT.656-4 standard.

Video signals containing superimposed information can be output through the SDI OUT 3 connector. Whether the superimposing is to be set ON or OFF is selected using the SUPER switch 4 on the front panel.

#### <Note>

The digital audio signals which are to be input to these connectors must be synchronized with the video input signals. Otherwise, noise will be generated in the audio output signals.

## Parts and their functions (continued)

### Rear panel

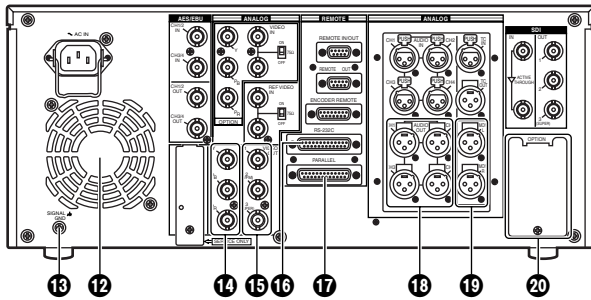

#### 12 Fan

This fan is used to cool down the VTR.  
If, for any reason, the fan stops, "E-10" will appear on the counter display.

#### 13 SIGNAL GND terminal

This is connected to the signal ground terminal on the component connected to this VTR in order to minimize noise. It is not a safety ground.

#### 14 ANALOG COMPONENT VIDEO OUT connectors

The analog component video signals are output through these connectors.

#### 15 ANALOG COMPOSITE VIDEO OUT connectors

The analog composite video signals are output through these connectors.

The waveform monitor (WFM) signal can be output from the VIDEO OUT 2 connector.

It can be selected using setup menu No. 00 (WFM SEL).

Video signals containing superimposed information can be output through the VIDEO OUT 3 connector.

Whether the superimposing is to be set ON or OFF is selected using the SUPER switch 4 on the front panel.

#### 16 RS-232C connector

A personal computer or other component can be connected to this connector to operate the VTR.

#### 17 PARALLEL REMOTE connector

This connector is used when the VTR is to be operated by an external component.

#### 18 ANALOG AUDIO OUT connectors

The analog audio signals are output through these connectors.

#### 19 MONITOR OUT connectors

During playback, the PCM audio signals (CH1/CH2/CH3/CH4) or playback signals from the CUE track are output through these connectors.

#### <Note>

Noise may appear on the CUE signal at the instant recording is started.

#### 20 OPTION connector

Use of an digital video interface board (AJ-YAD955G, optional accessory) enables input/output interfacing of the digital signals with the IEEE1394 standard.

# Connections

## Source machine:

Set the REMOTE button **3** on the front panel to the remote mode (REMOTE lamp ON).

## Recorder:

Set the REMOTE button **3** on the front panel to the local mode (REMOTE lamp OFF).

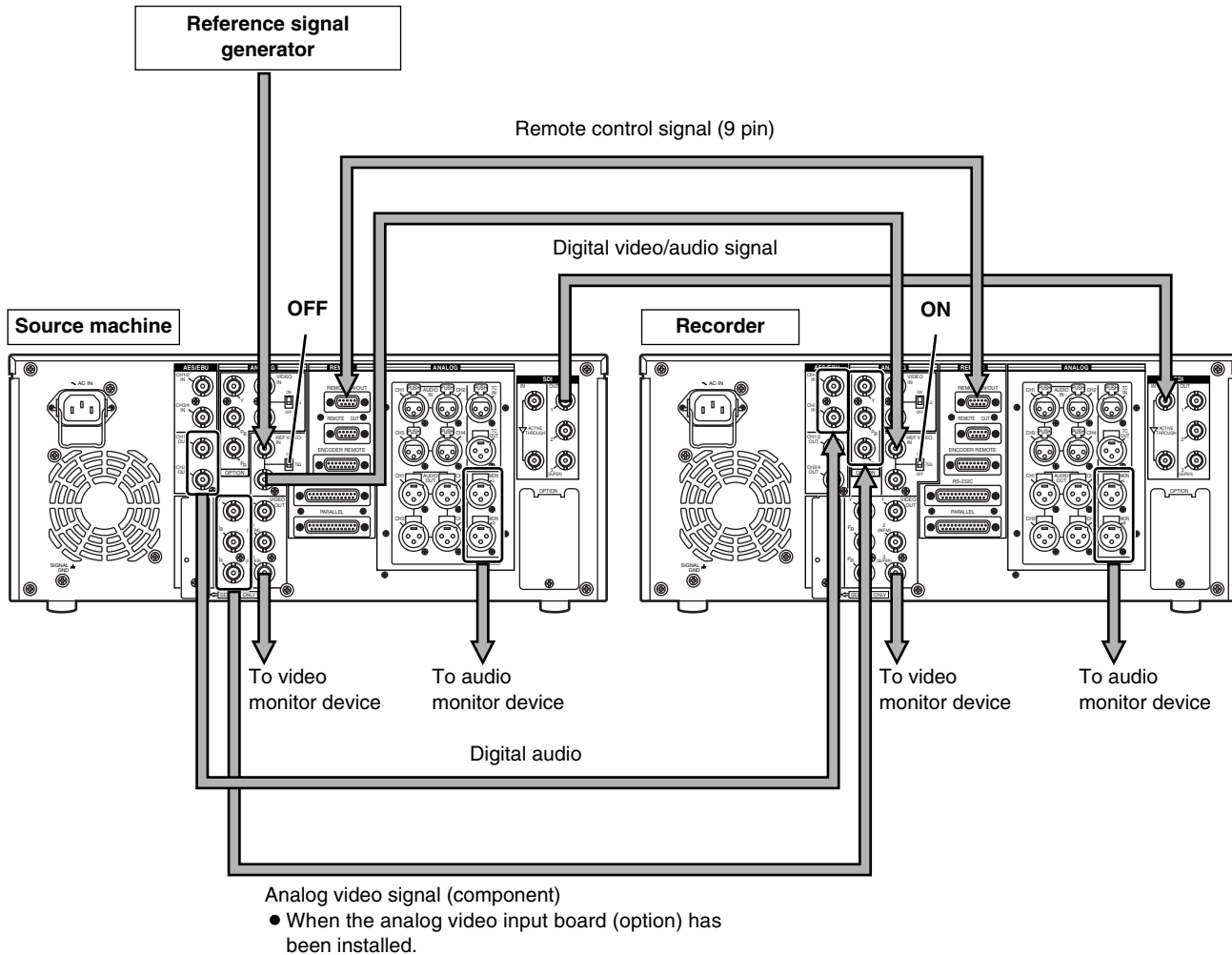

### <Note>

Video and audio output may be disturbed when the reference video signal is not input, so it is recommended that a system which inputs the reference video signal be used.

# Connections (continued)

## Connections with editing controller

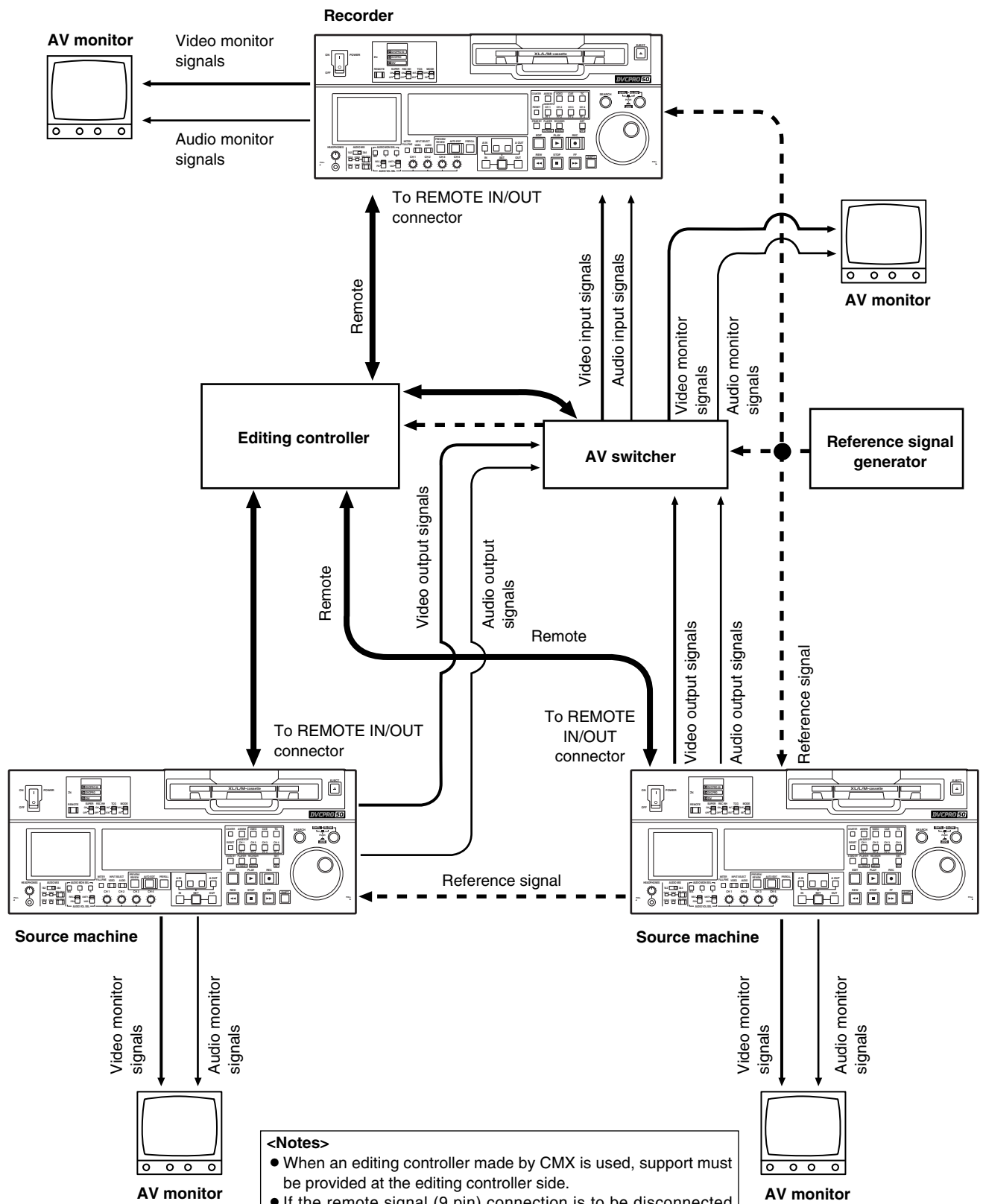

- <Notes>**
- When an editing controller made by CMX is used, support must be provided at the editing controller side.
  - If the remote signal (9 pin) connection is to be disconnected from one component and connected to another instead, recheck the editing controller settings, etc.
  - Video and audio output may be disturbed when the reference video signal is not input, so it is recommended that a system which inputs the reference video signal be used.

# Tapes

## Consumer-use DV and DVCAM cassettes (Standard DV and DVCAM cassettes, mini DV and DVCAM cassettes)

- Use a cassette adapter (AJ-CS455P) when a mini DV or DVCAM cassette is to be used.  
Note that inserting a mini DV or DVCAM cassette without the use of a cassette adapter will cause malfunctioning.  
Also note that long-duration mini DV cassettes (80 minutes in the standard mode and 120 minutes in the LP mode) cannot be used.
- It is not possible to play back tapes which have been recorded in the LP mode.
- When editing material recorded on a consumer-use DV or DVCAM cassette, first record the material on a DVCPRO tape or other tape used by VTRs for broadcast applications.
- The maximum transport speed of a mini DV or DVCAM cassette tape is 32×.
- The images may be subject to disturbance during the slow motion playback of consumer-use DV and DVCAM cassette tapes.
- From the perspective of protecting consumer-use DV and DVCAM cassette tapes, minimize the number of times the tapes are cued up at the same locations as much as possible.
- When consumer-use DV and DVCAM cassette tapes are used, the maximum time for STILL TIMER is set to 10 seconds.

It is recommended that tapes bearing the Panasonic brand be used as the consumer-use DV tapes.

### M cassettes

Tapes enabling recording and playback for up to 33 minutes at the 50 Mbps rate and for up to 66 minutes at the 25 Mbps rate.  
(AJ-P66MP)

### L cassettes

Tapes enabling recording and playback for up to 92 minutes at the 50 Mbps rate and for up to 184 minutes at the 25 Mbps rate.  
(AJ-P126LP, AJ-5P92LP)

- Use AJ-5P92LP tapes which have been recorded using the DVCPRO (25M) format in a VTR that supports 184 minutes of DVCPRO (25M) format recording and playback.

### XL cassettes

Tapes enabling recording and playback for up to 126 minutes at the 50 Mbps rate and for up to 252 minutes at the 25 Mbps rate.  
(AJ-5P126XG)

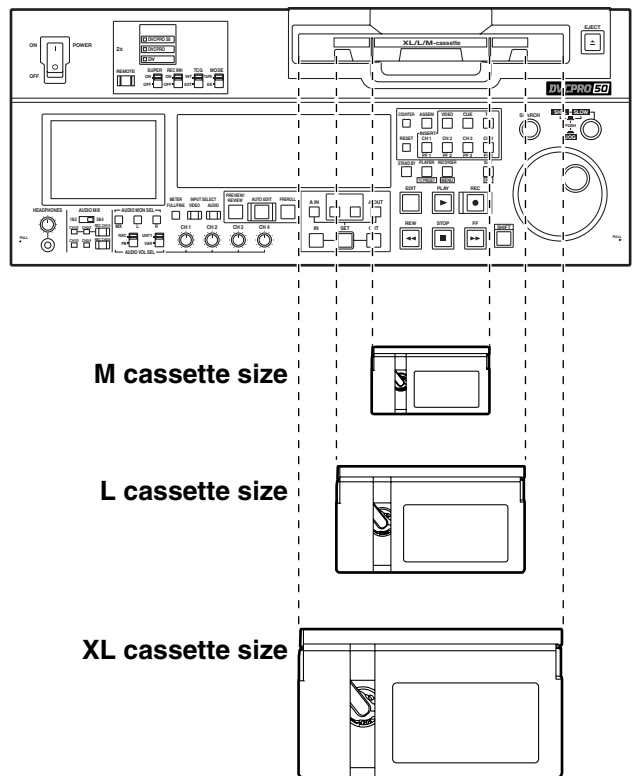

Align the center of the cassette with the center of the insertion slot, and press it in gently.  
The cassette tape will load automatically.

# Jog/Shuttle

---

## Jog mode

- 1** Press the search dial so that it remains pressed in. Check that the JOG lamp has lit.
- 2** Turn the search dial.  
The dial's click-stops are released, and the tape is played back at the speed ( $-1\times$  to  $+1\times$ ) corresponding to the speed at which the dial is turned.  
The maximum speed can be switched using setup menu No. 323 (JOG FWD MAX) and No. 324 (JOG REV MAX) settings.  
However, noise will occur at all speeds other than  $-0.43\times$  to  $+0.43\times$ .  
When the dial is no longer turned, the still picture mode is established.
- 3** To transfer the VTR from the jog mode to another mode, press the button that corresponds to the mode concerned.

### <Note>

The direct search mode in which the VTR is transferred to the shuttle mode or jog mode by turning the search dial is set at the factory.  
By selecting KEY as the setup menu No. 100 (SEARCH ENA) setting, the VTR can be set to the mode in which it will not be transferred to the search mode unless the search button is pressed.

## Shuttle mode

- 1** Press the search dial so that it is released from the pressed-in position.  
The SHTL lamp lights, and the shuttle mode is established.
  - Immediately after the power is turned on, turn the search dial and leave it at the center position.
- 2** Press the SHTL/SLOW button and switch to SHTL or SLOW.
- 3** Turn the search dial.
  - When the SHTL lamp among the JOG, SHTL and SLOW lamps is lit, the playback picture speed changes from 0 up to  $\pm 32\times$  depending on the dial position.  
This speed can be switched to  $\pm 8.4\times$ ,  $\pm 16\times$  or  $\pm 32\times$  using setup menu No. 101 (SHTL MAX).  
The dial has a click-stop at the center position where the still picture mode is established.
  - When the SLOW lamp among the JOG, SHTL and SLOW lamps is lit, the playback picture speed changes from  $-4.1$  up to  $+4.1\times$  depending on the dial position.  
The maximum speed can be switched using setup menu No. 320 (VAR FWD MAX) and No. 321 (VAR REV MAX) settings. However, noise will occur at all speeds other than  $-0.43\times$  to  $+0.43\times$ ,  $+0.5\times$  and  $+0.75\times$ .  
The dial has a click-stop at the center position where the still picture mode is established.
- 4** To transfer the VTR from the shuttle mode to another mode, press the STOP button or other button.

### <Notes>

- It is possible to listen to playback audio in the  $-10$  to  $+10$  speed range from the audio monitor output. (PCM must be selected for the setup menu No. 721 (MONI CH SELECT) setting.)
- The audio playback sound heard in the search mode contains noise.

# Manual editing

---

**1** Select the editing mode.

**ASSEMBLE:**

Assemble (frame-to-frame continuity) editing is performed in this mode.

**INSERT:**

Insert editing is performed in this mode.

**2** Select the channels to be edited.

For insert editing, press the buttons corresponding to the channels to be edited so that their lamps light.

**3** Press the PLAY button.

**4** While monitoring the TV monitor, search the position (IN point) where the editing is to be started, and press the PLAY and EDIT buttons together at this position.

**5** Similarly, while monitoring the TV monitor, search the position (OUT point) where the editing is to be terminated, and press the PLAY or STOP button at this position. The unit will change to STOP or PLAY mode and editing will stop.

## Preroll

---

**1** Press the PREROLL button.

The VTR now performs the preroll operation.

- If the edit IN point has been registered, the tape is rewound from the edit IN point for the period of time which was set by setup menu No. 000 (P-ROLL TIME), and it then stops.
- If the edit IN point has not been registered, the tape is rewound from the position where the button was pressed for the period of time which was set by setup menu item No.000 (P-ROLL TIME), and it then stops.

**<Notes>**

- The time code or CTL must be continuously recorded on the tape between the edit IN point and preroll point.
- When the IN point has not been registered, it is possible to select whether to register the IN point and proceed with the preroll or proceed with the preroll without registering the IN point using setup menu No. 313 (AUTO ENTRY).



# Automatic editing (deck-to-deck)

## Switch settings and adjustments

### When using the AJ-SD965 as the recorder

- 1 Set the POWER switch to ON.
- 2 Use the INPUT SELECT buttons to select the video and audio input signals.
- 3 Switch the time counter display to TC, CTL or UB.
- 4 Set the AUDIO VOL SEL (REC/PB) switch to the REC position.
- 5 If the recording levels are to be adjusted using the level controls, set the AUDIO VOL SEL (UNITY/VAR) switch to the VAR position. If the recording levels are to be fixed, set the switch to the UNITY position.
- 6 Set the REMOTE button to the local mode (REMOTE lamp OFF).

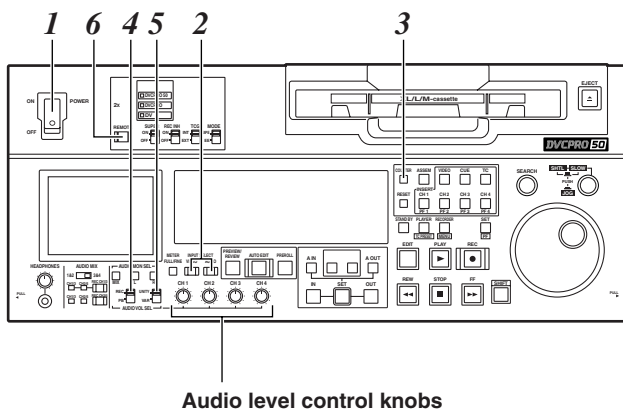

### When using the AJ-SD965 as the player

- 1 Set the POWER switch to ON.
- 2 Set the AUDIO VOL SEL (REC/PB) switch to the PB position.
- 3 If the playback levels are to be adjusted using the level controls, set the AUDIO VOL SEL (UNITY/VAR) switch to the VAR position. If the playback levels are to be fixed, set the switch to the UNITY position.
- 4 Set the REMOTE button to the remote mode (REMOTE lamp ON).

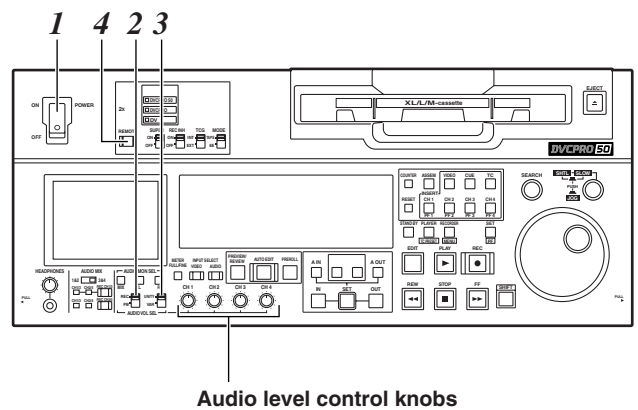

# Automatic editing (deck-to-deck) (continued)

## Selecting the editing mode

- 1 Select the editing mode.  
For assemble editing, press the ASSEM button.  
For insert editing, press the INSERT button.  
**ASSEM:**  
This sets the unit to assemble (frame-to-frame continuity) editing mode.  
**INSERT:**  
This sets the unit to insert editing mode.
- 2 Select the channels to be edited.  
With assemble editing, the ASSEM lamp lights.  
With insert editing, press the buttons corresponding to the channels to be edited so that their lamps light.
- 3 Select the VTR to be operated.  
(Settings for editing using two VTRs)  
Press the PLAYER or RECORDER button to select the VTR which is to be operated.  
**PLAYER:**  
Press this button if the player VTR is to be operated to register the edit points.  
**RECORDER:**  
Press this button if the recorder VTR (this unit) is to be operated to register the edit points.

## Registering the edit points

- 1 Locate the edit IN point by performing the jog or shuttle operation.  
Set the tape to the still picture mode at the desired position.  
For a detailed description of the jog and shuttle operations, refer to page 23.
- 2 Press the SET button while holding down the IN button.  
The edit IN point is now registered.  
The edit IN point value appears on the display panel.
- 3 Locate the edit OUT point by performing the jog or shuttle operation.  
Set the tape to the still picture mode at the desired position.
- 4 Press the SET button while holding down the OUT button.  
The edit OUT point is now registered.  
The edit OUT point value appears on the display panel.

**Match frame processing function**  
When two VTRs are used to perform the editing operations, there will be a total of 4 edit points: the IN and OUT points for the player and those for the recorder. However, the last point is automatically calculated so only three of the edit points need to be registered.

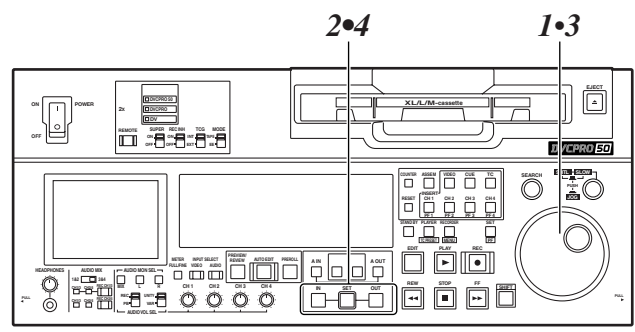
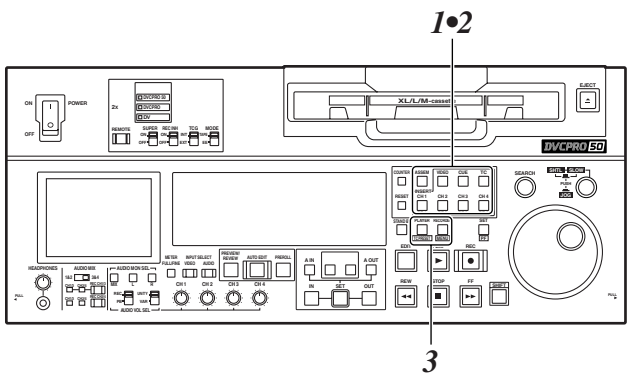

## Automatic editing (deck-to-deck) (continued)

### Checking and previewing edit points

**1** Press the IN (or OUT) button to check the edit point. The value of the registered edit point appears on the display panel.

**2** While holding down the IN (or OUT) button, press the PREROLL button and check the picture at the edit point.

The tape is cued up to the edit IN (or OUT) point, and a still picture of the point appears.

- If STOP has been selected as the setup menu No. 315 (AFTER CUE-UP) setting and if the MODE switch has been set to EE, the VTR is set to the E-E mode.

**3** By holding down the IN and OUT buttons at the same time, check the editing duration. The duration appears on the display panel.

#### How to calculate the duration

- When two edit points have been set:  
Duration between the two points
- When only one edit point has been set:  
Duration between the data which has been set and the current address
- When no edit points have been set:  
Duration of the previously edited section

**4** After the edit points have been registered, press the PREVIEW button.

Regular preview is now conducted.

#### <Notes>

- If the edit IN point has not been registered, the position where the PREVIEW button was pressed is registered as the edit IN point.
- To stop the preview at any time, press the STOP button.
- When the PREVIEW button is pressed again after the IN point during the course of a preview, the preview will start again from the beginning.
- When the edit OUT point is reached, the tape stops automatically.

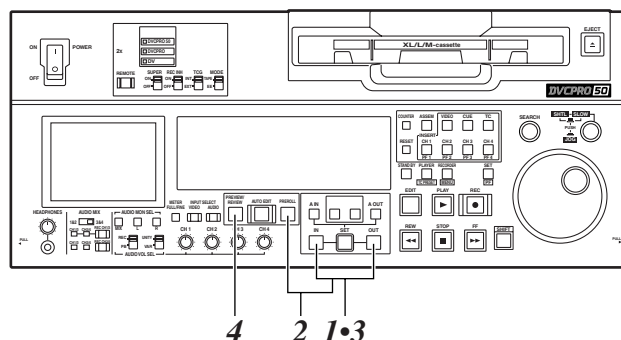

# Automatic editing (deck-to-deck) (continued)

## Modifying edit points

### 1 Re-registering an edit point

Locate the new edit point by performing the jog or shuttle operation, and press the IN (or OUT) button and SET button at the same time to re-register the edit point.

### 2 Modifying an edit point in 1-frame increments (trimming function)

Press the TRIM button while holding down the IN (or OUT) button. Each time the + button is pressed, the point is moved ahead by one frame.

Conversely, each time the – button is pressed, the point is moved back by one frame.

### 3 Resetting edit points

#### ● Resetting both an edit IN point and OUT point

Press the RESET button.

(This takes effect only in the CTL mode.)

#### ● Resetting either an edit IN point or OUT point

Press the RESET button while holding down the IN (or OUT) button.

#### <Notes>

- An edit OUT point can be reset even while editing is in progress.
- In the eject mode, the IN and OUT points are automatically reset.

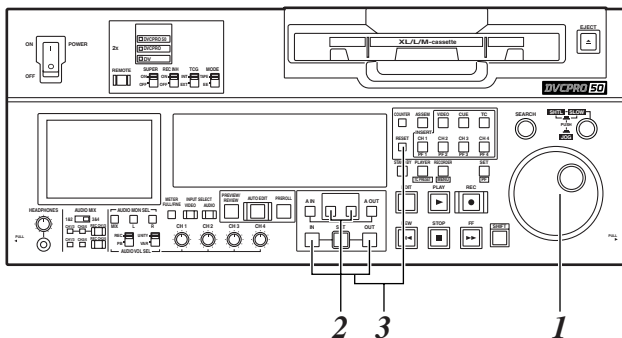

## Automatic editing (deck-to-deck) (continued)

### Executing and reviewing automatic editing

- 1 Press the AUTO EDIT button.  
Automatic editing is now executed.
  - To suspend editing at any time, press the STOP button.
  - When the edit OUT point is reached, the tape is post-rolled, after which it stops.

#### Post-rolling

With assemble editing, editing continues for about 2 seconds after the edit OUT point is passed, the tape is then returned to the OUT point, after which it stops.

With insert editing, the PLAY mode is established after the edit OUT point has been passed, the tape is then returned to the OUT point, after which it stops.

The post-roll time can be set using setup menu No. 325 (POSTROLL TM).

#### Retry function

Even when the STOP button has been pressed to suspend editing, editing can be repeated from the beginning simply by pressing the AUTO EDIT button again.

#### Auto tag function (recorder side)

If, upon completion of editing, the next edit point has not yet been registered, the previous edit OUT point is registered as the IN point and editing is executed when the AUTO EDIT button is pressed.

To release the auto tag mode, press one of the transport system buttons (such as the PLAY button).

#### Registering an OUT point while editing is in progress

If the SET button is pressed while the OUT button is being held down when automatic editing is in progress, the position corresponding to when the button was pressed is registered as the OUT point and the editing operation is exited.

Even if the AUTO EDIT button is pressed, the OUT point is registered and editing is exited in the same way.

#### <Note>

The registered points are automatically cleared after editing has been executed. However, the previous edit points can be recalled by pressing the TRIM+ (or TRIM-) button and SET button at the same time.

- 2 Upon completion of the editing, press the REVIEW button.  
Review is then started by the recorder side.
  - To stop the review at any time, press the STOP button.
  - When the edit OUT point is reached, the tape is post-rolled, after which it stops.

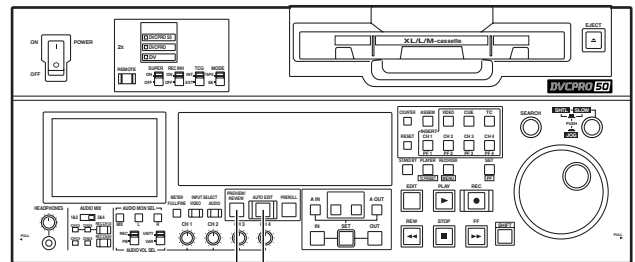

2 1

# Audio split editing

The video edit points and audio edit points can be registered independently, and editing can be executed with the video point offset from the audio points.

Audio edit points cannot be registered when the assemble editing mode has been selected.

After registering the edit points, proceed with the same operations as for insert editing.

## ■ Registering the edit points

### Video IN point:

Press the SET button while holding down the IN button.

### Video OUT point:

Press the SET button while holding down the OUT button.

### Audio IN point:

Press the SET button while holding down the A IN button.

### Audio OUT point:

Press the SET button while holding down the A OUT button.

## ■ Clearing the edit points

### Video IN point:

Press the RESET button while holding down the IN button.

### Video OUT point:

Press the RESET button while holding down the OUT button.

### Audio IN point:

Press the RESET button while holding down the A IN button.

### Audio OUT point:

Press the RESET button while holding down the A OUT button.

## ■ Modifying edit points

### Video IN point:

Press the TRIM+ button or TRIM- button while holding down the IN button.

### Video OUT point:

Press the TRIM+ button or TRIM- button while holding down the OUT button.

### Audio IN point:

Press the TRIM+ button or TRIM- button while holding down the A IN button.

### Audio OUT point:

Press the TRIM+ button or TRIM- button while holding down the A OUT button.

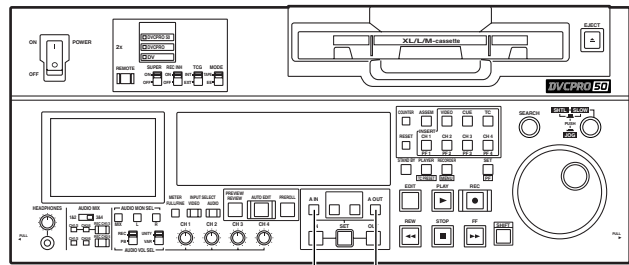

A IN button    A OUT button

## ■ Displaying the audio split edit points

The edit points appear on the display panel.

### Video IN point:

Press the IN button.

### Video OUT point:

Press the OUT button.

### Audio IN point:

Press the A IN button.

### Audio OUT point:

Press the A OUT button.

### <Note>

If the editing mode is changed to assemble editing after the audio edit points have been registered, the audio edit points will be cleared.

## ■ Cueing the tape up to the edit points

### Cue-up to video IN point:

Press the PREROLL button while holding down the IN button.

### Cue-up to video OUT point:

Press the PREROLL button while holding down the OUT button.

### Cue-up to audio IN point:

Press the PREROLL button while holding down the A IN button.

### Cue-up to audio OUT point:

Press the PREROLL button while holding down the A OUT button.

## Audio split editing (continued)

---

### ■ Duration display

The duration can be indicated on the display panel only.

#### **Between the video IN and OUT points:**

Press the IN button and OUT button at the same time.

#### **Between the audio IN and OUT points:**

Press the A IN button and A OUT button at the same time.

### **Match frame processing system**

When two VTRs are used to perform the audio split editing operations, there will be a total of 8 edit points: the video IN and OUT points for the player, the video IN and OUT points for the recorder, the audio IN and OUT points for the player, and the audio IN and OUT points for the recorder.

When five of the eight edit points are registered, the remaining three points are automatically calculated so only five of the edit points need to be registered.

### ■ When a VTR not equipped with the split editing function is used as the player

When a VTR that cannot set the video and audio edit points independently is used as the player, split editing is still possible by setting the audio IN point and OUT point in the recorder and setting the data of three points as the video edit points.

#### **<Note>**

If, during audio split editing, the video OUT point (or audio OUT point) only is registered without the audio OUT (or video OUT point) having been registered and automatic editing is then executed, either the audio OUT point (or video OUT point) will be registered or editing will continue until the STOP button is pressed to suspend the editing operation.

# Variable memory editing

Using the unit as a controller (deck-to-deck editing mode recorder) to control the playback speed of the VTR used as the player, editing can be performed in speed variable mode.

## ■ Selecting the variable memory mode

When deck-to-deck editing (either the RECORDER or PLAYER lamp lights) is to be performed, set the initial speed (-1.0 to +2.0) by turning the search dial while pressing the SET button held down to transfer the unit to variable memory mode.

## ■ Releasing variable memory mode

Press the RESET button while holding down the SET button to release the unit from variable memory mode.

The unit will also be released from this mode when deck-to-deck editing operations are completed.

## Variable memory editing operation procedure

Variable memory editing operation can be performed according to the following procedure.

- 1** Select the edit mode by pressing ASSEM button or desired INSERT buttons.
- 2** Select VTR to be operated by pressing RECORDER or PLAYER button.
- 3** Register IN/OUT point by using SET button and IN/OUT buttons.  
The OUT point of VTR used as the player cannot be registered.

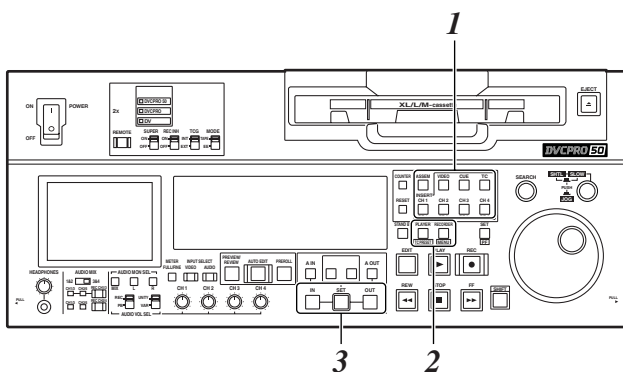

- 4** After selecting VTR used as the player by pressing PLAYER button, set the initial speed by the search dial while pressing SET button.
- 5** Simultaneously pressing both SET button and PREVIEW/REVIEW button results in automatic prerolling for the both VTRs (player and recorder), then the player VTR is operated at the set initial speed up to the IN point.
- 6** After passing the IN point, turn the search dial to memorize the playback speed of the VTR used as the player.
- 7** When the tape has passed the OUT point set by recorder, the memory of the playback speed will terminate.
- 8** When AUTO EDIT button is pressed, variable memory editing is executed.  
Once editing has been executed, the memorized speed will be cleared. The initial speed will not be cleared however.
- 9** The result of editing can be checked by pressing PREVIEW/REVIEW button.

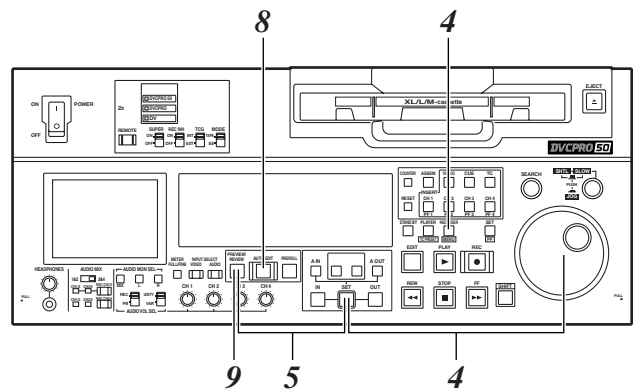

### <Notes>

- The content stored in the memory will be cleared in a mode other than the variable memory mode. Also, the memory will be cleared when the power switch is turned OFF.
- Phase adjustment is not made during playback to the IN point of variable memory editing. Therefore, depending on the VTR used as the player and its speed setting, no guarantees are made for the accuracy of the IN point.
- When variable memory editing is to be performed, keep the speed set to within the speed range for variable speed playback which can be guaranteed by the VTR used as the player.



# PF (Programmable Function) functions

Four most frequently used setup items can be registered in the four PF buttons.

## Registering setup items in the PF buttons

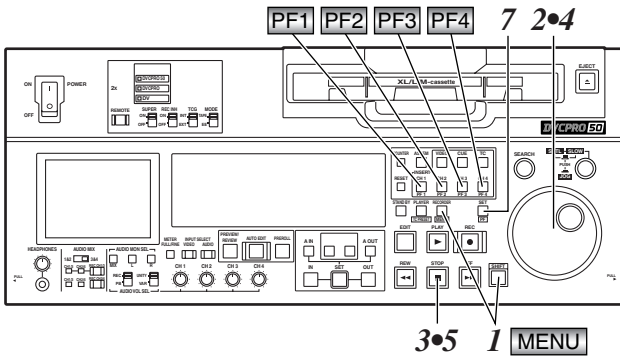

- 1 Press **MENU** (SHIFT + RECORDER).  
The setup menu screen appears on the LCD monitor, and the setup menu item number appears on the counter display.
  - The setup menu screen is also displayed on the TV monitor which has been connected to the VIDEO OUT 3 connector or SDI OUT 3 connector.

- 2 Turn the search dial to move the cursor (\*) on the menu screen to the item (No.A04, A05, A06 or A07) corresponding to the PF button to be specified.

```

SETUP-MENU  MENU
<USER1>    NO.A04-
 901 BL BRIGHT  OFF
 A00 LOAD        USER2
 A01 SAVE        USER2
 A02 P.ON LOAD  OFF
 *A04 PF1 ASSIGN ---
 A05 PF2 ASSIGN ---
 A06 PF3 ASSIGN ---
 A07 PF4 ASSIGN ---
 END
    
```

Aligned the cursor with the No.A04 item, and set the first menu item to be registered in **PF1**.  
In the same way, align the cursor with No.A05, A06 and A07, and three other menu items can be registered in **PF2**, **PF3** and **PF4**, respectively.

- 3 When the STOP button is pressed, the menu items which can be registered in the specified PF button are displayed.

```

SETUP-MENU  MENU
<USER1>    NO.A04-
 A04 PF1 ASSIGN  ---

*--- NO ASSIGN
001 LOCAL ENA
002 TAPE TIMER
003 REMAIN SEL
008 DISPLAY SEL
009 CHARA H-POS
010 CHARA V-POS
    
```

- 4 Turn the search dial to move the cursor (\*) to the item to be registered.

- 5 Press the STOP button.  
The display screen returns to the status in step 2, and the registered item is displayed at the position of the specified PF button.

- 6 To register the next item in the next PF button, repeat steps 2 to 5.

- 7 After the item(s) has (have) been registered, press the SET button.  
The registered item(s) is (are) stored in the memory, and the regular screen is restored.

## Operations using the PF buttons

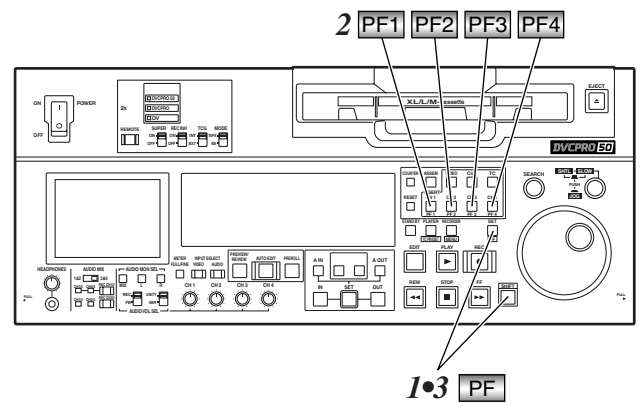

- 1 Press **PF** (SHIFT + SET).  
The menu items registered in the PF buttons are displayed on the LCD monitor.

```

PF1 SYS FORMAT  50M
PF2 INT SG      CB75
PF3 -----
PF4 -----
    
```

- 2 Press the PF button (**PF1**, **PF2**, **PF3** or **PF4**) that corresponds to the item whose setting is to be changed.  
Each time the PF button is pressed, the setting is updated in sequence.

- 3 When the SET button is pressed, the regular screen is restored.

- If no operations are performed for a period of five seconds while the menu items remain displayed, the regular screen is restored.

# Setup (initial settings)

This VTR's main settings are performed while making selections using a system of menus.

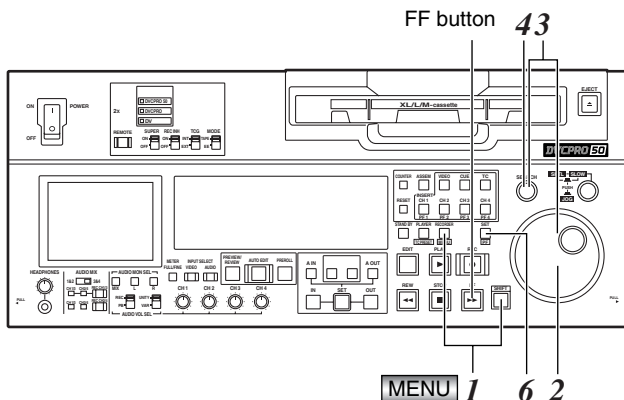

## Changing the settings

- 1 Press the **MENU** (SHIFT+RECORDER).  
The setup menu screen appears on the LCD monitor, and the setup menu item number appears on the counter display.  
Each time the FF button is pressed (for about 1.5 seconds), the item number and item name are selected and displayed alternately.  
(If a setup was performed previously, the screen on which the last change was made is displayed.)
  - The setup menu screen is also displayed on the TV monitor which has been connected to the VIDEO OUT 3 connector or SDI OUT 3 connector.

- 2 Turn the search dial to select the item to be set.  
The menu screen cursor (\*) moves, and the item number on the display flashes.
  - When the dial is turned clockwise, the item number is incremented from 001 → 002 → 003 → 004 and so on; conversely, when it is turned counterclockwise, the item number is decremented.
  - When the FF button or REW button is pressed while holding down the PLAY button, the next or previous item is selected.
  - Whenever possible, limit the use of the search dial to the JOG mode.

- 3 At the position where the change is to be made, turn the search dial while holding down the search button.  
The settings on the menu screen and display now flash.  
When the dial is turned clockwise, the setting number is incremented; conversely, when it is turned counterclockwise, it is decremented.
  - At this time, when the RESET button is pressed while holding down the search button, the setting value is returned to the factory setting.

- 4 Upon completion of the setting, release the search button.  
The item number now flashes.
  - When the search dial is in the SHTL mode, the item will move unless the dial is set to the center position.

- 5 When other items are to be changed, repeat steps 2 to 4.

- 6 Press the SET button.  
The changes are stored in the memory.  
**To disregard the new settings and restore the old settings instead, press the RECORDER button.**
  - To return the setup contents to the factory settings (initial settings), press the RESET button while the menu is displayed. The following message is displayed.

```
SETUP-MENU INIT SET  
YES<PLAY>/NO<STOP>
```

If the PLAY button is now pressed, the factory settings are reinstated.

### <Notes>

- If the RESET button is pressed to restore the factory settings, only the user files currently in use are restored. The other user files remain unaffected.
- The changes made to the SYSTEM menu contents are recorded also by pressing the RECORDER button to close the menu screen.

# Setup menus

This VTR can hold five user files, each of which has its own specific menu settings, and one of these files can be selected for use.

## Changing the file

- 1 Press the **MENU** (SHIFT+RECORDER).
- 2 When the FF button is pressed while holding down the SHIFT button, the next user file is selected; conversely, when the REW button is pressed while holding down the SHIFT button, the previous user file is selected.

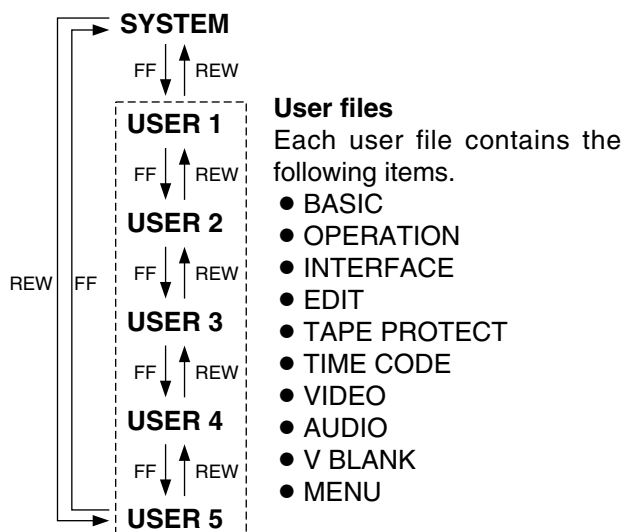

- 3 To enter the selection made in step 2 for the user file which is to be used, press the SET button.  
The user file is changed and stored in the memory.

### <Note>

Since the SYSTEM menu items are not included in user files 1 through 5, first select the user file and switch to the SYSTEM file, and then set the SYSTEM menu items.

## Setting and releasing the lock mode

The lock mode can be set to protect the system file and user file (USER2 to USER5) settings. Once the lock mode is set, no further changes can be made to the settings.

Setting and releasing the lock mode can be set for the system file by using setup menu No. 30 (MENU LOCK) and for the user files by using setup menu No. A03 (MENU LOCK).

- 1 Press the **MENU** (SHIFT+RECORDER).
- 2 Press the REW button or FF button while holding down the SHIFT button to select the file for which the lock mode is to be set or released.
- 3 Turn the search dial to move the cursor (\*) on the menu screen to No. 30 (MENU LOCK) for the system file or to No. A03 (MENU LOCK) for a user file.
- 4 Turn the search dial while holding down the search button to select whether the lock mode is to be set or released.

### To set the lock mode:

Set 0001 (ON) as the setting.

### To release the lock mode:

Set 0000 (OFF) as the setting.

When the lock mode has been set, "LOCKED" flashes on the menu screen. The counter display stops flashing and remains lit.

SETUP-MENU	LOCKED
<USER2>	NO.000-0005
*000 P-ROLL TIME	5s
001 LOCAL ENA	ST&EJ
002 TAPE TIMER	±12h
003 REMAIN SEL	OFF
004 SETUP NUMBER	OFF
005 METER SELECT	CUE
006 SYNCHRONIZE	ON
007 SUPER	ON
008 DISPLAY SEL	T&STA

- 5 Press the SET button.  
The setting is stored in the memory.

### <Notes>

- The lock mode cannot be set for the USER1 file.
- Once set to the lock mode, a file cannot be reset to the factory settings even by pressing the RESET button.

## Setup menus (continued)

### Loading user files

The contents of the USER2, USER3, USER4 or USER5 file can be copied (loaded) into the USER1 file. Also, the contents of the USER1 file can be copied (saved) into the USER2, USER3, USER4 or USER5 file.

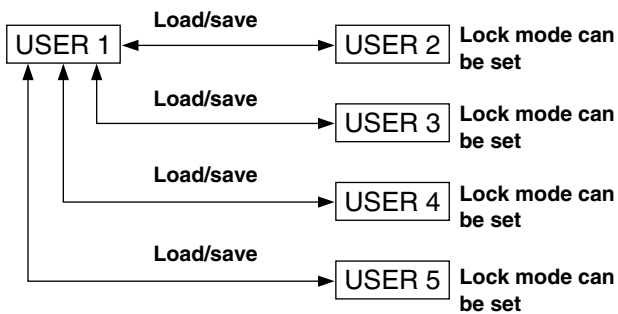

**1** Press the **MENU** (SHIFT+RECORDER).

**2** Press the REW button or FF button while holding down the SHIFT button to select the USER1 file.

**3** Turn the search dial to move the cursor (\*) on the menu screen to No. A00 (LOAD).

```

    SETUP-MENU   MENU
    <USER1>      NO. A00-0000
    804 BLANK LINE BLANK
    *A00 LOAD     USER2
    A01 SAVE     USER2
    A02 P.ON LOAD OFF
    END
  
```

**4** Turn the search dial while holding down the search button to select the user file whose contents are to be loaded into USER1.

**5** Press the SET button.  
The following message appears on the menu screen and counter display.

Menu screen

```

    SETUP-MENU   LOAD
    USER2 → USER1 OK?
    YES<PLAY>/NO<STOP>
  
```

Counter display

```

    L  U2  )  U1
  
```

The number of the user file selected in step **4** is displayed at ■.

**6** Press the PLAY button.  
The settings of the user file selected in step **4** are loaded, and the USER1 menu display appears. If the STOP button is pressed instead, the settings are not changed, and the USER1 menu display appears.

**7** Turn the search dial to move the cursor (\*) on the menu screen to a number other than No. A00 (LOAD) or No. A01 (SAVE).

**8** Press the SET button. The USER1 settings are stored in the memory.  
If the USER1 settings are not to be stored in the memory, do not press the SET button but press the MENU button instead.

## Setup menus (continued)

### Saving user files

- 1 Press the **MENU** (SHIFT+RECORDER).
- 2 Press the REW button or FF button while holding down the SHIFT button to select the USER1 file.
- 3 Turn the search dial to move the cursor (\*) on the menu screen to No. A01 (SAVE).

```
SETUP-MENU      MENU  
<USER1>        NO.A00-0000  
804 BLANK LINE BLANK  
A00 LOAD      USER2  
*A01 SAVE     USER2  
A02 P.ON LOAD OFF  
END
```

- 4 Turn the search dial while holding down the search button to select the user file in which the contents of USER1 are to be saved. Those user files which have been set to the lock mode do not appear on the display. If all the user files have been set to the lock mode, the "LOCKED" display appears, and the contents of USER1 cannot be saved into any of the user files.
- 5 Press the SET button.  
The following message appears on the menu screen and counter display.

#### Menu screen

```
SETUP-MENU      SAVE  
USER1 → USER2 OK?  
YES<PLAY>/NO<STOP>
```

#### Counter display

```
5 01 1 02
```

The number of the user file selected in step 4 is displayed at ■.

- 6 Press the PLAY button.  
The settings of USER1 are saved in the user file selected in step 4 and stored in the memory. If the STOP button is pressed instead, the settings are not changed, and the USER1 menu display appears.
- 7 Turn the search dial to move the cursor (\*) on the menu screen to a number other than No. A00 (LOAD) or No. A01 (SAVE).
- 8 Press the SET button. The USER1 settings are stored in the memory.  
If the USER1 settings are not to be stored in the memory, do not press the SET button but press the MENU button instead.

### Automatically recalling a user file when turning on the power

If the user file to be loaded is selected in advance using setup menu No. A02 (P.ON LOAD), the file will be automatically loaded into USER1 when the power is turned on.

# Setup menus (continued)

## SYSTEM menu

No./Item	Description																		
00 WFM SEL	<p>This selects the signal to output from the VIDEO OUT 2 connector.</p> <p>0000 CTL: The CTL signal is output. 0001 TC: The TIME CODE signal is output. 0002 VIDEO: The VIDEO OUT signal is output. 0003 RF_L: The PB L RF signal is output. 0004 RF_R: The PB R RF signal is output. 0005 ENV_L: The PB L ENV signal is output. 0006 ENV_R: The PB R ENV signal is output.</p> <p>&lt;Notes&gt;</p> <ul style="list-style-type: none"> <li>The settings can be changed at any time regardless of the setup menu item No. 40 (MENU LOCK) setting.</li> <li>During normal playback, the output signals have levels which are virtually identical to the values given below under a 75Ω termination. CTL: 0.1 to 0.3 Vp-p TC: 0.6 Vp-p VIDEO: 1.0 Vp-p</li> </ul>																		
11 SYS SC COAR.	<p>Coarse adjustment of system phase: 90° units</p> <table> <tr><td>0000</td><td>0</td><td></td></tr> <tr><td>0001</td><td>90</td><td>&lt;Note&gt;</td></tr> <tr><td>0002</td><td>180</td><td>If setting operation is</td></tr> <tr><td>0003</td><td>270</td><td>performed, the setting value</td></tr> <tr><td></td><td></td><td>does not return to factory</td></tr> <tr><td></td><td></td><td>(default) setting.</td></tr> </table>	0000	0		0001	90	<Note>	0002	180	If setting operation is	0003	270	performed, the setting value			does not return to factory			(default) setting.
0000	0																		
0001	90	<Note>																	
0002	180	If setting operation is																	
0003	270	performed, the setting value																	
		does not return to factory																	
		(default) setting.																	
12 SYS SC FINE	<p>Fine adjustment of system phase: Variable range ±45° or more --: Advanced, +: Delayed</p> <table> <tr><td>0000</td><td>-128</td><td>&lt;Note&gt;</td></tr> <tr><td>:</td><td>:</td><td>If setting operation is</td></tr> <tr><td>0128</td><td>0</td><td>performed, the setting value</td></tr> <tr><td>:</td><td>:</td><td>does not return to factory</td></tr> <tr><td>0255</td><td>127</td><td>(default) setting.</td></tr> </table>	0000	-128	<Note>	:	:	If setting operation is	0128	0	performed, the setting value	:	:	does not return to factory	0255	127	(default) setting.			
0000	-128	<Note>																	
:	:	If setting operation is																	
0128	0	performed, the setting value																	
:	:	does not return to factory																	
0255	127	(default) setting.																	
13 SYS H	<p>System phase adjustment: 74 ns steps --: Advanced, +: Delayed</p> <table> <tr><td>0000</td><td>-128</td><td>&lt;Note&gt;</td></tr> <tr><td>:</td><td>:</td><td>If setting operation is</td></tr> <tr><td>0108</td><td>0</td><td>performed, the setting value</td></tr> <tr><td>:</td><td>:</td><td>does not return to factory</td></tr> <tr><td>0216</td><td>127</td><td>(default) setting.</td></tr> </table>	0000	-128	<Note>	:	:	If setting operation is	0108	0	performed, the setting value	:	:	does not return to factory	0216	127	(default) setting.			
0000	-128	<Note>																	
:	:	If setting operation is																	
0108	0	performed, the setting value																	
:	:	does not return to factory																	
0216	127	(default) setting.																	

No./Item	Description										
14 SCH COARSE	<p>SCH phase adjustment: 90° units (The SC phase changes but the H phase does not change.) --: Advanced, +: Delayed</p> <table> <tr><td>0000</td><td>0</td></tr> <tr><td>0001</td><td>90</td></tr> <tr><td>0002</td><td>180</td></tr> <tr><td>0003</td><td>270</td></tr> </table>	0000	0	0001	90	0002	180	0003	270		
0000	0										
0001	90										
0002	180										
0003	270										
15 SCH FINE	<p>SCH phase adjustment: Total variable range: ±45° or more (The SC phase changes but the H phase does not change.) --: Advanced, +: Delayed</p> <table> <tr><td>0000</td><td>-32</td></tr> <tr><td>:</td><td>:</td></tr> <tr><td>0032</td><td>0</td></tr> <tr><td>:</td><td>:</td></tr> <tr><td>0064</td><td>32</td></tr> </table>	0000	-32	:	:	0032	0	:	:	0064	32
0000	-32										
:	:										
0032	0										
:	:										
0064	32										
16 AV PHASE	<p>This adjusts the audio output phase with respect to the video output: 20.8 μs steps --: The audio output phase is advanced with respect to the video output. +: The audio output phase is delayed with respect to the video output.</p> <table> <tr><td>0000</td><td>-128</td></tr> <tr><td>:</td><td>:</td></tr> <tr><td>0128</td><td>0</td></tr> <tr><td>:</td><td>:</td></tr> <tr><td>0255</td><td>127</td></tr> </table>	0000	-128	:	:	0128	0	:	:	0255	127
0000	-128										
:	:										
0128	0										
:	:										
0255	127										

The underlined items indicates the initial setting.

# Setup menus (continued)

## SYSTEM menu

No./Item	Description														
<b>18</b>	<b>System phase adjustment.</b>														
<b>SYS H OFFSET</b>	<table border="0"> <tr><td><u>0000</u></td><td>-3 : -13.4 μsec</td></tr> <tr><td>0001</td><td>-2 : -8.96 μsec</td></tr> <tr><td>0002</td><td>-1 : -4.52 μsec</td></tr> <tr><td><u>0003</u></td><td>0 : 0 sec</td></tr> <tr><td>0004</td><td>1 : +4.52 μsec</td></tr> <tr><td>0005</td><td>2 : +8.96 μsec</td></tr> <tr><td>0006</td><td>3 : +13.4 μsec</td></tr> </table> <p>&lt;Note&gt; Factory settings will remain unchanged even if an attempt is</p>	<u>0000</u>	-3 : -13.4 μsec	0001	-2 : -8.96 μsec	0002	-1 : -4.52 μsec	<u>0003</u>	0 : 0 sec	0004	1 : +4.52 μsec	0005	2 : +8.96 μsec	0006	3 : +13.4 μsec
<u>0000</u>	-3 : -13.4 μsec														
0001	-2 : -8.96 μsec														
0002	-1 : -4.52 μsec														
<u>0003</u>	0 : 0 sec														
0004	1 : +4.52 μsec														
0005	2 : +8.96 μsec														
0006	3 : +13.4 μsec														
<b>19</b>	<b>This sets whether the system phase is to be adjusted by the unit or from the external encoder remote controller.</b>														
<b>SYS SC/H</b>	<p><u>0000</u> <b>REMOTE :</b> The system phase is adjusted from the external encoder remote controller.</p> <p>0001 <b>LOCAL :</b> The system phase is adjusted by the unit.</p> <p>&lt;Note&gt; The setting of this menu item has no effect when the ENC CONTROL switch is at the LOCAL setting.</p>														

The underlined items indicates the initial setting.

No./Item	Description										
<b>30</b>	<b>This adjusts the brightness of the LCD monitor on the front panel.</b>										
<b>BRIGHT</b>	<table border="0"> <tr><td>0000</td><td>-7</td></tr> <tr><td>:</td><td>:</td></tr> <tr><td><u>0007</u></td><td><u>0</u></td></tr> <tr><td>:</td><td>:</td></tr> <tr><td>0014</td><td>7</td></tr> </table> <p>&lt;Note&gt; If setting operation is performed, the setting value does not return to factory (default) setting.</p>	0000	-7	:	:	<u>0007</u>	<u>0</u>	:	:	0014	7
0000	-7										
:	:										
<u>0007</u>	<u>0</u>										
:	:										
0014	7										
<b>31</b>	<b>This adjusts the contrast of the LCD monitor on the front panel.</b>										
<b>CONTRAST</b>	<table border="0"> <tr><td>0000</td><td>-7</td></tr> <tr><td>:</td><td>:</td></tr> <tr><td><u>0007</u></td><td><u>0</u></td></tr> <tr><td>:</td><td>:</td></tr> <tr><td>0014</td><td>7</td></tr> </table> <p>&lt;Note&gt; If setting operation is performed, the setting value does not return to factory (default) setting.</p>	0000	-7	:	:	<u>0007</u>	<u>0</u>	:	:	0014	7
0000	-7										
:	:										
<u>0007</u>	<u>0</u>										
:	:										
0014	7										
<b>40</b>	<b>This selects whether the system file lock mode is to be engaged or released.</b>										
<b>MENU LOCK</b>	<table border="0"> <tr><td><u>0000</u></td><td><b>OFF :</b> The lock is released (file data can be changed).</td></tr> <tr><td>0001</td><td><b>ON :</b> The lock is engaged (file data cannot be changed).</td></tr> </table> <p>&lt;Note&gt; Setup menu No. 00 (WFM SEL) can be changed at any time regardless of the setting selected for this menu item.</p>	<u>0000</u>	<b>OFF :</b> The lock is released (file data can be changed).	0001	<b>ON :</b> The lock is engaged (file data cannot be changed).						
<u>0000</u>	<b>OFF :</b> The lock is released (file data can be changed).										
0001	<b>ON :</b> The lock is engaged (file data cannot be changed).										

### Video output signal adjustments

The video output signals are adjusted using combinations of the ENC CONTROL switch position and SYSTEM menu item No.19 (SYS SC/H) setting.

These adjustments can be used for analog component, analog composite and SDI signal output.

A control matrix of the adjustments is shown below.

Setting		Item adjusted	
ENC CONTROL switch position	SYSTEM menu item 19: SYS SC/H	SYSTEM menu item 11: SYS SC COAR. 12: SYS SC FINE 13: SYS H	Bottom of front panel VIDEO LEVEL CHROMA LEVEL SET UP/BLC HUE/CHROMA PH
LOCAL	LOCAL	Unit	Unit
	REMOTE		
REMOTE	LOCAL	Unit	External encoder remote controller
	REMOTE	External encoder remote controller	

# Setup menus (continued)

## USER menu <BASIC>

No./Item	Description
000 P-ROLL TIME	<p>This sets the preroll time. The preroll time can be set from 0 to 15 seconds in 1-second increments.</p> <p><u>0000</u>    0s    &lt;Note&gt; :        :        : When the automatic editing <u>0005</u>    5s        mode [PREVIEW, AUTO :        :        : EDIT] is set, the unit will not 0015    15s        operate if the preroll time is                  set to 0 seconds.</p>
001 LOCAL ENA	<p>This selects the buttons on the front panel which can be operated when the REMOTE button is set to the remote mode (REMOTE lamp ON).</p> <p>0000    DIS : No buttons can be operated. <u>0001</u>   ST&amp;EJ : Only the STOP and EJECT buttons can be operated. 0002    ENA : All buttons except for the RECORDER and PLAYER buttons can be operated.</p>
002 TAPE TIMER	<p>This selects the 12 or 24 hour display for the CTL counter.</p> <p><u>0000</u>    ±12h : 12 hour display 0001    24h : 24 hour display</p>
003 REMAIN SEL	<p>This selects whether the remaining tape time and total tape length are to be displayed in the superimposed display of the VIDEO OUT 3/SDI OUT 3 connector signals.</p> <p>0000    OFF : No display. <u>0001</u>    2L : The remaining tape time is displayed on the second line. 0002    1L : The remaining tape time is displayed on the first line. 0003    R/TTL : The remaining tape time is displayed on the first line, and the total tape length is displayed in the second line.</p> <p>&lt;Notes&gt; ● When "2L" is selected, the remaining tape time is not displayed if "TIME" has been selected as the setup menu item No.008 (DISPLAY SEL) setting. ● When "R/TTL" is selected, the total tape length is not displayed if "TIME" has been selected as the setup menu item No.008 (DISPLAY SEL) setting.</p>

No./Item	Description
006 SYNCHRONIZE	<p>This selects whether or not to synchronize between two VTRs.</p> <p>0000    OFF : No synchronization. The editing points deviate several frames, but editing can be started quickly. <u>0001</u>    ON : Synchronization. Allows for error-free editing.</p>
008 DISPLAY SEL	<p>This selects what information is to be provided by the time code and other super displays output to the VIDEO OUT 3/SDI OUT 3 connector.</p> <p>0000    TIME : Data only. (The data indicates the value for whichever of CTL, TC or UB currently selected by the COUNTER button.) 0001    T&amp;STA : Data and operation status. 0002    T&amp;S&amp;M : Data, operation status and mode. 0003    T&amp;RT : Data and REC TIME 0004    T&amp;YMD : Data and REC DATE (year/month/day) 0005    T&amp;MDY : Data and REC DATE (month/day/year) 0006    T&amp;DMY : Data and REC DATE (day/month/year) 0007    T&amp;UB : Data and user bit. However, when UB has been selected with the COUNTER button, the time code is displayed after the user bit. 0008    T&amp;CTL : Data and CTL data. However, when CTL has been selected with the COUNTER button, the time code is displayed after the CTL data. 0009    T&amp;T : Data and time code. 0010    VITC : The time code and user bit recorded in the VAUX area are displayed.</p> <p>&lt;Notes&gt; ● Mode display: DVCPRO 50 (50 Mbps) = DVCPRO_50, DVCPRO (25 Mbps) = DVCPRO, DV = DV, DVCAM = DVCAM ● An error message appears if a warning or error has occurred when "T&amp;S&amp;M" has been selected as this setting. ● REC TIME and REC DATE are displayed during DV/DVCAM, playback only. With the DVCPRO50 (50 Mbps) or DVCPRO (25 Mbps) format, the operating mode is displayed.</p>

The underlined items indicates the initial setting.



# Setup menus (continued)

## USER menu <BASIC>

No./Item	Description
009 CHARA H-POS	<p>This sets the position of the characters on the horizontal plane for the time code and other super displays output to the VIDEO OUT 3/SDI OUT 3 connector.</p> <p>0000 0 : : <u>0004</u> 4 : : 0016 16</p>
010 CHARA V-POS	<p>This sets the position of the characters on the vertical plane for the time code and other super displays output to the VIDEO OUT 3/SDI OUT 3 connector.</p> <p>[625i system] [525i system] 0000 0 0000 0 : : : : <u>0023</u> 23 <u>0018</u> 18 : : : : 0028 28 0022 22</p> <p>&lt;Note&gt; When the DISPLAY SEL setting causes characters to extend beyond the edges of the screen, the setting value is changed so that the characters are automatically displayed in a position on the screen.</p>
011 CHARA TYPE	<p>This selects the display type for the super display output to the VIDEO OUT 3/SDI OUT 3 connector as well as for displays such as the setting menu, etc.</p> <p>0000 <u>WHITE</u> : White characters against a black background. 0001 W/OUT : White characters with a black border.</p>
012 SYS FORMAT	<p>This sets the VTR's recording and playback format.</p> <p>0000 <u>50M</u> : DVCPRO50 (50 Mbps) is selected. 0001 25M : DVCPRO (25 Mbps) is selected.</p> <p>&lt;Note&gt; The format complies with the setting of this menu item when the tape is ejected.</p>

No./Item	Description
013 PB FORMAT	<p>This sets the format in which the tape is to be played back.</p> <p>0000 <u>MANUAL</u> : The format complies with the setting of setup menu No. 012 (SYS FORMAT) when a DVCPRO cassette is inserted. The format complies to the format recorded on the tape when a DV or DVCAM cassette is inserted. 0001 <u>AUTO</u> : The format complies with the format recorded on the tape.</p> <p>&lt;Notes&gt; ● When an editing mode has been selected, the "MANUAL" setting is forcibly established for internal operations. ● When AUTO has been selected, the picture and sound may be disturbed until the format is detected after a tape is loaded.</p>
015 MONI CONTROL	<p>This sets whether the recorder is to be forcibly set to the EE mode and the player's playback signals are to be output to the monitor by pressing the recorder's PLAYER button when a monitor has been connected only to the recorder during deck-to-deck editing.</p> <p>0000 <u>MANU</u> : The recorder is not forcibly set to the EE mode. 0001 <u>AUTO</u> : The recorder is forcibly set to the EE mode, and the player's playback signals are output.</p>
017 CHARA SIZE	<p>This selects the size of the characters for the superimposed display output from the VIDEO OUT 3 or SDI OUT 3 connector.</p> <p>0000 <u>NORMAL</u> : Standard size 0001 <u>LARGE</u> : 4 times larger than the standard size</p> <p>&lt;Note&gt; When LARGE has been selected, only time data is displayed, regardless of the setup menu No.008 (DISPLAY SEL) setting.</p>
070 TV SYSTEM	<p>This selects the TV system.</p> <p>0000 525 : The 525 interlace/59.94 Hz system is selected. 0001 <u>625</u> : The 625 interlace/50 Hz system is selected.</p> <p>&lt;Note&gt; After this setting is changed, turn off and back on the power again to take it effect.</p>

The underlined items indicates the initial setting.

# Setup menus (continued)

## USER menu <OPERATION>

No./Item	Description
100 SEARCH ENA	<p>This selects the direct search dial operation.</p> <p><u>0000</u> <b>DIAL</b> : For direct search dial operations. <u>0001</u> <b>KEY</b> : Operation is not transferred to the search mode unless the search button is pressed.</p>
101 SHTL MAX	<p>This sets the maximum speed for shuttle operations.</p> <p><u>0000</u> ×8.4 : 8.4× normal speed <u>0001</u> ×16 : 16× normal speed <u>0002</u> ×32 : 32× normal speed</p>
102 FF. REW MAX	<p>This sets the maximum speed for FF and REW operations.</p> <p><u>0000</u> ×16 : 16 (32)× normal speed <u>0001</u> ×32 : 32 (60)× normal speed <u>0002</u> ×50 : 50 (100)× normal speed</p> <p>&lt;Notes&gt;</p> <ul style="list-style-type: none"> <li>• The speeds given in the parentheses apply in the DVCPRO (25 Mbps), DV and DVCAM mode.</li> <li>• With mini DV or mini DVCAM cassette, the maximum speed is set to 32× regardless of this item's settings.</li> </ul>
104 REF ALARM	<p>This selects whether to warn the operator when the REF. VIDEO signal has not been connected.</p> <p><u>0000</u> <b>OFF</b> : Warning is not given. <u>0001</u> <b>ON</b> : Warning is given by the flashing STOP lamp.</p> <p>&lt;Note&gt; Video and audio output may be disturbed when the reference video signal is not input, so it is recommended that a system which inputs the reference video signal be used.</p>

No./Item	Description
105 AUTO EE SEL	<p>This selects the VTR mode in which the EE status is established when the MODE switch is set to EE.</p> <p><u>0000</u> <b>S/F/R</b> : EE status is established in STOP, FF, REW and EJECT modes. <u>0001</u> <b>STOP</b> : EE status is established in STOP and EJECT modes. <u>0002</u> <b>BLACK</b> : EE status is established in STOP and EJECT modes. However, if the MODE switch is set to TAPE, the picture becomes black and the sound is muted when the tape is ejected. <u>0003</u> <b>BLACK1</b> : EE status is established in STOP, FF, REW and EJECT modes. However, if the MODE switch is set to TAPE, the picture becomes black and the sound is muted when the tape is ejected. <u>0004</u> <b>GRAY</b> : EE status is established in STOP and EJECT modes. However, if the MODE switch is set to TAPE, the picture becomes gray and the sound is muted when the tape is ejected. <u>0005</u> <b>GRAY1</b> : EE status is established in STOP, FF, REW and EJECT modes. However, if the MODE switch is set to TAPE, the picture becomes gray and the sound is muted when the tape is ejected.</p>
106 EE MODE SEL	<p>This selects the EE mode output signals.</p> <p><u>0000</u> <b>NORMAL</b> : Signals are output with a delay equivalent to the length of internal signal processing. <u>0001</u> <b>THRU</b> : Signals are output directly, without internal processing, and so are output with no delay.</p> <p>&lt;Note&gt; When the unit is in edit mode and 1394 or SG has been selected for the input signals by the INPUT SELECT button, internal operations are forcibly set to NORMAL.</p>
107 PLAY DELAY	<p>This set the play delay time in frame increments.</p> <p><u>0000</u>     <u>0</u> :        : 0015     15</p>
108 CAP. LOCK	<p>This selects the CAPSTAN LOCK mode.</p> <p>[625i system] <u>0000</u>     <u>2F</u> : 2F mode <u>0001</u>     <u>4F</u> : 4F mode <u>0002</u>     <u>8F</u> : 8F mode</p> <p>[525i system] <u>0000</u>     <u>2F</u> : 2F mode <u>0001</u>     <u>4F</u> : 4F mode</p>

The underlined items indicates the initial setting.

# Setup menus (continued)

## USER menu <OPERATION>

No./Item	Description
109 <b>AUTO REW</b>	<p>This selects whether to rewind the tape automatically to the tape start when the tape end is detected.</p> <p><u>0000</u>    <b>OFF</b> : The tape stops at the tape end. 0001    <b>ON</b> : The tape is rewound to the tape start.</p>
110 <b>MEMORY STOP</b>	<p>This selects whether the VTR is to stop automatically when the counter value reaches "0" during a fast forwarding or rewinding operation in the CTL mode.</p> <p><u>0000</u>    <b>OFF</b> : The VTR does not stop. 0001    <b>ON</b> : The VTR stops automatically.</p> <p>&lt;Notes&gt;</p> <ul style="list-style-type: none"> <li>• The stop mode concerned is either the stop or the still-picture (SHTL STILL or SLOW STILL) mode depending on the setup menu No. 315 (AFTER CUE-UP) setting.</li> <li>• When both the AUTO REW function and MEMORY function have been selected at the same time, the AUTO REW function takes precedence.</li> </ul>

### Memory stop function

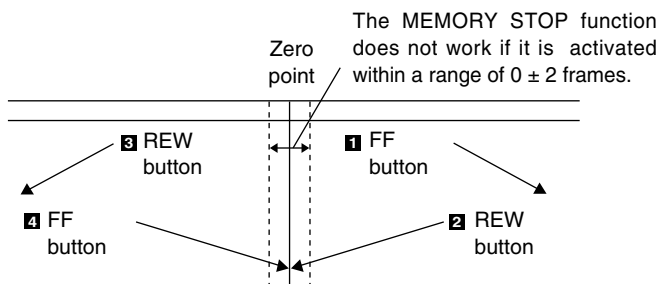

- 1 When the FF button is pressed, the VTR performs the regular fast forward operation since the zero point is not located in the direction of operation.
- 2 When the REW button is pressed, the PREROLL lamp lights (the SHTL lamp lights as well), the VTR proceeds with the preroll operation, and it automatically stops when it reaches the position where the counter reads "0."
- 3 When the REW button is pressed, the VTR performs the regular rewinding operation since the zero point is not located in the direction of operation.
- 4 When the FF button is pressed, the PREROLL lamp lights (the SHTL lamp lights as well), the VTR proceeds with the preroll operation, and it automatically stops when it reaches the position where the counter reads "0."

The underlined items indicates the initial setting.

No./Item	Description
111 <b>FRZ MODE SEL</b>	<p>This selects the output picture in the STANDBY OFF (HALF LOADING) and EJECT modes.</p> <p><u>0000</u>    <b>DIS</b> : The video output is muted. 0001 <b>STB OFF</b> : When the STANDBY OFF (HALF LOADING) mode is established, the picture being played back at the time is frozen and output. 0002 <b>SOF&amp;EJ</b> : When the STANDBY OFF (HALF LOADING) or EJECT mode is established, the picture being played back at the time is frozen and output.</p> <p>&lt;Notes&gt;</p> <ul style="list-style-type: none"> <li>• Freeze status complies with the setup menu item No. 605 (FREEZE SEL) setting.</li> <li>• In the EJECT mode, freeze is output only when BLACK, BLACK1, GRAY or GRAY1 is selected as the setup menu item No. 105 (AUTO EE SEL) setting.</li> </ul>
112 <b>V IN SEL INH</b>	<p>This selects whether video input switching using the INPUT SELECT button is to be enabled or disabled.</p> <p><u>0000</u>    <b>OFF</b> : Video input switching using the INPUT SELECT button is enabled. 0001    <b>ON</b> : Video input switching using the INPUT SELECT button is disabled. 0002    <b>REC</b> : Video input switching using the INPUT SELECT button after the unit has been transferred to a recording (but not editing) mode is disabled.</p>
113 <b>A IN SEL INH</b>	<p>This selects whether audio input switching using the INPUT SELECT button is to be enabled or disabled.</p> <p><u>0000</u>    <b>OFF</b> : Audio input switching using the INPUT SELECT button is enabled. 0001    <b>ON</b> : Audio input switching using the INPUT SELECT button is disabled. 0002    <b>REC</b> : Audio input switching using the INPUT SELECT button after the unit has been transferred to a recording (but not editing) mode is disabled.</p> <p>&lt;Note&gt;</p> <p>Even when the ON or REC setting is selected to disable audio input switching using the INPUT SELECT button, it is still possible to set the setup menu items No. 715 (CH1 IN SEL), No. 716 (CH2 IN SEL), No. 717 (CH3 IN SEL), No. 718 (CH4 IN SEL), No. 719 (D IN SEL12) and No. 720 (D IN SEL34).</p>

## Setup menus (continued)

### USER menu <OPERATION>

No./Item	Description
114 REC INH LAMP	<p>This selects whether to cause the REC INH lamp to flash or light up when the cassette has been set to the accidental erasure prevention status.</p> <p><u>0000</u> <u>LIGHT</u> : The lamp lights up. 0001 <b>FLASH</b> : The lamp flashes.</p> <p>&lt;Note&gt; When the REC INH switch is set to ON, the REC INH lamp always lights regardless of the general setting status.</p>
115 EJECT SW INH	<p>This selects whether to enable or disable the operation of the EJECT button on the front panel.</p> <p><u>0000</u> <b>REC</b> : Operation is disabled while the unit is in the recording mode. 0001 <b>OFF</b> : Operation is enabled in all modes.</p>
116 EJECT LAMP	<p>This selects whether the EJECT lamp is to remain lighted or be turned off in the cassette out status.</p> <p><u>0000</u> <b>MODE1</b> : The EJECT lamp remains lit. 0001 <b>MODE2</b> : The EJECT lamp goes off.</p>

The underlined items indicates the initial setting.

# Setup menus (continued)

## USER menu <INTERFACE>

No./Item	Description
200 PARA RUN	<p>This selects whether two or more VTRs are to be operated in synchronization.</p> <p><u>0000</u> <b>DIS</b> : No operation in synchronization            0001 <b>ENA</b> : Operation in synchronization</p> <p>&lt;Note&gt;            When operating two or more VTRs in synchronization, set all the VTRs to ENA.</p>
201 9P SEL	<p>This selects whether the 9P connector is to function when the REMOTE button is set to the remote mode (REMOTE lamp ON).</p> <p>0000 <b>OFF</b> : Connector does not function.  <u>0001</u> <b>ON</b> : Connector functions.</p>
202 ID SEL	<p>This sets the ID information to be returned to the controller.</p> <p>0000 <b>OTHER</b>  <u>0001</u> <b>DVCPRO</b>            0002 <b>ORIG</b></p> <p>&lt;Notes&gt;</p> <ul style="list-style-type: none"> <li>• ID information of any VTR except for the DVCPRO's is set in OTHER.</li> <li>• The ORIG setting should only be used when a Panasonic controller (AG-A850 etc. sold separately) is connected.</li> </ul>
203 25P SEL	<p>This selects whether the PARALLEL (25P) connector is to function when the REMOTE button is set to the remote mode (REMOTE lamp ON).</p> <p>0000 <b>OFF</b> : Connector does not function.  <u>0001</u> <b>ON</b> : Connector functions.</p>
204 RS232C SEL	<p>This selects whether the RS-232C connector is to function when the REMOTE button is set to the remote mode (REMOTE lamp ON).</p> <p><u>0000</u> <b>OFF</b> : Connector does not function.            0001 <b>ON</b> : Connector functions.</p>
205 BAUD RATE	<p>These settings are for selecting the RS-232C communication speed (baud rate).</p> <p>0000 300            0001 600            0002 1200            0003 2400            0004 4800  <u>0005</u> 9600</p>
206 DATA LENGTH	<p>These settings are for selecting the RS-232C data length. (Unit: bit)</p> <p>0000 7  <u>0001</u> 8</p>
207 STOP BIT	<p>These settings are for selecting the RS-232C stop bit length. (Unit: bit)</p> <p>0000 1  <u>0001</u> 2</p>

No./Item	Description
208 PARITY	<p>These settings are for selecting the none, odd or even for the RS-232C parity bit.</p> <p><u>0000</u> <b>NON</b> :            Parity bit is not used.            0001 <b>ODD</b> :            An odd number of bits is used for the parity system.            0002 <b>EVEN</b> :            An even number of bits is used for the parity system.</p>
209 RETURN ACK	<p>These settings are for selecting whether the ACK code is to be returned when a command is received from RS-232C.</p> <p>0000 <b>OFF</b> : ACK code is not returned.  <u>0001</u> <b>ON</b> : ACK code is returned.</p>
210 25P STBY CMD	<p>For selecting the method used to detect the STANDBY COMMAND signal input at the PARALLEL (25P) connector.</p> <p><u>0000</u> <b>OFF/ON</b> :            Each time active signals are detected, the STANDBY ON or STANDBY OFF mode is selected alternately.            0001 <b>ON</b> :            When active signals are detected in the STANDBY OFF mode, the unit is transferred to the STANDBY ON mode.            Nothing happens if they are detected during an operation in the STANDBY ON mode.</p>
211 LOCAL 25P	<p>This selects whether the PARALLEL (25P) connector is to function when the REMOTE button is set to the local mode (REMOTE lamp OFF).</p> <p><u>0000</u> <b>OFF</b> : Connector does not function.            0001 <b>ON</b> : Connector functions.</p>
212 MASTER PORT	<p>For selecting the remote control connector to control the slave when the unit is used as the master during deck-to-deck operations.</p> <p><u>0000</u> <b>IN/OUT</b> : The IN/OUT connector is used.            0001 <b>OUT</b> : The OUT connector is used.</p> <p>&lt;Note&gt;            This setting takes effect only when the REMOTE button is set to the local mode (REMOTE lamp OFF).</p>

The underlined items indicates the initial setting.

## Setup menus (continued)

### USER menu <EDIT>

No./Item	Description
301 <b>IN/OUT DEL</b>	<p>This selects the operation to be performed when an edit point has been set incorrectly (when the OUT point is before the IN point).</p> <p><b>0000 MANU :</b> Editing is not executed unless the illegal edit point is cleared or set again properly.</p> <p><b>0001 AUTO :</b> The edit points already input are automatically cleared.</p>
303 <b>STD/ NON-STD</b>	<p>This selects STD or NON-STD in accordance with the composite input signal.</p> <p><b>0000 AUTO :</b> Standard/non-standard signals are automatically identified and processed.</p> <p><b>0001 STD :</b> Standard signals are processed. (Forced STD)</p> <p><b>0002 N-STD :</b> Non-standard signals are processed. (Forced NON-STD)</p> <p>&lt;Note&gt; Use the non-standard (N-STD) setting when video or audio trouble occurs with signals from laser discs or a satellite.</p>
304 <b>SERVO REF</b>	<p>This selects the video signal processing.</p> <p><b>0000 AUTO :</b> Servo is synchronized with the input signal during recording and editing, or with the REF signal during playback. With the EE output, the servo is synchronized with the internal reference signal when there is no REF signal.</p> <p><b>0001 EXT :</b> Servo is synchronized at all times with the REF signal.</p> <p><b>0002 AUTO1 :</b> Select this setting to use a standard signal as the input signal. The servo is synchronized with the input signal during recording or editing and with the REF signal during playback. With the EE output, the servo is synchronized with the input signal when there is no REF signal.</p>

No./Item	Description
305 <b>EDIT RPLCE1</b>	<p>This sets the channel assignments for the controller's analog audio preset when editing the digital audio of the VTR using a controller which does not have a digital audio edit preset control function.</p> <p>This selects the channel concerned when the VTR CH1 edit preset is set in compliance with the ON or OFF presetting for the analog audio signals designated by the controller.</p> <p><b>0000 N-DEF :</b> Not set.</p> <p><b>0001 CH1 :</b> Compliance with analog CH1 edit preset.</p> <p><b>0002 CH2 :</b> Compliance with analog CH2 edit preset.</p> <p><b>0003 CH1+2 :</b> Compliance with either analog CH1 or CH2 edit preset.</p>
306 <b>EDIT RPLCE2</b>	<p>The same type of setting as setup menu No. 305. This selects the channel concerned when the CH2 edit preset is set in compliance with the ON or OFF presetting for the analog audio signals designated by the controller.</p> <p><b>0000 N-DEF :</b> Not set.</p> <p><b>0001 CH1 :</b> Compliance with analog CH1 edit preset.</p> <p><b>0002 CH2 :</b> Compliance with analog CH2 edit preset.</p> <p><b>0003 CH1+2 :</b> Compliance with either analog CH1 or CH2 edit preset.</p>
307 <b>EDIT RPLCE3</b>	<p>The same type of setting as setup menu No. 305. This selects the channel concerned when the CH3 edit preset is set in compliance with the ON or OFF presetting for the analog audio signals designated by the controller.</p> <p><b>0000 N-DEF :</b> Not set.</p> <p><b>0001 CH1 :</b> Compliance with analog CH1 edit preset.</p> <p><b>0002 CH2 :</b> Compliance with analog CH2 edit preset.</p> <p><b>0003 CH1+2 :</b> Compliance with either analog CH1 or CH2 edit preset.</p>

The underlined items indicates the initial setting.

# Setup menus (continued)

## USER menu <EDIT>

No./Item	Description
308 EDIT RPLCE4	<p>The same type of setting as setup menu No. 305. This selects the channel concerned when the CH4 edit preset is set in compliance with the ON or OFF presetting for the analog audio signals designated by the controller.</p> <p><u>0000</u> <b>N-DEF</b> : Not set.</p> <p>0001 <b>CH1</b> : Compliance with analog CH1 edit preset.</p> <p>0002 <b>CH2</b> : Compliance with analog CH2 edit preset.</p> <p>0003 <b>CH1+2</b> : Compliance with analog CH1 or CH2 edit preset.</p>
309 EDIT RPLCEC	<p>The same type of setting as setup menu No. 305. This selects the channel concerned when the CUE edit preset is set in compliance with the ON or OFF presetting for the analog audio signals designated by the controller.</p> <p><u>0000</u> <b>N-DEF</b> : Not set.</p> <p>0001 <b>CH1</b> : Compliance with analog CH1 edit preset.</p> <p>0002 <b>CH2</b> : Compliance with analog CH2 edit preset.</p> <p>0003 <b>CH1+2</b> : Compliance with either analog CH1 or CH2 edit preset.</p>
310 CONFI EDIT	<p>This selects whether to conduct simultaneous playback while editing is in progress.</p> <p><u>0000</u> <b>OFF</b> : No simultaneous playback 0001 <b>ON</b> : Simultaneous playback</p> <p>&lt;Note&gt; Simultaneous playback is valid when the MODE switch is set to TAPE.</p>
311 AUD EDIT IN	<p>This selects the connection method for the digital audio edit IN point.</p> <p>0000 <b>CUT</b> : Cut processing <u>0001</u> <b>FADE</b> : V Fade processing</p>
312 AUD EDIT OUT	<p>This selects the connection method for the digital audio edit OUT point.</p> <p>0000 <b>CUT</b> : Cut processing <u>0001</u> <b>FADE</b> : V Fade processing</p>
313 AUTO ENTRY	<p>This selects whether the IN point is to be entered using the PREROLL button when it has not been entered.</p> <p><u>0000</u> <b>DIS</b> : IN point is not entered. 0001 <b>ENA</b> : IN point is entered.</p>

No./Item	Description
314 CF ADJ SEL	<p>This selects the CF adjustment deck with deck-to-deck editing.</p> <p><u>0000</u> <b>PLAYER</b> : The player's edit IN/OUT points are adjusted. (reference as the RECORDER side)</p> <p>0001 <b>RECORD</b> : The recorder's edit IN/OUT points are adjusted. (reference as the PLAYER side)</p>
315 AFTER CUE-UP	<p>This selects the mode after cue-up operation is complete.</p> <p><u>0000</u> <b>STOP</b> : STOP mode 0001 <b>STILL</b> : SHTL STILL mode 0002 <b>STILL2</b> : SLOW STILL mode</p>
320 VAR FWD MAX	<p>This sets the maximum SLOW FWD speed.</p> <p><u>0000</u> <b>+4.1</b> : +4.1 (+3.1)× speed 0001 <b>+1.85</b> : +1.85× speed 0002 <b>+1</b> : +1× speed</p> <p>&lt;Notes&gt;</p> <ul style="list-style-type: none"> <li>• The value for the DV/DVCAM tape is shown in parenthesis ( ).</li> <li>• At any speed setting other than +4.1, the phase cannot be synchronized from the editing controller.</li> </ul>
321 VAR REV MAX	<p>This sets the maximum SLOW REV speed.</p> <p><u>0000</u> <b>-4.1</b> : -4.1 (-3.1)× speed 0001 <b>-1.85</b> : -1.85× speed 0002 <b>-1</b> : -1× speed 0003 <b>-0.43</b> : -0.43× speed</p> <p>&lt;Note&gt; The value for the DV/DVCAM tape is shown in parenthesis ( ).</p>
323 JOG FWD MAX	<p>This sets the maximum JOG FWD speed.</p> <p><u>0000</u> <b>+4.1</b> : +4.1 (+3.1)× speed 0001 <b>+1.85</b> : +1.85× speed <u>0002</u> <b>+1</b> : +1× speed</p> <p>&lt;Notes&gt;</p> <ul style="list-style-type: none"> <li>• The value for the DV/DVCAM tape is shown in parenthesis ( ).</li> <li>• The maximum speed is set to +1× when the dial on the front panel is operated.</li> <li>• At any speed setting other than +4.1, the phase cannot be synchronized from an editing controller which synchronizes the phase using the JOG command.</li> </ul>

The underlined items indicates the initial setting.

## Setup menus (continued)

### USER menu <EDIT>

No./Item	Description
324  JOG REV MAX	<p>This sets the maximum JOG REV speed.</p> <p>0000    -4.1 : -4.1 (-3.1) × speed            0001    -1.85 : -1.85 × speed            0002    -1 : -1 × speed  <u>0003</u>   -0.43 : -0.43 (-0.5) × speed</p> <p>&lt;Notes&gt;</p> <ul style="list-style-type: none"> <li>• The value for the DV/DVCAM tape is shown in parenthesis ( ).</li> <li>• The maximum speed is set to -1 × when the dial on the front panel is operated.</li> </ul>
325  POSTROLL TM	<p>This sets the postroll time.            Any time from 0 to 5 seconds can be set in 1-second units.</p> <p>0000    0s            0001    1s  <u>0002</u>    2s            0003    3s            0004    4s            0005    5s</p>

### USER menu <TAPE PROTECT>

No./Item	Description
400  STILL TIMER	<p>This selects the time to be taken until the unit goes into the tape protection mode when it is left standing in the stop or search still (JOG/SLOW/SHTL) mode.            (Unit: s = second, min = minute)</p> <p>0000    0.5s    &lt;Notes&gt;            0001    5s        • STEP FWD and HALF            0002    10s        LOADING are provided in            0003    20s        the tape protection mode.            0004    30s        Either of these can be set            0005    40s        for STOP and SEARCH            0006    50s        STILL.            0007    1min       • The cumulative standby  <u>0008</u>    2min       time at the same tape                             position increases when                             transmitting programs or                             otherwise using identical                             materials repeatedly.                             In order to protect the tape,                             it is recommended that the                             shortest possible setting for                             the standby time in the                             same tape location is used.                             • When a DV/DVCAM tape is                             used, any setting above 10                             seconds will be treated as                             10 seconds.</p>

No./Item	Description
401  SRC PROTECT	<p>When the time selected as the setup menu item No. 400 (STILL TIMER) setting elapses while the unit is in the search STILL (JOG/SLOW/SHTL) mode, the unit automatically enters one of the tape protection modes. This menu item is for selecting which tape protection mode the unit is to enter.</p> <p>0000    STEP : STEP FWD            0001    HALF : HALF LOADING</p> <p>&lt;Note&gt;</p> <p>When STEP FWD is selected, the unit automatically goes into the STANDBY OFF (HALF LOADING) mode when the total time for which the unit is left standing in the still status reaches 30 minutes (or 1 minute for a DV/DVCAM tape).</p>
402  DRUM STDBY	<p>This selects the drum operation in the STANDBY OFF (HALF LOADING) mode.</p> <p>0000    OFF : The drum stops rotating.  <u>0001</u>    ON : The drum continues rotating.</p>
403  STOP PROTECT	<p>When the time selected as the setup menu item No. 400 (STILL TIMER) setting elapses while the unit is in the STOP mode, the unit automatically enters one of the tape protection modes. This menu item is for selecting which tape protection mode the unit is to enter.</p> <p>0000    STEP : STEP FWD            0001    HALF : HALF LOADING</p> <p>&lt;Note&gt;</p> <p>When STEP FWD is selected, the unit is automatically transferred to the STANDBY OFF (HALF LOADING) mode when the total time during which it has been left standing in the STOP mode reaches 30 minutes (or 1 minute for a DV/DVCAM tape).</p>

The underlined items indicates the initial setting.



# Setup menus (continued)

## USER menu <TIME CODE>

No./Item	Description												
500 VITC BLANK	<p>For selecting whether to output the VITC signal at the positions selected by setup menu items No. 501 (VITC POS-1) and No. 502 (VITC POS-2).</p> <p><u>0000</u> BLANK : VITC signals are not output.  <u>0001</u> THRU : VITC signals are output.</p>												
501 VITC POS-1	<p>This sets the position where the VITC signal is to be inserted.</p> <table border="0"> <tr> <td>[625i system]</td> <td>[525i system]</td> </tr> <tr> <td><u>0000</u> 7L</td> <td><u>0000</u> 10L</td> </tr> <tr> <td>:</td> <td>:</td> </tr> <tr> <td><u>0004</u> 11L</td> <td><u>0006</u> 16L</td> </tr> <tr> <td>:</td> <td>:</td> </tr> <tr> <td><u>0015</u> 22L</td> <td><u>0010</u> 20L</td> </tr> </table> <p>&lt;Note&gt;            The same line as the one used for the setup menu items No. 502 (VITC POS-2) and No. 662 (UMID POS) setting cannot be set.</p>	[625i system]	[525i system]	<u>0000</u> 7L	<u>0000</u> 10L	:	:	<u>0004</u> 11L	<u>0006</u> 16L	:	:	<u>0015</u> 22L	<u>0010</u> 20L
[625i system]	[525i system]												
<u>0000</u> 7L	<u>0000</u> 10L												
:	:												
<u>0004</u> 11L	<u>0006</u> 16L												
:	:												
<u>0015</u> 22L	<u>0010</u> 20L												
502 VITC POS-2	<p>This sets the position where the VITC signal is to be inserted.</p> <table border="0"> <tr> <td>[625i system]</td> <td>[525i system]</td> </tr> <tr> <td><u>0000</u> 7L</td> <td><u>0000</u> 10L</td> </tr> <tr> <td>:</td> <td>:</td> </tr> <tr> <td><u>0006</u> 13L</td> <td><u>0008</u> 18L</td> </tr> <tr> <td>:</td> <td>:</td> </tr> <tr> <td><u>0015</u> 22L</td> <td><u>0010</u> 20L</td> </tr> </table> <p>&lt;Note&gt;            The same line as the one used for the setup menu items No. 501 (VITC POS-1) and No. 662 (UMID POS) setting cannot be set.</p>	[625i system]	[525i system]	<u>0000</u> 7L	<u>0000</u> 10L	:	:	<u>0006</u> 13L	<u>0008</u> 18L	:	:	<u>0015</u> 22L	<u>0010</u> 20L
[625i system]	[525i system]												
<u>0000</u> 7L	<u>0000</u> 10L												
:	:												
<u>0006</u> 13L	<u>0008</u> 18L												
:	:												
<u>0015</u> 22L	<u>0010</u> 20L												
503 TCG REGEN	<p>This selects the signal to be regenerated when the time code generator (TCG) in the REGEN mode.</p> <p><u>0000</u> TC&amp;UB :            Both the time code and user bit are regenerated.  <u>0001</u> TC :            Only the time code is regenerated.  <u>0002</u> UB :            Only the user bit is regenerated.</p>												
504 REGEN MODE	<p>This selects whether the time code is to be regenerated during automatic editing using the unit's control panel.</p> <p><u>0000</u> AS&amp;IN :            Time code is regenerated with assemble or insert editing.  <u>0001</u> ASSEM :            Time code is regenerated with assemble editing.  <u>0002</u> INSRT :            Time code is regenerated with insert editing.  <u>0003</u> SW :            Setting complies with TC (REGEN/PRESET) switch setting.</p>												

No./Item	Description
505 EXT TC SEL	<p>This selects the time code to be used when an external time code is to be used.</p> <p><u>0000</u> LTC :            The LTC of the TIME CODE IN connector is used.  <u>0001</u> VITC :            The VITC of the input video signal is used.</p>
506 BINARY GP	<p>This sets the usage status of the user bit of the time code generated by the TCG.</p> <p><u>0000</u> 000 :            NOT SPECIFIED (character set not specified)  <u>0001</u> 001 :            ISO CHARACTER (8 bits character set based on ISO646, ISO2022)  <u>0002</u> 010 : UNASSIGNED 1 (undefined)  <u>0003</u> 011 : UNASSIGNED 2 (undefined)  <u>0004</u> 100 : UNASSIGNED 3 (undefined)  <u>0005</u> 101 : PAGE/LINE  <u>0006</u> 110 : UNASSIGNED 4 (undefined)  <u>0007</u> 111 : UNASSIGNED 5 (undefined)</p>
507 PHASE CORR	<p>This selects whether to control the phase correction of the LTC which is output from the TIME CODE OUT connector.</p> <p><u>0000</u> OFF :            Phase correction control is not performed.  <u>0001</u> ON :            Phase correction control is performed.</p>
508 TCG CF FLAG	<p>This selects whether the CF flag of the TCG is to ON.</p> <p><u>0000</u> OFF : CF flag is OFF.  <u>0001</u> ON : CF flag is ON.</p>
509 DF MODE	<p>This selects the DF or NDF mode for CTL and TCG.</p> <p><u>0000</u> DF : The drop frame mode is used.  <u>0001</u> NDF : The non-drop frame mode is used.</p> <p>&lt;Notes&gt;</p> <ul style="list-style-type: none"> <li>The drop frame mode takes effect when the REMOTE button is set to the local mode (REMOTE lamp OFF) or when ENA has been selected as the setup menu item No.001 (LOCAL ENA).</li> <li>This setup menu is not displayed in the 625i system.</li> </ul>
510 TC OUT REF	<p>This is used to switch the phase of the time code, which is output from the TIME CODE OUT connector, for the external LTC input when the TCG switch is at the EXT position.</p> <p><u>0000</u> V OUT :            Time code is synchronized with output video signal.  <u>0001</u> TC_IN :            Time code is synchronized with external time code input.</p>

The underlined items indicates the initial setting.

# Setup menus (continued)

## USER menu <TIME CODE>

No./Item	Description
511 VITC OUT	<p><b>This selects how the VITC which is to be superimposed onto the output video signal is to be output.</b></p> <p><u>0000</u>    <b>SBC :</b> During recording: The input time code, which was selected by the setup menu No. 505 (EXT TC SEL) setting and TCG switch, is output as the VITC. During playback: The time code recorded in the SBC area is output as the VITC.</p> <p><b>0001</b>    <b>VAUX :</b> During recording: The time code detected from the input video signal is output as the VITC. During playback: The time code recorded in the VAUX area is output as the VITC.</p> <p><b>&lt;Note&gt;</b> The time code detected from the input video signal is automatically recorded in the VAUX area while pictures are being recorded.</p>
512 TC OUT ADV	<p><b>This selects how the phase alignment for the time code output from the TIME CODE OUT connector is to be handled.</b></p> <p>Usually, it is aligned with the output video and audio signals. However, when external components are to be connected, it is possible to align the phase with the input signal.</p> <p><u>0000</u>    <b>OFF :</b> Phase alignment is not performed. The time code output from the TIME CODE OUT connector is aligned with the output video and audio signals.</p> <p><b>0001</b>    <b>EDIT :</b> When editing mode has been selected, the time code output from the TIME CODE OUT connector is aligned with the input video and audio signals during playback and editing operations. In all other modes it is aligned with the output video and audio signals.</p>

No./Item	Description
514 VITC GEN	<p><b>This selects whether or not to record the internal time code generator value in the VAUX area.</b></p> <p><u>0000</u>    <b>OFF :</b> The internal time code generator value is not recorded in the VAUX area. When video signals on which the time code has been recorded are input, the time code of the input signals is recorded in the VAUX area.</p> <p><b>0001</b>    <b>ON :</b> The internal time code generator value is recorded in the VAUX area.</p> <p><b>&lt;Note&gt;</b> If 1394 has been selected as the input signals using the INPUT SELECT button, the time code on the input signals will be recorded regardless of this menu's setting.</p>

### SBC (sub code data) area:

This area is separate from the video and audio data area on the helical track. The time code complying with SMPTE/EBU standards is stored here. As with the conventional LTC (linear time code), the time code can be read even during rewinding or fast forwarding. It can also be read out when the tape has stopped.

### VAUX (video auxiliary data) area:

This area is to be found in the video data area on the helical track. The additional information relating to the video data is stored here.

### <Note>

The time code and user bit are controlled during tape playback by the data which has been recorded in the SBC area. This means that all the data recorded in the SBC area alone is used as the data which is to be indicated on the counter display section in the middle of the front panel or in the superimposed display, or as the data which is to be transmitted to the editing controller or other unit.

The underlined items indicates the initial setting.

# Setup menus (continued)

## USER menu <VIDEO>

No./Item	Description
600 INT SG	<b>This selects the internal reference signal.</b>  0001 <u>BB</u> : The black burst is generated. 0002 <u>CB100</u> : 100% color bars are generated. 0003 <u>CB75</u> : 75% color bars are generated.
601 OUT VSYNC	<b>This selects whether to float the vertical sync position of the video output in order to align the video output phase with the input in the EE/record/edit modes.</b>  0000 <u>N-VF</u> : Signals are not floated. 0001 <u>VF</u> : Signals are floated.
602 V-MUTE SEL	<b>This selects whether to mute the video output signals when a blank on the tape has been detected during playback.</b>  0000 <u>N-MUTE</u> : No muting. (Freeze) 0001 <u>LOW RF</u> : Muting. (Set to gray.)
603 CC (F1) BLANK	<b>This selects ON or OFF for the closed caption signal of the first field.</b>  0000 <u>BLANK</u> : Signal is forcibly blanked. 0001 <u>THRU</u> : Signal is not blanked. <Note> This setup menu is not displayed in the 625i system.
604 CC (F2) BLANK	<b>This selects ON or OFF for the closed caption signal of the second field.</b>  0000 <u>BLANK</u> : Signal is forcibly blanked. 0001 <u>THRU</u> : Signal is not blanked. <Note> This setup menu is not displayed in the 625i system.
605 FREEZE SEL	<b>This selects the freeze mode for still pictures.</b>  0000 <u>FIELD</u> : Field freeze. 0001 <u>FRAME</u> : Frame freeze. <Note> When frame freeze has been selected, the frame slow status is established with the slow setting.
606 OUT C KILL	<b>This selects chroma color killer processing for the video output signals.</b>  0000 <u>B/W</u> : No color signals are output. 0001 <u>COLOR</u> : Color signals are output.

No./Item	Description
609 EDH	<b>This selects whether to superimpose EDH onto the SDI output signals.</b>  0000 <u>OFF</u> : EDH is not superimposed. 0001 <u>ON</u> : EDH is superimposed. <Note> Even when ON is selected for this setting, EDH is not superimposed onto the signals output from the SDI OUT 3 connector if the SUPER switch on the front panel of the unit is set to ON.
610 Pb/Pr IN LV	<b>This selects the analog component input level.</b>  0000 <u>M II</u> : M II level 0001 <u>B-CAM</u> : B-CAM level <Notes> • This setup menu is not displayed in the 625i system. • When no optional board (AJ-YA931G) has been installed, setup menu No. 610 is not displayed.
611 YC SEP MODE	<b>This selects Y/C separation processing for the composite input signals.</b>  0000 <u>B/W</u> : The signals are processed as B/W signals. 0001 <u>AUTO</u> : The signals are automatically detected. <Note> When no optional board (AJ-YA931G) has been installed, setup menu No. 611 is not displayed.
614 Pb/Pr OUT LV	<b>This selects the analog component output level.</b>  0000 <u>M II</u> : M II level 0001 <u>B-CAM</u> : B-CAM level <Note> This setup menu is not displayed in the 625i system.
618 INTERPOLATE	<b>This selects the interpolation operation.</b> Vertical interpolation is conducted automatically during slow-motion playback to reduce the vertical movement of the playback pictures. However, this menu item enables the interpolation operation to be forcibly turned off.  0000 <u>OFF</u> : Interpolation is forcibly turned off. 0001 <u>AUTO</u> : Interpolation is automatically turned on during slow-motion playback.

The underlined items indicates the initial setting.

## Setup menus (continued)

### USER menu <VIDEO>

No./Item	Description
620 ESR MODE	<p>This selects the operation mode for edge subcarrier reduction (ESR) in the playback circuit.</p> <p><u>0000</u> OFF: The mode is forcibly set to OFF.</p> <p><u>0001</u> AUTO: The mode is automatically set to ON or OFF depending on the VTR operation.</p>
621 CCR MODE	<p>This selects the cross color processing during playback.</p> <p><u>0000</u> OFF: The cross color is output with no changes made.</p> <p><u>0001</u> ON: The cross color can be reduced.</p> <p>&lt;Note&gt; This setup menu is not displayed in the 625i system.</p>

No./Item	Description
622 SETUP 25	<p><b>For setting 7.5% setup processing to be performed on input and output signals in the DVCPRO (25 Mbps) mode.</b></p> <p>When the STOP button is pressed, operation is transferred to the sub-screen, and the setup level is set for each output. To return from the sub-screen, press the STOP button again.</p> <p>&lt;Note&gt; This setup menu is not displayed in the 625i system.</p>
Sub-screen	
00 CMPST IN	<p><b>This selects the 7.5% setup processing for the input composite signal.</b></p> <p><u>0000</u> THRU: The signal is recorded in its original form.</p> <p><u>0001</u> CUT: The signal is recorded with the 7.5% setup removed.</p>
01 CMPST OUT	<p><b>This selects the 7.5% setup processing for the output composite signal.</b></p> <p><u>0000</u> THRU: The signal is output in its original form.</p> <p><u>0001</u> ADD: The signal is output with the 7.5% setup added.</p> <p>&lt;Note&gt; Bear in mind the setting for sub-screen item No. 03 (CMPNT OUT) of setup menu item No. 622 (SETUP 25).</p>
02 CMPNT IN	<p><b>This selects the 7.5% setup processing for the input component signal.</b></p> <p><u>0000</u> THRU: The signal is recorded in its original form.</p> <p><u>0001</u> CUT: The signal is recorded with the 7.5% setup removed.</p>
03 CMPNT OUT	<p><b>This selects the 7.5% setup processing for the output composite, component and serial (digital) signal.</b></p> <p><u>0000</u> THRU: The signal is output in its original form.</p> <p><u>0001</u> CUT: The signal is output with the 7.5% setup removed.</p> <p><u>0002</u> ADD: The signal is output with the 7.5% setup added.</p>

The underlined items indicates the initial setting.

# Setup menus (continued)

## USER menu <VIDEO>

No./Item	Description
623 SETUP 50	<p><b>For setting 7.5% setup processing to be performed on input and output signals in the DVCPRO50 (50 Mbps) mode.</b></p> <p>When the STOP button is pressed, operation is transferred to the sub-screen, and the setup level is set for each output. To return from the sub-screen, press the STOP button again.</p> <p><b>&lt;Note&gt;</b> This setup menu is not displayed in the 625i system.</p>
<b>Sub-screen</b>	
00 CMPST IN	<p><b>This selects the 7.5% setup processing for the input composite signal.</b></p> <p><u>0000</u> THRU : The signal is recorded in its original form.</p> <p><u>0001</u> CUT : The signal is recorded with the 7.5% setup removed.</p>
01 CMPST OUT	<p><b>This selects the 7.5% setup processing for the output composite signal.</b></p> <p><u>0000</u> THRU : The signal is output in its original form.</p> <p><u>0001</u> ADD : The signal is output with the 7.5% setup added.</p> <p><b>&lt;Note&gt;</b> Bear in mind the setting for sub-screen item No. 03 (CMPNT OUT) of setup menu item No. 623 (SETUP 50).</p>
02 CMPNT IN	<p><b>This selects the 7.5% setup processing for the input component signal.</b></p> <p><u>0000</u> THRU : The signal is recorded in its original form.</p> <p><u>0001</u> CUT : The signal is recorded with the 7.5% setup removed.</p>
03 CMPNT OUT	<p><b>This selects the 7.5% setup processing for the output composite, component and serial (digital) signal.</b></p> <p><u>0000</u> THRU : The signal is output in its original form.</p> <p><u>0001</u> CUT : The signal is output with the 7.5% setup removed.</p> <p><u>0002</u> ADD : The signal is output with the 7.5% setup added.</p>

No./Item	Description
624 CC REC	<p><b>For selecting whether to record the closed caption signals multiplexed on the input signals on the tape.</b></p> <p><u>0000</u> OFF : No closed caption signal is recorded. In addition, the EE output signals are blanked.</p> <p><u>0001</u> ON : When a closed caption signal is detected from the selected input signal, it can be recorded.</p> <p><b>&lt;Notes&gt;</b></p> <ul style="list-style-type: none"> <li>● If 1394 signals have been selected as the input signals, the closed caption signals which have been multiplexed onto the input signals will be recorded on the tape regardless of the setting.</li> <li>● This setup menu is not displayed in the 625i system.</li> </ul>
645 WIDE SELECT	<p><b>This selects whether or not to record the wide-screen information on the tape.</b></p> <p><u>0001</u> WIDE : The wide-screen information is recorded on the tape.</p> <p><u>0002</u> NORMAL : The wide-screen information is not recorded on the tape.</p> <p><b>&lt;Notes&gt;</b></p> <ul style="list-style-type: none"> <li>● If 1394 has been selected as the input signals using the INPUT SELECT button, the wide-screen information on the input signals will be recorded regardless of this menu's setting.</li> <li>● The aspect ratio cannot be changed by this unit.</li> </ul>

The underlined items indicates the initial setting.

## Setup menus (continued)

### USER menu <VIDEO>

No./Item	Description														
660 UMID REC	<p><b>This selects whether or not to record the UMID information on the tape.</b></p> <p><b>0000 OFF:</b> UMID information is not recorded on the tape. In addition, EE output signals are blanked.</p> <p><b>0001 ON:</b> UMID information is recorded on the tape.</p> <p><b>&lt;Notes&gt;</b></p> <ul style="list-style-type: none"> <li>• If 1394 has been selected as the input signals using the INPUT SELECT button, the UMID information on the input signals will be recorded regardless of this menu's setting.</li> <li>• If THRU has been selected as the setup menu item No. 106 (EE MODE SEL) setting, UMID information of the EE output signals will be blanked.</li> <li>• The UMID information cannot be rewritten by this unit.</li> </ul>														
661 UMID GEN	<p><b>This selects the basic UMID information to be recorded on the tape when ON has been selected as the setup menu item No. 660 (UMID REC) setting.</b></p> <p><b>0000 INT:</b> Newly created basic UMID information of this unit is always recorded.</p> <p><b>0001 EXT:</b> The basic UMID information of the input signals is recorded. Newly created basic UMID information of this unit is recorded if there is no basic UMID information on the input signals.</p> <p><b>&lt;Notes&gt;</b></p> <ul style="list-style-type: none"> <li>• The source pack (of the UMID information) of the input signal will be recorded on the tape, regardless of this menu's setting.</li> <li>• The UMID information cannot be rewritten by this unit.</li> </ul>														
662 UMID POS	<p><b>This sets the line on which the UMID information is to be superimposed.</b></p> <table> <tr> <td>[625i system]</td> <td>[525i system]</td> </tr> <tr> <td><b>0000 BLANK</b></td> <td><b>0000 BLANK</b></td> </tr> <tr> <td><b>0001 8L</b></td> <td><b>0001 12L</b></td> </tr> <tr> <td>:</td> <td>:</td> </tr> <tr> <td><b>0010 17L</b></td> <td><b>0006 17L</b></td> </tr> <tr> <td>:</td> <td>:</td> </tr> <tr> <td><b>0015 22L</b></td> <td><b>0008 19L</b></td> </tr> </table> <p><b>&lt;Note&gt;</b> The line selected for the setup menu item No. 501 (VITC POS-1) and No. 502 (VITC POS-2) settings cannot be selected for this item.</p>	[625i system]	[525i system]	<b>0000 BLANK</b>	<b>0000 BLANK</b>	<b>0001 8L</b>	<b>0001 12L</b>	:	:	<b>0010 17L</b>	<b>0006 17L</b>	:	:	<b>0015 22L</b>	<b>0008 19L</b>
[625i system]	[525i system]														
<b>0000 BLANK</b>	<b>0000 BLANK</b>														
<b>0001 8L</b>	<b>0001 12L</b>														
:	:														
<b>0010 17L</b>	<b>0006 17L</b>														
:	:														
<b>0015 22L</b>	<b>0008 19L</b>														

The underlined items indicates the initial setting.

# Setup menus (continued)

## USER menu <AUDIO>

No./Item	Description
701 CH1 IN LV	This selects the audio input (CH1) reference level switching.  0000 4dB <u>0001</u> 0dB 0002 -20dB
702 CH2 IN LV	This selects the audio input (CH2) reference level switching.  0000 4dB <u>0001</u> 0dB 0002 -20dB
703 CH3 IN LV	This selects the audio input (CH3) reference level switching.  0000 4dB <u>0001</u> 0dB 0002 -20dB
704 CH4 IN LV	This selects the audio input (CH4) reference level switching.  0000 4dB <u>0001</u> 0dB 0002 -20dB
706 CH1 OUT LV	This selects the audio output (CH1) reference level switching.  0000 4dB <u>0001</u> 0dB 0002 -20dB
707 CH2 OUT LV	This selects the audio output (CH2) reference level switching.  0000 4dB <u>0001</u> 0dB 0002 -20dB
708 CH3 OUT LV	This selects the audio output (CH3) reference level switching.  0000 4dB <u>0001</u> 0dB 0002 -20dB
709 CH4 OUT LV	This selects the audio output (CH4) reference level switching.  0000 4dB <u>0001</u> 0dB 0002 -20dB

No./Item	Description
711 MONIL OUT LV	This selects the audio monitor output (Lch) reference level switching.  0000 4dB <u>0001</u> 0dB 0002 -20dB
712 MONIR OUT LV	This selects the audio monitor output (Rch) reference level switching.  0000 4dB <u>0001</u> 0dB 0002 -20dB
713 MONI OUT	This selects whether or not to couple the volume level of the audio monitor output with the volume control of the headphone jack.  0000 <u>UNITY</u> : Volume is output at a fixed level, regardless of the position of the volume control. 0001 <u>VAR</u> : Audio monitor output volume is coupled to the volume control.
715 CH1 IN SEL	This selects the CH1 input when USER SET has been selected by pressing the unit's AUDIO input selector button.  0000 <u>ANA</u> : Analog input. 0001 <u>DIGI</u> : Digital input.
716 CH2 IN SEL	This selects the CH2 input when USER SET has been selected by pressing the unit's AUDIO input selector button.  0000 <u>ANA</u> : Analog input. 0001 <u>DIGI</u> : Digital input.
717 CH3 IN SEL	This selects the CH3 input when USER SET has been selected by pressing the unit's AUDIO input selector button.  0000 <u>ANA</u> : Analog input. 0001 <u>DIGI</u> : Digital input.
718 CH4 IN SEL	This selects the CH4 input when USER SET has been selected by pressing the unit's AUDIO input selector button.  0000 <u>ANA</u> : Analog input. 0001 <u>DIGI</u> : Digital input.
719 D IN SEL12	This selects the CH1 and CH2 digital input when USER SET has been selected by pressing the unit's AUDIO input selector button.  0000 <u>AES</u> : AES/EBU input 0001 <u>SIF</u> : SDI input
720 D IN SEL34	This selects the CH3 and CH4 digital input when USER SET has been selected by pressing the unit's AUDIO input selector button.  0000 <u>AES</u> : AES/EBU input 0001 <u>SIF</u> : SDI input

The underlined items indicates the initial setting.

# Setup menus (continued)

## USER menu <AUDIO>

No./Item	Description
721 MONI CH SEL	<p>This selects the monitor output.</p> <p><u>0000</u> <b>MANU</b> : The output signal is as selected in MONITOR SELECT buttons.</p> <p><u>0001</u> <b>AUTO</b> : PCM AUDIO output is selected within the <math>-0.43 (-0.5) \times</math> to <math>+1 \times</math> speed range; CUE is automatically selected for all other tape speeds.</p> <p>&lt;Note&gt; The value for the DV/DVCAM tape is shown in parenthesis ( ).</p> <p><u>0002</u> <b>PCM</b> : The PCM AUDIO signal is output over the <math>-10 \times</math> to <math>+10 \times</math> range.</p> <p>&lt;Note&gt; This setup menu's setting takes effect when CH1, CH2, CH3 or CH4 has been selected by the L and R MONITOR SELECT buttons on the front panel. (If CUE has been selected, the cue signal will be output at all the speeds regardless of the setup menu's setting.)</p>
726 REC CUE	<p>This selects the input signal recorded in CUE.</p> <p><u>0001</u> <b>CH1</b> : Audio CH1 input  <u>0002</u> <b>CH2</b> : Audio CH2 input  <u>0003</u> <b>CH1+2</b> : Audio CH1 and CH2 MIX signal  <u>0004</u> <b>CH3</b> : Audio CH3 input  <u>0005</u> <b>CH4</b> : Audio CH4 input  <u>0006</u> <b>CH3+4</b> : Audio CH3 and CH4 MIX signal  <u>0007</u> <b>CH1-4</b> : Audio CH1, CH2, CH3 and CH4 mixed signals</p>
727 PB FADE	<p>This selects the processing method for the audio edit points (IN point, OUT point) during playback.</p> <p><u>0000</u> <b>AUTO</b> : According to the status during recording.  <u>0001</u> <b>CUT</b> : Forced CUT  <u>0002</u> <b>FADE</b> : Forced FADE</p>
728 EMBEDDED AUD	<p>This selects whether to superimpose the audio data onto the SDI output.</p> <p><u>0000</u> <b>OFF</b> : Data is not superimposed.  <u>0001</u> <b>ON</b> : Data is superimposed.</p>

No./Item	Description
731 CUE OUT SEL	<p>This selects whether or not the cue signal is to be output to the main line output in the search mode.</p> <p><u>0000</u> <b>OFF</b> : CUE is not output.  <u>0001</u> <b>ON</b> : CUE is output.</p> <p>&lt;Notes&gt;  <ul style="list-style-type: none"> <li>This function works only when a setting other than MANU has been selected by setup menu No. 721 (MONI CH SEL).</li> <li>The main signal system output channels used for the CUE output differ depending on the setting selected by setup menu No. 735 (MON AUTO SEL).  When L/R is selected:  CUE is output to CH1 to CH4.  When L is selected:  CUE is output to CH1 and CH3.  When R is selected:  CUE is output to CH2 and CH4.</li> </ul> <ul style="list-style-type: none"> <li>When PCM has been selected as the setup menu No. 721 (MONI CH SEL) setting, PCM is output.</li> </ul> </p>
733 CUE OUT	<p>This selects the timing for the output picture and CUE output when CUE has been selected for monitor output.</p> <p><u>0000</u> <b>NORMAL</b> : The timing is aligned with the output picture.  <u>0001</u> <b>DIRECT</b> : Whatever has been recorded on the tape is output with no delay.</p> <p>&lt;Note&gt; When DIRECT has been selected, the timing of the output picture and that of the cue output are not aligned properly.</p>
734 MONI SEL INH	<p>This selects whether the operation of the AUDIO MON SEL button on the front panel is to be enabled or disabled.</p> <p><u>0000</u> <b>OFF</b> : Operation is enabled.  <u>0001</u> <b>ON</b> : Operation is disabled.  <u>0002</u> <b>ON1</b> :  Operation is disabled in the FULL display mode and enabled only in the FINE display mode.</p>
735 MON AUTO SEL	<p>Although CUE is automatically output to the monitor output in accordance with the operation mode when a setting AUTO has been selected by setup menu item No. 721 (MONI CH SEL), the MON AUTO SEL setup menu item is used to select the monitor channel which is to be automatically switched to CUE.</p> <p><u>0000</u> <b>L/R</b> :  CUE is output to both the left and right channels.  <u>0001</u> <b>L</b> :  CUE is output to the left channel only.  <u>0002</u> <b>R</b> :  CUE is output to the right channel only.</p>

The underlined items indicates the initial setting.



## Setup menus (continued)

### USER menu <AUDIO>

No./Item	Description
750 DV PB ATT	<p>This selects the audio output level during DV playback.</p> <p><b>0000</b> OFF: The audio output level is not attenuated.</p> <p><u>0001</u> ON: The audio output level is attenuated (reduced).</p>
751 REC PT MUTE	<p>This selects whether to mute the sound where recordings are joined during DV/DVCAM playback.</p> <p><b>0000</b> OFF: The sound is not muted.</p> <p><u>0001</u> ON: The sound is muted.</p>

The underlined items indicates the initial setting.

#### <Concerning the CUE output in the search mode>

The table below shows how the CUE output to the monitor and main signal system outputs differs according to how the setup menu item (No. 721, No. 731 and No. 735) settings are combined.

731 CUE OUT SEL	721 MONI CH SEL	735 MON AUTO SEL	Monitor output		Main signal system output			
			Lch	Rch	CH1	CH2	CH3	CH4
OFF	MANU	—	PCM *1	PCM *1	PCM *1	PCM *1	PCM *1	PCM *1
	AUTO	L/R	CUE	CUE				
		L	CUE	PCM *1				
		R	PCM *1	CUE				
PCM	—	PCM *2	PCM *2	PCM *2	PCM *2	PCM *2	PCM *2	
ON	MANU	—	PCM *1	PCM *1	PCM *1	PCM *1	PCM *1	PCM *1
	AUTO	L/R	CUE	CUE	CUE	CUE	CUE	CUE
		L	CUE	PCM *1	CUE	PCM *1	CUE	PCM *1
		R	PCM *1	CUE	PCM *1	CUE	PCM *1	CUE
PCM	—	PCM *2	PCM *2	PCM *2	PCM *2	PCM *2	PCM *2	

#### <Notes>

\*1: PCM audio signal output is muted when the VTR is played outside the -0.43 to +1 normal speed.

\*2: PCM audio signal output is muted when the VTR is played outside the -10 to +10 normal speed.

When either AUTO is selected, the PCM audio signal is output within -0.43 to +1 normal speed even in the automatic CUE output mode.

# Setup menus (continued)

## USER menu <V BLANK>

No./Item	Description																		
<b>800</b>	<b>For selecting the mode for recording signals on additional lines.</b>																		
<b>ADD LINE 25</b>																			
0000	<b>OFF</b> : No signals are recorded on additional lines.																		
0001	<b>YC422</b> : The 422 mode signals are recorded on 1 line.																		
0002	<b>YC411</b> : The 411 mode signals are recorded on 1 line.																		
0003	<b>Y1_B/W</b> : Only the Y signal is recorded on 1 line directly.																		
0004	<b>Y1_BPF</b> : Only the Y signal is recorded on 1 line after it has been separated from the C signal.																		
0005	<b>C1</b> : Only the C signal is recorded on 1 line.																		
0006	<b>Y2_B/W</b> : Only the Y signal is recorded on 2 lines directly.																		
0007	<b>Y2_BPF</b> : Only the Y signal is recorded on 2 lines after it has been separated from the C signal.																		
0008	<b>C2</b> : Only the C signal is recorded on 2 lines.																		
	<b>&lt;Notes&gt;</b>																		
	<ul style="list-style-type: none"> <li>When a setting from "0001 (YC422)" to "0008 (C2)" is selected and the STOP button is pressed, operation transfers to the sub-screen, and the recording line or lines can be selected.</li> <li>To return from the sub-screen, press the STOP button again.</li> <li>The setting takes effect when the system format is 25 Mbps.</li> </ul>																		
<b>Sub-screen</b>																			
<b>00</b> <b>REC LINE1</b>	<b>For selecting the additional line where the signals are to be recorded.</b>																		
	<table> <thead> <tr> <th>[625i system]</th> <th>[525i system]</th> </tr> </thead> <tbody> <tr> <td>0000 7L</td> <td>0000 10L</td> </tr> <tr> <td>:</td> <td>:</td> </tr> <tr> <td>0015 22L</td> <td>0012 22L</td> </tr> <tr> <td>0016 320L</td> <td>0013 263L</td> </tr> <tr> <td>:</td> <td>:</td> </tr> <tr> <td>0031 335L</td> <td>:</td> </tr> <tr> <td>0032 623L</td> <td>0025 284L</td> </tr> <tr> <td></td> <td>0026 525L</td> </tr> </tbody> </table>	[625i system]	[525i system]	0000 7L	0000 10L	:	:	0015 22L	0012 22L	0016 320L	0013 263L	:	:	0031 335L	:	0032 623L	0025 284L		0026 525L
[625i system]	[525i system]																		
0000 7L	0000 10L																		
:	:																		
0015 22L	0012 22L																		
0016 320L	0013 263L																		
:	:																		
0031 335L	:																		
0032 623L	0025 284L																		
	0026 525L																		

No./Item	Description																						
<b>Sub-screen</b>																							
<b>01</b> <b>REC LINE2</b>	<b>For selecting the additional line where the signals are to be recorded.</b>																						
	<table> <thead> <tr> <th>[625i system]</th> <th>[525i system]</th> </tr> </thead> <tbody> <tr> <td>0000 7L</td> <td>0000 10L</td> </tr> <tr> <td>:</td> <td>:</td> </tr> <tr> <td>0015 22L</td> <td>0012 22L</td> </tr> <tr> <td>0016 320L</td> <td>0013 263L</td> </tr> <tr> <td>:</td> <td>:</td> </tr> <tr> <td>0018 322L</td> <td>:</td> </tr> <tr> <td>:</td> <td>:</td> </tr> <tr> <td>0031 335L</td> <td>0016 275L</td> </tr> <tr> <td>0032 623L</td> <td>0025 284L</td> </tr> <tr> <td></td> <td>0026 525L</td> </tr> </tbody> </table>	[625i system]	[525i system]	0000 7L	0000 10L	:	:	0015 22L	0012 22L	0016 320L	0013 263L	:	:	0018 322L	:	:	:	0031 335L	0016 275L	0032 623L	0025 284L		0026 525L
[625i system]	[525i system]																						
0000 7L	0000 10L																						
:	:																						
0015 22L	0012 22L																						
0016 320L	0013 263L																						
:	:																						
0018 322L	:																						
:	:																						
0031 335L	0016 275L																						
0032 623L	0025 284L																						
	0026 525L																						
	<b>&lt;Note&gt;</b>																						
	This menu item is not displayed when additional line mode setting "1" through "5" has been selected.																						

The underlined items indicates the initial setting.

# Setup menus (continued)

## USER menu <V BLANK>

No./Item	Description
801	<p><b>For selecting the mode for recording signals on additional lines.</b></p> <p><b>ADD LINE 50</b></p> <p>0000 OFF: No signals are recorded on additional lines.</p> <p>0001 <u>YC422</u>: The 422 mode signals are recorded on 2 lines.</p> <p>0002 Y4_B/W: Only the Y signal is recorded on 4 lines directly.</p> <p>0003 Y4_BPF: Only the Y signal is recorded on 4 lines after it has been separated from the C signal.</p> <p>0004 C4: Only the C signal is recorded on 4 lines.</p> <p>&lt;Notes&gt;</p> <ul style="list-style-type: none"> <li>When a setting from "0001 (YC422)" to "0004 (C4)" is selected and the STOP button is pressed, operation transfers to the sub-screen, and the recording lines can be selected.</li> <li>To return from the sub-screen, press the STOP button again.</li> <li>The setting takes effect when the system format is 50 Mbps.</li> </ul>
<b>Sub-screen</b>	
00 REC LINE1	<p><b>For selecting the additional line where the signals are to be recorded.</b></p> <p>[625i system] [525i system]</p> <p>0000 7L 0000 10L</p> <p>: : : :</p> <p>0015 22L 0012 22L</p> <p>0016 320L 0013 263L</p> <p>: : 0014 273L</p> <p>0031 335L : :</p> <p>0032 <u>623L</u> 0025 284L</p> <p>0026 525L</p>
01 REC LINE2	<p><b>For selecting the additional line where the signals are to be recorded.</b></p> <p>[625i system] [525i system]</p> <p>0000 7L 0000 10L</p> <p>: : : :</p> <p>0015 22L 0012 22L</p> <p>0016 320L 0013 263L</p> <p>: : 0014 273L</p> <p>0018 <u>322L</u> : :</p> <p>: : 0016 275L</p> <p>0031 335L : :</p> <p>0032 623L 0025 284L</p> <p>0026 525L</p>

No./Item	Description
<b>Sub-screen</b>	
02 REC LINE3	<p><b>For selecting the additional line where the signals are to be recorded.</b></p> <p>[625i system] [525i system]</p> <p>0000 7L 0000 10L</p> <p>: : : :</p> <p>0003 <u>10L</u> 0003 13L</p> <p>: : : :</p> <p>0015 22L 0012 22L</p> <p>0016 320L 0013 263L</p> <p>: : 0014 273L</p> <p>0031 335L : :</p> <p>0032 623L 0025 284L</p> <p>0026 525L</p> <p>&lt;Note&gt;</p> <p>This menu item is not displayed when setting "1" has been selected as the additional line mode.</p>
03 REC LINE4	<p><b>For selecting the additional line where the signals are to be recorded.</b></p> <p>[625i system] [525i system]</p> <p>0000 7L 0000 10L</p> <p>: : : :</p> <p>0015 22L 0012 22L</p> <p>0016 320L 0013 263L</p> <p>: : 0014 273L</p> <p>0019 <u>323L</u> : :</p> <p>: : 0017 276L</p> <p>0031 335L : :</p> <p>0032 623L 0025 284L</p> <p>0026 525L</p> <p>&lt;Note&gt;</p> <p>This menu item is not displayed when setting "1" has been selected as the additional line mode.</p>
802	<p><b>For selecting the type of teletext signals to be recorded.</b></p> <p><b>TELETEXT SEL</b></p> <p>0000 MOJI: MOJI system</p> <p>0001 <u>NABTS</u>: NABTS system</p> <p>&lt;Notes&gt;</p> <ul style="list-style-type: none"> <li>This setup menu is not displayed in the 625i system.</li> <li>VITC signals are often mistakenly detected as teletext signals when the NABTS system has been selected.</li> </ul> <p>If this happens, select MANU as the setting for setup menu No. 803 (TELETEXT DET), then select the line for teletext signals.</p>

The underlined items indicates the initial setting.

# Setup menus (continued)

## USER menu <V BLANK>

No./Item	Description																																				
803 TELETEXT DET	<p>For selecting the method used to detect the lines in which the teletext signals are to be recorded.</p> <p><u>0000 OFF</u> : The teletext signals are not recorded.</p> <p><u>0001 AUTO</u> : The teletext signals are automatically detected and recorded.</p> <p><u>0002 MANU</u> : The lines in which the teletext signals are to be recorded are selected and set.</p> <p>&lt;Notes&gt;</p> <ul style="list-style-type: none"> <li>The number of lines in which the teletext signals can be recorded depends on the number of recording lines which was entered as the setup menu No. 800 (ADD LINE 25) or No. 801 (ADD LINE 50) setting. [See "Number of lines which can be set for teletext."] </li> <li>When setting "MANU" is selected and the STOP button is pressed, operation transfers to the sub-screen, and the number of recording lines can be selected. To return from the sub-screen, press the STOP button again.</li> <li>When the input signal is a non-standard signal or N-STD has been selected for the setup menu No. 303 (STD/NONSTD) setting, teletext signals will not be played back correctly in EE mode.</li> </ul>																																				
<b>Sub-screen</b>																																					
[625i system] <u>00</u> REC LINE1 : 14 REC LINE15	<p>For selecting the lines in which the teletext signals are to be recorded.</p> <table border="0"> <tr> <td>[625i system]</td> <td>[525i system]</td> </tr> <tr> <td><u>0000 OFF</u></td> <td><u>0000 OFF</u></td> </tr> <tr> <td>0001 7&amp;320</td> <td>0001 10&amp;273</td> </tr> <tr> <td>0002 8&amp;321</td> <td>0002 11&amp;274</td> </tr> <tr> <td>0003 9&amp;322</td> <td>0003 12&amp;275</td> </tr> <tr> <td>0004 10&amp;323</td> <td>0004 13&amp;276</td> </tr> <tr> <td>0005 11&amp;324</td> <td>0005 14&amp;277</td> </tr> <tr> <td>0006 12&amp;325</td> <td>0006 15&amp;278</td> </tr> <tr> <td>0007 13&amp;326</td> <td>0007 16&amp;279</td> </tr> <tr> <td>0008 14&amp;327</td> <td>0008 17&amp;280</td> </tr> <tr> <td>0009 15&amp;328</td> <td>0009 18&amp;281</td> </tr> <tr> <td>0010 16&amp;329</td> <td>0010 19&amp;282</td> </tr> <tr> <td>0011 17&amp;330</td> <td>0011 20&amp;283</td> </tr> <tr> <td>0012 18&amp;331</td> <td>0012 21&amp;284</td> </tr> <tr> <td>0013 19&amp;332</td> <td>0013 22</td> </tr> <tr> <td>0014 20&amp;333</td> <td></td> </tr> <tr> <td>0015 21&amp;334</td> <td></td> </tr> <tr> <td>0016 22</td> <td></td> </tr> </table>	[625i system]	[525i system]	<u>0000 OFF</u>	<u>0000 OFF</u>	0001 7&320	0001 10&273	0002 8&321	0002 11&274	0003 9&322	0003 12&275	0004 10&323	0004 13&276	0005 11&324	0005 14&277	0006 12&325	0006 15&278	0007 13&326	0007 16&279	0008 14&327	0008 17&280	0009 15&328	0009 18&281	0010 16&329	0010 19&282	0011 17&330	0011 20&283	0012 18&331	0012 21&284	0013 19&332	0013 22	0014 20&333		0015 21&334		0016 22	
[625i system]	[525i system]																																				
<u>0000 OFF</u>	<u>0000 OFF</u>																																				
0001 7&320	0001 10&273																																				
0002 8&321	0002 11&274																																				
0003 9&322	0003 12&275																																				
0004 10&323	0004 13&276																																				
0005 11&324	0005 14&277																																				
0006 12&325	0006 15&278																																				
0007 13&326	0007 16&279																																				
0008 14&327	0008 17&280																																				
0009 15&328	0009 18&281																																				
0010 16&329	0010 19&282																																				
0011 17&330	0011 20&283																																				
0012 18&331	0012 21&284																																				
0013 19&332	0013 22																																				
0014 20&333																																					
0015 21&334																																					
0016 22																																					
[525i system] <u>00</u> REC LINE1 : 12 REC LINE13	<table border="0"> <tr> <td>[625i system]</td> <td>[525i system]</td> </tr> <tr> <td><u>0000 OFF</u></td> <td><u>0000 OFF</u></td> </tr> <tr> <td>0001 7&amp;320</td> <td>0001 10&amp;273</td> </tr> <tr> <td>0002 8&amp;321</td> <td>0002 11&amp;274</td> </tr> <tr> <td>0003 9&amp;322</td> <td>0003 12&amp;275</td> </tr> <tr> <td>0004 10&amp;323</td> <td>0004 13&amp;276</td> </tr> <tr> <td>0005 11&amp;324</td> <td>0005 14&amp;277</td> </tr> <tr> <td>0006 12&amp;325</td> <td>0006 15&amp;278</td> </tr> <tr> <td>0007 13&amp;326</td> <td>0007 16&amp;279</td> </tr> <tr> <td>0008 14&amp;327</td> <td>0008 17&amp;280</td> </tr> <tr> <td>0009 15&amp;328</td> <td>0009 18&amp;281</td> </tr> <tr> <td>0010 16&amp;329</td> <td>0010 19&amp;282</td> </tr> <tr> <td>0011 17&amp;330</td> <td>0011 20&amp;283</td> </tr> <tr> <td>0012 18&amp;331</td> <td>0012 21&amp;284</td> </tr> <tr> <td>0013 19&amp;332</td> <td>0013 22</td> </tr> <tr> <td>0014 20&amp;333</td> <td></td> </tr> <tr> <td>0015 21&amp;334</td> <td></td> </tr> <tr> <td>0016 22</td> <td></td> </tr> </table>	[625i system]	[525i system]	<u>0000 OFF</u>	<u>0000 OFF</u>	0001 7&320	0001 10&273	0002 8&321	0002 11&274	0003 9&322	0003 12&275	0004 10&323	0004 13&276	0005 11&324	0005 14&277	0006 12&325	0006 15&278	0007 13&326	0007 16&279	0008 14&327	0008 17&280	0009 15&328	0009 18&281	0010 16&329	0010 19&282	0011 17&330	0011 20&283	0012 18&331	0012 21&284	0013 19&332	0013 22	0014 20&333		0015 21&334		0016 22	
[625i system]	[525i system]																																				
<u>0000 OFF</u>	<u>0000 OFF</u>																																				
0001 7&320	0001 10&273																																				
0002 8&321	0002 11&274																																				
0003 9&322	0003 12&275																																				
0004 10&323	0004 13&276																																				
0005 11&324	0005 14&277																																				
0006 12&325	0006 15&278																																				
0007 13&326	0007 16&279																																				
0008 14&327	0008 17&280																																				
0009 15&328	0009 18&281																																				
0010 16&329	0010 19&282																																				
0011 17&330	0011 20&283																																				
0012 18&331	0012 21&284																																				
0013 19&332	0013 22																																				
0014 20&333																																					
0015 21&334																																					
0016 22																																					

No./Item	Description
804 BLANK LINE	<p>This turns the blanking ON or OFF in the vertical blanking period of the video output signals.</p> <p><u>0000 BLANK</u> : Blanking is effected forcibly for all lines.</p> <p><u>0001 THRU</u> : No blanking is effected for any of the lines.</p> <p><u>0002 MANU</u> : Blanking ON or OFF is selected for each line.</p> <p>&lt;Note&gt; When setting "MANU" is selected and the STOP button is pressed, operation transfers to the sub-screen, and ON or OFF can be selected for each line. To return from the sub-screen, press the STOP button again.</p>
<b>Sub-screen</b>	
[625i system] <u>00</u> LINE 7&320 : 15 LINE 22&335	<p><u>0000 BLANK</u> : Blanking is forcibly effected.</p> <p><u>0001 THRU</u> : No blanking is effected.</p>
[525i system] <u>00</u> LINE 10&273 : 11 LINE 21&284	

### Number of lines which can be set for TELETEXT

The number of lines differs, depending on whether ON or OFF has been selected for the setup menu item No. 660 (UMID REC) setting.

- When 25 Mbps is the recording/playback format.

No. 800: ADD LINE 25 setting value	Number of lines which can be set			
	[625i system]		[525i system]	
	UMID REC: ON	UMID REC: OFF	UMID REC: ON	UMID REC: OFF
OFF	12	14	10	13
YC422	5	7	4	5
YC411	8	10	5	8
Y1_B/W, Y1_BPF, C1	12	14	10	13
Y2_B/W, Y2_BPF, C2	5	7	4	5

- When 50 Mbps is the recording/playback format.

No. 801: ADD LINE 50 setting value	Number of lines which can be set			
	[625i system]		[525i system]	
	UMID REC: ON	UMID REC: OFF	UMID REC: ON	UMID REC: OFF
OFF, YC422, Y4_B/W, Y4_BPF, C4	12	15	9	10

The underlined items indicates the initial setting.

# Setup menus (continued)

## USER menu <LCD>

No./Item	Description
900 LCD PROTECT	<p>This sets the LCD monitor's saving function (see page 11).</p> <p><b>0000 OFF :</b> The saving function is not established.</p> <p><b>0001 ON :</b> The saving function is established.</p>
901 BL BRIGHT	<p>This sets the brightness of the LCD monitor's backlight.</p> <p><b>0000 NORMAL :</b> The backlight lights at the normal brightness.</p> <p><b>0001 HIGH :</b> The backlight lights more brightly than normal.</p>

## USER menu <MENU>

No./Item	Description
A00 LOAD	<p>This selects the user file whose contents will be loaded into USER1.</p> <p><b>0000 USER2 :</b> The USER2 file contents are loaded.</p> <p><b>0001 USER3 :</b> The USER3 file contents are loaded.</p> <p><b>0002 USER4 :</b> The USER4 file contents are loaded.</p> <p><b>0003 USER5 :</b> The USER5 file contents are loaded.</p> <p>&lt;Note&gt; When the SET button is pressed after loading, the setting will be stored in the memory. When the MENU button is pressed, the setting will not be changed.</p>
A01 SAVE	<p>This selects the user file into which the USER1 settings will be saved.</p> <p><b>0000 USER2 :</b> The settings are saved in USER2.</p> <p><b>0001 USER3 :</b> The settings are saved in USER3.</p> <p><b>0002 USER4 :</b> The settings are saved in USER4.</p> <p><b>0003 USER5 :</b> The settings are saved in USER5.</p> <p><b>0004 LOCKED :</b> This display appears when all the user files are in the change prohibit status.</p> <p>&lt;Notes&gt;</p> <ul style="list-style-type: none"> <li>• User files whose status have been set to change prohibit cannot be selected.</li> <li>• When all the user files are in the change prohibit status, the "LOCKED" display appears and the contents cannot be saved.</li> </ul>

No./Item	Description
A02 P. ON LOAD	<p>This loads the contents of the selected user file into USER1 and it starts operation with the USER1 settings when the power is turned on.</p> <p><b>0000 OFF :</b> Operation is started with the settings of the previously set user file.</p> <p><b>0001 USER2 :</b> The contents of USER2 are loaded into USER1 and operation is started with the USER1 settings.</p> <p><b>0002 USER3 :</b> The contents of USER3 are loaded into USER1 and operation is started with the USER1 settings.</p> <p><b>0003 USER4 :</b> The contents of USER4 are loaded into USER1 and operation is started with the USER1 settings.</p> <p><b>0004 USER5 :</b> The contents of USER5 are loaded into USER1 and operation is started with the USER1 settings.</p>
A03 MENU LOCK	<p>This selects whether to set or release the user file (USER2 – USER5) lock mode.</p> <p><b>0000 OFF :</b> The lock is released (changes can be made).</p> <p><b>0001 ON :</b> The lock is set (changes are prohibited).</p> <p>&lt;Note&gt; The lock cannot be set for USER1.</p>
A04 PF1 ASSIGN	<p>This registers the setup menu item in <b>PF1</b> (CH1 button of INSERT button).</p>
A05 PF2 ASSIGN	<p>This registers the setup menu item in <b>PF2</b> (CH2 button of INSERT button).</p>
A06 PF3 ASSIGN	<p>This registers the setup menu item in <b>PF3</b> (CH3 button of INSERT button).</p>
A07 PF4 ASSIGN	<p>This registers the setup menu item in <b>PF4</b> (CH4 button of INSERT button).</p>

### <Notes>

- No. A00 (LOAD), No. A01 (SAVE) and No. A02 (P.ON LOAD) are the menu items which can be set only for USER1. They are not displayed with the USER2 – USER5 files.
- No. A03 (MENU LOCK) is the menu item which can be set only for the USER2 – USER5 files. It is not displayed with USER1.

The underlined items indicates the initial setting.

# Time code/user bit

## Time code

The time code is used when the time code signal generated by the time code generator (time code signal generator) is to be recorded on the tape, its values are to be read by the time code reader (time code signal reader), and the absolute position of the tape is to be displayed in increments of hours, minutes, seconds and frames.

The time code is written in the sub-code area (data area) of the helical track. This enables insert editing to be conducted independently using the time code alone. In addition, the VTR's playback speed can be read from the stop mode to slow-motion playback up to high-speed play (approx. 50× normal speed/approx. 100× when using DVCPRO tape).

The time code value appears on the counter display. It is also superimposed onto the display of the TV monitor which has been connected to the VIDEO OUT 3 connector or SDI OUT 3 connector, but it does not appear on the front panel's LCD monitor.

TCR 00 : 07 : 04 : 24  
↑     ↑     ↑     ↑  
Hours Minutes Seconds Frames

## User bit

"User bit" refers to the 32-bit (8-digit) data frame among the time code signals which has been released to users. It enables operator numbers values to be recorded.

The alphanumeric characters which can be used for the user bit are the figures 0 to 9 and the letters A to F.

## Setting the internal time code

**1** Set the VTR to stop mode.

**2** Select "TC" using the COUNTER button.

**3** Use the TC (REC RUN/FREE RUN) switch to set the operation mode in which the internal time code generator is to be advanced.

### REC RUN:

The internal time code generator is advanced during recording.

The time code advances all the time when the TC (REGEN/PRESET) switch is at the REGEN position.

### FREE RUN:

When the power is on, the internal time code generator is advanced regardless of the operation mode.

**4** Use the TC (REGEN/PRESET) switch to set the regenerating mode.

### REGEN:

In this mode, the continuity of the original time code prior to editing is maintained.

- A more detailed setting can be performed using setup menu No. 503 (TCG REGEN) and No. 504 (REGEN MODE).

### PRESET:

In this mode, recording is commenced from the value which was set by the **TC PRESET** (SHIFT+PLAYER).

- During automatic editing, whatever has been selected for the menu No. 504 setting is used for regeneration even when the TCG switch has been set to PRESET.

**5** Use the **TC PRESET** (SHIFT+PLAYER) to set the start number of the time code or user bit.

① Press the **TC PRESET** (SHIFT+PLAYER). The left-most set of digits starts flashing.

② To change the value, turn the search dial while holding down the search button.

③ Turn the search dial to select the set of digits that is to be set. The digits selected start flashing.

The setting ranges are as follows:

- Time code:
  - [625i system]  
00:00:00:00 to 23:59:59:24
  - [525i system]  
00:00:00:00 to 23:59:59:29

- User bit:  
00:00:00:00 to FF FF FF FF

④ Repeat steps ② and ③ to change any other values.

⑤ Once the start number has been set, press the SET button.

In the FREE RUN mode, the time code begins to advance.

⑥ Proceed with the recording or editing.

## Time code/user bit (continued)

### Setting the external time code

- 1 Set the VTR to stop mode.
- 2 Select "TC" using the COUNTER button.
- 3 Set the TCG switch to EXT. (External time code selection)
- 4 The following settings can be selected with setup menu No. 505 (EXT TC SEL).

#### LTC:

The LTC signal input to the TIME CODE IN connector (XLR) on the rear panel is recorded as TC.

#### <Note>

LTC must be synchronized with the video signal.

#### VITC:

The VITC of the input video signal is recorded as TC.

### Reproducing the time code/user bit

- 1 Set the VTR to stop mode.
- 2 Select "TC" or "UB" using the COUNTER button.
- 3 Press the PLAY button.  
Playback starts and the time code is shown on the display.  
When the SUPER switch is set to ON, the time code value is superimposed on the video signals from the VIDEO OUT 3/SDI OUT 3 connector.

#### <Note>

When the time code signal cannot be read, the time code is automatically interpolated by the CTL signal. The display appears as shown below.

T \* R 00:01:04:07\*

When the time code signal cannot be read, an asterix (\*) is displayed.

" ": 1, 3 field  
"\*": 2, 4 field

The colon between the seconds and frames changes to a period during drop frame mode.

# Superimpose screen

The control signals, time code, etc. are displayed using abbreviations.

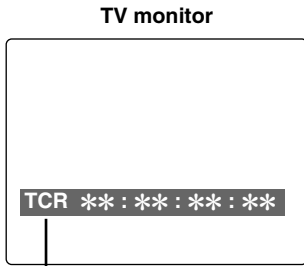

**Abbreviations:**

- CTL** : Control signal count value
- TCR** : Time code data recorded in the SBC area
- TCR.** : Time code data recorded in the VAUX area
- UBR** : User bit data recorded in the SBC area
- UBR.** : User bit data recorded in the VAUX area
- TCG** : Time code data of the time code generator
- UBG** : User bit data of the time code generator

**<Note>**

[T\*R], [T\*R.], [U\*R] or [U\*R.] is displayed when the data has not been read correctly from the tape.

**Characters displayed**

The background of characters superimposed on the display can be changed using setup menu No. 011 (CHARA TYPE).



TV monitor

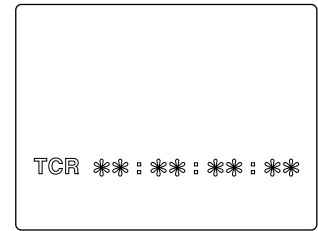

TV monitor

**Display position**

The position of the characters superimposed on the display can be changed using setup menus No. 009 (CHARA H-POS) and No. 010 (CHARA V-POS).



TV monitor



TV monitor

**Operation mode**

The VTR's operation mode can also be displayed using setup menu No. 008 (DISPLAY SEL).



TV monitor

VTR operation mode



# Video output signals and servo reference signal

This section explains how the output signals and servo reference signal are selected.

## External synchronization of video output signals

The video output signals are output in synchronization with the REF VIDEO input signal or video input signal. As shown in the figure below, this signal is selected in accordance with the setup menu settings, VTR mode and availability of the video input signal.

### <Notes>

Synchronization is determined as follows depending on the availability of the REF VIDEO input signal when "BB", "CB100" or "CB75" has been selected as the setup menu No. 600 (INT SG) setting.

- When the REF VIDEO input signal is available: Synchronization with the REF VIDEO input signal
- When the REF VIDEO input signal is not available: Internal synchronization

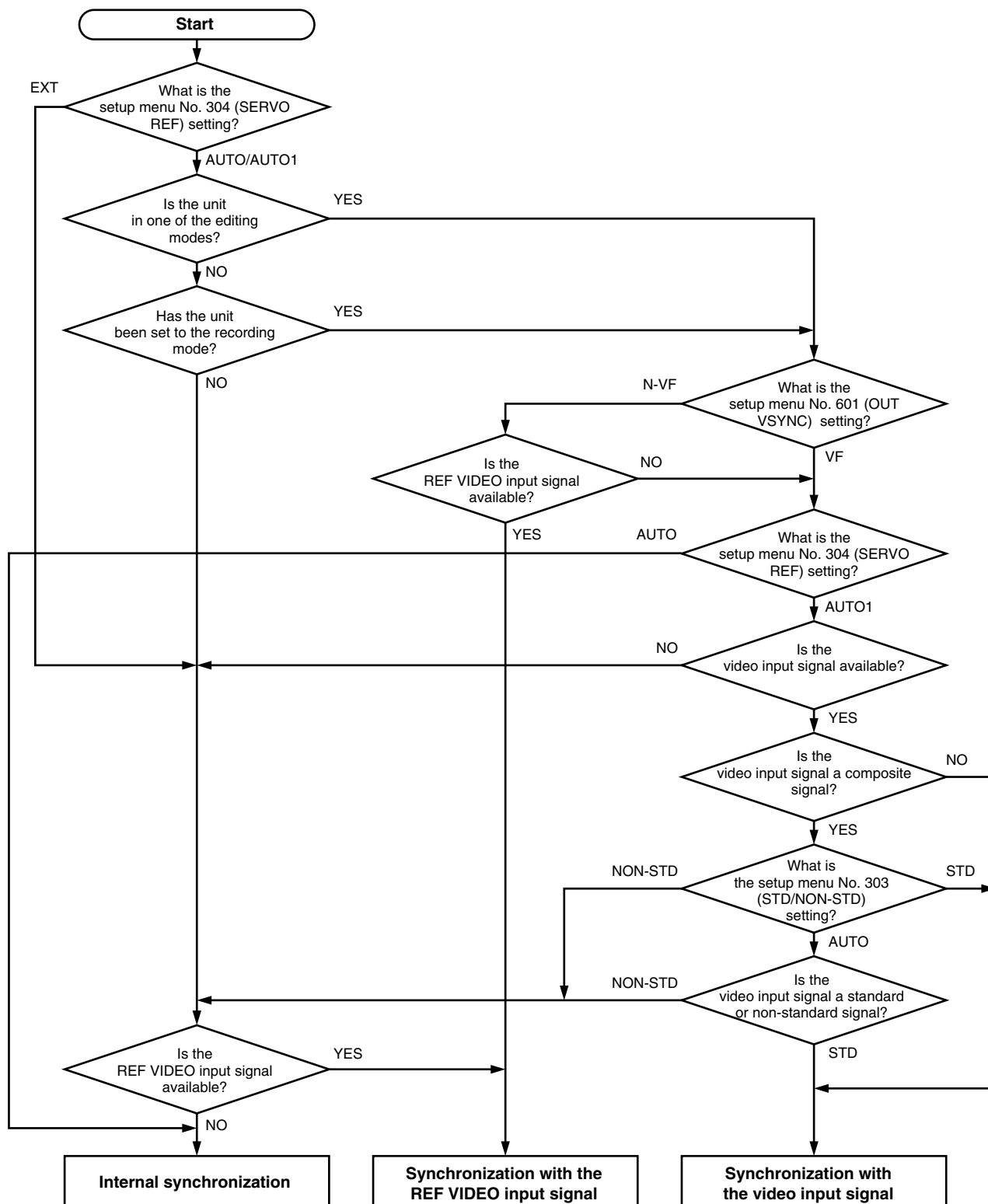

# Video output signals and servo reference signal (continued)

## Servo reference signal

The REF VIDEO input signal or video input signal is selected as the servo reference signal. As shown in the figure below, the signal is selected in accordance with the setup menu settings, VTR mode and availability of the video input signal.

### <Notes>

Synchronization is determined as follows depending on the availability of the REF VIDEO input signal when "BB", "CB100" or "CB75" has been selected as the setup menu No. 600 (INT SG) setting.

- When the REF VIDEO input signal is available:  
Synchronization with the REF VIDEO input signal
- When the REF VIDEO input signal is not available:  
Internal synchronization



# Audio V fade function

---

When editing tapes, the edit point splicing selection (setup menu No. 311 and 312) information is recorded on the tape. This information is then sensed during playback, and V fade or cut processing is automatically performed for these sections.

However, only when the playback fade selection (No. 727) is AUTO.

## When the edit point splicing selection (setup menu No. 311 and 312) is CUT

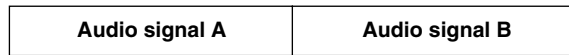

↑  
Noise appears at the edit splice.

## When the edit point splicing selection (setup menu No. 311 and 312) is FADE



↑  
V fade is performed instantaneously to eliminate the noise.

### <Notes>

- When the playback fade selection (No. 727) is CUT, cut processing is performed for all splices.
- When the playback fade selection (No. 727) is FADE, V fade processing is performed for all splices.

# Audio recording channel and monitor output selection

## Audio recording channel

The audio recording channels are selected on the AUDIO setup menu as shown below.

Recording track	Recording signal
CH1	CH1 input/CH2 input/CH1 input+CH2 input
CH2	CH1 input/CH2 input/CH1 input+CH2 input
CH3	CH3 input/CH4 input/CH3 input+CH4 input
CH4	CH3 input/CH4 input/CH3 input+CH4 input
CUE	CH1 input/CH2 input/CH1 input+CH2 input/ CH3 input/CH4 input/CH3 input+CH4 input/ CH1 input+CH2 input+CH3 input+CH4 input

## Monitor output channel

The monitor output channels are selected using the AUDIO MON SEL (L and R) and AUDIO MON SEL (MIX) buttons as shown below.

Monitor output	Output signal
L	CH1/CH2/CH3/CH4/CH1+CH2/CH3+CH4/ CH1+CH3/CH2+CH4/CUE
R	CH1/CH2/CH3/CH4/CH1+CH2/CH3+CH4/ CH1+CH3/CH2+CH4/CUE

# Printed circuit board

## F1 board (AUDIO)

Switch No.	Function
SW100	<b>AUDIO INPUT IMPEDANCE SW</b> This sets the CH1 audio input impedance.  <u>HIGH/600Ω</u>
SW101	<b>AUDIO INPUT IMPEDANCE SW</b> This sets the CH2 audio input impedance.  <u>HIGH/600Ω</u>
SW200	<b>AUDIO INPUT IMPEDANCE SW</b> This sets the CH3 audio input impedance.  <u>HIGH/600Ω</u>
SW201	<b>AUDIO INPUT IMPEDANCE SW</b> This sets the CH4 audio input impedance.  <u>HIGH/600Ω</u>

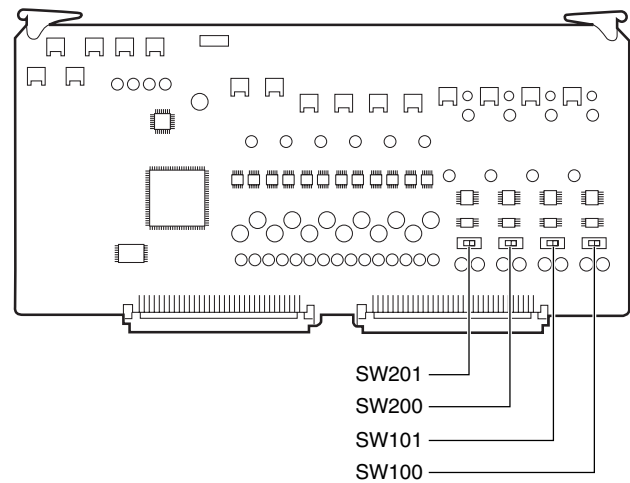

The underlined items indicates the initial setting.

# Rack mounting

The unit can be mounted into a 19-inch standard rack using the optional rack-mounting adaptors (AJ-MA75P). For the installation rails, it is recommended that the 18-inch rail and bracket (model number CC3061-99-0400) by Chassis Trak be used. (The complete slide rail and bracket unit is not available from Panasonic.)

For further details, consult your dealer.

- 1 Attach the inner members of the slide rails. Refer to the figure below for the locations where the screws are to be attached.

Locations where the screws are secured on the right (R) side of the inner members of the slide rails

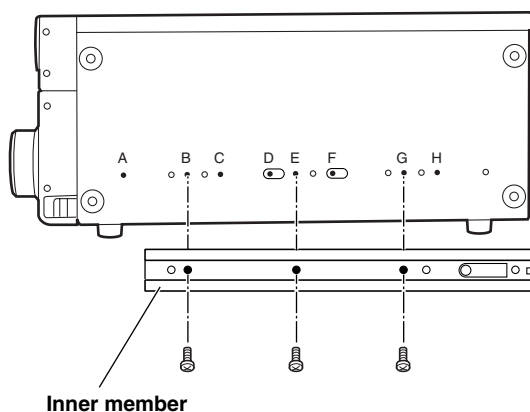

#### <Notes>

- The length of the screws used is subject to restriction. (B, G: 10 mm, E: 6 mm)
- Attach the inner members at the same symmetrical positions on the left (L) side.
- Fix the members in place using 3 screws on each side (total: 6 screws).
- The letters "A" to "H" are not actually marked on the side panels.

- 2 Attach the outer member brackets to the rack. Check that the height is the same for the left and right brackets.
- 3 Remove the four screws at the front for attaching the left and right side panels.

- 4 Attach the AJ-MA75P rack mount adaptor using the same 4 screws.

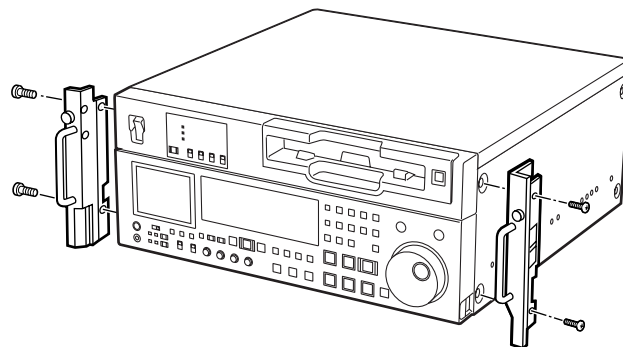

Rack-mounting adaptors

- 5 Remove the 4 rubber legs from the bottom of the unit, and install the unit in the rack. After the unit has been installed, check that it moves smoothly along the rails.

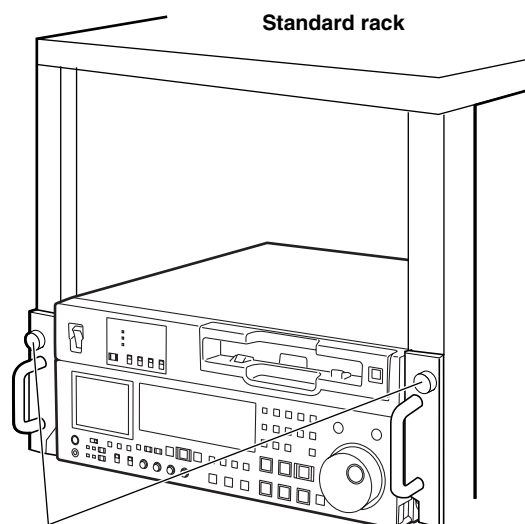

Fasten it to the rack with set screws.

#### <Notes>

- Keep the temperature inside the rack to between 5°C and 40°C.
- Bolt the rack securely to the floor so that it will not topple over when the VTR is drawn out.

# Video head cleaning

---

This unit is equipped with an auto head cleaning function which automatically reduces the amount of dirt on the video heads. However, in order to maximize the unit's reliability, it is recommended that the video heads be cleaned as and when appropriate.

For further details on how to actually clean the heads, consult with one of our service companies or with your dealer.

# Condensation

---

Condensation occurs due to the same principle involved when droplets of water form on a window pane of a heated room. It occurs when the unit or tape is moved between places where the temperature or humidity varies greatly or when, for instance:

- It is moved to a very humid place full of steam or a room immediately after it has been heated up.
- It is suddenly moved from a cold location to a hot or humid location.

When moving the unit to locations such as these, leave it standing for about 10 minutes rather than switching on the power immediately.

If condensation occurs in the unit, "E-20" will flash on the counter display and the cassette will be automatically ejected.

Leave the unit with the power on until "E-20" is cleared from the display.

# Maintenance

---

Before starting any maintenance work, switch the power to OFF and, holding the plug, unplug the cord from the socket.

Use a soft cloth to clean the outside of the unit.

For stubborn dirt or stains, wipe the unit with a cloth that has been lightly dampened with well-diluted kitchen detergent and wrung out thoroughly.

After wiping off the dirt with the damp cloth, finish it off with a dry cloth.

## <Note>

Do not use alcohol, benzene, thinners or any other solvents as they may affect the color of external parts or damage the unit's coating.

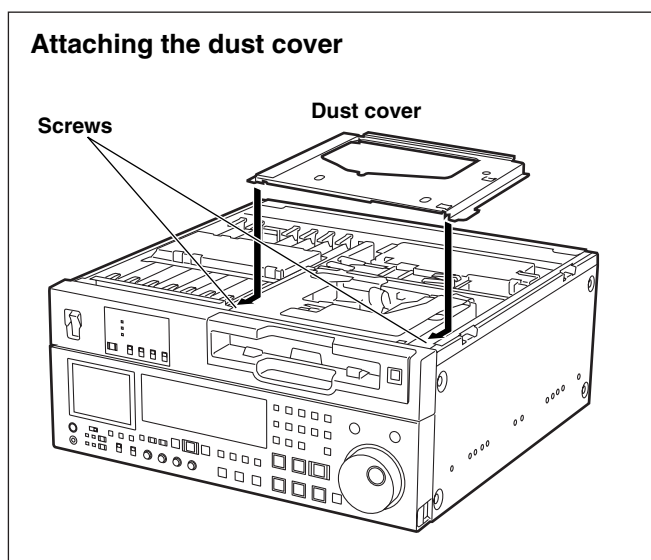

# Error messages

When a warning occurs in this unit, the error number is indicated on the counter display.

Open the DIAG menu to display a description of the error on the counter display or monitor TV.

When a operational malfunction has occurred in the unit, the error number flashes on the counter display.

## DIAG menu

This display the VTR information.

VTR information includes “WARNING” information, “HOURS METER” (usage time) information and “UMID (Unique Material Identifier)” information.

A DIAG menu appears on the monitor when the monitor is connected to the VIDEO OUT 3/SDI OUT 3 connector on the connector section.

## ■ Displaying the DIAG menu

- 1** Press the DIAG button.  
The DIAG menu screen is displayed on the monitor, and the message is displayed on the counter display.
- 2** Each time the search button is pressed, the display changes as follows: “WARNING” → “HOURS METER” → “UMID INFO” → and so on.
- 3** Press the DIAG button again to return to the original display.

## ■ “WARNING” information display

- A warning message is displayed whenever a warning occurs.  
When warnings have not been detected, “NO WARNING” is displayed.
- When multiple warning occur, the descriptions for each warning can be checked by turning the search dial.

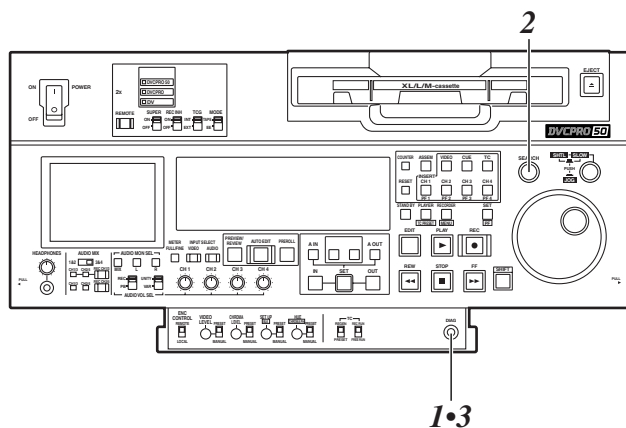

## Error messages (continued)

### ■ Displaying the “HOURS METER” information

Turn the search dial to move the cursor (\*).  
The description for the item where the cursor is located is shown on the counter display.

No./Item	Description
Ser	Displays the unit's serial No.
*****	
H00 OPERATION	Displays the time that the power has been supplied in one-hour units.
H01 DRUM RUN	Displays the time that the drum has been rotating in one-hour units.
H02 TAPE RUN	Displays the time that the tape has been running during FF, REW, PLAY, SEARCH (JOG, SLOW, SHTL), REC, and EDIT modes (except for STILL in the JOG, SLOW or SHTL mode) in one-hour units.
H03 THREADING	The number of times for threading (loading)/unthreading (unloading) is displayed in single units.
H04 F LOADING	Displays the number of times front loading has been performed in single units.
H05 LCD ON	Displays the time that the LCD monitor has been lighting in one-hour units.
H11 DRUM RUNr	Displays the time that the drum has been rotating in one-hour units. (Can be reset)
H12 TAPE RUNr	Displays the time that the tape has been running during FF, REW, PLAY, SEARCH (JOG, SLOW, SHTL), REC, and EDIT modes (except for STILL in the JOG, SLOW or SHTL mode) in one-hour units. (Can be reset)
H13 THREADINGr	The number of times for threading (loading)/unthreading (unloading) is displayed in single units. (Can be reset)
H14 F LOADINGr	Displays the number of times front loading has been performed in single units. (Can be reset)
H15 LCD ONr	Displays the time that the LCD monitor has been lighting in one-hour units. (Can be reset)
H30 POWER ON	The number of times the power has been turned on is displayed in single units.

#### <Notes>

- The resettable items in the “HOURS METER” information are reset by the shop when performing maintenance or other work.
- The search buttons and the search dial cannot be operated while the DIAG menu is displayed.

If “T&S&M” is selected in the setup menu No. 008 (DISPLAY SEL), a message appears in the mode display whenever a warning or error occurs. When multiple events occur, the event with the highest priority is displayed.

Priority	Display/Description
High ↑ ↓ Low	<b>Error messages (See error message table)</b> When an operational malfunction has occurred in the unit, the error number flashes and the error message is indicated on the counter display.
	<b>INT SG</b> When SG has been selected as the input signal with the INPUT SELECT buttons, pressing the REC button or the EDIT button (E-E mode) will display “INT SG” for the first two seconds. This is also displayed for the first two seconds when starting editing.
	<b>NO INPUT</b> If there is no input signal (except for analog audio) to the connector selected using the INPUT SELECT buttons, pressing the REC button or the EDIT button (E-E mode) will display “NO INPUT” for the first two seconds. This is also displayed for the first two seconds when starting editing.
	<b>Warning messages (See error message table)</b> When a warning occurs in this unit, the error number and warning message are indicated on the counter display. When multiple warnings occur, the warning with the highest priority is displayed.

### ■ UMID information display

This is displayed when UMID information is present on the input signal in E-E mode.

This lamp lights during tape playback when UMID information has been recorded on the tape.  
“NO-INFO” is displayed when there is no UMID information.

Item	Display/Description
MATNO	Material number
COPY	Instance number (No. of copies)
OWNR	Country, organization, user
POS	Reception status from GPS satellites when recording spatial coordinates (height above sea level, longitude and latitude): HOLD: No reception from any satellite 2D: Reception possible, but number of satellites is insufficient. Height above sea level will not be accurate. 3D: Good reception
DATE	Date
TIME	UTC (Coordinated Universal Time) and time difference with UTC



# Error messages (continued)

## Warning messages

Priority	<ul style="list-style-type: none"> <li>● Monitor display</li> <li>● Description</li> <li>● VTR operation and corrective action</li> </ul>
High ↑ ↓ Low	<p><b>E-10 (FAN STOP)</b>            This is displayed when the fan motor stops.  <b>VTR:</b> Operation continues.  <ul style="list-style-type: none"> <li>● Check that nothing is obstructing the fan movement.</li> </ul> </p> <p><b>E-09 (NO RF)</b>            This appears during playback when a blank section (tape blank) lasting for one or more seconds has been detected.            Such a section is identified as a tape blank when all of the following conditions are met.  <ul style="list-style-type: none"> <li>● No head outputs</li> <li>● No playback data readout</li> <li>● No CTL (Excluding DV and DVCAM tapes)</li> </ul> <b>VTR:</b> Operation continues.  <ul style="list-style-type: none"> <li>● Check the tape.                A tape on which material has not been recorded may have been inserted.</li> </ul> </p> <p><b>E-00 (SERVO NOT LOCKED)</b>            This appears when the servo is not locked for three or more seconds during playback, recording, or editing.  <b>VTR:</b> Operation continues.  <ul style="list-style-type: none"> <li>● Check the tape.                A tape recorded other than PAL format may have been inserted.</li> </ul> </p> <p><b>E-01 (LOW RF)</b>            This appears when envelope levels approximately 1/3 that of normal levels are detected for more than one second during playback, recording, or editing.  <b>VTR:</b> Operation continues.  <ul style="list-style-type: none"> <li>● Clean the video heads.</li> </ul> </p> <p><b>E-02 (HIGH ERROR RATE)</b>            This appears when the error rate has increased to the extent that correction or interpolation was performed on either the video or audio signals.  <b>VTR:</b> Operation continues.  <ul style="list-style-type: none"> <li>● Clean the video heads.</li> </ul> </p>

## Error messages (continued)

### Error messages

Display	<ul style="list-style-type: none"> <li>● Description</li> <li>● VTR operation and corrective action</li> </ul>
<b>E-20</b> <b>DEW</b>	<p>If condensation is detected, the error number flashes and the unit transfers to eject mode. The drum rotates after the cassette is ejected to eliminate the condensation. Once the unit is released from condensation status, the error message display is cleared and the VTR is able to be used.</p> <ul style="list-style-type: none"> <li>● If condensation is detected in the eject mode, the drum starts rotating as soon as it is detected.</li> <li>● If condensation is detected when the cassette has been inserted, the drum rotation is stopped, and after the tape is ejected, the drum starts rotating.</li> </ul> <p><b>VTR: EJECT</b></p> <ul style="list-style-type: none"> <li>● Leave the power on and wait.</li> </ul>
<b>E-29</b> <b>FRONT LOAD MOTOR</b>	<p>The unit switches to eject mode and if the cassette fails to move up within 6 seconds, this error number flashes on the display.</p> <ul style="list-style-type: none"> <li>● If the cassette does not move down inside the machine even when 6 seconds have elapsed since the cassette was inserted, the VTR is transferred to the eject mode.</li> </ul> <p><b>VTR: STOP</b></p> <ul style="list-style-type: none"> <li>● Set the POWER switch to OFF and then to ON again.</li> </ul>
<b>E-31</b> <b>LOADING MOTOR</b>	<p>If the unloading operation is not completed within 6 seconds, this error number flashes on the display.</p> <ul style="list-style-type: none"> <li>● When the loading operation is not completed within 6 seconds, the VTR is transferred to the eject (unloading) mode.</li> </ul> <p><b>VTR: STOP</b></p> <ul style="list-style-type: none"> <li>● Set the POWER switch to OFF and then to ON again.</li> </ul>
<b>E-35</b> <b>SERVO CONTROL ERROR</b>	<p>If there is no response from the servo microcomputer for 1 second or more, this error number flashes on the display.</p> <p><b>VTR: STOP</b></p> <ul style="list-style-type: none"> <li>● Set the POWER switch to OFF and then to ON again.</li> </ul>
<b>E-37</b> <b>SERVO COMM ERROR</b>	<p>If 10 seconds or more elapses and the servo microcomputer has not followed orders issued by the system control microcomputer, this error number flashes on the display.</p> <p><b>VTR: STOP</b></p> <ul style="list-style-type: none"> <li>● Set the POWER switch to OFF and then to ON again.</li> </ul>
<b>E-38</b> <b>SERVO FG ERROR</b>	<p>If automatic adjustment of the reel and capstan rotation in eject status was not performed correctly when the power was turned on, this error number flashes on the display.</p> <p><b>VTR: STOP</b></p> <ul style="list-style-type: none"> <li>● Set the POWER switch to OFF and then to ON again.</li> </ul>

Display	<ul style="list-style-type: none"> <li>● Description</li> <li>● VTR operation and corrective action</li> </ul>
<b>E-51</b> <b>FRONT LOAD ERROR</b>	<p>If the take-up reel rotates without engaging for a specific period of time during the start or end processing operation while loading is underway (half position), this error number flashes on the display.</p> <p><b>VTR: STOP</b></p> <ul style="list-style-type: none"> <li>● Set the POWER switch to OFF and then to ON again.</li> </ul>
<b>E-52</b> <b>W-UP REEL NOT ROTA</b>	<p>If the take-up reel fails to take up the tape while the tape is traveling in the state where the total amount of the tape has not yet been detected after the cassette was inserted, this error number flashes on the display.</p> <p><b>VTR: STOP</b></p> <ul style="list-style-type: none"> <li>● Set the POWER switch to OFF and then to ON again.</li> </ul>
<b>E-53</b> <b>WINDUP ERROR</b>	<p>If there is an abnormally large discrepancy between the amount of tape taken up by the take-up reel and the amount of tape supplied by the supply reel while the tape is traveling after the total amount of the tape begins to be detected, this error number flashes on the display.</p> <p><b>VTR: STOP</b></p> <ul style="list-style-type: none"> <li>● Set the POWER switch to OFF and then to ON again.</li> </ul>
<b>E-55</b> <b>UNLOAD ERROR</b>	<p>If the tape has not been taken up during unloading, this error number flashes on the display.</p> <p><b>VTR: STOP</b></p> <ul style="list-style-type: none"> <li>● Set the POWER switch to OFF and then to ON again.</li> </ul>
<b>E-57</b> <b>S-FF/REW TIMEOVER</b>	<p>If the start or end processing operation is not completed, this error number flashes on the display.</p> <p><b>VTR: STOP</b></p> <ul style="list-style-type: none"> <li>● Set the POWER switch to OFF and then to ON again.</li> </ul>
<b>E-59</b> <b>DRUM ROTA TOO SLOW</b>	<p>If the cylinder motor speed is abnormally low, this error number flashes on the display.</p> <p><b>VTR: STOP</b></p> <ul style="list-style-type: none"> <li>● Set the POWER switch to OFF and then to ON again.</li> </ul>
<b>E-60</b> <b>DRUM ROTA TOO FAST</b>	<p>If the cylinder motor speed is abnormally high, this error number flashes on the display.</p> <p><b>VTR: STOP</b></p> <ul style="list-style-type: none"> <li>● Set the POWER switch to OFF and then to ON again.</li> </ul>
<b>E-61</b> <b>CAP ROTA TOO SLOW</b>	<p>If the capstan motor speed is abnormally low, the error number flashes on the display.</p> <p><b>VTR: STOP</b></p> <ul style="list-style-type: none"> <li>● Set the POWER switch to OFF and then to ON again.</li> </ul>

## Error messages (continued)

### Error messages

Display	<ul style="list-style-type: none"> <li>● Description</li> <li>● VTR operation and corrective action</li> </ul>
<b>E-64</b> <b>S REEL ROTA</b> <b>TOO FAST</b>	<p>If the supply reel motor speed is abnormally high, the error number flashes on the display.</p> <p><b>VTR: STOP</b></p> <ul style="list-style-type: none"> <li>● Set the POWER switch to OFF and then to ON again.</li> </ul>
<b>E-67</b> <b>T REEL ROTA</b> <b>TOO FAST</b>	<p>If the take-up reel motor speed is abnormally high, the error number flashes on the display.</p> <p><b>VTR: STOP</b></p> <ul style="list-style-type: none"> <li>● Set the POWER switch to OFF and then to ON again.</li> </ul>
<b>E-69</b> <b>T REEL</b> <b>TORQUE ERR</b>	<p>If excess torque being applied to the take-up reel motor is detected, the error number flashes on the display.</p> <p><b>VTR: STOP</b></p> <ul style="list-style-type: none"> <li>● Set the POWER switch to OFF and then to ON again.</li> </ul>
<b>E-70</b> <b>S REEL</b> <b>TORQUE ERR</b>	<p>If excess torque being applied to the supply reel motor is detected or an abnormal current flowing to the current detection resistor is detected, this error number flashes on the display.</p> <p><b>VTR: STOP</b></p> <ul style="list-style-type: none"> <li>● Set the POWER switch to OFF and then to ON again.</li> </ul>
<b>E-71</b> <b>CAP TENSION</b> <b>ERROR</b>	<p>If abnormal tension at the supply side is detected in the capstan mode, the error number flashes on the display.</p> <p><b>VTR: STOP</b></p> <ul style="list-style-type: none"> <li>● Set the POWER switch to OFF and then to ON again.</li> </ul>
<b>E-72</b> <b>REEL TENSION</b> <b>ERROR</b>	<p>If abnormal tension at the supply side is detected in the reel mode, the error number flashes on the display.</p> <p><b>VTR: STOP</b></p> <ul style="list-style-type: none"> <li>● Set the POWER switch to OFF and then to ON again.</li> </ul>
<b>E-73</b> <b>REEL DIR</b> <b>UNMATCH</b>	<p>If the take-up reel motor has rotated in the reverse direction, this error number flashes on the display.</p> <p><b>VTR: STOP</b></p> <ul style="list-style-type: none"> <li>● Set the POWER switch to OFF and then to ON again.</li> </ul>
<b>E-74</b> <b>DRUM</b> <b>TORQUE</b> <b>ERROR</b>	<p>If excess torque being applied to the cylinder motor is detected, this error number flashes on the display.</p> <p><b>VTR: STOP</b></p> <ul style="list-style-type: none"> <li>● Set the POWER switch to OFF and then to ON again.</li> </ul>
<b>E-78</b> <b>SVDR COMM</b> <b>ERROR</b>	<p>If a problem has been encountered in communication between the servo microcomputer and servo drive board, this error number flashes on the display.</p> <p><b>VTR: STOP</b></p> <ul style="list-style-type: none"> <li>● Set the POWER switch to OFF and then to ON again.</li> </ul>

**Consult your dealer if the error message is still displayed even after restarting the unit.**

# RS-232C interface

The VTR can be operated by commands when the RS-232C interface is used.  
(See command table on pages 79, 80.)

## ■ Conditions for acknowledging commands from RS-232C interface

- The REMOTE button on the front panel must be set to the remote mode (REMOTE lamp ON).
- The setup menu No. 204 "RS232C SEL" must be ON.

If the above conditions are not met, [ACK] + [STX] ER001 [EXT] is returned to the external unit.  
Whether the [ACK] code is returned depends on the setting which has been selected for setup menu item No. 209 "RETURN ACK".

## Hardware specifications

### External interface specifications

#### ● Connector specifications

Connector:  
D-SUB 25-pin (crossover cable supported)

Pin No.	Signal	Description
1	FG	Protective ground (Frame ground)
2	RXD	Received data (Data is sent to PC.)
3	TXD	Transmitted data (Data is received from PC.)
4	CTS	Clear to send (Shorted with pin 5.)
5	RTS	Request to send (Shorted with pin 4.)
6	DTR	Data terminal ready (No processing)
7	SG	Signal ground (Signal ground)
20	DSR	Data set ready (+ voltage output after communication enable status)

#### ● Example of connection with controller (PC)

Using crossover cable with D-SUB 25-pin connectors

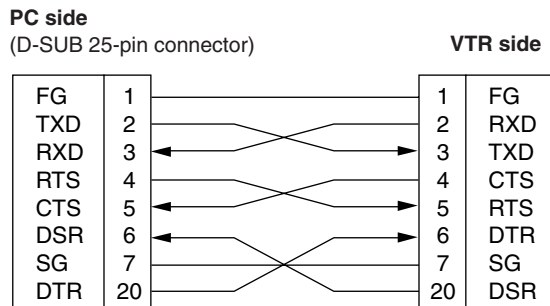

Using crossover cable with D-SUB 9-pin and 25-pin connectors

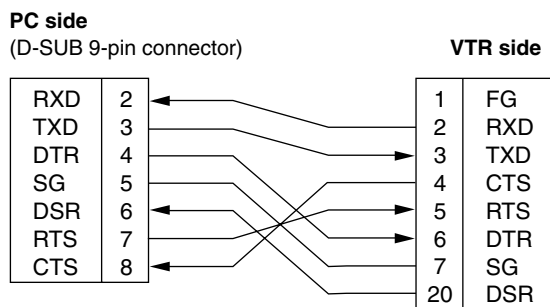

# RS-232C interface (continued)

## Software specifications (Protocol)

### 1. Communication parameters

<b>Communication system</b>	Asynchronous, full duplex
<b>Communication speed</b>	300/600/1200/2400/4800/ <u>9600</u>
<b>Bit length</b>	7bit/ <u>8 bit</u>
<b>Stop bit</b>	<u>1 bit</u> /2 bit
<b>Parity bit</b>	<u>NONE</u> /ODD/EVEN
<b>ACK code</b>	<u>ACK code returned</u> /ACK code not returned <Note> The ACK code is what is returned from the VTR to the controller when data has been successfully sent from the controller.

The underlining indicates the factory settings.

Any changes to the settings can be made using the setup menu items listed below.

Communication parameter	Setup menu item
<b>Communication speed</b>	No.205 BAUD RATE
<b>Bit length</b>	No.206 DATA LENGTH
<b>Stop bit</b>	No.207 STOP BIT
<b>Parity bit</b>	No.208 PARITY
<b>ACK code</b>	No.209 RETURN ACK

### 2. Send format [controller (PC) → VTR]

#### ■ Data format

[STX] [command] [:] [data] [ETX]  
02h XX XX XX 3Ah XX……XX 03h

#### 20H<XX<7FH

(XX = ASCII code: symbols, numbers upper-case letters)

#### [command] :

Command identifier; a 3-byte identifier (ASCII code: symbols, numbers, upper-case letters) is sent as the command.

#### [ : ] :

This code serves as a delimiter between the command and data.

#### [data] :

Data (ASCII code: symbols, numbers, upper-case letters) can be added in the number of bytes required.

#### ■ Outline of send procedure from controller

- ① The send command starts with STX (start of text = 02h).  
The command is then identified by COMMAND which follows and the data is added as required.  
The format ends with ETX (end of text = 03h).
- ② When a different command is to be sent, a response is awaited from the VTR, and then the command is sent. (See page 79.)
- ③ If STX is sent again before ETX is sent, the receive data buffer inside the VTR is cleared. A command error is returned to the controller, and the data is newly processed with STX which was received again at the head.

## RS-232C interface (continued)

---

### 3. Return format

#### [VTR → controller (PC)]

The following responses are made to the command. If necessary, more than one response is made.

#### ■ When the communication has terminated normally

1. The receive completion message is returned.

```
[ACK]
06h
```

2. The execution completion message is returned.

```
[STX] [command] [data] [ETX]
02h   XX XX XX  XX.....XX 03h
```

#### [command] :

This is the message (data) which is returned or the execution completion message identifier.

#### [data] :

This is the data to be returned. It can be omitted.

#### Example:

#### Send command      Return message (data)

```
[STX] OPL [ETX] → [ACK] [STX] OPL [ETX]
```

#### ■ When the communication has terminated abnormally

```
[NACK]
15h
```

#### ■ When processing is not possible due to incorrect data or trouble in the VTR

1. The receive completion message is returned.

```
[ACK]
06h
```

2. An error code is returned.

```
[STX] [E R N1 N2 N3] [ETX]
02h   Error code   03h
```

### 4. Error code table

**ER001** : Invalid command

- Unsupported command received.
- Error in command execution

**ER002** : Parameter error

**ER102** : VTR mode error (front loading motor)

**ER103** : VTR mode error (loading motor)

**ER104** : VTR mode error (drum, capstan system)

**ER105** : VTR mode error (reel system)

**ER106** : VTR mode error (tension system)

**ER108** : VTR dew error

**ER1FF** : VTR system error

# RS-232C interface (continued)

## 5. Command table

### ■ Commands relating to operation control

#### <Notes>

- As for the return (completion) message, [ACK] is first returned when data is received, and the execution message is subsequently returned. It is only the execution message which is listed in this table.
- In the case of commands not listed in the table, ER001 (invalid command) is returned after [ACK] has been returned.

VTR operation	Send command	Return (completion) message
<b>STOP</b>	[STX] OSP [ETX] ↔	[STX] OSP [ETX]
	This command is for stopping the tape travel.	
<b>EJECT</b>	[STX] OEJ [ETX] ↔	[STX] OEJ [ETX]
	This command is for ejecting the cassette tape. The resulting output picture and sound statuses differ according to the settings selected for the setup menu No. 105 (AUTO EE SEL) and the setup menu No. 111 (FRZ MODE SEL).	
<b>PLAY</b>	[STX] OPL [ETX] ↔	[STX] OPL [ETX]
	This command is for starting playback.	
<b>REWIND</b>	[STX] ORW [ETX] ↔	[STX] ORW [ETX]
	This command is for rewinding the tape. The resulting output picture and sound statuses differ according to the settings selected for the setup menu No. 105 (AUTO EE SEL). The maximum tape speed differs according to the setting selected for setup menu No. 102 (FF. REW MAX).	
<b>FAST FORWARD</b>	[STX] OFF [ETX] ↔	[STX] OFF [ETX]
	This command is for fast forwarding the tape. The resulting output picture and sound statuses differ according to the settings selected for the setup menu No. 105 (AUTO EE SEL). The maximum tape speed differs according to the setting selected for setup menu No. 102 (FF. REW MAX).	
<b>REC</b>	[STX] ORC [ETX] ↔	[STX] ORC [ETX]
	This command is for starting the recording.	

VTR operation	Send command	Return (completion) message
<b>SHTL FORWARD</b>	[STX] OSF:data [ETX] ↔	[STX] OSF [ETX]
	<p>This is the forward direction shuttle command.</p> <p>data = n : speed data            0 : STILL            1 : ×0.03            2 : ×0.1            3 : ×0.2            4 : ×0.5            5 : ×1            6 : ×1.85            7 : ×4.1 (×3.1)            8 : ×9.5            9 : ×16            A : ×32</p> <p>&lt;Notes&gt;</p> <ul style="list-style-type: none"> <li>● The ×16 and ×32 speed differ according to the setting selected for setup menu No. 101 (SHTL MAX).</li> <li>● The value for the DV/DVCAM tape is shown in parenthesis ( ).</li> </ul>	
<b>SHTL REVERSE</b>	[STX] OSR:data [ETX] ↔	[STX] OSR [ETX]
	<p>This is the reverse direction shuttle command.</p> <p>data = n : speed data            0 : STILL            1 : ×0.03            2 : ×0.1            3 : ×0.2            4 : ×0.43 (×0.5)            5 : ×1            6 : ×1.85            7 : ×4.1 (×3.1)            8 : ×9.5            9 : ×16            A : ×32</p> <p>&lt;Notes&gt;</p> <ul style="list-style-type: none"> <li>● The ×16 and ×32 speed differ according to the setting selected for setup menu No. 101 (SHTL MAX).</li> <li>● The value for the DV/DVCAM tape is shown in parenthesis ( ).</li> </ul>	
<b>STANDBY OFF</b>	[STX] OBF [ETX] ↔	[STX] OBF [ETX]
	This command is setting the VTR to standby OFF.	
<b>STANDBY ON</b>	[STX] OBN [ETX] ↔	[STX] OBN [ETX]
	This command is setting the VTR to standby ON.	

## RS-232C interface (continued)

### ■ Commands relating to inquiries

#### <Notes>

- As for the return (completion) message, [ACK] is first returned when data is received, and the execution message is subsequently returned. It is only the execution message which is listed in this table.
- In the case of commands not listed in the table, ER001 (invalid command) is returned after [ACK] has been returned.

VTR operation	Send command	Return (completion) message
<b>CTL/TC DATA REQUEST</b>	[STX] QCD [ETX]	↔ [STX] CD data [ETX]
	<p>This command is for inquiring about the counter value.</p> <p>data = f w gh mm ss ff</p> <p>f = F</p> <p>w = S</p> <p>gh =</p> <p>CTL mode:</p> <p>g = SP (20h) : for a plus display</p> <p>– (2Dh) : for a minus display</p> <p>h = 0 – 9 : hours</p> <p>TC mode:</p> <p>gh = 00 – 23 : hours</p> <p>mm = 00 – 59 : minutes</p> <p>ss = 00 – 59 : seconds</p> <p>[625i system]</p> <p>ff = 00 – 24 : frames</p> <p>[525i system]</p> <p>ff = 00 – 29 : frames</p> <p>&lt;Note&gt;</p> <p>CTL or TC is returned, whichever corresponds to the front display mode.</p>	
<b>STATUS REQUEST</b>	[STX] QOP [ETX]	↔ [STX] *** [ETX]
	<p>This command is for inquiring about the VTR's operation mode.</p> <p>*** =</p> <p>OEJ : EJECT</p> <p>OFF : FAST FORWARD</p> <p>OPL : PLAY</p> <p>ORC : REC</p> <p>ORW : REWIND</p> <p>OSP : STOP (including the STANDBY ON)</p> <p>SRS : (IN/OUT) PREROLL</p> <p>OBF : STANDBY OFF</p> <p>OSF : SHTL FORWARD</p> <p>OSR : SHTL REVERSE</p> <p>OJG : JOG FORWARD/REVERSE</p> <p>OSW : VAR FORWARD/REVERSE</p> <p>EAE : AUTO EDIT</p> <p>EON : EDIT ON (MANUAL EDIT)</p> <p>EPV : PREVIEW</p> <p>ERV : REVIEW</p>	

VTR operation	Send command	Return (completion) message
<b>ID (VTR No.) REQUEST</b>	[STX] QID [ETX]	↔ [STX] data [ETX]
	<p>This command is for inquiring about the VTR used.</p> <p>data = AJ-SD965P</p>	



# Connector signals

## VIDEO IN

<b>SDI IN (DIGITAL)</b>	BNC×2, Active through
<b>Y, PB, PR (ANALOG)</b>	BNC×3 (Board, option)
<b>VIDEO IN</b>	BNC×2, Loop-through, 75Ω termination switch provided (Board, option)
<b>REF VIDEO IN</b>	BNC×2, Loop-through, 75Ω termination switch provided

## VIDEO OUT

<b>SDI OUT (DIGITAL)</b>	BNC×3
<b>Y, PB, PR (ANALOG)</b>	BNC×3
<b>VIDEO OUT</b>	BNC×3

## AUDIO IN

<b>SDI IN (DIGITAL)</b>	BNC×2, Active through
<b>AUDIO IN (DIGITAL)</b>	BNC×2 (CH1/CH2, CH3/CH4) AES/EBU format
<b>AUDIO IN (ANALOG)</b>	XLR×4 (CH1, CH2, CH3, CH4)
<b>TIME CODE IN</b>	XLR×1

## AUDIO OUT

<b>SDI OUT (DIGITAL)</b>	BNC×3
<b>AUDIO OUT (DIGITAL)</b>	BNC×2 (CH1/CH2, CH3/CH4) AES/EBU format
<b>AUDIO OUT (ANALOG)</b>	XLR×4 (CH1, CH2, CH3, CH4)
<b>TIME CODE OUT</b>	XLR×1
<b>MONITOR OUT</b>	XLR×2 (L/R)
<b>HEADPHONES (front)</b>	Stereo mini jack

## RS-422A REMOTE (9P)

### ● REMOTE IN/OUT

Pin No.	Signal
1	FRAME GROUND
2	TRANSMIT A
3	RECEIVE B
4	RECEIVE COMMON
5	—————
6	TRANSMIT COMMON
7	TRANSMIT B
8	RECEIVE A
9	FRAME GROUND

### ● REMOTE OUT

Pin No.	Signal
1	FRAME GROUND
2	RECEIVE A
3	TRANSMIT B
4	TRANSMIT COMMON
5	—————
6	RECEIVE COMMON
7	RECEIVE B
8	TRANSMIT A
9	FRAME GROUND

## Connector signals (continued)

### PARALLEL REMOTE (25P)

Pin No.	Signal
1	PLAY COMMAND
2	STOP COMMAND
3	FF COMMAND
4	REW COMMAND
5	REC COMMAND
6	EJECT COMMAND
7	STAND BY COMMAND
8	PREROLL COMMAND
9	IN SET COMMAND
10	—————
11	—————
12	≥ 10 V, MAX 300 mA
13	PLAY STATUS
14	STOP STATUS
15	FF STATUS
16	REW STATUS
17	REC STATUS
18	EJECT STATUS
19	STAND BY ON STATUS
20	PREROLL STATUS
21	SERVO LOCK STATUS
22	OPERATION ENABLE STATUS
23	—————
24	—————
25	GND

#### <Notes>

- COMMAND pins: TTL level, active low, ≥ 100ms edge electrical signal.
- STATUS pins: open collector, sink current 6 mA

### RS-232C

#### D-SUB 25-pin (crossover cable supported)

Pin No.	Signal	Description
1	FG	Protective ground (Frame ground)
2	RXD	Received data (Data is sent to PC.)
3	TXD	Transmitted data (Data is received from PC.)
4	CTS	Clear to send (Shorted with pin 5.)
5	RTS	Request to send (Shorted with pin 4.)
6	DTR	Data terminal ready (No processing)
7	SG	Signal ground (Signal ground)
20	DSR	Data set ready (+ voltage output after communication enable status)

### ENCODER (15P)

Pin No.	Signal
1	—————
2	SET UP/BLACK LEVEL
3	C LEVEL
4	GND
5	+9 V
6	SYSTEM H PHASE
7	SYS. SC COARSE (2)
8	-9 V
9	HUE/CHROMA PHASE
10	VIDEO LEVEL
11	RET GND
12	—————
13	—————
14	SYS. SC FINE
15	SYS. SC COARSE (1)

# Specifications

## [GENERAL]

<b>Power supply:</b>	AC 100 – 240 V, 50/60 Hz
<b>Power consumption:</b>	115 W 130 W (with all options)

 indicates safety information.

**Operating ambient temperature:**  
5°C to 40°C

**Operating ambient humidity:**  
10% to 80% (no condensation)

**Weight:**  
38.5 lb (17.5 kg)

**Dimensions (W×H×D):**  
16 3/4 inches×6 15/16 inches×16 7/16 inches  
(424 mm×175.2 mm×417 mm)  
(Not including the support legs, connectors, and JOG dial)

**Recording format:**  
DVCPRO50/DVCPRO format selectable

**Recording video signal:**  
525i/625i system selectable

**Recording audio signal:**  
DVCPRO50:  
48 kHz 16-bit 4 channels  
DVCPRO:  
48 kHz 16-bit 2 channels

**Recording tracks:**  
Digital video audio:  
helical track  
The time code is recorded in the sub-code area.  
Cue track:  
1 track  
Control track:  
1 track

**Tape speed:**  
[525i system]  
67.640 mm/sec (DVCPRO50)  
[625i system]  
67.708 mm/sec (DVCPRO50)

**Recording time:**  
50 Mbps:  
126 minutes (using the AJ-5P126XG)  
92 minutes (using the AJ-5P92LP)  
33 minutes (using the AJ-P66MP)  
25 Mbps:  
252 minutes (using the AJ-5P126XG)  
184 minutes (using the AJ-5P92LP)  
66 minutes (using the AJ-P66MP)

**Tape:**  
Metal tape

**FF/REW time:**  
Less than 3 min (with AJ-5P126XG)  
Less than 2 min (with AJ-P126LP)  
Less than 1 min (with AJ-P66MP)

**Digital slow:**  
–0.43× to +0.43×, +0.5×, +0.75× speed  
(DVCPRO, DVCPRO50)

**Editing accuracy:**  
±0 frames (using the time code)

**Tape timer accuracy:**  
±1 frame (using the continuous CTL signal)

**Servo lock time:**  
Less than 0.5 sec (color framing/standby ON)

## [VIDEO]

### ■ Digital video

**Sampling frequencies:**  
Y: 13.5 MHz, PB/PR: 6.75 MHz  
(DVCPRO50)

**Quantizing:**  
8 bits

**Video compression method:**  
DV-Based compression (SMPTE 314M)

**Video compression rate:**  
DVCPRO50: 1/3,3,  
DVCPRO: 1/5

**Error correction:**  
Reed-Solomon product code

**Bit rate:**  
DVCPRO50: 50 Mbps,  
DVCPRO: 25 Mbps

### ■ Digital IN/Analog component OUT

**Video bandwidth:**  
[525i system]  
Y : 30 Hz to 5.75 MHz (±0.5 dB)  
PB/PR : 30 Hz to 2.75 MHz (±0.5 dB)  
[625i system]  
Y : 25 Hz to 5.75 MHz (±1.0 dB)  
PB/PR : 25 Hz to 2.75 MHz (±1.0 dB)

**S/N ratio:**  
Better than 60 dB (Y)

**K factor:**  
Less than 1% (Y 2T)

**Y/PB, PR delay:**  
Less than 10 ns

### ■ Video input connector

**Analog component input (option):**  
BNC×3 (Y, PB, PR)  
Y: 1.0 V [p-p], PB/PR: 0.486/0.7 V [p-p] switchable,  
75Ω (75% color bar, 7.5% setup)

**Analog composite input (option):**  
BNC×2, loop-through, 75Ω on/off

**Reference input:**  
BNC×2, loop-through, 75Ω on/off

**SDI input:**  
BNC×2, active through, complies with SMPTE259M-C/ITU-R  
BT.656-4 standard

# Specifications (continued)

## [VIDEO]

### ■ Video output connector

**Analog component output:**

BNC×3 (Y, PB, PR)  
Y: 1.0 V [p-p], PB/PR: 0.486/0.7 V [p-p] switchable,  
(75% color bar, 7.5% setup)

**Analog composite output:**

BNC×3, video 1, video 2 (video/WFM selectable), video 3  
(superimpose on/off)

**SDI output:**

BNC×3, SDI 1, SDI 2, SDI 3 (superimpose on/off),  
complies with SMPTE259M-C/ITU-R BT.656-4 standard

### ■ Video signal adjustment

**Video output gain:**

±3 dB

**Video output chroma gain:**

±3 dB

**Video output HUE (chroma phase):**

±30°

**Video output setup (black) level:**

±100 mV (±14 IRE)

**Video output sync phase:**

±15 µsec

**Video output SC phase:**

More than ±180°

## [AUDIO]

### ■ Digital audio

**Sampling frequencies:**

48 kHz (synchronous with video)

**Quantizing:**

16 bits

**Frequency response:**

20 Hz to 20 kHz ±1.0 dB (at the reference level)

**Dynamic range:**

Better than 90 dB (1 kHz, emphasis OFF, "A" weighted)

**Distortion:**

Less than 0.05% (1 kHz, emphasis OFF, reference level)

**Crosstalk:**

Less than -80 dB (1 kHz, between 2 channels)

**Wow & flutter:**

Below measurable limit

**Headroom:**

20 dB

**De-emphasis:**

T1 = 50 µsec, T2 = 15 µsec (auto on/off)

### ■ Cue track

**Frequency response:**

300 Hz to 6 kHz ±3.0 dB (DVCPRO50)

## [AUDIO]

### ■ Audio input connector

**Analog input (CH1, CH2, CH3, CH4):**

XLR×4, 600Ω/high impedance selectable (factory setting: high impedance), +4/0/-20 dBu selectable

**Digital input (CH1/CH2, CH3/CH4):**

BNC×2, AES/EBU format

**SDI input:**

BNC×2, active through, complies with SMPTE272M-A/ITU-R BT.656-4 standard

### ■ Audio output connector

**Analog output (CH1, CH2, CH3, CH4):**

XLR×4, low impedance, +4/0/-20 dBu selectable

**Digital output (CH1/CH2, CH3/CH4):**

BNC×2, AES/EBU format,  
75Ω, 1.0 ± 0.2 V [p-p]

**SDI output:**

BNC×3, 75Ω, complies with SMPTE272M-A/ITU-R BT.656-4 standard

**Monitor output:**

XLR×2, low impedance, +4/0/-20 dBu selectable

**Headphones:**

Stereo mini jack, 8Ω, variable level

## [Other Input/Output Connectors]

**Time code input:**

XLR×1, 0.5 V to 8.0 V [p-p], 10 kΩ

**Time code output:**

XLR×1, low impedance, 2.0 V ± 0.5 V [p-p]

**RS-422A input:**

D-sub 9-pin, RS-422A interface

**RS-422A output:**

D-sub 9-pin, RS-422A interface

**RS-232C:**

D-sub 25-pin, RS-232C interface

**Parallel input/output:**

D-sub 25-pin

**Encoder remote:**

D-sub 15-pin

Weight and dimensions when shown are approximately.  
Specifications are subject to change without notice.



# Panasonic®

**PANASONIC BROADCAST & TELEVISION SYSTEMS COMPANY**  
UNIT COMPANY OF MATSUSHITA ELECTRIC CORPORATION OF AMERICA

**Executive Office:**

One Panasonic Way 4E-7, Secaucus, NJ 07094 (201) 348-7000

**EASTERN ZONE:**

One Panasonic Way 4E-7, Secaucus, NJ 07094 (201) 348-7621

**Southeast Region:**

1225 Northbrook Parkway, Ste 1-160, Suwanee, GA 30024 (770) 338-6835

**Central Region:**

1707 N Randall Road E1-C-1, Elgin, IL 60123 (847) 468-5200

**WESTERN ZONE:**

3330 Cahuenga Blvd W., Los Angeles, CA 90068 (323) 436-3500

**Government Marketing Department:**

52 West Gude Drive, Rockville, MD 20850 (301) 738-3840

**Broadcast PARTS INFORMATION & ORDERING:**

9:00 a.m. – 5:00 p.m. (EST) (800) 334-4881/24 Hr. Fax (800) 334-4880

Emergency after hour parts orders (800) 334-4881

**TECHNICAL SUPPORT:**

Emergency 24 Hour Service (800) 222-0741

**Panasonic Canada Inc.**

5770 Ambler Drive, Mississauga, Ontario L4W 2T3 (905) 624-5010

**Panasonic de Mexico S.A. de C.V.**

Av angel Urraza Num. 1209 Col. de Valle 03100 Mexico, D.F. (52) 1 951 2127

**Panasonic Sales Company**

**Division of Matsushita Electric of Puerto Rico Inc.**

San Gabriel Industrial Park, 65th Infantry Ave., Km. 9.5, Carolina, Puerto Rico 00630 (787) 750-4300



## Free Manuals Download Website

<http://myh66.com>

<http://usermanuals.us>

<http://www.somanuals.com>

<http://www.4manuals.cc>

<http://www.manual-lib.com>

<http://www.404manual.com>

<http://www.luxmanual.com>

<http://aubethermostatmanual.com>

Golf course search by state

<http://golfingnear.com>

Email search by domain

<http://emailbydomain.com>

Auto manuals search

<http://auto.somanuals.com>

TV manuals search

<http://tv.somanuals.com>