

Panasonic

Digital HD Video Cassette Player/Recorder

Operating Instructions

Model No. **AJ-HD1200AE**

DVC PRO HD EX

The unit's recording function become operational only when the AJ-YA120AG (optional accessory) or AJ-YAD120AG (optional accessory) has been installed.

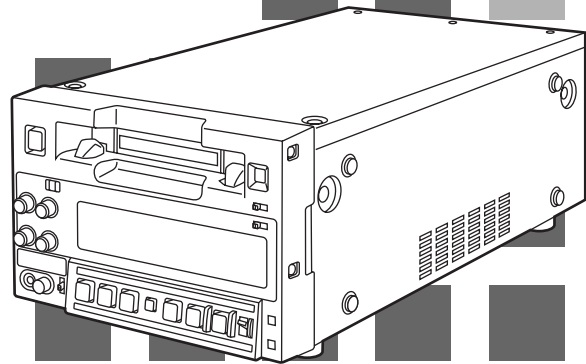

Before operating this product, please read the instructions carefully and save this manual for future use.

For your safety

IMPORTANT

“Unauthorized recording of copyrighted television programmes, video tapes and other materials may infringe the right of copyright owners and be contrary to copyright laws.”

Operating precaution

Operation near any appliance which generates strong magnetic fields may give rise to noise in the video and audio signals. If this should be the case, deal with the situation by, for instance, moving the source of the magnetic fields away from the unit before operation.

■ THIS APPARATUS MUST BE EARTHED

To ensure safe operation the three-pin plug must be inserted only into a standard three-pin power point which is effectively earthed through the normal house-hold wiring.

Extension cords used with the equipment must be three-core and be correctly wired to provide connection to earth. Wrongly wired extension cords are a major cause of fatalities.

The fact that the equipment operates satisfactorily does not imply that the power point is earthed and that the installation is completely safe. For your safety, if in any doubt about the effective earthing of the power point, consult a qualified electrician.

■ DO NOT REMOVE PANEL COVER BY UNSCREWING.

To reduce the risk of electric shock, do not remove cover. No user serviceable parts inside.

Refer servicing to qualified service personnel.

CAUTION:

THE AC OUTLET (MAINS SOCKET) SHALL BE INSTALLED NEAR THE EQUIPMENT AND SHALL BE EASILY ACCESSIBLE.

WARNING:

- TO REDUCE THE RISK OF FIRE OR SHOCK HAZARD, DO NOT EXPOSE THIS EQUIPMENT TO RAIN OR MOISTURE.
- TO REDUCE THE RISK OF FIRE OR SHOCK HAZARD, KEEP THIS EQUIPMENT AWAY FROM ALL LIQUIDS-USE AND STORE ONLY IN LOCATIONS WHICH ARE NOT EXPOSED TO THE RISK OF DRIPPING OR SPLASHING LIQUIDS, AND DO NOT PLACE ANY LIQUID CONTAINERS ON TOP OF THE EQUIPMENT.

CAUTION:

Do not install or place this unit in a bookcase, built-in cabinet or any other confined space in order to maintain adequate ventilation. Ensure that curtains and any other materials do not obstruct the ventilation to prevent risk of electric shock or fire hazard due to overheating.

CAUTION:

TO REDUCE THE RISK OF FIRE OR SHOCK HAZARD AND ANNOYING INTERFERENCE, USE THE RECOMMENDED ACCESSORIES ONLY.

CAUTION:

TO REDUCE THE RISK OF FIRE OR SHOCK HAZARD, REFER MOUNTING OF THE OPTIONAL INTERFACE BOARD TO QUALIFIED SERVICE PERSONNEL.

CAUTION:

TO REDUCE THE RISK OF FIRE OR SHOCK HAZARD, REFER CHANGE OF SWITCH SETTING INSIDE THE UNIT TO QUALIFIED SERVICE PERSONNEL.

CAUTION:

Even when the Power Switch is in the OFF position, a small current flows the filter circuit.

 indicates safety information.

Caution for AC Mains Lead

FOR YOUR SAFETY PLEASE READ THE FOLLOWING TEXT CAREFULLY.

This product is equipped with 2 types of AC mains cable. One is for continental Europe, etc. and the other one is only for U.K.

Appropriate mains cable must be used in each local area, since the other type of mains cable is not suitable.

FOR CONTINENTAL EUROPE, ETC.

Not to be used in the U.K.

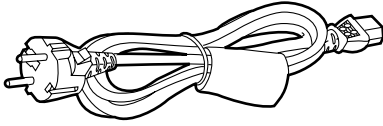

FOR U.K. ONLY

If the plug supplied is not suitable for your socket outlet, it should be cut off and appropriate one fitted.

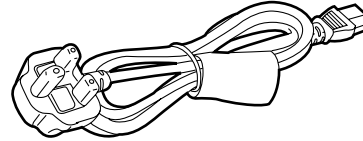

FOR U.K. ONLY

This appliance is supplied with a moulded three pin mains plug for your safety and convenience.

A 13 amp fuse is fitted in this plug.

Should the fuse need to be replaced please ensure that the replacement fuse has a rating of 13 amps and that it is approved by ASTA or BSI to BS1362.

Check for the ASTA mark  or the BSI mark  on the body of the fuse.

If the plug contains a removable fuse cover you must ensure that it is refitted when the fuse is replaced.

If you lose the fuse cover the plug must not be used until a replacement cover is obtained.

A replacement fuse cover can be purchased from your local Panasonic Dealer.

IF THE FITTED MOULDED PLUG IS UNSUITABLE FOR THE SOCKET OUTLET IN YOUR HOME THEN THE FUSE SHOULD BE REMOVED AND THE PLUG CUT OFF AND DISPOSED OF SAFELY. THERE IS A DANGER OF SEVERE ELECTRICAL SHOCK IF THE CUT OFF PLUG IS INSERTED INTO ANY 13 AMP SOCKET.

If a new plug is to be fitted please observe the wiring code as shown below.

If in any doubt please consult a qualified electrician.

WARNING: THIS APPLIANCE MUST BE EARTHED.

IMPORTANT: The wires in this mains lead are coloured in accordance with the following code:

Green-and-Yellow:	Earth
Blue:	Neutral
Brown:	Live

As the colours of the wires in the mains lead of this appliance may not correspond with the coloured markings identifying the terminals in your plug, proceed as follows:

- The wire which is coloured GREEN-AND-YELLOW must be connected to the terminal in the plug which is marked with the letter E or by the Earth symbol \perp or coloured GREEN or GREEN-AND-YELLOW.
- The wire which is coloured BLUE must be connected to the terminal in the plug which is marked with the letter N or coloured BLACK.
- The wire which is coloured BROWN must be connected to the terminal in the plug which is marked with the letter L or coloured RED.

How to replace the fuse

1. Open the fuse compartment with a screwdriver.

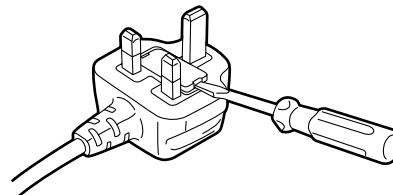

2. Replace the fuse.

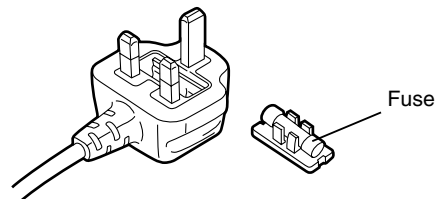

 indicates safety information.

Contents

Introduction	5	Setup (initial settings)	24
Features	5	Setting method using the on-screen menus	24
Parts and their functions	7	Returning to the factory settings	24
Front panel	7	Setting the user defaults	25
Rear panel	12	Loading the user defaults	26
Tapes	14	Menu protection	26
Inserting the tape	14	Releasing the menu protection mode	27
Usable tapes	14	Displaying the DIAG menu	27
Operation	15	Setup menus	28
Turning on the unit's power	15	Menus which are displayed	28
STOP mode	15	SYSTEM	31
Recording	16	BASIC	33
Pause/recording (follow-on recording)	16	OPERATION	37
Playback	17	INTERFACE	40
Cue/review	17	TAPE PROTECT	40
Still image playback	17	TIME CODE	41
Linear 0.3× playback	18	VIDEO	43
Variable speed playback	18	AUDIO	45
Repeat playback	19	MENU	47
Time code & user's bit	20	DIF	48
Time code	20	Error messages	49
User's bit	20	Condensation	51
Setting the time code (from the menu)	20	Emergency eject	52
Setting the time code (from the front panel)	20	Video head cleaning	52
Setting the user's bit	21	Maintenance	52
Playing back the time code and user's bit	21	Specifications	53
Superimposed screen displays	22		

Introduction

The AJ-HD1200A multi-format digital video cassette player is capable of playing not only all types of materials ranging from HD (DVCPRO HD and DVCPRO HD-LP) to SD (DVCPRO50, DVCPRO50P and DVCPRO) recorded in the DVCPRO formats on 1/4-inch wide compact cassette tapes but also consumer DV and DVCAM tapes.

A down-converter provided as a standard feature verifies all tapes, whatever their format, using analog composite output signals.

Furthermore, by installing an optional board, the unit can be used as a recorder to record HD signals (1080i/59.94 Hz, 1080i/50 Hz or 720p/59.94 Hz) in the DVCPRO HD-LP format. In addition, 720/24p over 60p sources recorded using a variable frame rate camera can be converted into 1080/24 PsF format output signals to support cinema applications.

Similarly, 720/25p over 60p sources can be converted into 1080/25 PsF or 576i format output signals.

Thanks to the incorporation of highly efficient digital compression technology, the deteriorations in the image and sound quality during dubbing are now significantly reduced with this high image quality VTR. The compact size and light weight of the unit enable it to be carried around and mounted in a standard rack with ease.

You can perform the unit's settings interactively with the on-screen menus displayed on the TV monitor.

Features

Compact size and light weight.

The unit has a width of 214 mm, a height of 132 mm, and a depth of 428 mm, and weighs only 7.9 kg.

Grips are also attached for easy carry.

Efficient installation in a rack

The unit's width is one-half of 19 inches and its height is 3U: this translates into greater saving of installation space in a standard rack compared to conventional models.

DVCPRO HD cassette tapes used

The unit uses 1/4-inch wide cassette tapes.

<Note>

When recording* HD signals, use DVCPRO HD cassettes.

High image quality

The unit achieves a high image quality by recording 4:2:2 HD component signals with a recording rate (=100 Mbps) which is four times as high as that for existing DVCPRO formats.

1080i or 720p, NTSC or PAL selectable

By switching the settings provided for the video signal input (1080i/59.94 Hz or 720p/59.94 Hz) on the setup menu, the unit can record* and play back the signals of the system selected.

The unit also supports the PAL mode. Playback of 1080i/50 Hz or PAL SD materials is enabled by switching the setting on the system menu.

Frame rate conversion

When playing back a tape recorded at a frame rate of 24 fps using a variable frame rate camera, the tape's signals can be converted to the 1080/24 PsF format and output by selecting a menu item setting. When playing back a tape recorded at a frame rate of 25 fps, the tape's signals can be converted to the 1080/25 PsF or 576i format and output.

<Notes>

- Use tapes that are shot with a variable frame rate camera.
- Do not use dubbed or edited tapes. The tape control information may be lost, making it impossible to convert the signals for playback.
- To convert a tape recorded using a frame rate other than 24 (25) fps to the 1080/24 (25) PsF format, use the frame rate converter (AJ-FRC27) available as an optional accessory.

DVCPRO-compatible playback

In addition to DVCPRO HD-LP playback, the unit can play back tapes recorded using the existing DVCPRO HD, DVCPRO50 and DVCPRO formats. It can also play back consumer DV tapes (SP) and DVCAM tapes.

* The unit's recording function become operational only when the AJ-YA120AG (optional accessory) or AJ-YAD120AG (optional accessory) has been installed.

Features

SD down-converter

The unit comes with a built-in SD down-converter as a standard feature to enable the output of SD SDI signals* and analog composite signals at the same time as HD SDI output signals* and for monitoring the signals on an SD monitor.

Up-converter function*

When an SD format tape is played back, it is possible to up-convert the signals to the HD format while at the same time outputting the signals in the SD format.

Cross-converter function*

The unit comes with a built-in cross-converter to enable 1080i/59 Hz format signals to be converted into 720p/59 Hz format signals or, conversely, to enable 720p/59 Hz format signals to be converted into 1080i/59 Hz format signals.

HD analog component output

This feature enables HD signals to be monitored with ease.

AC/DC operation

The unit supports AC supply voltages ranging from 100V to 240V and DC12V power supply as well.

Follow-on recording function*

Using the REC button and PAUSE button together activates the auto back function, enabling the next image to follow on from the last image with no disruptions in the continuity.

On-screen menu settings

Highly detailed and individualized function settings can be performed on-screen.

Time code

The unit is equipped with a built-in time code generator/time code reader (TCG/TCR). Since time code signals can also be input from an external device*, regeneration to an external time code is possible.

[Multi-functional interfaces]

Serial digital input/output*

The unit's HD component serial I/O interface enables interfacing with HD component video signals and 8-channel digital audio signals using a single BNC connector. (SMPTE 292M/296M/299M) The unit is also equipped with an SD down-converter as a standard feature so that SD component serial signals can be output as well. (SMPTE 259M-C, 272M-A, ITU-R BT.656-4)

Analog video output

Since the unit's analog composite down-converter comes as a standard feature, the signals can be monitored on an SD monitor.

9-pin remote

The unit's 9-pin remote control connector enables it to be operated with an external remote controller (AJ-A95: optional accessory).

IEEE1394 digital input/output

Use of the digital video interface board (AJ-YAD120AG: optional accessory) enables signals to be input and output using an interface which complies with the IEEE 1394 standard.

<Playback formats and output formats>

Playback format	Output format
DVCPRO HD-LP, DVCPRO HD	DVCPRO HD, DVCPRO50, DV
DVCPRO50	DVCPRO50, DV
DVCPRO	DVCPRO, DV
DVCPRO P, DV, DVCAM	DV
When the E-E mode is established: <ul style="list-style-type: none">● Install the AJ-YA120AG board which is available as an optional accessory.● Select a setting other than "1394" for menu item No.600 [VIDEO IN SEL].	DVCPRO HD, DVCPRO50, DV

<Notes>

When any of the settings below is established, no signals will be output from the digital video interface.

- When "23/24," "25(HD)" or "25(SD)" is selected as the menu item No.25 [SYSTEM FREQ] setting
- When "60/24" is selected as the menu item No.030 [HD FREQUENCY] setting
- When "720p" is selected as the menu item No.630 [1080i→HD_OUT] setting
- When "1080i" is selected as the menu item No.632 [720p→HD_OUT] setting

* The unit's recording function become operational only when the AJ-YA120AG (optional accessory) or AJ-YAD120AG (optional accessory) has been installed.

Parts and their functions

Front panel

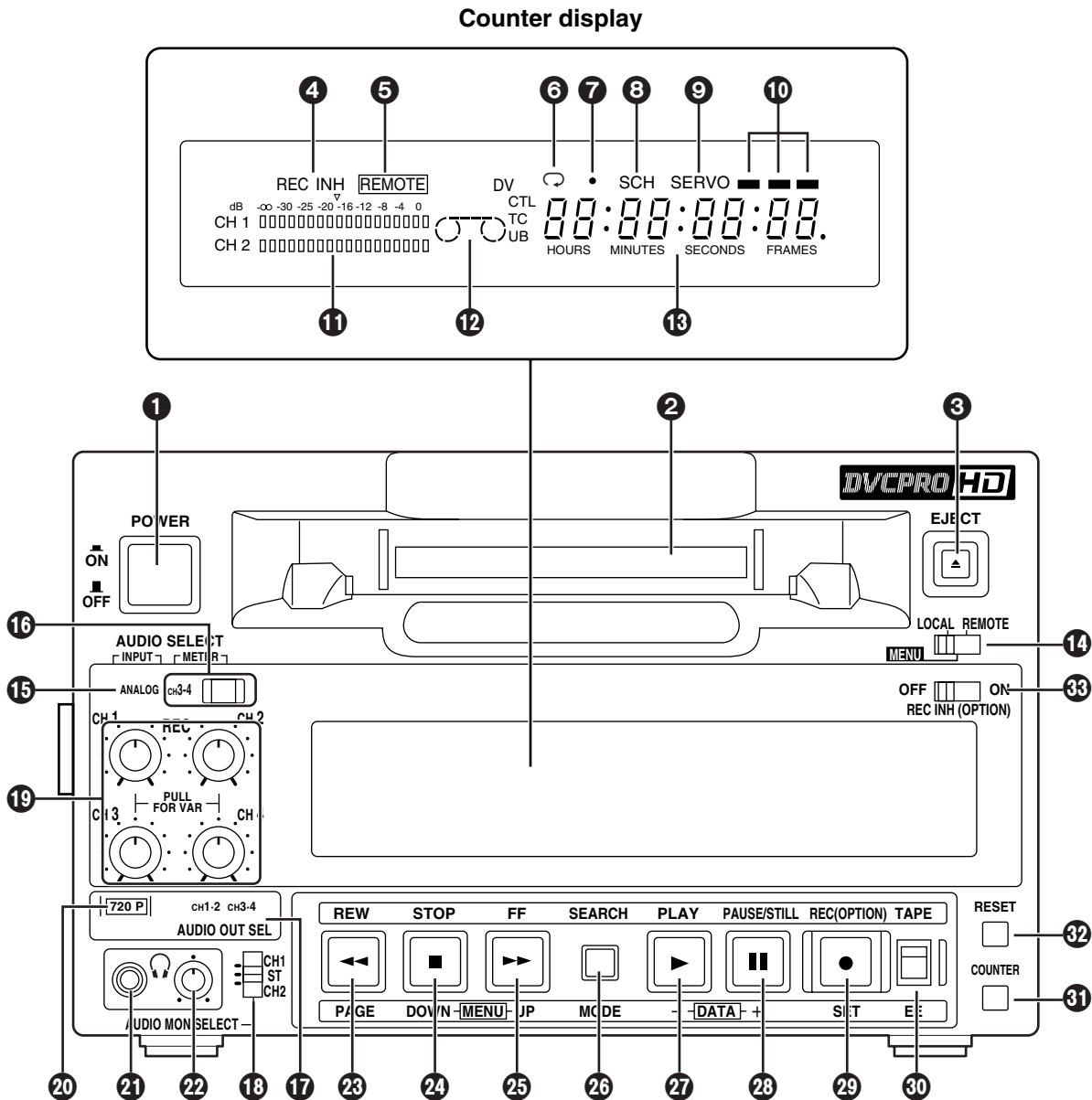

1 POWER switch

2 Cassette slot

Align the center of the cassette with the center of the slot and push it gently inside.
The cassette tape is loaded automatically.

3 EJECT button

When this is pressed, the tape is unloaded, and several seconds later the cassette will be automatically ejected.
When it is pressed while the counter display shows the CTL display, the display will be reset.

4 REC/REC INH lamp

REC: The lamp lights during recording*.
REC INH:

The lamp lights when the cassette is set to the accidental erasure prevention status.
It also lights when the REC INHIBIT switch 33 is set to the ON position. Recording operations cannot be performed while it is lighted.

5 REMOTE lamp

This lights when the LOCAL/MENU/REMOTE switch 14 is set to the REMOTE position.

* This function is operational only when the AJ-YA120AG (optional accessory) has been installed.

Parts and their functions

Front panel

⑥ REPEAT lamp

This lights during repeat playback.

<Note>

The lamp flashes and repeat playback is not performed if the counter display mode which has been set using menu items No.161 [CTL (TC) BGN] and No.162 [END] is at variance from the counter display mode used for repeat playback.

⑦ SYSTEM format lamp

This indicates the status of the mode which has been selected by menu item No.15 [SYSTEM FREQ].

On: 59/60 Hz mode

Off: 50 Hz/25 PsF mode

Flashing: 23/24 Hz mode*, 25 Hz mode*

⑧ SCH lamp*

When SD signals are supplied to the HD/SD REF VIDEO IN connector, this lights while the subcarrier phase of the signals is within the prescribed range.

⑨ SERVO lamp

This lights when the drum servo or capstan servo is locked.

⑩ Channel condition lamps

The lamp corresponding with the error rate status lights to indicate the channel condition.

(Green → white → red)

Green : This lights when the error rates of both the video and audio playback signals are satisfactory.

White : This lights when the error rate of either the video playback signals or audio playback signals has deteriorated. Normal playback images appear even while it is lighted.

Red : This lights when correction or interpolation is initiated for either the video playback signals or audio playback signals.

⑪ Level meter

This indicates the levels of the audio signals.

The levels of the input signals are shown during recording* or E-E* selection, and the levels of the output signals are shown during playback.

⑫ Cassette insertion/tape travel indicator lamp

This lights when a cassette is inside the unit.

: This appears when a tape is inserted and the STANDBY ON mode is established.

: This appears when a tape is inserted and the STANDBY OFF (HALF LOADING) mode is established.

: This appears when the tape is traveling, and the segment display moves as the tape travels.

: When the fan has shut down, the “○” corresponding to the stopped side flashes.

⑬ Counter display

This displays the TC and CTL counts, user's bit (UB), remaining tape length and total tape length as well as the on-screen information and other messages.

If the voltage drops when the unit is powered with DC power supply, the display flashes to provide a warning.

When the voltage drops down to 10.6 V or so, the unit's power is automatically turned off. (When “TYPE-A” or “TYPE-B” is not selected as the menu item No.180 [BATTERY SEL] setting)

CTL, TC and UB lamps

The corresponding lamps flash when the TC and UB information cannot be read during playback.

The lamps remain lighted when the information can be read properly.

⑭ LOCAL/MENU/REMOTE switch

Use this switch to select the menu settings or control the unit from an external device.

LOCAL:

Select this position when the unit is to be operated using the controls on its operation panel.

MENU:

Select this position to perform on-screen menu settings.

REMOTE:

Select this position when the unit is to be operated using the external remote controller (AJ-A95).

* This function is operational only when the AJ-YA120AG (optional accessory) has been installed.

Parts and their functions

Front panel

15 ANALOG lamp*

This lights when ANALOG is selected for the audio input signals as the menu item No.700 [AUDIO IN SEL] setting. When it is off, the HD SDI signal input or INT SG status is established.

<Note>

The signals which are input for each of the channels when analog signals are supplied are recorded on the following audio tracks of the tape.

- CH1 input → CH1 and CH5 tracks
- CH2 input → CH2 and CH6 tracks
- CH3 input → CH3 and CH7 tracks
- CH4 input → CH4 and CH8 tracks

* This function is operational only when the AJ-YA120AG (optional accessory) has been installed.

16 METER button and lamp (CH3•4)

Each time the METER button is pressed, the signals which are output to the headphone jack 2 and represented on the level meter display are switched between CH1/CH2 and CH3/CH4.

When the CH1/CH2 signal levels are displayed, the CH3•4 lamp goes off.

<Note>

The METER button takes effect when LINE is selected as the menu item No.780 [AUD OUT SEL] setting for the analog audio output connectors.

17 Audio output lamps (CH1•2, CH3•4)

The audio channels to which the signals are output are indicated by these lamps.

18 Audio monitor selector switch

This is used to select the audio monitor output and headphone output channel.

Reference:

Combination of setup menu items and audio outputs selected by the front panel switches

Setup menu item			Front panel				Rear panel AUDIO OUT connectors				
No.780 AUD OUT SEL	No.770 MONITOR MIX	No.771 H.PHONE MIX	Audio monitor selector switch 18	Audio output lamps 17	METER lamp 16	Headphone output	CH1	CH2	CH3/L	CH4/R	AUDIO MONITOR
LINE	—	—	CH1	CH1•2 CH3•4	Off	L=R (CH1)	CH1	CH2	CH3	CH4	L=R (CH1)
		STEREO	ST		CH3•4	L=R (CH3)					L=R (CH3)
					Off	L=CH1/R=CH2					L=CH1/R=CH2
		CH1+2	CH1+2		CH3•4	L=CH3/R=CH4					L=CH3/R=CH4
—	CH2	Off	L=R (CH1+2)	L=R (CH1+2)							
		CH3•4	L=R (CH3+4)	L=R (CH3+4)							
		Off	L=R (CH2)	L=R (CH2)							
		CH3•4	L=R (CH4)	L=R (CH4)							
CH1/2	—	—	CH1	CH3•4	Off	L=R (CH1)	CH1	CH2	L=CH1	R=CH1	L=R (CH1)
	STEREO	STEREO	ST			L=CH1/R=CH2			L=CH1	R=CH2	L=CH1/R=CH2
						L=R (CH1+2)			L=CH1/R=CH2	L=R (CH1+2)	
	CH1+2	STEREO	CH1+2			L=CH1/R=CH2			L=CH1+2	R=CH1+2	L=CH1/R=CH2
—	—	CH2	L=R (CH1+2)	L=R (CH1+2)							
		—	CH2	L=R (CH2)	L=R (CH2)						
CH3/4	—	—	CH1	CH3•4	CH3•4	L=R (CH3)	CH3	CH4	L=CH3	R=CH3	L=R (CH3)
	STEREO	STEREO	ST			L=CH3/R=CH4			L=CH3	R=CH4	L=CH3/R=CH4
						L=R (CH3+4)			L=CH3/R=CH4	L=R (CH3+4)	
	CH1+2	STEREO	CH1+2			L=CH3/R=CH4			L=CH3+4	R=CH3+4	L=CH3/R=CH4
—	—	CH2	L=R (CH3+4)	L=R (CH3+4)							
		—	CH2	L=R (CH4)	L=R (CH4)						

Parts and their functions

Front panel

19 Analog audio signal recording level controls*

These are used to adjust the recording levels of the analog audio signals for CH1, CH2, CH3 and CH4 (coupled to CH5, CH6, CH7 and CH8).

These are “pull for variable” controls: pull up a control to adjust it. If a control is pulled down, the signals of the corresponding channel are set to the default level.

<Note>

These controls cannot be used to adjust the levels of HD digital audio signals.

20 720p lamp

This lights when the 720p system is selected.

21 Headphone jack

When stereo headphones are connected to this jack, the recording* or playback sound can be monitored through the headphones.

22 Volume control

This is used to adjust the headphones volume.

23 REW button

Press this to rewind the tape.

While the button is held down in one of the search modes (search still, FWD search, FWD search still or REV search still), the REV search mode is established, and the tape is reviewed at the speed selected using menu item NO.150 [SEARCH SPEED]. (See page 17)

When the button is pressed in one of the slow modes (slow still, FWD slow or FWD slow still), the tape is played back at the REV linear 0.3× speed. (See page 18)

24 STOP button

When this is pressed, the tape stops traveling, and when the TAPE/EE switch 30 is set to TAPE, still images can be monitored.

The cylinder continues to rotate even in the stop mode, and the tape remains tightly wound around it.

When the unit has been in the stop mode for a period exceeding the prescribed time, it is automatically set to the standby OFF (half loading) mode in order to protect the tape.

The stop mode is established immediately after a tape is inserted into the unit.

When a still image is displayed, noise may appear on the monitor: this is normal and not indicative of trouble.

25 FF button

Press this to fast forward the tape.

While the button is held down in one of the search modes (search still, REV search, REV search still or FWD search still), the FWD search mode is established, and the tape is cued at the speed selected using menu item NO.150 [SEARCH SPEED]. (See page 17)

When the button is pressed in one of the slow modes (slow still, REV slow or REV slow still), the tape is played back at the FWD linear 0.3× speed. (See page 18)

26 SEARCH button

When this is pressed, the unit is set to the search mode or slow mode. (See pages 17, 18)

27 PLAY button

Press this to start playback.

Recording starts when it is pressed together with the REC button.

28 PAUSE/STILL button

When this is pressed during recording, the tape temporarily stops (pauses). When it is pressed again, recording* is resumed.

When it is pressed during playback, a still image appears. When it is pressed again, playback is resumed.

When it is pressed during FWD or REV search, the tape pauses (FWD or REV search still). When it is pressed again, the FWD or REV search is resumed.

When it is pressed during FWD or REV slow playback, the tape pauses (FWD or REV slow still). When it is pressed again, the FWD or REV slow playback is resumed.

In the FWD or REV slow playback mode, the tape is played back at the linear 0.3× speed.

When the tape pauses, noise may appear on the monitor: this is normal and not indicative of trouble. (See page 18)

* This function is operational only when the AJ-YA120AG (optional accessory) or AJ-YAD120AG (optional accessory) has been installed.

Parts and their functions

Front panel

29 REC button*

No optional board installed

This unit is a video cassette player so it cannot record by pressing the REC button.

When the REC button is pressed, the REC INH lamp on the counter display lights for several seconds. When T&S&M has been selected as the menu item No.006 [DISPLAY SEL] setting, "NO OPTION FOR REC" appears in the superimposed mode display area.

When the AJ-YA120AG or AJ-YAD120AG is installed

When the REC button is pressed together with the PLAY button, recording starts. When it is pressed during stop or eject, the input video signals and audio signals can be checked even when the TAPE/EE switch is set to TAPE.

The value of the time code generator can also be checked. (REC CHECK mode)

The REC CHECK mode is released when the STOP button or other operation button is pressed.

30 TAPE/EE switch

This is used to select the signals which are to be output in the STOP mode.

TAPE:

The signals played back from the tape are output.

EE:

No optional board installed

The signals selected by menu item No.106 [EJECT EE SEL] are output. The black signal for the video signals and mute for the audio output are the factory settings.

When the AJ-YA120AG or AJ-YAD120AG is installed

The signals selected by menu item No.600 [VIDEO IN SEL] are output as the video signals, and the signals selected by menu item No.700 [AUDIO IN SEL] are output as the audio signals.

However, when "1394" is selected as the VIDEO IN SEL setting, the audio input signals will also be supplied from the DV connector (digital video interface).

<Note>

The image and sound may be disrupted when this switch's position is changed.

31 COUNTER button

This is used to switch the counter display.

Each time it is pressed, the display is switched by one step in the following sequence: CTL → TC → UB → r → PB FORMAT → CTL and so on.

CTL : The tape timer (control signal) is displayed.

TC : The time code is displayed.

UB : The user's bit is displayed.

r : The remaining tape length and total tape length are displayed in 1-minute increments.

Example:

r30-46 = 30 minutes of tape remaining out of a total tape length of 46 minutes

PB FORMAT:

The format of the tape now playing is displayed.

Playback tape format	Counter display
DVCPRO HD-LP (1080i)	Hd 1080
DVCPRO HD-LP (720P)	Hd 720P
DVCPRO HD (1080i)	Hd 1080 SP
DVCPRO HD (720P)	Hd 720P SP
DVCPRO50 (422)	Sd 50
DVCPRO (411)	Sd 25
DVCPRO50 (420P)	Sd 50P
DV	The DV lamp on the counter display lights.
DVCAM	—

32 RESET button

When this is pressed in the CTL mode, the counter display is reset to zero.

33 REC INHIBIT switch*

This is used to enable or disable recording on the cassette tape.

ON : Recording on the cassette tape is disabled. The REC INHIBIT lamp on the display lights.

OFF : When the cassette tape's accidental erasure prevention mechanism is at the recording enable setting, recording onto the cassette tape is enabled.

* This function is operational only when the AJ-YA120AG (optional accessory) or AJ-YAD120AG (optional accessory) has been installed.

Parts and their functions

Rear panel

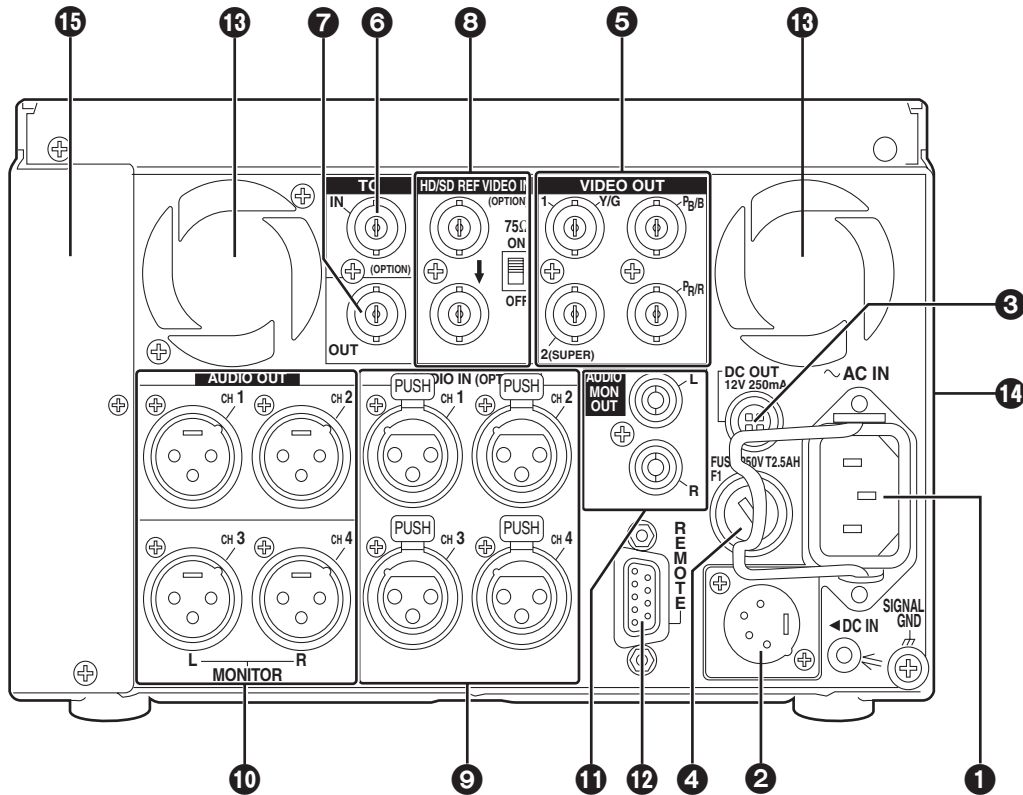

1 AC IN inlet

This is the AC power inlet.
Connect the accessory power cable here.
When both an AC power supply and DC power supply have been connected, the AC power supply takes priority.

2 DC IN socket

This is the input connector for the DC 12V supply voltage.
Use the optional AC adapter (AJ-B75 or AJ-B95).
When the voltage has dropped to around 10.6V, the unit's power is automatically turned off. (When "TYPE-A" or "TYPE-B" is not selected as the menu item No.180 [BATTERY SEL] setting)
Even when the supply voltage is restored later, the power will not automatically come back on. The POWER switch must be set to OFF and then back to ON several seconds later.
When both AC power supply and DC power supply are connected, the AC power supply takes priority.

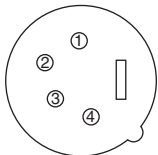

Pin No.	Signal
1	Ground
2	—
3	—
4	+12 V

<Note>

Supplying +12V power to the GND terminal by mistake may give rise to ignition, resulting in a fire, or it may cause injury.

3 DC OUT socket

This is the DC 12V output socket.
Power is supplied from here to the external remote controller (AJ-A95).
The DC power cable is packed together with the AJ-A95.



Pin No.	Signal
1	Ground
2	—
3	—
4	+12 V

4 Fuse holder

This holds the AC 250 V/2.5 A fuse (time lag type).
<Note>
Use the fuse specified by Panasonic.

Parts and their functions

Rear panel

⑤ VIDEO OUT (1, 2, Y/G, PB/B, PR/R) connectors

By changing the menu item No.615 [V OUT SEL] setting, either analog composite video signals or HD analog component Y (or G) signals are output from the VIDEO OUT1 connector.

By selecting the menu item No.616 [OUT MATRIX] setting, Y/PB/PR or R/G/B signals can be selected as the HD analog component signals.

Video signals with superimposed information embedded can be output from the VIDEO OUT2 connector.

Whether superimposed information is to be embedded in the signals is selected using menu item No.005 [SUPER].

<Notes>

- When HD analog component output or HD SDI output* signals are output with the 60 Hz or 24 Hz system frequency, the SD SDI* signals will be output without the sync signals (NO SYNC), and the analog composite signals will be output in the black-and-white mode (burst OFF).
- A dummy sync signal for preventing the monitor from operating incorrectly is added to the sync signals in the RGB output.

⑥ TC IN connector*

This is used to record an external time code onto the tape.

⑦ TC OUT connector

This is used to output the playback time code during playback.

During recording*, the time code generated by the internal time code generator is output from this connector.

⑧ HD/SD REF VIDEO IN connectors and 75Ω termination switch*

These are the input connectors for the HD/SD reference video signal. For termination, set the switch to ON.

<Notes>

- When inputting an HD reference signal to the connector, input a tri-level sync signal with positive and negative polarities. Also, supply signals matching the input signals and tape format.
- When inputting an SD reference signal to the connector, use composite video signals which satisfy the RS-170A standard or a black burst signal.

⑨ AUDIO IN connectors (CH1, CH2, CH3, CH4)*

These are the input connectors for the analog audio signals.

⑩ AUDIO OUT/MONITOR connector (CH1, CH2, CH3, CH4)

These are the output connectors for the analog audio signals.

The CH3 and CH4 connectors are also used as the audio monitor output connectors (left and right channels). (See page 9)

⑪ AUDIO MONITOR connectors

These are the audio monitor output connectors.

The same signals are output as the headphone output signals.

<Note>

The output signal level is fixed.

⑫ REMOTE CONTROL connector

An external remote controller (AJ-95: optional accessory) is connected here to enable the unit to be operated using an external device.

<Notes>

- Set the LOCAL/MENU/REMOTE switch to REMOTE.
- The connector satisfies the RS-422A interface standard, but no editing-related functions are operational.

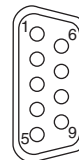

Pin No.	Signal
1	Frame Ground
2	Transmit A
3	Receive B
4	Receive Common
5	—
6	Transmit Common
7	Transmit B
8	Receive A
9	Frame Ground

⑬ Fan motor

This is provided to cool off the unit.

⑭ Grips

Grips are provided on both sides of the unit, but the unit should be placed on a flat, level surface for operation.

⑮ Option panel

When the AJ-YA120AG or AJ-YAD120AG option is to be installed, remove this panel, and replace it with the panel packed with the option.

For details on installation, refer to the instructions accompanying the option concerned.

* This function is operational only when the AJ-YA120AG (optional accessory) has been installed.

Inserting the tape

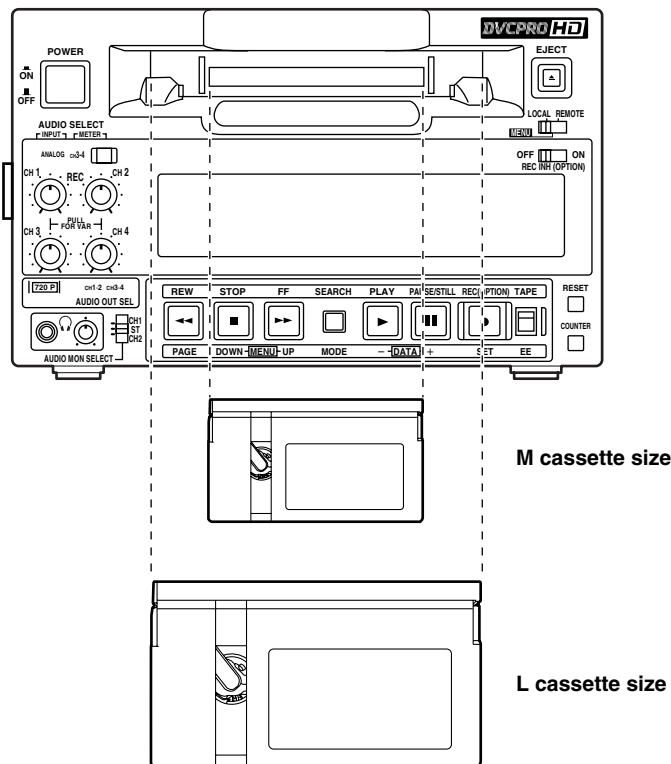

Align the cassette with the center of the slot and push it gently inside.
The cassette tape is loaded automatically.

Usable tapes

Consumer DV, DVCAM cassettes

Standard DV, DVCAM cassettes

Mini DV, DVCAM cassettes

Note that long-playing mini DV cassette tapes (80 minutes in standard mode, 120 minutes in long-playing mode) cannot be used.

For consumer DV tapes, Panasonic recommends the Panasonic brand.

M cassettes

DVCPRO HD-LP

Tapes with up to 33 minutes of recording/playback (AJ-HP33EMG)

DVCPRO 25/50/50P HD playback tapes

L cassettes

DVCPRO HD-LP

Tapes with up to 92 minutes of recording/playback (AJ-HP64ELG, AJ-HP92ELG)

DVCPRO 25/50/50P HD playback tapes

Precautions for using consumer DV and DVCAM cassettes

- Use a cassette adapter (AJ-CS455P) when using mini DV or DVCAM cassette tapes. Inserting a mini DV or DVCAM cassette tape into the unit without using a cassette adapter may cause trouble or malfunctioning.
- Tapes recorded in the LP modes cannot be played back.
- When editing material recorded on a consumer DV or DVCAM cassette tape, record the material onto a DVCPRO tape or onto another broadcast VTR before use.
- The maximum transport speed of a mini DV or DVCAM cassette tape is 32x normal tape speed.
- The images may be disrupted when a consumer DV or DVCAM cassette tape is played back in a slow motion mode.
- To protect your tapes, refrain as much as possible from repeatedly cueing up the tapes in consumer DV or DVCAM cassettes at the same place.
- When consumer DV or DVCAM cassette tapes are used, the maximum STILL TIMER time is set to 10 seconds.

Operation

Turning on the unit's power

Before attempting to operate the unit, check whether the equipment has been connected properly. Ensure that the unit is placed on a flat, level surface for operation.

1 Turn on the unit's power.

2 Insert a cassette tape.

Insert the cassette tape at the correct position without forcing it in any way.

3 Check that the STOP lamp has lighted.

As soon as the tape is inserted, the cylinder starts rotating automatically, the tape is loaded, and the unit is set to the stop mode.

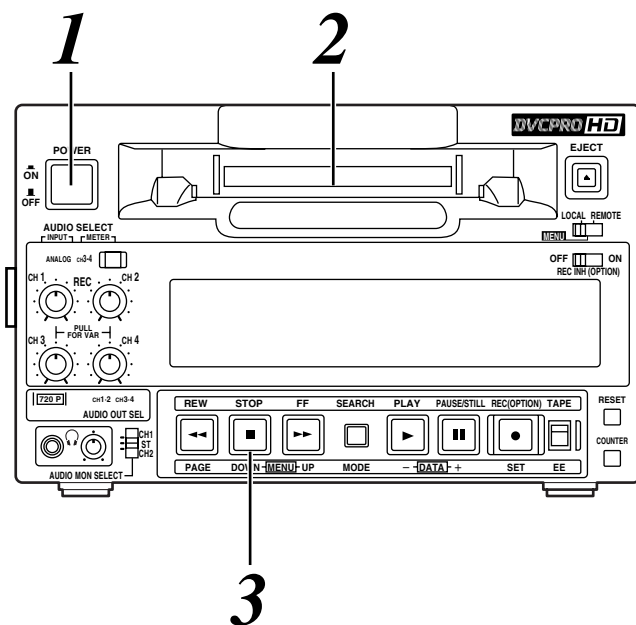

STOP mode

1 When the STOP button is pressed, the unit is set to the STOP mode.

The STOP lamp lights, and the tape stops traveling.

- In order to protect the tape inside the unit, the unit is set to the tape protection mode when the time selected as the menu item No.400 [STILL TIMER] has elapsed.

When the STOP, REW, FF or PLAY button is pressed, the unit is transferred to the corresponding mode.

<Precaution for STILL TIMER setting>

- If the same locations on the same tape are repeatedly used, the cumulative standby time at these same locations will continue to mount up. To protect your tapes, minimize the amount of standby time at the same locations on the tapes.

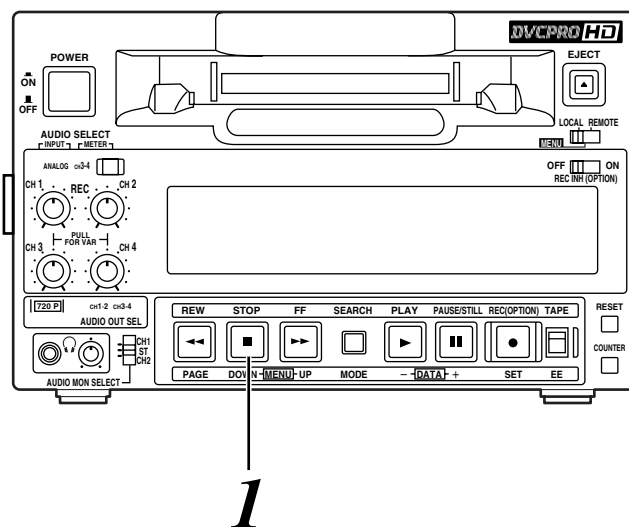

<Notes>

- Before turning off the power, press the EJECT button to eject the cassette.
- When ON is selected as the menu item No.104 [REF ALARM] setting, the STOP button's lamp will flash if the reference video input signal is not supplied.

Operation

Recording

This function can be used only when the AJ-YA120AG (optional accessory) has been installed.

1 Set the cassette tape's erasure prevention tab to recording enable, and insert the tape.

2 Press the STOP button to set the unit to the STOP mode.

3 **Selecting the input video signals**
Use menu item No.600 [VIDEO IN SEL] to select the video input signals.

4 **1. Selecting the input audio signals**
1) Connect the signals to be recorded.
2) Use menu item No.700 [AUDIO IN SEL] to select the audio input signals.

<Note>

When "1394" is selected as the menu item No.600 [VIDEO IN SEL] setting, the audio signals are input from the DV connector (digital video interface) regardless of the AUDIO IN SEL setting.

2. Adjusting the analog audio levels

- Adjust the levels of the audio input signals when analog audio signals have been selected as the audio input signals.

When the audio recording level controls are at their pushed-in positions, the audio signals are recorded at the proper levels.

<Note>

When HD SDI signals or signals from the DV connector (digital video interface) are selected as the audio input signals, it is not possible to adjust their level.

5 While holding down the REC button, press the PLAY button.

The REC and PLAY lamps light, and recording commences.

When ALL has been selected as the menu item No.154 [AUTO BACK] setting, the tape is rewound for several seconds from the position where the REC and PLAY buttons were pressed. The tape will run up, and recording will start from the position where the REC and PLAY buttons were pressed so that the new recording will follow on from the previous recording with no disruptions in the continuity of the images.

6 To end the recording, press the STOP button. Recording now ends, and the unit is set to the stop mode.

<Note>

Check that the SERVO lamp remains lighted during recording. When it flashes or it is off, the playback images will be disrupted.

Pause/recording (follow-on recording)

1 Press the PAUSE/STILL button while the cassette tape is playing back.

2 Press the REC button to set the unit to the REC PAUSE mode.

The monitor display now switches to the E-E screen.

When REC-P or ALL has been selected as the menu item No.154 [AUTO BACK] setting, the tape will be rewound for several seconds from the position where the PAUSE/STILL button was pressed.

3 Press the PAUSE/STILL button to start recording.

The tape now runs as far as the position where the PAUSE/STILL button was pressed in step **1**, and recording commences.

<Note>

The E-E screen is now displayed.

4 Press the PAUSE/STILL button again to temporarily stop the recording.

When REC-P or ALL has been selected as the menu item No.154 [AUTO BACK] setting, the tape will be rewound for several seconds from the position where the PAUSE/STILL button was pressed, and then it will stop temporarily.

5 Follow-on recording can be performed by repeating steps **3** and **4**.

Operation

Playback

1 Insert a cassette tape into the unit.

2 Press the **PLAY** button.
Normal playback now commences.

3 To end playback, press the **STOP** button.
The VTR is set to the stop mode.

<Notes>

- Check that the SERVO lamp remains lighted during recording. When it flashes or it is off, the playback images will be disrupted.
- When playback starts up, the images will be disrupted for a moment.

Cue/review

When the FF or REW button is pressed while one of the search modes (search still, FWD search, REV search, FWD search still or REV search still) is established, the tape is cued or reviewed at the speed which was set using menu item No.150 [SEARCH SPEED].

Furthermore, when the FF is pressed during cue or the REW button is pressed during review, the cue or review speed can be increased to 1.85x normal tape speed. When the FF or REW button is pressed again, the tape is restored to the speed which was set using menu item No.150 [SEARCH SPEED].

When the SEARCH button is pressed in the FF mode or REW mode, the tape first slows down to the speed which was set using menu item No.150 [SEARCH SPEED], and cue or review is then performed.

When the PAUSE/STILL button is pressed during cue or review, the tape is temporarily stopped (paused). When it is pressed again, cue or review is resumed.

VTR operation status	Button operated	Resulting VTR operation
PLAY or STOP	SEARCH	Search still
	FF or REW	FF or REW
FF	PLAY or STOP	PLAY or STOP
	SEARCH	FWD search (cue)
REW	PLAY or STOP	PLAY or STOP
	SEARCH	REV search (review)
Search still	PLAY or STOP	PLAY or STOP
	FF	FWD search (cue)
	REW	REV search (review)
FWD search (cue)	SEARCH	FF
	FF	FWD search speed switching
	REW	REV search (review)
	PAUSE/STILL	FWD search still
REV search (review)	SEARCH	REW
	FF	FWD search (cue)
	REW	REV search speed switching
	PAUSE/STILL	REV search still
FWD search still	PAUSE/STILL or SEARCH or REW	FWD search (cue)
	REW	REV search (review)
REV search still	PAUSE/STILL or SEARCH or REW	REV search (review)
	FF	FWD search (cue)
Any status	PLAY	PLAY
	STOP	STOP

Still image playback

Press the PAUSE/STILL button during playback. When it is pressed again, normal playback is restored.

<Notes>

- No sound is heard during still image playback.
- Noise may appear on the still images.

Operation

Linear 0.3× playback

The unit is set to the slow still mode when the SEARCH button is pressed during still image playback (PLAY PAUSE).

When the FF or REW button is now pressed, the tape is played back at the linear 0.3× speed.

Pressing the PAUSE/STILL button during linear 0.3× playback will pause the tape.

When the PAUSE/STILL button is pressed again, linear 0.3× playback resumes.

Variable speed playback

(when AJ-A95 is connected)

When the AJ-A95 (option) is connected to the REMOTE connector, the tape speed can be varied by operating the search dial on the AJ-A95.

<Notes>

- Noise may appear on the screen when the tape is playing back at a speed other than 1×.
- During variable speed playback, the sound recorded on the analog CUE track is played back.

VTR operation status	Button operated	Resulting VTR operation
PLAY	PAUSE/STILL	PLAY PAUSE
PLAY PAUSE	PAUSE/STILL or PLAY	PLAY
	SEARCH	Slow still
Slow still	PLAY	PLAY
	FF	FWD slow
	REW	REV slow
FWD slow	REW	REV slow
	SEARCH or PAUSE/STILL	FWD slow still
REV slow	FF	FWD slow
	SEARCH or PAUSE/STILL	REV slow still
FWD slow still	PAUSE/STILL or SEARCH or FF	FWD slow
	REW	REV slow
REV slow still	PAUSE/STILL or SEARCH or REW	REV slow
	FF	FWD slow
Any status	PLAY	PLAY
	STOP	STOP
Any status	STOP → FF	FF
	STOP → REW	REW

Repeat playback

Setting the BEGIN and END points

1 Set the VTR to the menu mode.
(This is done by setting the LOCAL/MENU/REMOTE switch to the MENU position).

2 Select menu item No.161 [CTL (TC) BGN] or No.162 [END], and press the DATA+ button (PAUSE/STILL button) or DATA- button (PLAY button).

<Note>

Whether a setting is to be entered can be selected by operating the DATA+ button and DATA- button.

The --:--:--:-- display appears when there is no setting. When repeat playback is performed in this status, the BEGIN point serves as the tape start and END point as the tape end.

3 Use the COUNTER button to select TC or CTL.
<Note>

When the RESET button is pressed, the display is reset to 00:00:00:00.

4 Use the UP button (FF button) and DOWN button (STOP button) to select the digit to be changed (the one that is flashing).

The frame digits cannot be selected, and they always appear as "00."

5 The DATA+ button (PAUSE/STILL button) and DATA- button (PLAY button) are used to change the value displayed.

6 After performing the settings, press the SET button (REC button).

The settings are now stored in the memory.

<Note>

If the MODE button (SEARCH) button is pressed without first pressing the SET button after the settings have been performed, the settings will not be stored in the memory and the statuses established prior to those settings will be restored.

7 Set the LOCAL/MENU/REMOTE switch to the LOCAL or REMOTE position.

Setting the repeat playback mode

1 Set the VTR to the menu mode.
(This is done by setting the LOCAL/MENU/REMOTE switch to the MENU position).

2 Select menu item No.160 [MEMORY MODE], and select the repeat playback mode.

Setting	Operation
OFF	Normal operation
M-STOP	When the tape is fast forwarded or rewound, it stops near the BEGIN point.
REPT1	When the tape is played back to the END point, it is rewound to the BEGIN point where it stops.
CONT	When the tape is played back to the END point, it is rewound to the BEGIN point and played back again, and these operations are repeated.

3 Set the LOCAL/MENU/REMOTE switch to the LOCAL or REMOTE position.

<Notes>

- The image will deteriorate if the same tape is played back over and over again. Once a tape has been played back for a hundred or so times, replace it with a new one.
- The image which is to be output when the tape is returned to the BEGIN point in the repeat playback mode can be set using menu item No.163 [REPT MODE].
When FREEZE is selected as the menu item No.163 [REPT MODE] setting, the playback image will not freeze properly if the tape end is set to serve as the END point. Set the END point in a section of the tape where images have been recorded.
- If the counter display mode (TC/CTL) established using the menu item No.161 [CTL (TC) BGN] or No.162 [END] setting and the counter display mode (TC/CTL) in which repeat playback is to be performed do not correspond, the REPEAT lamp flashes, and the repeat playback operation will not be performed.

Time code & user's bit

Time code

The time code signals generated by the time code generator (time code signal generator) are recorded on the tape, and their values are read by the time code reader (time code signal reader) to indicate absolute positions on the tape in increments of hours, minutes, seconds and frames.

The time code itself is written in the sub code area (data area) of the helical track.

This enables the VTR's playback speed to be read from the stop mode to slow playback or even to high-speed playback.

The time code values are indicated on the display or superimposed onto the screen.

TCR. 00 : 07 : 04 : 24
↑ ↑ ↑ ↑
Hours Minutes Seconds Frames

User's bit

The user's bit is a 32-bit (8-digit) information frame among the time code signals which has been released to users. It can be used to record the operator number or other such information.

The alphanumeric characters which can be used for the user's bit are the numbers 0 to 9 and the letters A, B, D, E and F.

Setting the time code

(from the menu)

This function can be used only when the AJ-YA120AG (optional accessory) or AJ-YAD120AG (optional accessory) has been installed.

- 1 Set the VTR to the menu mode.**
(This is done by setting the LOCAL/MENU/REMOTE switch to the MENU position).
- 2 Set menu item No.507 [TC SOURCE] to INT.**
- 3 Select menu item No.530 [TC PRESET].**

4 When the DATA+ button (PAUSE/STILL button) or DATA- button (PLAY button) is pressed, the value of the first digit starts flashing.

5 When the MENU-UP button (FF button) or MENU-DOWN button (STOP button) is pressed, the next digit whose value is to be changed starts flashing.

6 Use the DATA+ button (PAUSE/STILL button) or DATA- button (PLAY button) to change the value.

7 After performing the setting, press the SET button (REC) button.
(The display now returns to the regular menu screen.)

8 Set the LOCAL/MENU/REMOTE switch to the LOCAL or REMOTE position.

Setting the time code

(from the front panel)

When AJ-YA120AG (optional accessory) or AJ-YAD120AG (optional accessory) has been installed and INT has been selected as the menu item No.507 [TC SOURCE] setting, the time code can be set from the front panel.

1 Hold down the RESET button for at least two seconds.

Now perform steps 4 to 7 of "Setting the time code (from the menu)."

<Notes>

- Displayed as the initial value is the current value of the time code generator.
- Pressing the RESET button while TC PRESET is being set (status in which the numbers are flashing) will reset the setting to 00000000.
- The time code cannot be set when REGEN is set using a combination of menu items No.503 [TCG MODE] and No.505 [TCG REGEN].
- When the MODE button (SEARCH button) is pressed without first pressing the SET button after the setting has been performed, the time code setting is canceled, and the display returns to the regular menu screen.

Time code & user's bit

Setting the user's bit

This function can be used only when the AJ-YA120AG (optional accessory) or AJ-YAD120AG (optional accessory) is installed.

1 Set the VTR to the menu mode.
(This is done by setting the LOCAL/MENU/REMOTE switch to the MENU position).

2 Select menu item No.531 [UB PRESET].

The following steps are the same as for setting the time code.

Playing back the time code and user's bit

1 Set the unit to the STOP mode.

2 Set the COUNTER button to TC or UB.
TC : The time code is displayed.
UB : The user's bit is displayed.

3 Press the PLAY button.
Playback commences, and the time code appears on the display.
When CMPST has been selected as the menu item No.005 [SUPER] setting, the time code value is superimposed onto the video signals which are output from the VIDEO OUT2 connector.

<Notes>

- When a drop frame time code is read, the colon between the seconds and frames is replaced with a period.
- When the time code signal is temporarily missing, it is automatically filled in by the CTL signal. Below are displayed.

Superimposed display

T*R	00 : 07 : 04 : 24
An asterisk * appears here when the time code signal is temporarily missing.	In the case of a drop frame, a period (.) appears in place of the colon between the seconds and frames.

Counter display

TC —	00 : 07 : 04 : 24
UB —	
This flashes when the time code signal is temporarily missing.	In the case of a drop frame, a period (.) appears in place of the colon between the seconds and frames.

Superimposed screen displays

The control signal, time code, etc. are displayed on the TV monitor in the form of abbreviations when the unit's VIDEO OUT2 connector is connected to a TV monitor.

In addition, when the optional AJ-YA120AG is installed, the connector from which the superimposing is output can be changed using the menu item No.005 [SUPER] setting. (See page 33)

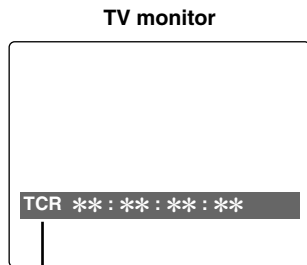

Abbreviation
CTL (control signal)
TCR (time code playback value)
UBR (user's bit playback value)

Characters displayed

The background of the characters superimposed on the display can be changed using menu item No.009 [CHARA TYPE].



TV monitor

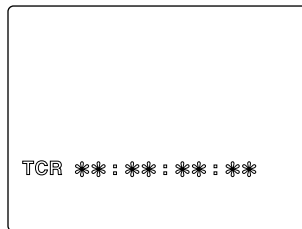

TV monitor

Display position

The position where the superimposed characters are displayed can be changed using menu items No.007 [CHARA H-POS] and No.008 [CHARA V-POS].



TV monitor



TV monitor

<Note>

When the DATA+ button or DATA- button is pressed together with the PAGE button, the superimposing can be displayed and the established settings can be checked.

Even while the PAGE button is pressed, the actual statuses can be checked using the DATA+ button or DATA- button.

The original display is restored when the MODE button or SET button is pressed.

Remaining tape display

The display position for the remaining tape display can be changed using the menu item No.003 [REMAIN SEL] setting. (See page 33)

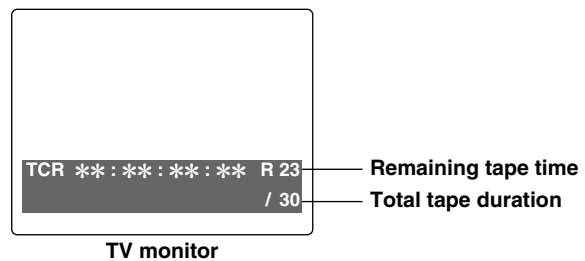

The figure shows what is displayed when R/TTL has been selected as the menu item No.003 [REMAIN SEL] setting.

Superimposed screen displays

Operation mode

What data is to be displayed can be selected using menu item No.006 [DISPLAY SEL].

TIME:

Counter value

T&STA:

Counter value, VTR operation mode

T&S&M:

Counter value, VTR operation mode, tape format and error messages

T&RT:

Counter value, time of recording

T&YMD:

Counter value, date of recording
(year → month → day, in this sequence)

T&MDY:

Counter value, date of recording
(month → day → year, in this sequence)

T&DMY:

Counter value, date of recording
(day → month → year, in this sequence)

T&UB:

Counter value, user's bit

The time code is displayed following the user's bit when UB is selected using the COUNTER button.

T&CTL:

Counter value, tape timer

The time code is displayed following the tape timer when CTL is selected using the COUNTER button.

T&T:

Counter value, time code

<Note>

REC TIME and REC DATE are displayed only when a DV or DVCAM format tape is being played back. The operation mode is displayed when a DVCPRO HD-LP, DVCPRO HD, DVCPRO50, DVCPRO P or DVCPRO format tape is used.

TIME mode

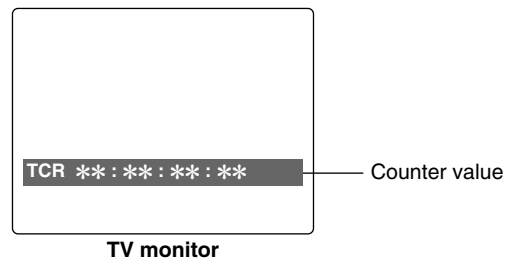

T&STA mode

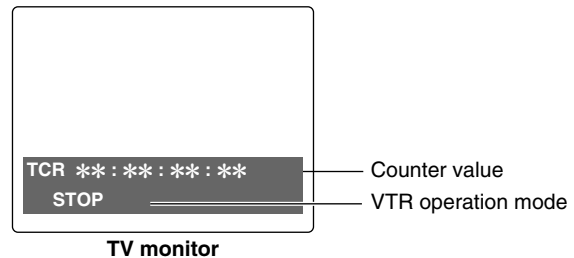

T&S&M mode

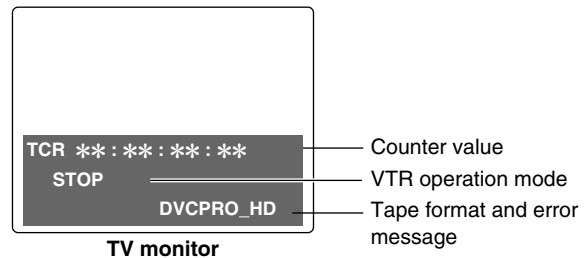

<Note>

When the tape start or end is detected during VTR operation mode, "BOT (beginning of tape) or EOT (end of tape) is indicated at the start of the line.

Display examples:

EOT STOP

(STOP status at tape end)

BOT STANDBY OFF

(standby status at tape start)

Setup (initial settings)

This unit's main settings can be performed and checked using the on-screen menus which are displayed on the video monitor connected to the unit. It is also possible to perform and check the settings using the item numbers and setting numbers which are indicated on the front panel display. Furthermore, a user setting memory in which to store one set of settings is provided, enabling the desired settings to be stored for future use.

Setting method using the on-screen menus

1 Set the LOCAL/MENU/REMOTE switch to the MENU position.

The unit is set to the menu setting mode, and the menu screen appears on the video monitor.

SET-UP MENU	MAIN
	NO.00
* 00 SYSTEM	
000 BASIC	
100 OPERATION	
200 INTERFACE	
400 TAPE PROTECT	
500 TIME CODE	
600 VIDEO	
700 AUDIO	
A00 MENU	

In the menu setting mode, the REW, STOP, FF, SEARCH, PLAY, PAUSE/STILL and REC function buttons work as the PAGE, MENU-DOWN, MENU-UP, MODE, DATA-, DATA+ and SET buttons.

2 Press the MENU-UP button or MENU-DOWN button to move the cursor (*) to the menu where changes are to be made.

3 Press the MODE button, and set the menu items.

To return to the menu screen, press the MODE button while holding down the PAGE button.

4 Press the MENU-UP button or MENU-DOWN button to move the cursor (*) to the item which is to be changed.

The pages can be scrolled up or down by pressing the MENU-UP button or MENU-DOWN button while holding down the PAGE button.

5 Press the DATA+ button or DATA- button to change the setting.

6 Press the SET button to enter the setting.

To make changes to any other items, repeat steps 4, 5 and 6.

<Note>

The setting can be canceled by pressing the MODE button.

To change another item without entering the setting, press the MODE button, and then repeat steps 4, 5 and 6.

7 Set the LOCAL/MENU/REMOTE switch to the LOCAL or REMOTE position.

This completes the menu setting procedure.

Returning to the factory settings

1 Set the LOCAL/MENU/REMOTE switch to the MENU position.

The unit is set to the menu setting mode, and the menu screen appears on the video monitor.

2 Press the RESET button.

The unit is now set to the default setting mode, and the default setting screen now appears on the video monitor.

SELECT MODE
* 0 ESCAPE
1 LOAD
2 SAVE
3 PROTECT

Setup (initial settings)

- 3** Press the MENU-UP button or MENU-DOWN button to move the cursor to the LOAD position, and press the SET button.

The unit is set to the LOAD mode, and the LOAD screen appears on the video monitor.

```
SET-UP MENU  <LOAD>
* NO
  FACTORY
  USER (ALL)
  USER (NOT SYSTEM)
```

- 4** Press the MENU-UP button or MENU-DOWN button to move the cursor to the FACTORY position, and press the SET button.

- When the cursor is moved to FACTORY and this operation is performed, all the settings except the SYSTEM menu settings are returned to the factory settings.
- When the cursor is moved to NO and this operation is performed, the display returns to the menu screen without restoring the factory settings.

- 5** Set the LOCAL/MENU/REMOTE switch to the LOCAL or REMOTE position.

This completes the menu setting procedure.

- 4** Press the MENU-UP button or MENU-DOWN button to move the cursor to the SAVE position, and press the SET button.

The unit is set to the SAVE mode, and the SAVE screen appears on the video monitor.

```
SET-UP MENU  <SAVE>
* NO
  USER (ALL)
  USER (NOT SYSTEM)
```

- 5** Press the MENU-UP button or MENU-DOWN button to move the cursor to the USER (ALL) position, and press the SET button.

- When the cursor is moved to USER (NOT SYSTEM) and this operation is performed, all the settings except the SYSTEM menu settings are updated.
- When the cursor is moved to NO and this operation is performed, the display returns to the menu screen without updating the settings.

- 6** The screen prompting the user to confirm whether the settings are to be saved now appears. To save the settings, press the MENU-UP button or MENU-DOWN button to move the cursor to the YES position, and press the SET button.

The settings are now stored in the memory.

```
SAVE OK?
* NO
  YES
```

- 7** Set the LOCAL/MENU/REMOTE switch to the LOCAL or REMOTE position.

This completes the menu setting procedure.

Setting the user defaults

- 1** Set the LOCAL/MENU/REMOTE switch to the MENU position.

The unit is set to the menu setting mode, and the menu screen appears on the video monitor.

- 2** Perform the operations in steps 2 to 6 for "Setting method using the on-screen menus," and change to the desired settings.

- 3** Press the RESET button.

The unit is now set to the default setting mode, and the default setting screen now appears on the video monitor.

```
SELECT MODE
* 0 ESCAPE
  1 LOAD
  2 SAVE
  3 PROTECT
```

Setup (initial settings)

Loading the user defaults

- 1 Set the LOCAL/MENU/REMOTE switch to the MENU position.**

The unit is set to the menu setting mode, and the menu screen appears on the video monitor.

- 2 Press the RESET button.**

The unit is now set to the default setting mode, and the default setting screen now appears on the video monitor.

```
SELECT MODE
  * 0 ESCAPE
    1 LOAD
    2 SAVE
    3 PROTECT
```

- 3 Press the MENU-UP button or MENU-DOWN button to move the cursor to the LOAD position, and press the SET button.**

The unit is set to the LOAD mode, and the LOAD screen appears on the video monitor.

```
SET-UP MENU <LOAD>
  * NO
    FACTORY
    USER (ALL)
    USER (NOT SYSTEM)
```

- 4 Press the MENU-UP button or MENU-DOWN button to move the cursor to the USER (ALL) position, and press the SET button.**

- When the cursor is moved to USER (NOT SYSTEM) and this operation is performed, everything except the SYSTEM menu settings operates according to the user settings stored in the memory.
- When the cursor is moved to NO and this operation is performed, the display returns to the menu screen without changing to the user settings stored in the memory.

- 5 Set the LOCAL/MENU/REMOTE switch to the LOCAL or REMOTE position.**

This completes the menu setting procedure.

Menu protection

By setting the unit to the menu protection mode, the setup menu can no longer be opened even when the LOCAL/MENU/REMOTE switch is set to the MENU position.

- 1 Set the LOCAL/MENU/REMOTE switch to the MENU position.**

The unit is set to the menu setting mode, and the menu screen appears on the video monitor.

- 2 Press the RESET button.**

The unit is now set to the default setting mode, and the default setting screen now appears on the video monitor.

```
SELECT MODE
  * 0 ESCAPE
    1 LOAD
    2 SAVE
    3 PROTECT
```

- 3 Press the MENU-UP button or MENU-DOWN button to move the cursor to the PROTECT position, and press the SET button.**

The unit is set to the menu protection setting mode, and the screen prompting the user to confirm the menu protection appears on the video monitor.

```
MENU PROTECT OK?
  * NO
    YES
```

- 4 To initiate menu protection, press the MENU-UP button or MENU-DOWN button to move the cursor to the YES position, and press the SET button.**

The menu screen now appears.

Setup (initial settings)

5 Set the LOCAL/MENU/REMOTE switch to the LOCAL or REMOTE position.

The unit is now set to the menu protection mode. When the LOCAL/MENU/REMOTE switch is set to the MENU position, the unit is not set to the menu setting mode, and "MENU PROTECTED" appears on the video monitor screen.

<Note>

If, during the setting of the menu protection mode, the LOCAL/MENU/REMOTE switch is set to the MENU position while the COUNTER button on the front panel is held down, the unit is set to the menu setting mode, and the regular menu settings can be performed.

Perform steps 2 to 7 of "Setting method using the on-screen menus."

Releasing the menu protection mode

1 Set the LOCAL/MENU/REMOTE switch to the MENU position while holding down the COUNTER button on the front panel.

The unit is set to the menu setting mode, and the menu screen appears on the video monitor.

2 Perform steps 2 and 3 of the menu protection procedure described above.

The screen prompting the user to confirm whether to initiate menu protection appears on the video monitor.

```
MENU PROTECT OK?
* NO
  YES
```

3 Press the MENU-UP button or MENU-DOWN button to move the cursor to the NO position, and press the SET button.

The menu protection mode is now released.

Displaying the DIAG menu

The unit comes with a function for displaying the "hour meter," "software version" and "deck serial No." on the video monitor.

1 Set the LOCAL/MENU/REMOTE switch to the MENU position while holding down the EJECT button.

The unit is set to the DIAG display mode, and the hour meter and deck serial No. appear on the video monitor.

DIAG-MENU	HOURS METER
Ser *****	
H00 OPERATION	00000H
H01 DRUM RUN	00000H
H02 TAPE RUN	00000H
H03 THREADING	00000T
H04 F LOADING	00000T
H11 DRUM RUN r	00000H
H12 TAPE RUN r	00000H
H13 THREADING r	00000T
H14 F LOADING r	00000T

Items with "r" can be reset when the unit is serviced.

2 With the hour meter displayed, press the SEARCH button.

The software version appears on the video monitor.

DIAG-MENU	SOFT VERSION
SYSIF	1.**-**-**.**
AVDV	1.**-**-**.**
SERVO	1.**-**-**.**
END	

The hour meter display is restored when the SEARCH button is pressed again.

3 Set the LOCAL/MENU/REMOTE switch to the LOCAL or REMOTE position.

The unit is restored to its regular mode.

Setup menus

Menus which are displayed

The menus displayed differ depending on the setting selected for menu item No.25 [SYSTEM FREQ] and on the optional boards (AJ-YA120AG, AJ-YAD120AG) which have been installed.

No.	Superimposed display	No optional board installed		AJ-YA120AG installed					AJ-YAD120AG installed		Both optional boards installed				
		59/60	50i/25P	59/60	23/24	50i/25P	25 (HD)	25 (SD)	59/60	50i/25P	59/60	23/24	50i/25P	25 (HD)	25 (SD)
12	SYS H (HD)	No	No						No	No					
14	SYS SC (SD)	No	No						No	No					
15	VO SYS H (SD)	No	No						No	No					
16	SD SYS H (SD)	No	No						No	No					
18	SCH COAR (SD)	No	No						No	No					
19	SCH FINE (SD)	No	No						No	No					
20	AV PHASE														
25	SYSTEM FREQ														
26	HD SYS H ADV	No	No		No	No	No	No	No	No		No	No	No	
001	LOCAL ENA														
002	TAPE TIMER				No		No	No				No		No	
003	REMAIN SEL														
005	SUPER														
006	DISPLAY SEL														
007	CHARA H POS														
008	CHARA V POS														
009	CHARA TYPE														
020	SYS FORMAT		No		No	No	No	No		No		No	No	No	
022	PB FORMAT														
023	FORMAT SEL														
030	HD FREQUENCY		No			No	No	No		No			No	No	
031	OUT REF	No	No		No				No	No		No			
101	SHTL MAX														
102	FF. REW MAX														
104	REF ALARM	No	No						No	No					
106	EJECT EE SEL														
107	EE MODE SEL	No	No		No		No	No	No	No		No		No	
108	PLAY DELAY														
109	CAP LOCK				No		No	No				No		No	
110	AUTO REW														
112	FRZ MODE SEL														
114	REC INH LAMP	No	No												
115	EJECT SW INH	No	No		No		No	No				No		No	
118	SP MODE INH	No	No		No		No	No				No		No	
150	SEARCH SPEED														
152	HUMID OPE														
154	AUTO BACK	No	No		No		No	No				No		No	
160	MEMORY MODE														
161	CTL BGN/TC BGN														
162	END														
163	REPT MODE														
180	BATTERY SEL														
181	TYPE-A NEAR														
182	TYPE-A END														

Setup menus

No.	Superimposed display	No optional board installed		AJ-YA120AG installed					AJ-YAD120AG installed		Both optional boards installed				
		59/60	50i/25P	59/60	23/24	50i/25P	25 (HD)	25 (SD)	59/60	50i/25P	59/60	23/24	50i/25P	25 (HD)	25 (SD)
183	TYPE-B NEAR														
184	TYPE-B END														
202	ID SEL														
400	STILL TIMER														
401	SRC PROTECT														
402	DRUM STDBY														
403	STOP PROTECT														
500	VITC BLANK				No		No					No		No	
501	VITC POS-1				No		No					No		No	
502	VITC POS-2				No		No					No		No	
503	TCG MODE	No	No		No		No	No				No		No	
504	RUN MODE	No	No		No		No	No				No		No	
505	TCG REGEN	No	No		No		No	No				No		No	
507	TC SOURCE	No	No		No		No	No				No		No	
508	BINARY GP	No	No		No		No	No				No		No	
509	PHASE CORR														
510	TCG CF FLAG	No	No		No		No	No				No		No	
511	DF MODE		No		No	No	No	No	No			No	No	No	
512	TC OUT REF	No	No		No		No	No				No		No	
513	VITC OUT														
514	HD EMBD VITC	No	No				No	No	No					No	
515	HD EMBD LTC	No	No				No	No	No					No	
530	TC PRESET	No	No		No		No	No				No		No	
531	UB PRESET	No	No		No		No	No				No		No	
600	VIDEO IN SEL	No	No		No		No	No	No	No		No		No	
601	VIDEO INT SG	No	No		No		No	No	No	No		No		No	
602	SDI IN MODE	No	No		No		No	No	No	No		No		No	
603	V-MUTE SEL														
604	FREEZE SEL														
615	V OUT SEL						No	No						No	
616	OUT MATRIX						No							No	
620	DOWNCON MODE						No							No	
621	UPCON V MODE	No	No				No	No	No	No				No	
626	D/C ENH H						No							No	
627	D/C ENH V						No							No	
628	U/C ENH H	No	No				No	No	No	No				No	
629	U/C ENH V	No	No				No	No	No	No				No	
630	1080i→HD_OUT	No	No		No	No	No	No	No	No		No	No	No	
632	720p→HD_OUT	No	No		No	No	No	No	No	No		No	No	No	
634	480p→HD_OUT	No	No		No	No	No	No	No	No		No	No	No	
636	480i→HD_OUT	No	No		No	No	No	No	No	No		No	No	No	
676	BLK CLIP		No			No	No	No		No			No	No	
680	CC (F1) BLANK		No		No	No	No	No		No		No	No	No	
681	CC (F2) BLANK		No		No	No	No	No		No		No	No	No	
684	EDH (SD)	No	No				No		No	No				No	
685	ESR MODE (SD)		No			No	No	No		No			No	No	
686	CCR MODE (SD)		No			No	No	No		No			No	No	
687	SDI INDEX 0	No	No		No		No		No	No		No		No	

Setup menus

No.	Superimposed display	No optional board installed		AJ-YA120AG installed					AJ-YAD120AG installed		Both optional boards installed				
		59/60	50i/25P	59/60	23/24	50i/25P	25 (HD)	25 (SD)	59/60	50i/25P	59/60	23/24	50i/25P	25 (HD)	25 (SD)
700	AUDIO IN SEL	No	No		No		No	No	No	No		No		No	No
701	CH1 IN LV	No	No		No		No	No	No	No		No		No	No
702	CH2 IN LV	No	No		No		No	No	No	No		No		No	No
703	CH3 IN LV	No	No		No		No	No	No	No		No		No	No
704	CH4 IN LV	No	No		No		No	No	No	No		No		No	No
706	CH1 OUT LV														
707	CH2 OUT LV														
708	CH3/L OUT LV														
709	CH4/R OUT LV														
730	REC CUE	No	No		No		No	No				No		No	No
731	PB FADE														
732	EMBEDDED AUD	No	No						No	No					
759	DV PB ATT														
760	REC PT MUTE														
762	AUD RATE CON														
765	CUE OUT SEL														
769	MONI SEL														
770	MONITOR MIX														
771	H. PHONE MIX														
780	AUD OUT SEL														
781	IN IMP SEL	No	No		No		No	No				No		No	No
880	DIF SPEED	No	No	No	No	No	No	No				No		No	No
882	DIF IN CH	No	No	No	No	No	No	No				No		No	No
883	DIF OUT CH	No	No	No	No	No	No	No				No		No	No
886	DIF CONFIG	No	No	No	No	No	No	No				No		No	No
890	DIF AUD OUT	No	No	No	No	No	No	No				No		No	No
891	DIF DV AUDIO	No	No	No	No	No	No	No				No		No	No
894	HD→DIF OUT	No	No	No	No	No	No	No				No		No	No
895	50M→DIF OUT	No	No	No	No	No	No	No				No		No	No
896	25M→DIF OUT	No	No	No	No	No	No	No				No		No	No
899	DIF SUPER	No	No	No	No	No	No	No				No		No	No
A02	P. ON LOAD														

<Note>

For details on menu items No.880 to 899, refer to the instructions accompanying the AJ-YAD120AG.

Setup menus

SYSTEM

Item		Setting		Description of settings
No.	Superimposed display	No.	Superimposed display	
12	SYS H (HD)	0000 : <u>1320</u> : 2640	-1320 : 0 : 1320	For adjusting the system phase of the HD SDI output signals (in 13.5 ns increments). -: The phase is advanced. +: The phase is delayed. <Note> The setting range is as follows: ● -1100 to 0 to 1100 when 59/60 is selected as the SYSTEM FREQ setting ● -1375 to 0 to 1375 when 23/24 is selected as the SYSTEM FREQ setting
14	SYS SC (SD)	0000 : <u>0108</u> : 0216	-108 : 0 : 108	For adjusting the system phase of the VIDEO output and SD SDI output signals (total variable range of over ±180 degrees). -: The phase is advanced. +: The phase is delayed.
15	VO SYS H (SD)	0000 : <u>0864</u> : 1728	-864 : 0 : 864	For adjusting the system phase of the VIDEO output signals (in 37 ns increments). -: The phase is advanced. +: The phase is delayed. <Note> The setting range is -858 to 0 to 858 when 59/60 is selected as the menu item No.25 [SYSTEM FREQ] setting.
16	SD SYS H (SD)	0000 : <u>0864</u> : 1728	-864 : 0 : 864	For adjusting the system phase of the SD SDI output signals (in 37 ns increments). -: The phase is advanced. +: The phase is delayed. <Note> The setting range is -858 to 0 to 858 when 59/60 is selected as the menu item No.25 [SYSTEM FREQ] setting.
18	SCH COAR (SD)	<u>0000</u> 0001 0002 0003	0 90 180 270	For adjusting the SCH (sub-carrier to horizontal) phase of the VIDEO output signals (4 positions in 90-degree increments). The SC phase changes, and the H phase remains unchanged.
19	SCH FINE (SD)	0000 : <u>0032</u> : 0064	-32 : 0 : 32	For adjusting the SCH (sub-carrier to horizontal) phase of the VIDEO output signals (variable range of over ±45 degrees). The SC phase changes, and the H phase remains unchanged. A range of ±180 degrees is covered by using this setting in combination with item No.18 [SCH COAR(SD)].
20	AV PHASE	0000 : <u>0100</u> : 0200	-100 : 0 : 100	For adjusting the phase of the AUDIO output signals in relation to the VIDEO output signals (in 20.8 μs increments). -: The phase of the audio output signals is advanced in relation to the video output signals. +: The phase of the audio output signals is delayed in relation to the video output signals.

“ ” indicates the factory setting.

Setup menus

SYSTEM

Item		Setting		Description of settings
No.	Superimposed display	No.	Superimposed display	
25	SYSTEM FREQ	<u>0000</u> 0001 *0002 *0003 *0004	<u>59/60</u> 50i/25P *23/24 *25 (HD) *25 (SD)	<p>For selecting the system frequency</p> <p>0: The 59.94 Hz or 60 Hz system frequency is selected.</p> <p>1: The 50 Hz or 25 PsF system frequency is selected. At this setting, the 1080/25 PsF format signals can be recorded and played back in the same way as with the 1080/50i format.</p> <p>2: The 23.98 Hz or 24 Hz system frequency is selected.</p> <p>3: The 25 Hz system frequency is selected. However, black signals are output from the SD SDI output and analog composite connectors.</p> <p>4: The 25 Hz system frequency is selected. However, black signals are output from the HD SDI output and analog component connectors.</p> <p><Note> Merely changing this item's setting only causes the menu item to flash, and the setting itself is not reflected in the unit. To reflect a new setting in the unit, turn off the power and then turn it back on.</p>
26	HD SYS H ADV	<u>0000</u> 0001	<u>0H</u> 90H	<p>For selecting the output whose HD output phase is to be advanced by 90H in relation to the SD output.</p> <p>0: Both the HD and SD signals are output in phase with the HD and SD REF output signals.</p> <p>1: The HD signals are output at a phase advanced by 90H from the SD output signals.</p> <p>When the SD REF signal is input, the REF input and SD output are in-phase, and when the HD REF signal is input, the REF input and HD output are in-phase.</p> <p><Notes></p> <ul style="list-style-type: none"> • The audio signals and TC signal are output in phase with the HD output. • With the 720p format, there is a phase difference of 120H between them. • This item's setting is fixed to "0H" when "1394" is selected as the menu item No.600 [VIDEO IN SEL] setting or when an SD format tape is being played back.

* This appears when the AJ-YA120AG (optional accessory) has been installed.

"___" indicates the factory setting.

Setup menus

BASIC

Item		Setting		Description of settings
No.	Superimposed display	No.	Superimposed display	
001	LOCAL ENA	0000 <u>0001</u> 0002	DIS ST&EJ ENA	For setting the buttons on the front panel which can be operated when the LOCAL/MENU/REMOTE switch is at the REMOTE position. 0: None of the buttons can be operated. 1: Only the STOP and EJECT buttons can be operated. 2: All of the buttons with the exception of COUNTER and RESET can be operated.
002	TAPE TIMER	<u>0000</u> 0001	$\pm 12h$ 24h	For setting how the time is to be displayed on the CTL counter display. 0: 12-hour display 1: 24-hour display
003	REMAIN SEL	0000 <u>0001</u> 0002 0003	OFF <u>2L</u> 1L R/TTL	For setting the superimposing of the remaining tape time and/or total tape duration displays onto the VIDEO OUT2 connector. 0: No displays are superimposed. 1: The remaining tape time is displayed on the second line. 2: The remaining tape time is displayed on the first line. 3: The remaining tape time is displayed on the first line and the total tape duration on the second line. <Notes> <ul style="list-style-type: none"> The information will not be displayed when 2L is set and TIME is selected as the menu item No.006 [DISPLAY SEL] setting. The remaining tape time will not be displayed when R/TTL is set and TIME is selected as the menu item No.006 [DISPLAY SEL] setting.
005	SUPER	0000 <u>0001</u> 0002 *0003 *0004 *0005 *0006	OFF CMPST CMPNT *SDSDI *HDSDI *CPS&SD *CPN&HD	For setting the superimposing of the displays onto various connectors. 0: The displays are superimposed onto none of the output connectors. 1: The displays are superimposed onto VIDEO OUT2. 2: The displays are superimposed onto the HD component output (Y). 3: The displays are superimposed onto SD SDI OUT. 4: The displays are superimposed onto HD SDI OUT. 5: The displays are superimposed onto VIDEO OUT2 and SD SDI OUT. 6: The displays are superimposed onto the HD component output (Y) and HD SDI OUT.

<Note>

Even when OFF is selected as the menu item No.005 [SUPER] setting, the superimposing will be displayed in accordance with what is set using menu item No.006 [DISPLAY SEL] during the menu settings. Once the menu settings are exited, the display follows the setting selected for menu item No.005 [SUPER].

* This appears when the AJ-YA120AG (optional accessory) has been installed.

“___” indicates the factory setting.

Setup menus

BASIC

Item		Setting		Description of settings																								
No.	Superimposed display	No.	Superimposed display																									
006	DISPLAY SEL	0000	TIME	For setting what the information to be superimposed. 0: Only the data is displayed. ("Data" refers to the CTL, TC or UB value selected by the COUNTER button.)																								
		<u>0001</u>	T&STA	1: The data and operation status are displayed.																								
		0002	T&S&M	2: The data, operation status and mode are displayed.																								
		0003	T&RT	3: The data and REC TIME are displayed.																								
		0004	T&YMD	4: The data and REC DATE (year/month/day) are displayed.																								
		0005	T&MDY	5: The data and REC DATE (month/day/year) are displayed.																								
		0006	T&DMY	6: The data and REC DATE (day/month/year) are displayed.																								
		0007	T&UB	7: The data and user's bit are displayed. The time code is displayed after the user's bit when the COUNTER button is set to UB.																								
		0008	T&CTL	8: The data and CTL are displayed. The time code is displayed after the CTL data when the COUNTER button is set to CTL.																								
		0009	T&T	9: The data and time code are displayed.																								
				<Notes> <ul style="list-style-type: none"> Depending on the format used, the following displays appear for the modes. <table border="0"> <tr> <td><Format></td> <td></td> <td><Display></td> </tr> <tr> <td>DVCPRO HD-LP</td> <td>➔</td> <td>DVCPRO_HD-LP</td> </tr> <tr> <td>DVCPRO HD</td> <td>➔</td> <td>DVCPRO_HD</td> </tr> <tr> <td>DVCPRO50</td> <td>➔</td> <td>DVCPRO_50</td> </tr> <tr> <td>DVCPRO50P</td> <td>➔</td> <td>DVCPRO_P</td> </tr> <tr> <td>DVCPRO</td> <td>➔</td> <td>DVCPRO</td> </tr> <tr> <td>DV</td> <td>➔</td> <td>DV</td> </tr> <tr> <td>DVCAM</td> <td>➔</td> <td>DVCAM</td> </tr> </table> When T&S&M is selected as the item setting, an error message is superimposed onto the display when a warning or error occurs. REC TIME and REC DATE are displayed only during DV or DVCAM playback. The operation mode is displayed with the DVCPRO HD-LP, DVCPRO HD, DVCPRO50, DVCPRO50P or DVCPRO format. 	<Format>		<Display>	DVCPRO HD-LP	➔	DVCPRO_HD-LP	DVCPRO HD	➔	DVCPRO_HD	DVCPRO50	➔	DVCPRO_50	DVCPRO50P	➔	DVCPRO_P	DVCPRO	➔	DVCPRO	DV	➔	DV	DVCAM	➔	DVCAM
<Format>		<Display>																										
DVCPRO HD-LP	➔	DVCPRO_HD-LP																										
DVCPRO HD	➔	DVCPRO_HD																										
DVCPRO50	➔	DVCPRO_50																										
DVCPRO50P	➔	DVCPRO_P																										
DVCPRO	➔	DVCPRO																										
DV	➔	DV																										
DVCAM	➔	DVCAM																										
007	CHARA H-POS	0000	0	For setting the horizontal position at which the superimposed characters are to be displayed.																								
		:	:																									
		<u>0006</u>	6																									
		:	:																									
		0037	37																									
008	CHARA V-POS	0000	0	For setting the vertical position at which the superimposed characters are to be displayed.																								
		:	:																									
		<u>0023</u>	23																									
		:	:																									
		0032	32																									
009	CHARA TYPE	<u>0000</u>	WHITE	For setting the superimposed display and menu display type. 0: White characters are displayed on a black background. 1: White characters with black edges are displayed.																								
		0001	W/OUT																									

<Note>

If the PAGE button and DATA+ button or DATA- button are pressed when menu items No.007 [CHARA H-POS] and No.008 [CHARA V-POS] are set, the superimposed information is displayed so that its setting can be checked.

Even while the PAGE button is pressed, the actual statuses can be checked using the DATA+ button or DATA- button.

“ ” indicates the factory setting.

Setup menus

BASIC

Item		Setting		Description of settings
No.	Superimposed display	No.	Superimposed display	
020	SYS FORMAT	<u>0000</u> 0001	<u>1080i</u> 720p	For setting the format in which to record or play back the signals including the HD REF signals. 0: 1080i mode 1: 720p mode
022	PB FORMAT	0000 <u>0001</u>	MANUAL <u>AUTO</u>	For setting the format in which to play back the tape. 0: The tape is played back in the format selected by the menu item No.020 [SYS FORMAT] setting. 1: The tape is played back in the format selected by the format in which the tape was recorded.
023	FORMAT SEL	<u>0000</u> 0001 0002 0003 0004 0005 0006	<u>HD-LP</u> HD-SP 422 411 420p DV DVCAM	For selecting the format when MANUAL is selected as the menu item No.022 [PB FORMAT] setting. 0: The DVCPRO HD-LP format is selected, and the format follows the menu item No.020 [SYS FORMAT] setting. 1: The DVCPRO HD format is selected, and the format follows the menu item No.020 [SYS FORMAT] setting. 2: The DVCPRO50 (422) format is selected. 3: The DVCPRO (411) format is selected. 4: The DVCPROP (420p) format is selected. 5: The DV format is selected. 6: The DVCAM format is selected.
030	HD FREQUENCY	<u>0000</u> 0001	<u>59/23</u> 60/24	For setting the field frequency. 0: The field frequency is set to 59.94/23.98 Hz. 1: The field frequency is set to 60/24 Hz. <Note> The field frequency which is set here takes effect only when there is no input which supports the OUT REF setting. If there is an input which supports the setting, the field frequency is consistent with the field frequency of input.
031	OUT REF	<u>0000</u> 0001 0002 0003	<u>AUTO</u> INPUT HD REF SD REF	For selecting the video output reference. 0: The REF signal (HD/SD) which is input to the REF connector is automatically identified and serves as the reference. If no signal is supplied to the REF connector, the HD serial input signal serves as the reference. If neither the REF input signal nor HD serial input signal is supplied, the internal sync signal serves as the reference. 1: The HD serial input signal serves as the reference. If this signal is not available, the unit's internal reference is used. 2: The HD REF input signal serves as the reference. If this signal is not available, the unit's internal reference is used. 3: The SD REF input signal serves as the reference. If this signal is not available, the unit's internal reference is used. <Note> When "1394" is selected as the menu item No.600 [VIDEO IN SEL] setting, the output picture in the E-E mode or output picture during recording may be disturbed in the vertical direction even when this item is set. However, there will be no problem with the pictures which are recorded on the tape.

“ ” indicates the factory setting.

Setup menus

Formats for playback

Depending on how the menu item No.020 [SYS FORMAT], No.022 [PB FORMAT] and No.023 [FORMAL SEL] settings are combined, the formats of the tapes played back by the unit differ as shown in the table below.

022. PB FORMAT	020. SYS FORMAT	023. FORMAT SEL	Playback format
MANUAL	1080i	HD-LP	DVCPRO HD-LP (1080i)
		HD-SP	DVCPRO HD (1080i)
		50M	DVCPRO50 (422)
		25M	DVCPRO (411)
		50Mp	DVCPROP (420p)
		DV	DV
		DVCAM	DVCAM
	720p	HD-LP	DVCPRO HD-LP (720p)
		HD-SP	DVCPRO HD (720p)
		50M	DVCPRO50 (422)
		25M	DVCPRO (411)
		50Mp	DVCPROP (420p)
		DV	DV
		DVCAM	DVCAM
AUTO	If AUTO is selected as the menu item No.022 [PB FORMAT] setting, the format applying when the format is not yet detected (when the tape inserted) follows the menu item No.023 [FORMAL SEL] setting. However, if DV or DVCAM is selected, operation proceeds as if HD-LP is selected.	DVCPRO HD-LP (1080i/720p), DVCPRO HD (1080i/720p), DVCPRO50 (422), DVCPRO (411), DVCPROP (420p), DC or DVCAM format is detected automatically.	

<Notes>

- When the tape is ejected, the format follows the one selected by menu item No.020 [SYS FORMAT] setting.
- During DVCPROP playback, the format is down-converted to 480i and output.

Setup menus

OPERATION

Item		Setting		Description of settings
No.	Superimposed display	No.	Superimposed display	
101	SHTL MAX	0000 <u>0001</u> 0002	X8.4 <u>X16</u> X32	For setting the maximum speed in the shuttle mode when using the external controller connected to the 9-pin remote connector. 0: 8.4× normal speed 1: 16× normal speed 2: 32× normal speed <Note> The maximum speed for the HD SP mode is automatically limited to 25× normal speed.
102	FF.REW MAX	0000 0001 <u>0002</u>	X16 X32 <u>X50</u>	For setting the maximum speed of fast forward or rewind operations. 0: 16× normal speed 1: 32× normal speed 2: 50× normal speed <Notes> ● The maximum speed for the DV and DVCAM modes is automatically limited to 32× normal speed. ● The maximum speed for the HD SP mode is automatically limited to 25× normal speed.
104	REF ALARM	0000 <u>0001</u>	OFF <u>ON</u>	For setting whether a warning is to be displayed when the REF VIDEO signal is not connected. 0: No warning is displayed. 1: A warning is displayed by the flashing STOP lamp.
106	EJECT EE SEL	<u>0000</u> 0001 0002	<u>EE</u> BLACK GRAY	For setting the video and audio output statuses during eject. 0: Both the video and audio signals are always output in the E-E (electric modulation to electric playback) mode regardless of the position of the TAPE/EE switch. 1: The output status differs according to the position of the TAPE/EE switch. EE: The signals are output in the E-E mode. TAPE: BLACK is output for the video, and the audio is muted. 2: The output status differs according to the position of the TAPE/EE switch. EE: The signals are output in the E-E mode. TAPE: GRAY is output for the video, and the audio is muted. <Note> The EE pictures will be all black when the AJ-YA120AG (optional accessory) or AJ-YAD120AG (optional accessory) is not installed.
107	EE MODE SEL	<u>0000</u> 0001	<u>NORMAL</u> THRU	For selecting the output signals in the EE mode. 0: Signals delayed by the time taken by internal signal processing are output. 1: Signal processing is not undertaken internally, and the signals are output without delay at their original timing. <Note> The superimposed information is not displayed when THRU is used as the setting.
108	PLAY DELAY	<u>0000</u> : 0015	<u>0</u> : 15	For setting the play rise time in frame increments.
109	CAP LOCK	0000 0001 0002	<u>2F</u> 4F 8F	For selecting in how many field increments the playback framing is to be locked. 0: 2F 1: 4F 2: 8F <Notes> ● 8F can be selected only when 50 is selected as the menu item No.25 [SYSTEM FREQ] setting. ● In the HD LP or HD SP mode, the 2F mode is selected during recording*, including follow-on recording, and playback regardless of the menu item's setting.

* This appears when the AJ-YA120AG (optional accessory) or AJ-YAD120AG (optional accessory) has been installed.

“ ” indicates the factory setting.

Setup menus

OPERATION

Item		Setting		Description of settings
No.	Superimposed display	No.	Superimposed display	
110	AUTO REW	<u>0000</u> 0001	<u>OFF</u> ON	For setting whether the tape is to be automatically rewound to its beginning when the tape end is detected. 0: The tape is not rewound. 1: The tape is rewound to its beginning.
112	FRZ MODE SEL	<u>0000</u> 0001	<u>DIS</u> STBOFF	For setting the video output when the mode is transferred from playback images to standby OFF (half loading). 0: The video output is muted. 1: When the standby OFF (half loading) mode is established, the image played back at that moment is frozen and output.
114	REC INH LAMP	<u>0000</u> 0001	<u>LIGHT</u> FLASH	For setting the operation of the REC INHIBIT lamp when the cassette is set to the erasure prevention status. 0: The lamp lights. 1: The lamp flashes. <Note> When the REC INHIBIT switch on the front panel is set to ON, the REC INHIBIT lamp lights at all times regardless of what setting is selected for this menu item.
115	EJECT SW INH	<u>0000</u> 0001	<u>REC</u> OFF	For setting whether to restrict the operation of the EJECT button on the front panel. 0: Operation is inhibited while the unit is in the recording mode. 1: The EJECT button can be operated in all operation modes.
118	SP MODE INH	<u>0000</u> <u>0001</u>	<u>OFF</u> ON	For selecting whether to enable or disable recording on a tape which has been recorded using a format other than DVCPRO HD-LP. 0: Recording onto the cassette tape is enabled. 1: Recording onto the cassette tape is disabled.
150	SEARCH SPEED	<u>0000</u> 0001	<u>X4.1</u> X8.4	For setting the search still, cue and review speed. 0: 4.1× normal tape speed 1: 8.4× normal tape speed
152	HUMID OPE	<u>0000</u> 0001	<u>OFF</u> ON	For setting the unit's operation when condensation has formed. 0: The unit does not operate when condensation has formed. 1: It operates even when condensation has formed but no guarantees are made that the operation will be trouble-free. <Note> Since operating the unit when condensation has formed may damage the tape or give rise to other trouble, the "0" setting (no operation) is recommended under normal circumstances.
154	AUTO BACK	<u>0000</u> <u>0001</u> 0002	<u>OFF</u> <u>REC-P</u> ALL	For setting how the follow-on recording function is to be used. (For setting the AUTO BACK function operation which rewinds the tape for several seconds in order to ensure that the video images follow on one from another with no disruptions.) 0: The tape is not rewound automatically (no AUTO BACK). 1: The tape is rewound (AUTO BACK) during REC PAUSE, and it then stops in the recording standby status. (When PAUSE is released, the tape runs up, and recording starts.) 2: In addition to the function of the 0001 REC-P setting, the tape is rewound (AUTO BACK) during REC PLAY, the tape immediately runs up, and recording starts.
160	MEMORY MODE	<u>0000</u> 0001 0002 0003	<u>OFF</u> M-STOP REPT1 CONT	For setting the repeat playback mode. 0: No repeat playback (normal operation). 1: The tape stops near the BEGIN point when it is fast forwarded or rewound. 2: When the tape reaches the END point, it is rewound to the BEGIN point, and stops. 3: When the tape reaches the END point, it is rewound to the BEGIN point, and plays back, and this is done repeatedly.

“ ” indicates the factory setting.

Setup menus

OPERATION

Item		Setting		Description of settings
No.	Superimposed display	No.	Superimposed display	
161	CTL BGN or TC BGN			For setting the BEGIN point in the repeat playback mode. Either TC or CTL is set as the counter display mode using the COUNTER button. If no mode is set, -- : -- : -- : -- appears, and the tape start serves as the BEGIN point.
162	END			For setting the END point in the repeat playback mode. Either TC or CTL is set as the counter display mode using the COUNTER button. If no mode is set, -- : -- : -- : -- appears, and the tape end serves as the END point.
163	REPT MODE	<u>0000</u> 0001 0002	<u>FREEZE</u> BLACK SW	For setting what images are to be output while the tape returns to the BEGIN point in the repeat playback mode. 0: The tape returns to the BEGIN point with the image played back at the END point still frozen. 1: The tape returns to the BEGIN point while the screen remains black. 2: The tape returns to the BEGIN point following the setting selected by the TAPE/EE switch. <Note> If the tape end is set as the END point when "0:FREEZE" is selected, the playback image will not be frozen properly. Set the END point to a place within the range where images are recorded.
180	BATTERY SEL	<u>0000</u> 0001 0002 0003 0004 0005 0006	<u>NiCd12</u> NiCd13 NiCd14 S-LION I-LION TYPE-A TYPE-B	For setting the type of battery. 0: 12 V-type battery 1: 13 V-type battery 2: 14 V-type battery 3: Setting for using the BP-L90A lithium-ion battery. 4: Setting for using the ENDURA80 lithium-ion battery. 5: Setting for using the battery selected by the menu item No.181 [TYPE-A NEAR] item and No.182 [TYPE-A END] item 6: Setting for using the battery selected by the menu item No.183 [TYPE-B NEAR] item and No.184 [TYPE-B END] item
181	TYPE-A NEAR	<u>0000</u> : 0044	<u>10.6</u> : 15.0	For setting (in increments of 0.1 V) the voltage level at which the counter flashes as warning for TYPE-A battery (selected as the menu item No.180 [BATTERY SEL] item). <Note> When this item has been set to a voltage level close to 15.0 V, the counter display may flash even when an AC power source is being used.
182	TYPE-A END	<u>0000</u> : 0034	<u>10.6</u> : 14.0	For setting (in increments of 0.1 V) the voltage level at which the TYPE-A battery (selected as the menu item No.180 [BATTERY SEL] item) is to be automatically turned off.
183	TYPE-B NEAR	<u>0000</u> : 0044	<u>10.6</u> : 15.0	For setting (in increments of 0.1 V) the voltage level at which the counter flashes as warning for TYPE-B battery (selected as the menu item No.180 [BATTERY SEL] item). <Note> When this item has been set to a voltage level close to 15.0 V, the counter display may flash even when an AC power source is being used.
184	TYPE-B END	<u>0000</u> : 0034	<u>10.6</u> : 14.0	For setting (in increments of 0.1 V) the voltage level at which the TYPE-B battery (selected as the menu item No.180 [BATTERY SEL] item) is to be automatically turned off.

“ ” indicates the factory setting.

Setup menus

INTERFACE

Item		Setting		Description of settings
No.	Superimposed display	No.	Superimposed display	
202	ID SEL	0000 <u>0001</u> 0002	OTHER <u>DVCPRO</u> ORIG	For setting the ID information to be returned to the controller. 0: The ID information of the VTR other than DVCPRO is set. 1: The DVCPRO ID information is set. 2: Set this only when the unit is connected to a Panasonic controller (such as the AJ-A900, optional accessory). <Note> Select 1 (DVCPRO) or 2 (ORIG) if "23/24," "25(HD)" or "25(SD)" is selected as the menu item No.25 [SYSTEM FREQ] setting.

TAPE PROTECT

Item		Setting		Description of settings
No.	Superimposed display	No.	Superimposed display	
400	STILL TIMER	0000 0001 0002 0003 0004 0005 0006 0007 <u>0008</u>	0.5S 5S 10S 20S 30S 40S 50S 1min <u>2min</u>	For setting the time to be taken before the unit is set in the tape protection mode when it is left standing in the STOP or STILL status. (Units: S = seconds, min = minutes) <Note> When a DV or DVCAM tape is used, any setting above 2 (10S) will result in a setting time of 10 seconds.
401	SRC PROTECT	0000 <u>0001</u>	<u>STEP</u> HALF	For setting the operation to be performed in the tape protection mode when the unit is left standing in the STILL status. 0: STEP FWD 1: Standby OFF (half loading) <Note> If STEP FWD is selected, the unit is automatically transferred to the standby OFF (half loading) mode when the unit is left standing in the STILL mode for a total of 30 minutes (or 1 minute for DV or DVCAM tape).
402	DRUM STDBY	0000 <u>0001</u>	OFF <u>ON</u>	For setting the cylinder operation in the standby OFF (half loading) mode. 0: The cylinder stops rotating. 1: The cylinder continues to rotate.
403	STOP PROTECT	0000 <u>0001</u>	<u>STEP</u> <u>HALF</u>	For setting the operation to be performed in the tape protection mode when the unit is left standing in the STOP status. 0: STEP FWD 1: Standby OFF (half loading) <Note> When STEP FWD is selected, the unit is automatically transferred to the standby OFF (half loading) mode when the unit is left standing in the STOP mode for a total of 30 minutes (or 1 minute for DV or DVCAM tape).

"_" indicates the factory setting.

Setup menus

TIME CODE

Item		Setting		Description of settings
No.	Superimposed display	No.	Superimposed display	
500	VITC BLANK	0000 <u>0001</u>	BLANK THRU	For setting whether to output the VITC signal at the position which is set using menu items No.501 [VITC POS-1] and No.502 [VITC POS-2]. 0: The VITC signal is not output. 1: The VITC signal is output. <Note> This setting takes effect only with the SD output (VIDEO output and SD SDI output).
501	VITC POS-1	0000 : <u>0004</u> : 0015	7L : <u>11L</u> : 22L	For setting the position where the VITC signal is to be inserted. <Notes> ● The same line as the one selected by menu item No.502 [VITC POS-2] cannot be selected. ● If 59/60 is selected as the menu item No.25 [SYSTEM FREQ] setting, the setting range is lines 10L to <u>16L</u> to 20L. ● This setting takes effect only with the SD output (VIDEO output and SD SDI output).
502	VITC POS-2	0000 : <u>0006</u> : 0015	7L : <u>13L</u> : 22L	For setting the position where the VITC signal is to be inserted. <Notes> ● The same line as the one selected by menu item No.501 [VITC POS-1] cannot be selected. ● If 59/60 is selected as the menu item No.25 [SYSTEM FREQ] setting, the setting range is lines 10L to <u>18L</u> to 20L. ● This setting takes effect only with the SD output (VIDEO output and SD SDI output).
503	TCG MODE	0000 0001 <u>0002</u>	REGEN PRE <u>AUTO</u>	For setting the synchronization of the internal time code generator. 0: The time code which is read from the tape by the time code reader is used. 1: The mode can be preset using the controls on the operation panel or the remote controller. 2: REGEN or PRE is automatically selected depending on the operation mode. Follow-on recording mode: REGEN is selected. All other modes: PRE is selected.
504	RUN MODE	<u>0000</u> 0001	<u>REC</u> FREE	For setting the operation mode in which the internal time code generator runs. 0: The generator runs only while recording is in progress. 1: The generator runs while the power is on regardless of the unit's operation mode.
505	TCG REGEN	<u>0000</u> 0001 0002	<u>TC&UB</u> TC UB	For setting the signal to be regenerated when the TCG (time code generator) is in the regeneration mode. 0: Both the time code and user's bit are regenerated. 1: Only the time code is regenerated. 2: Only the user's bit is regenerated.
507	TC SOURCE	<u>0000</u> 0001 0002 0003	<u>INT</u> EXT L SLTC SVITC	For selecting the time code to be used when an external time code is used. 0: The internal time code generator is used. 1: The LTC information of the TIME CODE IN connector is used. 2: The LTC information added to the serial signals which are supplied to the HD SDI IN connector is used. 3: The VITC information added to the serial signals which are supplied to the HD SDI IN connector is used. <Notes> ● When a setting other than INT has been selected for this menu item, the user's bit of the LTC and VITC which is output during recording may be output with a delay of 1 frame from the time code. ● When "1394" is selected as the menu item No.600 [VIDEO IN SEL] setting and a setting other than INT is selected for TC SOURCE, the time code which is input to the DV connector is used. At this time, the VITC information will not be superimposed onto the video signal output when recording is performed or the E-E mode is established. The LTC information and VITC information are not superimposed onto the HD serial output signals.

“ ” indicates the factory setting.

Setup menus

TIME CODE

Item		Setting		Description of settings
No.	Superimposed display	No.	Superimposed display	
508	BINARY GP	<u>0000</u> 0001 0002 0003 0004 0005 0006 0007	<u>000</u> 001 010 011 100 101 110 111	For setting the usage status for the user's bit of the time code generated by the TCG. 0: No character set specified 1: 8-bit character set complying with the ISO646 and ISO2022 standards 2: Undefined 3: Undefined 4: Undefined 5: Page/line 6: Undefined 7: Undefined
509	PHASE CORR	<u>0000</u> 0001	<u>OFF</u> ON	For setting whether to control the phase correction of the LTC output during playback. 0: The phase correction is not controlled. 1: The phase correction is controlled.
510	TCG CF FLAG	<u>0000</u> 0001	<u>OFF</u> ON	For selecting whether to set the CF flag of the TCG to ON. 0: The CF flag is set to OFF. 1: The CF flag is set to ON.
511	DF MODE	<u>0000</u> 0001	<u>DF</u> NDF	For selecting whether to use the DF or NDF mode for CTL and TCG. 0: The drop frame (DF) mode is used. 1: The non-drop frame (NDF) mode is used.
512	TC OUT REF	<u>0000</u> 0001	<u>VOUT</u> TC_IN	For setting the signal to be used as the reference for aligning the phase of the time code which is output from the TC OUT connector with the phase of the external TC input signal when a setting other than INT is selected as the menu item No.507 [TC SOURCE] setting. (In EE mode only) 0: The output video signal is used as the reference. 1: The external time code input signal is used as the reference.
513	VITC OUT	<u>0000</u> 0001	<u>SBC</u> VAUX	For selecting how to output the VITC signal which is superimposed onto the output video signal. 0: In the playback mode, the time code recorded in the SBC area is output. 1: In the playback mode, the time code recorded in the VAUX area is output. <Note> • The VITC information which is detected by the HD serial input is automatically recorded in the VAUX area when the images are recorded. • When "23/24," "25(HD)" or "25(SD)" is selected as the menu item No.25 [SYSTEM FREQ] setting and VAUX is selected as the VITC OUT setting, the time code which is output may not be continuous.
514	HD EMBD VITC	<u>0000</u> 0001	<u>OFF</u> ON	For selecting whether to superimpose the VITC information onto the HD serial output. 0: The VITC information is not superimposed. 1: The VITC information is superimposed.
515	HD EMBD LTC	<u>0000</u> 0001	<u>OFF</u> ON	For selecting whether to superimpose the LTC information onto the HD serial output. 0: The LTC information is not superimposed. 1: The LTC information is superimposed.
530	TC PRESET			For setting the time code of the internal TCG. 00000000 to 23595924 Selection range of 00000000 to 23595929 when 59/60 is selected as the menu item No.35 [SYSTEM FREQ] setting
531	UB PRESET			For setting the user's bit of the internal TCG. 00000000 to FFFFFFFF

" " indicates the factory setting.

Setup menus

VIDEO

Item		Setting		Description of settings
No.	Superimposed display	No.	Superimposed display	
600	VIDEO IN SEL	0000 0001 0002	INTSG HDSDI 1394	For selecting the video signals to be input. 0: The internal signal selected by VIDEO INT SG is generated. 1: The serial video signal supplied to the HD SDI IN connector is selected. 2: The compressed digital signals supplied to the DV connector are selected. When this happens, the audio input signals will also be supplied from the DV connector (digital video interface). <Notes> • This item's setting cannot be changed while a tape is being played back. • When 1394 is selected as this item's setting, "1080i" is selected as the menu item No.630 [1080i→HD_OUT] setting and "720p" is selected as the menu item No.632 [720p→HD_OUT] setting.
601	VIDEO INT SG	0000 0001 0002 0003 0004 0005	100%CB 75%CB SMPTE BLACK PLL EQ	For selecting the type of internal signal. 0: A 100% color bar signal is selected. 1: A 75% color bar signal is selected. 2: An SMPTE color bar signal is selected. 3: A black signal is selected. 4: The PLL signal is selected. (This signal is used for the adjustments performed before the unit was shipped from the factory.) 5: The EQ signal is selected. (This signal is used for the adjustments performed before the unit was shipped from the factory.)
602	SDI IN MODE	0000 0001	DR OFF DR ON	For selecting how to process the serial input. 0: The 8 higher bits whose two lower bits have been rounded off are recorded. 1: The dynamically rounded 8 higher bit signal is recorded.
603	V-MUTE SEL	0000 0001 0002 0003	N MUTE GRAY BLACK NOISE	For setting whether to mute the video output signal when a blank part of the tape is detected during playback. 0: The video output signal is not muted. (It is frozen.) 1: The video output signal is muted and turned gray. 2: The video output signal is muted and turned black. 3: The video output signal is muted and turned into noise.
604	FREEZE SEL	0000 0001	FIELD FRAME	For selecting the freeze mode of the still pictures and the slow play mode. 0: Field freeze, field slow 1: Frame freeze, frame slow
615	V OUT SEL	0000 0001	CMPNT CMPST	For selecting what signals are to be output from the VIDEO OUT1 output connector. 0: The HD component signals are output. 1: Composite signals are output.
616	OUT MATRIX	0000 0001	YPbPr RGB	For selecting what signals are to be output from the HD component output connector. 0: The YPbPr signals are output. 1: The RGB signals are output.
620	DOWNCON MODE	0000 0001 0002	FIT_V FIT_H FIT_HV	For setting the image processing during down-conversion. 0: Side cut mode 1: Letter-box mode 2: Squeeze mode
621	UPCON V MODE	0000 0001 0002	FIT_V FIT_H FIT_HV	For setting the image processing during up-conversion. 0: Side panel mode 1: Top and bottom cut-off in vertical direction 2: Stretch mode
626	D/C ENH H	0000 0001	0dB +1dB	For enhancing the horizontal outlines during down-conversion. 0: 0dB 1: +1dB
627	D/C ENH V	0000 0001	0dB +1dB	For enhancing the vertical outlines during down-conversion. 0: 0dB 1: +1dB

“___” indicates the factory setting.

Setup menus

VIDEO

Item		Setting		Description of settings
No.	Superimposed display	No.	Superimposed display	
628	U/C ENH H	0000 <u>0001</u>	0dB <u>+1dB</u>	For enhancing the horizontal outlines during up-conversion. 0: 0dB 1: +1dB
629	U/C ENH V	0000 <u>0001</u>	0dB <u>+1dB</u>	For enhancing the vertical outlines during up-conversion. 0: 0dB 1: +1dB
630	1080i→HD_OUT	<u>0000</u> 0001	<u>1080i</u> 720p	For selecting the HD output signal format during 1080i tape playback or in the 1080i EE mode. 0: 1080i 1: 720p <Notes> <ul style="list-style-type: none"> This item's setting cannot be changed while a tape is being recorded or while the recording pause mode is established. When 720p is selected as this item's setting, no signals are output from the DV connector. If "1394" is selected as the menu item No.600 [VIDEO IN SEL] setting, "HSDSI" is established as the VIDEO IN SEL setting.
632	720p→HD_OUT	0000 <u>0001</u>	1080i <u>720p</u>	For selecting the HD output signal format during 720p tape playback or in the 720p EE mode. 0: 1080i 1: 720p <Notes> <ul style="list-style-type: none"> This item's setting cannot be changed while a tape is being recorded or while the recording pause mode is established. When 1080i is selected as this item's setting, no signals are output from the DV connector. If "1394" is selected as the menu item No.600 [VIDEO IN SEL] setting, "HSDSI" is established as the VIDEO IN SEL setting.
634	480p→HD_OUT	<u>0000</u> 0001	<u>1080i</u> 720p	For selecting the HD output signal format during 480p tape (DVCPRO50P) playback. 0: 1080i 1: 720p
636	480i→HD_OUT	<u>0000</u> 0001	<u>1080i</u> 720p	For selecting the HD output signal format during 480i tape (DVCPRO50, DVCPRO, DV or DVCAM) playback. 0: 1080i 1: 720p
676	BLK CLIP	<u>0000</u> 0001	OFF <u>ON</u>	For setting whether to clip what is below the pedestal level for the Y (luminance) signal of VIDEO OUT and SD OUT. 0: What is below the pedestal level is not clipped. 1: What is below the pedestal level is clipped.
680	CC (F1) BLANK *DW	0000 <u>0001</u>	BLANK <u>THRU</u>	For selecting ON or OFF for the closed caption signal in the first field. 0: Forced blanking 1: No blanking
681	CC (F2) BLANK *DW	0000 <u>0001</u>	BLANK <u>THRU</u>	For selecting ON or OFF for the closed caption signal in the second field. 0: Forced blanking 1: No blanking
684	EDH (SD) *DW	0000 <u>0001</u>	OFF <u>ON</u>	For setting whether to superimpose EDH onto the SD SDI output. 0: EDH is not superimposed. 1: EDH is superimposed.
685	ESR MODE (SD) *DW	0000 <u>0001</u>	OFF <u>AUTO</u>	For selecting the mode of the edge subcarrier reduction (ESR) operation in the playback circuit. 0: ESR is forcibly turned off. 1: ESR is automatically set to ON or OFF depending on the unit's operation.
686	CCR MODE (SD) *DW	<u>0000</u> 0001	OFF <u>AUTO</u>	For selecting the cross color processing during playback. 0: The cross color is output as is. 1: The cross color can be reduced.

<Note>

*DW: With SD output (SD tape playback or down-converted output)

“ ” indicates the factory setting.

Setup menus

VIDEO

<Note>

*DW: With SD output (SD tape playback or down-converted output)

Item		Setting		Description of settings
No.	Superimposed display	No.	Superimposed display	
687	SDI INDEX 0 *DW	0000 0001	OFF ON	For selecting whether to superimpose the VIDEO INDEX signal onto the SD SDI output. 0: The VIDEO INDEX signal is not superimposed onto the SD SDI output. 1: The VIDEO INDEX signal is superimposed onto the SD SDI output.

AUDIO

Item		Setting		Description of settings
No.	Superimposed display	No.	Superimposed display	
700	AUDIO IN SEL	0000 0001 0002	INTSG ANA SDI	For setting the audio signal input (in all the channels simultaneously). 0: The internal signal is generated. 1: The input is fixed to analog signals. 2: The input is fixed to SDI signals. <Notes> • The input signals of the channels when analog signals are supplied are recorded onto the audio tracks below on the tape. CH1 input → CH1 and CH5 track CH2 input → CH2 and CH6 track CH3 input → CH3 and CH7 track CH4 input → CH4 and CH8 track • When "1394" is selected as the menu item No.600 [VIDEO IN SEL] setting, the audio input signals will also be supplied from the DV connector (digital video interface).
701	CH1 IN LV	0000 0001 0002 0003	4dB 0dB -20dB -60dB	For setting the reference level of the analog audio input (CH1).
702	CH2 IN LV	0000 0001 0002 0003	4dB 0dB -20dB -60dB	For setting the reference level of the analog audio input (CH2).
703	CH3 IN LV	0000 0001 0002 0003	4dB 0dB -20dB -60dB	For setting the reference level of the analog audio input (CH3).
704	CH4 IN LV	0000 0001 0002 0003	4dB 0dB -20dB -60dB	For setting the reference level of the analog audio input (CH4).
706	CH1 OUT LV	0000 0001 0002	4dB 0dB -20dB	For setting the reference level of the analog audio output (CH1).
707	CH2 OUT LV	0000 0001 0002	4dB 0dB -20dB	For setting the reference level of the analog audio output (CH2).
708	CH3/L OUT LV	0000 0001 0002	4dB 0dB -20dB	For setting the reference level of the analog audio output (CH3).
709	CH4/R OUT LV	0000 0001 0002	4dB 0dB -20dB	For setting the reference level of the analog audio output (CH4).

"_" indicates the factory setting.

Setup menus

AUDIO

Item		Setting		Description of settings
No.	Superimposed display	No.	Superimposed display	
730	REC CUE	0001	CH1	For setting the input signal to be recorded on the CUE track. 1: Audio input CH1 signal 2: Audio input CH2 signal 3: Audio input CH3 signal 4: Audio input CH4 signal 5: Audio input CH5 signal 6: Audio input CH6 signal 7: Audio input CH7 signal 8: Audio input CH8 signal 9: Audio input CH1 + CH2 mixed signal 10: Audio input CH3 + CH4 mixed signal 11: Audio input CH5 + CH6 mixed signal 12: Audio input CH7 + CH8 mixed signal 13: Audio input CH1 through CH8 mixed signal
		0002	CH2	
		0003	CH3	
		0004	CH4	
		0005	CH5	
		0006	CH6	
		0007	CH7	
		0008	CH8	
		0009	CH1+2	
		0010	CH3+4	
		0011	CH5+6	
		0012	CH7+8	
		0013	CH1~8	
		731	PB FADE	
0001	CUT			
0002	FADE			
732	EMBEDDED AUD	0000	OFF	For setting whether to superimpose audio data onto the HD SDI output and SD SDI output. 0: The audio data is not superimposed. 1: The audio data is superimposed.
		0001	ON	
759	DV PB ATT	0000	OFF	For selecting the audio output level during DV format playback. 0: The audio output level is not attenuated. 1: The audio output level is attenuated.
		0001	ON	
760	REC PT MUTE	0000	OFF	For selecting whether to mute the sound at the joins in the recording during DV or DVCAM format playback. 0: The sound is not muted. 1: The sound is muted.
		0001	ON	
762	AUD RATE CON	0000	OFF	For setting whether the tape is to be played back without passing the signals through the rate converter (without activating the digital filter) in the digital audio output unit. 0: The tape is played back without passing the signals through the rate converter. 1: The signals are passed through the rate converter, and the tape is played back. <Notes> ● In modes other than the 60 Hz mode, the signals are not passed through the rate converter regardless of this menu item's setting. ● ON/OFF control is exercised for channels 1 through 8 at the same time. Separate settings cannot be performed on a channel by channel basis.
		0001	ON	
765	CUE OUT SEL	0000	OFF	For setting whether to output the analog CUE signal to the audio output (main line). 0: The analog CUE signal is not output. During playback, PCM sound is output; in all other modes, no sound is output. 1: The analog CUE signal is output. During playback, PCM sound is output; in all other modes, the analog CUE signal is output.
		0001	ON	
769	MONI SEL	0000	PLY PCM	For setting the monitor output sound during playback. 0: PCM sound is output. 1: CUE sound is output.
		0001	PLY CUE	

“ ___ ” indicates the factory setting.

Setup menus

AUDIO

Item		Setting		Description of settings
No.	Superimposed display	No.	Superimposed display	
770	MONITOR MIX	<u>0000</u> 0001	<u>STEREO</u> CH1+2	For setting the audio monitor output sound. (This functions when the audio monitor selector switch on the front panel is at the ST position.) 0: The sound is output in stereo. 1: Mixed sound is output (to both the left and right connectors).
771	H.PHONE MIX	<u>0000</u> 0001	<u>STEREO</u> CH1+2	For setting the headphone output sound. (This functions when the audio monitor selector switch on the front panel is at the ST position.) 0: The sound is output in stereo. 1: Mixed sound is output (when a monaural earphone is used).
780	AUD OUT SEL	<u>0000</u> 0001 0002	<u>LINE</u> CH1/2 CH3/4	For setting the sound to be output from the analog audio output connectors. 0: All the output connectors are used as the main line output. CH1 connector = CH1 sound CH2 connector = CH2 sound CH3 connector = CH3 sound CH4 connector = CH4 sound 1: The CH1 and CH2 output connectors are used as the main line output, and the CH3 and CH4 output connectors are used as the monitor output connectors. CH1 connector = CH1 sound CH2 connector = CH2 sound CH3 connector = Monitor L (CH1, CH2, CH1+CH2) sound CH4 connector = Monitor R (CH1, CH2, CH1+CH2) sound 2: The CH1 and CH2 output connectors are used as the main line output, and the CH3 and CH4 output connectors are used as the monitor output connectors. CH1 connector = CH3 sound CH2 connector = CH4 sound CH3 connector = Monitor L (CH3, CH4, CH3+CH4) sound CH4 connector = Monitor R (CH3, CH4, CH3+CH4) sound
781	IN IMP SEL	<u>0000</u> 0001	<u>600</u> HIGH	For setting the analog audio input impedance. 0: 600 Ω 1: High impedance <Note> Regardless of this setting, the impedance is set to 3 kΩ when -60 dB is selected as the menu item No.701 to 704 [CH1-4 IN LV] settings.

MENU

Item		Setting		Description of settings
No.	Superimposed display	No.	Superimposed display	
A02	P.ON LOAD	<u>0000</u> 0001	<u>OFF</u> ON	For setting whether to change the setup menu settings to the user initial settings when the power is turned on. 0: The settings are not changed. 1: The settings are changed.

“ ” indicates the factory setting.

Setup menus

DIF (This menu appears only when the AJ-YAD120AG board is installed.)

Item		Setting		Description of settings
No.	Superimposed display	No.	Superimposed display	
880	DIF SPEED	0000 0001 0002	S100 S200 S400	For setting the transfer speed of the digital video interface output. 0: 100 Mbps 1: 200 Mbps 2: 400 Mbps <Note> When S100 has been selected as this item's setting, DVCPRO HD format signals cannot be input or output.
882	DIF IN CH	0000 : 0063 0064	0 : 63 AUTO	For setting the input channel. 0 to 63: The input channel is fixed at the channel corresponding to the number specified. 64: The input channel is not fixed at the channel corresponding to the number specified. The input channel is initialized to 63 when the power is turned on.
883	DIF OUT CH	0000 : 0063 0064	0 : 63 AUTO	For setting the output channel. 0 to 63: The output channel is fixed at the channel corresponding to the number specified. 64: The output channel is not fixed at the channel corresponding to the number specified. The output channel is initialized to 63 when the power is turned on.
886	DIF CONFIG	0000 0001 : 0255	DFLT 1 : 255	Menu item for expansion purposes. Normally, use DFLT as the setting.
890	DIF AUD OUT	0000 0001	CH1/2 CH3/4	For setting the audio channels to which the signals from the digital video interface are to be output in the DV format when a DVCPRO HD tape or 50M format tape is played back. 0: CH1 and CH2 1: CH3 and CH4
891	DIF DV AUDIO	0000 0001 0002	THRU LOCK LOCK48	For setting forcible audio mode conversion when a DV tape is played back and the audio signals are output in the DV format. 0: Normal setting (the signals simply pass through). 1: Forcible conversion to the LOCK mode (no frequency conversion) 2: Forcible conversion to 48kHz/2CH/LOCK.
894	HD→DIF OUT	0000 0001 0002	HD 50M DV	For setting the format of the signals to be output from the digital video interface when a DVCPRO HD tape is played back or the E-E mode is established (while the AJ-YA120AG board is installed). 0: DVCPRO HD 1: DVCPRO50 2: DV
895	50M→DIF OUT	0000 0001	50M DV	For setting the format of the signals to be output from the digital video interface when a 50M format tape is played back. 0: DVCPRO50 1: DV <Note> When DV is selected as this item's setting, the closed caption signals and time code (VITC) signals in the vertical blanking period are transmitted, but none of the other signals in the vertical blanking period are transmitted.
896	25M→DIF OUT	0000 0001	25M DV	For setting the format of the signals to be output from the digital video interface when a 25M format tape is played back. 0: DVCPRO 1: DV
899	DIF SUPER	0000 0001	OFF ON	For setting whether the superimposed display is to be output from the digital video interface when the format is converted (from HD to 50M, from HD to DV or from 50M to DV). 0: The superimposed text is not displayed. 1: The superimposed text is displayed.

<Notes>

The following settings are recommended when a format other than DVCPRO HD is selected as the format of the signals to be output and an external unit is connected to the DV connector.

- Menu item No.022 [PB FORMAT]: MANUAL
- Menu item No.023 [FORMAT SEL]: Format of the tape inserted in the unit

“ ” indicates the factory setting.

Error messages

When something goes wrong with the unit, one of the following error messages will appear on the front panel's counter display and on the monitor's superimposed display.

With a superimposed display, the error number will appear in the counter value display area.

If T&S&M is selected as the menu item No.006 [DISPLAY SEL] setting, the error messages will appear in the mode display area of the superimposed display.

Error No.	Error message and description
- d -	<p>DEW When dew (condensation) has been detected, the error number flashes, and the unit is transferred to the EJECT mode. In the EJECT mode, the tape is ejected, and no further tape operations can be performed.</p> <p>After the tape has been ejected, the cylinder continues to rotate in order to dry out the condensation. When the condensation has dried out, the error display is cleared, and the VTR can be operated again.</p> <ul style="list-style-type: none"> • If condensation is detected in the EJECT mode, the cylinder starts rotating straight away. • If condensation is detected when a cassette is inserted, the cylinder stops rotating, and after the tape has been ejected, it resumes rotating. <p>Wait with power supplied to the unit until the condensation has dried out. When ON is selected as the menu item No.152 [HUMID OPE] setting, the unit can still be operated.</p> <p>The counter value and “- d -” appear alternately on the front panel's counter display area.</p>
E - 00	<p>SERVO NOT LOCKED This appears when the servo is not locked for 3 or more seconds during playback or recording.</p>
E - 01	<p>LOW RF This appears when there is no head output (due to clogging, for instance) for 1 or more seconds during playback.</p>
E - 02	<p>HIGH ERROR RATE This appears when the error rate has deteriorated, and either the video or audio playback signals are subject to correction or interpolation.</p>
E - 09	<p>NO RF This appears when a blank area on the tape has been detected for 1 or more seconds during playback.</p> <p>The unit recognizes an area on the tape as blank when all the conditions below are satisfied.</p> <ul style="list-style-type: none"> • There are no output signals from any of the heads. • Playback data cannot be read. • No CTL signal is present.
E - 10	<p>FAN STOP This appears when the fan motor has stopped operating.</p> <p>The unit's power is automatically turned off in about five minutes after the motor has shut down.</p>

Error No.	Error message and description
E - 93	<p>INVALID TC MODE (in 23/24 Hz mode) This appears during playback if the time code is recorded in the DF mode. The video output is disrupted and the sound output is muted at the time code drop points.</p> <p>The VTR continues to operate.</p> <p>If a tape recorded using a variable frame rate camera is to be played back with the unit, the time code must be recorded in the non-drop frame (NDF) mode.</p>
E - 94	<p>TC SEQUENCE UNMATCH (in 23/24 Hz mode and 25 Hz mode) This appears during playback when the correlation between the active frame information and time code is not correct. The video output may not be uniform (it may not move smoothly).</p> <p>The VTR continues to operate.</p> <p>The information of the active frame (first frame where the frame image is switched) is recorded on tapes which have been recorded using a variable frame rate camera. When playing back these tapes in the unit, frame 0 of the time code must be detected at the active frame position.</p>
E - 29	<p>FRONT LOAD MOTOR This appears when the cassette has failed to move up even six seconds after the unit has been transferred to the EJECT mode.</p> <p><Note> If the cassette fails to move down even when six seconds has elapsed after the cassette was inserted, the unit will be transferred to the EJECT mode.</p>
E - 31	<p>LOADING MOTOR This appears when the unloading operation fails to be completed within 6 seconds.</p> <p><Note> If the loading operation fails to be completed within six seconds after the cassette was inserted, the unit will be transferred to the EJECT mode.</p>
E - 35	<p>SERVO CONTROL ERROR This appears when there has been no response from the servo microcomputer for 1 second or more.</p>
E - 37	<p>SERVO COMM ERROR This appears when the servo microcomputer fails to carry out an instruction of the system control microcomputer even after 10 seconds have elapsed.</p>
E - 38	<p>SERVO FG ERROR This appears when the automatic reel and capstan rotation adjustment, which is performed in the EJECT mode, has not been carried out properly when the unit's power was switched on.</p>

Error messages

Error No.	Error message and description	Error No.	Error message and description
E – 51	FRONT LOAD ERROR This appears when the take-up reel turns without engaging the tape for the prescribed period of time in the start end processing operation while the tape is loading (at the half-loading position).	E – 69	T REEL TORQUE ERR This appears when an abnormal level of torque has been detected as having been applied to the take-up reel motor.
E – 52	W-UP REEL NOT ROTA This appears when the take-up reel has failed to take up the tape while the tape is running in the status where the total tape duration is undetected after the cassette was inserted.	E – 6A	This appears on the front panel's counter display when a communication error between the IF microcomputer and front microcomputer has occurred. At this time, the superimposed display will be cleared.
E – 53	WINDUP ERROR This appears when the amount of tape taken up by the take-up reel and the amount supplied by the supply reel while the tape is running are abnormally different after the total tape duration has been detected.	E – 70	S REEL TORQUE ERR This appears when an abnormal level of torque has been detected as having been applied to the supply reel motor.
E – 55	UNLOAD ERROR This appears when the tape has not been taken up during unloading.	E – 71	CAP TENSION ERROR This appears when abnormal tension on the supply side has been detected in the capstan mode.
E – 57	S-FF/REW TIMEOVER This appears when the tape start end processing operation fails to be completed.	E – 72	REEL TENSION ERROR This appears when abnormal tension on the supply side has been detected in the reel mode.
E – 59	DRUM ROTA TOO SLOW This appears when the cylinder motor rotates abnormally slowly.	E – 73	REEL DIR UNMATCH This appears when the direction of the take-up reel motor has been reversed.
E – 60	DRUM ROTA TOO FAST This appears when the cylinder motor rotates abnormally quickly.	E – 74	DRUM TORQUE ERROR This appears when an abnormal level of torque has been detected as having been applied to the cylinder motor.
E – 61	CAP ROTA TOO SLOW This appears when the capstan motor rotates abnormally slowly.	E – 78	M-IF COMM ERROR This appears when trouble has occurred in communication between the mechanism relay board and servo microcomputer.
E – 64	S REEL TOO FAST This appears when the supply reel motor rotates abnormally quickly.	E – bA	BATTERY This appears when the input DC voltage has dropped below the undercut voltage (approx. 10.6 V).
E – 67	T REEL TOO FAST This appears when the take-up reel motor rotates abnormally quickly.	Consult your dealer if the error message display persists even after the unit has been restarted.	

Error messages

Error messages which may appear when the AJ-YAD120AG board is installed

Error No.	Error message and description	Error No.	Error message and description
E – 04	UNKNOWN SIG This appears when the format of the signals supplied to the digital video interface is neither DVCPRO nor DV. It also appears when two AJ-HD1200A units are used as the input and output units and different settings are selected for the menu item No.25 [SYSTEM FREQ] of the two units. Operation performed by AJ-HD1200A Operation is continued (*1).	E – 18	INVALID TC SIG This appears when the time code signals supplied to the digital video interface are not the correct ones. Operation performed by AJ-HD1200A Operation is continued (*3).
E – 14	NO MATCH SIG This appears when the signals supplied to the digital video interface are at variance from the system format which is set by the AJ-HD1200A. Operation performed by AJ-HD1200A Operation is continued (*1).	E – 90	NOT 1X 100M SIG This appears when the signals supplied to the digital video interface do not have the 1× transfer speed of the DVCPRO HD (100 Mbps) format. Operation performed by AJ-HD1200A Operation is continued (*1).
E – 16	INVALID VIDEO SIG This appears when the video signals supplied to the digital video interface are not the correct ones. Operation performed by AJ-HD1200A Operation is continued (*1).	E – 92	1394 INITIAL ERROR This appears when the initialization process fails during communication via the digital video interface. Operation performed by AJ-HD1200A Operation is continued (*4).
E – 17	INVALID AUDIO SIG This appears when the audio signals supplied to the digital video interface are not the correct ones. Operation performed by AJ-HD1200A Operation is continued (*2).		

<Notes>

- *1: This error message always appears in the E-E mode.
In such a case, black signals are recorded as the video signals, and the audio signals are muted.
- *2: This error message always appears in the E-E mode.
In such a case, the audio signals are muted.
- *3: This error message always appears in the E-E mode.
In such a case, the time code of the time code generator inside the AJ-HD1200A is recorded as the time code signal.
- *4: This error message always appears in the E-E mode.
In such a case, no signals can be output using the digital video interface.

Condensation

Condensation forms in the unit and on the tape following the same principle which is behind the formation of droplets of water (condensation) on the window panes of a heated room. This phenomenon occurs when the unit or tape is moved to a location with significantly different temperature and humidity levels. Condensation forms when:

- The unit (or tape) is moved to a high-humidity place filled with steam or to a room immediately after it has been heated up.
- The unit (or tape) is suddenly moved from a cool place to a place with high temperature and humidity levels.

When the unit (or tape) has been moved to such a place, do not turn on the power immediately but leave the unit (or tape) standing for about 10 minutes. When condensation has formed in the unit, the “– – d – –” error message lights on the counter display, and the cassette tape is automatically ejected.

Keep the power on, and wait until the error message is cleared.

Emergency eject

Procedure to ejecting the tape manually in an emergency

If the cassette tape fails to be ejected even when the EJECT button is pressed, it can be ejected as follows.

- Follow the steps below after making absolutely sure that the unit's power has been turned off.

❶ Remove the top panel.

❷ Use a Phillips-head screwdriver to push in the red plastic gear (A) and turn it counterclockwise while keeping it pushed in. The mechanism that winds up the tape is activated by this, and it makes a latching sound. Ignore the sound, and turn the gear through about 10 revolutions.

<Note>

Turning the gear more than necessary will strain the cassette, possibly resulting in tape damage.

❸ Check that the posts have unloaded the tape and that the tape is completely housed inside the cassette.

❹ Once the tape has been completely returned inside the cassette case, use the Phillips-head screwdriver to push in the red plastic gear (B) in front of the cassette down motor's worm gear and, while keeping it pushed in, turn it clockwise to eject the cassette.

<Note>

When closing the cassette cover, take care not to catch the tape.

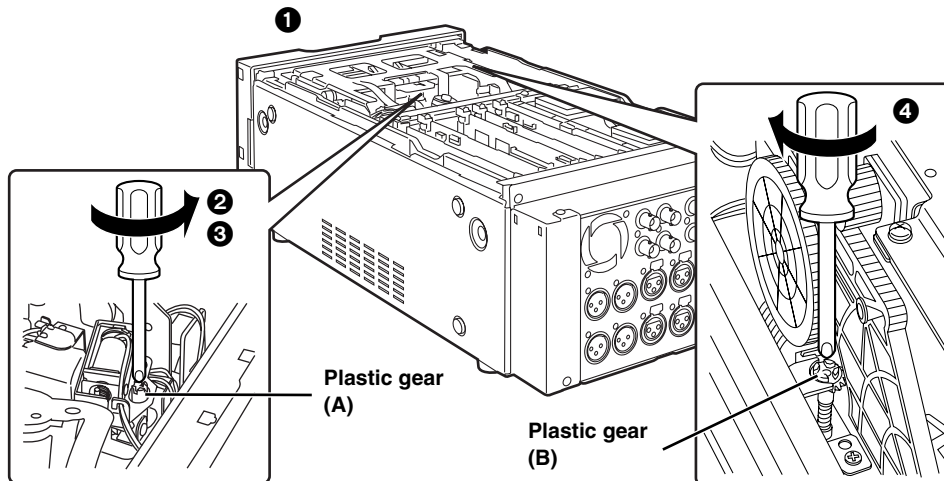

Video head cleaning

This unit comes with an auto head cleaning function which reduces the amount of dirt on the heads automatically. However, in order to improve the unit's reliability, it is recommended that the video heads be cleaned on a daily basis. Use the cleaning fluid specified by Panasonic.

Maintenance

Before proceeding with maintenance, set the power switch to OFF, and be absolutely sure to hold the molded part of the power plug to disconnect it from the power outlet.

Clean the cabinet using a soft cloth. To remove stubborn dirt, dilute some kitchen detergent, soak a cloth in the solution and wring it out well, and then wipe away the dirt. After wiping off the dirt, use a dry cloth to take up the remaining moisture. Do not use paint thinners or benzene.

Specifications

[GENERAL]

Power supply:

AC (100-240) V, 50/60 Hz

DC 12V, 6.6 A

Power consumption:

69 W (main unit only)

97 W (when AJ-YA120AG, AJ-YAD120AG are installed)

 indicates safety information.

Ambient operating temperature:

41°F to 104°F (5°C to 40°C)

Ambient operating humidity:

10% to 80% (no condensation)

Weight:

17.38 lb (7.9 kg)

Dimensions (W×H×D):

8 7/16×5 1/4×16 7/8 inches (214×132×428 mm)

Recording format*1, *2:

DVCPRO HD-LP

Recording video signals*1, *2:

1080i/59.94 Hz, 720p/59.94 Hz, 1080i/50 Hz switchable

Recording audio signals*1:

48 kHz, 16 bits, 8 channels

Recording tracks*1:

- Digital video/audio: Helical track
- Time code: Helical track (sub code area)
- Cue signal: 1 track
- Control (CTL) signal: 1 track

Playback formats:

DVCPRO HD-LP, DVCPRO HD, DVCPRO50, DVCPRO P, DVCPRO, DV-SP, DVCAM

Tape speed:

67.64 mm/sec. (in 59.94 Hz mode)

67.70 mm/sec. (in 60/50 Hz mode)

Recording time:

92 min. (when using AJ-HP92ELG)

Tapes used:

Metal tapes

FF/REW time:

Approx. 2 min. (when using AJ-HP92ELG)

[VIDEO]

■ Digital video**Sampling frequency**

Y: 74.25 MHz

PB/PR: 37.125 MHz

Quantizing:

8 bits

Video compression system:

DCT + variable length code

Video compression ratio:

1:6.7

Error correction:

Reed-Solomon product code

Video recording bit rate:

100 Mbps

■ Video input connectors*1**HD serial digital input:**

BNC × 1

(compliant with SMPTE 292M/296M/299M standards)

Reference input:

Black burst/HD tri-level sync automatic switching

BNC × 2 (loop-through × 1)

75Ω termination ON/OFF switchable

■ Video output connectors**HD serial digital output*1:**

BNC × 2

(compliant with SMPTE 292M/296M/299M standards)

(information superimposing ON/OFF)

SD serial digital output*1:

BNC × 1 (compliant with SMPTE 259M-C/272M-A, ITU-R BT.656-4 standards)

(information superimposing ON/OFF)

Analog composite output:

BNC × 2

VIDEO1*3, VIDEO2

(information superimposing ON/OFF)

HD analog component output:

BNC × 3*3 (Y/PB/PR, R/G/B switchable)

(information superimposing ON/OFF)

*1: This functions only when the AJ-YA120AG (optional accessory) is installed.

*2: This functions only when the AJ-YAD120AG (optional accessory) is installed.

*3: The VIDEO1 and HD analog component Y outputs are switched.

Specifications

■ Video output adjustment ranges

HD serial digital output system phase*1:

1080i: $\pm 0.5H$ (in 13.5ns increments)

59/60 Hz: ± 1100 samples

50 Hz: ± 1320 samples

23/24 Hz: ± 1375 samples

720p: $\pm 0.5H$ (in 13.5ns increments)

59/60 Hz: ± 825 samples

SD serial digital/composite video output system phase*1:

$\pm 0.5H$ (in 37ns increments)

59 Hz: ± 858 samples

50 Hz: ± 864 samples

Composite video output SC phase;

± 180 deg. or more

[AUDIO]

■ Digital audio

Sampling frequency:

48 kHz (synchronized with video)

Quantizing:

16 bits

Frequency response:

20 Hz to 20 kHz ± 1 dB (at reference level)

Dynamic range:

More than 85 dB (1 kHz, emphasis OFF)

Distortion:

Less than 0.1% (1 kHz, emphasis OFF, reference level)

Crosstalk:

Less than -80 dB (1 kHz, between 2 channels)

Wow & flutter:

Below measurable limits

Headroom:

18 dB

■ Audio input connectors*1

Analog input (CH1, CH2, CH3, CH4):

XLR $\times 4$, 600 Ω /high impedance switchable (default: 600 Ω)

+4/0/-20 dBm/-60 dBu switchable

(The impedance is set to 3 k Ω when -60 dB is selected)

HD serial digital input:

BNC $\times 1$, 75 Ω ,

Compliant with SMPTE 292M/296M/299M standard

■ Audio output connectors

Analog output (CH1, CH2, CH3, CH4):

XLR $\times 4$, low impedance

+4/0/-20 dBm (with 600 Ω load) switchable

Monitor output L or R switchable for CH3/CH4 output

HD serial digital output*1:

BNC $\times 2$, 75 Ω

(compliant with SMPTE 292M/296M/299M standard)

SD serial digital output*1:

BNC $\times 1$, 75 Ω

(compliant with SMPTE 259M-C/272M-A, ITU-R BT.656-4 standards)

Monitor output (L, R):

PHONO $\times 2$, 600 Ω , -8 dBv

Headphone output:

Stereo (6 mm diameter), 8 Ω , level variable

[OTHER CONNECTORS]

Time code input*1:

BNC $\times 1$, 0.5 to 8V [p-p], 10 k Ω

Time code output:

BNC $\times 1$, low impedance, 2.0 ± 0.5 V [p-p] (with 600 Ω load)

RS-422A input:

D-sub 9-pin, for AJ-A95

RS-422A interface

DC power output:

4 pins $\times 1$, DC 12 V, 250 mA, for AJ-A95

DV input/output connector:

Connector:

6-pin type

Transmission rate:

400 Mbps, 200 Mbps, 100 Mbps;selectable

Transmission data:

Compliant with IEEE 1394-1995

Compliant with IEC 61883-Part1, Part2

Control command:

Compliant with AV/C command set (General Ver 3.0, VCR Subunit Ver 2.01)

[OPTIONS]

HD SDI input/output SD SDI output board:

AJ-YA120AG

Digital video input/output board:

AJ-YAD120AG

*1: This functions only when the AJ-YA120AG (optional accessory) is installed.

*2: This functions only when the AJ-YAD120AG (optional accessory) is installed.

Weight and dimensions shown are approximate. Specifications are subject to change without notice.

Panasonic Broadcast Europe
Panasonic Marketing Europe GmbH

Hagenauer Str. 43, 65203 Wiesbaden-Biebrich Deutschland Tel: 49-611-235-481



© 2004 Matsushita Electric Industrial Co., Ltd. All rights reserved.

Printed in Japan

F0604W1044 

Free Manuals Download Website

<http://myh66.com>

<http://usermanuals.us>

<http://www.somanuals.com>

<http://www.4manuals.cc>

<http://www.manual-lib.com>

<http://www.404manual.com>

<http://www.luxmanual.com>

<http://aubethermostatmanual.com>

Golf course search by state

<http://golfingnear.com>

Email search by domain

<http://emailbydomain.com>

Auto manuals search

<http://auto.somanuals.com>

TV manuals search

<http://tv.somanuals.com>