

Operating Instructions

Vacuum Cleaner

MC-E455, MC-E456, MC-E457

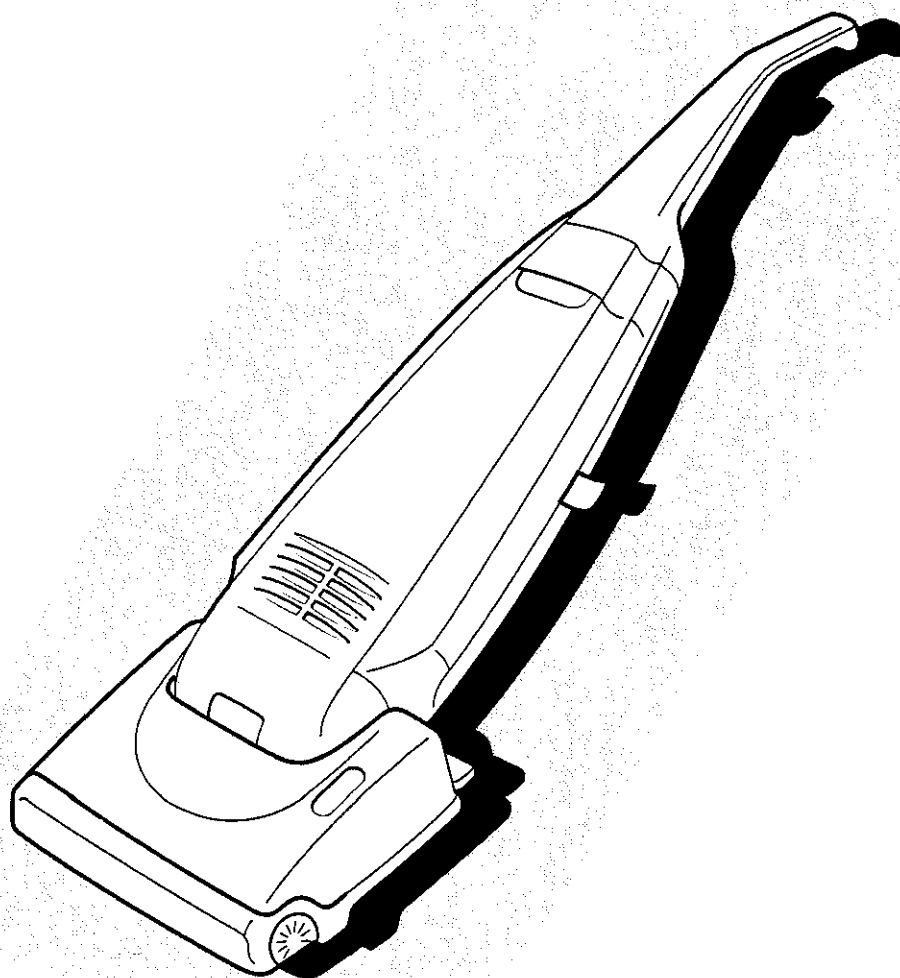

Panasonic

We would particularly advise that you carefully study this Operating Instructions before attempting to operate the unit and that you note the Important Safety Instructions.

TABLE OF CONTENTS

	Page		Page
• Important Safety Instructions for the user	3	• G) How to use the accessories	7
• Cautions	3	• H) Dust bag check indicator	8
• Identification of main parts	4	• I) How to change the dust bag	8
• A) Handle assembly	5	• J) Filter care	9
• B) Power cord release / storage	5	• Trouble shooting guide	9
• C) ON/OFF Switch	5	• Blockages	10
• D) Variable power control	6	• Maintenance for the rotary brush	10
• E) Handle adjustment by foot pedal	6	• Servicing and repairs	11
• F) Beater bar switch	7		

REMINDER FOR CUSTOMER

The model and serial number of this product may be found on the name plate located at the back of your cleaner. You should note the model and serial number in the spaces provided and retain this book as a permanent record of your purchase.

Model Number:
Serial Number:
Date Purchased:
Where Purchased:



IMPORTANT SAFETY INSTRUCTIONS FOR THE USER

When using this vacuum cleaner, please observe these basic precautions.

WARNING: To reduce the risk of fire, electric shock, or injury:

- Do not leave vacuum cleaner when it is plugged in to mains outlet. Unplug from the outlet when not in use, before cleaning the appliance or undertaken maintenance operations.
- Electric shocks can occur if used outdoors or on wet surfaces.
- This appliance is not intended for use by young children or infirm persons without supervision; young children should be supervised to ensure that they do not play with the appliance.
- Do not use with damaged cord or plug. If the vacuum cleaner is not working as it should be, or has been dropped, damaged, left outdoors, or come into contact with water, consult an authorised Panasonic Service Centre.
- Do not pull or carry by cord, use cord as a handle, close a door on cord, pull cord around sharp edges or corners. Do not run vacuum cleaner over the cord. Keep cord away from heated surfaces.
- Do not handle plug or vacuum cleaner with wet hands.
- Do not put any object into openings. Do not use with any opening blocked; keep free of dust, lint, hair and anything that may block or reduce air flow.
- Keep hair, loose clothing, fingers, and all parts of body away from openings and moving parts.
- Do not use the vacuum cleaner without filters and/or dust bag in place. Never try to patch a broken dust bag.
- Turn off all controls before unplugging.
- Use extra care when cleaning on stairs.
- Do not use to pick up flammable or combustible liquids such as gasoline or use in areas where they may be present.
- This appliance should be serviced by an authorised Panasonic Service Centre, and only genuine Panasonic spare parts should be used.
- Keep feet, fingers and hands away from the rotary brush. (It may cause injury).



CAUTIONS

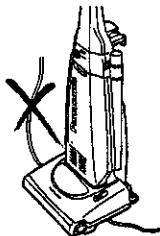

1. To avoid any possible damage to the mains cable, never run over the cord or allow it to become caught in the rotary brush when using the vacuum cleaner.

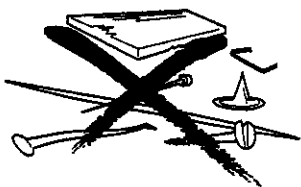

4. Before using the vacuum cleaner, remove large or sharp objects from the carpet to avoid damaging the machine or the dust bag.

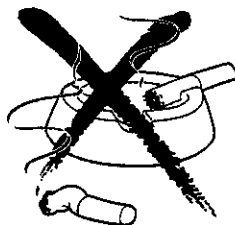

2. Never let the vacuum cleaner pick up wet matter, mud or burning ashes, etc.

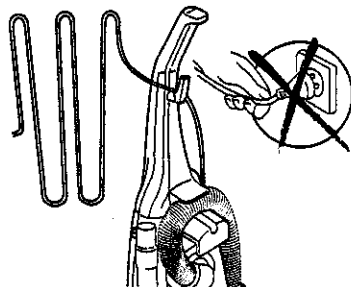

5. Do not pull on the cord strongly when disconnecting the appliance from the mains.

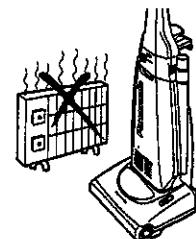

3. Keep the vacuum cleaner away from heat sources such as radiators, fires, direct sunlight, etc.

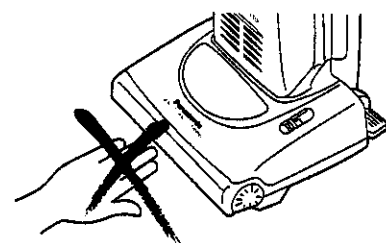

6. Keep fingers and hands away from the rotary brush to avoid injury.

IDENTIFICATION OF MAIN PARTS

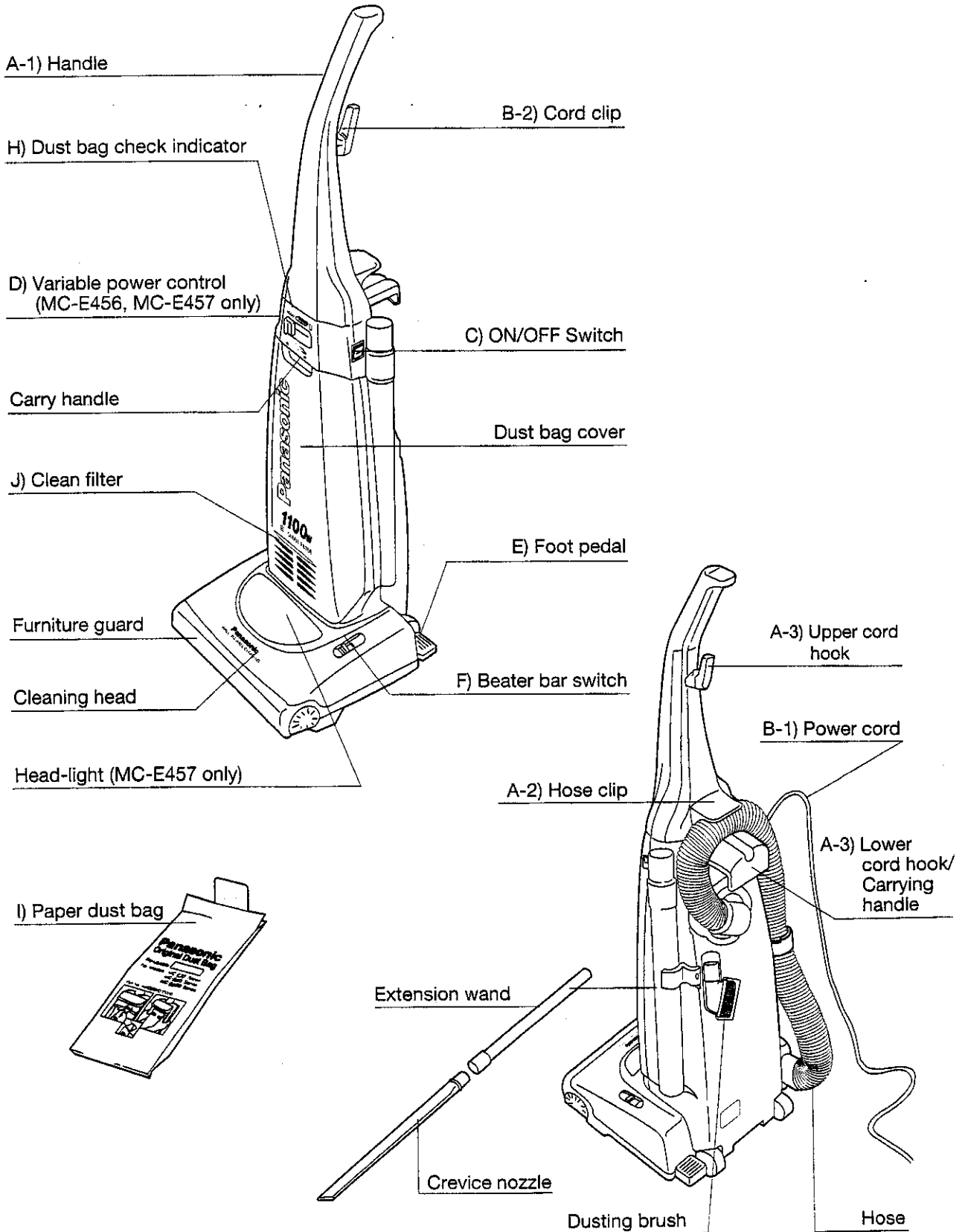

HOW TO ASSEMBLE / OPERATE YOUR CLEANER

A) HANDLE ASSEMBLY

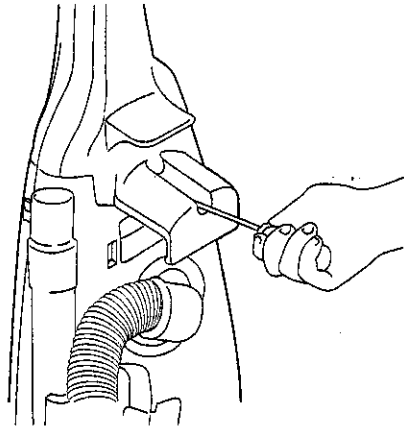

1) Insert the base of the handle into the top of the body of the machine as shown. Push in handle and tighten the screw.

IMPORTANT: Do not over tighten the screw.

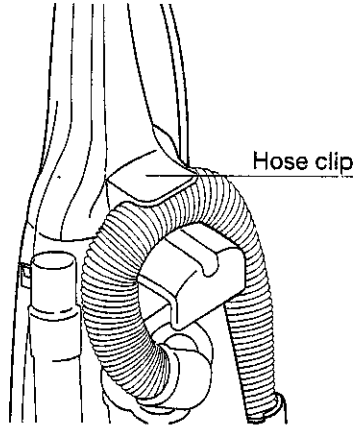

2) Set the hose around the hose clip.

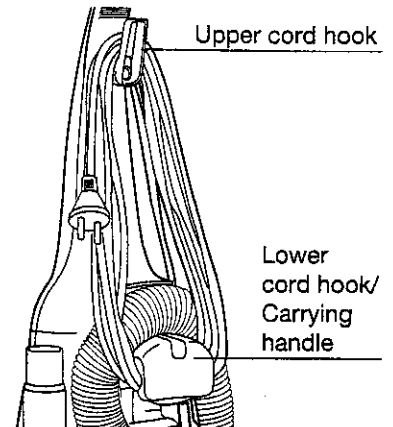

3) Turn the upper cord hook in the upright position and wind the power cord around the upper and lower cord hooks.

B) POWER CORD RELEASE / STORAGE

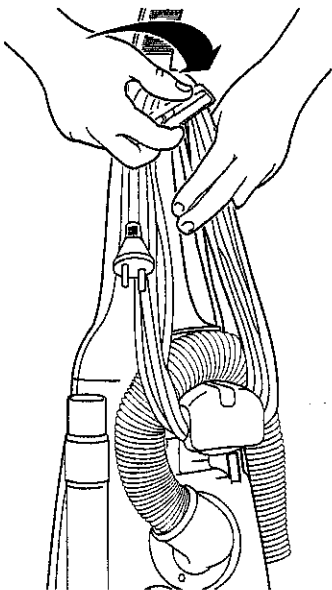

1) Turn the upper hook to release the power cord for instant use.

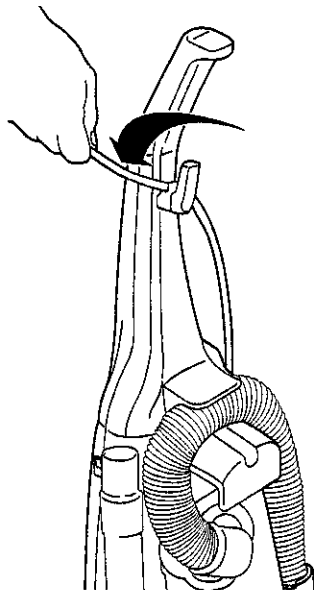

2) Fix the power cord by the cord clip to help secure the cord during use.

NOTE: To avoid any possible damage to the power cord, never run over the cord or allow it to become caught in the rotary brush.

C) ON / OFF SWITCH

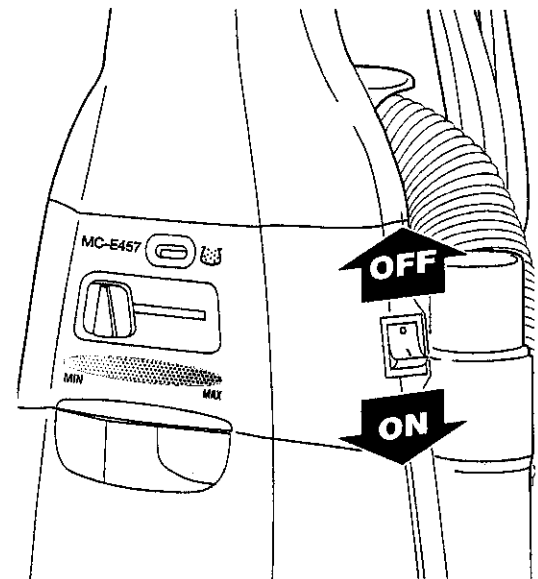

To start or stop the vacuum cleaner push the switch button to " I " to turn ON and to " O " to turn OFF.

D) VARIABLE POWER CONTROL (MC-E456, MC-E457 Only)

These vacuum cleaners incorporate a variable power control to select the most suitable power required for your cleaning needs.

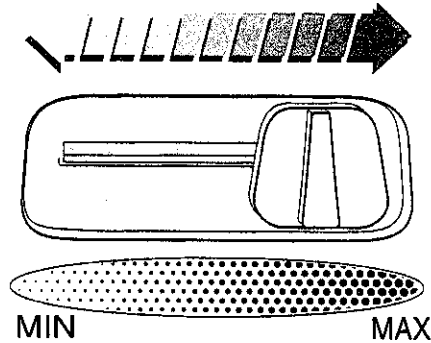

MIN: To clean curtains and soft furnishings etc., with tool attached.

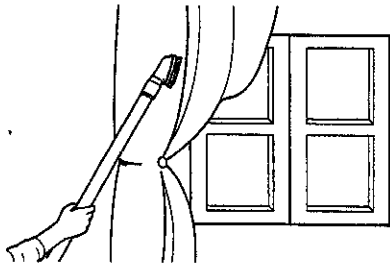

MAX: To clean with high suction continuously on carpets.

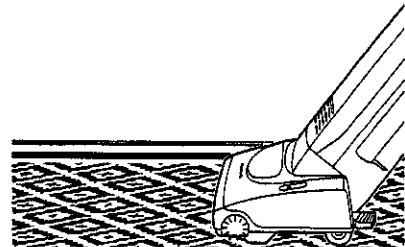

E) HANDLE ADJUSTMENT BY FOOT PEDAL

To lower the body of the cleaner, step on the pedal at the left rear corner of the vacuum cleaner.

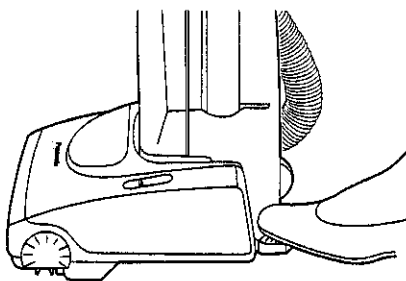

1. Upright position
The handle should be in an upright position when cleaning tools are used.

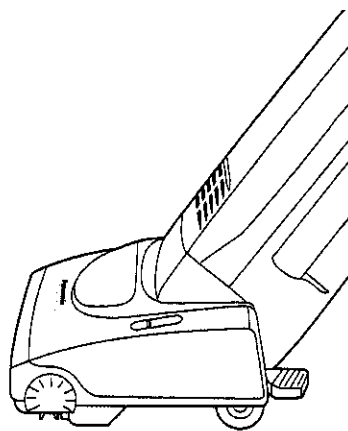

2. Middle position
For normal cleaning, depress the foot pedal and pull back the handle to a comfortable angle and release the pedal to lower the cleaning head.

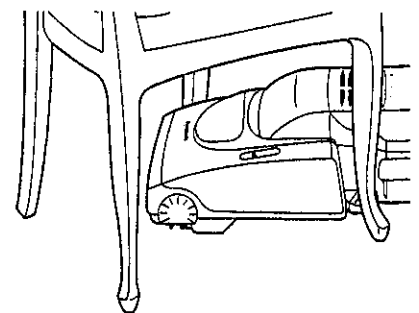

3. Low position
For cleaning under furniture, depress the pedal a second time. The handle may now be lowered almost to the floor as shown.

F) BEATER BAR SWITCH

For cleaning carpeted floor, slide the switch to the " BEATER BAR " position. For using the accessories, slide the switch to the " STOP " position to stop the rotary brush from rotating.

NOTE: Always keep the vacuum cleaner operating in order to change rotary brush position.

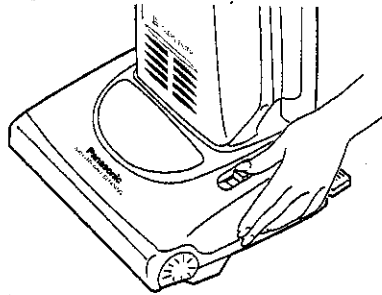

SWITCH BEATER BAR ON OR OFF

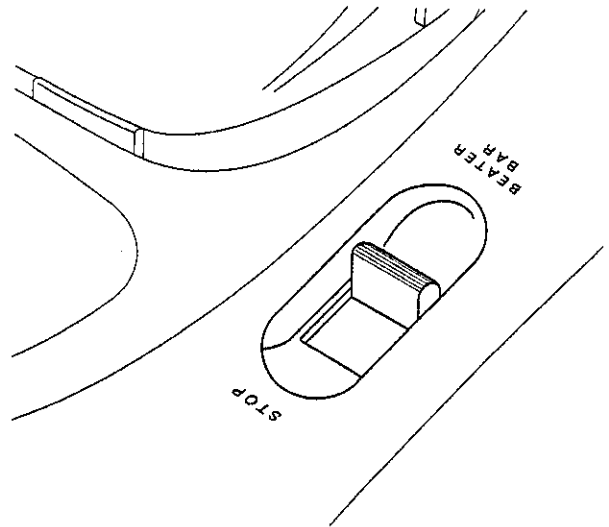

G) HOW TO USE THE ACCESSORIES

- 1) To use the accessories keep the vacuum cleaner in upright position and slide the beater bar switch to " STOP " position to stop the rotary brush rotating.
- 2) Pull out the hose from the rear side of the vacuum cleaner and remove the hose from the hose clip and support. Then connect any accessory as illustrated .

NOTE: After having finished using the accessories, re-insert the hose to the suction inlet and re-install the hose into the hose clip and support.

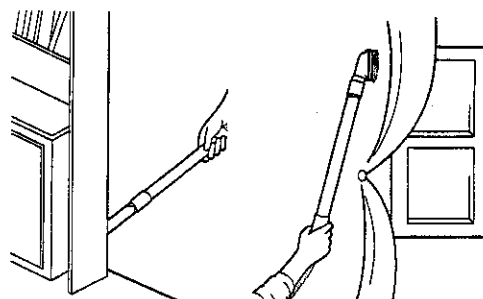
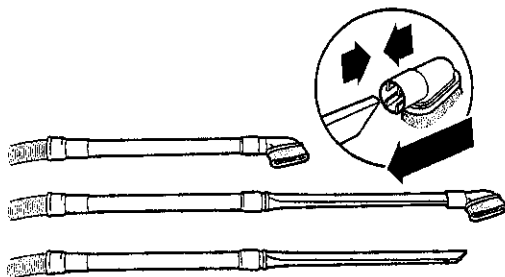
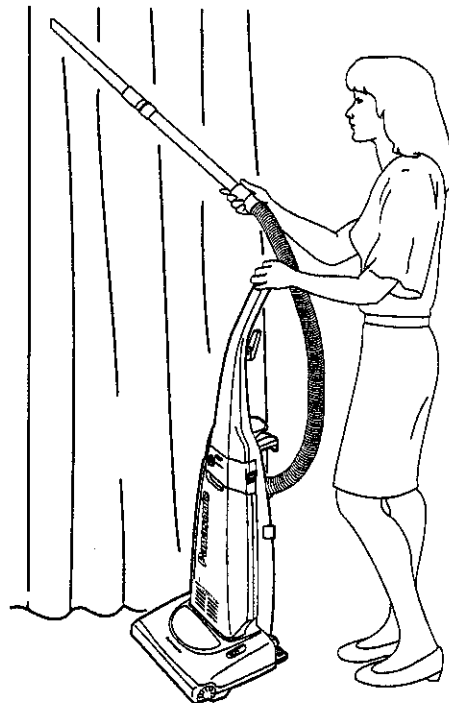
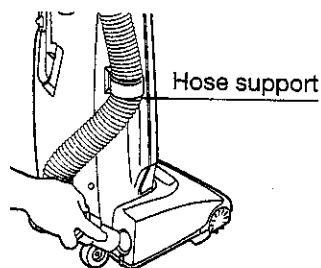
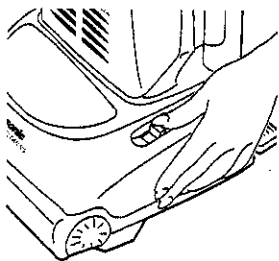

H) DUST BAG CHECK INDICATOR

The dust bag check indicator (yellow mark) will appear in the window, when airflow through the bag is insufficient. When this happens, check the paper bag, it may be full or blocked with fine dust and needs to be emptied or replaced.

NOTE: If after having replaced or emptied the bag, the yellow mark continues appearing in the window, check to see if the hose or suction inlet is clogged. (see BLOCKAGES). Also the yellow mark can appear when using the crevice nozzle.

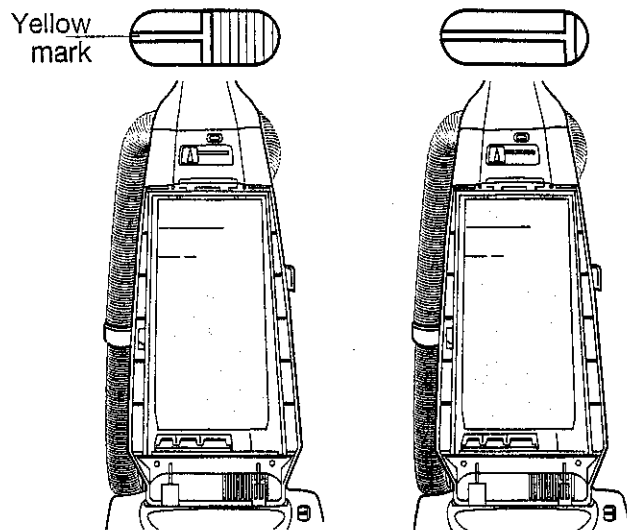

CAUTION: DISCONNECT THE CLEANER FROM THE MAINS OUTLET BEFORE THE OPERATIONS BELOW

I) HOW TO CHANGE THE DUST BAG

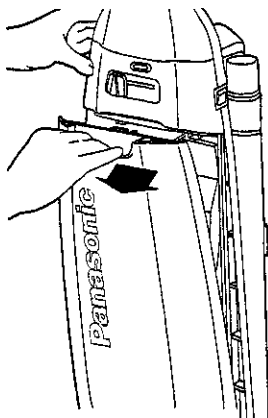

1) Remove dust cover simply pulling it forwards.



2) Grip the cardboard of the dust bag and pull out.

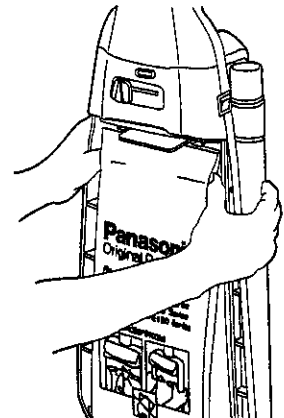

3) Install the dust bag pressing the cardboard as shown and replace the dust cover.

NOTE: Make sure that the dust bag is correctly fitted to avoid dust leakage.

We recommend the use of genuine Panasonic bags Type U-2E only.

J) FILTER CARE

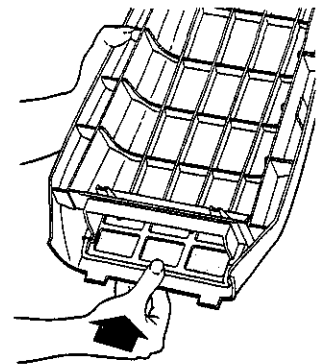
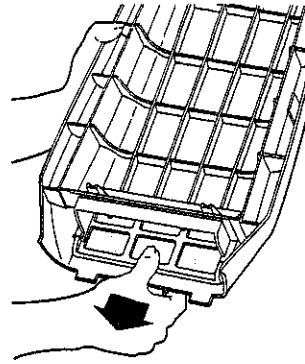
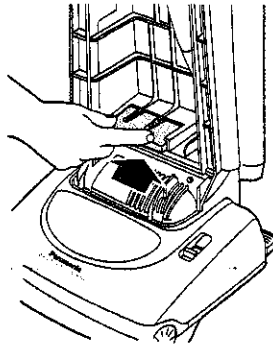
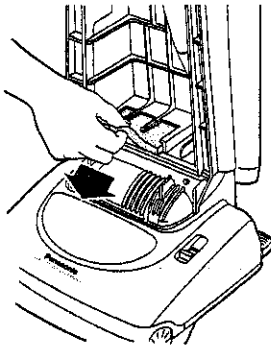

Central Filter (Fig. 1)

Part no. AMC8F0391100

The central filter (foam filter) is installed in the dust bag compartment to protect the motor from dirt.

When it becomes dirty, simply rinse it out in warm water and dry it thoroughly before replacing.

To remove the central filter, hold the filter at the top (as illustrated) and pull it out.

Important: Ensure that the filter is completely dry before re-installing it into the cleaner.

Clean Air Filter (Fig. 2)

Part no. AMC8F28G1000

The clean air filter (electrostatic), is installed in the dust cover. This filter retains any small dust particles which may be present in the expelled air.

It is advisable to change the clean air filter when it becomes dirty. As a guide, once or twice a year is usually sufficient.

To change the clean air filter, first remove the dust cover and then slide out the filter support and simply unhook the filter from the retaining ribs.

NOTE: Never use the cleaner without the correct filters properly installed. Failure to do so may result in motor damaged.

TROUBLE SHOOTING GUIDE

Before returning the vacuum cleaner to a Panasonic Service Centre, check the following points:

Trouble	Check Point	Cause / Remedy
Motor fails to rotate (no noise is heard at all).	<ul style="list-style-type: none"> Mains plug connection. 	<ul style="list-style-type: none"> Mains plug connected firmly.
Motor runs but no suction.	<ul style="list-style-type: none"> Hose inlet clogged. Check dust indicator. Paper bag broken. Central filter. 	<ul style="list-style-type: none"> If there is a blockage, remove it. If shows full, replace the paper bag. If paper bag is broken replace it. If the central filter is full of dust, clean or replace it.
Rotary brush does not rotate.	<ul style="list-style-type: none"> Clogged by a large object in the rotary brush housing. Belt broken / loose. 	<ul style="list-style-type: none"> If there is any obstruction, remove it. If the belt is broken, replace it. If loose re-install it again.

This vacuum cleaner is attached with a thermal-fuse device, that will operate when over heating occurs. If your cleaner does not work, it is possible that the over heating device has operated. If this occurs, take the vacuum cleaner to an official Panasonic Service Centre to be repaired.



IMPORTANT NOTE: Before servicing any part always, **DISCONNECT THE CLEANER FROM THE ELECTRICITY SUPPLY.**

BLOCKAGES

If your cleaner stops to pick up dust, or the dust bag check indicator shows "Full" while the dust bag is still empty, a blockage may have occurred.

Remove the hose from the suction inlet, push the small clips inwards, turn the hose right and pull it upwards (Fig. 1). Clean any obstruction from the hose and/or suction inlet using a blunt implement, taking care not to damage the hose.

If the obstruction occurs in the suction pipe inlet, it can be removed with care as shown in Fig. 2.

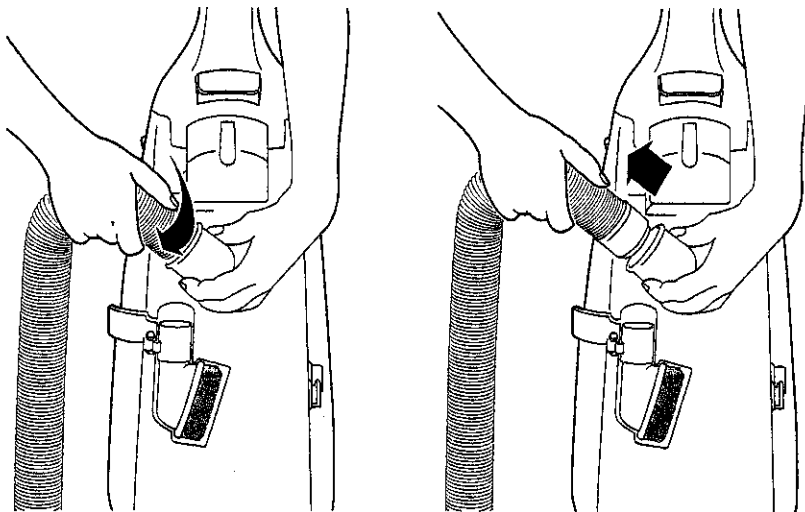

Fig. 1

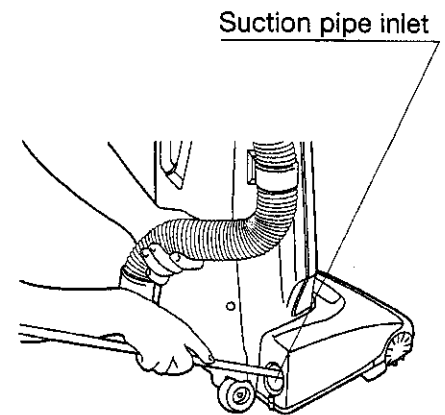
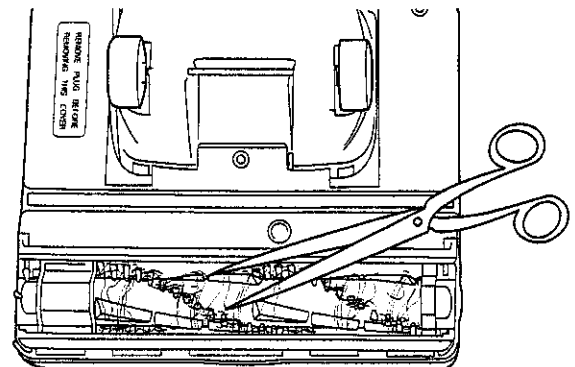
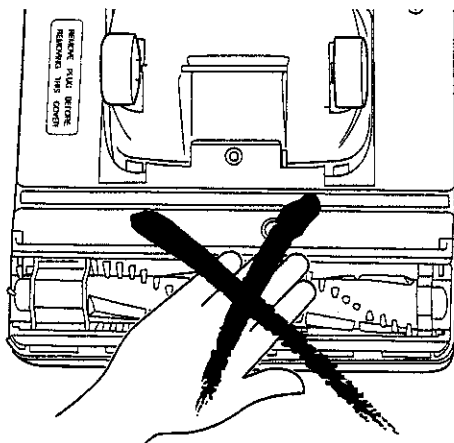

Fig. 2

MAINTENANCE FOR THE ROTARY BRUSH

DO NOT USE YOUR FINGERS OR HANDS TO REMOVE OR CLEAN THE ROTARY BRUSH.

When it is necessary remove threads, strings, hairs, etc., which have wound around the rotary brush, cut across them with a pair of scissors making sure not to cut the brush.



SERVICING AND REPAIRS

Before replacing any part **DISCONNECT THE CLEANER FROM THE MAINS SUPPLY.**
We always recommend you use genuine Panasonic replacement parts only.
If you have any query, contact your local Panasonic dealer/ service agent.
To replace any of the following parts, place the vacuum cleaner in the horizontal position by using the pedal. Then turn it over exposing the underside.

HOW TO REPLACE - DRIVE BELT TYPE UB-1L/ ROTARY BRUSH ASSEMBLY (Part No. AMC8R98G1061)

1. Remove the 4 screws from the base plate and lift it off. (Fig. 1)
2. Release the belt from the motor shaft and lift the rotary brush assembly to remove the belt. (Fig. 2)
3. To reassemble the rotary brush assembly, simply return the belt to the motor shaft and rotary brush pulley.
Re-insert the rotary brush mounts to their holding points, and turn the rotary brush to ensure that the belt has been seated correctly. (Fig. 3)
4. Replace the base plate and re-fasten the screws securely.

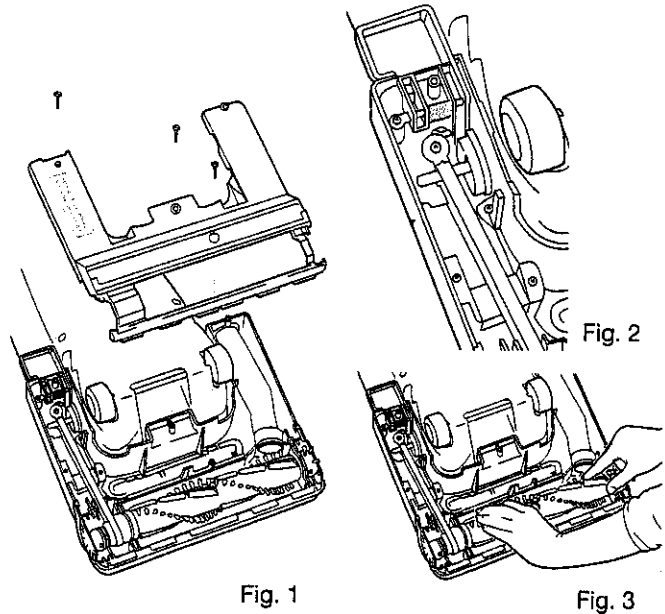

HOW TO REPLACE - ROTARY BRUSH / SIDE BRUSHES / BEARING SUPPORT A-B

1. First remove the base plate, drive belt and lift out the rotary brush assembly (as illustrated above).
2. Remove the 2 screws at both ends of the rotary brush assembly and separate the different parts as shown in the exploded view.
3. Replace any damaged part and reassemble in reverse order.

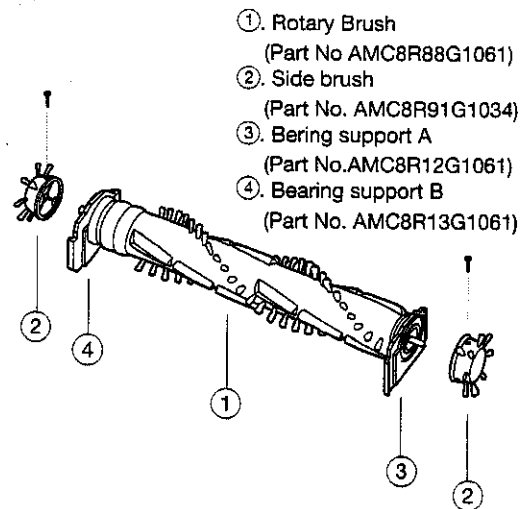

HOW TO REPLACE HEAD-LIGHT BULB (MC-E457 only) (Part No. AMC8D25B6100)

1. Remove the base plate, release the head-light assembly and lift it up. (Fig.1)
2. Remove the old bulb simply pulling forward, and replace with a new one. (Consult your local dealer/ Service agent for a suitable replacement bulb).
3. Re-insert the head-light assembly back into place, replace the base plate and re-fasten the screws securely.

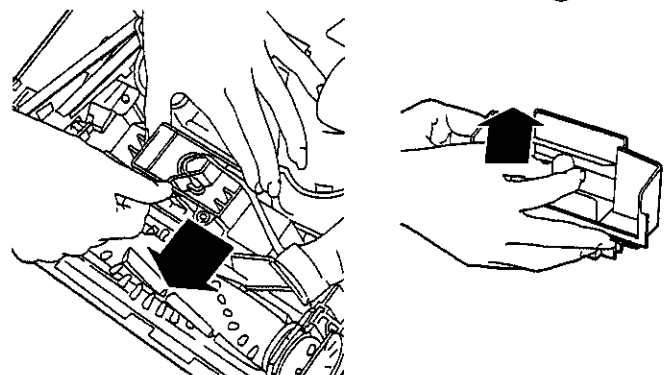

Panasonic Australia PTY Limited
1 Garigal Road
BELROSE NSW 2085
AUSTRALIA

Fisher & Paykel
Customer Services Division
PO Box 14-444
Panmure
AUCKLAND - NEW ZEALAND

Z07G60500

Printed in Spain

Free Manuals Download Website

<http://myh66.com>

<http://usermanuals.us>

<http://www.somanuals.com>

<http://www.4manuals.cc>

<http://www.manual-lib.com>

<http://www.404manual.com>

<http://www.luxmanual.com>

<http://aubethermostatmanual.com>

Golf course search by state

<http://golfingnear.com>

Email search by domain

<http://emailbydomain.com>

Auto manuals search

<http://auto.somanuals.com>

TV manuals search

<http://tv.somanuals.com>