

FP2/FP2SH Series Programmable Controllers



CPU Units

Top Performance, Full Range of Functions

■ CPU units

Selectable from six types, according to the application

There are six types of CPU units, including the standard type and the type with preinstalled commonly-used advanced functions. This selection allows for more economical system development according to the application. See page 12 for details.

■ FP2

Superior cost performance



Standard type
FP2-C1



With 64 input points
FP2-C1D



With S-LINK
FP2-C1SL

■ FP2SH

Industry's highest class processing speed Adequate programming capacity



60k step
standard type
FP2-C2



60k step type
for small PC card
FP2-C2P



120k step type
for small PC card
FP2-C3P

■ Body size

The front face is smaller than an A6 sheet of paper

The front face area is 140mm wide and 100mm high (when using five modules), which is small enough to fit completely on an A6 sheet of paper. The compact body requires minimum installation space. (Depth: 108.3mm)

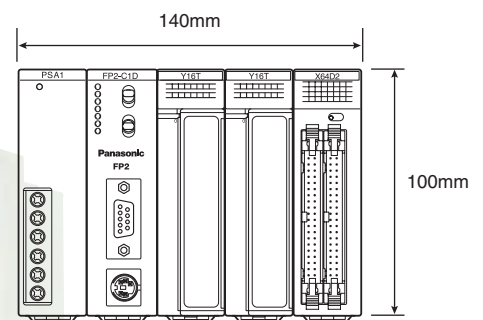



Memory and I/O Control

Flexible Expandability

Memory and I/O control

Equipped with an adequate program memory and operating memory capacity

The body is compact; however, the standard program memory capacity of FP2/FP2SH is as large as 16k/60k steps, and when optional memory is added, 32k/120k steps. A variety of operation memory types are also available. The maximum number of controlled I/O points is 2,048 (2,048/8,192 for FP2/FP2SH when using remote I/O units), which is sufficient for medium-scale control.

Addition of optional memory

FP2: Addition of optional memory to the CPU unit allows it to store up to 32k program steps, provides it with the clock/calendar function, and makes comment writing possible.

FP2SH: An optional IC card can be used as program memory or expanded data memory.

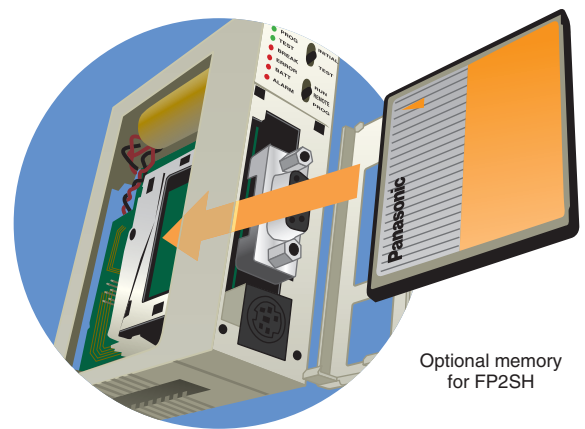

Optional memory for FP2SH

I/O point expansion by adding backplanes

See page 14 for details.

Conventional backplane

Only one backplane can be added to one master backplane. When both the master and expansion backplanes are of the 14-module type, up to 1,600 I/O points can be controlled.

H type backplane

Up to three backplanes can be added to one master backplane. Now up to 32 units can be connected and up to 2,048 I/O points controlled.

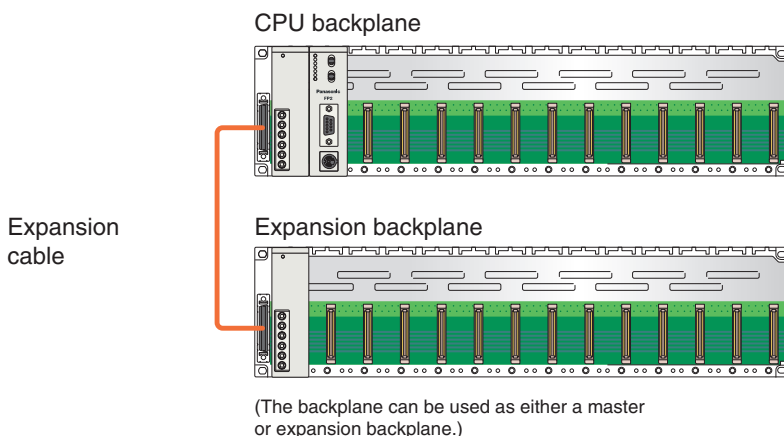

	Conventional type	H type
Max. number of backplanes	1 + 1 = 2	1 for master + 3 for expansion = 4
Max. number of units	12 + 13 = 25	8 + 8 x 3 = 32
Max. number of I/O points	25 x 64 = 1,600	32 x 64 = 2,048
Max. cable length	1 cable, 2m	3 cables, 3.2m

The H type and conventional type cannot be used in combination.

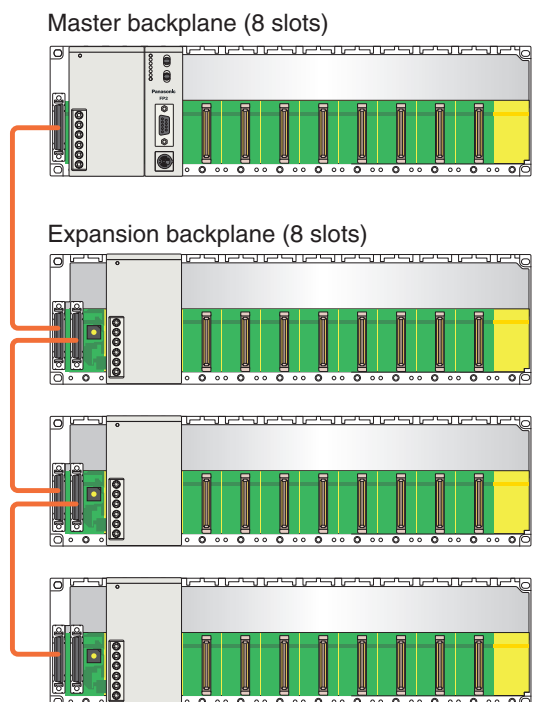



Positioning

Optimal Combination with Servo Drives

"RTEX" positioning units



Compatible with Realtime Express MINAS A4N* network servo systems.

Facilitate multi-axis high precision positioning

- High-accuracy multi-axis positioning control achieved by high-speed 100Mbps communication.
- Compatible with commercially available LAN cables, significantly reducing wiring costs.
- Two-axis unit available in addition to the four- and eight-axis units.
- Data from a maximum of 600 points can be registered for each axis.
- Three-axis helical interpolation supported in addition to two-axis linear and two-axis circular interpolation functions.
- Dedicated tool software "Configurator PM" supports operations from setup through startup and monitoring.
- Equipped with a manual pulser input terminal, allowing for fine teaching.

* Realtime Express and MINAS A4N are a trademark and a product name of Matsushita Electric Industrial Co., Ltd.

High-speed 100Mbps communications

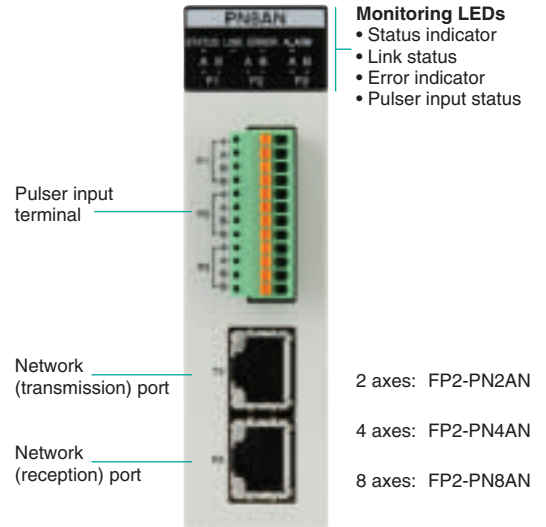

Controls up to 256 axes, adequately supporting large-scale equipment control

- Up to 32 eight-axis units can be connected and up to 256 axes controlled (when using FP2SH with H type backplane).
- Selectable among two, four, and eight-axis types to flexibly support control system configurations of a few or multiple axes.
- Use in combination with the ultra-high speed and large capacity FP2SH CPU unit (20k steps/1ms (measured by our company), program capacity of 120k steps) adequately supports the control of large-scale equipment.

System configuration:

Maximum number of connectable positioning units "RTEX"

FP2: 16 units FP2SH: 32 units

One positioning unit can control two to eight axes (depending on the type).

Servo amplifier: MINAS A4N manufactured by Matsushita Electric Industrial Co., Ltd.

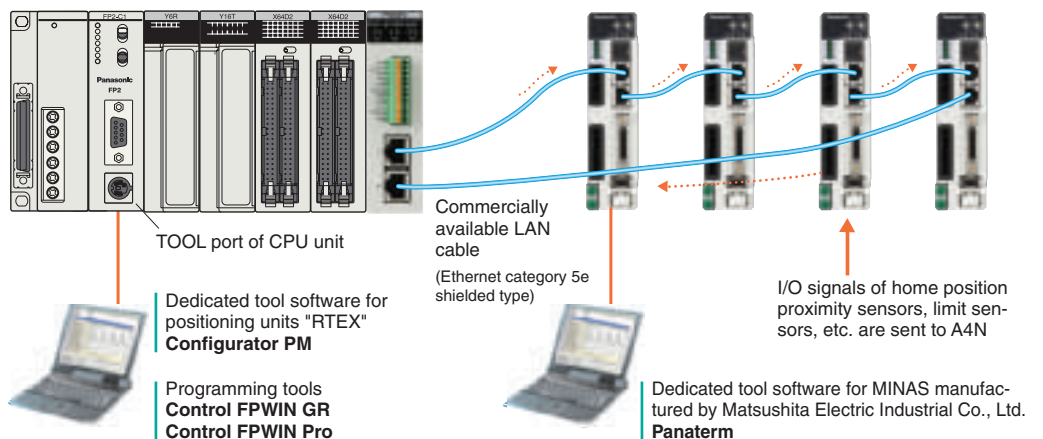

Contact for inquiries about MINAS AC servomotor series: Panasonic Electric Works Europe AG
Telephone: +49 (0) 8024-648-0, Fax: +49 (0) 8024-648-111, www.panasonic-electric-works.com



Positioning

High-Speed, High-Precision Positioning

Positioning units

High-speed, high-accuracy pulse output type positioning unit. Speed command: 4Mpps, Startup time: 0.005ms

Support pulse-input type stepping motors, and servomotors. The speed command range is up to 4Mpps, allowing for high-speed and high-accuracy positioning. The startup time is as high as 0.005ms, allowing for a reduction of the tact time. (Startup time: Time between reception of a command from a CPU unit and pulse output from a positioning unit.)

- The feedback pulse count function counts output pulses from encoders or other devices.
- The jog positioning function widens the supported application range.
- The four types of S-curve acceleration/deceleration control allow for smooth startup and stoppage.
- Program libraries for linear interpolation and other operations are available.
- Function "Libraries for FPCWIN Pro" can be downloaded from our Website: www.panasonic-electric-works.com
- Motor Driver I/F Terminal II is available for connection with MINAS AC servo series.



For 1 axis (AFP8503)



For 2 axes (AFP8504)

High-speed counter units and pulse I/O units

Interrupt, counting, pulse output, and PWM output functions are integrated in a single unit

- Equipped with four channels of a maximum of 200kHz high-speed counter inputs, allowing for fine control.
- Equipped with eight user-allocatable outputs for the four high-speed counter channels. The number of counter stages can be changed.
- Interrupt function can start interrupt program when the time specified elapses or via external signal.
- Control up to 100kpps pulse output and up to 30kpps PWM output.
- A single module has high-speed counter, interrupt, general I/O, pulse output*, PWM output* functions, allowing for highly efficient system configuration.

* Only available with the pulse I/O units.



Positioning unit (2 axes)
FP2-PP21 FP2-PP22



Positioning unit (4 axes)
FP2-PP41 FP2-PP42

Configuration

- One unit can control up to 4 axes.

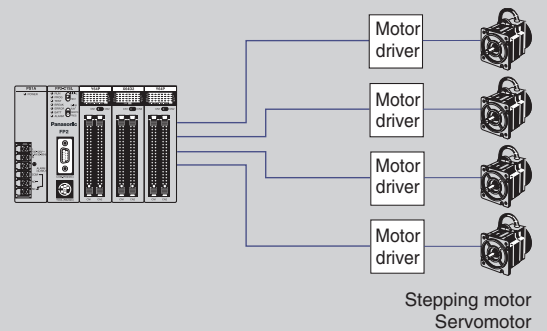

High-speed counter units
FP2-HSCT(NPN)
FP2-HSCP(PNP)

Pulse I/O units
FP2-PXYT(NPN)

FP2-PXYP(PNP)



Configuration

Counts RPM based on the encoder output, compares the count with the preset RPM, and instructs the inverter to adjust the speed or stop operation.

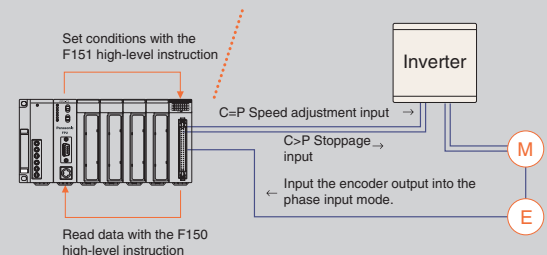



Analog Control

Accurate Process Control

■ Analog control

Multi-range control of a variety of equipment is possible. The units can be directly connected with thermocouples and resistance temperature detectors

■ Support voltage/current/temperature sensor ranges

The analog input unit supports voltage, current, and temperature sensors. The analog output unit supports voltage or current output. Different voltage/current ranges can be controlled concurrently.

■ Equipped with multiple channels

The input unit has eight channels, and the output unit has four. Space-saving multiple-channel control is possible.

■ High-speed conversion at 500ms by each channel

The speed of voltage and current input/output conversion can reach as high as 500ms.

■ I/O refresh system

Since input/output data is allocated to the I/O memory, complicated programming is not necessary.

■ Analog input units

Three types of analog input units are available to meet a wide variety of customer needs.

High-speed, high-accuracy, multiple-input unit with 8 isolated channels

Industry's fastest level

High-speed achieved by highly reliable isolation among channels

Temperature conversion: 20ms/ch

Voltage conversion: 5ms/ch

(Without insulation setting: 500ms/ch)

Industry's top level

High-accuracy conversion

Voltage: $\pm 0.1\%$ (25°C)

Temperature: $\pm 0.3\%$ (0 to 55°C)

Multiple inputs

A single unit supports inputs of thermocouple, RTD, and voltage data^{*1}.

8 inputs unit solely for RTDs (Pt100/Pt1000)

High-speed, high-accuracy



Conversion speed: 20ms/ch
Conversion accuracy: $\pm 0.3\%$
(0 to 55°C)

For users who input RTD data only and require more affordable type.

FP2-RTD

8 low costs inputs solely for voltage/current data

High-speed, high-accuracy



Low cost unit for input of voltage/current data that indicates measurements of pressure, flow rate, fluid volume, speed, etc.

FP2-AD8VI

■ Configuration

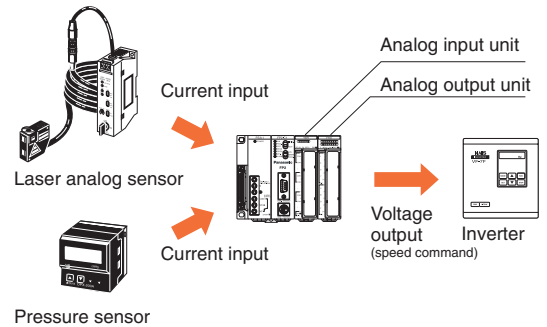

FP2-AD8X

- For users who require faster and more accurate temperature control.
- For users who require multiple isolated input channels or who want to reduce the cost per channel.
- For users who want to input temperature and voltage (current) data through a single unit.

*1: Current inputs can be converted into voltage inputs by attaching the supplied external resistor to the input terminal section.

■ Analog output unit

Supports multiple channels. (Four channels per unit).

High-speed, high-accuracy

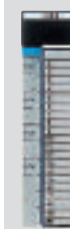

Number of outputs: 4
Conversion speed: 500ms/ch
Overall accuracy: $\pm 1.0\%$ FS or less
(0 to 55°C)

FP2-DA4



Networking

Connect all PLCs with Each Other

Support a wide variety of networks, such as open networks, PLC links, remote I/O systems, and S-LINK

Open network

Ethernet

- Supports three communication interfaces: 100BASE-TX, 10BASE-T, and 10BASE5.
- Supports TCP/IP and UDP/IP.
- Communication among a maximum of eight connections is available.
- Compatible with user-friendly MEWTOCOL.
- Supports remote programming.

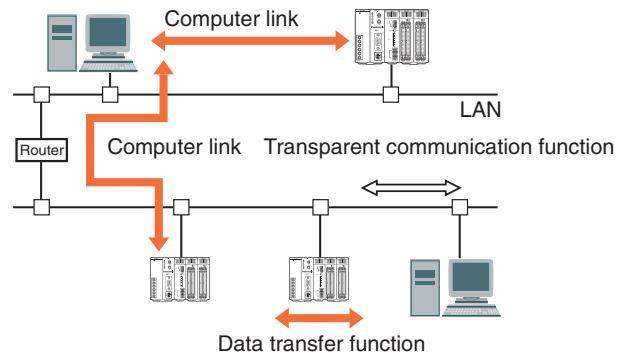

PLC link

PLC link is a system that allows our PLCs to share contact data and word data without programming.

MEWNET-W0 mode

A PLC link of the compact high-performance PLC FPΣ (Sigma)* and FP-X* can be established by using a combination of the multi-communication unit and an RS485 communication block. This mode enables the efficient connection of FP2/FP2SH, FPΣ (Sigma) and FP-X units on a single network and contributes to significant cost reduction.

- 115.2kbps transmission speed.
- Transfer of data of 64 points/128 words is possible.
- Up to 16 units can be connected.
- Extendable to 1,200m.

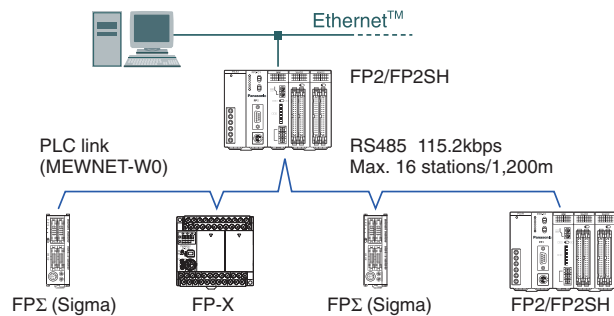

* Each FPΣ (Sigma) unit also requires an RS485 cassette (FPG-COM3 or FPG-COM4) to be attached.
 * Each FP-X unit requires that an AFPX-COM3 or AFPX-COM4 communication cassette is attached.

MEWNET-W2 mode

Large capacity PLC links can be established by using twisted-pair cables and multi-wire link units.

- 500kbps transmission speed.
- Transfer of data of 4096 points/4096 words is possible.
- Up to 32 units can be connected.
- Extendable to 1,200m

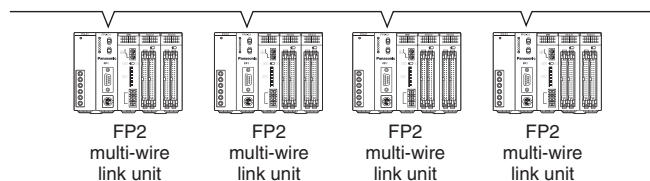



Flexible Network Slave Unit

Continuous Communication in Industrial Applications

The Flexible Network Slave (FNS) unit is a powerful, modular network unit used together with the programmable controllers FP2 and FP2SH. By exchanging compact network blocks, you can connect to various networking systems without having to modify your entire hardware platform. The blocks are available for three bus systems: PROFIBUS, DeviceNet and CANopen. Others are planned for the future.



FP2-FNS

4 simple steps to setup your network

1

Install the FP2 FNS expansion module on the backplane of your FP2 system. The number of units is restricted by the size of the FP2 backplane.



2

Various types of plug-in network blocks can be mounted in the device at any phase between manufacturer and end customer without having to worry about special protective provisions.



3

For each network type, ready-made function libraries for FPWIN Pro are available free of charge from the Panasonic Electric Works Europe AG Website (www.panasonic-electric-works.com) These libraries drastically shorten the time needed to develop your applications, and consequently save valuable human resource costs. They also include a complete online help file and programming examples.

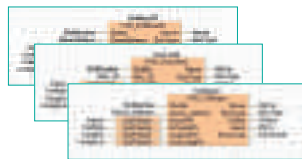

4

Download the GSD or EDS files with the description of the device from the Panasonic Electric Works Europe AG Website. The master unit requires these files to recognize the slave device characteristics.

Advantages:

- Wide range of connectivity solutions.
- One PLC hardware platform for several bus systems.
- Fast reaction to new market networking trends possible with existing units: no additional hardware development needed: you need only exchange the network block.
- Extremely compact.

PROFIBUS:

- Automatic baud rate detection.
- Transmission speed of 9.6kbps to 12Mbps.
- Max. link area of 76 words (inputs and outputs).
- Interface: DB9F (9-pin Sub-D female).



PROFIBUS Plug-in module AFPN-AB6200

DeviceNet:

- Automatic baud rate detection.
- Transmission speed of 125kbps to 500kbps.
- Max. link area of 128 words in each direction.
- Interface: 5-pin terminal block.



DeviceNet Plug-in module AFPN-AB6201

CANopen:

- Automatic baud rate detection.
- Transmission speed of 10kbps to 1Mbps.
- Max. link area of 128 words (for TPDOs and RPDOs).
- Interface: 9-pin Sub-D mode



CANopen Plug-in module AFPN-AB6218



FP Web-Server

Program/Operate the PLC using an Ethernet Network

The multifunctional FP Web-Server provides users with the option of connecting any FP Series PLC to the Internet/Intranet for bi-directional communication via Ethernet. No changes to the PLC programs are necessary. Simply assign an IP address to the FP Web-Server and connect the PLC to the FP Web-Server via the serial RS232C interface. A standard browser, e.g. MS Internet Explorer, can be used for access at the PC. The Windows-based program FP Web Configurator Tool helps you easily set up and configure the FP Web-Server.



FPWEB2

The FP Web-Server's 3 interfaces

- ← 100Base-TX / 10Base-T (RJ45, twisted pair)
– connects to the Ethernet at 100Mbit/s
- ← RS232C (screw terminal)
– connects to the PLC at 1200 to 115.2kbit/s
- ← RS232C (SUB-D 9 male)
– connects to a modem

FP Web-Server advantages

- Uses existing Intranet, saves wiring.
- Uses standard browser, saves Scada software.
- Remote control.
- Remote monitoring.
- Remote programming.
- Alarm information via e-mail.

■ Highlights

Web-Server:

PLC data presented as HTML (or XML) pages

- Access via standard Internet browser.
- PLC data handling via HTML and Java Applet.
- Optional: Password protection, IP lock security.

RS232C device server:

- Ethernet <-> RS232C conversion (MEWTOCOL).
- Transparent RS232C data tunneling via Ethernet.
- Programming and visualization via TCP or UDP.

Modem dial-out / Internet system:

- FP Web-Server can dial-out to the Internet.
- Various Internet / GPRS system solutions.

Modbus-TCP protocol:

- Communication via standard industrial Ethernet protocol (server and client).
- Gateway for Modbus-RTU units (master and slave).

IEC 60870-5-101 and IEC 60870-5-104 protocol:

- Communication via RS232C, RS485 adapter, multipoint modem, dial-up modem, Ethernet.

Network time server synchronization:

- PLC real-time clock update via NTP server.

E-mail

- PLC can send e-mails.
- E-mail via LAN e-mail server or Internet dial-up.
- PLC-defined or pre-stored e-mail text.
- PLC data array as attachment to an e-mail.

Modem dial-in / Ethernet gateway:

- FP Web-Server can be dialed up via modem.
- One remote gateway for multiple FP Web-Servers.

Specifications	
Current consumption	65mA
Operating voltage	24VDC (10.8-26.4VDC)
Communication interfaces	RS232C for connection to a PLC, RS232C for modem connection, 100Base-TX/10Base-T, Ethernet
Communication protocol	MEWTOCOL, DNS, HTTP, SMTP, FTP TELNET, TCP/IP, UDP/IP, PPP, SNTIP, Modbus
Safety	Passwords, IP lock
Ambient temp.	0°C to 55°C
Storage temp.	-20°C to +70°C
Dimensions	25W x 90H x 60D (mm)
Weight	0.11kg



Remote I/O Systems

Flexible Layout of I/O Devices

Remote I/O systems

MEWNET-F mode

The number of I/O points can be increased up to 8192 and the transmission distance can be extended up to 700m by using the multi-wire link units.

- MEWNET-F is a remote I/O system that connects I/O units in separate locations with twisted-pair cables.
- The remote I/O master unit serves as a master station. Slave stations can be selected from the units shown on the next page.
- Up to four wiring routes are available, allowing for a flexible layout of slave stations.
- This network system is ideal for cases where I/O units need to be installed in separate locations or in a location away from the control box.

F mode

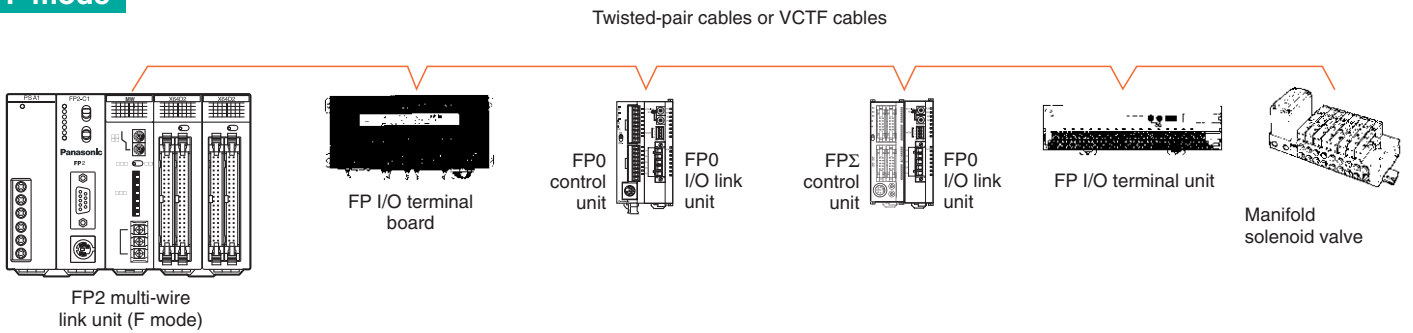

S-LINK

- S-LINK is a link system that allows the free layout of I/O devices, such as sensors, by T-branch connections with a four-wire flat cable.
- The number of I/O points can be increased up to 2048 in increments of one channel having 128 points.
- A CPU unit with S-LINK ports and a single S-LINK unit are available. FP2-C1SL has two S-LINK ports and can control 256 I/O points.



S-LINK unit
FP2-SL2



S-LINK CPU unit
FP2-C1SL

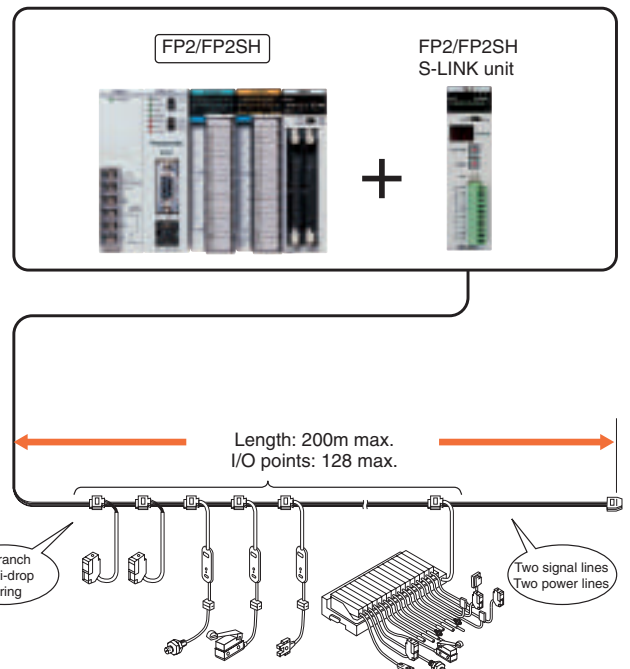

- Sensors to be connected by S-LINK must be chosen from among S-LINK-compatible sensors manufactured by SUNX Limited.

Note: The number of I/O points may be less than 128 depending on the connected device model and connection location. For details, refer to the S-LINK instruction manual of SUNX Limited.



Serial Communication

Connect to Various Serial Devices

Serial communication control

The CPU units have an RS232C port as standard equipment. The communication unit enables connections with RS232C/RS485/ RS422-compatible devices

CPU units

All CPU units have an RS232C port as standard equipment. They can be directly connected to a host computer or a display panel, and can also be connected to a modem to collect data from and change programs in devices in a remote location.



Multi-communication unit (MCU)

The communication blocks are detachable

Up to two blocks to be attached can be selected among RS485, RS232C, and RS422 blocks.



FP2-MCU

Direct connection to a control panel or a computer

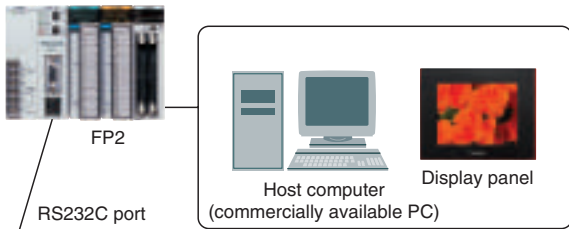

Remote monitoring via a modem

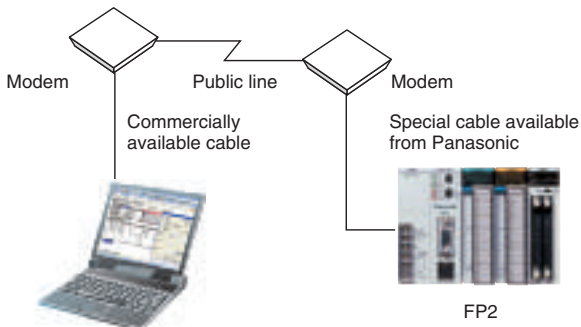

"PCWAY" for easy data collection

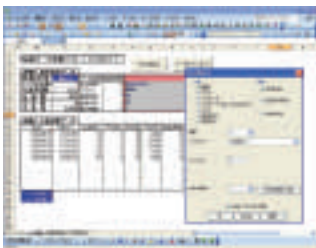

The operation data managing software "PCWAY" allows FP2/FP2SH operation data to be imported into Excel* without programming.

* Excel is a registered trademark of the Microsoft Corporation.



The 230kbps communication speed (simultaneous two-channel communication) facilitates fast large-volume data communications

Three communication blocks available.

RS232C



FP2-CB232

RS422



FP2-CB422

RS485



FP2-CB485

The combination is selectable

COM2 (the lower channel) is sealed before shipping to protect it from damage, e. g. if only COM1 is used.



Multi-communication unit FP2-MCU.

* This unit cannot operate without a communication block attached. Purchase the above communication block(s) together with this unit.



FP2

Basic CPUs

The functions for a medium-scale PLC are squeezed into a compact body. Perfect when combining various devices.



■ Features

1. Compact body

The functions for a medium-scale PLC are squeezed into a compact body which requires minimal installation area (H: 100, W: 140, D: 108.3mm).

2. Module specifications enable flexible design

Backplanes for 5, 7, 9, 12, and 14 modules are available, and since the units have the same width, you can choose the most economical design for your application.

3. RS232C port is standard

RS232C port allows connection with operation display panels and host computers, as well as remote surveillance using modems, etc.

4. Different memory options are available to meet your application

Memory units for comment, calendar timer, expansion RAM, and ROM operation are available so you can add just the options you need.

5. Dedicated instructions for high level data processing

Real number data operation is naturally supported, which simplifies programming.

■ Power supply/I/O specifications

Item	Description
Power supply	100V to 120VAC / 200V to 240VAC / 100V to 240VAC, 24VDC (varies with different models)
Input	12V to 24VDC, 24VDC \pm common
Output	Relay 2A to 5A / Transistor 0.1A to 0.5A (varies with different models)

■ Performance specifications

Item	Description
Number of I/O points	Up to 768 points
Expansion	Standard Up to 1 backplane Units: 25 max. I/O points: 1,600 max. Remote I/O points: 2,048 max.
	H type Up to 3 backplanes Units: 32 max. I/O points: 2,048 max. Remote I/O points: 2,048 max.
Operation speed	0.35 μ s/step (Basic instruction)
Built-in memory	RAM (ROM is optional)
Memory capacity	Approx. 16k steps
Operation memory	Internal relay 4048 points
	Timer/Counter (T/C) 1024 points in total
	Data register 6000 words

■ Special functions

Item	Description
Analog I/O	Available by adding analog input and analog output units
High-speed counter	Available by adding high-speed counter unit (max. 200kHz)
Pulse output	Positioning unit 2-axis Positioning unit 4-axis
Serial	RS232C port Standard equipped with CPU unit Expandable by adding C.C.U., M.C.U. and serial data unit
	RS422 RS485 Expandable by adding M.C.U.
Interrupt input	Available by adding high-speed counter unit or pulse I/O unit

■ Special network functions

Item	Description
Remote I/O	S-LINK, MEWNET-F
PLC Link	MEWNET-W2 (Wire) MEWNET-W0 PROFIBUS, DeviceNet, CANopen
Computer Link	Linkable by using tool port or COM. port on CPU unit. Also available by adding M.C.U. and C.C.U.
Modem connection	Available

■ Other built-in functions

Item	Description
Program block-edit during RUN	Available
Constant scan	Available
Clock/Calendar function	Can be used with the addition of the calendar function option

Product numbers	
Standard Type CPU	FP2-C1
CPU with 64points input	FP2-CS1D
CPU with S-LINK	FP2-C1SL



FP2SH

High-Performance CPUs

Scanning time of 1ms for 20k steps. A high-performance model for high-speed operation.



■ Features

1. Scanning time of 1ms for 20k steps

An operating speed at the top of its class enables high-speed processing and a dramatically decreased tact time.

2. Large programming capacity of up to 120k steps

60k and 120k programming capacities are available depending on the model.

3. Optional small PC card is also available

The small PC card is available for programming backup or data memory expansion. This allows great amounts of data to be processed.

4. Built-in comment and calendar timer functions

These functions, options with the FP2, are built right into the FP2SH.

The I/O unit and intelligent unit are the same for the FP2 series.

■ Power supply/I/O specifications

Item	Description
Power supply	100V to 120VAC / 200V to 240VAC / 100V to 240VAC, 24VDC (varies with different models)
Input	12V to 24VDC, 24VDC \pm common
Output	Relay 2A to 5A / Transistor 0.1A to 0.5A (varies with different models)

■ Performance specifications

Item	Description	
Number of I/O points	Up to 768 points	
Expansion	Standard Units: 25 max. I/O points: 1,600 max. Remote I/O points: 8,192 max.	
	H type Units: 32 max. I/O points: 2,048 max. Remote I/O points: 8,192 max.	
Operation speed	0.03 μ s/step (Basic instruction)	
Built-in memory	RAM (ROM/Small PC card is optional)	
Memory capacity	Approx. 60k steps/approx. 120k steps (varies with different models)	
Operation memory	Internal relay	14,192 points
	Timer/Counter (T/C)	3072 points in total
	Data register	10,240 words
	File register	32,765 words x 3 banks

■ Special functions

Item	Description
Analog I/O	Available by adding analog input and analog output units
High-speed counter	Available by adding high-speed counter unit (max. 200kHz)
Pulse output	Positioning unit 2-axis Positioning unit 4-axis
Serial	RS232C port Standard equipped with CPU unit Expandable by adding C.C.U., M.C.U. and serial data unit
	RS422 RS485 Expandable by adding M.C.U.
Interrupt input	Available by adding high-speed counter unit or pulse I/O unit

■ Special network functions

Item	Description
Remote I/O	S-LINK, MEWNET-F
PLC Link	MEWNET-W2 (Wire) MEWNET-W0 MEWNET-VE PROFIBUS DeviceNet CANopen
Computer Link	Linkable by using tool port or COM. port on CPU unit. Also available by adding M.C.U. and C.C.U.
Modem connection	Available

■ Other built-in functions

Item	Description
Program block-edit during RUN	Available
Constant scan	Available
Clock/Calendar function	Built-in type

Product numbers	
Standard Type CPU (60k steps)	FP2-C2
CPU for small PC card (60k steps)	FP2-C2P
CPU for small PC card (120k steps)	FP2-C3P



FP2/FP2SH

Product Line and Accessories

FP2/FP2SH system configurations and unit lineup

Unit combinations

- Most units occupy one slot, i. e. module each, though some units occupy two slots.
- When selecting a backplane, carefully consider the units and number of slots you need.
- The power supply unit and CPU unit must be mounted on the CPU backplane.



Power supply units



100VAC,
2.5A type
FP2-PSA1



200VAC,
2.5A type
FP2-PSA2



100 to 240VAC,
5A type
FP2-PSA3



24VDC,
5A type
FP2-PSD2

Backplanes

(For use as both master and expansion backplanes. The 5-module type cannot be used with or as an expansion backplane.)



5-module type
FP2-BP05



7-module type
FP2-BP07



9-module type
FP2-BP09



12-module type
FP2-BP12



14-module type
FP2-BP14

H type backplanes



H type master backplane
(11 modules): 8 slots
FP2-BP11MH



H type expansion backplane
(10 modules): 8 slots
FP2-BP10EH

Units that occupy two modules each

Type	Model No.
Power supply unit, 5A type	FP2-PSA3 FP2-PSD2
CPU unit with 64 input points	FP2-C1D
CPU unit with S-LINK ports	FP2-C1SL



Expansion cable
(60cm)
FP2-EC



Expansion cable
(2m)
FP2-EC2



Dummy unit
FP2-DM

CPU units

FP2



Standard type
FP2-C1



With 64-point input
FP2-C1D



With S-LINK
FP2-C1SL

FP2SH



Standard type
(60k steps)
FP2-C2



For small PC card
(60k steps)
FP2-C2P



For small PC card
(120k steps)
FP2-C3P

FP2/FP2SH

Product Line and Accessories

- Except for the 5-module expansion backplane, or backplanes can be expanded.
 - If the backplane is of the H type, up to three backplanes can be added.
 - Most of the units can be used in any combination; however, some combinations are subject to constraints due to the unit type, current consumption, etc.
- Please contact us for details.*

Input and output units



16-point DC input
FP2-X16D2

16-point NPN transistor output
FP2-Y16T

16-point PNP transistor output
FP2-Y16P

6-point Relay output (5A)
FP2-Y6R

16-point Relay output (2A)
FP2-Y16R



32-point DC input
FP2-X32D2

32-point NPN transistor output
FP2-Y32T

32-point PNP transistor output
FP2-Y32P



64-point DC input
FP2-X64D2

64-point NPN transistor output
FP2-Y64T

64-point PNP transistor output
FP2-Y64P

32-point input/32-point NPN output mixed
FP2-XY64D2T

FP2-XY64D7T

32-point input/32-point PNP output mixed
FP2-XY64D2P

FP2-XY64D7P

Optional memories

For FP2



FP2-EM1
FP2-EM2



FP2-EM3
FP2-EM6
FP2-EM7

Type of memory unit

	A	A	N/A	N/A
FP2-EM1	A	A	N/A	N/A
FP2-EM2	A	A	A	N/A
FP2-EM3	A	A	A	A
FP2-EM6	N/A	N/A	A	A
FP2-EM7	N/A	N/A	N/A	A

A: Available
N/A: Not available

For FP2SH





F-ROM
FP2-EM4



EP-ROM
FP2-EM5

FP Memory Loader







Memory unit with ROM socket
FP2-EM7 (AFP2207)



F-ROM
SRAM (AFP5208)



Small PC card (2MB)
F-ROM (AIC50020)



Small PC card (2MB)
SRAM (AIC52000)



EP-ROM (AFP5209)

Data clear/
Data hold type
AFP8670/
AFP8671

Analog input/output units



Voltage/current input unit
FP2-AD8VI



Multiple analog input unit
FP2-AD8X



Resistance thermometer device input unit
FP2-RTD



Analog output unit
FP2-DA4

Positioning units

NEW



(2-axis)
Positioning units
RTEX
FP2-PN2AN

NEW



(4-axis)
Positioning units
RTEX
FP2-PN4AN

NEW



(8-axis)
Positioning units
RTEX
FP2-PN8AN



(2-axis)
Positioning units
FP2-PP21



(2-axis)
Positioning units
FP2-PP22



(4-axis)
Positioning units
FP2-PP41



(4-axis)
Positioning units
FP2-PP42

Pulse input/output units



High-speed counter unit
FP2-HSCP



Pulse I/O unit
FP2-PXPYP



Multi-communication unit
FP2-MCU



Serial data unit
FP2-SDU



Computer communication unit
FP2-CCU

The communication blocks are available separately.

Link-related units



ET-LAN
FP2-ET1



Multi-wire link unit
FP2-MW



S-LINK
FP2-SL2



Flexible Network Slave
FP2-FNS



Control FPCWIN Pro

Programming According to the International Standard IEC 61131-3

FPCWIN Pro is the Panasonic programming software developed according to the international standard IEC 61131-3 (for Windows 98, NT V4.0, 2000, ME, XP or Vista). This new version is a result of experience gained over many years. We were one of the first PLC manufacturers to offer an IEC 61131-3 programming software, and we are a leading member of the international organization PLCOpen.

Input and output variables are defined once in the global variable list

Multiple address assignment is caught automatically by the compiler

Type safe programming using simple or complex data types

Comfortable programming in the graphical LD editor (ladder diagram)

Functions can be saved in libraries for future reuse

One instruction for different data types (overloaded instructions)

Navigator with tree representation of called functions provides an overview even for very complex projects

Long variable names make the program self-explanatory

The SFC editor (Sequential Function Chart) allows you to easily visualize processes

Additional window for monitoring and forcing variables

Special functions for controlling the SFC program from another program

Using aliases names for PLC-independent access on the special data registers, e.g. RTC

The ST editor (Structured Text) solves complex programming tasks

Structuring with selection statements

Using loops for running through incoming data

Using STRING functions for analyzing incoming data...

...or for generating formatted output strings

Easy handling of formulas and arithmetic expressions

FPCWINPro full version supports all FP Series PLCs.

Product numbers	
With English manual	FPWINPROFEN5
With German manual	FPWINPROFDE5
With French manual	FPWINPROFFR5

FPCWINPro small version supports: FP-e, FP0, FP-X, FPΣ (Sigma)

Product numbers	
With English manual	FPWINPROSEN5
With German manual	FPWINPROSDE5
With French manual	FPWINPROSFR5

The most important highlights at a glance:

- One software for all FP Series PLCs.
- 5 programming languages (instruction list, ladder diagram, function block diagram, sequential function chart, structured text) available for all PLCs.
- Program organisation units, task and project management provide clear structure.
- Reuse of ready-made functions and function blocks saves time for programming and debugging.
- Online monitoring and diagnostics.
- Forcing – Turning off input and output contacts via the PC.
- Modem and Ethernet communication for remote programming, service and diagnostics.
- Extensive comments – online documentation created hand in hand with the program.
- 6 languages are supported: English, German, French, Italian, Spanish and Japanese.

Free demonstration disc





Other software tools

FP OPC Server and FP Data Analyzer

■ FP OPC Server

Connects your favorite industrial application to FP2 or other FP Series PLCs

The Panasonic FP OPC Server allows high-performance data transfer between applications supporting the universally accepted OPC PC DA Standard (v1-v3) and Panasonic FP Series PLCs. The FP OPC Server manages the device-specific communication and provides data via a standard interface. Thus OPC clients connected to the server can exchange information with FP2 or other FP Series PLCs.

■ Features of the FP OPC Server

- Modern and intuitive user interface allows you to configure the server. While creating the application, sophisticated user assistance helps you in your work.
- The server complies to the following OPC DA client/server technologies: OPC DA 1.0a, 2.05a and 3.0.
- The PLCs can be accessed via serial, modem and Ethernet communication lines.
- State-of-the-art import / export mechanism allows you to save, exchange or edit data in XML format. Data can also be exchanged using a CSV file.
- An icon or tool tip notifies the user about possible errors in configuration.
- The FP OPC Server allows you to clearly structure your application, e.g. by grouping elements in meaningful hierarchies.
- Tolerant of interruptions due to optimized communication features.

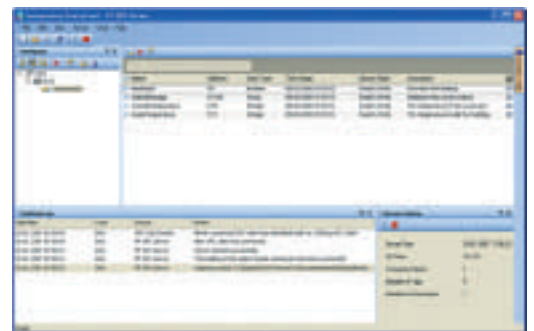

FP OPC Server software with one license
Product number: AFPS03510D
FP OPC Server additional license
Product number: AFPS03517D

■ FP Data Analyzer

The FP Data Analyzer is a software tool for acquisition, logic analysis and representation of recorded data on multiple channels connected to any Panasonic PLC. The software is a stand-alone tool. You need not install any other software to run the FP Data Analyzer.

The FP Data Analyzer can be connected to the FP2 by utilizing the integrated MEWNET Manager, for instance via the COM port. Recording and analyzing remote PLCs via LAN or modem is just a matter of seconds.

The tool can be used for:

- Performing failure diagnostics.
- Finding and isolating failures.
- Performing analyses, system optimization.
- Documenting processes.
- Shortening the time between setup and operation.
- Carrying out machine maintenance.
- Improving development.

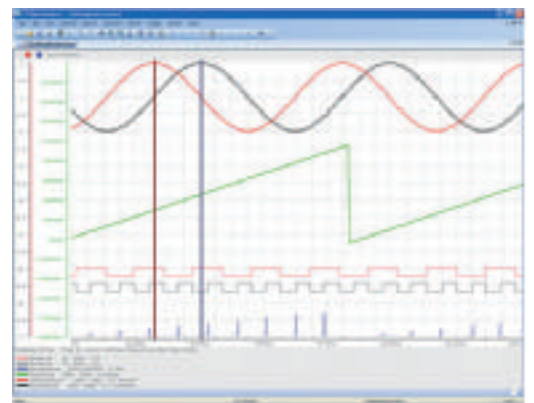

FP Data Analyzer
Product number: AFPS04510D



FP2/FP2SH

Specifications

■ CPU units

Item		FP2 CPU unit		FP2SH CPU unit		
		FP2-C1 FP2-C1D FP2-C1SL	FP2-C2	FP2-C2P	FP2-C3P	
Operation speed	Basic	0.35μs or more		0.03μs or more		
	High-level	0.93μs or more		0.06μs or more		
Program capacity	Built-in RAM	16k steps		60k steps		120k steps
	With expansion	32k steps		Not available		Not available
Number of I/O points	No expansion	Conventional type	Max. 768 points			
		H type	Max. 512 points			
	With expansion	Conventional type	Max. 1600 points			
		H type	Max. 2048 points			
With remote I/O		Max. 2048 points		Max. 8192 points		
Operation memory	Internal relay	4048 points		14,192 points		
	Data register	6000 words		10,240 words		
	File register	0 to 143,333 words (w/expansion 0 to 30,717 words)		32,765 words x 3 banks		
	Link register	256 words		8448 words		
Optional memory		F-ROM/EP-ROM		F-ROM/EP-ROM	Small PC card (F-ROM/S-RAM)	
Comment memory		Optional memory unit		Available		
Clock/Calendar function		Optional memory unit		Available		

■ Power supply units

Item		FP2-PSA1	FP2-PSA2	FP2-PSA3	FP2-PSD2
Input	Rated voltage	100V - 120VAC	200V - 240V	100V - 240VAC	24VDC
	Current consumption	0.4A or less (at 100VAC)	0.2A or less (at 200VAC)	0.7A or less (at 100VAC) 0.4A or less (at 200VAC)	2.5A or less
	Surge current	40A or less (55°C)		30A or less (25°C)	10A or less
	Rated frequency	47Hz ~ 63Hz			
	Operating	85 to 132VAC	170 to 264VAC	85 to 264VAC	20.4 to 31.2VDC (note)
Output	Voltage range	2.5A max.		5A max.	
Alarm contact capacity		30VDC 1A			
Alarm contact operation		When the ALARM LED of CPU unit is lit			
Alarm contact type		1c contact			
Leakage current		Between input and ground terminals, 0.75mA or less			
Breakdown voltage		1500VAC for 1 minute (between input and ground terminals)			
Insulation resistance		100 MΩ 500VDC (between input and ground terminals)			
Guaranteed lifetime		20,000 hours at 55°C			
Overcurrent protection function		Built-in overcurrent protection			
Fuse		Built-in type			
Terminal screw		M3			
Module size		1 modul	1 modul	2 module	2 module

Note: Allowable voltage fluctuation range after startup for the FP2-PSD2 is -35% to +30%. At startup, apply -15% to +30% the rated voltage for 100ms or more.



FP2/FP2SH

Specifications

Input units

Item	DC input unit			I/O mixed unit (input side)	
	16-point DC input type	32-point DC input type	64-point DC input type ¹⁾	DC input type/Transistor output (NPN) type ²⁾	DC input type/Transistor output (PNP) type ³⁾
	FP2-X16D2	FP2-X32D2	FP2-X64D2	FP2-XY64D2T	FP2-XY64D2P
Rated input voltage	12 - 24VDC	24VDC	24VDC	24VDC	24VDC
Rated input current	Approx. 8mA (at 24VDC)	Approx. 4.3mA (at 24VDC)	Approx. 4.3mA (at 24VDC)	Approx. 4.3mA (at 24VDC)	Approx. 4.3mA (at 24VDC)
Input impedance	Approx. 3kΩ	Approx. 5.6kΩ	Approx. 5.6kΩ	Approx. 5.6kΩ	Approx. 5.6kΩ
Min. ON voltage/Min. ON current	9.6V/4mA	19.2V/4mA	19.2V/4mA	19.2V/4mA	19.2V/4mA
Max. OFF voltage/Max. OFF current	2.5V/1mA	5.0V/1.5mA	5.0V/1.5mA	5.0V/1.5mA	5.0V/1.5mA
Response time	OFF→ON	0.2ms or less	0.2ms or less	0.2ms or less	0.2ms or less
	ON→OFF	0.2ms or less	0.3ms or less	0.3ms or less	0.3ms or less
Input points per common	8 points/common (Either the positive or negative of the input power supply can be connected to the common terminal.)	32 points/common	32 points/common	32 points/common	32 points/common
Connection method	Terminal block (M3 screw)	One 40-pin connector	Two 40-pin connectors	Two 40-pin connectors	Two 40-pin connectors

Notes: The number of ON points that can be actuated simultaneously is limited by the input voltage and the ambient temperature.

- 1) The specifications also apply to the input side of the CPU unit with 64 input points "FP2-C1D".
- 2) The specifications also apply to the DC-input, transistor-output (NPN) type I/O-mixed unit with ON pulse catch input "FP2-XY64D7T".
However, the response time is as follows: OFF→ON: 0.2ms or less (X0-X1F); ON→OFF: 0.3ms or less (X0-X1B), 1.0 to 5.0ms (X1C-X1F)
- 3) The specifications also apply to the DC-input, transistor-output (PNP) type I/O-mixed unit with ON pulse catch input "FP2-XY64D7P".
However, the response time is as follows: OFF→ON: 0.2ms or less (X0-X1F); ON→OFF: 0.3ms or less (X0-X1B), 1.0 to 5.0ms (X1C-X1F)

Output units

Item	Relay output unit				Transistor output unit				I/O mixed unit (output side) ^{note 3) and 4)}	
	^{note 1)}		NPN open collector ^{note 2)}	PNP open collector ^{note 2)}	NPN	PNP	NPN	PNP	DC input type/	DC input type/
	6-point type	16-point type	16-point type	16-point type	open collector	open collector	open collector	open collector	Transistor output (NPN) type	Transistor output (PNP) type
	FP2-Y6R	FP2-Y16R	FP2-Y16T	FP2-Y16P	FP2-Y32T	FP2-Y32P	FP2-Y64T	FP2-Y64P	FP2-XY64D2T	FP2-XY64D2P
Rated control capacity	5A 250VAC (10A/common) 5A 30VDC (10A/common) Min. load: 100mA 10V (resistor load)	2A 250VAC (5A/common) 2A 30VDC (5A/common) Min. load: 100μA 10V (resistor load)	-	-	-	-	-	-	-	-
Rated load voltage	-	-	5-24VDC	5-24VDC	5-24VDC	5-24VDC	5-24VDC	5-24VDC	5-24VDC	5-24VDC
Max. load current	-	-	0.5A (at 12 to 24VDC) 0.1A (at 5VDC)	0.5A (at 12 to 24VDC) 0.1A (at 5VDC)	0.1A (at 12 to 24VDC) 50mA (at 5VDC)	0.1A (at 12 to 24VDC) 50mA (at 5VDC)	0.1A (at 12 to 24VDC) 50mA (at 5VDC)	0.1A (at 12 to 24VDC) 50mA (at 5VDC)	0.1A (at 12 to 24VDC) 50mA (at 5VDC)	0.1A (at 12 to 24VDC) 50mA (at 5VDC)
Max. surge current	-	-	3A 10ms or less	3A 10ms or less	0.3A	0.3A	0.3A	0.3A	0.3A	0.3A
OFF state leakage current	-	-	1μA or less	1μA or less	1μA or less	1μA or less	1μA or less	1μA or less	1μA or less	1μA or less
ON state maximum voltage drop	-	-	0.5V or less	0.5V or less	1V or less (at 6 to 26.4VDC) 0.5V or less (at 6VDC or less)	1.5V or less (at 6 to 26.4VDC) 0.5V or less (at 6VDC or less)	1V or less (at 6 to 26.4VDC) 0.5V or less (at 6VDC or less)	1.5V or less (at 6 to 26.4VDC) 0.5V or less (at 6VDC or less)	1V or less (at 6 to 26.4VDC) 0.5V or less (at 6VDC or less)	1.5V or less (at 6 to 26.4VDC) 0.5V or less (at 6VDC or less)
Repose time	OFF→ON	10ms or less	10ms or less	0.1ms or less	0.1ms or less	0.1ms or less	0.1ms or less	0.1ms or less	0.1ms or less	0.1ms or less
	ON→OFF	8ms or less	8ms or less	0.3ms or less	0.3ms or less	0.3ms or less	0.3ms or less	0.3ms or less	0.3ms or less	0.3ms or less
Power supply for driving internal circuit	Voltage	24VDC±10% (21.6V to 26.4VDC)	24VDC±10% (21.6V to 26.4VDC)	4.75 to 26.4VDC	4.75 to 26.4VDC	4.75 to 26.4VDC	4.75 to 26.4VDC	4.75 to 26.4VDC	4.75 to 26.4VDC	4.75 to 26.4VDC
	Current	70mA or less	160mA or less	120mA or less (at 24VDC)	70mA or less (at 24VDC)	140mA or less (at 24VDC)	150mA or less (at 24VDC)	250mA or less (at 24VDC)	270mA or less (at 24VDC)	120mA or less (at 24 VDC)
Input points per common	2 points/common	8 points/common	8 points/common	8 points/common	32 points/common	32 points/common	32 points/common	32 points/common	32 points/common	32 points/common
Connection method	Terminal block (M3 screw)	Terminal block (M3 screw)	Terminal block (M3 screw)	Terminal block (M3 screw)	One 40-pin connector	One 40-pin connector	Two 40-pin connectors	Two 40-pin connectors	Two 40-pin connectors	Two 40-pin connectors

Notes: The number of ON points that can be actuated simultaneously is limited by the input voltage and the ambient temperature.
The maximum load current is limited by the external power supply voltage.

- 1) The current capacity of each common terminal is 5A max.
- 2) The maximum load current of the transistor output unit is limited by the external power supply voltage.
- 3) The specifications also apply to the DC-input, transistor-output (NPN) type I/O-mixed unit with ON pulse catch input "FP2-XY64D7T".
- 4) The specifications also apply to the DC-input, transistor-output (PNP) type I/O-mixed unit with ON pulse catch input "FP2-XY64D7P".



FP2/FP2SH

Specifications

■ Analog I/O units

1. Analog input

Item	FP2-AD8X	FP2-RTD	FP2-AD8VI	
Number of input points	8 channels	8 channels	8 channels	
Input range (resolution)	Voltage	±10V (1/65536)	–	
		1V ± 5V (1/13107)	–	
		±100mV (1/65536)	–	
	Current	– ^{note1)}	–	±20mA (1/32768)
				4mA to 20mA (1/13107)
	Thermocouple	S: 0 to +1500°C (0.1°C)	–	–
		J: -200 to +750°C (0.1°C)		
		J: -100 to +400°C (0.1°C)		
		K: -200 to +1200°C (0.1°C)		
		K: -200 to +1000°C (0.1°C)		
K: -200 to +600°C (0.1°C)				
T: -200 to +350°C (0.1°C)				
R: 0 to +1500°C (0.1°C)				
N: -200 to +1300°C (0.1°C)	–			
R.T.D	Pt 100 : -200 to +650°C (0.1°C)	–	–	
	Pt 100 : -100 to +200°C (0.1°C)			
	JPt 100 : -200 to +650°C (0.1°C)			
	JPt 100 : -100 to +200°C (0.1°C)			
	JPt1000 : -100 to +100°C (0.1°C)			
Conversion speed	Voltage	500µs/ch (insulated), 5ms (insulated)	–	
	Current	–	–	
	Thermocouple	20ms/ch	–	
	R.T.D	20ms/ch	20ms/ch	
Overall accuracy	Voltage: ±0.1% F.S. (25 °C) Voltage temperature coefficient: ±0.3% (0 to 55 °C)		±0.3% F.S. (0 to 55°C)	
Insulation method	Between the input terminal and FP2 internal circuits: Photocoupler and DC/DC converter		Between the input terminal and FP2 internal circuits: Photocoupler	
	Between channels: PhotoMOS relay		–	
Digital output	Averaging	Selectable from 3 to 64 times for each channel (Moving average after cutting the maximum and minimum values)		
	Offset setting	Selectable from K -2048 to +2047 for each channel		
Broken wire sensing	Each channel (only when a thermocouple or RTD is inputted)	Each channel	–	
Input range change method	Batch switching of all channels: By the range setting switch			
	Each channels: By shared memory setting			

Note 1: Current inputs can be converted into voltage inputs by attaching the supplied external resistor to the input terminal section.

2. Analog output

Item	Analog output unit FP2-DA4	
Number of output points	4 channels	
Output range (digital input)	Voltage	±10V (K-2048 to K+2047)
	Current	0 to 20mA (K0 to K4095)
Resolution	1/4096	
Conversion speed	500µs/ch	
Overall accuracy	±1.0% F.S. or less (0 to 55°C)	
Insulation method	– Between the output terminal and FP2 internal circuits: Photocoupler – Between channels: No insulation	
Analog output	Hold/Non-hold setting by shared memory setting	



FP2/FP2SH

Specifications

ET-LAN units

Performance Specification

Item	Specifications
Communications function	- MEWTOCOL-COM: computer link function (max. 2KB) - MEWTOCOL-DAT: data transfer (max. 1020 words) - Transparent communication
Number of communication connections	8 connections max.
Transparent communications buffer	Transmit: Factory setting: 1k words/connection x 3 Receive: Factory setting: 1k words/connection x 3

Transmission specifications for communication interface

Item	100BASE-TX ¹⁾	100BASE-T ¹⁾	100BASE5
Transmission speed	100Mbit/s	10Mbit/s	10Mbit/s
Transmission method	Base band	Base band	Base band
Max. segment length	100m ^{note 2)}	100m ^{note 2)}	500m
Max. distance between nodes	205m (2 segments)	500m (5 segments)	2500m (5 segments)
Communication cable or connection	Category 5 UTP cable	Category 3, 4 and 5 UTP cable	Transceiver cable
Max. transceiver cable length	-	-	50m ^{note 3)}
Max. number of nodes	-	-	100 nodes/segment
Node spacing	-	-	Integer multiples of 2.5m

Notes: 1) Switching between 100BASE-TX and 10BASE-T is done automatically by auto negotiation function.
 2) The standards cite 100m as the maximum, but noise resistance measures such as attaching a ferrite core may be necessary in some cases, depending on the usage environment. Also, if the hub is positioned close to a control board, we recommend using it at a distance of 10m or less.
 3) The standards cite 50m as the maximum, but noise resistance measures such as attaching a ferrite core may be necessary in some cases, depending on the usage environment. Also, if the transceiver is positioned close to a control board, we recommend using it at a distance of 5m or less.

Multi-communication units

Item	General-purpose serial communications		Computer link ¹⁾ (Panasonic open protocol "MEWTOCOL" should be used.)		PLC link function
	1:1 communications	1:N communications	1:1 communications	1:N communications	
Communication block used	FP2-CB232 FP2-CB422	FP2-CB485	FP2-CB232 FP2-CB422	FP2-CB485	FP2-CB232 FP2-CB422
Interface	RS232C RS422	RS485	RS232C RS422	RS485	RS232C RS485
Communication method	Full duplex	Two-wire half duplex	Full duplex	Two-wire half duplex	Token passing (Floating master)
Synchronization	Start-stop synchronization				
Transmission line	Three-core or five-core shielded wire	Twisted-pair cable or VCTF	Three-core or five-core shielded wire	Twisted-pair cable or VCTF	Twisted-pair cable or VCTF
Transmission distance	15m Length: 1200m max.	Length: 1200m max.	15m Length: 1200m max.	Length: 1200m max.	1200m (RS485) 15m (RS232C)
Transmission speed (To be set in the system register)	300 to 230,400bps	300 to 230,400bps (19,200 bps when our C-NET adapter is connected)	300 to 230,400bps	300 to 230,400bps (19,200 bps when our C-NET adapter is connected)	115,200bps
Transmission code	ASCII, JIS7, JIS8, and binary		ASCII, JIS7, JIS8		-
Transmission format (To be set in the system register)	Data length: 7 bits/8 bits				
	Parity: 0/Invalid/Valid (Odd/Even)				
	Stop bit: 1 bit/2 bits				
	Start code: With STX / Without STX		-		
End code: CR/CR+LF/Time setting/ETX		-			
Number of stations	-	99 stations max. (32 stations max. when our C-NET adapter is connected)	-	99 stations max. (32 stations max. when our C-NET adapter is connected)	16 stations max.
PLC link capacity	-	-	-	-	Link relay: 1024 points Link register: 128 words
COM1 (upper channel)	A	A	A	A	A
COM2 (lower channel)	A	A	A	A	N/A
Number of attachable units	23 units max. (including 8 units for the computer link and 2 channels for the PLC link)				
Supported versions	CPU unit (both FP2 and FP2SH): Ver. 1.4 or later, FPWIN GR: Ver. 2.4 or later, FPWIN PRO: Ver. 5.1 or later				

Note 1: The protocol can be downloaded from: www.panasonic-electric-works.com

A: Available
N/A: Not available



FP2/FP2SH

Specifications

Multi-wire link units

Item	FP2-MW		
	W mode	W2 mode ¹⁾	F mode
Communication method	Token bus		Polling
Transmission method	Base band		
Transmission speed	500kbit/s	500kbit/s, 250kbit/s	500kbit/s
Transmission distance	Extendable to 800m	Extendable to 800m 250kbits/s: 1200m max. 500kbits/s: 800m max.	Extendable to 700m
Number of connectable stations	32 stations max.		1 master + 32 slave stations max.
Transmission error check	CRC (cyclic redundancy check) system		
Synchronization	Start-stop synchronization		
Interface	RS485 compatible		
Transmission line	Twisted-pair cable		Twisted-pair cables or VCTF cables
RAS function	Hardware self-diagnosis function		

Note 1: When the unit is used in W2 mode, it must be set by user programs.

S-LINK units

Item	S-LINK units	CPU unit with S-LINK ports
	FP2-SL2	FP2-C1SL
Number of channels	1	2
Number of I/O points	128 points max.	128 points max. × 2
Rated power supply voltage	The number of input and output points for each channel can be selected by the switch in the unit body Input: 0/32/64/96/128 points Output: 0/32/64/96/128 points +24VDC ±10% Maximum allowable ripples (P-P): ±10% (S-LINK terminal block IN-24VDC 1.6 A or less)	
Power consumption ¹⁾	[Current consumption of the S-LINK controller (incl. D-G line current consumption)] +24VDC 1.6A or less [Maximum allowable current supply (Supply to the S-LINK and I/O devices through the 24V - 0V line)] +24VDC 5A (Fuse: 5A or less)	
Transmission method	Bi-directional time division multiplex transmission	
Synchronization	Bi/Frame synchronization	
Transmission protocol	S-LINK protocol	
Transmission speed	28.5kbit/s	
Transmission distance ²⁾	Main signal line: Extendable to 200m (max. 400m when a booster is used)	
FAN-OUT ²⁾	320	
Connection method	T-branch multi-drop wiring or standard multi-drop wiring [+24, 0V, D-G (with a function of D-G short-circuit protection)]	

Notes: 1) Refer to the "Power Capacity Determination" section of SUNX Limited's S-LINK Design Manual for details of the current consumption.

2) Refer to SUNX Limited's S-LINK Design Manual for the booster and FAN-OUT.

Positioning units: RTEX (Network type)



Item	RTEX (Network type)		
	2-axis type	4-axis type	8-axis type
Product number	FP2-PN2AN	FP2-PN4AN	FP2-PN8AN
Position control function	Control method	PTP control, continuous path (CP) control	
	Interpolation control	Two/Three-axis linear interpolation, two-axis circular interpolation, three-axis helical interpolation	
	Unit of control	Pulse/μm/inch/degree	
	Positioning data	600 points per axis	
	Backup	Parameters and data tables can be saved in FROM	
	Acceleration/deceleration method	Linear/S-curve acceleration and deceleration	
	Acceleration/deceleration time	0 to 10,000ms (in increments of 1ms)	
Positioning range	(-1073741823 to +1073741823 pulses) Increment/Absolute specification		
Speed control function	Supported by a JOG operation (free-run operation)		
Torque control function	Supported by a real-time torque control function		
Home return	Search method	Home proximity (DOG) search	
	Creep rate	Can be set freely	
Others	Pulser input operation supported		
	Auxiliary output code and auxiliary output contact		
	Dwell time In-position contact		
Communication speed	100Mbps		
Cables	Commercially available LAN straight cable (Category 5e shielded cable)		
Connection system	Ring		
Communication cycle/ Number of connectable stations	0.5ms, 8 axes max./system (Command cycle: 1ms)		
Transmission distance	Between terminals: 60m Total: 200m		

FNS (Flexible Network Slave) specifications:

Item	PROFIBUS	DeviceNet	CANopen
Baud rate	• Automatic baud rate detection • 9.6 kbaud to 12Mbaud	• Automatic baud rate detection • 125kbps to 500kbps	• Automatic baud rate detection • 10kbps to 1Mbps
Isolation	Galvanically isolated bus electronics	Galvanically isolated bus electronics	Galvanically isolated bus electronics
Connection types	DP-V0: process data is accessed from the PROFIBUS network as cyclical I/O data	• Cyclic connections • COS (Change of State) • Bit strobe connections • Polled connections • Explicit connections	PDO (Process Data Object) Exchange via: • Cyclic Synchronous • Acyclic Synchronous • COS • Timer-driven connections
Maximum inputs / outputs	76 words altogether for inputs and outputs (in units of 1, 2 or 4 words)	E. g. for cyclic connections: 128 words in each direction	Data 128 words (for TPDOs and RPDOs)
Additional features	Diagnostic support	• UCMM capable • CIP parameter object • Diagnostic support	Diagnostic support



FP2/FP2SH

Specifications

■ Positioning units: multifunction type (pulse output type)

		FP2-PP21	FP2-PP41	FP2-PP22	FP2-PP42
Output type		Transistor		Line driver	
Number of axes controlled		2 axes, independent	4 axes, independent	2 axes, independent	4 axes, independent
Position command	Command units Max. pulse count	Pulse unit (the program specifies whether Increment or Absolute is used.) Signed 32 bits (-2147483648 to +2147483647 pulses)			
Speed command	Command range	1pps to 500kpps (can set in 1pps)		1pps to 4Mpps (can set in 1pps)	
Acceleration/deceleration command	Acceleration/deceleration	Linear acceleration/deceleration, S acceleration/deceleration (this takes the form of an "S")			
	"S" Acceleration/deceleration	Can select from Sin curve, Secondary curve, Cycloid curve and Third curve			
	Acceleration/deceleration time	0 to 32,767ms (can set in 1ms)			
Home return	Home return speed	Speed setting possible (changes return speed and search speed)			
	Input terminals	Home input, Near home input, Over limit input (+), Over limit input (-)			
	Output terminals	Deviation counter clear output signal			
Operation mode		<ul style="list-style-type: none"> E point control (Linear and S accelerations/decelerations selecting possible) P point control (Linear and S accelerations/decelerations selecting possible) Home return function (Home search) JOG operation function JOG positioning function Pulser input function Transfer multiplication ratio (×1, ×2, ×5, ×10, ×50, ×100, ×500, ×1000 selecting possible) Real-time frequency change function Infinity output function 			
Startup time		0.02ms or 0.005ms possible			
Output interface	Output mode	1 pulse output (Pulse/Sign), 2 pulse output (CW/CCW)			
Feedback counter	Countable range	Signed 32-bit (-2147483648 to +2147483647 pulse)			
	Input mode	2-phase input*, Direction distinction input, Individual input (transfer multiple available for each)			
Other functions		The flag to compare the elapsed value is built-in (The timing signal outputs at the optional position during an operation)			
External power supply	Internal current consumption (at 5 VDC)	200mA max.	350mA max.	200mA max.	350mA max.
	Voltage	21.6VDC to 26.4VDC			
Current consumption	Voltage	50mA	90mA	50mA	90mA
	Current consumption	50mA	90mA	50mA	90mA

Notes: Previous FP2 positioning units FP2-PP2 and FP2-PP4 are not compatible with the multi-function type FP2 positioning unit. Please contact us.
* 2-phase input cannot be used with multiples of one.

■ High-speed counter units and pulse I/O units

Item		FP2 High-speed counter unit	FP2 Pulse I/O unit	
Product number		FP2-HSCT (NPN)	FP2-PXYT (NPN)	
		FP2-HSCP (PNP)	FP2-PXYP (PNP)	
Part no.	Insulation method	Photocoupler insulation		
	Rated voltage	24VDC		
	Rated current	Approx. 7.5mA (when using 24VDC)		
	Input impedance	Approx. 3.2kΩ		
	Usage voltage range	20.4VDC to 26.4VDC		
	Min. ON voltage/Min. ON current	19.2V /6mA		
	Min. OFF voltage/Min. OFF current	5.0V /1.5mA		
	Response time ¹⁾	OFF→ON	1μs or less	
		ON→OFF	2μs or less	
	Input time constant setting	None, 4μs, 8μs, 16μs, 32μs (set in 2-input units)		
Common method	16 points/common (+ common)			
Counter	Number of counter channels	4 channels		
	Calculation range	32-bit with sign (-2147483648 to +2147483647)		
	Max. calculation speed ¹⁾	200kHz		
	Input modes	3 modes (direction control, individual input, phase input)		
Max. calculation speed ¹⁾	2.5μs			
Other	8 comparison outputs, multiplier function (1, 2, 4)			
Interrupt	Number of interrupt points ²⁾	None, 1/unit, 8/unit (set with mode setting switches)		
	Interrupt processing delays	160μs max. (when using FP2 CPU unit) 50μs max. (when using FP2SH CPU unit)		
Output specifications	Insulation method	Photocoupler insulation		
	Rated load voltage	5 to 24VDC		
	Rated load voltage range	4.75VDC to 26.4VDC		
	Max. load current	0.1A (A11 to A18, B11 to B14 pins), 0.8A (B15 to B18 pins)		
	Leakage current when off	1μA max.		
	Max. voltage drop when on	0.5V max.		
	Response time	OFF→ON	1μs max.	
		ON→OFF	1μs or less (NPN) 5μs or less (PNP)	
	Surge absorber	Zener diode		
	Common method	16 points/common		
External power supply	Voltage	20.4VDC to 26.4VDC		
	Current (when using 24VDC)	90mA or less (NPN) 200mA or less (PNP)		
Counter	Surge absorber	8 points (A11 to A18 pins)		
Pulse output	Channels		4CH (B11 to B18 pins)	
	Max. output frequency		100kHz	
	Output modes		2 modes (direction control, individual output)	
PWM output	Number of output points	-	4CH (B15 to B18 pins)	
	Max. load current		0.8A	
	Cycle ³⁾		1Hz to 30kHz	
	Duty ³⁾		0 to 100% (unit: 1%)	

Notes:

- 1) This value is effective when the input time constant (filter) setting was set to "No setting".
- 2) If interrupts are used at the 1/unit setting, the interrupt from the external input terminal B1 (X8) or the interrupt program from the comparison 0 (one of among INT16 to INT23) is booted.
- 3) At maximum load current and resistance load. There may be distortion in the output waveform, depending on the load current and type of load.



FP2/FP2SH

Product Types

■ CPU units (Built-in RAM)

Product name		Operation speed	Built-in RAM	Optional memory			Other		Product number
				Expansion RAM	ROM	IC memory card	Clock/calendar	Comment memory	
FP2	Standard type CPU unit	From 0.35μs	16k steps ^{note 1)}	Available (See below.)	Available (See below.)	Not available	Available ^{note 2)}	Available ^{note 3)}	FP2-C1
	CPU unit 64-point input								FP2-C1D
	CPU unit with S-LINK								FP2-C1SL
FPSH	Standard type CPU unit	From 0.03μs	60k steps	Not available	Available (See below.)	Not available	Available (Built-in)	Available (Built-in)	FP2-C2
	CPU unit with IC memory card interface		60k steps	Not available	Available (Built-in)	Available (See below.)	Available (Built-in)	Available (Built-in)	FP2-C2P
	CPU unit with IC memory card interface		120k steps	Not available	Available (Built-in)	Available (See below.)	Available (Built-in)	Available (Built-in)	FP2-C3P

Notes: 1) For FP2 CPU unit, the capacity can be expanded up to 32k steps using the expansion RAM of the optional memory.
 2) The expansion memory unit (optional memory) with clock/calendar function is required for FP2 CPU unit.
 3) The expansion memory unit (optional memory) with comment input function is required for FP2 CPU unit.

■ Optional memories for FP2

Product name		Function				Product number
		Comment input	Clock/calendar	Expansion RAM	ROM socket	
For FP2	Expansion memory unit	Available	Available	Not available	Not available	FP2-EM1
		Available	Available	Available	Not available	FP2-EM2
		Available	Available	Available	Available	FP2-EM3
		Not available	Not available	Available	Available	FP2-EM6
		Not available	Not available	Not available	Available	FP2-EM7
	F-ROM	FLASH-ROM for program copy and ROM operation. Equivalent to SST-29EE010-120-4C-PH. Enables writing with the programming tool when attached to the CPU unit.				FP2-EM4
	EP-ROM	EP-ROM for program storage and ROM operation. Equivalent to M27C1001-12F1. A commercially available ROM writer is required.				FP2-EM5

■ Optional memories for FP2SH

Product name		Specification	Product number
ROM for FP2SH FP2-C2	Expansion memory unit	Socket for fitting ROM to the CPU unit	FP2-EM7
	F-ROM	FLASH-ROM for program copy and ROM operation. Equivalent to SST-29EE020-150-4C-PH. Enables writing with the programming tool when attached to the CPU unit.	AFP5208
	EP-ROM	EP-ROM for program storage and ROM operation. Equivalent to M27C2001-150F1. A commercially available ROM writer is required.	AFP5209
IC memory card (Small PC card) for FP2SH CPU unit with IC memory card interface	F-ROM	Backup unnecessary. Perfect for program memory. Used for readout when using data memory.	AIC50020
	SRAM	Perfect for data memory. Can also be used for program backup. Battery backups.	AIC52000

Note: Please refer to "FPΣ (Sigma) Product Types" for FP Memory Loader.

■ Backplanes

Product name		Specification	Product number
FP2 Backplane	Conventional type	5-module type (for basic)	FP2-BP05
		7-module type (for basic and expansion)	FP2-BP07
		9-module type (for basic and expansion)	FP2-BP09
		12-module type (for basic and expansion)	FP2-BP12
		14-module type (for basic and expansion)	FP2-BP14
	H type	8 slots (for basic)	FP2-BP11MH
FP2 Expansion cable		8 slots (for expansion)	FP2-BP10EH
		0.6m	FP2-EC
		2m	FP2-EC2

■ Power supply units

Product name	Specification	Product number
FP2 Power supply unit	Input: 100 to 120VAC, Output: 2.5A	FP2-PSA1
	Input: 200 to 240VAC, Output: 2.5A	FP2-PSA2
	Input: 100 to 240VAC, Output: 5A	FP2-PSA3
	Input: 24VAC, Output: 5A	FP2-PSD2



FP2/FP2SH

Product Types

I/O units

Product name	Type	Number of point	Connection method	Specification	Product number
FP2 Input unit	DC input	16	Terminal	12 to 24VDC	FP2-X16D2
		32	Connector	24VDC	FP2-X32D2
		64	Connector	24VDC	FP2-X64D2
FP2 Output unit	Relay output	6	Terminal	5A, 2 points per one common	FP2-Y6R
		16	Terminal	2A, 8 points per one common	FP2-Y16R
		16	Terminal	0.5A (12 to 24VDC), 0.1A (5VDC)	FP2-Y16T
	Transistor output NPN	32	Connector	0.1A (12 to 24VDC), 50mA (5VDC)	FP2-Y32T
		64	Connector	0.1A (12 to 24VDC), 50mA (5VDC)	FP2-Y64T
		16	Terminal	0.5A (12 to 24VDC), 0.1mA (5VDC)	FP2-Y16P
	Transistor output PNP	32	Connector	0.1A (12 to 24VDC), 50mA (5VDC)	FP2-Y32P
		64	Connector	0.1A (12 to 24VDC), 50mA (5VDC)	FP2-Y64P
		FP2 I/O mixed unit	DC input, Transistor output NPN	Input 32	Connector
Output 32	Input 24VDC, Output 0.1A (12 to 24 VDC), 50mA (5VDC) with on pulse catch input			FP2-XY64D7T	
DC input, Transistor output PNP	Input 32		Connector	Input 24VDC, Output 0.1A (12 to 24VDC), 50mA (5VDC)	FP2-XY64D2P
	Output 32	Input 24VDC, Output 0.1A (12 to 24 VDC), 50mA (5VDC) with on pulse catch input		FP2-XY64D7P	

Note: Pressure welding socket is supplied. A special tool (part number AXY52000) is needed for connection. Please purchase separately if you are using a terminal or flat cable socket.

Maintenance parts

Product name	Specification	Product number
Battery	For FP2, button type battery, CR2450 or equivalent	AFC8801
	For FP2SH CPU unit, battery with cable	AFP8801
Dummy unit	For blank slot	FP2-DM

Intelligent units for remote I/O control

Product name	Specification	Controllable I/O points	Product number
FP2 Multi-wire link unit	Can connect as the remote I/O system MEWNET-F master station Perfect for remote I/O systems using many points	Max. 2048 points per one unit	FP2-MW
FP2 CPU unit with S-LINK	Direct connection to SUNX Co., Ltd., S-LINK reduced-wiring system CPU unit with 128 points x 2 channels	256 points at S-LINK section	FP2-C1SL
FP2 S-LINK unit	Direct connection to SUNX Co., Ltd., S-LINK reduced-wiring system CPU unit with 128 points x 2 channels	128 points per one unit	FP2-SL2

Intelligent units for analog I/O

Product name	Specification	Number of I/O points	Product number	
FP2 Analog input unit	FP2-AD8VI	Not insulated Voltage: 1 to 5V, -10 to +10V Current: 4 to 20mA, -20 to +20mA	Analog input: 8 channels	FP2-AD8VI
	FP2-AD8X	Insulated Voltages, currents, thermocouples, resistance thermometer devices	Analog input: 8 channels	FP2-AD8X
	FP2-RTD	R.T.D. type: Pt 100, JPt 100, JPt 1000 type	R.T.D. input: 8 channels	FP2-RTD
FP2 Analog output unit	Voltage range: -10 to +10V Current range: 0 to 20mA Resolution: 1/4096	Analog input: 4 channels	FP2-DA4	

Positioning unit, high-speed counter unit and pulse I/O units

Product name	Specification			Product number
	Output type	Number of axes controlled	Speed command	
FP2 Positioning unit RTEX		2		FP2-PN2AN
		4		FP2-PN4AN
		8		FP2-PN8AN
Control Configurator PM		Tool software for positioning unit RTEX (English)		AFPS66510
FP2 Positioning unit Multifunction type ³⁾	Transistor	2, independent	1pps to 500kpps	FP2-PP21
		4, independent		FP2-PP41
	Line drive	2, independent	1pps to 4Mpps	FP2-PP22
		4, independent		FP2-PP42
FP2 High-speed counter unit	8 interrupt inputs 4-channel high-speed counter Input: 24VDC Output: 5 to 24VDC (0.1A, 12 points/0.8A, 4 points)		NPN output	FP2-HSCT
			PNP output	FP2-HSCP
FP2 Pulse I/O unit	8 interrupt inputs 4-channel high-speed counter 4 pulse output channels 4 PWM output channels Input: 24VDC Output: 5 to 24VDC (0.1A, 12 points/0.8A, 4 points)		NPN output	FP2-PXYT
			PNP output	FP2-PXYP

Notes: 1) Pressure welding socket is supplied. A special tool (part no. AXY52000) is needed for connection. Please purchase separately if you are using a terminal or flat cable socket.

2) Please refer to "FPΣ (Sigma) Product Types" for Motor driver I/F terminal II.

3) Previous FP2 positioning units FP2-PP2 and FP2-PP4 are not compatible with the multi-function type FP2 positioning unit.



FP2/FP2SH

Product Types

Serial communication and link-related intelligent units

Product name	Specification	Number of channels	Product number
FP2 ET-LAN unit	Ethernet-compatible unit for FP2/FP2SH To be mounted on the CPU backplane	1ch	FP2-ET1
Control Configurator ET	ET-LAN unit setting software (English)	-	AFPS32510
FP2 Multi-wire link unit	For PLC links Compatible with MEWNET-W/MEWNET-W2	1ch	FP2-MW
FP2 Multi-communication unit	Up to two blocks to be attached can be selected among RS485, RS232C, and RS422 blocks. General-purpose serial communications, computer links, PLC links (MEWNET-W0)	2ch	FP2-MCU
RS232C block	(For the multi-communication unit) 230kbps, 15m max.	1ch	FP2-CB232
RS422 block	(For the multi-communication unit) 230kbps, 1200m max.	1ch	FP2-CB422
RS485 block	(For the multi-communication unit) For PLC links (MEWNET-W0): 115kbps, 16 stations, 1,200m	1ch	FP2-CB485
FP2 Computer communication unit	For 1:1 communication between a PLC and a computer RS232C x 2 ch Connection with a control panel is also possible	2ch	FP2-CCU
FP2 Serial data unit	For communications with general-purpose RS232C devices The serial input/output is executed by sequence commands	2ch	FP2-SDU
FP2 FNS unit	Flexible Network Slave unit for FP2/FP2SH	1ch	FP2-FNS
PROFIBUS Plug-In Module	Plug-In network block for PROFIBUS	1ch	AFPN-AB6200
DeviceNet Plug-In Module	Plug-In network block for DeviceNet	1ch	AFPN-AB6201
CANopen Plug-In Module	Plug-In network block for CANopen	1ch	AFPN-AB6218

FPWIN Pro PLC programming software according to IEC 61131-3

Product name	Type	Product number	Applicable PLC			
			FP-X	FPΣ	FP0 FP-e	FP2 / FP2SH
FPWIN Pro for Windows	Full version with English manual	FPWINPROFEN5	A	A	A	A
	Full version with German manual	FPWINPROFDE5	A	A	A	A
	Full version with French manual	FPWINPROFFR5	A	A	A	A
	Small version with English manual	FPWINPROSEN5	A	A	A	N/A
	Small version with German manual	FPWINPROSDE5	A	A	A	N/A
	Small version with French manual	FPWINPROSFR5	A	A	A	N/A

A: Available, N/A: Not available

Other software tools

Product name	Description	Product number
FP OPC Server	Standardized connectivity to FP Series PLCs (software with one license)	AFPS03510D
FP OPC Server license	Additional license for FP OPC Server	AFPS03517D
FP Data Analyzer	Software tool to read and display PLC data	AFPS04510D
PCWAY	Data monitoring, logging and setting software based on Excel	AFW10031
CommX	OCX for communication, Internal data can be displayed and operated on Visual Basic	AFW20031



FP2/FP2SH

Dimensions

in mm

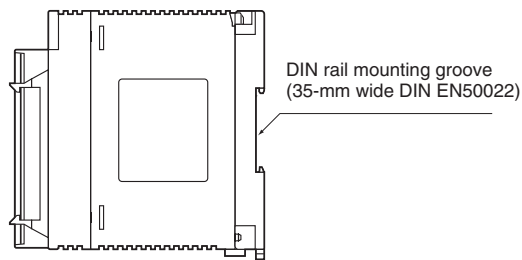
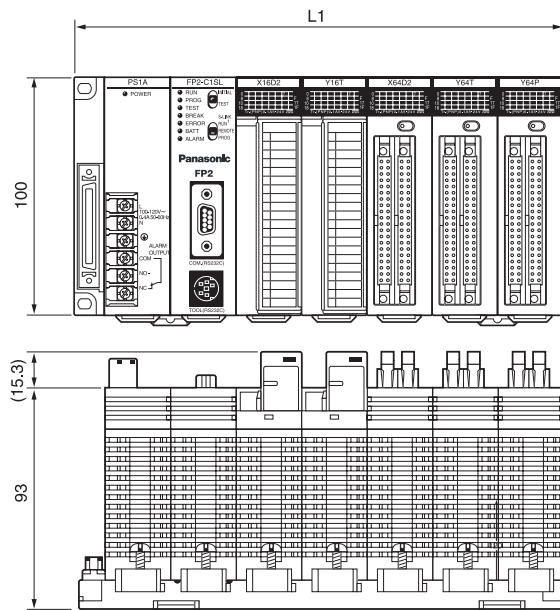

Mounting dimension (Tolerance: 1.0)

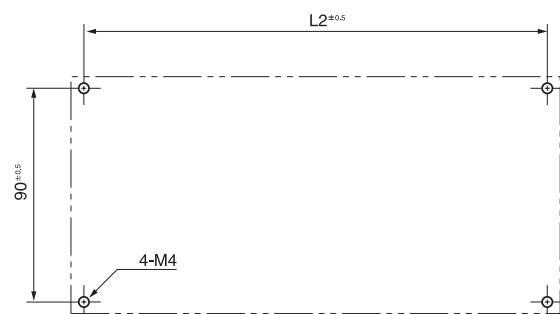

* The illustration shows a conventional 7-module type backplane.

Conventional backplanes					
	5-module	7-module	9-module	12-module	14-module
L1 (mm)	140	209	265	349	405
L2 (mm)	130	199	255	339	395

H type backplane		
	11-module (master backplane)	10-module (expansion backplane)
L1 (mm)	349	349
L2 (mm)	339	339

North America

Europe

Asia Pacific

China

Japan

Panasonic Electric Works

Please contact our Global Sales Companies in:

Europe

▶ Headquarters	Panasonic Electric Works Europe AG	Rudolf-Diesel-Ring 2, 83607 Holzkirchen, Tel. (08024) 648-0, Fax (08024) 648-111, www.panasonic-electric-works.com
▶ Austria	Panasonic Electric Works Austria GmbH PEW Electronic Materials Europe GmbH	Rep. of PEWDE, Josef Madersperger Str. 2, 2362 Biedermansdorf, Tel. (02236) 26846, Fax (02236) 46133, www.panasonic-electric-works.at Ennshafenstraße 9, 4470 Enns, Tel. (07223) 883, Fax (07223) 88333, www.panasonic-electronic-materials.com
▶ Benelux	Panasonic Electric Works Sales Western Europe B.V.	De Rijn 4, (Postbus 211), 5684 PJ Best, (5680 AE Best), Netherlands, Tel. (0499) 372727, Fax (0499) 372185, www.panasonic-electric-works.nl
▶ Czech Republic	Panasonic Electric Works Czech s.r.o.	Průmyslová 1, 34815 Planá, Tel. 374 799 990, Fax 374 799 999, www.panasonic-electric-works.cz
▶ France	Panasonic Electric Works Sales Western Europe B.V.	Succursale Française, 10, rue des petits ruisseaux, 91370 Verrières le Buisson, Tél. 01 60135757, Fax 01 60135758, www.panasonic-electric-works.fr
▶ Germany	Panasonic Electric Works Deutschland GmbH	Rudolf-Diesel-Ring 2, 83607 Holzkirchen, Tel. (08024) 648-0, Fax (08024) 648-555, www.panasonic-electric-works.de
▶ Hungary	Panasonic Electric Works Europe AG	Magyarországi Közvetlen Kereskedelmi Képviselete, 1117 Budapest, Neumann János u. 1., Tel. 06 1 482 9258, Fax 06 1 482 9259, www.panasonic-electric-works.hu
▶ Ireland	Panasonic Electric Works UK Ltd.	Dublin, Tel. (01) 4600969, Fax (01) 4601131, www.panasonic-electric-works.co.uk
▶ Italy	Panasonic Electric Works Italia s.r.l. Panasonic Electric Works Italia s.r.l.	Via del Commercio 3-5 (Z.I. Ferlina), 37012 Bussolengo (VR), Tel. (045) 6752711, Fax (045) 6700444, www.panasonic-electric-works.it
▶ Nordic Countries	Panasonic Electric Works Nordic AB PEW Fire & Security Technology Europe AB	Building Materials Division, Piazza della Repubblica 24, 20154 Milano (MI), Tel. (02) 29005391, Fax (02) 29003466 Sjögångsvägen 10, 19272 Sollentuna, Sweden, Tel. (08) 59476680, Fax (08) 59476690, www.panasonic-electric-works.se Citadellsvägen 23, 21118 Malmö, Tel. (040) 6977000, Fax (040) 6977099, www.panasonic-fire-security.com
▶ Poland	Panasonic Electric Works Polska sp. z o.o.	Al. Krakowska 4/6, 02-284 Warszawa, Tel. 22 338-11-33, Fax 22 338-12-00, www.panasonic-electric-works.pl
▶ Portugal	Panasonic Electric Works España S.A.	Portuguese Branch Office, Avda Adelino Amaro da Costa 728 R/C J, 2750-277 Cascais, Tel. (21) 4812520, Fax (21) 4812529
▶ Spain	Panasonic Electric Works España S.A.	Barajas Park, San Severo 20, 28042 Madrid, Tel. (91) 3293875, Fax (91) 3292976, www.panasonic-electric-works.es
▶ Switzerland	Panasonic Electric Works Schweiz AG	Grundstrasse 8, 6343 Rotkreuz, Tel. (041) 7997050, Fax (041) 7997055, www.panasonic-electric-works.ch
▶ United Kingdom	Panasonic Electric Works UK Ltd.	Sunrise Parkway, Linford Wood, Milton Keynes, MK14 6 LF, Tel. (01908) 231555, Fax (01908) 231599, www.panasonic-electric-works.co.uk

North & South America

▶ USA	PEW Corporation of America	629 Central Avenue, New Providence, N.J. 07974, Tel. 1-908-464-3550, Fax 1-908-464-8513, www.pewa.panasonic.com
--------------	-----------------------------------	---

Asia Pacific / China / Japan

▶ China	Panasonic Electric Works (China) Co., Ltd.	Level 2, Tower W3, The Towers Oriental Plaza, No. 2, East Chang An Ave., Dong Cheng District, Beijing 100738, Tel. (010) 8518-5988, Fax (010) 8518-1297
▶ Hong Kong	Panasonic Electric Works (Hong Kong) Co., Ltd.	RM1205-9, 12/F, Tower 2, The Gateway, 25 Canton Road, Tsimshatsui, Kowloon, Hong Kong, Tel. (0852) 2956-3118, Fax (0852) 2956-0398
▶ Japan	Matsushita Electric Works, Ltd.	1048 Kadoma, Kadoma-shi, Osaka 571-8686, Japan, Tel. (06) 6908-1050, Fax (06) 6908-5781, www.mew.co.jp/e-acg/
▶ Singapore	Panasonic Electric Works Asia Pacific Pte. Ltd.	101 Thomson Road, #25-03/05, United Square, Singapore 307591, Tel. (06255) 5473, Fax (06253) 5689

Panasonic[®]

08/2007

Copyright © 2007 • Printed in Germany
4193 euen 08/07

Free Manuals Download Website

<http://myh66.com>

<http://usermanuals.us>

<http://www.somanuals.com>

<http://www.4manuals.cc>

<http://www.manual-lib.com>

<http://www.404manual.com>

<http://www.luxmanual.com>

<http://aubethermostatmanual.com>

Golf course search by state

<http://golfingnear.com>

Email search by domain

<http://emailbydomain.com>

Auto manuals search

<http://auto.somanuals.com>

TV manuals search

<http://tv.somanuals.com>