



ACCULINK 317x E1 DATA SERVICE UNIT/ CHANNEL SERVICE UNIT OPERATOR'S GUIDE

Document No. 3170-A2-GB20-20

December 1996



ACCULINK 317x E1 Data Service Unit/Channel Service Unit

Operator's Guide
3170-A2-GB20-20

3rd Edition (December 1996)

Changes and enhancements to the product and to the information herein will be documented and issued as a new release.

Warranty, Sales, and Service Information

Contact your sales or service representative directly for any help needed. For additional information concerning warranty, sales, service, repair, installation, documentation, or training, use one of the following methods:

- **Via the Internet:** Visit the Paradyne World Wide Web site at <http://www.paradyne.com>
- **Via Telephone:** Call our automated call system to receive current information via fax or to speak with a company representative.
 - Within the U.S.A., call 1-800-870-2221
 - International, call 727-530-2340

Trademarks

All products and services mentioned herein are the trademarks, service marks, registered trademarks or registered service marks of their respective owners.



Printed on recycled paper

COPYRIGHT © 1996 Paradyne Corporation. All rights reserved.

This publication is protected by federal copyright law. No part of this publication may be copied or distributed, transmitted, transcribed, stored in a retrieval system, or translated into any human or computer language in any form or by any means, electronic, mechanical, magnetic, manual or otherwise, or disclosed to third parties without the express written permission of Paradyne Corporation, 8545 126th Avenue North, P.O. Box 2826, Largo, Florida 33779-2826.

Paradyne Corporation makes no representation or warranties with respect to the contents hereof and specifically disclaims any implied warranties of merchantability or fitness for a particular purpose. Further, Paradyne Corporation reserves the right to revise this publication and to make changes from time to time in the contents hereof without obligation of Paradyne Corporation to notify any person of such revision or changes.

Important Safety Instructions

1. Read and follow all warning notices and instructions marked on the product or included in the manual.
2. When an ac power source is used, this product is intended to be used with a three-wire grounding type plug – a plug which has a grounding pin. This is a safety feature. Equipment grounding is vital to ensure safe operation. Do not defeat the purpose of the grounding type plug by modifying the plug or using an adapter.

Prior to installation, use an outlet tester or a voltmeter to check the ac receptacle for the presence of earth ground. If the receptacle is not properly grounded, the installation must not continue until a qualified electrician has corrected the problem.

If a three-wire grounding type power source is not available, consult a qualified electrician to determine another method of grounding the equipment.

3. Slots and openings in the cabinet are provided for ventilation. To ensure reliable operation of the product and to protect it from overheating, these slots and openings must not be blocked or covered.
4. Do not allow anything to rest on the power cord and do not locate the product where persons will walk on the power cord.
5. Do not attempt to service this product yourself, as opening or removing covers may expose you to dangerous high voltage points or other risks. Refer all servicing to qualified service personnel.
6. General purpose cables may be provided with this product. Special cables, which may be required by the regulatory inspection authority for the installation site, are the responsibility of the customer.
7. When installed in the final configuration, the product must comply with the applicable Safety Standards and regulatory requirements of the country in which it is installed. If necessary, consult with the appropriate regulatory agencies and inspection authorities to ensure compliance.
8. A rare phenomenon can create a voltage potential between the earth grounds of two or more buildings. If products installed in separate buildings are **interconnected**, the voltage potential may cause a hazardous condition. Consult a qualified electrical consultant to determine whether or not this phenomenon exists and, if necessary, implement corrective action prior to interconnecting the products.
9. Input power to the ac voltage configuration of this product must be provided by one of the following: (1) a UL Listed/CSA certified power source with a Class 2 or Limited Power Source (LPS) output for use in North America, or (2) a certified power source with a Safety Extra Low Voltage (SELV) output for use in the country of installation.

Input power to the dc voltage configurations of this product must be provided by one of the following: (1) a National Electric Code (NEC)/Canadian Electric Code (CEC) Class 2 circuit for use in North America, or (2) a certified Safety Extra Low Voltage (SELV) circuit input for use in the country of installation.

In addition, if the equipment is to be used with telecommunications circuits, take the following precautions:

- Never install telephone wiring during a lightning storm.
- Never install telephone jacks in wet locations unless the jack is specifically designed for wet locations.
- Never touch uninsulated telephone wires or terminals unless the telephone line has been disconnected at the network interface.
- Use caution when installing or modifying telephone lines.
- Avoid using a telephone (other than a cordless type) during an electrical storm. There may be a remote risk of electric shock from lightning.
- Do not use the telephone to report a gas leak in the vicinity of the leak.

Notices

WARNING

THIS EQUIPMENT HAS BEEN TESTED AND FOUND TO COMPLY WITH THE LIMITS FOR A CLASS A DIGITAL DEVICE, PURSUANT TO PART 15 OF THE FCC RULES. THESE LIMITS ARE DESIGNED TO PROVIDE REASONABLE PROTECTION AGAINST HARMFUL INTERFERENCE WHEN THE EQUIPMENT IS OPERATED IN A COMMERCIAL ENVIRONMENT. THIS EQUIPMENT GENERATES, USES, AND CAN RADIATE RADIO FREQUENCY ENERGY AND, IF NOT INSTALLED AND USED IN ACCORDANCE WITH THE INSTRUCTION MANUAL, MAY CAUSE HARMFUL INTERFERENCE TO RADIO COMMUNICATIONS. OPERATION OF THIS EQUIPMENT IN A RESIDENTIAL AREA IS LIKELY TO CAUSE HARMFUL INTERFERENCE IN WHICH CASE THE USER WILL BE REQUIRED TO CORRECT THE INTERFERENCE AT HIS OWN EXPENSE.

THE AUTHORITY TO OPERATE THIS EQUIPMENT IS CONDITIONED BY THE REQUIREMENTS THAT NO MODIFICATIONS WILL BE MADE TO THE EQUIPMENT UNLESS THE CHANGES OR MODIFICATIONS ARE EXPRESSLY APPROVED BY PARADYNE.

WARNING

TO USERS OF DIGITAL APPARATUS IN CANADA:

THIS CLASS A DIGITAL APPARATUS MEETS ALL REQUIREMENTS OF THE CANADIAN INTERFERENCE-CAUSING EQUIPMENT REGULATIONS.

CET APPAREIL NUMÉRIQUE DE LA CLASSE A RESPECTE TOUTES LES EXIGENCES DU RÉGLEMENT SUR LE MATÉRIEL BROUILLEUR DU CANADA.

CE Marking

Models 3172-A1-410 and 3174-A1-410 Only

Models 3172-A1-410 and 3174-A1-410 of this product are marked with the CE mark. This mark has been affixed to demonstrate full compliance with the following European Directives:

- Directive 73/23/EEC – Council Directive of 19 February 1973 on the harmonization of the laws of the member states relating to electrical equipment designed for use within certain voltage limits, as amended by Directive 93/68/EEC.
- Directive 89/336/EEC – Council Directive of 3 May 1989 on the approximation of the laws of the member states relating to Electro-Magnetic Compatibility (EMC), as amended by Directive 93/68/EEC.
- Directive 91/263/EEC – Council Directive of 29 April 1991 on the approximation of the laws of the member states concerning telecommunication terminal equipment, including the mutual recognition of their conformity, as amended by Directive 93/68/EEC. The application of this directive is in relation only to network connection via the 120 ohm G.703 interface as specified in CTR12.

Table of Contents

Preface

Objectives and Reader Assumptions	iii
Related Documents	iii
Reference Documents	iii

1. Introduction

Overview	1-1
Features	1-1
Physical Description	1-3

2. Installation

Overview	2-1
Application Examples	2-1
SNMP Connection Examples	2-3
Important Instructions	2-5
Optional Power Sources	2-5
Cabling Examples	2-8
Power-Up Self-Test	2-9

3. Operation

Overview	3-2
Using the Front Panel	3-2
Displaying Unit Identity	3-8
Displaying LED Conditions	3-10
Selecting the DTE Drop/Insert or Data Port for LED Display	3-11
Changing Configuration Options	3-11
Configuring the E1 DSU/CSU for SNMP Management	3-14
Configuring SNMP Traps	3-18
Configuring DS0 Channels	3-20
Providing Backup Capability	3-32
Selecting the Timing Source	3-33
Acquiring/Releasing the User Interface	3-35
Resetting the E1 DSU/CSU	3-36
Download Operations	3-36

4. Maintenance

Overview	4-2
Self-Test Health	4-2
Device Health and Status	4-3
Network Performance Reports	4-5
Alarms	4-9
SNMP Traps	4-10
Troubleshooting	4-11
Test Jacks	4-13
Test Commands	4-14
Remote Loopback Tests	4-14
Local Loopback Tests	4-15
Test Patterns	4-20
Lamp Test	4-23
Displaying E1 DSU/CSU Test Status	4-24

Appendices

A. Front Panel Menu	A-1
B. Technical Specifications	B-1
C. Configuration Options	C-1
D. Pin Assignments	D-1
E. SNMP MIB Objects	E-1
F. IP Network Addressing Scenario	F-1
G. Front Panel Emulation	G-1
H. Equipment List	H-1

Glossary

Index

Preface

Objectives and Reader Assumptions

This operator's guide contains installation, operation, and maintenance information for the ACCULINK 317x E1 Data Service Unit (DSU)/Channel Service Unit (CSU).

It is assumed that you are familiar with the operation of digital data communication equipment and DSUs and CSUs in particular. You should also be familiar with Simple Network Management Protocol (SNMP) if you want your E1 DSU/CSU to be managed by an SNMP manager.

Related Document

7800-A2-GB20 *ACCULINK 3100 Series Open Management Application for HP OpenView User's Guide*

Reference Documents

- CSA-22.2 No. 950-M89
- CSA 108-M1983
- FCC Part 15
- UL 1950
- *Management Information Base for Network Management of TCP/IP-Based Internets: MIBII.* RFC 1213, March 1991
- *Definitions of Managed Objects for the DS1 and E1 Interface Types.* RFC 1406, January 1993
- *Definitions of Managed Objects for RS-232-like Hardware Devices.* RFC 1317, April 1992
- *Extensions to the Generic-Interface MIB.* RFC 1229, May 1991

Introduction 1

Overview	1-1
Features	1-1
DTE Drop/Insert Interface	1-2
Alarm Message Capability	1-2
Front Panel Emulation	1-2
SNMP Management Support	1-2
Physical Description	1-3
Front Panel	1-3
Rear Panel	1-3

Overview

The E1 DSU/CSU acts as an interface between the E1 digital network (as specified in CCITT standards G.703 and G.704) and the customer premises equipment, converting signals received from the DTE (Data Terminal Equipment) to signals that can be transmitted over E1 lines. Typical applications include Local Area Network (LAN)/Wide Area Network (WAN) interconnection, shared access to network-based services, and fractional E1 network applications.

The E1 DSU/CSU series of products consists of a Model 3172 DSU/CSU (2-port) and a Model 3174 DSU/CSU (4-port). Differences between these models are discussed where applicable throughout this guide.

Features

The E1 DSU/CSU optimizes network performance with a wide range of features such as the following:

- Software configuration menu displayed via a liquid crystal display (LCD) to permit quick and easy operation and elimination of complicated hardware strapping.
- Local or remote configuration and operation flexibility.
- Several loopback capabilities and test pattern generators.
- DTE drop/insert capability.
- Alarm message display/print capability.
- Front panel emulation via Windows-based Front Panel Emulation software.
- Network management provided through industry-standard Simple Network Management Protocol (SNMP).

DTE Drop/Insert Interface

The DTE Drop/Insert interface is compatible with the signal format of CCITT Recommendation G.703 and the frame structure of CCITT Recommendation G.704. This interface allows DTEs/PBXs to share the E1 network with other high-speed equipment.

Alarm Message Capability

The E1 DSU/CSU can be attached, either locally or remotely, to an ASCII terminal or printer to display or print alarm messages. The communications (COM) port can be used as the destination for Alarm Set and Alarm Clear messages. This enables an ASCII terminal or printer to monitor the E1 DSU/CSU for alarm conditions. Alarms can also be displayed on a PC that is using a terminal emulation package.

Front Panel Emulation

The E1 DSU/CSU offers functionality through Front Panel Emulation software that is similar to that provided by the E1 DSU/CSU front panel. The E1 DSU/CSU can either be locally or remotely attached to a 386 or higher personal computer (PC) that has at least four megabytes (MB) of random-access memory (RAM). (An external modem is required for remote attachment.) A copy of the E1 DSU/CSU front panel appears on the PC. The functionality of the front panel is available by clicking on the function keys with the mouse rather than by pressing keys from the actual front panel. For more information, refer to Appendix G, *Front Panel Emulation*.

SNMP Management Support

SNMP is a network management protocol that is used to monitor network performance and status, and to report alarms (i.e., traps). To function, SNMP requires a manager consisting of a software program housed within a workstation or PC; an agent consisting of a software program housed within a device (e.g., the E1 DSU/CSU); and a Management Information Base (MIB) consisting of a database of managed objects.

Users of the external SNMP manager can issue “Get” and “Set” commands to an object in the SNMP database maintained by the E1 DSU/CSU.

The E1 DSU/CSU can be managed by any industry-standard SNMP manager. The company provides an SNMP application that runs on a Hewlett-Packard HP OpenView network management platform. For more information, refer to the *ACCULINK 3100 Series Open Management Application for HP OpenView User's Guide*.

The E1 DSU/CSU supports the following MIBs:

- MIB II – Defines the general objects for use in Transmission Control Protocol/Internet Protocol (TCP/IP) internets and provides general information about the E1 DSU/CSU. MIB II is backward-compatible with MIB I.
- DS1/E1 MIB – Defines objects for managing E1 interfaces and supports the network and DTE Drop/Insert interfaces on the E1 DSU/CSU.
- RS-232-like MIB – Defines objects for managing RS-232-type interfaces (e.g., RS-422, RS-423, etc.) and supports synchronous data ports (PORTs 1–4) and management communication ports (AUX and COM ports) on the E1 DSU/CSU.
- Generic-Interface Extension MIB – An extension to MIB II that defines additional objects for control of generic interfaces in MIB II. It supports control of tests on the E1 and synchronous data interfaces that are not supported by other MIBs.
- Enterprise MIB – Defines objects that are unique to Paradyne devices.

Two link layer protocols, Point-to-Point Protocol (PPP) and Serial Line Internet Protocol (SLIP), are supported for connection to an external SNMP manager or network device (e.g., a router).

The SNMP manager or network device can be directly connected to the communications (COM) port. An external LAN Adapter can be connected to either the COM port or the auxiliary (AUX) port to provide Ethernet connectivity. Also, the E1 DSU/CSU can be daisy chained together by connecting the COM port of one device to the AUX port of the other, providing SNMP connectivity.

The SNMP management system can communicate to the E1 DSU/CSU remotely through the Facility Data Link (FDL) or the synchronous data port's Embedded Data Link (EDL). FDL provides an in-band channel for performance and control signals on the network interface. It uses the spare bit S_{a4} in time-slot zero as defined in CCITT standard G.704. EDL provides the ability to detect and synchronize on a framing pattern, provides cyclic redundancy checking (CRC), and maintains near-end and far-end performance statistics.

Physical Description

The E1 DSU/CSU series of products consists of a Model 3172 DSU/CSU (2-port) and a Model 3174 DSU/CSU (4-port).

Front Panel

The E1 DSU/CSU front panel (Figure 1-1) contains,

- One 2-line, 16-alphanumeric-character-per-line liquid crystal display (LCD)
- One 7-button keypad (three Function and four directional keys)
- Twelve light-emitting diodes (LEDs)
- Six test jacks

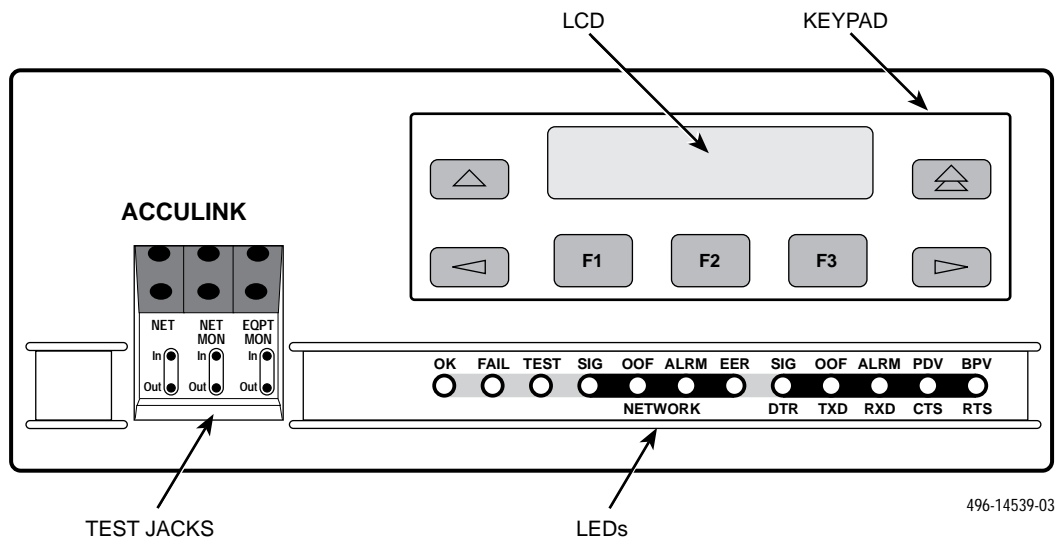
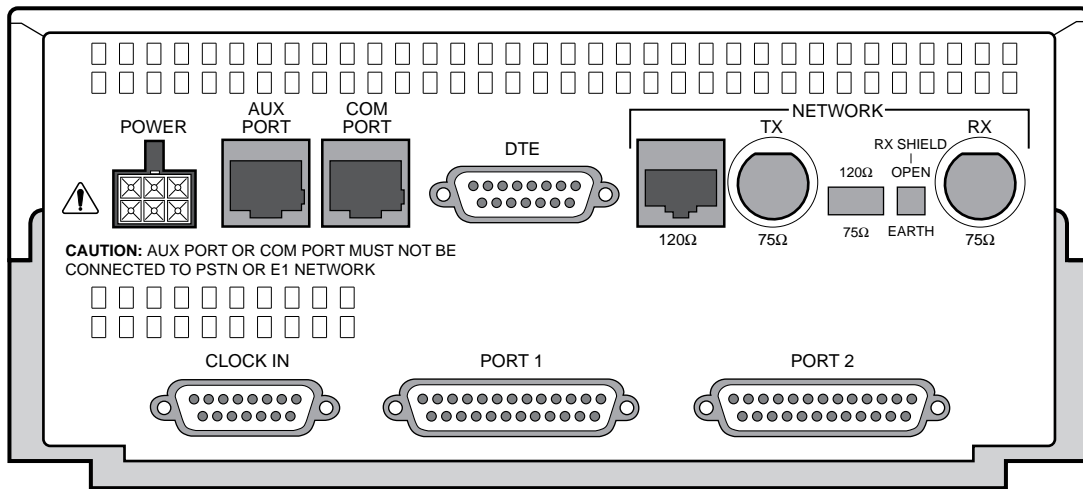

Figure 1-1. Front Panel

Rear Panel

The E1 DSU/CSU rear panel contains the connectors and switches required for the operation of the E1 DSU/CSU (Figures 1-2 and 1-3). The connectors and switches are described in Table 1-1.



495-14295-02

Figure 1-2. Model 3172 Rear Panel

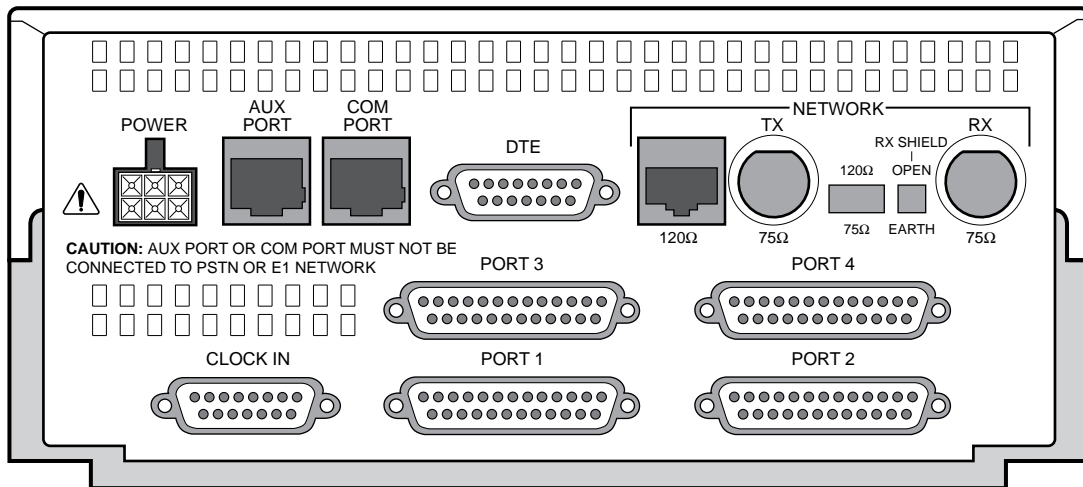

495-14294-02

Figure 1-3. Model 3174 Rear Panel

**Table 1-1
Rear Panel Connectors and Switches**

Name	Function
POWER	Supplies power to the E1 DSU/CSU by providing an attachment for the ac power module or the optional dc power cable (+24 or -48 Vdc).
AUX PORT	Supports SNMP LAN Adapter or daisy-chain connections.
COM PORT	Provides access to a locally connected PC, an ASCII terminal or printer, or an SNMP management link.
DTE	Provides access to the DTE Drop/Insert interface. This interface is compatible with the signal format of CCITT Recommendation G.703 and the frame structure of CCITT Recommendation G.704.
NETWORK—120Ω NETWORK—75Ω TX/RX NETWORK—120Ω/75Ω (switch) NETWORK—RX SHIELD (switch)	Provides an unkeyed modular jack for a 120 ohm balanced network interface. Provides two BNC connectors (Transmit and Receive) for a 75 ohm unbalanced network interface. Selects either a 120 ohm balanced network interface or a 75 ohm unbalanced network interface. Selects either an “open” or “earth” shield connection for the 75 ohm RX interface. (This switch must be set to “open” when using the 120 ohm interface.)
CLOCK IN	Used to attach an external clock to the E1 DSU/CSU.
PORTs 1– 4	Used to connect the customer’s synchronous data DTE to the E1 DSU/CSU.

Installation 2

Overview	2-1
Application Examples	2-1
SNMP Connection Examples	2-3
Important Instructions	2-5
Optional Power Sources	2-5
Installing the +24 Vdc Power Supply	2-5
Installing the Single -48 Vdc Power Supply	2-6
Installing the Redundant -48 Vdc Power Supply	2-7
Cabling Examples	2-8
Power-Up Self-Test	2-9

Overview

This chapter contains information for installing your E1 DSU/CSU. It includes application examples, cabling, and power-up information.

Application Examples

The E1 DSU/CSU is designed to provide an interface between the E1 digital network and the customer premises equipment. The E1 DSU/CSU is connected to the customer premises equipment through one of the synchronous data ports (PORTs 1-4) or the DTE

Drop/Insert port (DTE). It is connected to the network through the Network interface (NETWORK). The most common applications for the E1 DSU/CSU are:

- Point-to-Point LAN interconnection (Figure 2-1).
- Shared access to network-based services (Figure 2-2).
- Fractional E1 network applications (Figure 2-3).
- Wireless/DACS (Digital Access and Cross-connect System) applications (Figure 2-4).

Both voice and data applications are supported.

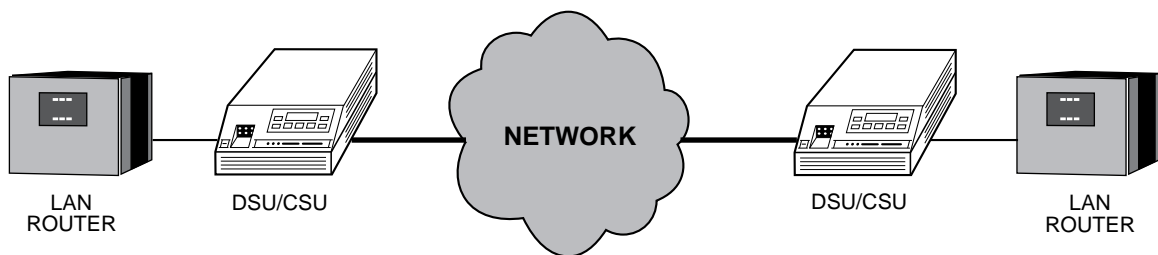

496-14296a-02

Figure 2-1. Point-to-Point Application Example

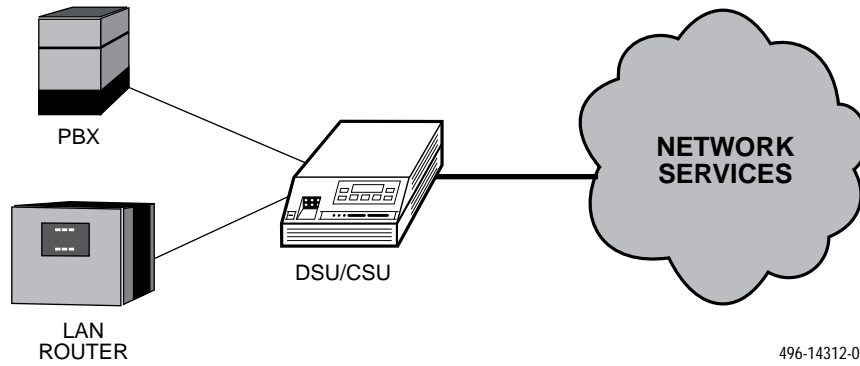

Figure 2-2. Shared Access Application Example

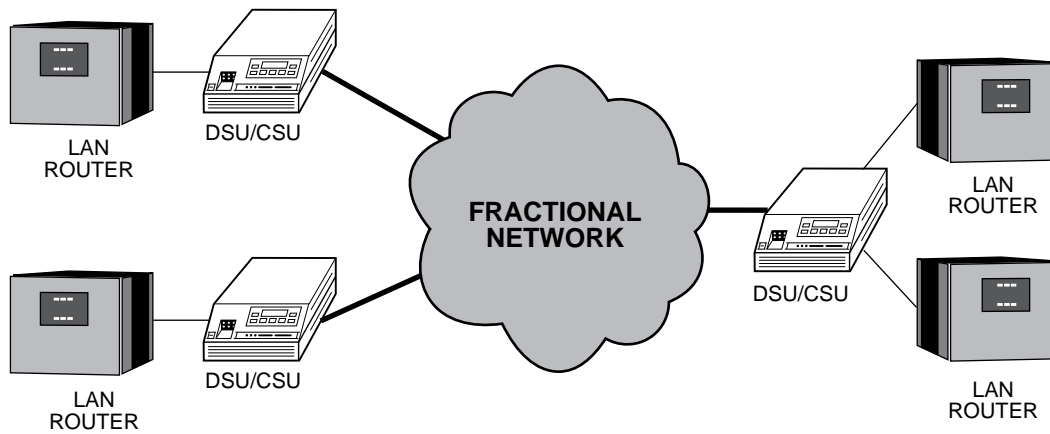

Figure 2-3. Fractional E1 Application Example

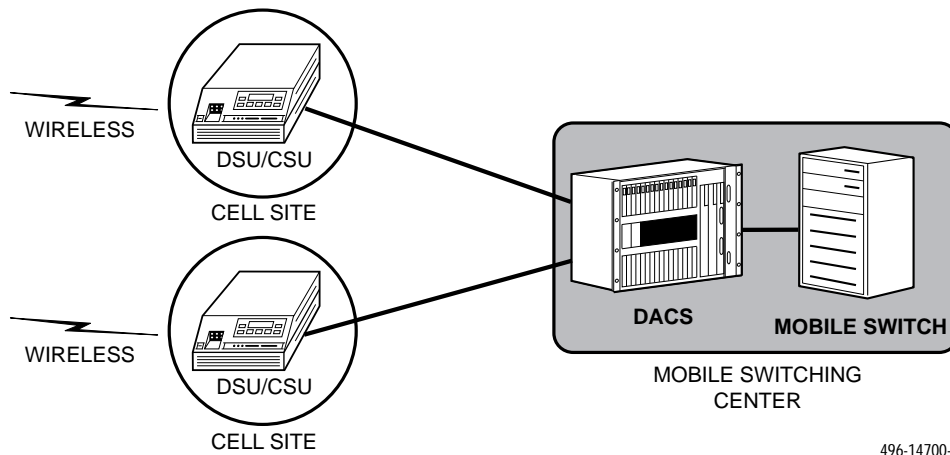

Figure 2-4. Wireless/DACS Application Example

SNMP Connection Examples

The E1 DSU/CSU can be connected to an SNMP management system in a number of ways. Some examples include:

- Directly connecting the COM port to the SNMP manager (Figure 2-5).
- Connecting the COM port to a network device (e.g., a router) for SNMP management (Figure 2-6).
- Connecting the COM port or the AUX port to an external LAN Adapter for Ethernet SNMP connectivity (Figure 2-7).
- Daisy chaining the COM port of one device to the AUX port of the other to provide SNMP connectivity (Figure 2-8).
- Remotely managing the E1 DSU/CSU through the Facility Data Link (FDL) or the synchronous data port's Embedded Data Link (EDL) (Figure 2-9).

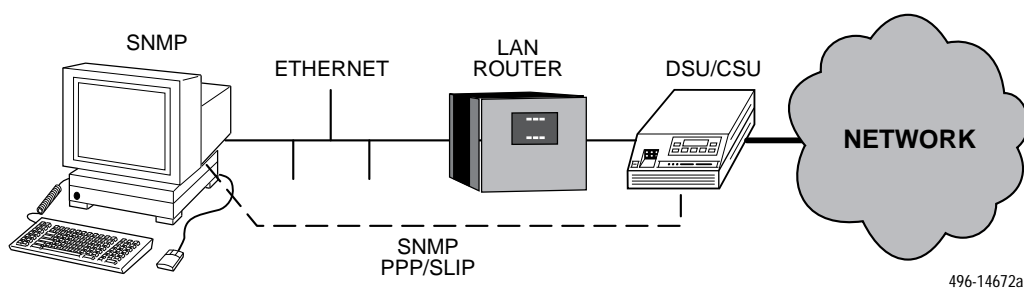

Figure 2-5. Direct Connection to an SNMP Manager

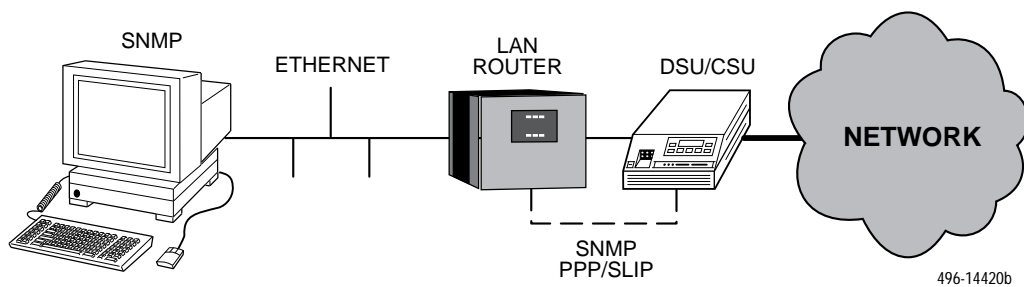
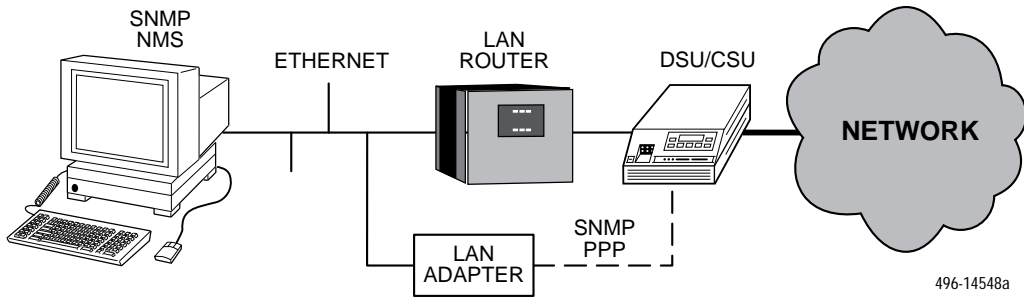
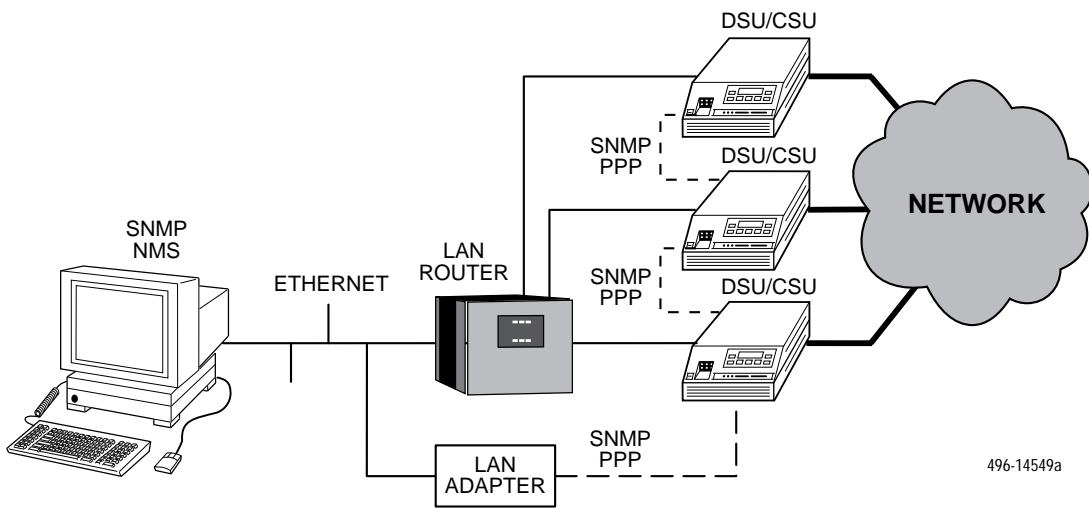

Figure 2-6. Connection through a Router to SNMP



496-14548a

Figure 2-7. Connection through a LAN Adapter to SNMP



496-14549a

Figure 2-8. LAN Adapter and Daisy Chaining for SNMP Support

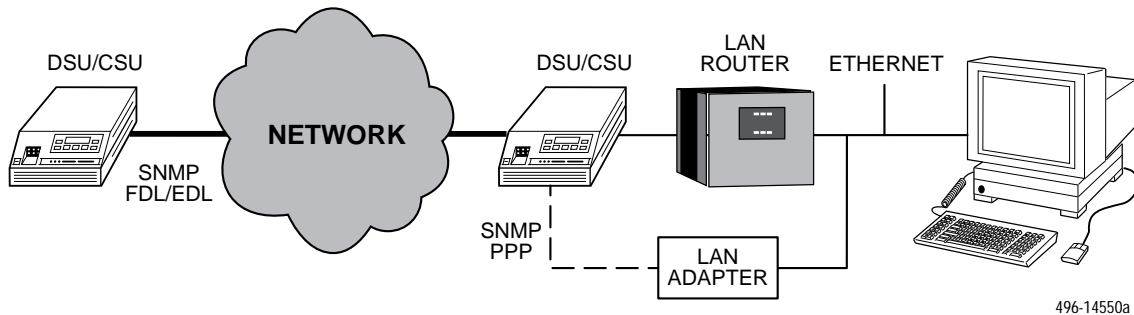

496-14550a

Figure 2-9. Remote SNMP Management through FDL/EDL

Important Instructions

Read and follow all warning notices and instructions marked on the E1 DSU/CSU or included in this guide.

CAUTION

Disconnect the power cable before connecting or removing any data cables at the rear of the unit.

HANDLING PRECAUTIONS FOR STATIC-SENSITIVE DEVICES

This product is designed to protect sensitive components from damage due to electrostatic discharge (ESD) during normal operation. When performing installation procedures, however, take proper static control precautions to prevent damage to equipment. If you are not sure of the proper static control precautions, contact your nearest sales or service representative.

Optional Power Sources

The E1 DSU/CSU is typically powered by the ac power module. Use the following procedures only if you want to use an optional dc power source.

Using the optional dc power cable, the E1 DSU/CSU is capable of operating on either a +24 Vdc power source, –48 Vdc single source battery, or –48 Vdc redundant source batteries (for power backup). To select the power, choose one of the following power supply types.

Installing the +24 Vdc Power Supply

To install the E1 DSU/CSU using a +24 Vdc power supply, refer to Figure 2-10 and use the following procedure.

To install the +24 Vdc power supply,

1. Connect the green wire to a suitable earth ground.
2. Connect the white wire to the +24 Vdc return.
3. Connect the orange wire to the +24 Vdc source.
4. Cut the black, red and blue wires off at the outer insulation.
5. Plug the power connector into the E1 DSU/CSU.

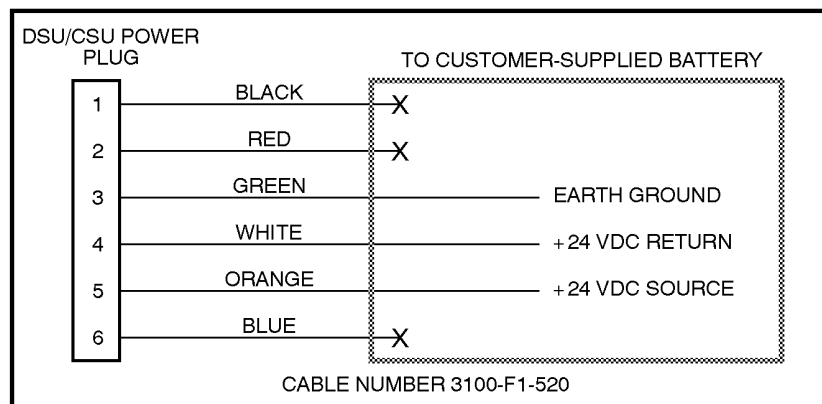

493-14298

Figure 2-10. +24 Vdc Power Supply Pinouts

Installing the Single –48 Vdc Power Supply

To install the E1 DSU/CSU using a single source –48 Vdc power supply, refer to Figure 2-11 and use the following procedure.

To install the –48 Vdc single source power supply,

1. Connect the black and red wires to the –48 Vdc return source.
2. Connect the green wire to a suitable earth ground.
3. Connect the orange and blue wires to the –48 Vdc input source.
4. Cut the white wire off at the outer insulation.
5. Plug the power connector into the E1 DSU/CSU.

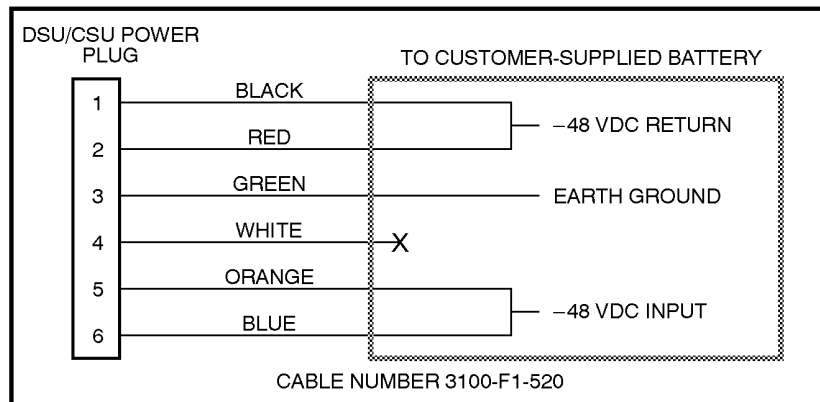

493-14299

Figure 2-11. –48 Vdc Single Source Power Supply Pinouts

Installing the Redundant -48 Vdc Power Supply

To install the E1 DSU/CSU using a redundant -48 Vdc power supply, refer to Figure 2-12 and use the following procedure.

To install the redundant -48 Vdc power supply,

1. Connect the black wire to the -48 Vdc return source B.
2. Connect the red wire to the -48 Vdc return source A.
3. Connect the green wire to a suitable earth ground.
4. Connect the orange wire to the -48 Vdc input source B.
5. Connect the blue wire to the -48 Vdc input source A.
6. Cut the white wire off at the outer insulation.
7. Plug the power connector into the E1 DSU/CSU.

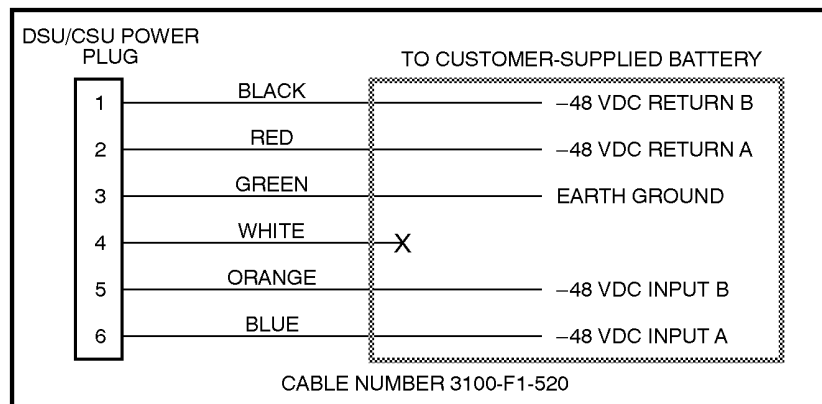

493-14300

Figure 2-12. -48 Vdc Redundant Source Power Supply Pinouts

Cabling Examples

The E1 DSU/CSU is supplied with an ac power module. You must provide the DTE and network cables.

Optional cables that you can order from the company are described in Appendix D, *Pin Assignments*.

Figure 2-13 illustrates some cabling examples.

NOTE

The 120Ω/75Ω switch selects either the 120 ohm balanced network interface or the 75 ohm unbalanced network interface. The RX SHIELD switch selects either an “open” or “earth” shield connection for the 75 ohm RX interface. (This switch must be set to “open” when using the 120 ohm interface.)

CAUTION

Disconnect the power cable before connecting or removing any data cables at the rear of the unit.

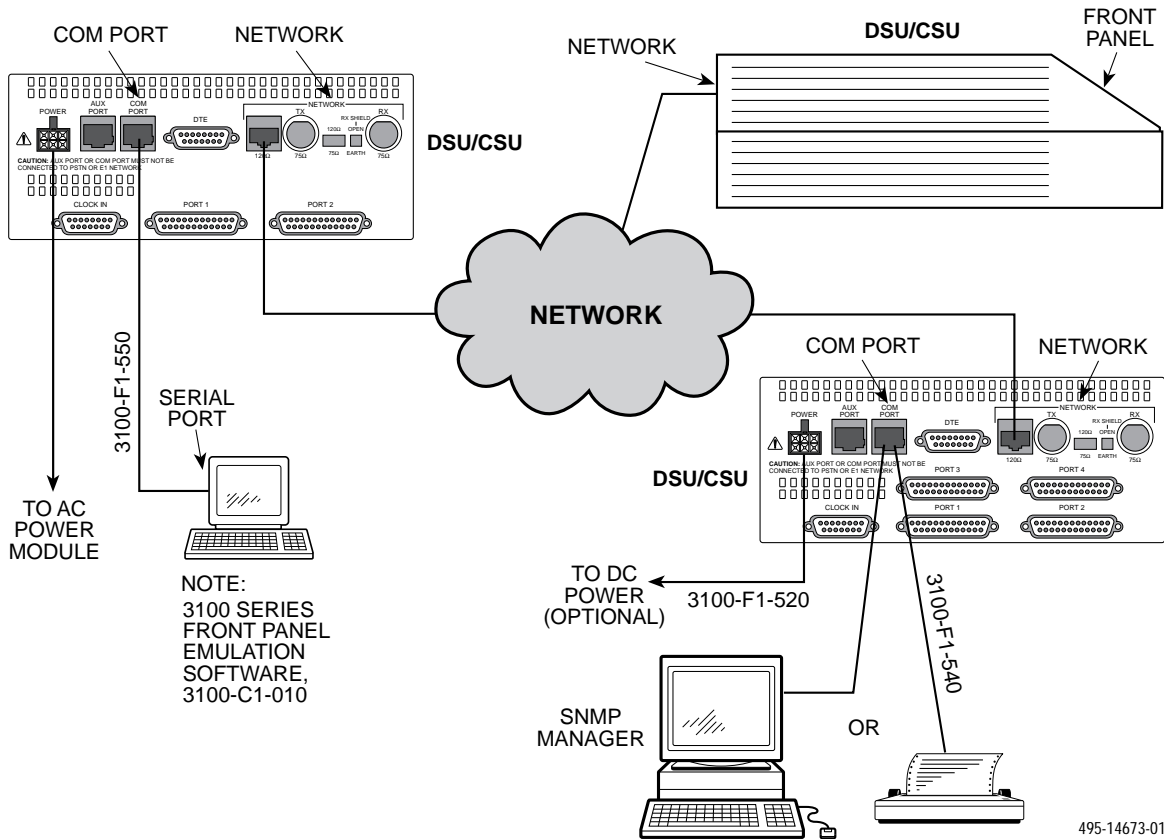

Figure 2-13. Cabling Examples

Power-Up Self-Test

After you connect the E1 DSU/CSU to a power source, the unit performs the power-up self-test to ensure that it is in good working order. The E1 DSU/CSU performs this test on itself upon power-up or after a device reset unless it has been disabled by the Self-Test configuration option (see Appendix C, *Configuration Options*).

The self-test includes a basic processor test, a limited memory test, a code checksum test, and basic verification tests of the internal components. The front panel LCD displays the progress and pass/fail status of these power-up tests.

The power-up self-test consists of the following steps:

1. Once the E1 DSU/CSU is plugged in, the In Progress screen appears and the Fail LED blinks ON and Off continuously.

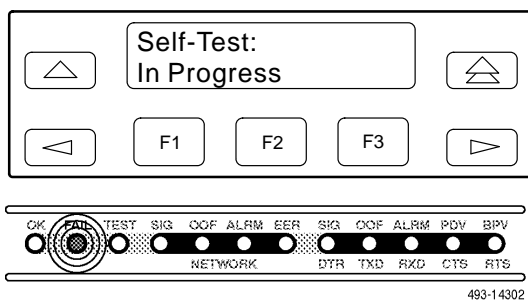

2. All the LEDs then start to flash simultaneously in the pattern twice ON, then Off. Then, the LCD begins to flash characters and numbers in the same pattern, alternating with the flashing LEDs.
3. If the self-test is successful, the Passed screen appears for one second, the Fail LED turns Off and the OK LED lights.

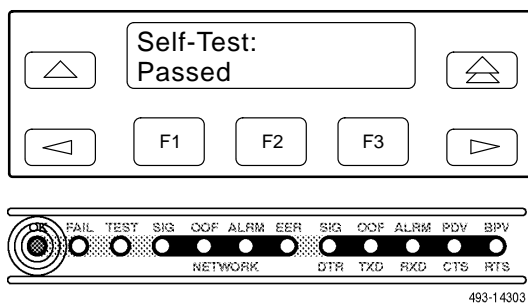

If the self-test fails, the Failed screen appears for five seconds. The Fail LED lights, and an eight-digit failure code (nnnnnnnn) is displayed for use by service personnel to determine the cause of the self-test failure. The E1 DSU/CSU continues to try to operate. If you are in doubt about the results of the self-test, use the Self-Test Health command to display the status of this test (see the *Self-Test Health* section in Chapter 4, *Maintenance*).

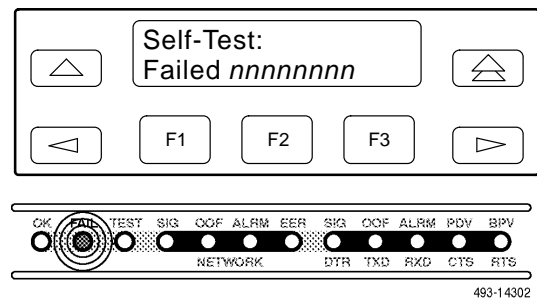

4. The top-level menu screen appears.

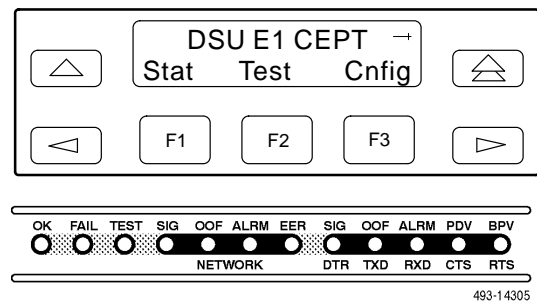

Operation 3

Overview	3-2
Using the Front Panel	3-2
LCD	3-3
Keypad	3-3
Test Jacks	3-4
LEDs	3-4
Displaying Unit Identity	3-8
Displaying LED Conditions	3-10
Selecting the DTE Drop/Insert or Data Port for LED Display	3-11
Changing Configuration Options	3-11
Displaying/Editing Configuration Options	3-12
Saving Edit Changes	3-13
Selecting/Copying to a Specific Port	3-13
Configuring the E1 DSU/CSU for SNMP Management	3-14
Selecting the Port	3-14
Setting the IP Address	3-15
Selecting the Link Layer Protocol	3-16
Specifying the Community Name(s) and Access Type(s)	3-17
Configuring SNMP Traps	3-18
Enabling SNMP Trap Messages	3-18
Selecting the Number of Trap Managers	3-19
Configuring a Destination for SNMP Traps	3-19
Configuring DS0 Channels	3-20
Displaying DS0 Channel Assignments	3-27
Allocating Data Ports	3-28
Block Channel Assignment Method	3-29
Individual Channel Assignment Method	3-30
Allocating DS0 Channels from the Drop/Insert Interface to the Network Interface	3-30
Clearing DS0 Channel Allocation	3-32
Providing Backup Capability	3-32
Selecting the Timing Source	3-33
Configuring for Network Timing	3-34
Configuring for External Timing	3-34
Acquiring/Releasing the User Interface	3-35
Acquiring the Active User Interface	3-35
Releasing the Active User Interface	3-35
Resetting the E1 DSU/CSU	3-36
Download Operations	3-36

Overview

This chapter contains information for operating your E1 DSU/CSU. It includes a description of the front panel and sample procedures for configuring the E1 DSU/CSU.

Using the Front Panel

The E1 DSU/CSU front panel (Figure 3-1) consists of an LCD, a keypad, test jacks, and 12 LEDs.

NOTE

You can display a graphical representation of the E1 DSU/CSU front panel on an attached PC (see Appendix G, *Front Panel Emulation*).

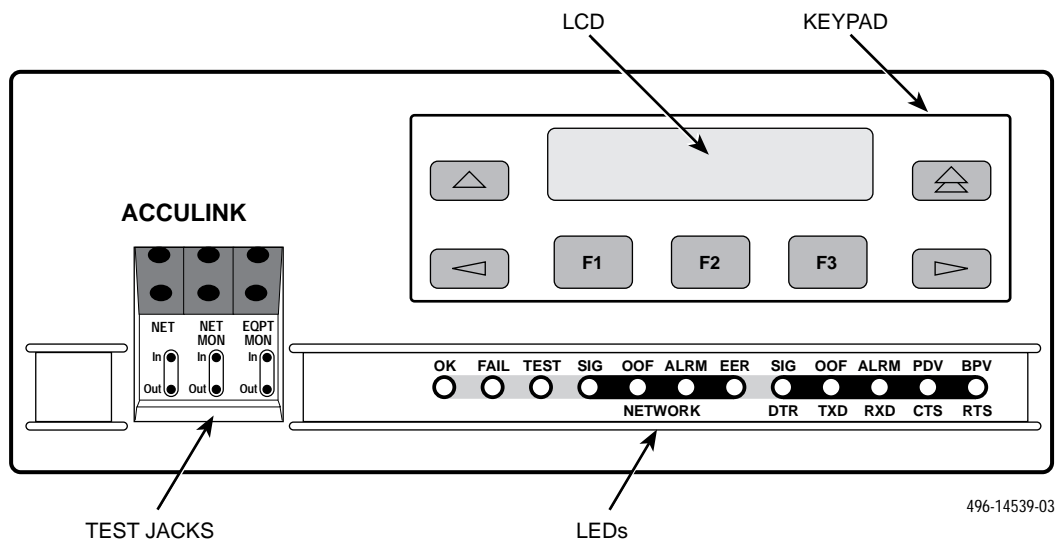

Figure 3-1. E1 DSU/CSU Front Panel

LCD

The LCD (Figure 3-2) displays two types of data:

- Messages such as alarms, command/test completion, and action in progress
- Front panel menu tree information (see Appendix A, *Front Panel Menu*)

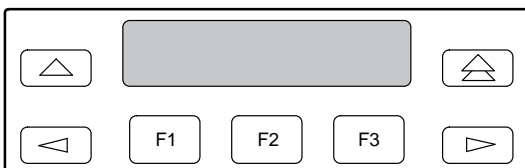

Figure 3-2. LCD

The LCD displays status messages as requested via the Device Health and Status branch of the front panel menu (see the *Device Health and Status* section in Chapter 4, *Maintenance*). In addition, the highest level status message appears on the front panel automatically if no front panel action has occurred at the E1 DSU/CSU for the past five minutes.

The LCD also lists commands, configuration options, and test results. In most cases, the top line shows the command or option name and default value, while the second line displays options and responses. When a response is required, select from the options displayed directly above the Function keys (F1, F2, F3); make your choice by pressing the corresponding Function key.

Keypad

The 7-button keypad (Figure 3-3) enables you to navigate through the menu tree and select choices presented on the second line of the LCD.

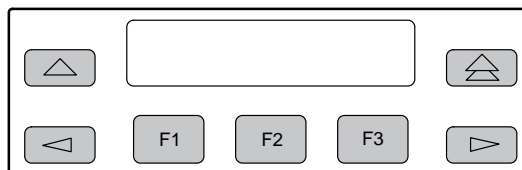
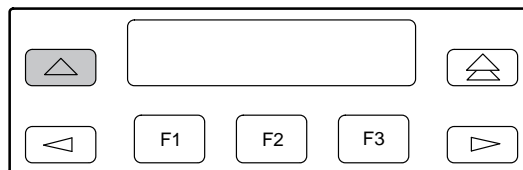
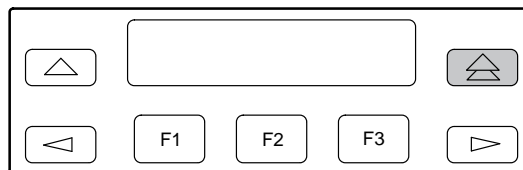

Figure 3-3. Keypad

Use the \triangle key to move up the menu.



Use the \triangle key to exit any part of the menu in which you may be operating. You immediately return to the top-level menu screen shown on the front panel menu (see Appendix A, *Front Panel Menu*).



Use the Function (F1, F2, F3) keys to make selections from the choices presented on the second line of the LCD. When this line presents choices, it is generally divided into three sections, each displayed directly above one of the Function keys. When your choice appears above one of the Function keys, press that key to select that choice.

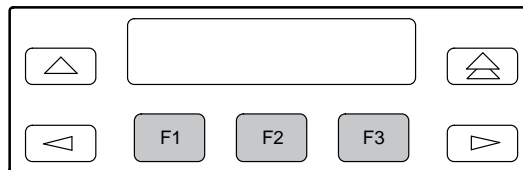

The scroll keys (◀ and ▶) serve one of two functions, depending on whether a menu screen or a data entry screen appears on the front panel.

For data entry screens, the ◀ key scrolls one character to the left while the ▶ key scrolls one character to the right.

For menu screens, the ◀ key scrolls to the previous menu choice while the ▶ key scrolls to the next menu choice.

If a choice is available to the left of the screen, the character ← appears on the top line. If a choice is available to the right of the screen, the → character appears on the top line. If choices are available to both the right and the left of the screen, two arrows appear (↔). The arrows indicate that you must use the scroll keys to bring the additional options onto the screen.

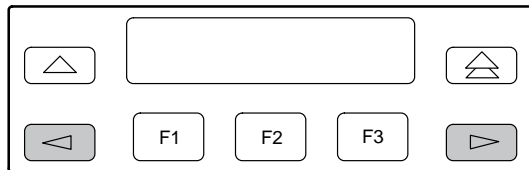

Test Jacks

Six test jacks are located on the front panel (Figure 3-4). These are described in the *Test Jacks* section in Chapter 4, *Maintenance*.

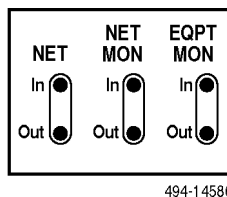

Figure 3-4. Test Jacks

LEDs

There are twelve LEDs on the E1 DSU/CSU front panel. The five LEDs on the right (Figure 3-5) are shared between the DTE Drop/Insert port and the data ports. Refer to the *Selecting the DTE Drop/Insert or Data Port for LED Display* section later in this chapter to choose which port's status the LEDs display.

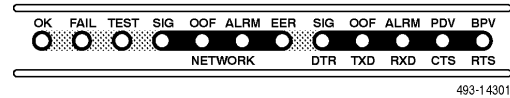

Figure 3-5. E1 DSU/CSU LEDs

A green LED indicates normal operation. A yellow LED indicates a warning (for the DTE Drop/Insert port) or activity (for the data ports). Conditions are sampled every tenth of a second.

The twelve front panel LEDs are grouped into four sections to indicate the status of the:

- System (Table 3-1)
- NETWORK interface (Table 3-2)
- DTE Drop/Insert Port (Table 3-3)
- Data Ports (Table 3-4)

**Table 3-1
System LEDs**

Name	Color	Meaning
OK	Green	Indicates the current operational state of the E1 DSU/CSU. <i>ON:</i> The E1 DSU/CSU is operational and has power. <i>OFF:</i> The E1 DSU/CSU is performing a power-up self-test or a system failure has occurred. <i>BLINKING:</i> A software download is in progress.
FAIL	Yellow	Indicates a system failure or a self-test. <i>ON:</i> A device error/fault is detected or a reset has just occurred. <i>OFF:</i> No system failures are detected. <i>BLINKING:</i> A self-test is in progress.
TEST	Yellow	A system test is in progress. <i>ON:</i> A loopback or pattern test has been initiated either locally, by the network, or externally. <i>OFF:</i> No tests are active.

**Table 3-2
NETWORK Interface LEDs**

Name	Color	Meaning
SIG	Green	Monitors the signal being received from the network. <i>ON:</i> A recoverable signal is being received from the network. <i>OFF:</i> The signal cannot be recovered from the network (a Loss of Signal condition exists).
OOF	Yellow	Monitors Out Of Frame (OOF) conditions on the received network signal. <i>ON:</i> At least one OOF was detected on the signal during the sampling period. <i>OFF:</i> No OOFs were detected on the signal during the sampling period.
ALRM	Yellow	Indicates whether an alarm condition exists on the received network signal. <i>ON:</i> An alarm condition (LOS, LOF, EER, RAI, AIS) exists on the received network signal. Use the Device Health and Status command to determine the alarm type. <i>OFF:</i> No alarm condition exists on the network interface signal.
EER	Yellow	Indicates when the excessive error rate has been exceeded on the network interface. <i>ON:</i> The excessive error rate has been exceeded on the network interface. <i>OFF:</i> The excessive error rate has not been exceeded on the network interface.

**Table 3-3
DTE Drop/Insert Port LEDs**

Name	Color	Meaning
SIG	Green	Monitors the signal being received from the DTE Drop/Insert port. <i>ON:</i> A recoverable signal is being received from the DTE Drop/Insert port. <i>OFF:</i> The signal cannot be recovered from the DTE Drop/Insert port (a Loss of Signal condition exists).
OOF	Yellow	Monitors Out Of Frame (OOF) conditions on the received DTE Drop/Insert signal. <i>ON:</i> At least one OOF was detected on the signal during the sampling period. <i>OFF:</i> No OOFs were detected on the signal during the sampling period.
ALRM	Yellow	Indicates whether an alarm condition exists on the received DTE Drop/Insert signal. <i>ON:</i> An alarm condition (LOS, LOF, EER, RAI, AIS) exists on the received DTE Drop/Insert signal. Use the Device Health and Status command to determine the alarm type. <i>OFF:</i> No alarm condition exists on the DTE Drop/Insert Interface signal.
PDV	Yellow	Monitors Pulse Density Violations (PDV) on the received DTE Drop/Insert signal. <i>ON:</i> At least one PDV was detected (and corrected) on the received DTE Drop/Insert signal during the sampling period. <i>OFF:</i> No PDVs were detected on the received DTE Drop/Insert signal during the sampling period.
BPV	Yellow	Monitors Bipolar Violations (BPV) on the received DTE Drop/Insert signal. <i>ON:</i> At least one BPV was detected (and corrected) on the received DTE Drop/Insert signal during the sampling period. <i>OFF:</i> No BPVs were detected on the received DTE Drop/Insert signal during the sampling period.

**Table 3-4
Data Port LEDs**

Name	Color	Meaning
DTR	Green	Monitors the state of interchange circuit CD (CCITT 108/1, /2) – Data Terminal Ready received from the synchronous data DTE. <i>ON:</i> DTR is being asserted by the synchronous data DTE. <i>OFF:</i> DTR is not being asserted.
TXD	Yellow	Monitors activity on interchange circuit BA (CCITT 103) – Transmitted Data. This is the data sent from the synchronous data DTE to the data port on the E1 DSU/CSU. <i>ON:</i> Ones are being received from the synchronous data DTE. <i>OFF:</i> Zeros are being received from the synchronous data DTE. <i>CYCLING:</i> Both ones and zeros are being received from the synchronous data DTE.
RXD	Yellow	Monitors activity on interchange circuit BB (CCITT 104) – Received Data. This is data sent to the synchronous data DTE from the data port on the E1 DSU/CSU. <i>ON:</i> Ones are being sent to the synchronous data DTE. <i>OFF:</i> Zeros are being sent to the synchronous data DTE. <i>CYCLING:</i> Both ones and zeros are being sent to the synchronous data DTE.
CTS	Yellow	Monitors the state of interchange circuit CB (CCITT 106) – Clear-to-Send sent to the synchronous data DTE. <i>ON:</i> CTS is being asserted by the E1 DSU/CSU. <i>OFF:</i> CTS is not being asserted.
RTS	Yellow	Monitors the state of interchange circuit CA (CCITT 105) – Request-to-Send received from the synchronous data DTE. <i>ON:</i> RTS is being asserted by the synchronous data DTE. <i>OFF:</i> RTS is not being asserted.

Displaying Unit Identity

The identity of the E1 DSU/CSU (serial number, model number, software revision level, hardware revision level, and customer identification) is available through the Status branch of the front panel menu (see Appendix A, *Front Panel Menu*).

The customer identification is the only identity number you can change.

To display the E1 DSU/CSU's identity (ID),

1. Press F1 to select Status from the top-level menu screen.

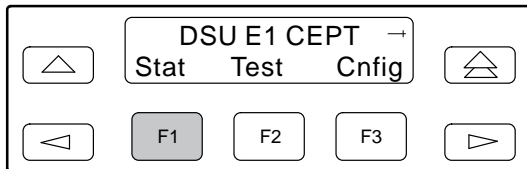

2. Press the \triangleright key three times on the Status screen to bring the ID selection onto the front panel LCD.

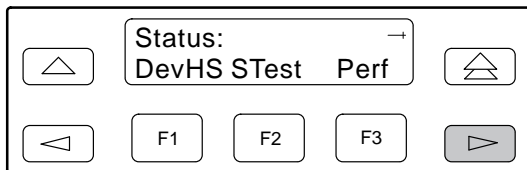

3. Press F3 to select ID from the Status screen.

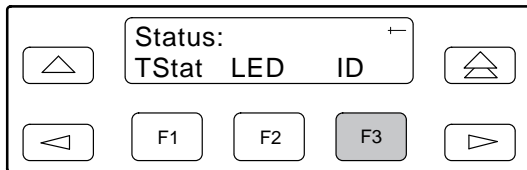

4. The following screens appear in the order listed each time you press the \triangleright key.

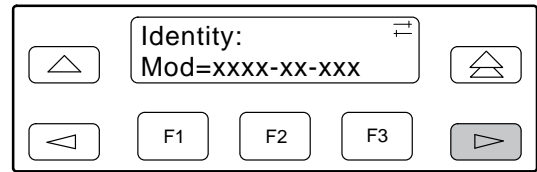
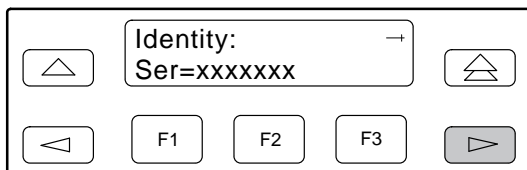

NOTE

The third-from-last digit in the model number may vary due to the type of power supply shipped with the E1 DSU/CSU. Refer to the label on the bottom of the E1 DSU/CSU for the correct model number.

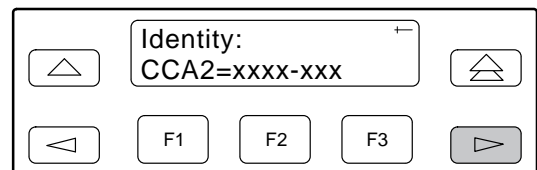
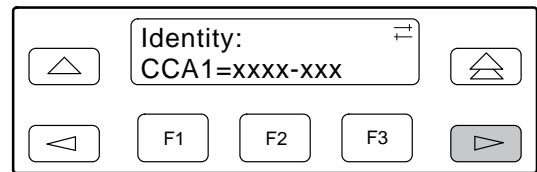
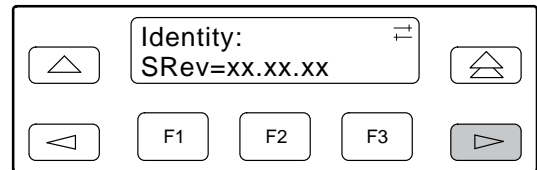
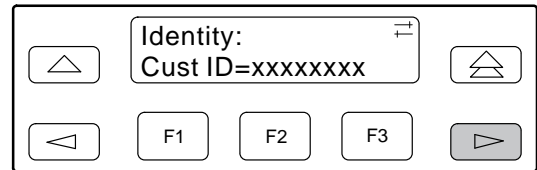

To change the customer identification (CID),

1. Press the \triangleright key on the top-level menu to bring the Ctrl branch onto the front panel LCD.

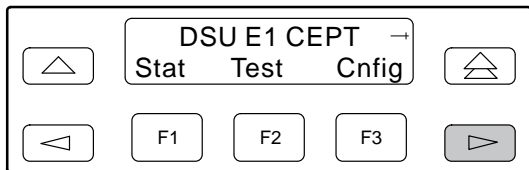

2. Press F3 to select Ctrl from the top-level menu screen.

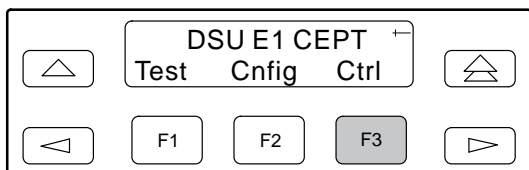

3. Press the \triangleright key on the Control screen until the CID selection appears on the front panel LCD.

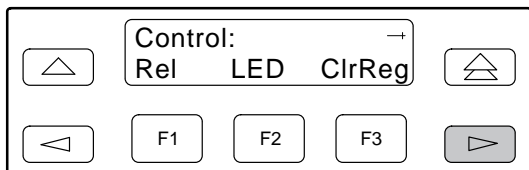

4. Select CID.

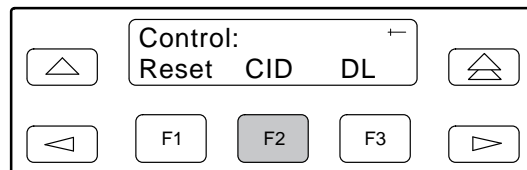

5. Use the \triangleleft and \triangleright keys to position the cursor under the desired character. You must enter a character before the \triangleright moves the cursor to the next space to the right.

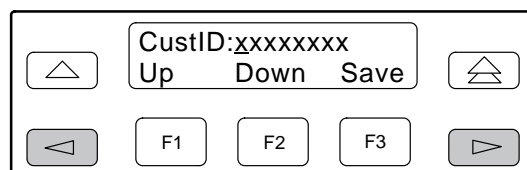

6. Enter the desired ID. Press F1 (Up) and F2 (Down) to scroll up and down through the valid characters/numbers for the customer ID. Valid characters are 0 through 9, #, -, ., /, A to Z, and blank space. Press F3 (Save) to save the ID.

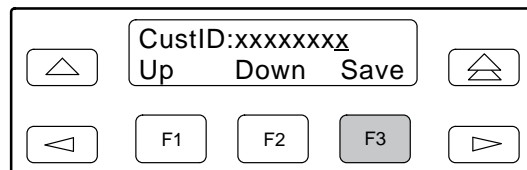

Displaying LED Conditions

The same conditions monitored by the front panel LEDs can also be monitored by the LED command. This command is most useful when the E1 DSU/CSU is being accessed remotely (see Appendix G, *Front Panel Emulation*). When using Front Panel Emulation, no LEDs are shown on the PC's screen; you must use the Stat command procedure described below to get LED information.

To display LED conditions on the front panel screen,

1. Press F1 to select Stat from the top-level menu screen.

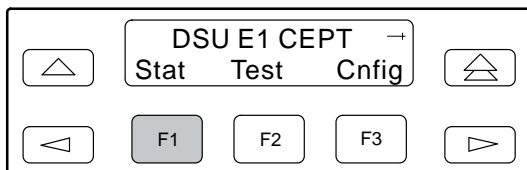

2. From the Status screen, press the \triangleright key to display the LED selection.

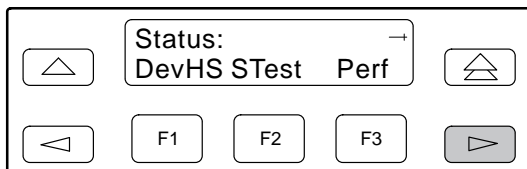

3. Select LED from the Status screen.

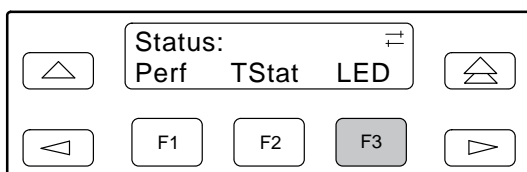

4. From the Select LEDs screen, press the Function key that corresponds to E1 or the port for which you want to display LEDs. Use the scroll keys, if necessary.

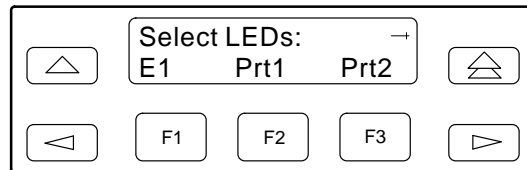

If you chose E1, the LED Display screen lists the LED signals, two at a time, on the second line. A vertical bar at the left of the LED name indicates the condition is ON, while an underscore indicates the condition is Off.

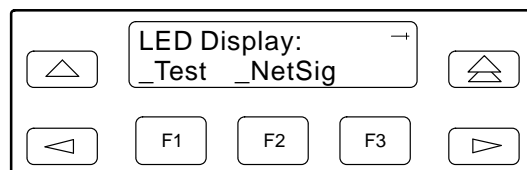

If you chose a port, the Port *n* LEDs screen lists the LED signals, two at a time, on the second line. A vertical bar at the left of the LED name indicates the condition is ON, while an underscore indicates the condition is Off.

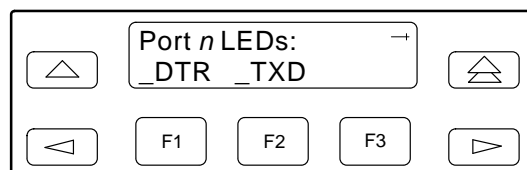

5. Use the \triangleright and \triangleleft keys to scroll LED names onto the screen.

Selecting the DTE Drop/Insert or Data Port for LED Display

Use the LED command on the Control branch to select which port's (DTE Drop/Insert or data port) status appears on the five shared LEDs on the front panel.

To select a port for LED display,

1. From the top-level menu screen, press \triangleright once to scroll the Ctrl name onto the screen.

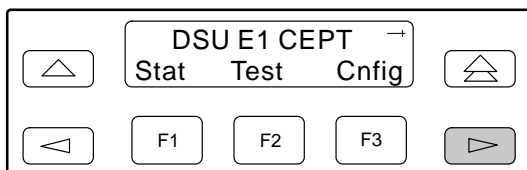

2. Press F3 to select Ctrl.

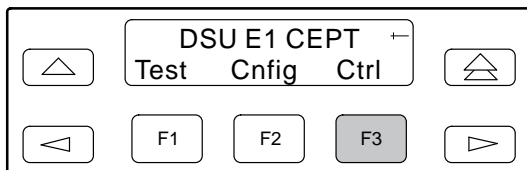

3. From the Control screen, select LED.

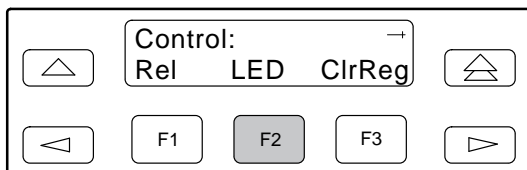

The currently selected port name appears on the top line of the LCD. DTE indicates the DTE Drop/Insert port.

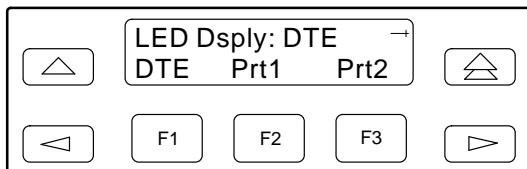

4. From the LED Dsply screen, press the Function key that corresponds to the DTE Drop/Insert or data port for which you want the LEDs to display. Use the scroll keys, if necessary.

Select DTE to monitor the DTE Drop/Insert port's SIG, OOF, ALRM, PDV, and BPV status signals on the shared LEDs.

Select a particular data port to monitor the data port's DTR, TXD, RXD, CTS, and RTS control signals on the shared LEDs.

Changing Configuration Options

The E1 DSU/CSU is an intelligent device that displays only valid options for the current configuration. Therefore, you are only presented with menu choices that are consistent with the current configuration and operational state of the E1 DSU/CSU; invalid combinations of configuration options do not appear. For example, menus displayed for the Model 3172 (2 ports) and the Model 3174 (4 ports) differ due to the number of ports available. Also, if the DTE Drop/Insert interface selection is disabled, many of the menu choices do not appear. Be aware that although all options are shown in this guide, what you see on your E1 DSU/CSU varies with your configuration.

The E1 DSU/CSU offers four sets of configuration options located in the following memory areas:

- **Active (Activ).** The configuration option set active for the E1 DSU/CSU is stored here. Before a configuration option set becomes active for the E1 DSU/CSU, you must save the set to the Active area. When the E1 DSU/CSU is shipped from the factory, the Active configuration option set is identical to the Factory set. This area can be written to and controls the current operation of the device.
- **Customer 1 (Cust1).** The first of two sets of customer-defined configuration options. This area can be written to.
- **Customer 2 (Cust2).** The second of two sets of customer-defined configuration options. This area can be written to.
- **Factory (Fact).** This is a set of configuration options preset at the company. This set is determined by what is considered to be the most common configuration used in the E1 DSU/CSU market. Factory options are read-only.

The configuration options are divided into functional groups. Appendix C contains a list of the configuration options and defaults. These groups are:

- DTE (Drop/Insert) Interface (Table C-1)
- Port (Table C-2)
- Network Interface (Table C-3)
- Channel (Tables C-4 and C-5)
- General (Table C-6)
- User Interface (Table C-7)
- Alarm (Table C-8)
- General SNMP (Table C-9)
- SNMP Trap (Table C-10)

Use the Configuration (Cnfig) branch of the front panel menu tree to display or change E1 DSU/CSU configuration options (see Appendix A, *Front Panel Menu*).

Displaying/Editing Configuration Options

To display/edit configuration options,

1. Press F3 to select Cnfig from the top-level menu screen.

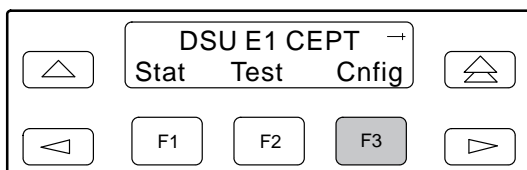

2. Select the configuration option set to be copied into the Edit area by using the appropriate Function key. Use the scroll keys, if necessary.

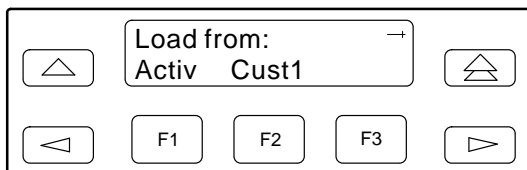

3. Press F1 to select Edit.

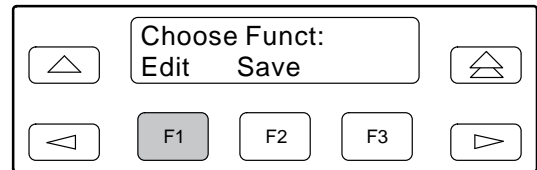

4. From the Edit screen, select the functional group you want to edit by pressing the appropriate Function key. Use the scroll keys, if necessary. (The NET selection is shown as an example only.)

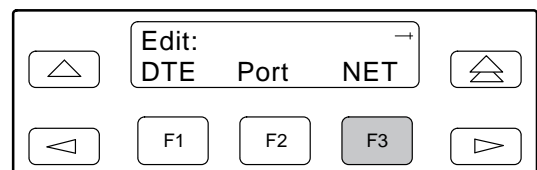

The configuration options for the selected functional group appear on the front panel one option at a time. The option name appears on Line 1 with the current value next to it. To reach other options, use the Next and Previous selections to scroll forward and backward through the group of options.

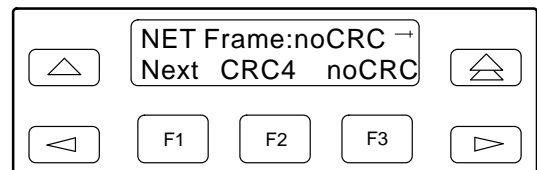

5. Press the appropriate Function key to choose another value. Use the scroll keys, if necessary.
6. Use the Save procedure to save your changes to the Active or Customer area.

Saving Edit Changes

Save edit changes to the Active area when you want those changes to take effect immediately. Save edit changes to the Customer area when you want to overwrite the existing Customer configuration options and store these changes for future use.

NOTE

If you attempt to exit the Edit function after making changes without performing a Save, the E1 DSU/CSU prompts you with **Save Options? Choose Yes or No.**

To save edit changes,

1. From the Choose Function screen (one level above the Edit screen, two levels below the top-level menu screen), press F2 to select Save.

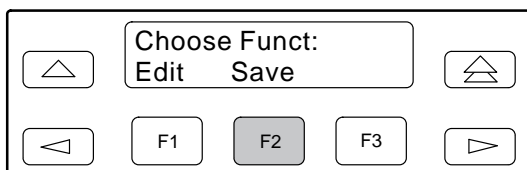

2. Choose whether you want to save to the Active, Customer 1, or Customer 2 area. Use the scroll keys, if necessary.

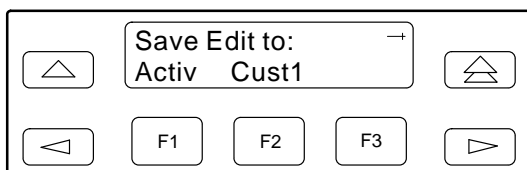

Selecting/Copying to a Specific Port

For the E1 DSU/CSU, you have the capability of selecting a specific port to configure, and then copying the configuration options from that port to another port (or to all ports).

To select a specific port to configure,

1. Press F3 to select Cnfig from the top-level menu screen.
2. Select the configuration option set to be copied into the Edit area by using the appropriate Function key. Use the scroll keys, if necessary.
3. Press F1 to select Edit.
4. Press F2 to select Port.

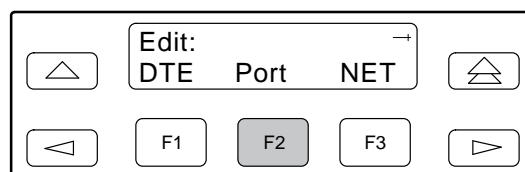

5. From the Port Select screen, press the Function key that corresponds to the port you want to configure. Use the > key to scroll additional ports onto the screen, if necessary. Configure the port (see Appendix C, *Configuration Options*).

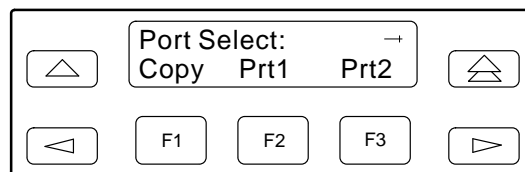

To copy the configuration options to one or all ports,

6. From the Port Select screen, press F1 (Copy).

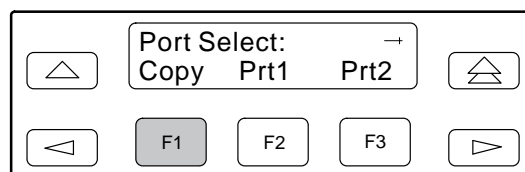

7. Select the port *from* which you want to copy the configuration options using the corresponding Function key.

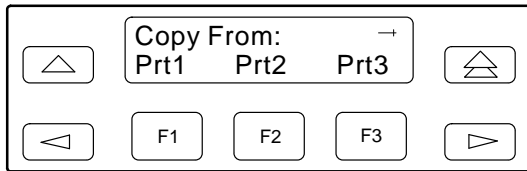

8. Select the port *to* which you want to copy the configuration options using the corresponding Function key. Or, press F1 (All) to choose to copy to all ports.

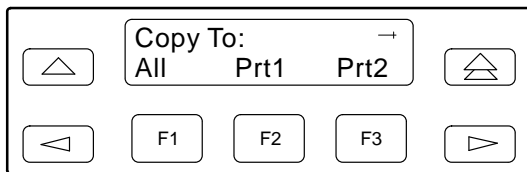

Configuring the E1 DSU/CSU for SNMP Management

To configure the E1 DSU/CSU for management by an SNMP management system you must,

- Select and configure the port that provides the link to the SNMP management system.
- Set the Internet Protocol (IP) address and subnet mask needed to access the device (see Appendix F, *IP Network Addressing Scenario*).
- Select the link layer protocol (PPP or SLIP) for the port.
- Specify the two community names that are allowed to access the device's Management Information Base (MIB).
- Configure the device to send traps to the SNMP manager, if desired.

Selecting the Port

The SNMP manager or network device (e.g., a router) can be directly connected to the communications (COM) port. An external LAN Adapter can be connected to either the COM port or the auxiliary (AUX) port to provide Ethernet or Token Ring connectivity. Also, the E1 DSU/CSU can be daisy chained together by connecting the COM port of one device to the AUX port of the other, providing SNMP connectivity.

The COM port can support either synchronous or asynchronous PPP, or asynchronous SLIP at data rates of up to 38,400 bps. The AUX port can support data rates up to 38,400 bps.

The example shown below assumes that the COM port is being used as the link to the SNMP manager.

To select the COM port as the management link,

1. Press F3 to select Cnfig from the top-level menu screen.
2. Select the configuration option set to be copied into the Edit area by using the appropriate Function key. Use the scroll keys, if necessary.
3. Press F1 to select Edit.
4. Press the \triangleright key from the Edit screen to display the User selection.
5. Select User.

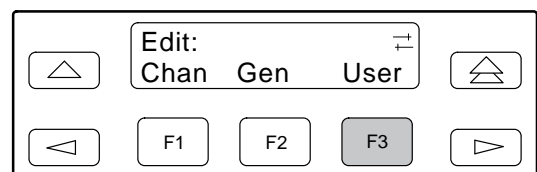

6. Press F1 (Next) until the Com Use configuration option appears.

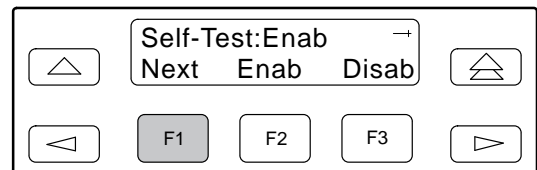

- Press F2 to configure the COM port as the management link to an external SNMP manager.

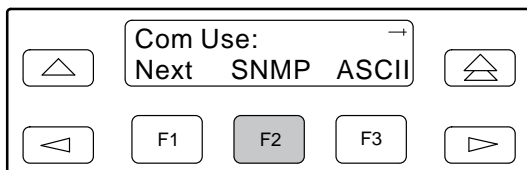

- Press F1 to select Gen from the SNMP Config screen.

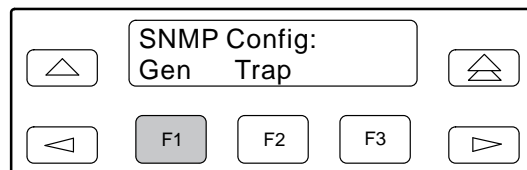

Setting the IP Address

The IP address is the address used by the SNMP manager to access the device. For devices using PPP, the IP address can be negotiated if the network device (e.g., router or SNMP manager) supports such negotiation. The IP address is composed of four fields with three digits per field (*xxx.xxx.xxx.xxx*).

The IP address is set for the COM port or the AUX port (with LAN Adapter or daisy chain), depending on which one has been chosen as the SNMP communications link. The example below assumes that an IP address of 010.155.111.222 is being set for the COM port. You can use the same principles to assign any value (between 000 and 255 for each digit field) to either port.

To assign an IP address to the COM port,

- Press F3 to select Cnfig from the top-level menu screen.
- Select the configuration option set to be copied into the Edit area by using the appropriate Function key. Use the scroll keys, if necessary.
- Press F1 to select Edit.
- Press the \triangleright key from the Edit screen to display the SNMP selection.
- Select SNMP.

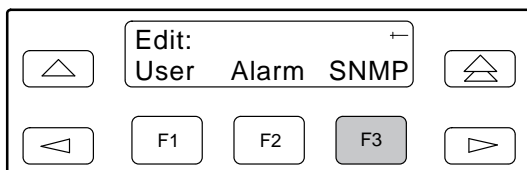

- Press F1 (Next) until the Com IP Adr configuration option appears.

NOTE

Steps 8 and 9 describe the process for entering an IP address. This process applies to any IP address.

- Press F2 (Edit) to edit the IP address. You have the option of using F3 (Clear) to reset the IP address to the factory default *000.000.000.000*.

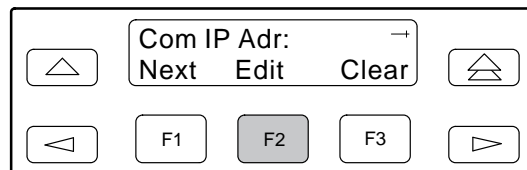

- Use the \triangleleft and \triangleright keys to position the cursor under the digit you want to change. Press F1 (Up) to increment the digit or F2 (Down) to decrement the digit. In this example, you would press \triangleright once to place the cursor under the middle digit in the first digit field, then press F1 (Up) once to change the 0 to a 1. Continue in this manner to change the other digits.

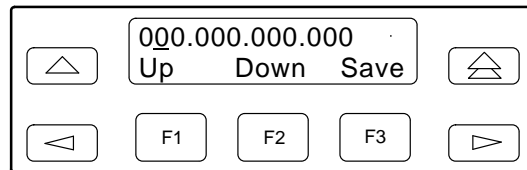

- When you are through changing the IP address, you **must** press F3 (Save) to save the value. Otherwise, the original value will be retained.

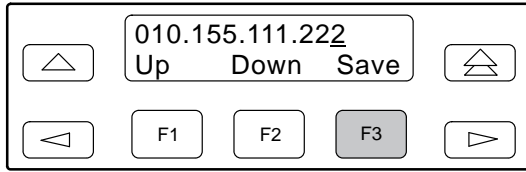

Selecting the Link Layer Protocol

Two link layer protocols, Point-to-Point Protocol (PPP) and Serial Line Internet Protocol (SLIP), are supported for connection to an external SNMP manager or network device (e.g., a router). PPP can be used for synchronous or asynchronous operation. SLIP can be used for asynchronous operation only.

The E1 DSU/CSU implementation of PPP supports the following:

- Full negotiation of PPP's Link Control Protocol (LCP).
- Active negotiation of LCP when the connection is established.
- Maximum Request Unit (MRU) sizes up to 1500 bytes, but the E1 DSU/CSU will attempt to negotiate down to 500 bytes.
- The E1 DSU/CSU provides a unique LCP magic number derived from the unit serial number and the elapsed time.
- Full negotiation of escape characters.

The E1 DSU/CSU implementation of PPP does not support Link Quality Reports (LQR), compression, encryption, Password Authentication Protocol (PAP) or Challenge Authentication Protocol (CHAP).

The E1 DSU/CSU implementation of SLIP supports a fixed MRU size of 1006 bytes.

Before selecting the protocol, you must first select the port to be used as the communications link. Refer to the *Selecting the Port* section on page 3-14. This example assumes that the COM port is being used as the communications link.

To select the link layer protocol,

- Press F3 to select Cnfig from the top-level menu screen.
- Select the configuration option set to be copied into the Edit area by using the appropriate Function key. Use the scroll keys, if necessary.
- Press F1 to select Edit.
- Press the \triangleright key from the Edit screen to display the SNMP selection.
- Press F3 to select SNMP.

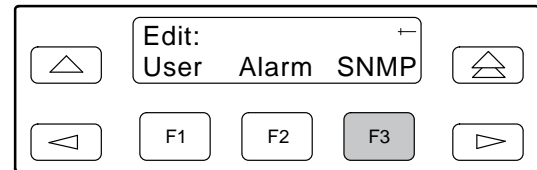

- Press F1 to select Gen from the SNMP Config screen.

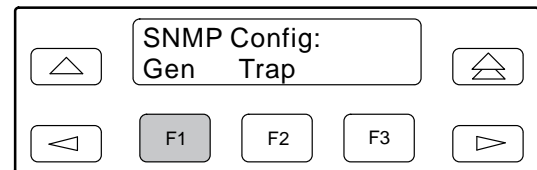

- Press F1 (Next) until the Com Link configuration option appears.
- Press F2 (PPP) or F3 (SLIP).

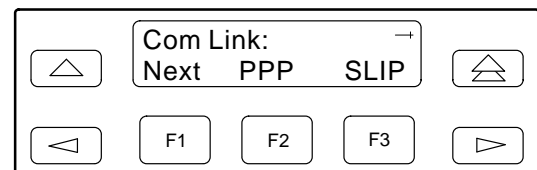

Specifying the Community Name(s) and Access Type(s)

You have the capability of specifying up to two community names (community name 1 and community name 2) to be used by external SNMP managers when trying to access objects in the E1 DSU/CSU's MIB. Once you specify the community name(s), you must then specify the type of access to the MIB that SNMP managers in the community are permitted to have.

To specify the community name 1 and its access type,

1. Press F3 to select Cnfig from the top-level menu screen.
2. Select the configuration option set to be copied into the Edit area by using the appropriate Function key. Use the scroll keys, if necessary.
3. Press F1 to select Edit.
4. Press the \triangleright key from the Edit screen to display the SNMP selection.
5. Press F3 to select SNMP.

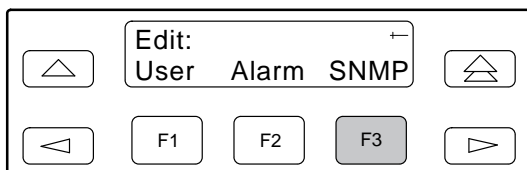

6. Press F1 to select Gen from the SNMP Config screen.

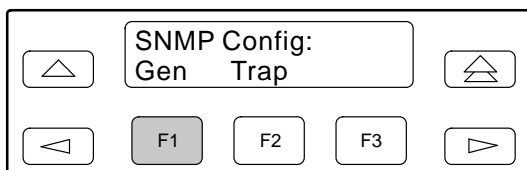

7. Press F1 (Next) until the CommunityName1 configuration option appears.

8. Press F2 (Edit) to edit the community name. The factory default community name is **public**.

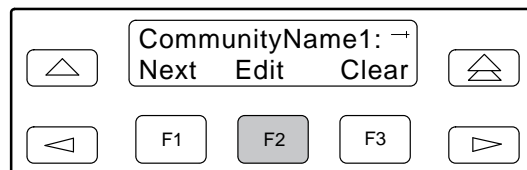

NOTE

Steps 9 and 10 describe the process for entering text strings for SNMP configuration options. This process applies to entering any text strings into SNMP configuration options.

9. Use the \triangleleft and \triangleright keys to position the cursor under the character you want to change. Press F1 (Up) or F2 (Down) to scroll through the valid numbers/characters for the text string.

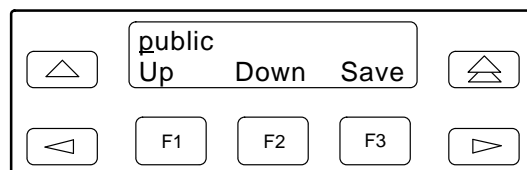

The F1 (Up) key scrolls through the ASCII character set in the following order: numbers (0–9), lowercase letters (a–z), uppercase letters (A–Z), space character, ASCII symbols (ascending order, based on ASCII code), and the End of Line symbol (\leftarrow). The \leftarrow erases all characters to the right of the cursor.

10. When you are through changing the community name, you **must** press F3 (Save) to save the value. Otherwise, the original value will be retained.

- Press F1 (Next) until the Access 1 configuration option appears.

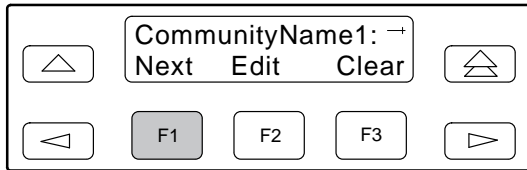

- Press F2 (Read) or F3 (R/W).

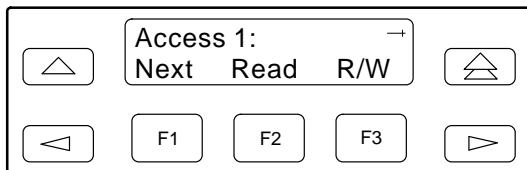

The Read selection allows read-only access (SNMP “Get”) to the accessible objects in the MIB when community name 1 is used. The R/W selection allows Read/Write access (SNMP “Get” and “Set”) to the objects in the MIB. Write access is allowed for all objects specified as read/write in the MIB. Read access is allowed for all objects specified as read-only or read/write.

Configuring SNMP Traps

A trap is an unsolicited message that is sent from the E1 DSU/CSU to an SNMP manager when the device detects certain, pre-specified conditions. These traps enable the SNMP manager to monitor the state of the network.

The SNMP Trap configuration option must be enabled for trap messages to be sent over the communications link. You must specify the number of SNMP managers that are to receive traps from this device, an IP address for each SNMP manager specified, and the type of traps to be sent from this device. For more information, refer to Appendix C, *Configuration Options*, and the *SNMP Traps* section in Chapter 4, *Maintenance*.

Enabling SNMP Trap Messages

To enable SNMP trap messages from this device,

- Press F3 to select Cnfig from the top-level menu screen.
- Select the configuration option set to be copied into the Edit area by using the appropriate Function key. Use the scroll keys, if necessary.
- Press F1 to select Edit.
- Press the \triangleright key from the Edit screen to display the Alarm selection.
- Select Alarm.

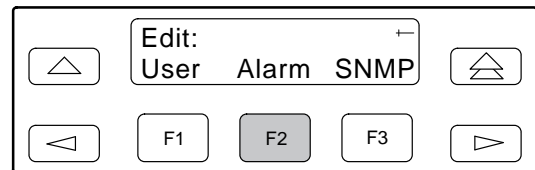

- Press F1 (Next) until the SNMP Trap configuration option appears.
- Press F2 (Enab) to enable trap messages over the SNMP management link.

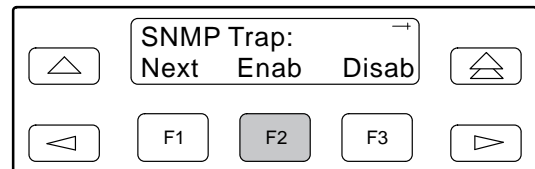

Selecting the Number of Trap Managers

If you intend to issue traps to an SNMP manager(s) from this device, you must specify the number of SNMP managers that are to receive the traps.

To specify the number of SNMP managers to receive traps from this device,

1. Press F3 to select Cnfig from the top-level menu screen.
2. Select the configuration option set to be copied into the Edit area by using the appropriate Function key. Use the scroll keys, if necessary.
3. Press F1 to select Edit.
4. Press the \triangleright key from the Edit screen to display the SNMP selection.
5. Select SNMP.

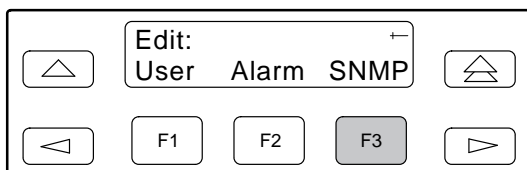

6. Select Trap from the SNMP Config screen.

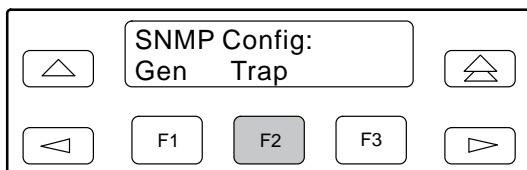

7. Select the number of SNMP managers to receive traps (from 1 through 6) by using the appropriate Function key. Use the scroll keys, if necessary.

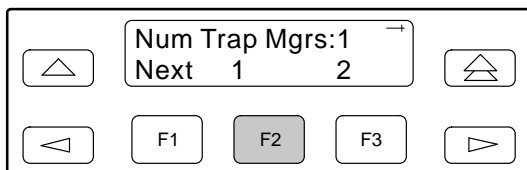

Configuring a Destination for SNMP Traps

A destination must be configured for each SNMP trap manager specified. This configuration option is displayed for the number of trap managers specified by the Number of Trap Managers configuration option.

To configure an IP address for the SNMP trap manager,

1. Press F3 to select Cnfig from the top-level menu screen.
2. Select the configuration option set to be copied into the Edit area by using the appropriate Function key. Use the scroll keys, if necessary.
3. Press F1 to select Edit.
4. Press the \triangleright key from the Edit screen to display the SNMP selection.
5. Select SNMP. (For screen displays, see the previous section, *Selecting the Number of Trap Managers*.)
6. Select Trap from the SNMP Config screen.
7. Press F1 (Next) until the Trapn IP Address configuration option appears.
8. Press F2 (Edit) to edit the IP address. You have the option of using F3 (Clear) to reset the IP address to the factory default *000.000.000.000*. Refer to the *Setting the IP Address* section on page 3-15 for more information on setting an IP address.
9. Press F1 (Next) until the Trapn Destination configuration appears, and select the destination for the SNMP trap by using the appropriate Function key. Use the scroll keys, if necessary.

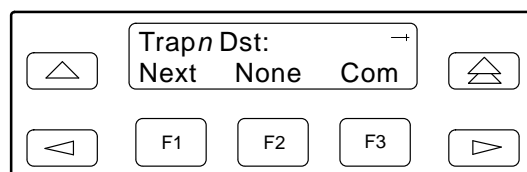

Configuring DS0 Channels

The E1 DSU/CSU provides channel configuration options that allow you to do the following:

- Display the DS0 assignments for the Network, DTE Drop/Insert, and data port interfaces.
- Allocate DS0 channels on the DTE Drop/Insert interface to the Network interface.
- Allocate DS0 channels on the Network or DTE Drop/Insert interface to particular data ports.
- Specify whether time-slot 16 (TS16) is reserved for signaling information.
- Clear (deallocate) all DS0 channels from the Network, DTE Drop/Insert, or data port interface.
- Map data from one port to another.

NOTE

If TS16 is reserved for signaling, D16 will automatically be assigned to N16, and DTE DS0 channels allocated to the network interface must be connected to the corresponding channel (e.g., D1 to N1, D2 to N2, etc.).

To allocate DS0 channels, begin by defining the logical channel configuration for the Network interface, and then the DTE Drop/Insert interface, and then any ports, if desired. See Figures 3-6 and 3-8 for examples of conceptual diagrams of channel configurations.

Blank configuration worksheets are provided at the back of Appendix C, *Configuration Options*. To complete the configuration worksheets for DS0 channel allocation:

1. Complete the Network E1 Interface and the DTE Drop/Insert Interface tables (unless the DTE Drop/Insert interface is disabled) as shown in the examples in Figures 3-7 and 3-9.
2. Using the worksheets shown in Figures 3-10 and 3-11, circle the configuration options needed to implement the logical channel configuration.

Once you have completed the worksheets, enter this information using the procedures in the *Allocating Data Ports* section on page 3-28. Configuration options are listed in Appendix C.

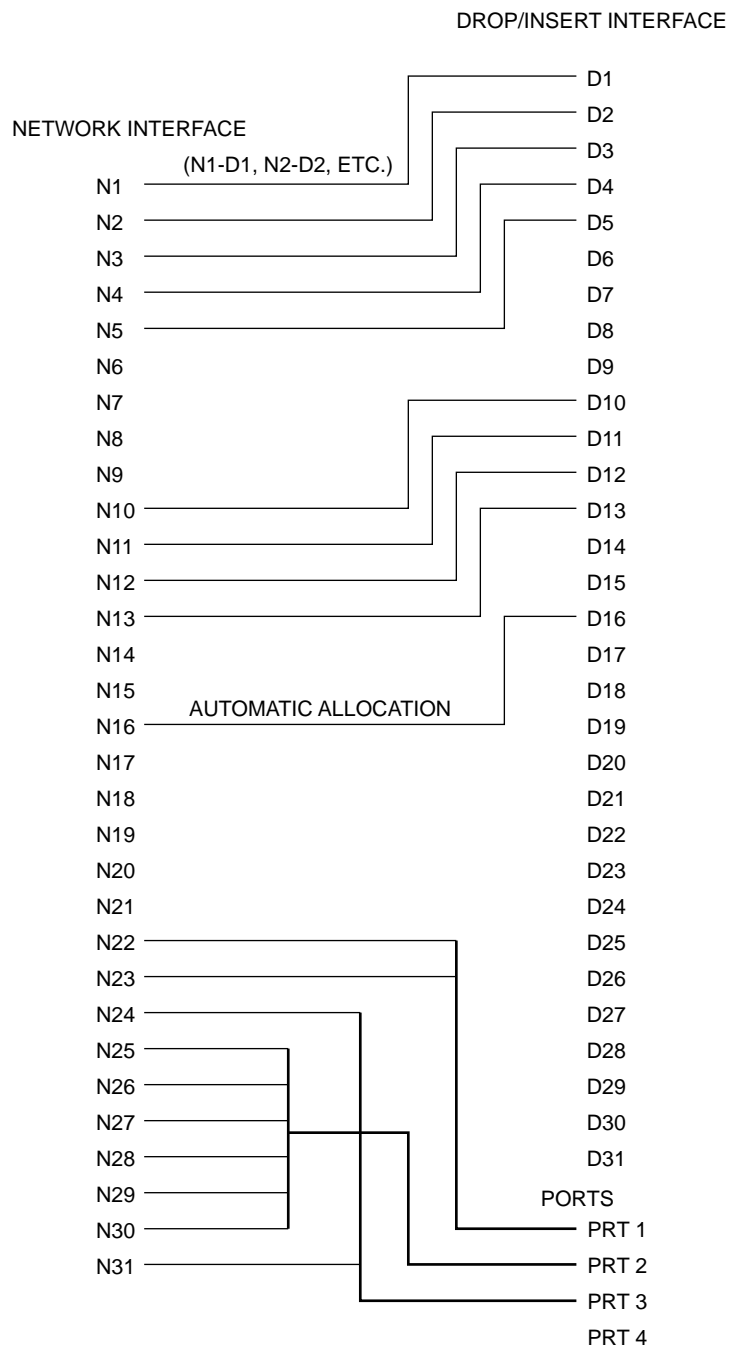

496-14899

Figure 3-6. Example of Channel Allocation with TS16 Reserved for Signaling

Network E1 Interface

Network Channel	Allocation
N1	D1
N2	D2
N3	D3
N4	D4
N5	D5
N6	
N7	
N8	
N9	
N10	D10
N11	D11
N12	D12
N13	D13
N14	
N15	
N16	D16
N17	
N18	
N19	
N20	
N21	
N22	Prt1
N23	Prt1
N24	Prt3
N25	Prt2
N26	Prt2
N27	Prt2
N28	Prt2
N29	Prt2
N30	Prt2
N31	Prt3

Allocations

D1 – D31 indicates allocation to DTE Drop/Insert channels.

Prt1 – Prt4 indicates allocation to synchronous data ports.

DTE Drop/Insert Interface

Drop/Insert Channel	Allocation
D1	N1
D2	N2
D3	N3
D4	N4
D5	N5
D6	
D7	
D8	
D9	
D10	N10
D11	N11
D12	N12
D13	N13
D14	
D15	
D16	N16
D17	
D18	
D19	
D20	
D21	
D22	
D23	
D24	
D25	
D26	
D27	
D28	
D29	
D30	
D31	

Allocations

N1 – N31 indicates allocation to Network E1 Channels.

Figure 3-7. Example of Interface Worksheet with TS16 Reserved for Signaling

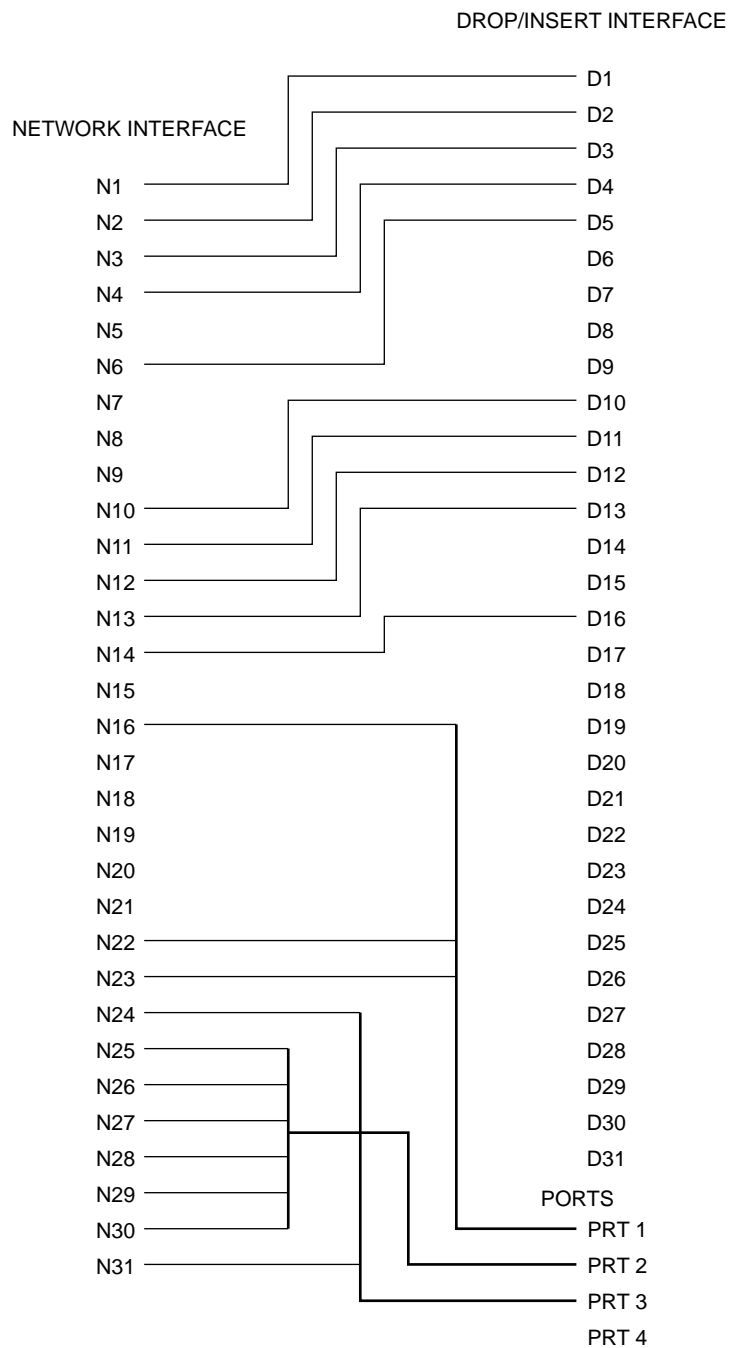

496-14898

Figure 3-8. Example of Channel Allocation with TS16 Available for Data

Network E1 Interface

Network Channel	Allocation
N1	D1
N2	D2
N3	D3
N4	D4
N5	
N6	D5
N7	
N8	
N9	
N10	D10
N11	D11
N12	D12
N13	D13
N14	D16
N15	
N16	Prt1
N17	
N18	
N19	
N20	
N21	
N22	Prt1
N23	Prt1
N24	Prt3
N25	Prt2
N26	Prt2
N27	Prt2
N28	Prt2
N29	Prt2
N30	Prt2
N31	Prt3

Allocations

D1 – D31 indicates allocation to DTE Drop/Insert channels.

Prt1 – Prt4 indicates allocation to synchronous data ports.

DTE Drop/Insert Interface

Drop/Insert Channel	Allocation
D1	N1
D2	N2
D3	N3
D4	N4
D5	N6
D6	
D7	
D8	
D9	
D10	N10
D11	N11
D12	N12
D13	N13
D14	
D15	
D16	N14
D17	
D18	
D19	
D20	
D21	
D22	
D23	
D24	
D25	
D26	
D27	
D28	
D29	
D30	
D31	

Allocations

N1 – N31 indicates allocation to Network E1 Channels.

Figure 3-9. Example of Interface Worksheet with TS16 Available for Data

Port Chan Conf	Options		Value
Port 1	Assign To		NET, DTE, Prt2, Prt3, Prt4
	Assign By		Block, Chan
	If Assign By Block	Port Rate	Nx64: 64, 128, 192, 256, 320, 384, 448, 512, 576, 640, 704, 768, 832, 896, 960, 1024, 1088, 1152, 1216, 1280, 1344, 1408, 1472, 1536, 1600, 1664, 1728, 1792, 1856, 1920, 1984 Nx56: 56, 112, 168, 224, 280, 336, 392, 448, 504, 560, 616, 672, 728, 784, 840, 896, 952, 1008, 1064, 1120, 1176, 1232, 1288, 1344, 1400, 1456, 1512, 1568, 1624, 1680, 1736 NOTE: If time-slot 16 is reserved for signaling, the highest port rate (1984 or 1736) does not appear.
		Start At	Time Slot (Nn or Dn): 1, 2, 3, 4, 5, 6, 7, 8, 9, 10, 11, 12, 13, 14, 15, 16, 17, 18, 19, 20, 21, 22, 23, 24, 25, 26, 27, 28, 29, 30, 31 (Select One)
	If Assign By Chan		Time Slot (Nn or Dn): 1, 2, 3, 4, 5, 6, 7, 8, 9, 10, 11, 12, 13, 14, 15, 16, 17, 18, 19, 20, 21, 22, 23, 24, 25, 26, 27, 28, 29, 30, 31 (Select Multiple)
Port 2	Assign To		NET, DTE, Prt1, Prt3, Prt4
	Assign By		Block, Chan
	If Assign By Block	Port Rate	Nx64: 64, 128, 192, 256, 320, 384, 448, 512, 576, 640, 704, 768, 832, 896, 960, 1024, 1088, 1152, 1216, 1280, 1344, 1408, 1472, 1536, 1600, 1664, 1728, 1792, 1856, 1920, 1984 Nx56: 56, 112, 168, 224, 280, 336, 392, 448, 504, 560, 616, 672, 728, 784, 840, 896, 952, 1008, 1064, 1120, 1176, 1232, 1288, 1344, 1400, 1456, 1512, 1568, 1624, 1680, 1736 NOTE: If time-slot 16 is reserved for signaling, the highest port rate (1984 or 1736) does not appear.
		Start At	Time Slot (Nn or Dn): 1, 2, 3, 4, 5, 6, 7, 8, 9, 10, 11, 12, 13, 14, 15, 16, 17, 18, 19, 20, 21, 22, 23, 24, 25, 26, 27, 28, 29, 30, 31 (Select One)
	If Assign By Chan		Time Slot (Nn or Dn): 1, 2, 3, 4, 5, 6, 7, 8, 9, 10, 11, 12, 13, 14, 15, 16, 17, 18, 19, 20, 21, 22, 23, 24, 25, 26, 27, 28, 29, 30, 31 (Select Multiple)

Figure 3-10. Port Channel Configuration Worksheet (Ports 1 and 2)

Port Chan Conf	Options		Value
Port 3	Assign To		NET, DTE, Prt1, Prt2, Prt4
	Assign By		Block, Chan
	If Assign By Block	Port Rate	Nx64: 64, 128, 192, 256, 320, 384, 448, 512, 576, 640, 704, 768, 832, 896, 960, 1024, 1088, 1152, 1216, 1280, 1344, 1408, 1472, 1536, 1600, 1664, 1728, 1792, 1856, 1920, 1984 Nx56: 56, 112, 168, 224, 280, 336, 392, 448, 504, 560, 616, 672, 728, 784, 840, 896, 952, 1008, 1064, 1120, 1176, 1232, 1288, 1344, 1400, 1456, 1512, 1568, 1624, 1680, 1736 NOTE: If time-slot 16 is reserved for signaling, the highest port rate (1984 or 1736) does not appear.
		Start At	Time Slot (Nn or Dn): 1, 2, 3, 4, 5, 6, 7, 8, 9, 10, 11, 12, 13, 14, 15, 16, 17, 18, 19, 20, 21, 22, 23, 24, 25, 26, 27, 28, 29, 30, 31 (Select One)
	If Assign By Chan		Time Slot (Nn or Dn): 1, 2, 3, 4, 5, 6, 7, 8, 9, 10, 11, 12, 13, 14, 15, 16, 17, 18, 19, 20, 21, 22, 23, 24, 25, 26, 27, 28, 29, 30, 31 (Select Multiple)
Port 4	Assign To		NET, DTE, Prt1, Prt2, Prt3
	Assign By		Block, Chan
	If Assign By Block	Port Rate	Nx64: 64, 128, 192, 256, 320, 384, 448, 512, 576, 640, 704, 768, 832, 896, 960, 1024, 1088, 1152, 1216, 1280, 1344, 1408, 1472, 1536, 1600, 1664, 1728, 1792, 1856, 1920, 1984 Nx56: 56, 112, 168, 224, 280, 336, 392, 448, 504, 560, 616, 672, 728, 784, 840, 896, 952, 1008, 1064, 1120, 1176, 1232, 1288, 1344, 1400, 1456, 1512, 1568, 1624, 1680, 1736 NOTE: If time-slot 16 is reserved for signaling, the highest port rate (1984 or 1736) does not appear.
		Start At	Time Slot (Nn or Dn): 1, 2, 3, 4, 5, 6, 7, 8, 9, 10, 11, 12, 13, 14, 15, 16, 17, 18, 19, 20, 21, 22, 23, 24, 25, 26, 27, 28, 29, 30, 31 (Select One)
	If Assign By Chan		Time Slot (Nn or Dn): 1, 2, 3, 4, 5, 6, 7, 8, 9, 10, 11, 12, 13, 14, 15, 16, 17, 18, 19, 20, 21, 22, 23, 24, 25, 26, 27, 28, 29, 30, 31 (Select Multiple)

Figure 3-11. Port Channel Configuration Worksheet (Ports 3 and 4)

Displaying DS0 Channel Assignments

Use the Display command (in the Channel Configuration branch) to view how the DS0 channels are currently allocated.

Line 1 of the display shows the 31 channels of the selected interface. Pressing \leftarrow or \rightarrow scrolls the next three channels onto the LCD. Line 2 displays what is allocated to the DS0 channel listed in Line 1. Symbols used in the display are shown in Table 3-5.

Table 3-5
Display Channel Symbols

Symbol	Meaning
-	The DS0 channel is not allocated.
Prt <i>n</i>	The DS0 channel is allocated to Port <i>n</i> , where <i>n</i> is 1, 2, 3, or 4.
N <i>n</i>	The DS0 channel is allocated to the Network E1 interface DS0 channel <i>n</i> , where <i>n</i> can be any number from 1 through 31.
D <i>n</i>	The DS0 channel is allocated to the DTE Drop/Insert interface DS0 channel <i>n</i> , where <i>n</i> can be any number from 1 through 31.

To display the DS0 channel allocation,

1. Press F3 to select Cnfig from the top-level menu screen.
2. Select the configuration option set to be copied into the Edit area by using the appropriate Function key. Use the scroll keys, if necessary.
3. Press F1 to select Edit.
4. Press the \rightarrow key from the Edit screen to display the Chan selection.

5. Select Chan.

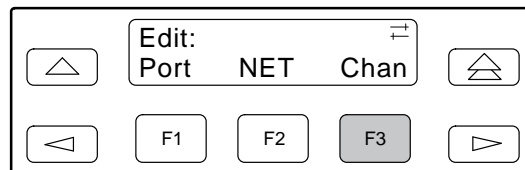

6. From the Channel Config screen, select Dsply (display).

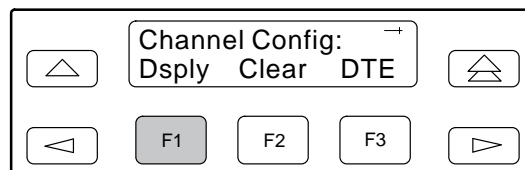

7. From the Display Chan screen, select NET to display the channels allocated to the Network E1 interface.

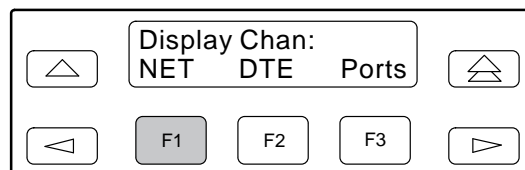

Or, select DTE to display the channels allocated to the DTE Drop/Insert interface.

NOTE

DTE does not appear when the DTE Drop/Insert interface is disabled.

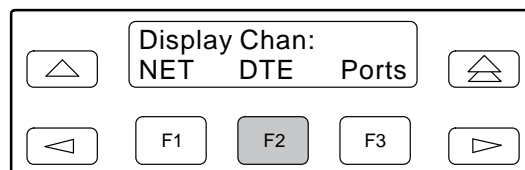

8. If you selected NET the channels allocated to the Network E1 interface are displayed. Line 1 displays the 31 channels for the Network E1 interface, while Line 2 displays what is allocated to the DS0 channel shown in Line 1. Pressing the ◀ or ▶ key scrolls the channels onto the screen in groups of three.

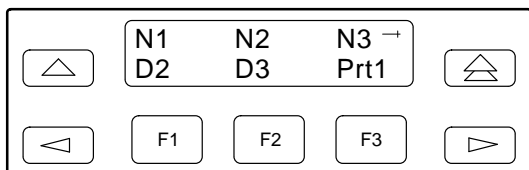

If you selected DTE, the channels allocated to the DTE Drop/Insert interface are displayed. Line 1 displays the 31 channels for the DTE Drop/Insert interface, while Line 2 displays what is allocated to the DS0 channel shown in Line 1.

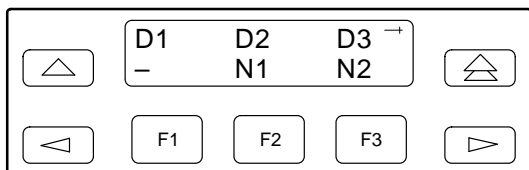

Allocating Data Ports

Assign a specific port (Prt1 and Prt2 for Model 3172, Prt1 through Prt4 for Model 3174) to DS0 channels on either the Network interface or the DTE Drop/Insert interface by using the configuration options. The following methods are available to assign DS0 channels to the port:

Block – Allows a block of contiguous channels to be assigned by specifying a data port rate and an initial DS0 channel (the first DS0 channel in a block of DS0 channels). The number of channels assigned is determined by the port rate. Only those initial DS0 channel numbers that provide enough bandwidth (based on the port’s data rate) are displayed on the screen. These channels are automatically assigned to the destination E1 interface when the initial DS0 channel is selected.

Chan – Individually selects the DS0 channels to allocate to the data port. The data port rate is automatically determined based on the number of channels selected.

Once a port is selected, you have access to configuration options to complete the port allocation procedure. These configuration options enable you to,

- Assign the selected port to the desired interface
- Select the desired method for channel allocation
- Select the port rate and starting channel (if the allocation method is block)
- Select the specific channels if the allocation method is by individual channel

These configuration options are explained in detail in Appendix C.

To select the data port,

1. Press F3 to select Cnfig from the top-level menu screen.
2. Select the configuration option set to be copied into the Edit area by using the appropriate Function key. Use the scroll keys, if necessary.
3. Press F1 to select Edit.
4. Press the ▶ key from the Edit screen to display the Chan selection.
5. Select Chan.

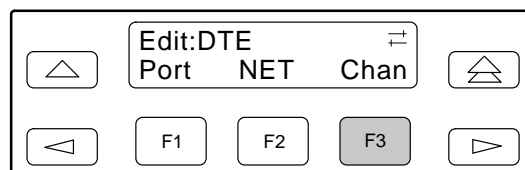

6. From the Channel Config screen, press the ▶ key to scroll the ports onto the screen.

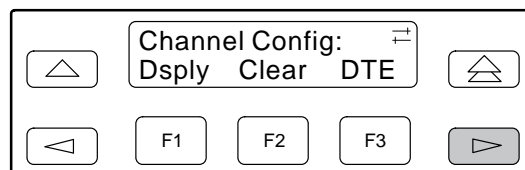

7. Select the desired port by pressing its corresponding Function key.

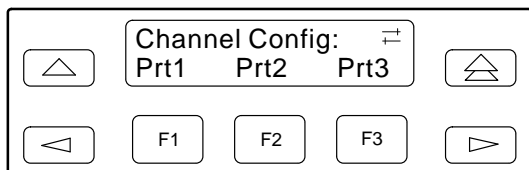

2. Press F1 (Next) to display the next configuration option (Port Rate).

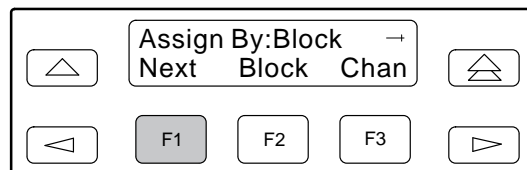

8. The configuration option for the data port channel allocation destination appears on the screen. Select NET to assign this port to the Network E1 interface, select DTE to assign this port to the DTE Drop/Insert interface, or press the > key and the appropriate Function key to assign this port to another port.

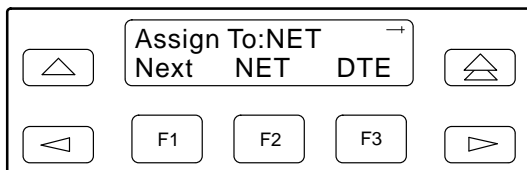

3. Use the < or > key to scroll the desired port rate onto the screen. Rates scroll in groups of three. Available selections depend on the current base rate selected for the port. Press the corresponding Function key to select the port rate. Then, select Next to display the Start At configuration option on the screen.

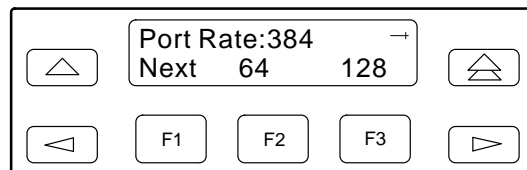

9. Press F1 (Next) to display the appropriate configuration options on the screen. Use one of the following examples, depending on whether you are assigning by block or individual channel.

4. The Start At screen displays the configuration option used to select the starting DS0 channel. If the destination selected is the Network E1 interface, then the Network channels appear on the screen. If the destination selected is the DTE Drop/Insert interface, then these channels appear on the screen.

Block Channel Assignment Method

The Assign By configuration option screen appears after you select a port.

To assign by the block method,

1. Press F2 (Block).

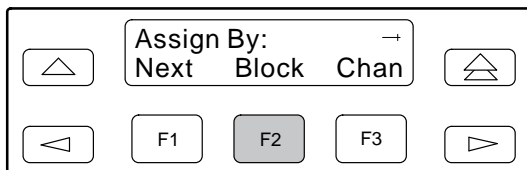

The following screen shows an example of the Network E1 interface. Use the < or > key to scroll the desired channel onto the screen. Use the Function keys to select the starting channel. Only those DS0 channel numbers that provide enough bandwidth (based on the configured data rate) to be used as a starting channel number are displayed. Channel allocation for this port can only be cleared by selecting Clear.

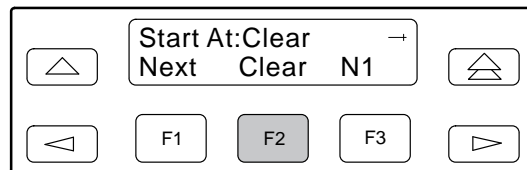

Individual Channel Assignment Method

The Assign By configuration option screen appears after you select a port.

To assign by the individual channel method,

1. Press F3 (Chan).

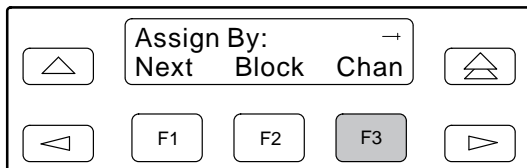

2. Press F1 (Next) to display the next configuration option (channel allocation).
3. Line 1 displays the 31 channels for the Network E1 interface or the DTE Drop/Insert interface, depending on which destination was chosen. This example assumes that the Network E1 interface is the destination. Line 2 displays what is allocated to the DS0 channel shown in Line 1. Pressing the < or > key scrolls the channels onto the screen in groups of three. Select the channel by pressing the Function key under the desired number. Port*n* appears. The port is assigned to that channel. To deallocate a port, press the Function key under that port number. Pressing the Function key under channels assigned to other ports has no effect.

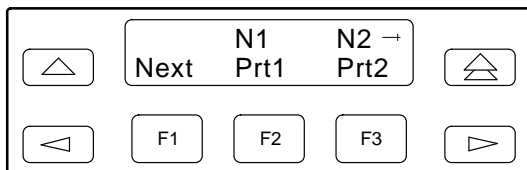

NOTE
 N16 will not appear if time-slot 16 (TS16) is reserved for signaling. (This is the default for TS16.)

Allocating DS0 Channels from the Drop/Insert Interface to the Network Interface

You can allocate DS0 channels from the DTE Drop/Insert interface to the Network interface and specify whether time-slot 16 (TS16) is reserved for signaling information.

To allocate DS0 channels from the DTE Drop/Insert interface to the Network interface,

1. Press F3 to select Cnfig from the top-level menu screen.
2. Select the configuration option set to be copied into the Edit area by using the appropriate Function key. Use the scroll keys, if necessary.
3. Press F1 to select Edit.
4. Press the > key from the Edit screen to display the Chan selection.
5. Select Chan.

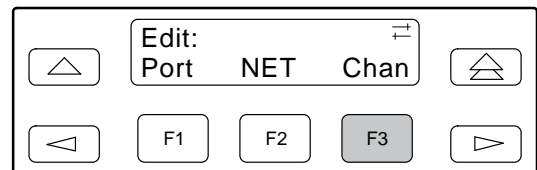

6. From the Channel Config screen, press F3 to select DTE.

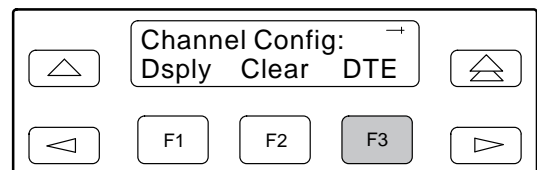

7. From the DTE Channels screen, press F1 to select TS16.

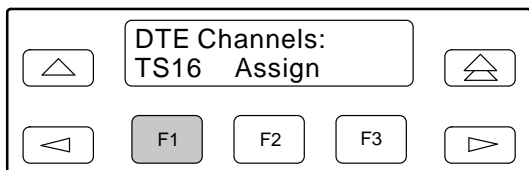

10. From the DTE Channels screen, press F2 to select Assign.

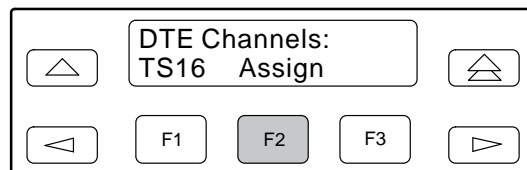

8. Rsvd (Reserved) is the default for TS16. This indicates that time-slot 16 is reserved for signaling information. Pressing F1 (Data) makes time-slot 16 available for data.

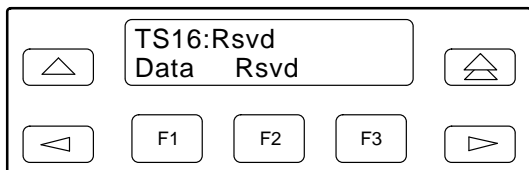

11. Press the Function key below the network channel desired. Each time that you press the Function key, the DTE channel number will scroll up one number. If the network channel is currently unassigned (“-” is displayed on Line 2), the DTE channel number initially displays the same number as the corresponding network channel number. However, if the network channel is currently assigned, the DTE channel number is shown as *Dn*. Pressing the Function key for D31 wraps the display back to D1. Only those channels that are not already assigned will appear on the LCD when scrolling. The network channels assigned to ports (Prt1...Prt4) are unavailable for assignment.

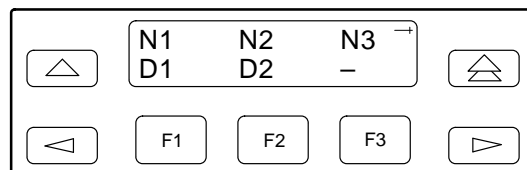

NOTE

If TS16 is reserved for signaling, D16 will automatically be assigned to N16, and DTE DS0 channels allocated to the network interface must be connected to the corresponding channel (e.g., D1 to N1, D2 to N2, etc.).

9. Press \triangle from the TS16 screen to return to the DTE Channels screen.

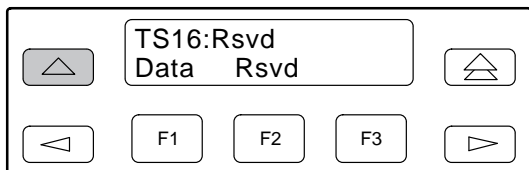

Clearing DS0 Channel Allocation

You can clear (deallocate) all the DS0 channels currently allocated to either the Network E1 interface, the DTE Drop/Insert interface, or the synchronous data ports.

To clear DS0 channel allocation,

1. Press F3 to select Cnfig from the top-level menu screen.
2. Select the configuration option set to be copied into the Edit area by using the appropriate Function key. Use the scroll keys, if necessary.
3. Press F1 to select Edit.
4. Press the \triangleright key from the Edit screen to display the Chan selection.
5. Select Chan.

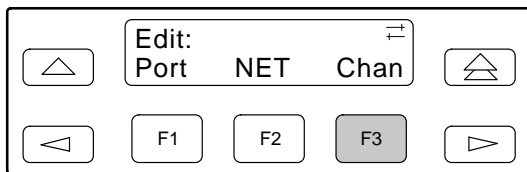

6. From the Channel Config screen, press F2 to select Clear.

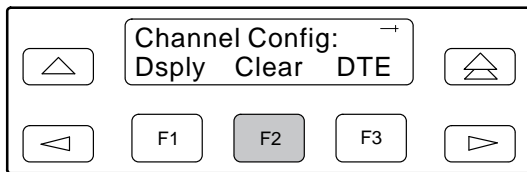

7. From the Clear Channel screen, select NET to clear all DS0 channels assigned to the Network E1 interface. Or, select DTE to clear all DS0 channels assigned to the DTE Drop/Insert interface. Or, select a port to clear all assignments for that data port.

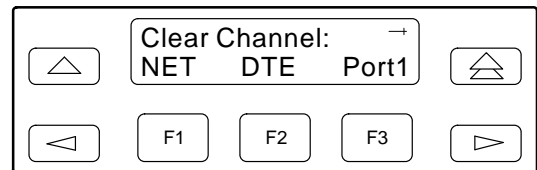

Providing Backup Capability

If the E1 network fails, the E1 DSU/CSU provides the ability to reconfigure the unit and restore (at least partially) priority data circuits through an external backup device.

You can store backup configuration options in the Customer 2 (Cust2) set of customer-defined configuration options. The Paradyne Enterprise MIB variable devConfigAreaCopy allows the entire contents of one configuration area to be copied into another configuration area via SNMP.

By cross-connecting two synchronous data ports to each other, one port can provide a backup path for the other. As soon as the ports are configured to be mapped to each other, Data Set Ready (DSR) for the ports is turned on. The external backup device can be configured to initiate dialing when it detects the off-to-on transition of DSR.

Selecting the Timing Source

The E1 DSU/CSU provides the ability to select a primary clock (timing) source that is used to synchronize all of the E1 and data port interfaces on the E1 DSU/CSU. The clock for each interface is at the appropriate rate for that interface (e.g., 2.048 Mbps for the E1 interfaces, the configured port rate for the data ports) and is independent of the primary clock rate. This means that the primary clock rate and the E1 DSU/CSU interface rates may be different.

The E1 DSU/CSU automatically falls back to the secondary clock when a failure of the selected primary clock is detected. If a secondary clock failure is detected, the E1 DSU/CSU falls back to its internal clock.

The clock source configuration options enable you to select either the Network E1 interface, a synchronous data port, the internal clock, the DTE Drop/Insert interface, or an external clock. If external clocking is selected, you must use the clock rate configuration option to specify the clock rate. Figure 3-12 shows some common clocking configurations. Two sample procedures for configuring timing are given in the following sections, *Configuring for Network Timing* and *Configuring for External Timing*. For more information on configuration options, refer to Appendix C.

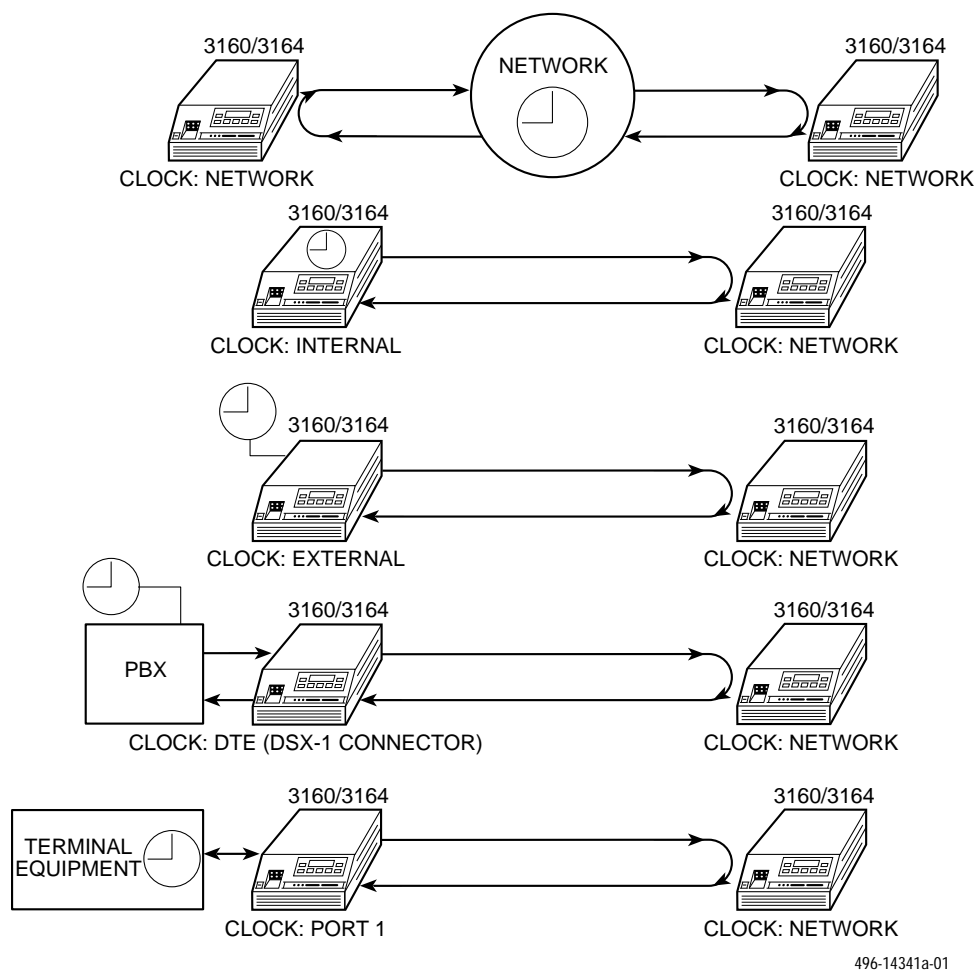

Figure 3-12. Common Clocking Configurations

496-14341a-01

Configuring for Network Timing

To configure for network timing,

1. Press F3 to select Cnfig from the top-level menu screen.
2. Select the configuration option set to be copied into the Edit area by using the appropriate Function key. Use the scroll keys, if necessary.
3. Press F1 to select Edit.
4. Press the \triangleright key from the Edit screen to display the Gen selection.
5. Select Gen for the general configuration options.

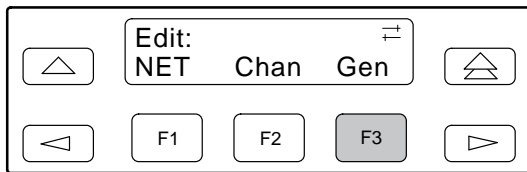

6. Select the primary clock source. For network, press F2 (note that network is also the default).

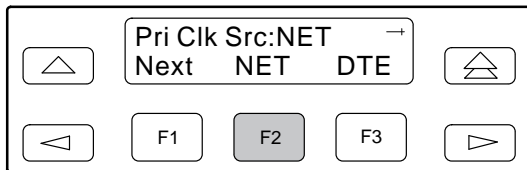

NOTE

The procedure for configuring the secondary clock source is similar to the example shown above. For more information on configuration options, refer to Appendix C.

Configuring for External Timing

To configure the E1 DSU/CSU for external timing,

1. Press F3 to select Cnfig from the top-level menu screen.
2. Select the configuration option set to be copied into the Edit area by using the appropriate Function key. Use the scroll keys, if necessary.
3. Press F1 to select Edit.
4. Press the \triangleright key from the Edit screen to display the Gen selection.
5. Select Gen for the general configuration options.

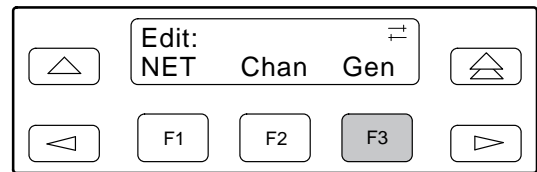

6. Select the primary clock source. For external, press the \triangleright key until the Ext selection scrolls onto the screen.

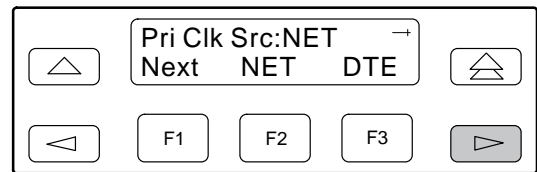

7. Press the appropriate Function key to select external timing.

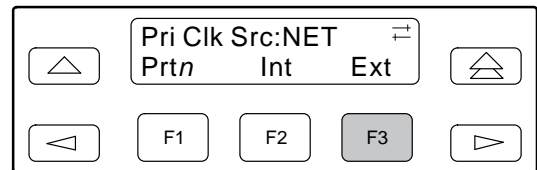

8. Select the appropriate external clock rate by pressing the corresponding Function key. This step is mandatory if you have chosen external clocking.

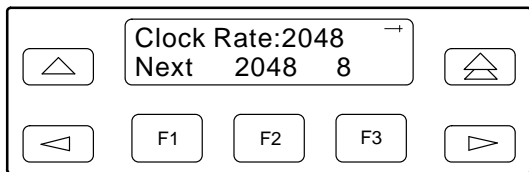

Acquiring/Releasing the User Interface

You can access the user interface from either the front panel or the COM port. The E1 DSU/CSU allows only one user interface to be active at a time. The front panel is the default user interface at power-up or after a reset. It is also the default during a software download or when a failure occurs at either the local or remote PC interface.

You can switch an inactive user interface to active if,

- The current active user interface has had no activity (no key was pressed) for at least five minutes, and/or
- The active user interface has been released with the Release command.

Acquiring the Active User Interface

To acquire the active user interface, press any key. If you are using the PC interface, use the mouse to click on the desired Function key.

The top-level menu screen appears on the active user interface, regardless of what screen was displayed at the previous active user interface.

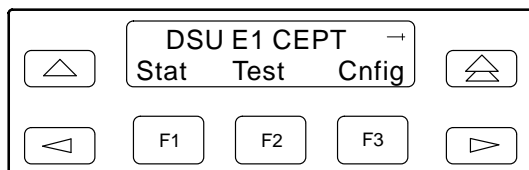

The inactive interface displays the following message when a Function key is pressed or a connection is made on the inactive user interface and control cannot be switched because the currently active interface is in use. On the screen, either Ft. Panel (front panel) or COM Port is displayed in the user interface (*User I/F*) field.

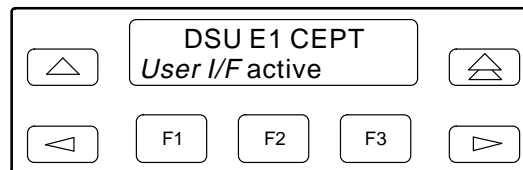

The inactive interface displays the following message after control has been released from the previously active interface and another interface has not become active.

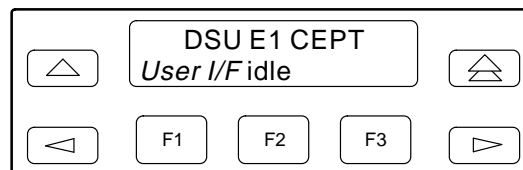

Releasing the Active User Interface

To release the current active user interface, either allow five minutes to elapse without pressing any key or use the Release command.

To use the Release command,

1. Press the \triangleright key on the top-level menu screen to bring the Ctrl branch onto the front panel LCD.

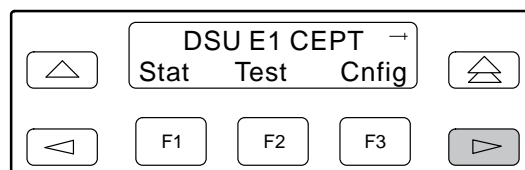

2. Press F3 to select Ctrl from the top-level menu screen.

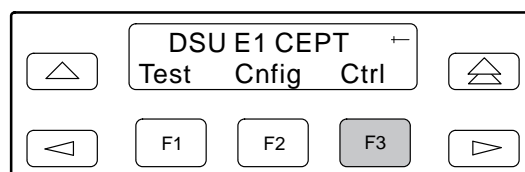

- From the Control screen, select Rel (Release).

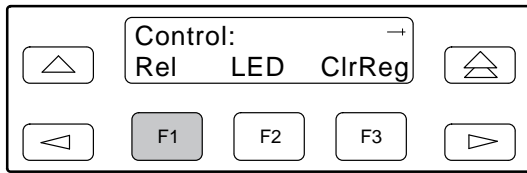

The active user interface is released. A screen with this message appears. No user interface is active until input is received from a user interface.

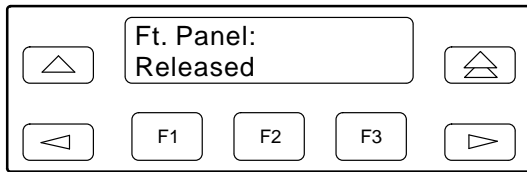

- Select Reset.

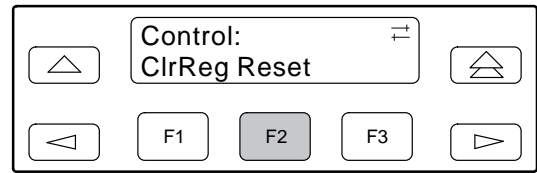

- From the Device Reset screen, press F1 to initiate a reset of the E1 DSU/CSU (the power-up sequence screen appears). Press F2 instead to return to the Control screen without initiating a reset.

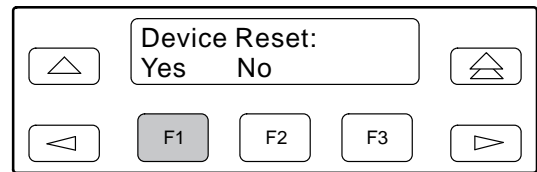

Resetting the E1 DSU/CSU

Use the Reset command to perform a power-on reset of the E1 DSU/CSU.

To reset the E1 DSU/CSU,

- Press the \triangleright key once to display the Ctrl selection on the top-level menu screen.

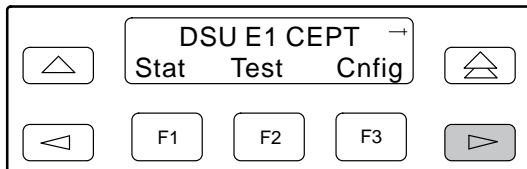

- Press F3 to select Ctrl from the top-level menu screen.
- From the Control screen, press the \triangleright key until the Reset selection appears on the screen.

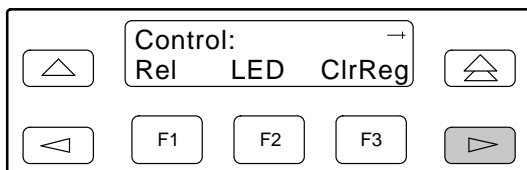

Download Operations

NOTE

The Download command is for use by service personnel only. Loss of primary data could result from improper use.

E1 DSU/CSU User Interface Access Security

NOTE

This page of the manual is self-supporting and can be removed to prevent unwanted knowledge of the security access levels and their selection.

The user interface access security option allows you to limit access to the E1 DSU/CSU to display-only and non-intrusive functions.

Level 1 (Lvl1) access security allows access to all functions available through the menu tree. This is the default setting.

Level 2 (Lvl2) access security restricts access to only those functions that cannot affect the operation of the E1 DSU/CSU in any way. At this level,

- None of the functions in the Test or Ctrl branches are available.
- All functions on the Stat branch are available.
- All functions on the Cnfig branch are available for display, but they cannot be used to save to a configuration area (Activ, Cust1, Cust2, or Fact).

You can only reach the screen that controls security access using the front panel.

Changing User Interface Access Security

To change user interface access security,

1. Press the  key two times from the top-level screen.

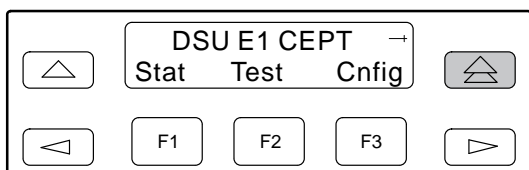

2. Press the  key three times.

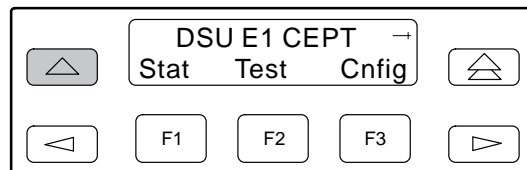

3. Press the  key once.

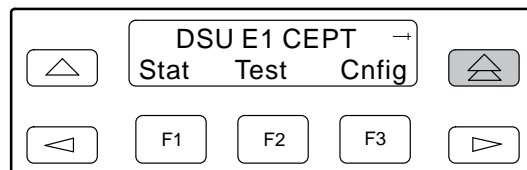

The Security screen appears.

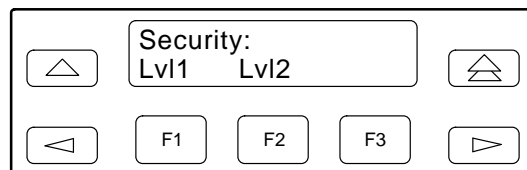

4. Press F1 to select Lvl1, or press F2 to select Lvl2. After you make a selection, the top-level screen appears.

If you do not make a selection within 5 minutes, the Automatic Device Health/Status screen appears.

Maintenance 4

Overview	4-2
Self-Test Health	4-2
Device Health and Status	4-3
Network Performance Reports	4-5
Alarms	4-9
SNMP Traps	4-10
Troubleshooting	4-11
Test Jacks	4-13
Test Commands	4-14
Remote Loopback Tests	4-14
Local Loopback Tests	4-15
Starting a Line Loopback	4-16
Starting a Payload Loopback	4-16
Starting a DTE Loopback	4-17
Starting a Repeater Loopback	4-17
Starting a Data Channel Loopback	4-18
Starting a Data Terminal Loopback	4-19
Aborting Loopbacks	4-19
Test Patterns	4-20
Sending Test Patterns	4-20
Monitoring Test Patterns on Individual Data Ports	4-22
Aborting Test Patterns	4-22
Lamp Test	4-23
Starting a Lamp Test	4-23
Aborting a Lamp Test	4-24
Displaying E1 DSU/CSU Test Status	4-24

Overview

The E1 DSU/CSU can detect and report faults, and perform diagnostic tests. These features ensure that your E1 DSU/CSU is giving you optimum performance in your network.

Self-Test Health

Use the Self-Test Health command to display the results of the power-up self-test. Possible messages are listed in Table 4-1. See Chapter 2, *Installation*, for more information about power-up self-test.

To display power-up self-test results,

1. Press F1 to select Stat from the top-level menu screen.

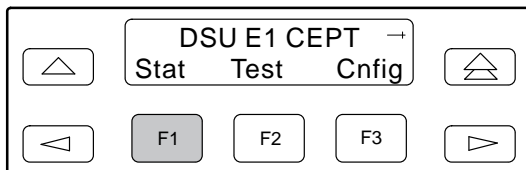

2. From the Status screen, press F2 to select STest.

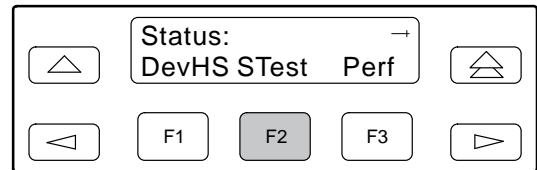

3. View the results of the last power-up self-test. If no problems were found during power-up, the following message appears.

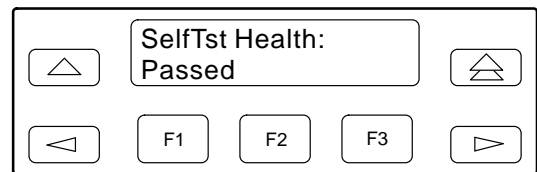

Table 4-1
Self-Test Health Messages

Message	Description
Passed	No problems were found during power-up.
CPU fail	The central processing unit failed internal testing.
DTE E1 fail	The unit failed to internally loop data on the DTE circuit.
Failure xxxxxxxx	An 8-digit hexadecimal failure code is provided for service personnel.
LCD fail	The front panel liquid crystal display (LCD) failed.
Memory fail	The unit failed program checksum verification.
NET E1 fail	The unit failed to internally loop data on the network circuit.
Device fail	One or more of the unit's integrated circuit chips failed to pass internal device level testing.
HDB3/LOS fail	The unit failed to encode data properly or to detect Loss Of Signal.
Alarm fail	The unit failed to transmit AIS or to detect an RAI alarm.
DSU fail	The unit failed to internally loop data on the DSU.
DSU Portn fail	Port's integrated circuitry failed to pass device internal testing.
Unknown Exp Dev	The unit is not able to recognize the expansion device connected to the main circuit card.

Device Health and Status

Use the Device Health and Status branch to view current health and status of the E1 DSU/CSU. When you access this branch, one or more status messages appear in priority order (highest to lowest) on Line 2 of the LCD. On the front panel, use the scroll keys to view any additional messages. Table 4-2 lists these messages in priority order.

The E1 DSU/CSU is polled for current status every ten seconds. If the status has changed from the last poll, the Health and Status screen is updated and the highest priority message is displayed. The message **DSU Operational** appears when there are no other messages.

To display device health and status,

1. Press F1 to select Stat from the top-level menu screen.

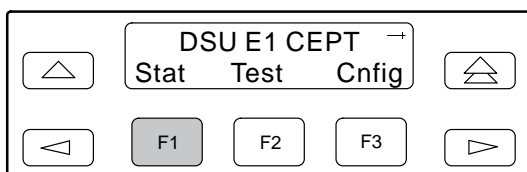

2. From the Status screen, press F1 to select DevHS.

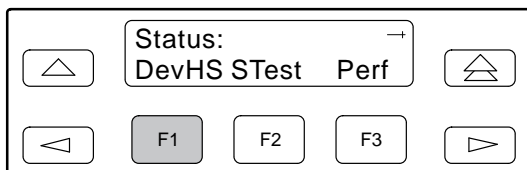

Alarm/status messages appear on Line 2 of the LCD in priority order (highest to lowest).

3. Use the scroll keys, if necessary, to scroll additional device health and status messages onto the LCD.

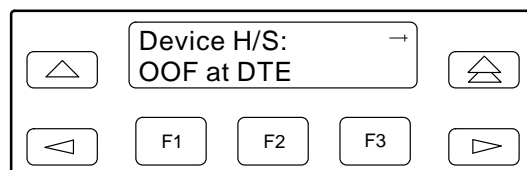

The Auto Device Health and Status screen appears when there is no activity (no keys pressed) on the active physical interface for five minutes. Only the highest priority message appears on Line 2 of the LCD.

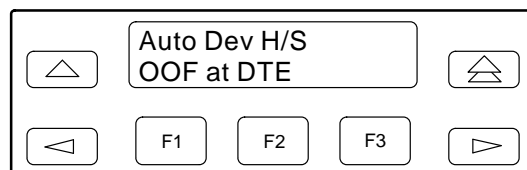

**Table 4-2
Health and Status Messages**

Message	Description
LOS at Net	A Loss Of Signal condition (declared after 175 consecutive zeros) has been detected on the network interface. The condition is cleared when the density of ones to zeros received is 12.5%.
LOS at DTE	A Loss Of Signal condition has been detected on the DTE Drop/Insert interface. The condition is cleared when the density of ones to zeros received is 12.5%.
OOF at Net	An Out Of Frame condition (3 consecutive errored frame alignment events or, in CRC4 mode, a lack of multiframe alignment) has been detected on the network interface. The condition is cleared when a reframe occurs.
OOF at DTE	An Out Of Frame condition has been detected on the DTE Drop/Insert interface. The condition is cleared when a reframe occurs.
AIS at Net	An Alarm Indication Signal (unframed all ones signal) is being received by the network interface.
AIS at DTE	An Alarm Indication Signal is being received by the DTE Drop/Insert interface.
EER at Net	An Excessive Error Rate condition has been detected on the network interface (the bit error rate is 10E-3 or greater for 5 seconds). The condition is cleared when the error rate falls below the threshold value (10E-4) for 5 seconds.
RAI at Net	A Remote Alarm Indication is being received by the network interface.
RAI at DTE	A Remote Alarm Indication is being received by the DTE Drop/Insert interface.
Primary Clk fail	The primary clock has failed. Timing for the E1 DSU/CSU is provided by the secondary clock.
Second Clk fail	The primary clock and the secondary clock have failed. Timing for the E1 DSU/CSU is provided by the internal clock.
OOF at Prtn	An Out Of Frame has been detected on data port Prtn (where <i>n</i> is the port number: 1–2 for the 3172, or 1–4 for the 3174). This condition only occurs if the synchronous data port's Embedded Data Link (EDL) is enabled.
EER at Prtn	The error rate of the received signal has exceeded the configured threshold for data port Prtn (where <i>n</i> is the port number: 1–2 for the 3172, or 1–4 for the 3174). This condition only occurs if the synchronous data port's Embedded Data Link (EDL) is enabled. The condition is cleared when the error rate falls below the synchronous data port's configured threshold value.
PORT SNMP Down	The SNMP management link is in a down state for <i>PORT</i> (where <i>PORT</i> is COM or AUX). This condition occurs if the <i>PORT</i> is configured for SNMP, and communication between the management system and the E1 DSU/CSU is not currently possible for this port. For the AUX port, this condition is detected only when a device reset or power-up occurs.
Selftest failed	A failure was detected during the power-on self-test. Select STest (in the Stat branch) to display more information about the failure.
DevFail #####	An internal error has been detected by the operating software. An 8-digit code appears for use by service personnel. The condition is cleared by resetting the device.
Download failed	A download attempt was interrupted and failed to complete. The condition is cleared by resetting the device.
Test in progress	A test is currently active. Select Tstat (in the Stat branch) to display more test information.
DSU Operational	This message only appears if there are no valid alarm or status messages.

Network Performance Reports

Network performance is continuously monitored and maintained in network aggregate registers (NET) and, if configured for EDL, in far-end and near-end port registers.

Network aggregate registers (NET) are status registers that collect performance data for the previous 24-hour period. Registers shown on the front panel LCD are listed in Table 4-3. Aggregate data is updated in 15-minute intervals. After 15 minutes, the current interval is rolled over into a set of accumulator registers that represent the previous 96 15-minute intervals for the register. An interval total of how many of the 96 registers contain valid data is also kept, as well as a 24-hour total for each accumulator register.

Network port performance is continuously monitored and maintained in internal memory registers when the port interface is configured to use EDL. The E1 DSU/CSU maintains two sets of port registers for each synchronous data port: far-end port registers and near-end port registers. These registers are status registers that collect performance data for the previous 8-hour period. Registers shown on the front panel LCD are listed in Table 4-3. Port data is updated in 15-minute intervals. After 15 minutes, the current interval is rolled over into a set of accumulator registers that represent the previous 32 15-minute intervals for the register. An interval total of how many of the 32 registers contain valid data is also kept, as well as a 8-hour total for each accumulator register.

To display a network aggregate (NET) Performance Report on the front panel LCD,

1. Press F1 to select Stat from the top-level menu screen.

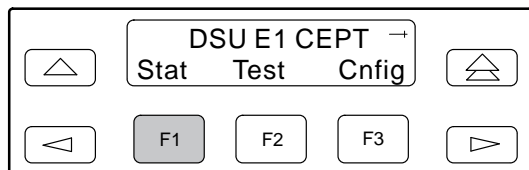

2. From the Status screen, select Perf.

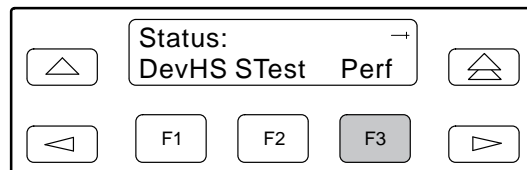

3. Select NET registers.

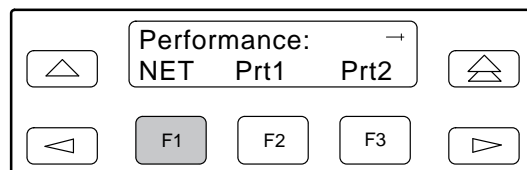

4. From the NET Registers screen, press F1 to view current registers (go to Step 5), press F2 to view 24-Hour Totals (go to Step 6), or press F3 to view 15-Minute Interval Registers (go to Step 7).

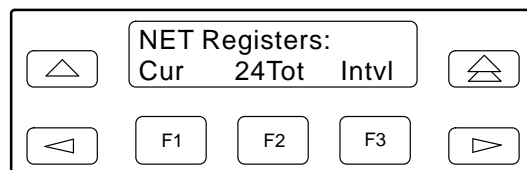

5. When you press F1 from the NET Registers screen, the NET registers for the current 15-minute interval appear.

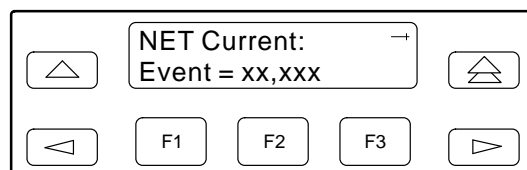

6. When you press F2 from the NET Registers screen, the NET registers for the 24-hour total interval appear.

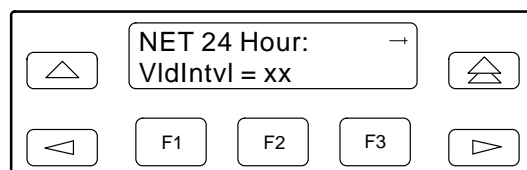

- When you press F3 from the NET Registers screen, the interval screen appears. Use this screen to choose the specific 15-minute interval.

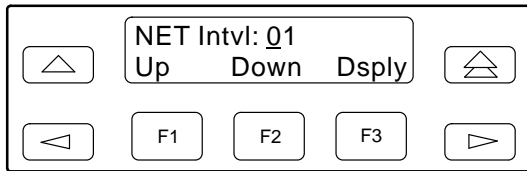

- Use the \triangleleft and \triangleright keys to position the cursor under the first or second digit in the interval number displayed, then use the F1 (Up) and F2 (Down) keys to increment/decrement the number.
- When you have selected the number of the interval you want to display, press F3 (Dsply) to display the registers for the interval selected.

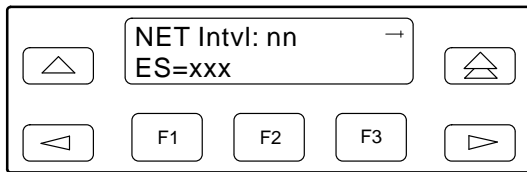

- Use the scroll keys to view additional register information.

You can reset the network registers from the E1 DSU/CSU via the ClrReg command in the Control branch of the front panel menu.

To clear the user performance registers,

- Press the \triangleright key on the top-level menu screen to bring the Ctrl branch onto the front panel LCD.

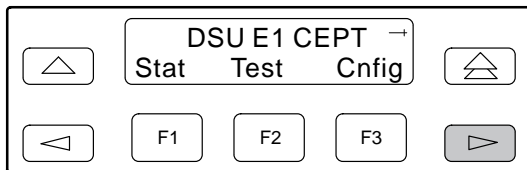

- Press F3 to select Ctrl from the top-level display screen.

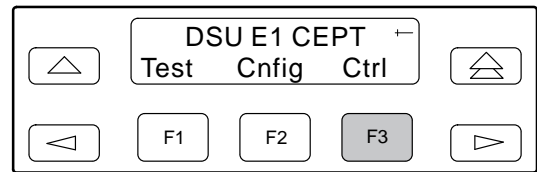

- Select ClrReg.

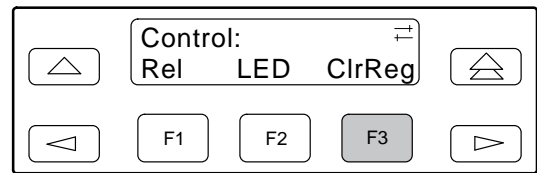

- From the Clear Prf Regs screen, press F1 to clear the NET registers.

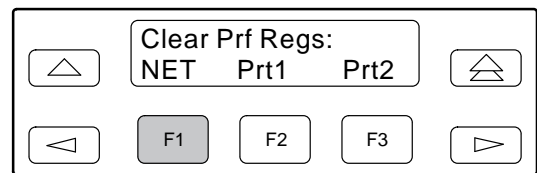

If you selected NET, the network performance registers are cleared. All accumulators are reset to zero and all status registers are cleared, and the current interval timer, the number of valid intervals count and the total 24-hour counts are reset to zero. The Command Complete screen then appears.

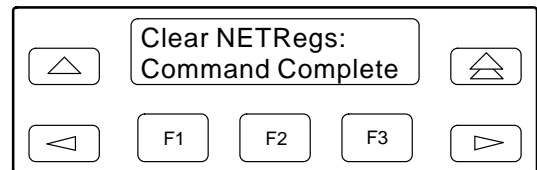

**Table 4-3
(1 of 2)
Performance Registers**

Register	Interval Description	Totals Description
Event	Error events counter. An error event is a frame with either a Cyclic Redundancy Check (CRC) error or an Out Of Frame (OOF) event. The maximum count is 65,535. This register is only reset as a result of a Clear Performance Register command. This register is valid for the current interval only.	N/A
CurTimer	Current interval timer. This register records the number of seconds in the current 15-minute interval. The maximum is 900 seconds. This register is valid for the current interval only.	N/A
VldIntvl	N/A	Valid interval total. Records the number of valid 15-minute intervals in the previous x hours, where x is 24 hours for aggregate performance and 8 hours for port performance. This register is not valid for the current interval.
ES	The number of errored seconds for the current interval. An errored second is any second with one or more of the following: errored frame alignment, CRC error, Loss of Signal (LOS), Alarm Indication Signal (AIS), or Loss of Frame (LOF). The maximum is 900 seconds.	The total number of errored seconds for the previous x hours, where x is 24 hours for aggregate performance and 8 hours for port performance.
UAS	The number of unavailable seconds for the current interval. An unavailable second is any one second interval when service is unavailable. The maximum is 900 seconds.	The total number of unavailable seconds for the previous x hours, where x is 24 hours for aggregate performance and 8 hours for port performance. (Detection occurs with 10 consecutive unavailable seconds.)
SES	The number of severely errored seconds for the current interval. For E1 or DTE registers, a severely errored second is any second with 805 or more CRC errors, 16 or more errored frame alignment signal events, or one or more LOS, AIS, or OOF event. For port registers, a severely errored second is any second with 320 or more CRC errors, or one or more OOF event. The maximum is 900 seconds.	The total number of severely errored seconds for the previous x hours, where x is 24 hours for aggregate performance and 8 hours for port performance.
BES	The number of bursty errored seconds for the current interval. For E1 or DTE registers, a bursty errored second is any second with more than one, but less than 805, CRC errors when in CRC4 mode, or more than one, but less than 16, errored frame alignment signals when in non-CRC4 mode. For port registers, a bursty errored second is any second with more than one, but less than 320, CRC errors. The maximum is 900 seconds.	The total number of bursty errored seconds for the previous x hours, where x is 24 hours for aggregate performance and 8 hours for port performance.

**Table 4-3
(2 of 2)
Performance Registers**

Register	Interval Description	Totals Description
LOFC	The loss of frame count for the current interval. This is a count of the number of times that an LOF is declared. An LOF is declared when a continuous out of frame condition persists for more than 2.5 seconds. The maximum loss of frame count is 255.	The total loss of frame count for the previous <i>x</i> hours, where <i>x</i> is 24 hours for aggregate performance and 8 hours for port performance.
StEvt (Only valid for aggregate performance.)	The status events register records whether one or more of the following events have occurred at least once during the interval. The event is identified by a letter as follows: R – A Remote Alarm Indication has been received on the network interface. L – Loss Of Signal has occurred on the network interface. E – The Excessive Error Rate threshold has been exceeded. F – A Frame Synchronization Bit Error has been detected. V – A Bipolar Violation has been detected. If none of these events occurred during the interval, StEvt=none will be displayed.	N/A
Complete (Only valid for far-end port performance.)	Bad E1 conditions or loopback tests may prevent far-end port statistics from reaching the E1 DSU/CSU. This field indicates whether the 15-minute interval contains 900 seconds of statistics. If one or more seconds of far-end statistics are missing, this field will display Complete=No, otherwise it will display Complete=Yes. This field is only displayed when Far is selected from the Prtn screen.	N/A

Alarms

The E1 DSU/CSU can be attached, either locally or remotely, to an ASCII terminal or printer to display or print alarm messages. The Communications (COM) port can be used as the destination for Alarm Set and Alarm Clear messages. This enables an ASCII terminal or printer to monitor the E1 DSU/CSU for alarm conditions. Alarms can also be displayed on a PC that is using a terminal emulation package.

Each alarm message contains a customer identification to indicate which remote E1 DSU/CSU is reporting an alarm. For information about customer identification, refer to the *Displaying Unit Identity* section in Chapter 3, *Operation*.

Possible alarm messages are as follows:

- **Continuous Loss Of Signal detected at the x Interface** (where x is either Network or DTE).
- **Alarm Cleared. Loss of Signal condition at the x Interface** (where x is either Network or DTE).
- **Continuous Out Of Frame condition detected at the x Interface** (where x is either Network or DTE).
- **Alarm Cleared. Out of Frame condition at the x Interface** (where x is either Network or DTE).
- **Alarm Indication Signal received at the x Interface** (where x is either Network or DTE).
- **Alarm Cleared. Alarm Indication Signal at the x Interface** (where x is either Network or DTE).
- **An Excessive Error Rate has been detected at the Network Interface.**
- **Alarm Cleared. An Excessive Error Rate at the Network Interface.**
- **Remote Alarm Indication signal received at the x Interface** (where x is either Network or DTE).
- **Alarm Cleared. Remote Alarm Indication signal at the x Interface** (where x is either Network or DTE).
- **Continuous Out Of Frame condition detected at synchronous data port n** (where n is the port number: 1–2 for Model 3172 DSU/CSUs, or 1–4 for Model 3174 DSU/CSUs).
- **Alarm Cleared. Out Of Frame condition at synchronous data port n** (where n is the port number: 1–2 for Model 3172 DSU/CSUs, or 1–4 for Model 3174 DSU/CSUs).
- **An Excessive Error Rate has been detected at synchronous data port n** (where n is the port number: 1–2 for Model 3172 DSU/CSUs, or 1–4 for Model 3174 DSU/CSUs).
- **Alarm Cleared. An Excessive Error Rate at synchronous data port n** (where n is the port number: 1–2 for Model 3172 DSU/CSUs, or 1–4 for Model 3174 DSU/CSUs).

If two alarm conditions are detected at once, the higher priority alarm is reported. However, if an even higher priority alarm is detected before the first alarm is cleared, the later alarm is not reported. (The alarms listed above are in priority order with the highest priority listed first.)

Alarms remain active until the alarm condition is cleared. Also, an alarm clear message is only sent when there are no other alarms active.

For information about alarm configuration options, refer to the *Alarm Configuration Options* section in Appendix C, *Configuration Options*.

For troubleshooting information, refer to the *Troubleshooting* section on page 4-11.

SNMP Traps

A trap is an unsolicited message that is sent from the E1 DSU/CSU to an SNMP manager when the device detects certain, pre-specified conditions. These traps enable the SNMP manager to monitor the state of the network.

The SNMP Trap configuration option must be enabled for trap messages to be sent over the communications link. You must specify the number of SNMP managers that are to receive traps from this device, an IP address for each SNMP manager specified, and the type of traps to be sent from this device. For more information, refer to Appendix C, *Configuration Options*, and the *Configuring SNMP Traps* section in Chapter 3, *Operation*.

Trap types consist of the following:

- **General traps** – include warmStart and authenticationFailure. The device sends a warmStart trap after it has been reset to indicate that it has just reinitialized itself. The device sends an authenticationFailure trap when it has received an SNMP protocol message that has not been properly authenticated. These traps are set by the Gen Trap configuration option.
- **Enterprise Specific traps** – signify that the device has recognized an enterprise-specific event. See Table 4-4 for enterprise-specific traps. These traps are set by the Entp Trap configuration option.
- **Link Traps** – identify the condition of the communications interface, either linkDown (one of the communications interfaces has failed) or linkUp (one of the communications interfaces has just come up). These traps are set by the Link Trap configuration option. The communications interfaces for which these traps can be generated are specified by the Trap I/F configuration option. Table 4-5 defines traps for each interface.

Table 4-4
Enterprise-Specific Trap Definitions

Trap Value	Event
enterpriseClockFail(1)	The currently configured primary clock source has failed.
enterpriseSelfTestFail(2)	A device hardware failure is detected at self-test. This trap is generated after device initialization.
enterpriseDeviceFail(3)	An internal device failure is detected by the operating software.
enterpriseSecClockFail(4)	The currently configured secondary clock source has failed.

Table 4-5
SNMP Trap per Interface

Interface	Trap Meaning
Network E1	Up = No alarm conditions. Down = Alarm conditions.
DTE Drop/Insert	Up = No alarm conditions and interface is enabled. Down = Alarm conditions or interface is disabled.
Synchronous Data Ports	Up = Port assigned to a network interface and both CTS and DSR are ON. Down = Port unassigned or either CTS or DSR are off.

Troubleshooting

The E1 DSU/CSU is designed to provide you with many years of trouble-free service. However, Table 4-6 gives you some direction if a problem occurs. For

problems other than those listed in the table, please contact your service representative.

**Table 4-6
(1 of 2)
Troubleshooting**

Symptom	Possible Cause	Solutions
No power	<ol style="list-style-type: none"> 1. The power cord is not securely plugged into the wall receptacle or rear panel connector. 2. The wall receptacle has no power. 	<ol style="list-style-type: none"> 1. Check that the power cord is securely attached at both ends. 2. Check the wall receptacle power by plugging in some equipment that is known to be working.
Power-Up Self-Test fails	The E1 DSU/CSU has detected an internal hardware failure.	Contact your field service representative.
Message LOS at Net appears	<ol style="list-style-type: none"> 1. Network cable problem. 2. No signal is being transmitted at the far-end E1 DSU/CSU. 3. E1 facility problem. 4. The 120 ohm interface is being used and the RX SHIELD switch is in the EARTH position. 	<ol style="list-style-type: none"> 1. Check that the network cable is securely attached at both ends. 2. Check the far-end E1 DSU/CSU status. 3. Contact your E1 facility provider. 4. Change the RX SHIELD switch to the OPEN position when using the 120 ohm interface.
Message LOS at DTE appears	<ol style="list-style-type: none"> 1. DTE Drop/Insert cable problem. 2. No signal being transmitted from the DTE. 	<ol style="list-style-type: none"> 1. Check that the DTE Drop/Insert cable is securely attached at both ends. 2. Check the DTE status.
Message OOF at Net appears	<ol style="list-style-type: none"> 1. Incompatible framing format between the network and the E1 DSU/CSU. 2. Network cabling problem. 3. E1 facility problem. 	<ol style="list-style-type: none"> 1. Check that the framing format for the network interface is correct. 2. Check that the network cable is securely attached at both ends. 3. Contact your E1 facility provider.
Message OOF at DTE appears	<ol style="list-style-type: none"> 1. Incompatible framing format between the Drop/Insert port on the customer premises equipment and the E1 DSU/CSU. 2. DTE Drop/Insert cabling problem. 	<ol style="list-style-type: none"> 1. Check that the framing format for the DTE Drop/Insert interface is correct. 2. Check that the DTE Drop/Insert cable is securely attached at both ends.
Message RAI at Net appears	<ol style="list-style-type: none"> 1. Network cable problem. 2. Far-end E1 DSU/CSU DTE has detected an LOS, LOF, AIS, or EER condition. 3. E1 facility problem. 	<ol style="list-style-type: none"> 1. Check that your network cable is securely attached at both ends. 2. Check the status of the far-end device. 3. Contact your E1 facility provider.
Message RAI at DTE appears	DTE has detected an LOS, LOF, AIS, or EER condition.	<ol style="list-style-type: none"> 1. Check the status of the DTE. 2. Check that the DTE Drop/Insert cable is securely attached at both ends.
Message AIS at Net appears	<ol style="list-style-type: none"> 1. Upstream E1 DSU/CSU is transmitting an AIS. 2. The network is transmitting an AIS. 	<ol style="list-style-type: none"> 1. Check the status of the upstream E1 DSU/CSU(s). 2. Contact your E1 facility provider.

**Table 4-6
(2 of 2)
Troubleshooting**

Symptom	Possible Cause	Solutions
Message AIS at DTE appears	DTE is sending an AIS.	Check the DTE.
Message EER at Net appears	E1 facility problem.	Contact your E1 facility provider.
BPV LED is ON	<ol style="list-style-type: none"> 1. Incompatible line coding format between the DTE and the E1 DSU/CSU. 2. DTE Drop/Insert cable problem. 	<ol style="list-style-type: none"> 1. Check that the line coding format for the DTE Drop/Insert interface is correct. 2. Check that the DTE cable is securely attached at both ends.
A failure message appears followed by an 8-digit code (#####)	Internal E1 DSU/CSU problem.	Record the 8-digit code, then contact your field service representative.
SNMP link is down	<ol style="list-style-type: none"> 1. The SNMP manager configuration is mismatched with the device configuration. 2. The SNMP manager's link layer protocol is not running. 	<ol style="list-style-type: none"> 1. Check that the configurations are matched. 2. Start the link layer protocol.
No SNMP communication via the AUX port	<ol style="list-style-type: none"> 1. Cable problem. 2. The link layer protocol is not running. 	<ol style="list-style-type: none"> 1. Check that the cable is securely attached at both ends. 2. Change the Aux Use configuration option to None, and then back to SNMP or Daisy (as appropriate).

Test Jacks

Six test jacks are located on the front panel (Figure 4-1). These test jacks allow for two break-in tests (Network In and Network Out) and four monitor access points (Equipment Monitor In, Equipment Monitor Out, Network Monitor In, and Network Monitor Out) to the E1 DSU/CSU.

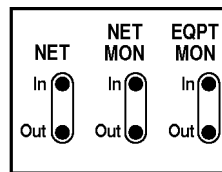

494-14586

Figure 4-1. E1 DSU/CSU Test Jacks

Test jack functions are shown in Figure 4-2 and described in Table 4-7.

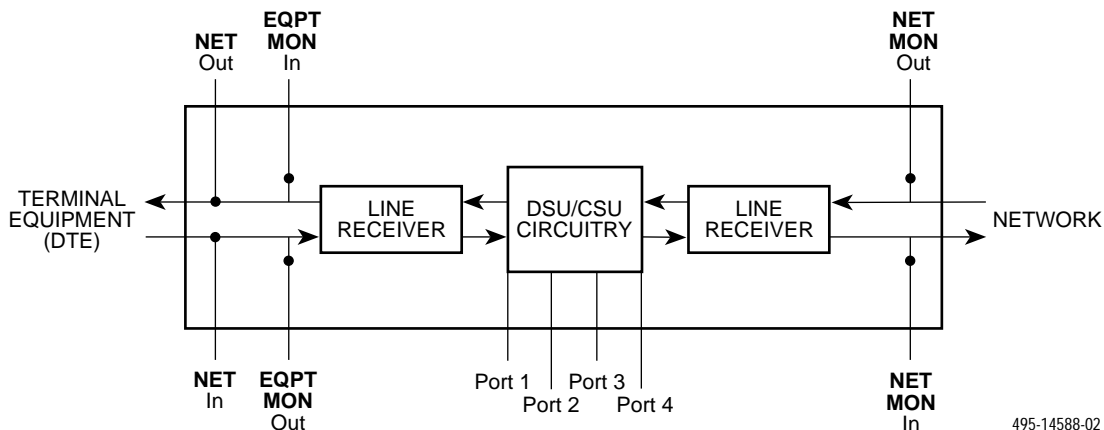

495-14588-02

Figure 4-2. Test Jack Block Diagram

Table 4-7
Test Jack Functions

Test Jack Name	Function
NET In (Network In)	A break-in test jack that allows a signal to be inserted toward the network by external test equipment. The signal is inserted on the DTE side of the E1 DSU/CSU.
NET Out (Network Out)	A break-in test jack that interrupts the signal coming from the network and allows it to be terminated by the external test equipment.
EQPT MON In (Equipment Monitor In)	A monitor jack that nonintrusively monitors the signal going into the terminal equipment (DTE).
EQPT MON Out (Equipment Monitor Out)	A monitor jack that nonintrusively monitors the signal coming out of the terminal equipment (DTE).
NET MON In (Network Monitor In)	A monitor jack that nonintrusively monitors the transmitted signal going into the network. This is a composite of the channels allocated to the DTE and data ports.
NET MON Out (Network Monitor Out)	A monitor jack that nonintrusively monitors the received signal coming out of the network. This is a composite of the channels allocated to the DTE and data ports.

Test Commands

The test commands enable you to run loopbacks and test patterns on the E1 DSU/CSU, and to test the front panel LEDs. These tests can help you isolate areas of trouble if you are having problems with your E1 DSU/CSU.

To access all Test commands from the Test branch, press F2 to select Test from the top-level menu screen.

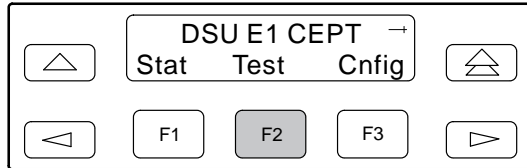

Remote Loopback Tests

The Remote Loopback tests enable you to troubleshoot your circuit by sending the following to a far-end E1 DSU/CSU:

- Data channel loopback up (DCLBUP) activation sequence to initiate a V.54 Loop 2
- Data channel loopback down (DCLBDN) deactivation sequence to terminate a V.54 Loop 2

You cannot perform remote loopbacks if any of the local loopbacks are active. If you attempt to do so, the error message **Invlid Test Combo** (Invalid Test Combination) appears.

To send a Data Channel Activation or Deactivation loopback sequence to the far-end E1 DSU/CSU,

1. Press F2 to select Test from the top-level menu screen.
2. From the Test screen, press F1 to select Rlpbk.

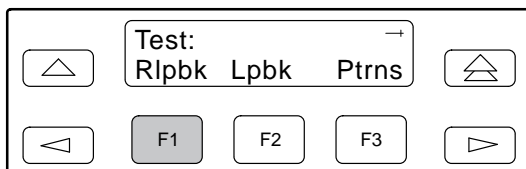

3. From the Rem Loopback screen, press the Function key that corresponds to the specific loopback test you want to perform.

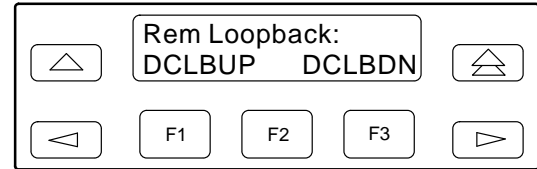

The Rem Loop screen appears, where *Type* is either DCLBUP or DCLBDN.

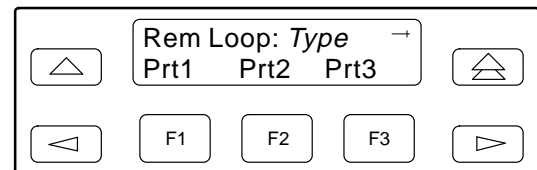

The DCLBUP and DCLBDN commands send the requested sequence out the network interface on the DS0 channels allocated to the port you select here.

4. From the Rem Loop screen, press the desired Function key to select the specific port. Use the scroll keys, if necessary.

After you select a port, the sequence is sent to the far-end E1 DSU/CSU. During this time, **Sending** appears on Line 2 of the LCD, followed by **Command Complete** when the sequence is complete.

During the **Sending** message, you can press the \triangleleft and \triangleright keys without affecting transmission of the loopback sequence.

Local Loopback Tests

The Local Loopback tests enable you to conduct circuit testing and fault isolation for the digital line. The supported local loopback tests are:

- Line Loopback (LLB)
- Payload Loopback (PLB)
- DTE Loopback (DLB)
- Repeater Loopback (RLB)
- Data Channel Loopback (DCLB)
- Data Terminal Loopback (DTLB)

NOTE

DLB does not appear when the DTE Drop/Insert interface is disabled.

The Line Loopback command can be activated and deactivated in response to commands received over the network interface. The Network Interface configuration option NET LLB controls whether the E1 DSU/CSU responds to the commands transmitted on the network interface to initiate LLBs (see Appendix C, *Configuration Options*).

The data port configuration option NET DCLB controls whether the E1 DSU/CSU responds to inband V.54 commands to initiate DCLB for that port (see Appendix C, *Configuration Options*).

Local loopback tests can be aborted (Abort Command) at any time.

No more than two local loopbacks can be active at any one time. An additional restriction prohibits certain loopbacks from running at the same time. Valid loopback combinations listed in Table 4-8 are identified by YES.

Table 4-8
Valid Loopback Combinations

	LLB	PLB	DLB	RLB	DCLB	DTLB
LLB	N/A	NO	YES	YES	NO	YES
PLB	NO	N/A	YES	NO	NO	YES
DLB	YES	YES	N/A	NO	YES	YES
RLB	YES	NO	NO	N/A	NO	YES
DCLB	NO	NO	YES	NO	YES (on separate ports)	YES (on separate ports)
DTLB	YES	YES	YES	YES	YES (on separate ports)	YES (on separate ports)

Starting a Line Loopback

The Line Loopback command (LLB) loops the received signal on the network interface back to the network without change.

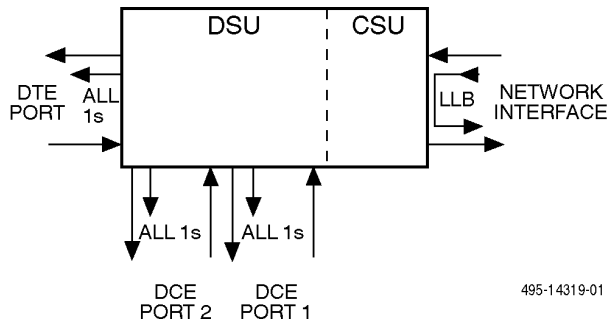

495-14319-01

To perform a Line loopback,

1. Press F2 to select Test from the top-level display screen.
2. From the Test screen, press F2 to select Lpbk.

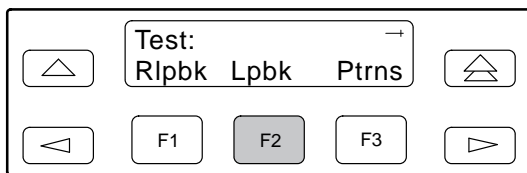

3. From the Loopback screen, press F2 to select LLB.

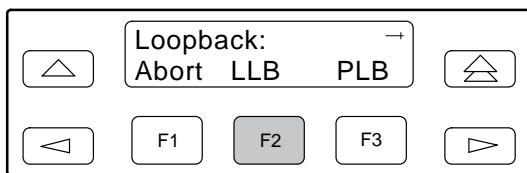

Test Started appears on Line 2. If a line loopback is already in progress, the **Already Active** message appears. If an invalid combination of loopbacks is in progress, the error message **Invlid Test Combo** appears (see Table 4-8 for valid loopback test combinations).

Starting a Payload Loopback

The Payload Loopback command (PLB) loops the received signal on the network interface back to the network. The signal is looped back as close to the DTE Drop/Insert port as possible (after it has passed through the framing circuitry of the E1 DSU/CSU). Therefore, framing CRCs and BPVs are corrected.

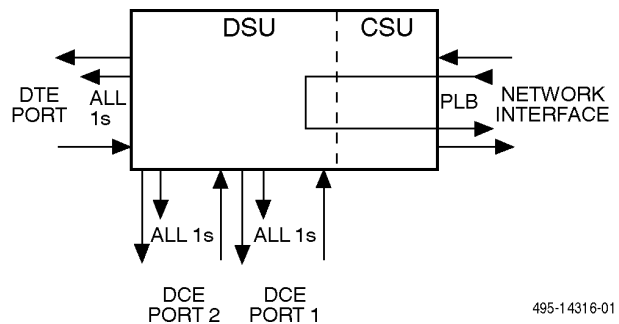

495-14316-01

To perform a Payload loopback,

1. Press F2 to select Test from the top-level menu screen.
2. From the Test screen, press F2 to select Lpbk.

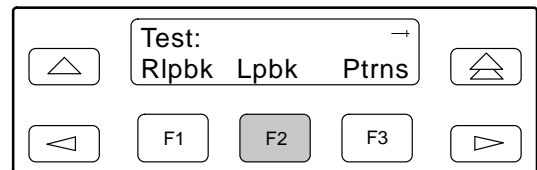

3. From the Loopback screen, press F3 to select PLB.

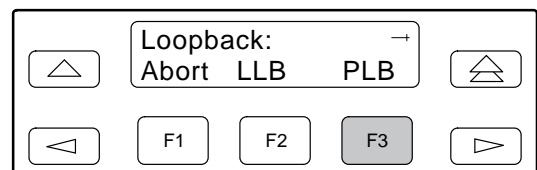

Test Started appears on Line 2. If a Payload loopback is already in progress, the **Already Active** message appears. If an invalid combination of loopbacks is in progress, the error message **Invlid Test Combo** appears (see Table 4-8 for valid loopback test combinations).

Starting a DTE Loopback

The DTE Loopback command (DLB) loops the received signal on the DTE Drop/Insert port back to the DTE without change.

A DTE loopback can be activated and deactivated based on the state of an external contact on the DTE Drop/Insert port. If this option is enabled with the DTE Interface configuration option Extrn DLB, closing the contact activates a DLB. The DLB remains active until the contact is opened. Refer to the *DTE Drop/Insert Interface* section in Appendix D, *Pin Assignments*, for more information.

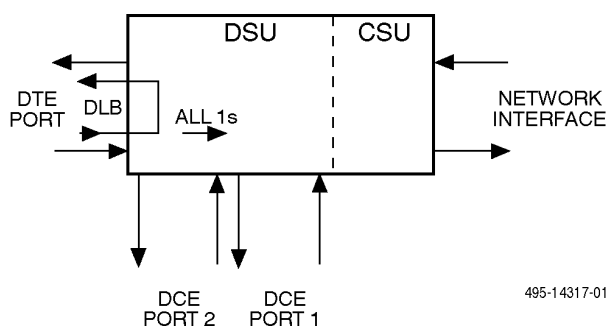

To perform a DTE loopback,

1. Press F2 to select Test from the top-level menu screen.
2. From the Test screen, press F2 to select Lpbk.

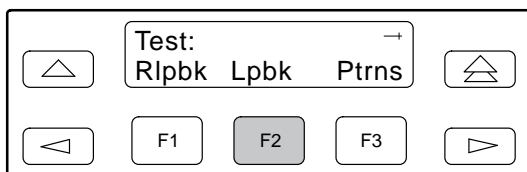

3. From the Loopback screen, press \triangleright once to display the DLB selection on the screen.

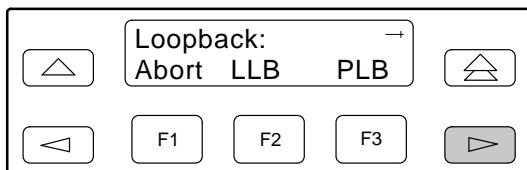

4. Press F3 to select DLB.

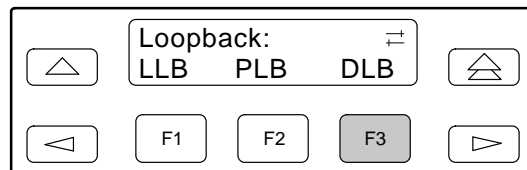

Test Started appears on Line 2. If a DTE loopback is already in progress, the **Already Active** message appears. If an invalid combination of loopbacks is in progress, the error message **Invlid Test Combo** appears (see Table 4-8 for valid loopback test combinations).

Starting a Repeater Loopback

The Repeater Loopback command (RLB) loops the signal being sent to the network back to the DTE Drop/Insert and data ports. The signal is looped back as close to the network interface as possible (after it has passed through the framing circuitry of the E1 DSU/CSU). Therefore, framing CRCs and BPVs are corrected.

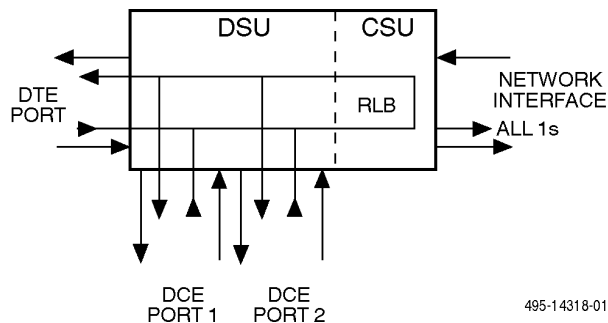

To perform a Repeater loopback,

1. Press F2 to select Test from the top-level menu screen.
2. From the Test screen, press F2 to select Lpbk.

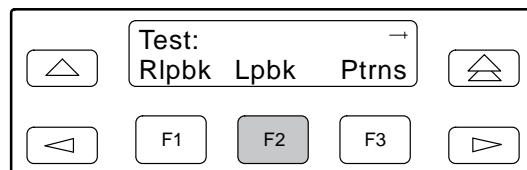

- From the Loopback screen, press \triangleright twice to display the RLB selection on the screen.

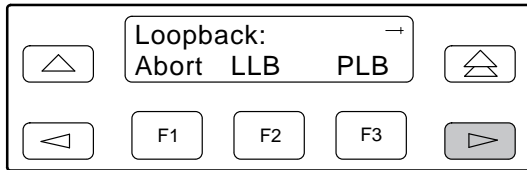

- Press F3 to select RLB.

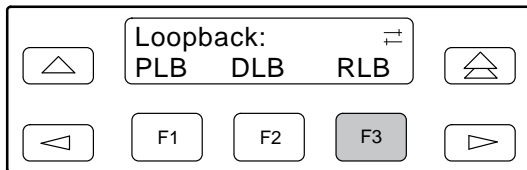

Test Started appears on Line 2. If a Repeater loopback is already in progress, the **Already Active** message appears. If an invalid combination of loopbacks is in progress, the error message **Invid Test Combo** appears (see Table 4-8 for valid loopback test combinations).

Starting a Data Channel Loopback

The Data Channel Loopback command (DCLB) loops the data received from the network interface, for all DS0 channels allocated to the selected port, back to the network. The loopback occurs after the data passes through the port circuitry but before it is sent out the data port.

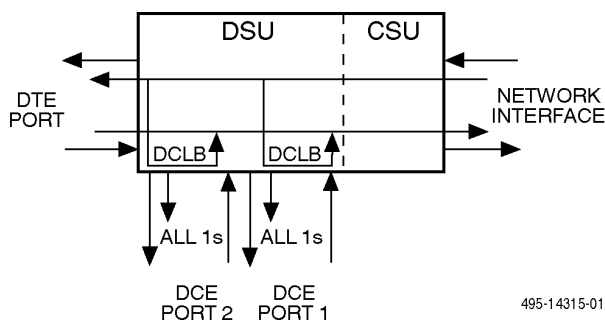

To perform a Data Channel loopback,

- Press F2 to select Test from the top-level menu screen.

- From the Test screen, press F2 to select Lpbk.

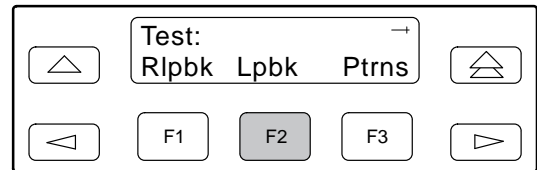

- From the Loopback screen, press \triangleright three times to display the DCLB selection on the screen.

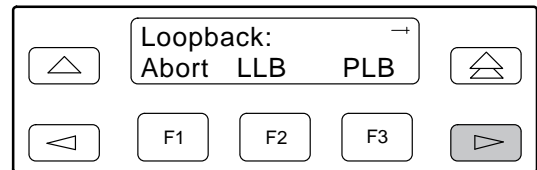

- Press F3 to select DCLB.

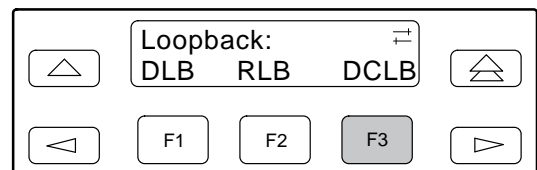

- From the DCLB screen, press the Function key for the port for which you want to perform the data channel loopback. Use the scroll keys, if necessary.

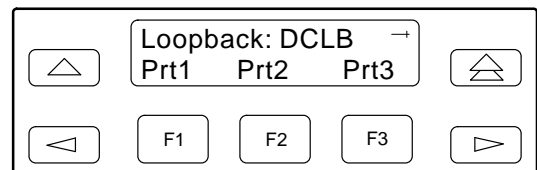

Test Started appears on Line 2. If a Data Channel loopback is already in progress, the **Already Active** message appears. If an invalid combination of loopbacks is in progress, the error message **Invid Test Combo** appears (see Table 4-8 for valid loopback test combinations).

Starting a Data Terminal Loopback

The Data Terminal Loopback command (DTLB) loops the data received from the selected port, for all DS0 channels allocated to the port, back out of the port. This loopback occurs after the data passes through the port circuitry but before it reaches the E1 framer.

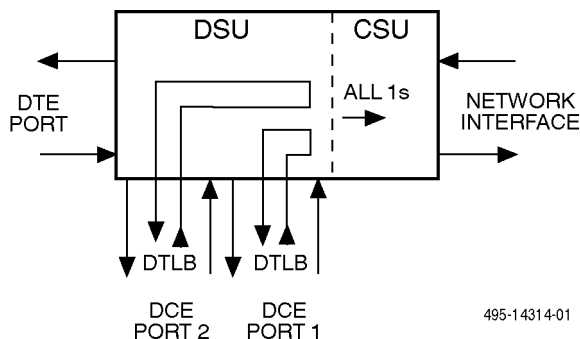

To perform a Data Terminal loopback,

1. Press F2 to select Test from the top-level menu screen.
2. From the Test screen, press F2 to select Lpbk.

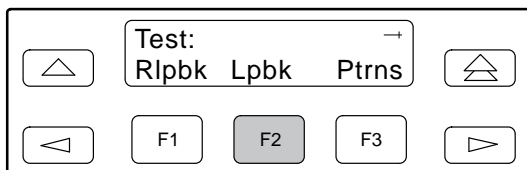

3. From the Loopback screen, press \triangleright four times to display the DTLB selection on the screen.
4. Press F3 to select DTLB.

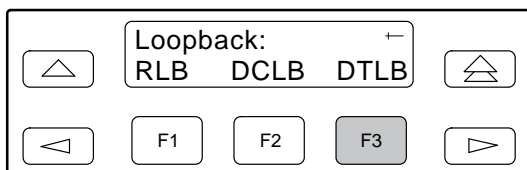

5. From the DTLB screen, press the Function key for the port for which you want to perform the data terminal loopback. Use the scroll keys, if necessary.

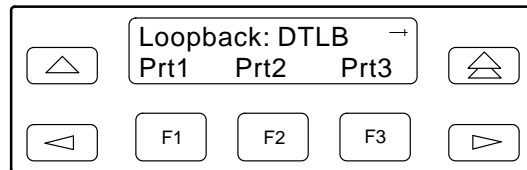

Test Started appears on Line 2. If a Data Terminal loopback is already in progress, the **Already Active** message appears. If an invalid combination of loopbacks is in progress, the error message **Invlid Test Combo** appears (see Table 4-8 for valid loopback test combinations).

Aborting Loopbacks

The Abort Loopback command stops all loopback tests or any selected loopback test currently active on the E1 DSU/CSU.

To abort one or more loopback tests,

1. Press F2 to select Test from the top-level menu screen.
2. From the Test screen, press F2 to select Lpbk.

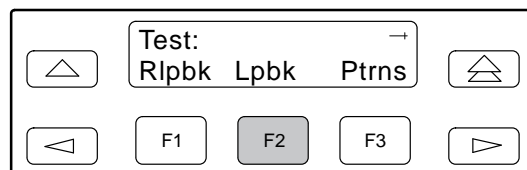

3. From the Loopback screen, press F1 to select Abort.

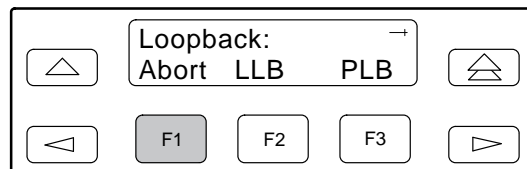

- From the Loopback Abort screen, press the desired Function key to abort All or one specific loopback test. Use the scroll keys, if necessary.

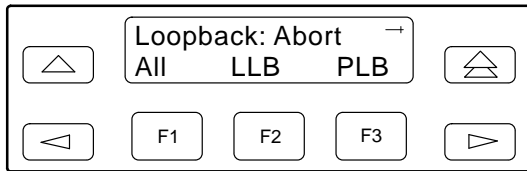

If you select ALL, LLB, PLB, DLB, or RLB, skip Step 5.

NOTE

DLB does not appear when the DTE Drop/Insert interface is disabled.

- From the Abort screen, press the Function key that corresponds to the port for which you want to abort the test. Use the scroll keys, if necessary.

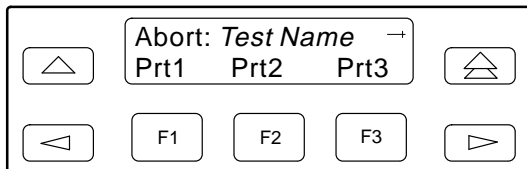

When abort is complete, the message **Command Complete** appears on the Abort screen.

NOTE

Be careful when selecting a specific loopback test to abort. If you mistakenly choose to abort a loopback test that is not currently running, a **Command Complete** message will still display and the loopback that is currently active will still be running. You can use the TStat branch of the menu to view the test status to determine if the abort was successful.

Test Patterns

Use the Test Pattern commands to send and abort transmission of test patterns on the E1 DSU/CSU network. Available test patterns are:

- 511** – A pseudo-random bit sequence (PRBS) that is 511 bits long (on the data ports only). This is a PRBS 2^9-1 test.
- 1-in-8** – A test pattern consisting of a one (1) followed by seven zeros (on the network only).
- QRSS** – A quasi-random signal source approximating live data that can be monitored for logic errors (on the data ports only).

Sending Test Patterns

Use the Send command to start transmission of a test pattern.

Only one test pattern can be active at a time on one port. Table 4-9 lists the valid send test pattern combinations. Valid combinations are identified by YES.

To send a test pattern,

- Press F2 to select Test from the top-level menu screen.
- From the Test screen, press F3 to select Ptrns.

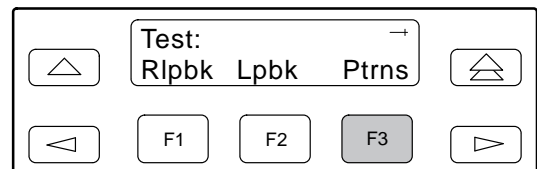

- From the Patterns screen, press F2 to select Send.

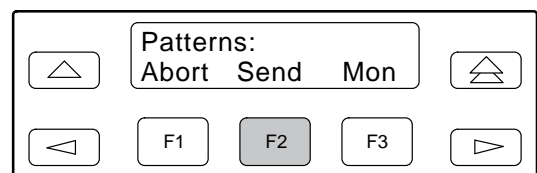

4. From the Patterns Send screen, press F1 to send a 511 pattern, F2 to send a 1-in-8 pattern, or F3 to send a QRSS pattern.

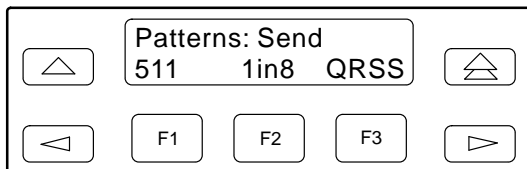

If you send a 1-in-8 pattern, skip Step 5.

5. From the Send screen, press the Function key that corresponds to the port for which you want to send a test pattern. Use the scroll keys, if necessary.

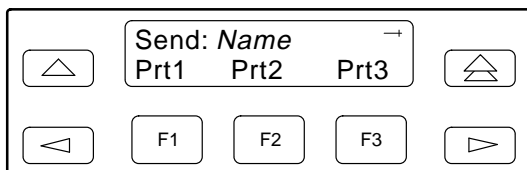

The Test Started screen appears.

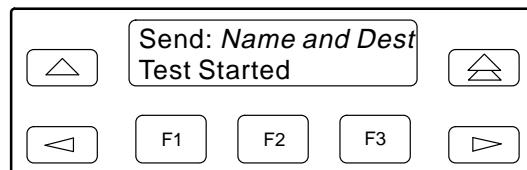

If the E1 DSU/CSU is already sending the test pattern you selected, the message **Already active** appears. If you selected an incompatible test pattern combination, the message **Invld Test Combo** appears. See Table 4-9 for valid combinations.

Table 4-9
Valid Send Test Pattern Combinations

	511 (Port)	1-in-8 (Network)	QRSS (Port)
511 (Port)	YES (on separate ports)	NO	YES (on separate ports)
1 in 8 (Network)	NO	N/A	NO
QRSS (Port)	YES (on separate ports)	NO	YES (on separate ports)

Monitoring Test Patterns on Individual Data Ports

Use the Monitor command to monitor QRSS or 511 test patterns on the channels allocated to an individual data port.

This command provides the number of errors detected in the test pattern (5 digits, maximum 99999).

To monitor a QRSS or 511 test pattern,

1. Press F2 to select Test from the top-level menu screen.
2. From the Test screen, press F3 to select Ptrns.

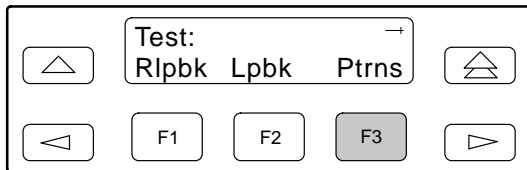

3. From the Patterns screen, press F3 to select Mon.

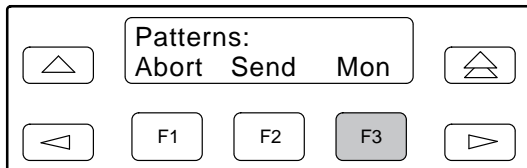

4. From the Patterns Mon screen, press F1 for QRSS or F2 for 511.

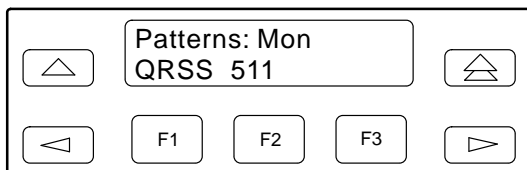

5. From the Monitor screen, press the Function key that corresponds to the port for which you want to monitor a test pattern. Use the scroll keys, if necessary.

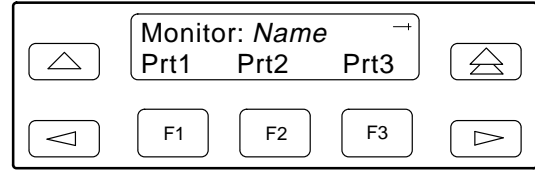

The Monitor screen appears with the error count. If the maximum of 99999 is exceeded, **OvrFlw** appears instead of the count. If the receiver loses synchronization while the monitor is active, **No Sync** appears.

Aborting Test Patterns

Use the Abort command to stop all test patterns or any selected test pattern active on the E1 DSU/CSU.

To abort test patterns,

1. Press F2 to select Test from the top-level menu screen.
2. From the Test screen, press F3 to select Ptrns.

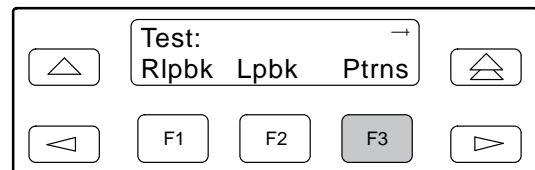

3. From the Patterns screen, press F1 to select Abort.

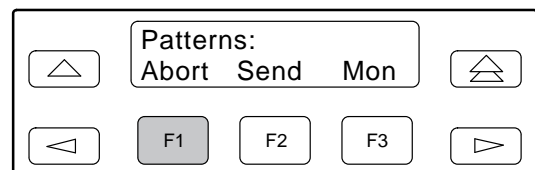

- From the Patterns Abort screen, press the desired Function key to abort either All active test patterns, active Send test patterns, or the active Monitor (Mon) test pattern.

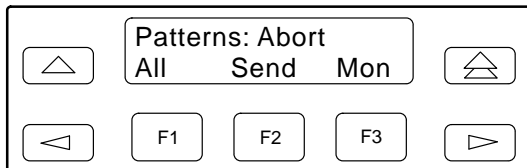

If you select All, the E1 DSU/CSU terminates all active test patterns and displays the message **Command Complete**. Skip Step 5.

NOTE

Be careful when selecting a specific test pattern to abort. If you mistakenly choose to abort a test pattern that is not currently running, a **Command Complete** message still displays and the test pattern currently active still runs. You can use the TStat branch of the menu to view the test status to determine if the abort was successful.

- From the Abort screen, press the Function key that corresponds to the network or port for which you want to abort a test pattern. Use the scroll keys, if necessary.

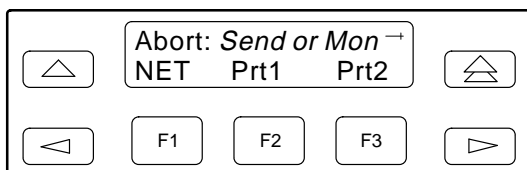

The E1 DSU/CSU terminates the selected test pattern and displays the message **Command Complete**.

Lamp Test

Use the Lamp Test commands to start and stop a test of the E1 DSU/CSU front panel LCD and LEDs.

Starting a Lamp Test

To start a Lamp test,

- Press F2 to select Test from the top-level menu screen.
- From the Test screen, press \triangleright once to display the Lamp selection on the screen.

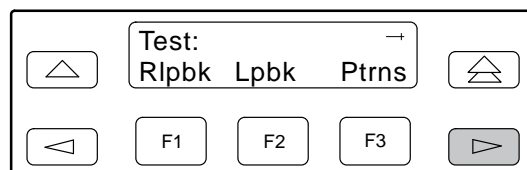

- From the Test screen, press F3 to select Lamp.

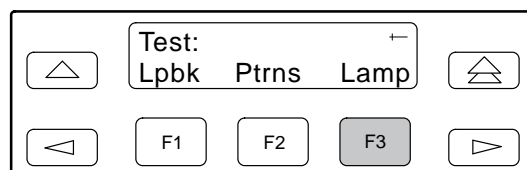

- From the Lamp Test screen, press F2 to select Start.

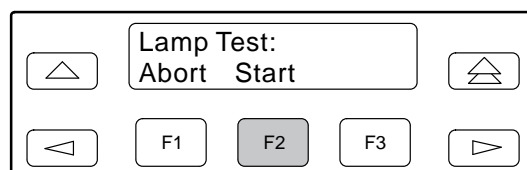

- The following screens alternately appear on the LCD until you press a Function key to return to the Lamp Test screen. In addition, all LEDs blink.

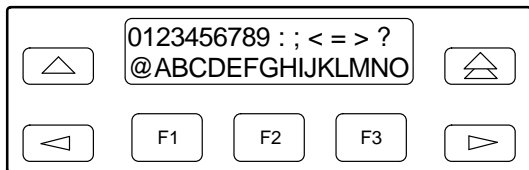
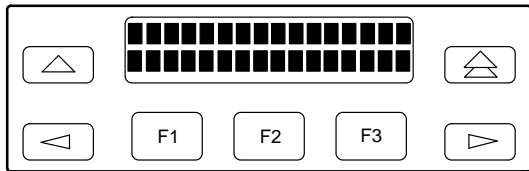

- When you are satisfied that all LEDs are lighting and the LCD is functioning properly, abort the Lamp test from the Lamp Test screen. The Device Health and Status screen appears automatically if there is no activity on the E1 DSU/CSU front panel for five minutes. However, the Lamp test remains active until it is aborted.

Aborting a Lamp Test

To abort the Lamp test,

- Display the Lamp Test screen. To do this when the LCD is alternating the Lamp test screens, press any Function key. Otherwise, follow Steps 1 through 3 for starting a Lamp test.

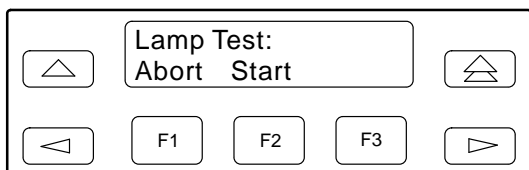

- From the Lamp Test screen, press F1 to select Abort.

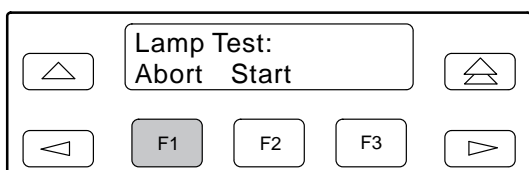

Displaying E1 DSU/CSU Test Status

Use the Test Status command to display the active tests for the E1 DSU/CSU. Status messages that can display on the front panel LCD are listed in Table 4-10.

To display test status,

- Press F1 to select Stat from the top-level menu screen.

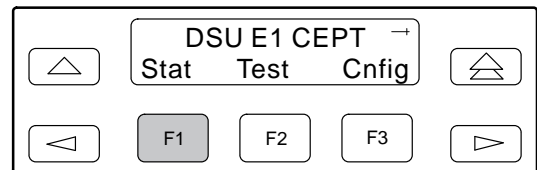

- From the Status screen, press the right arrow key once to display the TStat selection.

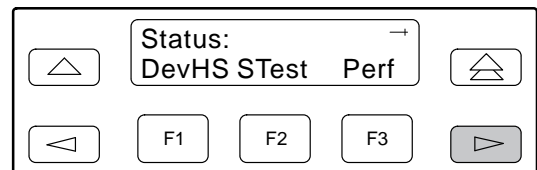

- Press F3 to select TStat.

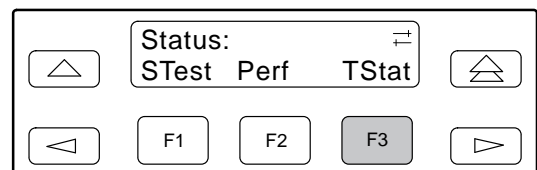

The Test Status screen appears showing you what tests are active for the E1 DSU/CSU.

**Table 4-10
Test Status Messages**

Message	Description
No Test Active	No tests are currently active.
LLB Test Active	The network interface is in Line loopback.
PLB Test Active	The network interface is in Payload loopback.
DLB Test Active	The DTE Drop/Insert port is in DTE loopback.
RLB Test Active	The DTE Drop/Insert port is in Repeater loopback.
DCLB on Port <i>n</i>	Port <i>n</i> is in a data channel loopback.
DTLB on Port <i>n</i>	Port <i>n</i> is in a data terminal loopback.
1-8 Test Active	A 1-in-8 test pattern is being sent on the network interface.
QRSS on Port <i>n</i>	A QRSS test pattern is being sent to the network on the channels allocated to port <i>n</i> .
511 on Port <i>n</i>	A 511 test pattern is being sent to the network on the channels allocated to port <i>n</i> .
Mon QRSS, Port <i>n</i>	A QRSS test pattern is being monitored on the channels allocated to port <i>n</i> .
Mon 511, Port <i>n</i>	A 511 test pattern is being monitored on the channels allocated to port <i>n</i> .
DLB Test, Extrn	The DTE Drop/Insert port is being held in DTE loopback by the external contact.
Lamp Test Active	The Lamp test is currently active.

Front Panel Menu **A**

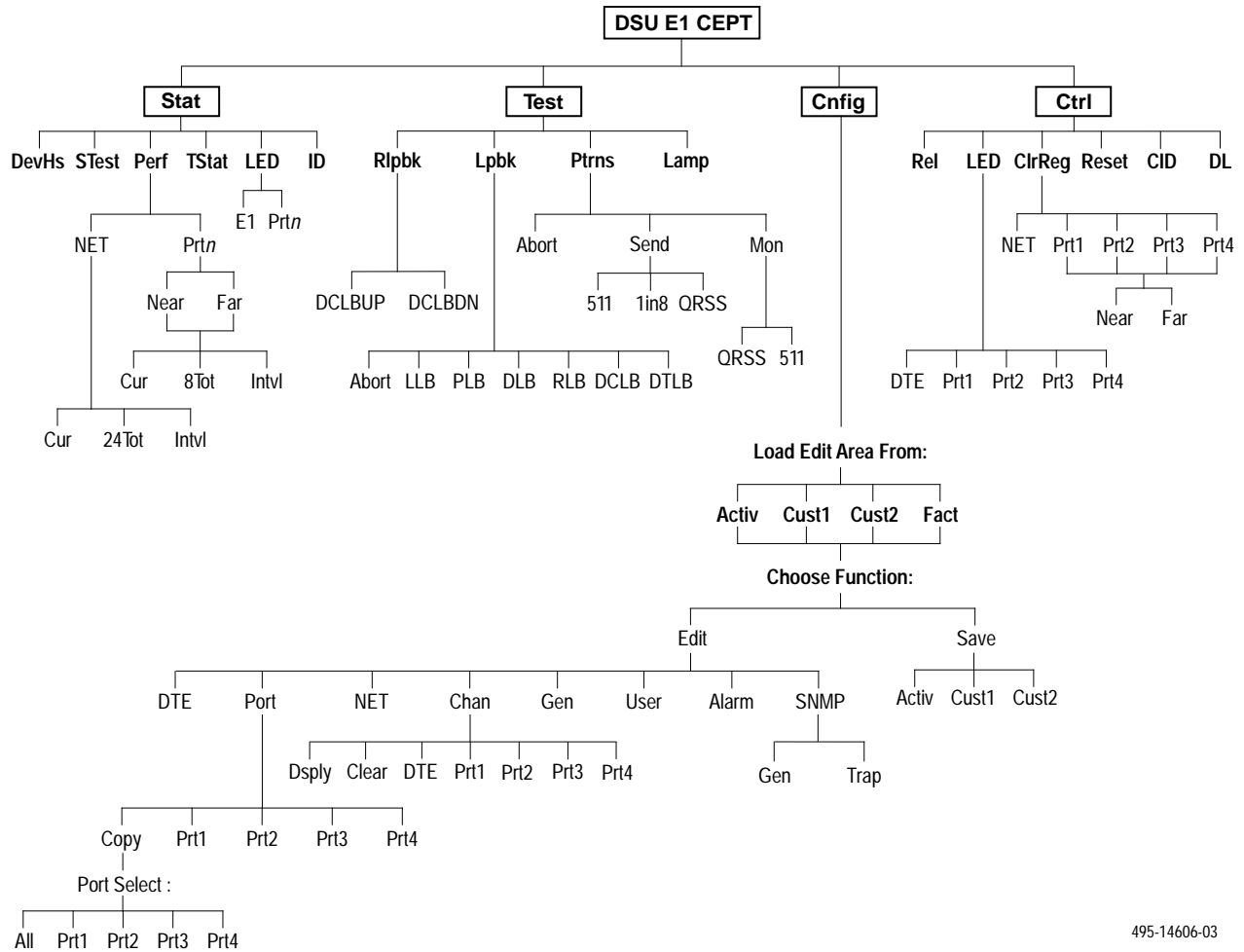

495-14606-03

Technical Specifications **B**

Overview B-1

Overview

The technical specifications for the Models 3172 and 3174 DSU/CSUs are listed in Table B-1.

**Table B-1
(1 of 2)
Models 3172/3174 DSU/CSUs Technical Specifications**

Specifications	Criteria
POWER REQUIREMENTS Typical: AC Power Module Optional: +24 Vdc -48 Vdc -48 Vdc Redundant	Refer to the labeling on the ac power module for input requirements +20 Vdc to +32 Vdc, 0.50A -38 Vdc to -60 Vdc, 0.25A -38 Vdc to -60 Vdc, 0.25A
POWER CONSUMPTION AND DISSIPATION	16.0 watts, 55.0 Btu per hour at 115 volts (ac power); 12.0 watts, 41 Btu per hour at +24 and -48 Vdc (dc power)
DTE Drop/Insert INTERFACE Physical Interface Framing Format Coding Format	DB15 socket for 120 ohm twisted pair (balanced) CRC-4, non-CRC-4 AMI, HDB3
NETWORK E1 INTERFACE Physical Interface Framing Format Coding Format Signal Recovery Capability Typical Drive Distances: 75 ohm, coaxial cable 120 ohm, 22 AWG (0.6 mm) 120 ohm, 24 AWG (0.5 mm) 120 ohm, 26 AWG (0.4 mm)	BNC pair for 75 ohm coaxial cables (unbalanced) or RJ48C for 120 ohm twisted pair (balanced) CRC-4, non-CRC-4 HDB3 43 dB of cable attenuation at 1024 kHz 3.4 km 2.3 km 1.8 km 1.5 km

**Table B-1
(2 of 2)
Models 3172/3174 DSU/CSUs Technical Specifications**

Specifications	Criteria
PORT INTERFACE Standards Rates	EIA 530A, V.35, RS-449 Nx64 kbps Nx56 kbps
APPROVALS	Refer to the product labeling
CLOCKING SOURCES	E1 network interface, synchronous data port, internal clock, DTE Drop/Insert interface, or external clock
PHYSICAL DIMENSIONS Height Width Depth	3.90 inches (10.0 cm) 7.63 inches (19.4 cm) 12.13 inches (30.8 cm)
WEIGHT	3.6 pounds (1.7 kg)
ENVIRONMENT Operating Temperature Storage Temperature Relative Humidity Shock and Vibration	32°F to 122°F (0°C to 50°C) 4°F to 158°F (20°C to 70°C) 5% – 95% (noncondensing) Withstands normal shipping and handling

Configuration Options C

Overview	C-1
DTE Interface Configuration Options	C-2
Port Configuration Options	C-3
Network Interface Configuration Options	C-7
Channel Configuration Options	C-8
General Configuration Options	C-12
User Interface Configuration Options	C-13
Alarm Configuration Options	C-16
SNMP Configuration Options	C-17
Configuration Worksheets	C-23

Overview

The E1 DSU/CSU configuration option tables contain a list of all configuration options and their selectable options. The configuration options are arranged into functional groups:

- **DTE Interface Configuration Options**

The DTE Interface configuration options configure the DTE Drop/Insert interface on the E1 DSU/CSU (Table C-1).

- **Port Configuration Options**

The Port configuration options configure the synchronous data ports on the E1 DSU/CSU (Table C-2).

- **Network Interface Configuration Options**

The Network Interface configuration options configure the Network E1 interface on the E1 DSU/CSU (Table C-3).

- **Channel Configuration Options**

The Channel configuration options configure the DTE Drop/Insert and synchronous data port channel allocations on the E1 DSU/CSU (Tables C-4 and C-5).

- **General Configuration Options**

The General configuration options configure clocks on the E1 DSU/CSU (Table C-6).

- **User Interface Configuration Options**

The User Interface configuration options configure and control the E1 DSU/CSU user interfaces (Table C-7).

- **Alarm Configuration Options**

The Alarm configuration options specify how alarm conditions are handled by the E1 DSU/CSU (Table C-8).

- **SNMP Configuration Options**

The SNMP Configuration Options configure the E1 DSU/CSU for SNMP management (Tables C-9 and C-10).

The configuration tables include a description of each configuration function and its selectable options. In the tables, the top line of each configuration option entry indicates the factory default setting.

DTE Interface Configuration Options

Table C-1
DTE Interface Configuration Options

DTE Port: Enab			
Next	Enab	Disab	Prev
DTE Drop/Insert Port. Enables the use of the DTE Drop/Insert port.			
Enab – Allows the use of the DTE Drop/Insert interface.			
Disab – Prohibits the use of the DTE Drop/Insert interface.			
NOTE: When this configuration option is disabled, you cannot display or configure any other DTE Interface configuration options and TS16 is set to data. If a clock source configuration option is set to DTE, it is changed to NET.			
DTE Frame: noCRC			
Next	CRC4	noCRC	Prev
DTE Line Framing Format. Designates the framing format for the DTE Drop/Insert interface.			
CRC4 – Configures for the CRC4 framing format.			
noCRC – Configures for the non-CRC4 framing format.			
DTE Coding: HDB3			
Next	AMI	HDB3	Prev
DTE Line Coding. Designates the line coding format to be used on the DTE Drop/Insert interface.			
AMI – Uses the Alternate Mark Inversion coding format.			
HDB3 – Uses the High Density Bipolar 3 coding format.			
Extrn DLB: Disab			
Next	Enab	Disab	Prev
DTE Loopback on External Contact. Allows the initiation and termination of a DTE Loopback (DLB) by an external contact. For more information, see the <i>DTE Drop/Insert Interface</i> section in Appendix D, <i>Pin Assignments</i> .			
Enab – Allows the E1 DSU/CSU to begin a DLB when the external contact is closed (if the current E1 DSU/CSU state allows a DLB to be performed). If the E1 DSU/CSU is already performing a DLB, closing the contact will have no effect. Opening the contact takes the E1 DSU/CSU out of DLB. The E1 DSU/CSU remains in DLB as long as the contact remains closed.			
Disab – Prevents the state of the external contact from affecting the operation of DLB.			
Send Ones: Enab			
Next	Enab	Disab	Prev
Send All Ones on DTE Drop/Insert Failure. Specifies the action to take on the signal transmitted to the network when a valid signal cannot be recovered from the DTE Drop/Insert interface (due to an LOS, OOF, or AIS condition).			
Enab – Sends all ones on the DS0 channels allocated to the network interface when an LOS, AIS, or OOF condition occurs on the DTE Drop/Insert interface.			
Disab – Passes the data unchanged to the network interface channels.			

Port Configuration Options

Table C-2
(1 of 4)
Port Configuration Options

Port Type: E530						
Next	E530	V.35	RS449	Prev		
Data Port Type. Allows selection of the data port interface type.						
E530 – Configures the port as an EIA 530A compatible interface. EIA 530A DTEs can be directly connected to the DB25 connector on the back of the E1 DSU/CSU.						
V.35 – Configures the port as a V.35 compatible interface. V.35 DTEs can be connected to the DB25 connector using an EIA 530-to-V.35 adapter cable.						
RS449 – Configures the port as an RS449 compatible interface. RS449 DTEs can be connected to the DB25 connector using an EIA 530A-to-RS449 adapter cable.						
NOTE: For X.21 applications, set this configuration option to RS449 and set the All Ones configuration option to RTS or Disab.						
Base Rate: Nx64						
Next	Nx64	Nx56	Prev			
Data Port Base Rate. Allows selection of the base rate for the data port. The data rate for the port is a multiple (from 1 to 31) of the base rate specified with this configuration option.						
Nx64 – Sets the base rate for this port to 64 kbps. The data rate will be Nx64 kbps, where N is a number from 1 to 31.						
Nx56 – Sets the base rate for this port to 56 kbps. The data rate will be Nx56 kbps, where N is a number from 1 to 31.						
Net DCLB: Disab						
Next	Enab	Disab	Prev			
Network Initiated DCLB. Allows the initiation and termination of a Data Channel Loopback (V.54 loop 2) by the receipt of a V.54 DCLB-actuate sequence or DCLB-release sequence from the network or far-end E1 DSU/CSU.						
Enab – Allows the E1 DSU/CSU to begin a DCLB for this port when it receives a DCLB-actuate sequence (if the current E1 DSU/CSU state allows a DCLB to be performed). Receiving a DCLB-release sequence terminates the DCLB.						
Disab – Ignores the DCLB-actuate and DCLB-release sequences for this port.						
Port LB: Disab						
Next	Disab	DTLB	DCLB	Both	Prev	
Port (DTE) Initiated Loopbacks. Allows the initiation and termination of a local Data Terminal Loopback (DTLB) or remote Data Channel Loopback (DCLB) by the DTE connected to this port. (DTLB is equivalent to a V.54 loop 3, and DCLB is equivalent to a V.54 loop 2.) Control of these loopbacks is through the DTE interchange circuits as specified by the V.54 standard.						
Disab – Disables control of local DTLBs and remote DCLBs by the DTE connected to this port.						
DTLB – Gives control of the local DTLBs for this port to the DTE attached to this port. This loopback is controlled by the Local Loopback interchange circuit LL (CCITT 141).						
DCLB – Gives control of the remote DCLBs for the far-end port connected to this port to the DTE attached to this port. This loopback is controlled by the Remote Loopback interchange circuit RL (CCITT 140). The far-end equipment must support in-band V.54 loopbacks.						
Both – Gives control of local DTLBs and remote DCLBs to the DTE connected to this port.						

Table C-2
(2 of 4)
Port Configuration Options

All Ones: Both						
Next	Disab	DTR	RTS	Both	Prev	
Send All Ones on Data Port Not Ready. Specifies the conditions on the data port that determine when valid data is not being sent from the DTE. When this condition is detected, all ones are sent to the network on the DS0 channels allocated to the port.						
Disab – Disables the monitoring of interchange circuits from the DTE connected to this port.						
DTR – Monitors the DTE Ready interchange circuit CD (CCITT 108/1/2). When DTR is interrupted, all ones are sent to the network.						
RTS – Monitors the Request-to-Send interchange circuit CA (CCITT 105). When RTS is interrupted, all ones are sent to the network.						
Both – Monitors both DTR and RTS. If either is interrupted, all ones are sent to the network.						
NOTE: For X.21 applications, set this configuration option to RTS or Disab.						
Rcv RAI: Halt						
Next	None	Halt	Prev			
Action on Network RAI Alarm. Specifies the action taken on this port when a Remote Alarm Indication (RAI) is received on the network interface.						
None – Makes the data port unaffected by RAIs received on the network interface.						
Halt – Stops the transmission of data on the port and disables the data port when RAIs are received on the network interface. When RAIs are received, all ones are sent on the Received Data interchange circuit BB (CCITT 104). The Clear-to-Send interchange circuit CB (CCITT 106) is interrupted.						
Tx Clock: Int						
Next	Int	Ext	Prev			
Data Port Transmit Clock. Specifies whether the transmitted data for the port is clocked using an internal clock provided by the E1 DSU/CSU (synchronized to the clock source specified by the clock source configuration options in the General configuration option group) or an external clock provided by the DTE connected to the port. When an external clock is used, it must be synchronized to the same clock source as the E1 DSU/CSU.						
Int – Indicates the clock is provided internally by the E1 DSU/CSU on the TXC interchange circuit DB (CCITT 114).						
Ext – Indicates the clock is provided externally by the DTE on the XTXC interchange circuit DA (CCITT 113). Use this selection when either the primary or secondary clock source is set to this data port.						
InvertTxC: Disab						
Next	Enab	Disab	Prev			
Invert Transmit Clock. Specifies whether the clock supplied by the E1 DSU/CSU on the TXC interchange circuit DB (CCITT 114) is phase inverted with respect to the Transmitted Data interchange circuit BA (CCITT 103). This configuration option is useful when long cable lengths between the E1 DSU/CSU and the DTE are causing data errors.						
Enab – Indicates TXC supplied by the E1 DSU/CSU on this port is phase inverted.						
Disab – Indicates TXC supplied by the E1 DSU/CSU on this port is not phase inverted.						
InvertData: Disab						
Next	Enab	Disab	Prev			
Invert Transmitted and Received Data. Specifies whether the port's transmitted data and received data are logically inverted before being transmitted or received. This configuration option is useful for applications where HDLC data is being transported. Inverting the data ensures that the density requirements for the network Interface are met.						
Enab – Indicates the transmitted data and received data for this port are inverted.						
Disab – Indicates the transmitted data and received data for this port are not inverted.						

Table C-2
(3 of 4)
Port Configuration Options

EDL: Disab							
Next	Enab	Disab	Prev				
<p>Embedded Data Link. Specifies whether Embedded Data Link (EDL) is enabled for a particular port. If EDL is enabled, then 8 kbps of the total bandwidth allocated for this port is not available to the synchronous data port. For example, if the port rate is 256 kbps (4 DS0 channels allocated) and EDL is enabled, then only 248 kbps is available to the port. EDL provides the following: detection of frame synchronization, CRC of the data stream (excluding the 8 kbps EDL), and an in-band data link (4 kbps) between the local and remote units. The 4 kbps in-band data link can be used for performance report messages and as a management link for SNMP.</p> <p>Enab – Indicates the port's EDL is enabled.</p> <p>Disab – Indicates the port's EDL is disabled.</p> <p>NOTE: This configuration option is not available and does not appear if the E1 DSU/CSU does not have the necessary hardware to support EDL.</p> <p>NOTE: If the local E1 DSU/CSU's EDL is enabled, then the remote E1 DSU/CSU's EDL must also be enabled.</p> <p>NOTE: EDL is not recommended for networks in which data is examined for routing purposes (e.g., frame relay, x.25).</p>							
Err Rate: 10E-4							
Next	10E-4	10E-5	10E-6	10E-7	10E-8	10E-9	Prev
<p>Port Excessive Error Rate Threshold. Sets the error rate threshold that determines when an Excessive Error Rate (EER) condition is declared for a particular port. The error rate selected by this configuration option is determined by the ratio of the number of CRC5 errors to the total number of bits received over a set period of time.</p> <p>10E-4 – 10E-4 Threshold. For example, at 1984 kbps, EER is declared if more than 1,983 CRC5 errors are detected in a 10-second period. It is cleared with less than 1,984 errors in ten seconds.</p> <p>10E-5 – 10E-5 Threshold. For example, at 1984 kbps, EER is declared if more than 1,189 CRC5 errors are detected in a 60-second period. It is cleared with less than 1,190 errors in sixty seconds.</p> <p>10E-6 – 10E-6 Threshold. For example, at 1984 kbps, EER is declared if more than 119 CRC5 errors are detected in a 60-second period. It is cleared with less than 120 errors in sixty seconds.</p> <p>10E-7 – 10E-7 Threshold. For example, at 1984 kbps, EER is declared if more than 11 CRC5 errors are detected in a 60-second period. It is cleared with less than 12 errors in sixty seconds.</p> <p>10E-8 – 10E-8 Threshold. For example, at 1984 kbps, EER is declared if more than 53 CRC5 errors are detected in three 15-minute intervals. It is cleared with less than 54 errors in three 15-minute intervals.</p> <p>10E-9 – 10E-9 Threshold. For example, at 1984 kbps, EER is declared if more than 5 CRC5 errors are detected in three 15-minute intervals. It is cleared with less than 6 errors in three 15-minute intervals.</p> <p>NOTE: This configuration option is not available and does not appear if EDL is disabled.</p>							
Near-end: Disab							
Next	Disab	Maint	Send	Both	Prev		
<p>Near-End Performance Statistics. Specifies whether the E1 DSU/CSU will maintain near-end performance statistics and send performance report messages (PRMs) for a particular port.</p> <p>Disab – Disables near-end performance statistics and does not send PRMs.</p> <p>Maint – Maintains near-end performance statistics for this port.</p> <p>Send – Sends PRMs over the port's EDL every second. Each PRM contains the performance statistics for the previous 4 seconds.</p> <p>Both – Maintains near-end performance statistics and sends PRMs over the port's EDL.</p> <p>NOTE: This configuration option is not available and does not appear if EDL is disabled.</p> <p>NOTE: If the local E1 DSU/CSU is configured to send near-end performance statistics, then the remote E1 DSU/CSU must be configured to maintain far-end performance statistics.</p>							

Table C-2
(4 of 4)
Port Configuration Options

Far-end: Disab			
Next	Disab	Maint	Prev
<p>Far-End Performance Statistics. Specifies whether to monitor for far-end performance report messages (PRMs) and maintain far-end performance registers for a particular port.</p> <p>Disab – Disables far-end performance statistics.</p> <p>Maint – Monitors the port's EDL for PRMs and maintains far-end performance statistics.</p> <p>NOTE: This configuration option is not available and does not appear if EDL is disabled.</p> <p>NOTE: If the local E1 DSU/CSU is configured to maintain far-end performance statistics, then the remote E1 DSU/CSU must be configured to send near-end performance statistics.</p>			
Mgmt Link: Disab			
Next	Disab	SNMP	Prev
<p>EDL Management Link. Specifies whether the EDL management link is enabled for a particular port. Selecting SNMP allows SNMP management traffic to flow over the 4 kbps in-band data link provided by EDL.</p> <p>Disab – Disables the port's EDL management link.</p> <p>SNMP – Enables the port's EDL management link.</p> <p>NOTE: This configuration option is not available and does not appear if EDL is disabled or FDL is enabled for SNMP.</p> <p>NOTE: If the local E1 DSU/CSU's EDL is enabled, then the remote E1 DSU/CSU's EDL must also be enabled.</p>			

Network Interface Configuration Options

Table C-3
Network Interface Configuration Options

<p>NET Frame: noCRC Next CRC4 noCRC Prev</p> <p>Network Line Framing Format. Designates the framing format for the Network E1 interface.</p> <p>CRC4 – Configures for the CRC4 framing format.</p> <p>noCRC – Configures for the non-CRC4 framing format.</p>
<p>Mgmt Link: Disab Next Disab SNMP Prev</p> <p>FDL Management Link. Specifies whether Facility Data Link (FDL) is enabled. Selecting SNMP allows SNMP management traffic to flow over the 4 kbps data link provided by FDL. Running SNMP over FDL requires an end-to-end FDL connection and cannot be terminated within the network.</p> <p>Disab – Disables the FDL Management Link.</p> <p>SNMP – Enables the FDL Management Link for SNMP.</p> <p>NOTE: This configuration option is not available and does not appear if EDL is enabled for SNMP.</p> <p>NOTE: If the local E1 DSU/CSU's FDL is enabled for SNMP, the remote E1 DSU/CSU's FDL must also be enabled for SNMP.</p>
<p>Circuit Ident: Next Edit Clear Prev</p> <p>Network Circuit Identifier. Specifies the transmission vendor's circuit identifier for the purpose of facilitating troubleshooting. The network circuit identifier is an ASCII text string that may be up to 255 characters in length.</p> <p>Edit – Allows you to edit and/or display the network circuit identifier using the generic text string entry screen.</p> <p>Clear – Allows you to clear the network circuit identifier. The network circuit identifier will be set to a null string.</p>

Channel Configuration Options

The Channel configuration options are divided into two tables as follows:

- DTE Channel Configuration Options (Table C-4)
- Data Port Channel Configuration Options (Table C-5)

NOTE

Entering the Channel (Chan) Configuration branch allows you to select Display (Dsply), Clear, DTE (if enabled), or one of the data ports. Tables C-4 and C-5 describe the DTE and data port configuration options. For information about the operation of Display and Clear, refer to the *Configuring DS0 Channels* section in Chapter 3, *Operation*.

**Table C-4
DTE Channel Configuration Options**

DTE Channels: TS16 Assign																
DTE Drop/Insert Channel. Allows the selection of time-slot 16 (TS16) for signaling information or assigns DS0 channels from the DTE Drop/Insert interface to DS0 channels on the Network E1 interface.																
TS16 – Allows the selection of TS16 for signaling information (see the TS16 configuration option below).																
Assign – Allows the assignment of DS0 channels from the DTE Drop/Insert interface to the Network E1 interface.																
TS16: Rsvd Data Rsvd																
DTE Drop/Insert TS16 Allocation. Specifies whether time-slot 16 (TS16) is reserved for signaling information or available for data.																
Data – Specifies that TS16 is available for data.																
Rsvd – Specifies that TS16 is reserved for signaling information.																
NOTE: Changing this configuration option from one selection to the other (Data or Rsvd), deallocates all DS0 channels assigned to either the Network E1 interface or the DTE Drop/Insert interface.																
N1	N2	N3	N4	N5	N6	N7	N8	N9	N10	N11	N12	N13	N14	N15	...	N31
–	–	–	–	–	–	–	–	–	–	–	–	–	–	–	...	–
DTE Drop/Insert Channel Allocation. Assigns DS0 channels from the DTE Drop/Insert interface to the Network E1 interface.																
Line 1 displays the 31 channels for the Network E1 interface. Line 2 displays what is allocated to the DS0 channel indicated in Line 1. Possible values for Line 2 are:																
Value Meaning																
– This DS0 channel is not allocated. You can modify this value on this screen.																
Prtn This DS0 channel is allocated to port <i>n</i> , where <i>n</i> is a number from 1 to 4. You cannot modify this value on this screen.																
Dn This DS0 channel is allocated to the DTE Drop/Insert interface DS0 channel <i>n</i> , where <i>n</i> is a number from 1 to 31. You can modify this value on this screen.																
Assign DTE channels to Network channels by pressing the Function key below the Network channel desired. The DTE channel number scrolls up one number each time you press the Function key. Only unassigned DTE channels appear during scrolling.																
NOTE: If time-slot 16 is reserved for signaling (see the TS16 configuration option), D16 is automatically allocated to N16 and will not be available for allocation on this screen.																

**Table C-5
(1 of 3)
Data Port Channel Configuration Options**

Channel Config: Dsply Clear DTE Prt1 Prt2 Prt3 Prt4
<p>NOTE: The configuration options described in this table are made available by selecting Prt1, Prt2, Prt3, or Prt4 from this Channel Config screen. Table C-4 describes the DTE configuration options. For information about the operation of Display and Clear, refer to the <i>Configuring DS0 Channels</i> section in Chapter 3, <i>Operation</i>.</p>
<p>Data Port Channel. Allows the assignment of a particular port to DS0 channels on either the Network E1 interface, the DTE Drop/Insert interface, or another port (see the Assign To configuration option below).</p> <p>NOTE: For Model 3172 DSU/CSUs, only Ports 1 and 2 are available.</p>
Assign To: NET Next NET DTE Prtn Prtn Prtn Prev
<p>Data Port Channel Allocation Destination. Allows you to assign this port to DS0 channels on either the Network E1 interface, the DTE Drop/Insert interface, or another port.</p> <p>NET – Assigns this port to DS0 channels on the Network E1 interface.</p> <p>DTE – Assigns this port to DS0 channels on the DTE Drop/Insert interface. If the DTE Drop/Insert interface is disabled, this selection is not displayed.</p> <p>Prtn – Assigns this port to another port, where <i>n</i> is the port number of all available ports except the port selected from the Channel Config screen. For example, if you select Prt1 from the Channel Config screen, Prt2, Prt3, and Prt4 appear for the 3174. Use this feature to designate a port as a backup port. You can attach an external backup device to Prtn and manually assign the selected port to the backup port (i.e., route data from the selected port to the backup port). When a port is assigned to another port, DSR is turned on. Selecting Prtn and Next takes you directly to the Port Rate configuration option, bypassing the Assign By configuration option. Only data ports with matching port base rates (i.e., Nx56 or Nx64) are displayed. Also, EDL does not operate when a synchronous data port is assigned to another synchronous data port. Therefore, if EDL is enabled, it is ignored.</p> <p>NOTE: Changing this configuration option from one E1 interface to the other (NET or DTE) deallocates all DS0 channels allocated to the previous interface.</p>
Assign By: Block Next Block Chan Prev
<p>Data Port Channel Allocation Method. If NET or DTE is selected using the Assign To configuration option, this configuration option designates the method for assigning DS0 channels to the destination E1 interface.</p> <p>Block – Allocates DS0 channels to this port by the block method.</p> <p>Chan – Allocates DS0 channels to this port by the individual channel method.</p> <p>NOTE: If time-slot 16 is reserved for signaling, the DS0 channels associated with time-slot 16 are not available for assignment using either method (Block or Chan).</p> <p>NOTE: Changing this configuration option from one method to the other (Block or Chan) deallocates all DS0 channels assigned to either the Network E1 interface or the DTE Drop/Insert interface.</p>

**Table C-5
(2 of 3)
Data Port Channel Configuration Options**

Port Rate: 384																	
Next	64	128	192	256	320	384	448	512	576	640	704	768	832	896	960	1024	1088
	1152	1216	1280	1344	1408	1472	1536	1600	1664	1728	1792	1856	1920	1984	Prev		
OR																	
Next	56	112	168	224	280	336	392	448	504	560	616	672	728	784	840	896	952
	1008	1064	1120	1176	1232	1288	1344	1400	1456	1512	1568	1624	1680	1736	Prev		
<p>Data Port Rate (appears when using the block channel allocation method, or when a synchronous data port is assigned to another synchronous data port). Designates the data rate for the port. Available selections depend on the current base rate configured for the port. The factory default for Nx64 is 384 kbps, and for Nx56 is 336 kbps.</p> <p>NOTE: This configuration option does not appear if the individual channel allocation method (Chan) is selected using the Assign By configuration option.</p> <p>NOTE: If time-slot 16 is reserved for signaling, the highest port rate (1984 or 1736) does not appear.</p> <p>NOTE: Changing this configuration option from one rate to another deallocates all DS0 channels assigned to either the Network E1 interface or the DTE Drop/Insert interface.</p> <p>NOTE: When you enable EDL, 8 kbps of the total bandwidth allocated for this port is not available to the synchronous data port. For example, if you select 256 kbps and EDL is enabled, only 248 kbps are available.</p> <p>NOTE: When you enable EDL for a synchronous data port and the clock source (either primary or secondary) is set to that synchronous data port, the external device must provide a clock of 8 kbps less than the expected data port rate. For example, if you select 64 kbps, the external clock source must supply a 56 kbps clock signal.</p> <p>NOTE: For the 3174 DSU/CSU there is a hardware limitation that limits the combined bandwidth used by Port1 and Port3 to a total of 2048 kbps and the combined bandwidth used by Port2 and Port4 to 2048 kbps. Thus, when entering this menu, the rate choices are limited due to this constraint. This limitation only occurs in configurations mapping a port to a port or when mapping ports to the DTE Drop/Insert interface and to the network.</p>																	
Start At:																	
Next	Clear	N1	N2	N3	N4	N5	N6	N7	N8	N9	N10	N11	...	N31	Prev		
OR																	
Start At:																	
Next	Clear	D1	D2	D3	D4	D5	D6	D7	D8	D9	D10	D11	...	D31	Prev		
<p>Data Port Channel Allocation (appears for the block method only). Designates the starting DS0 channel (N1–N31 for the Network E1 interface and D1–D31 for the DTE Drop/Insert interface).</p> <p>Available selections are only those DS0 channels that provide enough bandwidth (based on the configured data rate) to be used as a starting channel number.</p> <p>Select the desired starting channel number by pressing the Function key under that number. When you make the selection, the E1 DSU/CSU allocates the correct amount of DS0 channels to support the data rate currently configured for the port.</p> <p>Clear – Deallocates all DS0 channels for this port from either the Network E1 interface or the DTE Drop/Insert interface.</p> <p>NOTE: This configuration option does not appear if the individual channel allocation method (Chan) is selected using the Assign By configuration option, or if Prtn is selected using the Assign To configuration option.</p>																	

**Table C-5
(3 of 3)
Data Port Channel Configuration Options**

Next	N1	N2	N3	N4	N5	N6	N7	N8	N9	N10	N11	N12	...	N31	Prev
	-	-	-	-	-	-	-	-	-	-	-	-	...		
<i>OR</i>															
Next	D1	D2	D3	D4	D5	D6	D7	D8	D9	D10	D11	D12	...	D31	Prev
	-	-	-	-	-	-	-	-	-	-	-	-	...		

Data Port Channel Allocation (appears for the individual channel method only). Designates the DS0 channel to allocate to this port (N1–N31 for the Network E1 interface and D1–D31 for the DTE Drop/Insert interface).

Line 1 displays the 31 channels for the Network E1 interface or the DTE Drop/Insert interface. Line 2 displays what is allocated to the DS0 channel indicated in Line 1. Possible values for Line 2 are:

<u>Value</u>	<u>Meaning</u>
-	This DS0 channel is not allocated. You can modify this value on this screen.
Prtn	This DS0 channel is allocated to port <i>n</i> , where <i>n</i> is a number from 1 to 4. You can modify this value on this screen for this port only.
Nn	This DS0 channel is allocated to the Network E1 interface DS0 channel <i>n</i> , where <i>n</i> is a number from 1 to 31. You cannot modify this value on this screen.
Dn	This DS0 channel is allocated to the DTE Drop/Insert interface DS0 channel <i>n</i> , where <i>n</i> is a number from 1 to 31. You can modify this value on this screen.

Select the channel by pressing the Function key under that number. To deallocate a port, press the Function key under that port number. Pressing the Function key under channels assigned to other ports has no effect.

NOTE: The E1 DSU/CSU automatically derives the data rate for the port from the number of DS0 channels allocated.

NOTE: If time-slot 16 is reserved for signaling, D16 automatically connects to N16 and cannot be changed from this screen.

NOTE: For the 3174 DSU/CSU there is a hardware limitation that limits the combined bandwidth used by Port1 and Port3 to a total of 2048 kbps and the combined bandwidth used by Port2 and Port4 to 2048 kbps. If a selection of Prtn causes this limit to be exceeded, the selection is ignored and the “-” will continue to be displayed for the channel.

General Configuration Options

Table C-6
General Configuration Options

Pri Clk Src: NET										
Next	NET	DTE	Prt1	Prt2	Prt3	Prt4	Int	Ext	Prev	
<p>Primary Clock Source. Specifies the primary clock source for the E1 DSU/CSU. This selection synchronizes all internal timing and external interface clocks. Failure of the clock specified by this selection results in automatic fallback to the secondary clock source.</p> <p>NET – Configures the Network E1 interface as the primary clock source.</p> <p>DTE – Configures the DTE Drop/Insert interface as the primary clock source. This selection is not available if the DTE Drop/Insert interface is disabled. If the DTE Drop/Insert interface is disabled after making this selection, the primary clock source is changed to NET.</p> <p>Prt1, 2, 3, 4 – Configures data port 1, 2, 3, or 4 as the primary clock source. Set the same port's Transmit Clock to External. If you enable EDL for the same port, the external device must provide clocking of 8 kbps less than the expected data port rate. For example, if you select 64 kbps, the external clock must supply a 56 kbps clock signal.</p> <p>Int – Configures the internal clock as the primary clock source.</p> <p>Ext – Configures an external clock (provided through the Clock In connector) as the primary clock source.</p> <p>NOTE: For Model 3172 DSU/CSUs, Ports 3 and 4 are not available.</p>										
Sec Clk Src: NET										
Next	NET	DTE	Prt1	Prt2	Prt3	Prt4	Ext	Disab	Prev	
<p>Secondary Clock Source. Specifies the secondary clock source for the E1 DSU/CSU. Failure of the clock specified by the Primary Clock Source selection results in automatic fallback to the secondary clock source. When this occurs, this selection synchronizes all internal timing and external interface clocks. Failure of the clock specified by the Secondary Clock Source selection results in automatic fallback to internal clock.</p> <p>NET – Configures the Network E1 interface as the secondary clock source.</p> <p>DTE – Configures the DTE Drop/Insert interface as the secondary clock source. This selection is not available if the DTE Drop/Insert interface is disabled. If the DTE Drop/Insert interface is disabled after making this selection, the secondary clock source is changed to NET.</p> <p>Prt1, 2, 3, 4 – Configures data port 1, 2, 3, or 4 as the secondary clock source. Set the same port's Transmit Clock to External. If you enable EDL for the same port, the external device must provide clocking of 8 kbps less than the expected data port rate. For example, if you select 64 kbps, the external clock must supply a 56 kbps clock signal.</p> <p>Ext – Configures an external clock (provided through the Clock In connector) as the secondary clock source.</p> <p>Disab – Disables the secondary clock source. Failure of the primary clock source results in automatic fallback to the internal clock.</p> <p>NOTE: For Model 3172 DSU/CSUs, Ports 3 and 4 are not available.</p>										
Clock Rate: 2048										
Next	2048	8	Prev							
<p>External Clock Rate. Specifies the clock rate when the primary or secondary clock source is configured for external clock (Ext). This configuration option does not appear when the clock source is not an external clock.</p> <p>2048 – Sets the input rate of the external clock to 2,048 kHz.</p> <p>8 – Sets the input rate of the external clock to 8 kHz.</p>										

User Interface Configuration Options

Table C-7
(1 of 3)
User Interface Configuration Options

<p>Self-Test: Enab Next Enab Disab Prev</p> <p>Initial Self-Test. Specifies whether the E1 DSU/CSU performs a device self-test at power-up and after a device reset.</p> <p>Enab – Enables a self-test.</p> <p>Disab – Disables the self-test.</p>
<p>Com Use: ASCII Next SNMP ASCII Daisy Prev</p> <p>Communication Port Use. Specifies how the communication port is used. The communication port can be configured for only one use (each use is mutually exclusive): it can be configured as the management link to an external SNMP manager, it can be configured as a proprietary ASCII port, or it can be configured as an SNMP management link daisy chained to another 31xx Series device.</p> <p>SNMP – Specifies that the communication port is used as the management link to an external SNMP manager.</p> <p>ASCII – Specifies that the communication port is used as a proprietary ASCII port supporting Front Panel Emulation software and ASCII alarm messages.</p> <p>Daisy – Specifies that the communication port is used as an SNMP management port that is daisy chained to the auxiliary port of an another 31xx Series device.</p> <p>NOTE: SNMP and ASCII selections can be made using the ifAdminStatus MIB object (up = SNMP, testing = ASCII).</p> <p>NOTE: The Daisy selection requires the use of a customer-supplied, 8-pin-to-8-pin, straight-through cable. Whenever the cable is connected or disconnected, you should change the Daisy selection (as appropriate) to ensure that the correct parameters have been negotiated for the link layer.</p>
<p>Com Type: Async Next Async Sync Prev</p> <p>Communication Port Type. Specifies whether the communication port uses synchronous or asynchronous operation when it is configured as the SNMP management link.</p> <p>Async – Configures the communication port for asynchronous operation.</p> <p>Sync – Configures the communication port for synchronous operation.</p> <p>NOTE: This configuration option is not available if the Com Use configuration option is set to ASCII or Daisy. In these cases, the communication port is always asynchronous.</p>
<p>Com Clk: Int Next Int Ext Prev</p> <p>Communication Port Synchronous Clock. Specifies whether the communication port uses internal or external clocking when it is configured for synchronous operation.</p> <p>Int – Configures the communication port for internal clocking.</p> <p>Ext – Configures the communication port for external clocking.</p> <p>NOTE: This configuration option is not available if the Com Type configuration option is set to Async.</p>

Table C-7
(2 of 3)
User Interface Configuration Options

Com Rate: 9.6								
Next	1.2	2.4	4.8	9.6	14.4	19.2	38.4	Prev
Communication Port Rate. Configures the bit rate for the communication port.								
1.2 – Sets the bit rate to 1200 bps.								
2.4 – Sets the bit rate to 2400 bps.								
4.8 – Sets the bit rate to 4800 bps.								
9.6 – Sets the bit rate to 9600 bps.								
14.4 – Sets the bit rate to 14,400 bps.								
19.2 – Sets the bit rate to 19,200 bps.								
38.4 – Sets the bit rate to 38,400 bps.								
NOTE: This configuration option is not available if the communication port is configured for synchronous operation and the clock source is external.								
Char Length: 8								
Next	7	8	Prev					
Communication Port Character Length. Configures the character length (7 or 8 bits) for the communication port.								
NOTE: This configuration option must be set to 8 if the communication port is used for Front Panel Emulation or SNMP management.								
NOTE: This configuration option is not available if the communication port is configured for synchronous operation.								
CParity: None								
Next	None	Even	Odd	Prev				
Communication Port Parity. Configures the parity (none , even , or odd) for the communication port.								
NOTE: This configuration option is not available if the communication port is configured for synchronous operation.								
CStop Bits: 1								
Next	1	1.5	2	Prev				
Communication Port Stop Bits. Configures the number of stop bits (1, 1.5, or 2) for the communication port.								
NOTE: This configuration option is not available if the communication port is configured for synchronous operation.								

Table C-7
(3 of 3)
User Interface Configuration Options

Ignore DTR: No Next Yes No Prev
<p>Communication Port Ignore DTR State. Specifies whether the E1 DSU/CSU ignores the state of the Data Terminal Ready (DTR) input to the communication port.</p> <p>Yes – DTR is ignored.</p> <p>No – DTR is not ignored.</p> <p>NOTE: This configuration option is not available if the communication port is configured for synchronous operation.</p>
Aux Use: None Next None SNMP Daisy Prev
<p>Auxiliary Port Use. Specifies how the auxiliary port is used. The auxiliary port only supports Point-to-Point Protocol (PPP) with the following parameters: type is asynchronous, character length is 8, parity is none, and stop bit is 1.</p> <p>None – Specifies that the auxiliary port is not to be used.</p> <p>SNMP – Specifies that the auxiliary port is to be used as the management link to an external SNMP manager via an external LAN Adapter.</p> <p>Daisy – Specifies that the auxiliary port is to be used as an SNMP management link that is daisy chained to the communication port of another 31xx Series device.</p> <p>NOTE: The Daisy or SNMP selection requires the use of a customer-supplied, 8-pin-to-8-pin, straight-through cable. Whenever the cable is connected or disconnected, you should change the selection to None, and then back to Daisy or SNMP, to ensure that the correct parameters have been negotiated for the link layer.</p>
Aux Rate: 19.2 Next 9.6 14.4 19.2 38.4 Prev
<p>Auxiliary Port Rate. Configures the bit rate for the auxiliary port.</p> <p>9.6 – Configures the auxiliary port rate as 9600 bps.</p> <p>14.4 – Configures the auxiliary port rate as 14,400 bps.</p> <p>19.2 – Configures the auxiliary port rate as 19,200 bps.</p> <p>38.4 – Configures the auxiliary port rate as 38,400 bps.</p>

Alarm Configuration Options

Table C-8
Alarm Configuration Options

Alarm Msg: Disab			
Next	Enab	Disab	Prev
<p>Alarm Messages. Controls the generation of alarm messages, which are routed to an ASCII terminal or printer attached to the communication port. For more information, refer to the <i>Alarms</i> section in Chapter 4, <i>Maintenance</i>.</p> <p>Enab – Enables alarm messages routed to the communication port.</p> <p>Disab – Prevents alarm messages for any alarm conditions.</p> <p>NOTE: Alarm messages are only sent to the communication port if the Com Use configuration option is set to ASCII, otherwise the alarm messages are discarded.</p>			
SNMP Trap: Disab			
Next	Enab	Disab	Prev
<p>SNMP Trap Enable. Specifies whether SNMP trap messages are sent over the SNMP management link. For more information, refer to the <i>SNMP Traps</i> section in Chapter 4, <i>Maintenance</i>.</p> <p>Enab – Enables sending SNMP trap messages from this unit over any SNMP management link.</p> <p>Disab – Disables sending SNMP trap messages from this unit over any SNMP management link.</p>			

SNMP Configuration Options

The SNMP configuration options are divided into two tables as follows:

- General SNMP Configuration Options (Table C-9)
- SNMP Trap Configuration Options (Table C-10)

Table C-9
(1 of 4)
General SNMP Configuration Options

<p>System Name: Next Edit Clear Prev</p> <p>System Name. Specifies the SNMP system name for this unit. This is the name of this SNMP-managed node. Edit – Allows you to edit or display the system name. Clear – Allows you to clear the system name.</p>
<p>System Location: Next Edit Clear Prev</p> <p>System Location. Specifies the SNMP system location for this unit. This is the physical location of this SNMP-managed node. Edit – Allows you to edit or display the system location. Clear – Allows you to clear the system location.</p>
<p>System Contact: Next Edit Clear Prev</p> <p>System Contact. Specifies the SNMP system contact person for this unit, and how to contact this person. Edit – Allows you to edit or display the system contact. Clear – Allows you to clear the system contact.</p>
<p>CommunityName1:public Next Edit Clear Prev</p> <p>Community Name 1. Specifies the first of two community names that are allowed to access this unit's Management Information Base (MIB). External SNMP managers must supply this name to access an object in the MIB. Edit – Allows you to edit or display the first community name. The factory default sets this string to <i>public</i>. Clear – Allows you to clear the first community name.</p>
<p>Access 1: Read Next Read R/W Prev</p> <p>Access 1. Specifies the type of access allowed for community name 1. This is the type of access allowed for external SNMP managers accessing objects in the MIB using community name 1. Read – Allows read-only access (SNMP Get) to the accessible objects in the MIB for this device when community name 1 is used. This includes all objects specified as either read-only or read/write in the MIB RFCs. R/W – Allows read and write access (SNMP Get and Set) to the objects in the MIB for this device when community name 1 is used. Write access is allowed for all objects specified as read/write in the MIB RFCs. Read access is allowed for all objects specified as either read-only or read/write.</p>

Table C-9
(2 of 4)
General SNMP Configuration Options

CommunityName2: Next Edit Clear Prev
<p>Community Name 2. Specifies the second of two community names that are allowed to access this unit's Management Information Base (MIB). External SNMP managers must supply this name to access an object in the MIB.</p> <p>Edit – Allows you to edit or display the second community name.</p> <p>Clear – Allows you to clear the second community name.</p>
Access 2: Read Next Read R/W Prev
<p>Access 2. Specifies the type of access allowed for community name 2. This is the type of access allowed for external SNMP managers accessing objects in the MIB using community name 2.</p> <p>Read – Allows read-only access (SNMP Get) to the accessible objects in the MIB for this device when community name 2 is used. This includes all objects specified as either read-only or read/write in the MIB RFCs.</p> <p>R/W – Allows read and write access (SNMP Get and Set) to the objects in the MIB for this device when community name 2 is used. Write access is allowed for all objects specified as read/write in the MIB RFCs. Read access is allowed for all objects specified as either read-only or read/write.</p>
IP Adr: Next Edit Clear Prev
<p>IP Address for the E1 DSU/CSU. Specifies the IP address needed to access the E1 DSU/CSU. Since this IP Address is not bound to a particular port, it can be used for remote access via the FDL or EDL management link.</p> <p>Edit – Allows you to edit and/or display the IP address for the E1 DSU/CSU.</p> <p>Clear – Allows you to clear the IP address for the E1 DSU/CSU. The IP address is set to 000.000.000.000.</p>
NetMask: Next Edit Clear Prev
<p>Subnet Mask for the E1 DSU/CSU. Specifies the subnet mask needed to access the E1 DSU/CSU. Since this subnet mask is not bound to a particular port, it can be used for remote access via the FDL or EDL management link.</p> <p>Edit – Allows you to edit and/or display the subnet mask for the E1 DSU/CSU.</p> <p>Clear – Allows you to clear the subnet mask for the E1 DSU/CSU. The subnet mask is set to 000.000.000.000. If the subnet mask is 000.000.000.000, the IP protocol creates a default subnet mask based on the class of the IP address (Class A: 255.000.000.000, Class B: 255.255.000.000, or Class C: 255.255.255.000).</p>

Table C-9
(3 of 4)
General SNMP Configuration Options

Com IP Adr: Next Edit Clear Prev
<p>Com Port IP Address. Specifies the IP address for the communication port when it is configured as the SNMP management link. The IP address is only in effect when the Com Use configuration option is set to SNMP or Daisy.</p> <p>Edit – Allows you to edit or display the IP address for the communication port.</p> <p>Clear – Allows you to clear the IP address for the communication port.</p>
Com NetMask: Next Edit Clear Prev
<p>Subnet Mask for the Communication Port. Specifies the subnet mask needed to access the unit when the communication port is configured as the SNMP management link. The subnet mask is only in effect when the Com Use configuration option is set to SNMP or Daisy.</p> <p>Edit – Allows you to edit and/or display the subnet mask for the communication port.</p> <p>Clear – Allows you to clear the subnet mask for the communication port. The subnet mask is set to 000.000.000.000. If the subnet mask is 000.000.000.000, the IP protocol creates a default subnet mask based on the class of the IP address (Class A: 255.000.000.000, Class B: 255.255.000.000, or Class C: 255.255.255.000).</p>
Com Link: PPP Next PPP SLIP Prev
<p>Com Port Link Layer Protocol. Specifies the link layer protocol for the communication port when it is configured as the SNMP management link. This protocol is only in effect when the Com Use configuration option is set to SNMP.</p> <p>PPP – Specifies PPP as the link layer protocol for the SNMP management link on the communication port.</p> <p>SLIP – Specifies SLIP as the link layer protocol for the SNMP management link on the communication port. The communication port must be configured for asynchronous operation to support SLIP. This selection does not appear if the Com Use configuration option is set to Daisy.</p>

**Table C-9
(4 of 4)
General SNMP Configuration Options**

<p>Aux IP Adr: Next Edit Clear Prev</p> <p>IP Address for the Auxiliary Port. Specifies the IP address needed to access the unit when the auxiliary port is configured as the SNMP management link. The IP address is only in effect when the Aux Use configuration option is set to SNMP or Daisy. The auxiliary port only supports the PPP link protocol.</p> <p>Edit – Allows you to edit and/or display the IP address for the auxiliary port.</p> <p>Clear – Allows you to clear the IP address for the auxiliary port. The IP address will be set to 000.000.000.000.</p>									
<p>Aux NetMask: Next Edit Clear Prev</p> <p>Subnet Mask for the Auxiliary Port. Specifies the subnet mask needed to access the unit when the auxiliary port is configured as the SNMP management link. The subnet mask is only in effect when the Aux Use configuration option is set to SNMP or Daisy.</p> <p>Edit – Allows you to edit and/or display the subnet mask for the auxiliary port.</p> <p>Clear – Allows you to clear the subnet mask for the auxiliary port. The subnet mask is set to 000.000.000.000. If the subnet mask is 000.000.000.000, the IP protocol creates a default subnet mask based on the class of the IP address (Class A: 255.000.000.000, Class B: 255.255.000.000, or Class C: 255.255.255.000).</p>									
<p>Def Netwk: None Next None Com Aux FDL EDL1 EDL2 EDL3 EDL4 Prev</p> <p>Default Network Destination. Specifies the default network destination. This configuration option specifies where the default network is connected. For example, if the default network is connected to the communication port, you select Com. If the default network is connected to the far-end 31xx Series device over the FDL, you select FDL. The routing protocol uses the default network destination to route data that does not have a specific route.</p> <p>None – No default network destination. Data that cannot be routed is discarded.</p> <p>Com – The default network destination is the communication port. This selection only appears if the Com Use configuration option is set to SNMP.</p> <p>Aux – The default network destination is the auxiliary port. This selection only appears if the Aux Use configuration option is set to SNMP.</p> <p>FDL – The default network destination is FDL. This selection only appears if the FDL management link is enabled for SNMP.</p> <p>EDLn – The default network destination is the EDLn port (where n is 1–4). This selection only appears if the synchronous data port's EDL management link is enabled for SNMP.</p> <p>NOTE: If the chosen default network link is disabled or down, data is discarded and you should return to this menu and choose another default network.</p>									

Table C-10
(1 of 2)
SNMP Trap Configuration Options

Num Trap Mgrs: 1									
Next	1	2	3	4	5	6	Prev		
Number of Trap Managers. Specifies the number of SNMP trap managers that are to receive traps for this unit. NOTE: You must configure an IP address for each trap manager that is to receive trap messages.									
Trap <i>n</i> IP Addr: Clear									
Next	Edit		Clear		Prev				
Trap <i>n</i> IP Address. Specifies the IP address for each trap manager. This configuration option is repeated for all trap managers supported by the unit. Edit – Allows you to edit or display the IP address for Trap Manager <i>n</i> . Clear – Allows you to clear the IP address for Trap Manager <i>n</i> .									
Trap <i>n</i> Dst: None									
Next	None	Com	Aux	FDL	EDL1	EDL2	EDL3	EDL4	Prev
Trap Manager <i>n</i> Destination. Specifies the network destination for Trap Manager <i>n</i> . This configuration option is displayed for the number of trap managers (<i>n</i>) specified by the Number of Trap Managers configuration option. None – No Trap Manager <i>n</i> network destination. Traps are discarded. Com – The Trap Manager <i>n</i> network destination is the communication port. This selection only appears if the Com Use configuration option is set to SNMP or Daisy. Aux – The Trap Manager <i>n</i> network destination is the auxiliary port. This selection only appears if the Aux Use configuration option is set to SNMP or Daisy. FDL – The Trap Manager <i>n</i> network destination is the FDL management link. This selection only appears if the FDL management link is enabled for SNMP. EDL<i>n</i> – The Trap Manager <i>n</i> network destination is the EDL <i>n</i> port (where <i>n</i> is 1–4). This selection only appears if the synchronous data port's EDL management link is enabled for SNMP. NOTE: If the chosen destination link is disabled or down, the traps are discarded. Change the trap destination if the link ceases to be operational.									
Gen Trap: Both									
Next	Disab	Warm	Auth	Both	Prev				
General Trap Types. Specifies the general trap types to enable. For more information, refer to the <i>SNMP Traps</i> section in Chapter 4, <i>Maintenance</i> . Disab – Disables the sending of trap messages for warmStart and authenticationFailure events. Warm – Sends trap messages for warmStart events to the currently configured trap manager(s). Auth – Sends trap messages for authenticationFailure events to the currently configured trap manager(s). Both – Sends trap messages for warmStart and authenticationFailure events to the currently configured trap manager(s). NOTE: This configuration option is not available and does not appear if the SNMP Trap configuration option (in the <i>Alarm Configuration Options</i> section) is disabled.									

Table C-10
(2 of 2)
SNMP Trap Configuration Options

Entp Trap: Enab						
Next	Enab	Disab	Prev			
Enterprise Specific Traps. Specifies whether enterpriseSpecific traps are enabled. For more information, refer to the <i>SNMP Traps</i> section in Chapter 4, <i>Maintenance</i> .						
Enab – Sends trap messages for enterpriseSpecific events to the currently configured trap manager(s).						
Disab – Disables the sending of trap messages for enterpriseSpecific events.						
NOTE: This configuration option is not available and does not appear if the SNMP Trap configuration option (in the <i>Alarm Configuration Options</i> section) is disabled.						
Link Trap: Both						
Next	Disab	Up	Down	Both	Prev	
Link Trap Type. Specifies the link trap type to enable. Interfaces monitored for linkUp and linkDown traps can be specified with the Trap I/F configuration option. For more information, refer to the <i>SNMP Traps</i> section in Chapter 4, <i>Maintenance</i> .						
Disab – Disables the sending of trap messages for linkDown or linkUp events.						
Up – Sends trap messages for linkUp events to the currently configured trap manager(s).						
Down – Sends trap messages for linkDown events to the currently configured trap manager(s).						
Both – Sends trap messages for linkUp and linkDown events to the currently configured trap manager(s).						
NOTE: This configuration option is not available and does not appear if the SNMP Trap configuration option (in the <i>Alarm Configuration Options</i> section) is disabled.						
Trap I/F: All						
Next	NET	DTE	E1s	Ports	All	Prev
Link Trap Interfaces. Specifies which interfaces generate linkUp and linkDown trap messages. These traps are supported on the E1 interfaces (network and DTE Drop/Insert) and the synchronous data ports.						
NET – Sends trap messages for linkUp and linkDown events occurring on the network interface.						
DTE – Sends trap messages for linkUp and linkDown events occurring on the DTE Drop/Insert interface. This selection is not displayed if the DTE Drop/Insert interface is disabled.						
E1s – Sends trap messages for linkUp and linkDown events occurring on either the network or DTE Drop/Insert interface.						
Ports – Sends trap messages for linkUp and linkDown events occurring on the synchronous data ports.						
All – Sends trap messages for linkUp and linkDown events occurring on the network interface, DTE Drop/Insert interface, or the synchronous data ports.						
NOTE: This configuration option is not available and does not appear if the Link Trap configuration option is not configured to generate trap messages for linkUp or linkDown events.						

Configuration Worksheets

This section contains one set of blank worksheets to be used when configuring your E1 DSU/CSU in the network. It is recommended that you copy these blank worksheets before using them.

DTE Options	Value
DTE Port	Enab, Disab
DTE Frame	CRC4, noCRC
DTE Coding	AMI, HDB3
Extrn DLB	Enab, Disab
Send Ones	Enab, Disab

Net Options	Value
NET Frame	CRC4, noCRC
Mgmt Link	Disab, SNMP
Circuit Ident	Edit, Clear

General Options	Value
Pri Clk Src	NET, DTE, Prt1, Prt2, Prt3, Prt4, Int, Ext
Sec Clk Src	NET, DTE, Prt1, Prt2, Prt3, Prt4, Ext, Disab
Clock Rate	2048, 8

User Options	Value
Self-Test	Enab, Disab
Com Use	SNMP, ASCII, Daisy
Com Type	Async, Sync
Com Clk	Int, Ext
Com Rate	1.2, 2.4, 4.8, 9.6, 14.4, 19.2, 38.4
Char Length	7, 8
CParity	None, Even, Odd
CStop Bits	1, 1.5, 2
Ignore DTR	Yes, No
Aux Use	None, SNMP, Daisy
Aux Rate	9.6, 14.4, 19.2, 38.4

Alarm Options	Value
Alrm Msg	Enab, Disab
SNMP Trap	Enab, Disab

Prt1 Options	Value
Port Type	E530, V.35, RS449
Base Rate	Nx64, Nx56
NetDCLB	Enab, Disab
Port LB	Disab, DTLB, DCLB, Both
All Ones	Disab, DTR, RTS, Both
Rcv RAI	None, Halt
Tx Clock	Int, Ext
InvertTxC	Enab, Disab
InvertData	Enab, Disab
EDL	Enab, Disab
Err Rate	10E-4, 10E-5, 10E-6, 10E-7, 10E-8, 10E-9
Near-end	Disab, Maint, Send, Both
Far-end	Disab, Maint
Mgmt Link	Disab, SNMP

Prt3 Options	Value
Port Type	E530, V.35, RS449
Base Rate	Nx64, Nx56
NetDCLB	Enab, Disab
Port LB	Disab, DTLB, DCLB, Both
All Ones	Disab, DTR, RTS, Both
Rcv Yellow	None, Halt
Tx Clock	Int, Ext
InvertTxC	Enab, Disab
InvertData	Enab, Disab
EDL	Enab, Disab
Err Rate	10E-4, 10E-5, 10E-6, 10E-7, 10E-8, 10E-9
Near-end	Disab, Maint, Send, Both
Far-end	Disab, Maint
Mgmt Link	Disab, SNMP

Prt2 Options	Value
Port Type	E530, V.35, RS449
Base Rate	Nx64, Nx56
NetDCLB	Enab, Disab
Port LB	Disab, DTLB, DCLB, Both
All Ones	Disab, DTR, RTS, Both
Rcv Yellow	None, Halt
Tx Clock	Int, Ext
InvertTxC	Enab, Disab
InvertData	Enab, Disab
EDL	Enab, Disab
Err Rate	10E-4, 10E-5, 10E-6, 10E-7, 10E-8, 10E-9
Near-end	Disab, Maint, Send, Both
Far-end	Disab, Maint
Mgmt Link	Disab, SNMP

Prt4 Options	Value
Port Type	E530, V.35, RS449
Base Rate	Nx64, Nx56
NetDCLB	Enab, Disab
Port LB	Disab, DTLB, DCLB, Both
All Ones	Disab, DTR, RTS, Both
Rcv Yellow	None, Halt
Tx Clock	Int, Ext
InvertTxC	Enab, Disab
InvertData	Enab, Disab
EDL	Enab, Disab
Err Rate	10E-4, 10E-5, 10E-6, 10E-7, 10E-8, 10E-9
Near-end	Disab, Maint, Send, Both
Far-end	Disab, Maint
Mgmt Link	Disab, SNMP

Network E1 Interface

Network Channel	Allocation
N1	
N2	
N3	
N4	
N5	
N6	
N7	
N8	
N9	
N10	
N11	
N12	
N13	
N14	
N15	
N16	
N17	
N18	
N19	
N20	
N21	
N22	
N23	
N24	
N25	
N26	
N27	
N28	
N29	
N30	
N31	

Allocations

D1 – D31 indicates allocation to DTE Drop/Insert channels.

Prt1 – Prt4 indicates allocation to synchronous data ports.

DTE Drop/Insert Interface

Drop/Insert Channel	Allocation
D1	
D2	
D3	
D4	
D5	
D6	
D7	
D8	
D9	
D10	
D11	
D12	
D13	
D14	
D15	
D16	
D17	
D18	
D19	
D20	
D21	
D22	
D23	
D24	
D25	
D26	
D27	
D28	
D29	
D30	
D31	

Allocations

N1 – N31 indicates allocation to Network E1 Channels.

Prt1 – Prt4 indicates allocation to synchronous data ports.

Port Chan Conf	Options		Value
Port 1	Assign To		NET, DTE, Prt2, Prt3, Prt4
	Assign By		Block, Chan
	If Assign By Block	Port Rate	Nx64: 64, 128, 192, 256, 320, 384, 448, 512, 576, 640, 704, 768, 832, 896, 960, 1024, 1088, 1152, 1216, 1280, 1344, 1408, 1472, 1536, 1600, 1664, 1728, 1792, 1856, 1920, 1984 Nx56: 56, 112, 168, 224, 280, 336, 392, 448, 504, 560, 616, 672, 728, 784, 840, 896, 952, 1008, 1064, 1120, 1176, 1232, 1288, 1344, 1400, 1456, 1512, 1568, 1624, 1680, 1736 NOTE: If time-slot 16 is reserved for signaling, the highest port rate (1984 or 1736) does not appear.
		Start At	Time Slot (Nn or Dn): 1, 2, 3, 4, 5, 6, 7, 8, 9, 10, 11, 12, 13, 14, 15, 16, 17, 18, 19, 20, 21, 22, 23, 24, 25, 26, 27, 28, 29, 30, 31 (Select One)
	If Assign By Chan		Time Slot (Nn or Dn): 1, 2, 3, 4, 5, 6, 7, 8, 9, 10, 11, 12, 13, 14, 15, 16, 17, 18, 19, 20, 21, 22, 23, 24, 25, 26, 27, 28, 29, 30, 31 (Select Multiple)
Port 2	Assign To		NET, DTE, Prt1, Prt3, Prt4
	Assign By		Block, Chan
	If Assign By Block	Port Rate	Nx64: 64, 128, 192, 256, 320, 384, 448, 512, 576, 640, 704, 768, 832, 896, 960, 1024, 1088, 1152, 1216, 1280, 1344, 1408, 1472, 1536, 1600, 1664, 1728, 1792, 1856, 1920, 1984 Nx56: 56, 112, 168, 224, 280, 336, 392, 448, 504, 560, 616, 672, 728, 784, 840, 896, 952, 1008, 1064, 1120, 1176, 1232, 1288, 1344, 1400, 1456, 1512, 1568, 1624, 1680, 1736 NOTE: If time-slot 16 is reserved for signaling, the highest port rate (1984 or 1736) does not appear.
		Start At	Time Slot (Nn or Dn): 1, 2, 3, 4, 5, 6, 7, 8, 9, 10, 11, 12, 13, 14, 15, 16, 17, 18, 19, 20, 21, 22, 23, 24, 25, 26, 27, 28, 29, 30, 31 (Select One)
	If Assign By Chan		Time Slot (Nn or Dn): 1, 2, 3, 4, 5, 6, 7, 8, 9, 10, 11, 12, 13, 14, 15, 16, 17, 18, 19, 20, 21, 22, 23, 24, 25, 26, 27, 28, 29, 30, 31 (Select Multiple)

Port Chan Conf	Options		Value
Port 3	Assign To		NET, DTE, Prt1, Prt2, Prt4
	Assign By		Block, Chan
	If Assign By Block	Port Rate	Nx64: 64, 128, 192, 256, 320, 384, 448, 512, 576, 640, 704, 768, 832, 896, 960, 1024, 1088, 1152, 1216, 1280, 1344, 1408, 1472, 1536, 1600, 1664, 1728, 1792, 1856, 1920, 1984 Nx56: 56, 112, 168, 224, 280, 336, 392, 448, 504, 560, 616, 672, 728, 784, 840, 896, 952, 1008, 1064, 1120, 1176, 1232, 1288, 1344, 1400, 1456, 1512, 1568, 1624, 1680, 1736 NOTE: If time-slot 16 is reserved for signaling, the highest port rate (1984 or 1736) does not appear.
		Start At	Time Slot (Nn or Dn): 1, 2, 3, 4, 5, 6, 7, 8, 9, 10, 11, 12, 13, 14, 15, 16, 17, 18, 19, 20, 21, 22, 23, 24, 25, 26, 27, 28, 29, 30, 31 (Select One)
	If Assign By Chan		Time Slot (Nn or Dn): 1, 2, 3, 4, 5, 6, 7, 8, 9, 10, 11, 12, 13, 14, 15, 16, 17, 18, 19, 20, 21, 22, 23, 24, 25, 26, 27, 28, 29, 30, 31 (Select Multiple)
Port 4	Assign To		NET, DTE, Prt1, Prt2, Prt3
	Assign By		Block, Chan
	If Assign By Block	Port Rate	Nx64: 64, 128, 192, 256, 320, 384, 448, 512, 576, 640, 704, 768, 832, 896, 960, 1024, 1088, 1152, 1216, 1280, 1344, 1408, 1472, 1536, 1600, 1664, 1728, 1792, 1856, 1920, 1984 Nx56: 56, 112, 168, 224, 280, 336, 392, 448, 504, 560, 616, 672, 728, 784, 840, 896, 952, 1008, 1064, 1120, 1176, 1232, 1288, 1344, 1400, 1456, 1512, 1568, 1624, 1680, 1736 NOTE: If time-slot 16 is reserved for signaling, the highest port rate (1984 or 1736) does not appear.
		Start At	Time Slot (Nn or Dn): 1, 2, 3, 4, 5, 6, 7, 8, 9, 10, 11, 12, 13, 14, 15, 16, 17, 18, 19, 20, 21, 22, 23, 24, 25, 26, 27, 28, 29, 30, 31 (Select One)
	If Assign By Chan		Time Slot (Nn or Dn): 1, 2, 3, 4, 5, 6, 7, 8, 9, 10, 11, 12, 13, 14, 15, 16, 17, 18, 19, 20, 21, 22, 23, 24, 25, 26, 27, 28, 29, 30, 31 (Select Multiple)

General SNMP Options	Value
System Name	Edit, Clear
System Location	Edit, Clear
System Contact	Edit, Clear
CommunityName1	Edit, Clear
Access 1	Read, R/W
CommunityName2	Edit, Clear
Access 2	Read, R/W
IP Adr	Edit, Clear
NetMask	Edit, Clear
Com IP Adr	Edit, Clear
Com NetMask	Edit, Clear
Com Link	PPP, SLIP
Aux IP Adr	Edit, Clear
Aux NetMask	Edit, Clear
Def Netwk	None, Com, Aux, FDL, EDL1, EDL2, EDL3, EDL4

SNMP Trap Options	Value
Num Trap Mgrs	1, 2, 3, 4, 5, 6
Trapn IP Adr	Edit, Clear
Trapn Dst	None, Com, Aux, FDL, EDL1, EDL2, EDL3, EDL4
Gen Trap	Disab, Warm, Auth, Both
Entp Trap	Enab, Disab
Link Trap	Disab, Up, Down, Both
Trap I/F	NET, DTE, E1s, Ports, All

Pin Assignments **D**

Overview	D-1
E1 Network Interface	D-2
DTE Drop/Insert Interface	D-3
AUX Port Interface	D-4
COM Port Interface	D-5
EIA 530A Port Interface Connector	D-7
EIA 530A-to-RS449 Cable Interface	D-8
EIA 530A-to-V.35 Cable Interface	D-10
EIA 530A-to-X.21 Cable Interface	D-12
Power Input Connector	D-14
Optional DC Power Cable	D-14
External Clock Interface	D-15

Overview

The E1 DSU/CSU is shipped with a power module. Various other interconnecting cables are available from the company. For cable feature numbers, refer to Appendix H, *Equipment List*. This appendix describes the connector pin assignments for the E1 DSU/CSU, Paradyne cables, and customer-supplied cables.

E1 Network Interface

The E1 network interface is either two BNC connectors (Transmit and Receive) for a 75 ohm unbalanced interface, or an RJ48C, 8-position, unkeyed modular connector (Table D-1) for a 120 ohm balanced interface.

The E1 120 ohm network interface adapter cable is shown in Figure D-1.

Table D-1
E1 120 Ohm Balanced
Interface Connector

Signal	Pin Number
Receive Ring	1
Receive Tip	2
Receive Shield	3
Transmit Ring	4
Transmit Tip	5
Transmit Shield	6

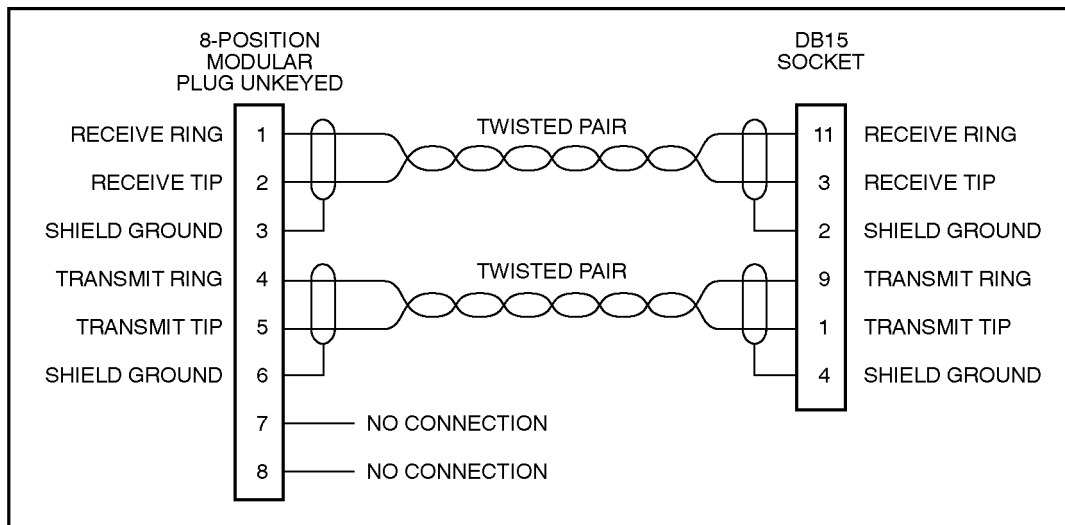

495-14698

Figure D-1. E1 120 Ohm Network Interface Adapter Cable

DTE Drop/Insert Interface

The DTE Drop/Insert interface connector is a DB15-type socket connector (Table D-2). For information about using Relay Contact Sense for external DTE loopback, refer to the Extrn DLB configuration option in the *DTE Interface Configuration Options* section of Appendix C.

The DTE Drop/Insert cable (Figure D-2) is typically supplied by a DTE vendor. It is made of shielded twisted-pair wires (22 AWG). The cable connector is a DB15 plug. Be sure to connect the shield ground only at the E1 DSU/CSU end to prevent ground loops.

Table D-2
DTE Drop/Insert Connector

Signal	Pin Number
Receiver Tip from DTE	1
Receiver Ring from DTE	9
Transmitter Tip to DTE	3
Transmitter Ring to DTE	11
Relay Contact Sense Return	12
Relay Contact Sense	14
Shield Ground	2, 4

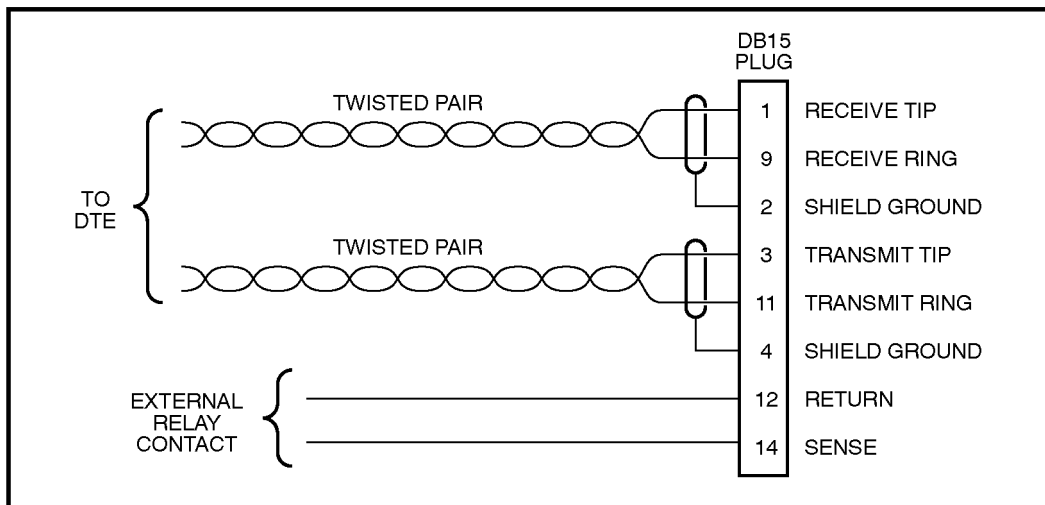

493-14152-01

Figure D-2. DTE Drop/Insert Cable

AUX Port Interface

The Auxiliary (AUX) port connects to the SNMP LAN Adapter for SNMP applications, or to another E1 DSU/CSU's COM port for daisy chain connectivity. (**The SNMP LAN Adapter includes the cable that is needed to attach it to the E1 DSU/CSU.**) The AUX port connector is an 8-pin modular connector (Table D-3).

NOTE

For daisy-chaining an AUX port to a COM port, a customer supplied, 8-pin-to-8-pin, straight-through cable is required and the appropriate configuration options (Com Use and Aux Use) must be set to Daisy. Whenever the cable is connected or disconnected, you should change the Daisy selection to ensure that the correct parameters have been negotiated for the link layer.

**Table D-3
AUX Port Connector**

Signal	Direction	Pin Number
DTE Transmit Clock	From DSU/CSU	1
DTE Receive Data	To DSU/CSU	2
Signal Ground	—	3
DTE Transmit Data	From DSU/CSU	4
DTE Receive Clock	From DSU/CSU	8

COM Port Interface

The COM port connects to a PC for front panel emulation, to an ASCII terminal or printer for alarms, to a network device (e.g., a router) for SNMP applications, to the SNMP LAN Adapter for SNMP applications, or to another E1 DSU/CSU's AUX port for daisy chain connectivity. **(The SNMP LAN Adapter includes the cable that is needed to attach it to the E1 DSU/CSU.)** The COM port connector is an 8-position keyed modular connector (Table D-4). The data signals on this port are referenced to a DTE interface.

The COM port-to-PC cable is shown in Figure D-3 and the COM port-to-terminal/printer cable is shown in Figure D-4.

NOTE

For daisy-chaining an AUX port to a COM port, a customer supplied, 8-pin-to-8-pin, straight-through cable is required and the appropriate configuration options (Com Use and Aux Use) must be set to Daisy. Whenever the cable is connected or disconnected, you should change the Daisy selection to ensure that the correct parameters have been negotiated for the link layer.

**Table D-4
COM Port Connector**

Signal	Direction	Pin Number
DCE Transmit Clock	From DSU/CSU	1
DCE Receive Data	From DSU/CSU	2
Signal Ground	—	3
DCE Transmit Data	To DSU/CSU	4
DCE Data Terminal Ready	To DSU/CSU	5
DCE Carrier Detect	From DSU/CSU	6
DCE Request-to-Send	To DSU/CSU	7
DCE Receive Clock	From DSU/CSU	8

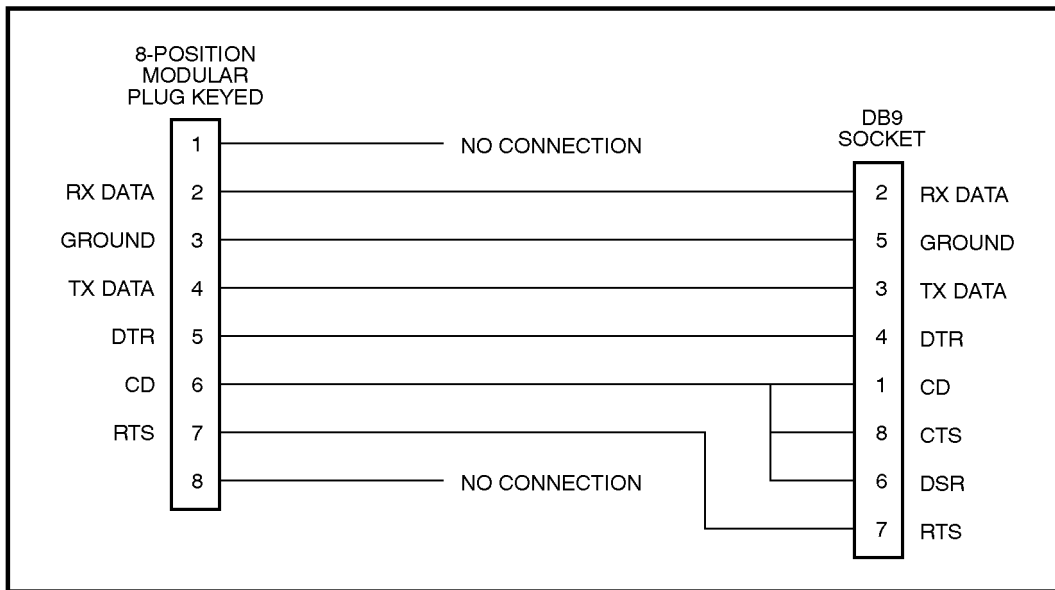

493-14153-01

Figure D-3. COM Port-to-PC Cable

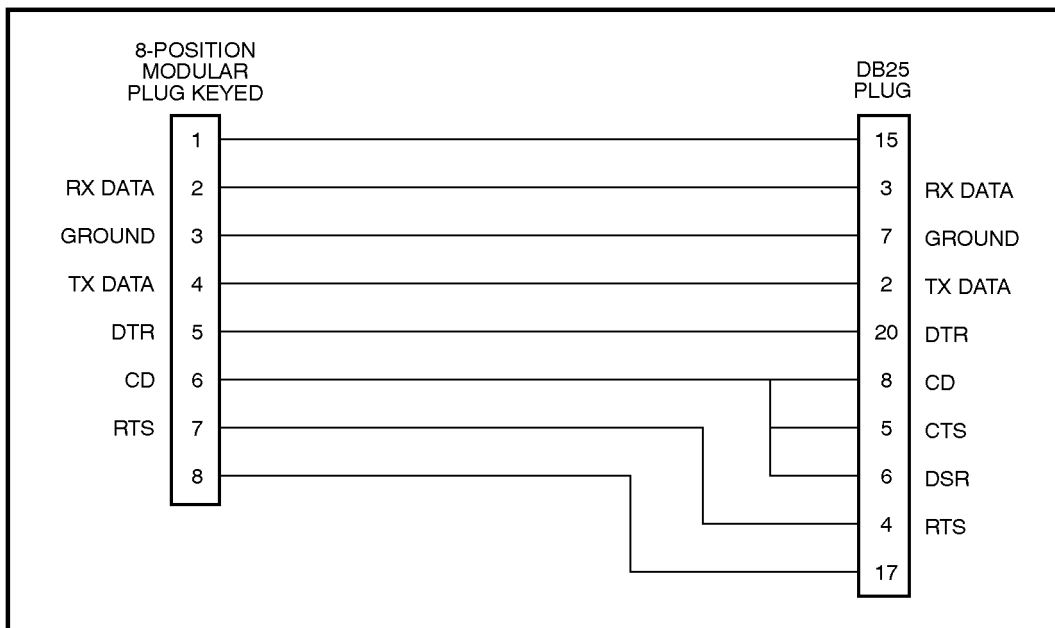

493-14154-01

Figure D-4. COM Port-to-Terminal/Printer Cable

EIA 530A Port Interface Connector

The EIA 530A Port Interface DB25 connector information is shown in Table D-5.

Table D-5
EIA 530A Port Interface DB25 Connector

Signal	Circuit Mnemonic	CCITT Number	Direction	Pin
Shield	—	—	—	1
Signal Common	AB	102A	—	7
Signal Common	AC	102B	—	23
Transmitted Data	BA	103	To DSU/CSU	2 (A) 14 (B)
Received Data	BB	104	From DSU/CSU	3 (A) 16 (B)
Request-to-Send	CA	105	To DSU/CSU	4 (A) 19 (B)
Clear-to-Send	CB	106	From DSU/CSU	5 (A) 13 (B)
Received Line Signal Detector	CF	109	From DSU/CSU	8 (A) 10 (B)
DCE Ready	CC	107	From DSU/CSU	6
DTE Ready	CD	108/1, /2	To DSU/CSU	20
Transmit Signal Element Timing (DTE Source)	DA	113	To DSU/CSU	11 (B) 24 (A)
Transmit Signal Element Timing (DCE Source)	DB	114	From DSU/CSU	12 (B) 15 (A)
Receiver Signal Element Timing (DCE Source)	DD	115	From DSU/CSU	17 (A) 9 (B)
Local Loopback	LL	141	To DSU/CSU	18
Remote Loopback	RL	140	To DSU/CSU	21
Test Mode	TM	142	From DSU/CSU	25

EIA 530A-to-RS449 Cable Interface

The EIA 530A-to-RS449 adapter cable (Figure D-5) provides the RS449 interface shown in Table D-6.

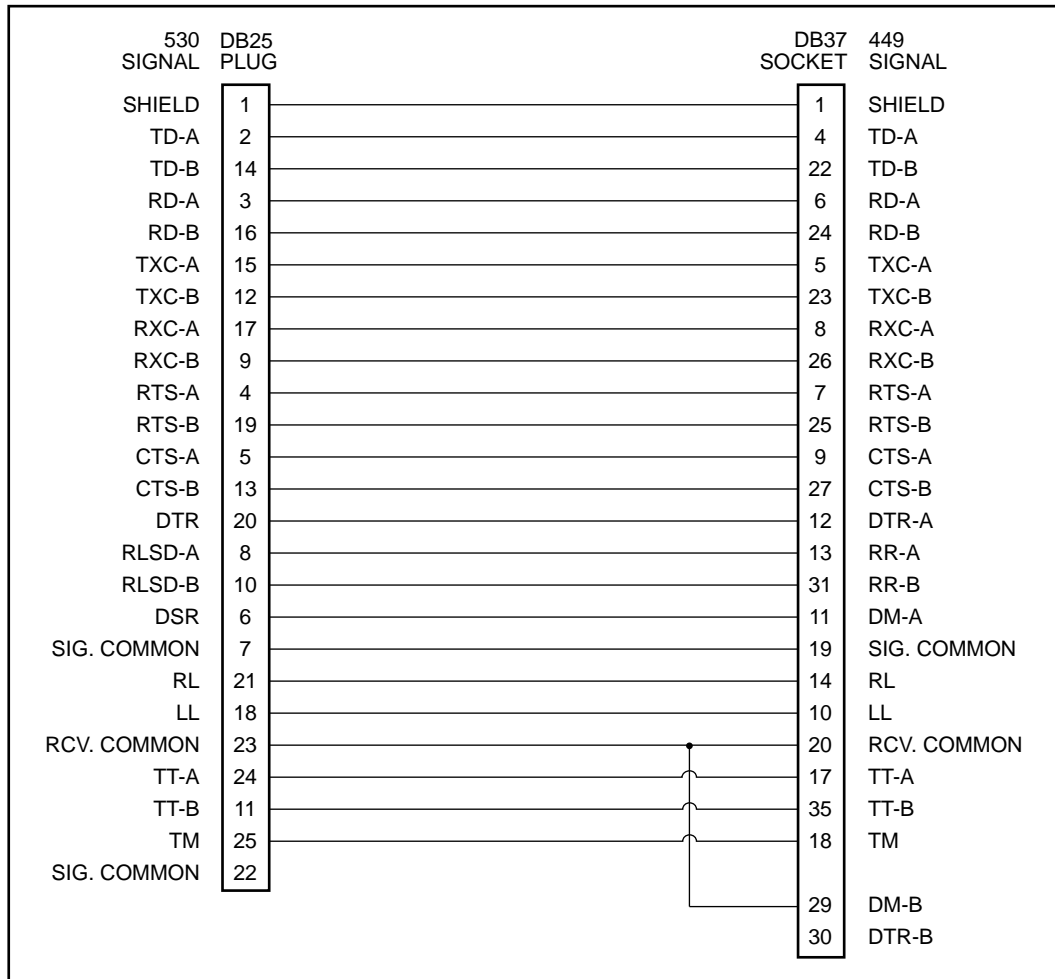

495-14323-01

Figure D-5. EIA 530A-to-RS449 Cable

**Table D-6
RS449 Cable Interface**

Signal	Circuit Mnemonic	CCITT Number	Direction	Pin
Shield	—	—	—	1
Signal Ground	SG	102A	—	19
Receive Ground	RC	102B	—	20
Send Common	SC	—	—	37
Send Data	SD	103	To DSU/CSU	4 (A) 22 (B)
Receive Data	RD	104	From DSU/CSU	6 (A) 24 (B)
Request-to-Send	RS	105	To DSU/CSU	7 (A) 25 (B)
Clear-to-Send	CS	106	From DSU/CSU	9 (A) 27 (B)
Receiver Ready	RR	109	From DSU/CSU	13 (A) 31 (B)
Data Mode	DM	107	From DSU/CSU	11 (A) 29 (B)
Terminal Ready	TR	108/1, /2	To DSU/CSU	12 (A) 30 (B)
Terminal Timing	TT	113	To DSU/CSU	17 (A) 35 (B)
Send Timing	ST	114	From DSU/CSU	5 (A) 23 (B)
Receive Timing	RT	115	From DSU/CSU	8 (A) 26 (B)
Local Loopback	LL	141	To DSU/CSU	10
Remote Loopback	RL	140	To DSU/CSU	14
Test Mode	TM	142	From DSU/CSU	18

EIA 530A-to-V.35 Cable Interface

The EIA 530A-to-V.35 adapter cable (Figure D-6) provides the V.35 interface shown in Table D-7.

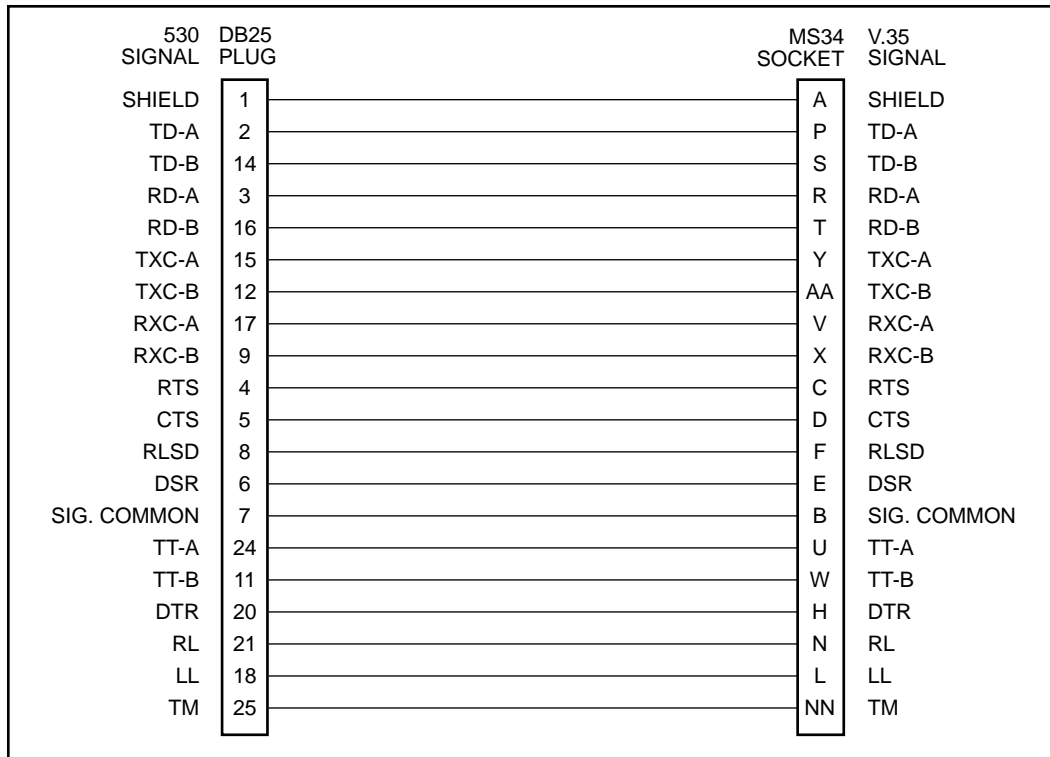

495-14324-01

Figure D-6. EIA 530A-to-V.35 Cable

**Table D-7
V.35 Cable Interface**

Signal	CCITT Number	Direction	Pin
Shield	—	—	A
Signal Common	102	—	B
Transmitted Data	103	To DSU/CSU	P (A) S (B)
Received Data	104	From DSU/CSU	R (A) T (B)
Request to Send	105	To DSU/CSU	C
Clear to Send	106	From DSU/CSU	D
Data Channel Received Line Signal Detector	109	From DSU/CSU	F
Data Set Ready	107	From DSU/CSU	E
Data Terminal Ready	108/1, /2	To DSU/CSU	H
Transmit Signal Element Timing (DTE Source)	113	To DSU/CSU	U (A) W (B)
Transmit Signal Element Timing (DCE Source)	114	From DSU/CSU	Y (A) AA (B)
Receiver Signal Element Timing (DCE Source)	115	From DSU/CSU	V (A) X (B)
Local Loopback	141	To DSU/CSU	L
Loopback/Maintenance	140	To DSU/CSU	N
Test Indicator	142	From DSU/CSU	NN

EIA 530A-to-X.21 Cable Interface

The EIA 530A-to-X.21 adapter cable (Figure D-7) provides the X.21 interface shown in Table D-8.

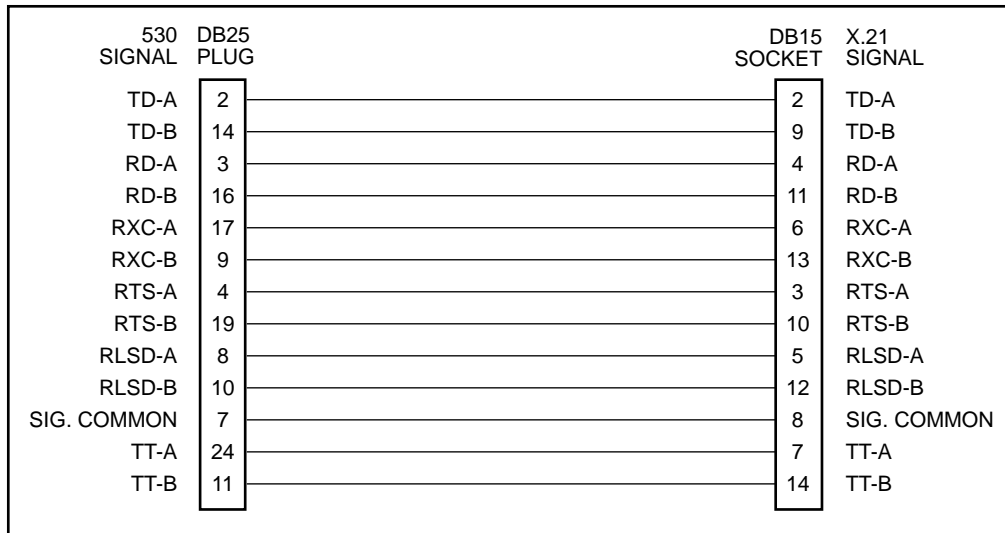

495-14787

Figure D-7. EIA 530A-to-X.21 Cable

Table D-8
X.21 Cable Interface

Signal	CCITT Number	Direction	Pin
Signal Common	102	—	8
Transmitted Data	103	To DSU/CSU	2 (A) 9 (B)
Received Data	104	From DSU/CSU	4 (A) 11 (B)
Request-to-Send	105	To DSU/CSU	3 (A) 10 (B)
Data Channel Received Line Signal Detector	109	From DSU/CSU	5 (A) 12 (B)
Transmit Signal Element Timing (DTE Source)	113	To DSU/CSU	7 (A) 14 (B)
Receiver Signal Element Timing (DCE Source)	115	From DSU/CSU	6 (A) 13 (B)

Power Input Connector

The input power connector leads are shown in Table D-9.

Table D-9
DC Power Connector

Signal	Pin Number
-48 Vdc Return	1, 2
-48 Vdc A	6
-48 Vdc B	5
+24 Vdc	5
+24 Vdc Return	4
Chassis Ground	3

Optional DC Power Cable

The power cable is a 14.5-foot, 18 AWG stranded cable. The connector is terminated at one end with a 6-position connector. The other end of the cable is terminated with a bare wire that should be connected to a dc power source. Figure D-8 shows the wire colors. The power source can be either a single source of +24 Vdc or up to two sources of -48 Vdc (A and B). You cannot connect +24 Vdc and -48 Vdc to the same unit. See the installation instructions in Chapter 2, *Installation*.

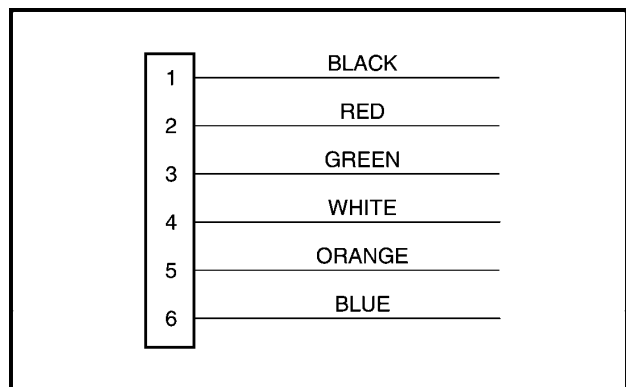

493-14158

Figure D-8. DC Power Cable

External Clock Interface

The External Clock connector pinouts are in Table D-10.

A cable diagram is shown in Figure D-9. This is a customer-supplied cable.

Table D-10
External Clock Connector

Signal	Pin Number
Shield	1
Clock (+) (RS422 only)	2
Clock (-) (RS422 only)	3
Clock In (RS423 only)	9
Signal Common	11

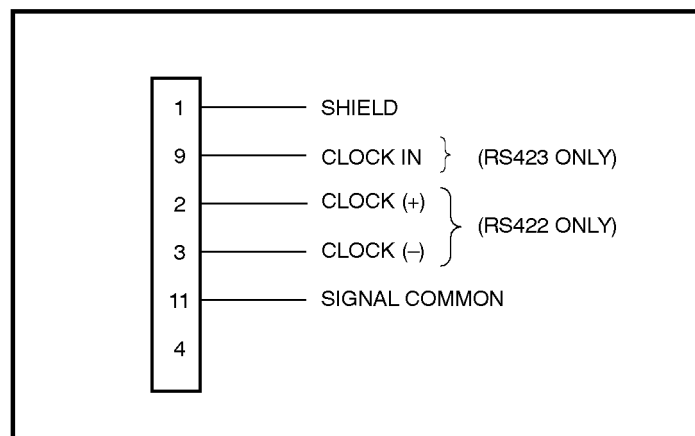

493-14344

Figure D-9. External Clock Connector

SNMP MIB Objects E

Overview	E-1
Management Information Base (MIB) II (RFC 1213)	E-1
System Group, MIB II	E-2
Interface Group, MIB II	E-2
IP Group, MIB II	E-5
ICMP Group, MIB II	E-7
UDP Group, MIB II	E-7
Transmission Group, MIB II	E-7
SNMP Group, MIB II	E-7
DS1/E1 MIB (RFC 1406)	E-8
Near End Group, DS1/E1 MIB	E-8
Far End Group, DS1/E1 MIB	E-10
The DS1 Fractional Group, DS1/E1 MIB	E-11
RS-232-like MIB (RFC 1317)	E-11
General Port Table, RS-232-like MIB	E-11
Asynchronous Port Table, RS-232-like MIB	E-12
Synchronous Port Table, RS-232-like MIB	E-13
Input Signal Table, RS-232-like MIB	E-13
Output Signal Table, RS-232-like MIB	E-13
Generic-Interface Extension MIB (RFC 1229)	E-14
Generic Interface Test Table, Generic Interface MIB	E-14
Paradyne Enterprise MIB	E-15
Correlation between Menu Commands and SNMP Objects	E-16

Overview

This appendix describes the Management Information Base (MIB) objects that are supported by the E1 DSU/CSU and provides a correlation between front panel commands and MIB objects (Table E-1).

Management Information Base (MIB) II (RFC 1213)

The objects defined by MIB II are organized into 10 different groups. The E1 DSU/CSU implements only those groups where the semantics of the group are

applicable to the implementation of the DSU/CSU. The MIB II object groups supported or not supported by the 31xx Series devices are as follows:

System Group	Supported.
Interface Group	Supported for the network interface, the DTE Drop/Insert interface, the synchronous data ports, the COM port, and the AUX port. Interface statistics (counters) apply to any port (COM or AUX), whichever is defined as the SNMP management link.
Address Translation Group	Not supported since this group is not supported in MIB II.

IP Group	Supported.
ICMP Group	Supported.
TCP Group	Not supported since the TCP protocol is not supported by the E1 DSU/CSU.
UDP Group	Supported.
EGP Group	Not supported since the EGP protocol is not supported by the E1 DSU/CSU.
Transmission Group	Supported on the E1 interfaces using the DS1/E1 MIB. Supported on the synchronous data ports using the RS-232-like MIB. Supported on the COM and AUX ports using the RS-232-like MIB.
SNMP Group	Supported.

System Group, MIB II

The System Group objects are fully supported by the E1 DSU/CSU. The following sections provide clarification for objects contained in the System Group where it is not otherwise clear how the object definition in MIB II is related to the E1 DSU/CSU. Objects not mentioned are supported as stated in the MIB.

System Group – “sysDescr” Object (system 1)

This object provides the full name and version identification for the system hardware and software. This object displays the following string:

E1 DSU/CSU; model *xxxx-xx-xxx*; S/W Release: *yy.yy.yy*; H/W CCA1: *zzzz-zzzz*; H/W CCA2: *zzzz-zzzz*; Serial number: *sssssss*.

Where: *xxxx-xx-xxx* represents the full model number of the unit.

yy.yy.yy represents the software revision number of the unit.

zzzz-zzzz represents the hardware revision numbers of the unit.

sssssss represents the serial number of the unit.

System Group – “sysObjectID” Object (system 2)

This object provides the authoritative identification of the network management subsystem contained in the unit. This object displays the following object identifier:

3172	1.3.6.1.4.1.74.1.14.2.2.5
3174	1.3.6.1.4.1.74.1.14.2.2.6

System Group – “sysServices” Object (system 7)

This object provides a value which indicates the set of services that are potentially offered by the E1 DSU/CSU. Only the following values are supported by the E1 DSU/CSU.

- physical(1) – Layer 1 functionality for all interfaces.
- datalink/subnetwork(2) – Layer 2 functionality (SLIP, PPP) for the COM and AUX ports.
- internet(4) – Layer 3 functionality (IP) for all management links.
- end-to-end(8) – Layer 4 functionality (UDP) for all management links.

Therefore, set this object to 15 (the sum of 1 + 2 + 4 + 8).

Interface Group, MIB II

The Interface Group consists of an object indicating the number of interfaces supported by the unit and an interface table containing an entry for each interface. The E1 DSU/CSU provides an entry in the interface table for the network interface, the DTE Drop/Insert interface, each of the synchronous data ports, the COM port, and the AUX port, if they apply. The following sections provide clarification for objects contained in the Interface Group where it is not clear how the object definition in MIB II is related to the E1 DSU/CSU.

Interface Group – “ifNumber” Object (interfaces 1)

This variable contains the maximum number of MIB II supported interfaces possible across the 31xx Series product line (9). This is different from the MIB description, which is defined as the number of interfaces on the particular device. This change allows the use of the same ifIndexes across all 31xx Series models.

Interface Group – “ifIndex” Object (ifEntry 1)

This object provides the index into the ifTable and typically into tables in other MIBs also. The values of the ifIndex object do not vary between models even though not all indexes are supported for a particular model. When an unsupported index is accessed, “noSuchName” is returned.

The following are the values of the ifIndexes for all E1 DSU/CSU models:

- 1 – Net E1
- 2 – DTE E1
- 3 – COM port
- 4 – (not used)
- 5 – Auxiliary RS-232 port
- 6 – DCE port 1
- 7 – DCE port 2
- 8 – DCE port 3
- 9 – DCE port 4

The supported ifIndexes for the 3172 DSU/CSU are:

- Net E1
- DTE E1
- COM port
- Auxiliary RS-232 port
- DCE port 1
- DCE port 2

The supported ifIndexes for the 3174 DSU/CSU are:

- Net E1
- DTE E1
- COM port
- Auxiliary RS-232 port
- DCE port 1
- DCE port 2
- DCE port 3
- DCE port 4

Interface Group – “ifDescr” Object (ifEntry 2)

This object provides the textual information about the interface. Each interface displays a text string as shown below:

Network E1:	“Network E1. E1 DSU/CSU, Hardware Version: [CCA number for the CSU board]”.
DTE E1:	“DTE E1. E1 DSU/CSU, Hardware Version: [CCA number for the CSU board]”.
COM:	“COM port. E1 DSU/CSU, Hardware Version: [CCA number for the CSU board]”.
AUX:	“AUX port. E1 DSU/CSU, Hardware Version: [CCA number for the CSU board]”.
Data Ports:	“Data Port n. E1 DSU/CSU, Hardware Version: [CCA number for the DSU board]” (where n is 1 to 4).

Interface Group – “ifType” Object (ifEntry 3)

This object identifies the type of the interface based on the physical/link protocol(s) immediately below the network layer. Only the following values are supported by the E1 DSU/CSU:

- e1(19) – Used for the network and DTE Drop/Insert interfaces.
- propPointToPointSerial(22) – Used for the synchronous data ports and for the COM port when the port is not configured as the SNMP management interface.
- ppp(23) – Used for the AUX or COM port when the port is configured for PPP.
- slip(28) – Used for the COM port when the port is configured for SLIP.

Interface Group – “ifMtu” Object (ifEntry 4)

This object identifies the largest datagram that can be sent or received on the interface. It is applicable only to the interface configured as the SNMP management link. This object is zero for all other interfaces.

Interface Group – “ifSpeed” Object (ifEntry 5)

This object provides the interface’s current bandwidth in bits per second. The value of this object for each interface is specified as follows:

- E1 Interfaces: 2,048,000 bps.
- COM and AUX: The currently configured data rate for the port.
- Data Ports: The currently configured data rate for the port when the port is allocated to one of the E1 interfaces or to another port as a backup. If the port is not allocated the data rate is defined as zero.

Interface Group – “ifAdminStatus” Object (ifEntry 7)

This object specifies the desired state (configuration) of the interface. This object is supported only for the COM port. It provides the ability to switch between using the port for SNMP or ASCII operations. The value of this object will not affect the state of any of the interfaces on the E1 DSU/CSU other than the COM port. Only the following values are supported by the E1 DSU/CSU:

- up(1) – The SNMP management link is active on the COM port.
- testing(3) – The SNMP management link is inactive on the COM port; the COM port can be used for proprietary ASCII functions.

Interface Group – “ifOperStatus” Object (ifEntry 8)

This object specifies the current operational state of the interface. The value of this object for each interface is defined as follows:

- Network E1:
 - The interface is up(1) when no alarm conditions exist.
 - The interface is down(2) when an alarm condition is active.
 - The interface is testing(3) when a test is active on the interface.
- DTE Drop/Insert:
 - The interface is up(1) when no alarm conditions exist and the interface is enabled.
 - The interface is down(2) when an alarm condition is active or the interface is disabled.
 - The interface is testing(3) when a test is active on the interface.
- COM Port:
 - When configured as an SNMP management link, up and down are based on the current state of the link layer protocol. Otherwise, the interface is always up(1).
 - The interface is never in the testing(3) state.
- AUX Port:
 - When configured as an SNMP management link, up and down are based on the current state of the link layer protocol. Otherwise, the interface is always down(2).
 - The interface is never in the testing(3) state.
- Data Ports:
 - The interface is up(1) when the port is assigned to the E1 interface or another data port as a backup, and both CTS and DSR are ON.
 - The interface is down(2) when the port is unassigned, or either CTS or DSR is OFF.
 - The interface is testing(3) when a test is active on the interface.

Interface Group – “ifLastChange” Object (ifEntry 9)

This object contains the value of “sysUpTime” at the time the interface entered its current operational state. For the E1 DSU/CSU, this object is only updated for the “up” and “down” states. This is done since the “testing” state is not mutually exclusive with the “up” and “down” states.

Interface Group – Input Counters (objects ifEntry 10 to ifEntry 15)

These objects collect statistics on the data received by the COM port and the AUX port when these ports are configured as SNMP management links. For interfaces that are not configured as an SNMP management link, these statistics are not provided and an error status is returned if access is attempted. The objects used to collect input statistics are listed below:

- ifInOctets (ifEntry 10)
- ifInUcastPkts (ifEntry 11)
- ifInNUcastPkts (ifEntry 12)
- ifInDiscards (ifEntry 13)
- ifInErrors (ifEntry 14)
- ifInUnknownProtos (ifEntry 15)

Interface Group – Output Counters (objects ifEntry 16 to ifEntry 21)

These objects collect statistics on the data received by the COM port and the AUX port when these ports are configured as SNMP management links. For interfaces that are not configured as an SNMP management link, these statistics are not provided and an error status is returned if access is attempted. The objects used to collect output statistics are listed below:

- ifOutOctets (ifEntry 16)
- ifOutUcastPkts (ifEntry 17)
- ifOutNUcastPkts (ifEntry 18)
- ifOutDiscards (ifEntry 19)
- ifOutErrors (ifEntry 20)
- ifOutQLen (ifEntry 21)

IP Group, MIB II

The IP Group objects are supported by the E1 DSU/CSU for all data paths which currently are configured to carry IP data to or from the E1 DSU/CSU, including the COM, AUX, EDL, and FDL. All of the objects in the IP Group other than the IP Address Translation table are fully supported. The IP Address Translation table (ipNetToMediaTable) does not apply to the E1 DSU/CSU and will be empty (i.e., have zero entries). The following sections provide clarification for objects contained in the IP Group when it is not clear how the object definition in MIB II is related to the E1 DSU/CSU.

IP Group – “ipForwarding” Object (ip 1)

This object specifies whether the unit is acting as an IP gateway in respect to the forwarding of a datagram received by, but not addressed to, this unit. Only the following value is supported by the E1 DSU/CSU.

- forwarding(1) – The unit is acting as a gateway.

IP Group – “ipAddrTable” Object (ip 20)

The address table is supported by the E1 DSU/CSU.

IP Group – “ipAdEntAddr” Object (ipAddrEntry 1)

The ipAdEntAddr object is an IP address supported by the device and serves as the index to the address table. Since indexes for tables must be unique, only one ifIndex may be displayed for each IP address supported by the device. If you have configured the same IP address for multiple interfaces or for default IP addresses, you will not see all interfaces that support a particular IP address upon display of the ipAddrTable.

IP Group – “ipAdEntIfIndex” Object (ipAddrEntry 2)

For some address table entries, the ipAdEntIfIndex object may have a value greater than ifNumber. In these cases, the ipAdEntIfIndex refers to a proprietary interface which is not currently implemented by the interface group of MIB II.

IP Group – “ipRouteTable” Object (ip 21)

The routing table used by the E1 DSU/CSU is supported as a read/write table. Entries in this table may be added, deleted, or changed. You should exercise great caution when adding or modifying routes in the ipRoutingTable. In general, it should not be necessary to add or modify routes in the E1 DSU/CSU. In those cases where it is deemed necessary, the routes should only be added to the connected device (i.e., the device closest to the destination). Internal routing mechanisms will propagate the route to the other devices.

An existing route may be effectively deleted by setting the ipRouteType object to “invalid” for the entry to be deleted. An existing route may be modified by changing fields in the desired entry (indexed by ipRouteDest) of the routing table. A new route may be added by specifying values for a table entry for which the index (“ipRouteDest”) does not already exist.

To add a route using an SNMP set, you must specify a group of minimal objects. These variable bindings must be contained in a single Protocol Data Unit (PDU). The objects are described in more detail in the following sections. The minimal set consists of:

- ipRouteDest
- ipRouteIfIndex

The following objects are defaulted if not specified in the set PDU used to add a route.

- ipRouteMetric1 – Defaulted to 1 hop.
- ipRouteMetric2 – Defaulted to -1 for standalone devices.
- ipRouteType – Defaulted to indirect.
- ipRouteMask – Defaulted as specified in the MIB description.

The following objects are unused in the E1 DSU/CSU and setting them will have no effect on the operation of the IP implementation.

- ipRouteMetric3, ipRouteMetric4, ipRouteMetric5 – Defaulted to -1 as specified in the MIB.
- ipRouteNextHop – Defaulted to 0.0.0.0.

The following read-only objects must not be specified in the set PDU used to add a route.

- ipRouteProto – Set to netmgmt(3) by software.
- ipRouteAge – Defaulted to 999.
- ipRouteInfo – Set to OBJECT IDENTIFIER {0, 0} since it is unused.

IP Group – “ipRouteDest” Object (ipRouteEntry 1)

The ipRouteDest object serves as the index to the routing table. Since indexes for tables must be unique, only one route per destination may appear in the table. To ensure that no duplicate destinations appear in the routing table, the ipRouteDest object of the ipRouteTable is treated as described in RFC 1354 (IP Forwarding Table MIB):

“The destination IP address of this route. An entry with a value of 0.0.0.0 is considered a default route. This object may not take a Multicast (Class D) address value. Any assignment (implicit or otherwise) of an instance of this object to a value x must be rejected if the bitwise logical-AND of x with the value of the corresponding instance of the ipForwardMask object is not equal to x .”

IP Group – “ipRouteIfIndex” Object (ipRouteEntry 1)

When the routing table is displayed, the ipRouteIfIndex object for some entries may have a value greater than ifNumber. In these cases, the ipRouteIfIndex refers to a proprietary interface which is not currently implemented by the interface group of MIB II. Route entries with an unrecognized ipRouteIfIndex value should not be deleted.

When setting this object via SNMP, the ipRouteIfIndex value can only assume an appropriate value of ifIndex defined for the particular device type.

IP Group – “ipRouteMetric2” Object (ipRouteEntry 4)

For standalone devices, ipRouteMetric2 is not used and contains -1.

When adding a route to the routing table using SNMP, do not specify a value for ipRouteMetric2.

IP Group – “ipRouteProto” Object (ipRouteEntry 9)

This object is a read-only object and may have the following values in the E1 DSU/CSU.

- other(1) – Temporary route added by IP.
- local(2) – Route added or modified as a result of user configuration via the front panel.
- netmgmt(3) – Route added or modified by means of an SNMP set.
- icmp(4) – Route added or modified by Internet Control Management Protocol (ICMP).
- rip(8) – Route added or modified by the Routing Information Protocol (RIP) or similar proprietary protocol.

IP Group – “ipRouteAge” Object (ipRouteEntry 10)

This object is implemented as a read-only object in the E1 DSU/CSU. In the E1 DSU/CSU, it reflects the value of the route’s time-to-live (in seconds). When displayed, a value of 999 represents a route that is retained permanently. For temporary routes, the ipRouteAge object decrements over time. All routes added via an SNMP set of the ipRouteTable are considered permanent routes. These routes do not age, but will remain unless deleted via SNMP.

ICMP Group, MIB II

The ICMP Group objects are fully supported by the E1 DSU/CSU.

UDP Group, MIB II

The User Datagram Protocol (UDP) Group objects are fully supported by the E1 DSU/CSU.

Transmission Group, MIB II

Objects in the transmission group are supported on the network and DTE Drop/Insert interfaces, the COM port, the AUX port, and the synchronous data ports. The objects in the transmission group are not defined within MIB II, but rather through other Internet standard MIB definitions. The following two transmission group objects are supported by the E1 DSU/CSU.

- ds1 (transmission 18) – The transmission object supported on the E1 interfaces.
- rs232 (transmission 33) – The transmission object supported on the synchronous data ports, COM port, and AUX port.

The “ds1” transmission object is defined by the DS1/E1 MIB. The rs232 transmission object is defined by the RS-232-like MIB.

SNMP Group, MIB II

The SNMP Group objects that apply to a management agent are fully supported by the E1 DSU/CSU. The following objects apply only to an NMS and return a zero value if accessed.

- snmpInTooBigs (snmp 8)
- snmpInNoSuchNames (snmp 9)
- snmpInBadValues (snmp 10)
- snmpInReadOnlys (snmp 11)
- snmpInGenErrs (snmp 12)
- snmpInGetResponses (snmp 18)
- snmpInTraps (snmp19)
- snmpOutGetRequests (snmp 25)
- snmpOutGetNexts (snmp 26)
- snmpOutSetRequests (snmp 27)
- snmpOutGetResponses (snmp 28)

DS1/E1 MIB (RFC 1406)

The “ds1” object defined by RFC 1406 is supported for both the network and DTE Drop/Insert interfaces. The DS1 Near End Group and DS1 Fractional Group are supported for both interfaces. The DS1 Far End Group is not supported.

Near End Group, DS1/E1 MIB

The DS1 Near End Group consists of the following four tables:

- DS1 Configuration
- DS1 Current
- DS1 Interval
- DS1 Total

All four tables are fully supported for the network interface. Since statistics are not kept for the DTE Drop/Insert interface, only the DS1 Configuration table is fully supported. The “statistic” objects for the DTE Drop/Insert interface entry in the DS1 Current, DS1 Interval, and DS1 Total tables are always zero (null). The following sections provide clarification for objects contained in the Near End Group when it is not clear how the object definition in the DS1/E1 MIB is related to the E1 DSU/CSU.

Near End Group – “dsx1TimeElapsed” Object (dsx1ConfigEntry 3)

Applies to the network interface only. An error status is returned if access is attempted for the DTE Drop/Insert interface.

Near End Group – “dsx1ValidIntervals” Object (dsx1ConfigEntry 4)

Applies to the network interface only. An error status is returned if access is attempted for the DTE Drop/Insert interface.

Near End Group – “dsx1LineType” Object (dsx1ConfigEntry 5)

This object corresponds to the NET Framing/DTE Framing configuration options for the E1 interfaces on the E1 DSU/CSU. Only the following values are supported by the E1 DSU/CSU.

- dsx1E1(4) – Indicates non-CRC-4 framing.
- dsx1E1-CRC(5) – Indicates CRC-4 framing.

Near End Group – “dsx1LineCoding” Object (dsx1ConfigEntry 6)

This object corresponds to the DTE Coding configuration option on the E1 DSU/CSU. Only the following values are supported by the E1 DSU/CSU.

- dsx1HDB3(3) – Indicates HDB3 line coding.
- dsx1AMI(5) – Indicates AMI line coding (for DTE only, not available for NET).

Near End Group – “dsx1SendCode” Object (dsx1ConfigEntry 7)

This object specifies the test patterns/codes being sent over the network interface. These tests are not supported on the DTE Drop/Insert interface. Only the following values are supported by the E1 DSU/CSU.

- dsx1SendNoCode(1) – Specifies that the interface is sending normal or looped data. Setting the interface to this value stops an active “send pattern” test on the interface. This is the only value supported by the DTE Drop/Insert interface.
- dsx1SendOtherTestPattern(8) – Specifies that the network interface is sending a 1-in-8 test pattern. This value is read-only. An attempt to write this value returns a badValue response.

**Near End Group – “dsx1CircuitIdentifier” Object
(dsx1ConfigEntry 8)**

This object is only supported on the network interface.

**Near End Group – “dsx1LoopbackConfig”
Object (dsx1ConfigEntry 9)**

This object specifies the loopback state of the E1 interfaces. Only the following values are supported by the E1 DSU/CSU.

- dsx1NoLoop(1) – The E1 interface is not in a loopback state.
- dsx1PayloadLoop(2) – Specifies that a Payload Loopback (PLB) is active for the network interface or a Repeater Loopback (RLB) is active for the DTE Drop/Insert interface.
- dsx1LineLoop(3) – Specifies that a Line Loopback (LLB) is active for the network interface or a DTE Loopback (DLB) is active for the DTE Drop/Insert interface.

**Near End Group – “dsx1LineStatus” Object
(dsx1ConfigEntry 10)**

This object specifies the line (alarm) status of the E1 interfaces. Only the following values are supported by the E1 DSU/CSU. More than one value may be active at a time.

- dsx1NoAlarm(1) – No alarm present.
- dsx1RcvFarEndLOF(2) – A Remote Alarm Indication (RAI) signal is being received.
- dsx1RcvAIS(8) – An Alarm Indication Signal (AIS) is being received.
- dsx1LossOfFrame(32) – An Out Of Frame (OOF) condition has persisted for more than 2.5 seconds.
- dsx1LossOfSignal(64) – A Loss of Signal (LOS) condition has persisted for more than 2.5 seconds.
- dsx1LoopbackState(128) – The near end of the E1 interface is in a loopback state.
- dsx1Other Failure(4096) – An Excessive Error Rate (EER) has been detected on the network interface.

**Near End Group – “dsx1SignalMode” Object
(dsx1ConfigEntry 11)**

This object specifies whether time-slot 16 (TS16) is reserved for signaling. Only the following values are supported by the E1 DSU/CSU.

- none(1) – No signaling is being used on this interface.
- messageOriented(4) – Indicates that TS16 is reserved for signaling.

Changing from none(1) to messageOriented(4) deallocates all DS0 channels on the DTE and network interfaces.

**Near End Group – “dsx1TransmitClockSource”
Object (dsx1ConfigEntry 12)**

This object specifies the timing source for the currently active transmit clock for this E1 interface. This may be either the primary clock source, secondary clock source (if the primary has failed), or the internal clock (if both primary and secondary have failed). This object differs from the MIB definition in that it is “read-only” (not read/write) for E1 DSU/CSUs. Only the following values are supported by the E1 DSU/CSU.

- loopTiming(1) – The recovered receive clock is being used as the transmit clock.
- localTiming(2) – The E1 DSU/CSU’s internal clock is being used as the transmit clock.
- ThroughTiming(3) – The recovered receive clock from another interface (e.g., E1, Port, or External) is being used as the transmit clock.

Near End Group – “dsx1Fdl” Object (dsx1ConfigEntry 13)

This object specifies how Facility Data Link is being used. Only the following values are supported by the E1 DSU/CSU. More than one value may be active at a time.

- dsx1other(1) – SNMP data is being sent over the FDL.
- dsx1Fdl-none(8) – Indicates that the device does not use FDL. This value is always returned for the DTE Drop/Insert interface. It is also returned for the network interface when the FDL management link is disabled.

Near End Group – The DS1 Current Table Objects (dsx1CurrentEntry)

The following DS1 current table objects are provided for the network interface only. Objects in the table that are not listed are not supported and will return an error status if access is attempted.

- dsx1CurrentIndex – The index that identifies the E1 interface.
- dsx1CurrentESs – Errored Seconds for the current interval.
- dsx1Current SESs – Severely Errored Seconds for the current interval.
- dsx1CurrentUASs – Unavailable Seconds for the current interval.
- dsx1CurrentBESs – Bursty Errored Seconds for the current interval.

Near End Group – The DS1 Interval Table Objects (dsx1IntervalEntry)

The following DS1 interval table objects are provided for the network interface only. Objects in the table that are not listed are not supported and will return an error status if access is attempted.

- dsx1IntervalIndex – The index that identifies the E1 interface.
- dsx1IntervalNumber – The interval number (1 to 96).
- dsx1IntervalESs – Errored Seconds for the interval.
- dsx1Interval SESs – Severely Errored Seconds for the interval.

- dsx1IntervalUASs – Unavailable Seconds for the interval.
- dsx1Interval BESs – Bursty Errored Seconds for the interval.

Near End Group – The DS1 Total Table Objects (dsx1TotalEntry)

The following DS1 total table objects are provided for the network interface only. Objects in the table that are not listed are not supported and will return an error status if access is attempted.

- dsx1TotalIndex – The index that identifies the E1 interface.
- dsx1TotalESs – The 24-hour total Errored Seconds.
- dsx1Total SESs – The 24-hour total Severely Errored Seconds.
- dsx1TotalUASs – The 24-hour total Unavailable Seconds.
- dsx1TotalBESs – The 24-hour total Bursty Errored Seconds.

Far End Group, DS1/E1 MIB

The DS1 Far End Group consists of the following three tables:

- DS1 Far End Current
- DS1 Far End Interval
- DS1 Far End Total

These tables are not supported for either the network or DTE Drop/Insert interface.

The DS1 Fractional Group, DS1/E1 MIB

The DS1 Fractional group consists of the DS1 fractional table. This table (dsx1FracTable) is fully supported by the E1 DSU/CSU and allows channel (time slots) to be mapped between the E1 interfaces and data ports. If an invalid channel map (e.g., two interfaces mapped to a single time slot, one interface mapped to two E1s, etc.) is received, an error is returned to the SNMP manager. The E1 DSU/CSU validates all channel configurations before applying them.

Operational Note: The fractional E1 group only allows specification of an entire interface to a particular time slot on another interface (i.e., a time slot on one interface cannot be mapped to a time slot on another interface). This prevents complete mapping of time slots on the DTE Drop/Insert interface to time slots on the network E1 interface. For mapping time slots between the network and DTE E1 interfaces, the following convention is used: Time slots on the E1 interface that are mapped to another E1 interface (i.e., not a data port) are connected in ascending order. For example, if the fractional table for the network E1 interface maps time-slots 1, 3 and 5 to the DTE E1 interface and the DTE E1 interface maps time slots 10, 11 and 15 to the network the following time slots are connected: N1 to D10, N3 to D11, and N5 to D15.

When time-slot 16 is reserved for signaling, allocated DTE channels must be mapped to the corresponding network channels (e.g., D1 to N1, etc.), otherwise an error is returned to the SNMP manager.

RS-232-like MIB (RFC 1317)

The “rs232” object defined by RFC 1317 is supported for all of the synchronous data ports, the COM port, and the AUX port. The RS-232-like MIB consists of one object and five tables, as follows:

- Number of RS-232-like ports
- The General Port Table
- The Asynchronous Port Table
- The Synchronous Port Table
- The Input Signal Table
- The Output Signal Table

The Asynchronous Port table is not supported by the E1 DSU/CSU for the synchronous data ports. The Input Signal and Output Signal tables are not supported for the AUX and COM ports. The following sections provide clarification for objects contained in the RS-232-like MIB when it is not clear how the object definition in MIB is related to the E1 DSU/CSU.

Number of Ports – “rs232Number” Object (rs232 1)

This object contains the number of ports in the RS-232-like general port table. This number is 4 for the 3172 DSU/CSU and 6 for the 3174 DSU/CSU.

General Port Table, RS-232-like MIB

The general port table contains general configuration objects for the RS-232-like interfaces.

General Port Table – “rs232PortIndex” Object (rs232PortEntry 1)

This object contains a unique value for each port and is used as an index into the general port table (rs232PortTable). The values of the rs232PortIndex object vary between models and are listed below.

The values of rs232PortIndex for the 3172 DSU/CSU are:

- 1 – COM port
- 2 – Auxiliary RS-232 port
- 3 – DCE port 1
- 4 – DCE port 2

The values of rs232PortIndex for the 3174 DSU/CSU are:

- 1 – COM port
- 2 – Auxiliary RS-232 port
- 3 – DCE port 1
- 4 – DCE port 2
- 5 – DCE port 3
- 6 – DCE port 4

General Port Table – “rs232PortType” Object (rs232PortEntry 2)

This object is used to identify the port’s hardware type. Only the following values are supported by the E1 DSU/CSU.

- rs232(2) – Used to identify the AUX and COM ports.
- rs422(3) – Used to identify synchronous data ports that are configured as EIA-530A or RS-449.
- v35(5) – Used to identify synchronous data ports that are configured as V.35.

General Port Table – “rs232PortInSigNumber” Object (rs232PortEntry 3)

This object contains the number of input signals contained in the input signal table. This is the number of signals that can be detected. This number is 2 for the synchronous data ports and 0 for the AUX and COM ports.

General Port Table – “rs232PortOutSigNumber” Object (rs232PortEntry 4)

This object contains the number of output signals contained in the output signal table. This is the number of signals that can be asserted. This number is 2 for the synchronous data ports and 0 for the AUX and COM ports.

General Port Table – “rs232PortInSpeed” Object (rs232PortEntry 5)

This object contains the port’s input speed in bits per second. For the E1 DSU/CSU, the rs232PortInSpeed object has the same value as the rs232PortOutSpeed object. The input speed of a synchronous data port is determined by the channel configuration and cannot be changed through this object. Thus, for the synchronous data ports, this object is read-only. The input speed of the AUX or COM port is the currently configured speed. Setting of this value for the AUX or COM port causes the configured port speed to be changed.

General Port Table – “rs232PortOutSpeed” Object (rs232PortEntry 6)

This object contains the port’s output speed in bits per second. For the E1 DSU/CSU, the rs232PortInSpeed object has the same value as the rs232PortOutSpeed object. The input speed of a synchronous data port is determined by the channel configuration and cannot be changed through this object. Thus, for the synchronous data ports, this object is read-only. The input speed of the AUX or COM port is the currently configured speed. Setting of this value for the AUX or COM port causes the configured port speed to be changed.

Asynchronous Port Table, RS-232-like MIB

The asynchronous port table contains an entry for the AUX or COM port when the port is configured for asynchronous operation. For the E1 DSU/CSU, the entries in the table that are counters (rs232AsyncPortEntry 6–8) are used to collect statistics and are not supported.

Asynchronous Port Table, “rs232AsyncPortBits” (rs232AsyncPortEntry 2)

This object specifies the number of bits in a character. Only the following values are supported by the E1 DSU/CSU.

- 7 – 7-bit characters. Supported on the COM port only.
- 8 – 8-bit characters.

Asynchronous Port Table, “rs232AsyncPortStopBits” (rs232AsyncPortEntry 3)

This object specifies the number of stop bits supported. Only the following values are supported by the E1 DSU/CSU.

- one(1) – One stop bit.
- two(2) – Two stop bits. Supported on the COM port only.
- one-and-half(3) – One and a half stop bits. Supported on the COM port only.

*Asynchronous Port Table,
"rs232AsyncPortParity"
(rs232AsyncPortEntry 4)*

This object specifies the parity used by the port. Only the following values are supported by the E1 DSU/CSU.

- none(1) – No parity bit.
- odd(2) – Odd parity. Supported on the COM port only.
- even(3) – Even parity. Supported on the COM port only.

*Asynchronous Port Table,
"rs232AsyncPortAutoBaud"
(rs232AsyncPortEntry 5)*

This object specifies the ability to automatically sense the input speed of the port. Only the following value is supported by the E1 DSU/CSU.

- disabled(2) – Autobaud is not supported.

Synchronous Port Table, RS-232-like MIB

The synchronous port table contains an entry for each of the synchronous data ports and the COM port when the port is configured for synchronous operation. For the E1 DSU/CSU, the entries in the table that are counters (rs232SyncPortEntry 3–7) are used to collect statistics and are not supported.

*Synchronous Port Table –
"rs232SyncPortClockSource"
(rs232SyncPortEntry 2)*

This object specifies the clock source for the port. Only the following values are supported by the E1 DSU/CSU.

- internal(1) – The port uses an internal clock.
- external(2) – The port uses an external clock.

Input Signal Table, RS-232-like MIB

This table contains entries for the input signals that can be detected by the unit for each of the synchronous data ports.

*Input Signal Table – "rs232InSigName"
(rs232InSigEntry 2)*

This object contains the identification of a hardware input signal. Only the following values are supported by the E1 DSU/CSU.

- rts(1) – Request-To-Send.
- dtr(4) – Data Terminal Ready.

*Input Signal Table – "rs232InSigState"
(rs232InSigEntry 3)*

This object contains the current signal state. Only the following values are supported by the E1 DSU/CSU.

- on(2) – The signal is asserted.
- off(3) – The signal is not asserted.

*Input Signal Table – "rs232InSigChanges"
(rs232InSigEntry 4)*

This object is not supported by the E1 DSU/CSU.

Output Signal Table, RS-232-like MIB

This object contains entries for the output signals that can be asserted by the unit for each of the synchronous data ports.

*Output Signal Table – "rs232OutSigName"
(rs232OutSigEntry 2)*

This object contains the identification of a hardware output signal. Only the following values are supported by the E1 DSU/CSU.

- cts(1) – Clear-To-Send.
- dsr(4) – Data Set Ready.

*Output Signal Table – "rs232OutSigState"
(rs232OutSigEntry 3)*

This object contains the current signal state. Only the following values are supported by the E1 DSU/CSU.

- on(2) – The signal is asserted.
- off(3) – The signal is not asserted.

Output Signal Table – “rs232OutSigChanges” (rs232OutSigEntry 4)

This object is not supported by the E1 DSU/CSU.

Generic-Interface Extension MIB (RFC 1229)

The generic-interface MIB is an experimental MIB that provides extensions to the generic interface group defined in MIB II. This MIB describes three tables:

- Generic Interface Extension Table
- Generic Interface Test Table
- Generic Receive Address Table

Only the generic interface test table is supported by the E1 DSU/CSU. This table is supported for the network interface only.

Generic Interface Test Table, Generic Interface MIB

The test table provides access to additional tests (loopbacks and pattern tests) that are not in the interface group of MIB II.

Generic Interface Test Table – “ifExtnsTestType” Object (ifExtnsTestEntry 4)

This object is a control variable used to start and stop operator-initiated tests on the interface. It provides the capability to:

- Start/stop the Send 1-in-8 test pattern on the network interface.
- Start/stop the Send QRSS/511 test pattern on a synchronous data port.
- Start sending a V.54 UP/DOWN code to the remote unit for a synchronous data port.
- Start/stop the Monitor QRSS/511 test pattern on a synchronous data port.
- Start/stop the DCLB/DTLB loopback test on a synchronous data port.

The following object identifiers control tests on the interface.

- noTest – Stops the test in progress on the interface.
- testFullDuplexLoopBack – Initiates a DCLB on the interface. Only supported for the data ports.
- testLoopDTLB – Initiates a DTLB on the interface. Only supported for the data ports.
- testMonQRSS – Initiates a Monitor QRSS test on the interface. Only supported for the data ports.
- testMon511 – Initiates a Monitor 511 test on the interface. Only supported for the data ports.
- testSendQRSS – Initiates a Send QRSS test on the interface. Only supported for the data ports.
- testSend511 – Initiates a Send 511 test on the interface. Only supported for the data ports.
- testSendV54Up – Sends a V54 Up code to the remote unit. Only supported for the data ports.
- testSendV54Down – Sends a V54 Down code to the remote unit. Only supported for the data ports.
- testSend1in8 – Initiates a Send 1-in-8 test on the network interface.

Where these object identifiers are defined as follows:

- noTest – OBJECT IDENTIFIER ::= [wellKnownTests 0]
- testFullDuplexLoopBack – OBJECT IDENTIFIER ::= [wellKnownTests 1]
- testLoopDTLB – OBJECT IDENTIFIER ::= [wellKnownTests 2]
- testMonQRSS – OBJECT IDENTIFIER ::= [wellKnownTests 3]
- testMon511 – OBJECT IDENTIFIER ::= [wellKnownTests 4]
- testSendQRSS – OBJECT IDENTIFIER ::= [wellKnownTests 5]
- testSend511 – OBJECT IDENTIFIER ::= [wellKnownTests 6]

- testSendV54Up – OBJECT IDENTIFIER ::= [wellKnownTests 7]
- testSendV54Down – OBJECT IDENTIFIER ::= [wellKnownTests 8]
- testSend1in8 – OBJECT IDENTIFIER ::= [wellKnownTests 12]

- inSyncNoBitErrors – OBJECT IDENTIFIER ::= [wellKnownCodes 2]
- inSyncWithBitErrors – OBJECT IDENTIFIER ::= [wellKnownCodes 3]
- notInSync – OBJECT IDENTIFIER ::= [wellKnownCodes 4]

*Generic Interface Test Table –
“ifExtnsTestResult” Object (ifExtnsTestEntry 5)*

This object contains the result of the most recently requested test. Only the following values are supported by the E1 DSU/CSU.

- none(1) – No test currently active.
- inProgress(3) – A test is currently in progress.
- notSupported(4) – The requested test is not supported.
- unAbleToRun(5) – The requested test cannot run due to the state of the unit.

*Generic Interface Test Table –
“ifExtnsTestCode” Object
(ifExtnsTestEntry 6)*

This object contains a code that contains more specific information on the test result. This object is defined as an object identifier. Only the following values are supported by the E1 DSU/CSU.

- none – No further information is available. Used for the send pattern/code and loopback tests.
- inSyncNoBitErrors – A monitor pattern (QRSS or 511) test has synchronized on the pattern and has not detected any bit errors.
- inSyncWithBitErrors – A monitor pattern (QRSS or 511) test has synchronized on the pattern and has detected bit errors.
- notInSync – A monitor pattern (QRSS or 511) test has not synchronized on the requested pattern.

Where these object identifiers are defined as follows:

- wellKnownCodes – OBJECT IDENTIFIER ::= [ifExtensions 5]
- none – OBJECT IDENTIFIER ::= [wellKnownCodes 1]

Paradyne Enterprise MIB

The variable devConfigAreaCopy under the devConfigAreaCopy group in the common area of the Paradyne Enterprise MIB will be supported. This variable allows the entire contents of one configuration area to be copied into another configuration area. Only the following values are supported by the E1 DSU/CSU.

- noOp(1) – An attempt to read this value returns a “noOp” response.
- active-to-customer1(2) – Copy from the active area to the customer 1 area.
- active-to-customer2(3) – Copy from the active area to the customer 2 area.
- customer1-to-active(4) – Copy from the customer 1 area to the active area.
- customer1-to-customer2(5) – Copy from the customer 1 area to the customer 2 area.
- customer2-to-active(6) – Copy from the customer 2 area to the active area.
- customer2-to-customer1(7) – Copy from the customer 2 area to the customer 1 area.
- factory1-to-active(8) – Copy from the factory area to the active area. (There is only one factory area for the E1 DSU/CSU.)
- factory1-to-customer1(9) – Copy from the factory area to the customer 1 area.
- factory1-to-customer2(10) – Copy from the factory area to the customer 2 area.

Correlation between Menu Commands and SNMP Objects

Table E-1 provides a correlation between how a function is performed or status is displayed on the front

panel and how the same function is accomplished using access to the SNMP database. SNMP **objects** are displayed in bold type while values for SNMP objects are displayed in *italics*.

Table E-1
(1 of 3)
SNMP MIB to Front Panel Command Cross-Reference

Front Panel Command	SNMP MIB Object
Stat→DevHS: LOS at NET OOF at NET RAI at NET AIS at NET EER at NET	Read the dsx1LineStatus object for NET E1 <i>dsx1LossOfSignal</i> <i>dsx1LossOfFrame</i> <i>dsx1RcvFarEnd</i> <i>dsx1RcvAIS</i> <i>dsx1OtherFailure</i>
Stat→DevHS: LOS at DTE OOF at DTE RAI at DTE AIS at DTE	Read the dsx1LineStatus object for DTE E1 <i>dsx1LossOfSignal</i> <i>dsx1LossOfFrame</i> <i>dsx1RcvFarEnd</i> <i>dsx1RcvAIS</i>
Stat→Perf→NET→Cur: CurTimer ES UAS SES BES	Read the value in following objects for NET E1 dsx1TimeElapsed dsx1CurrentES dsx1CurrentUAS dsx1CurrentSES dsx1CurrentBES
Stat→Perf→NET→Intvl→Dsply: ES UAS SES BES VldIntvl	Select the interval number with dsx1IntervalNumber . Read the value in the following objects for the NET E1 dsx1IntervalES dsx1IntervalUAS dsx1IntervalSES dsx1IntervalBES dsx1ValidIntervals
Stat→Perf→NET→24Tot: VldIntvl ES UAS SES BES	Read the value in the following objects for NET E1 dsx1ValidIntervals dsx1TotalES dsx1TotalUAS dsx1TotalSES dsx1TotalBES

Table E-1
(2 of 3)
SNMP MIB to Front Panel Command Cross-Reference

Front Panel Command	SNMP MIB Object
Stat→Tstat: LLB Test Active PLB Test Active RLB Test Active DLB Test Active DCLB on Port <i>n</i> DTLB on Port <i>n</i> 1–8 Test Active QRSS on Port <i>n</i> 511 on Port <i>n</i> Mon QRSS, Port <i>n</i> Mon511, Port <i>n</i>	Read: <i>dsx1LineLoop</i> from dsx1LoopbackConfig for Net E1 <i>dsx1PayloadLoop</i> from dsx1LoopbackConfig for Net E1 <i>dsx1PayloadLoop</i> from dsx1LoopbackConfig for DTE E1 <i>dsx1LineLoop</i> from dsx1LoopbackConfig for DTE E1 <i>testFullDuplexLoopback</i> from IfExtnsTestType for Port <i>n</i> <i>testLoopDTLB</i> from IfExtnsTestType for Port <i>n</i> <i>testSend1in8</i> from ifExtnsTestType for Net E1 <i>testSendQRSS</i> from IfExtnsTestType for Port <i>n</i> <i>testSend511</i> from IfExtnsTestType for Port <i>n</i> <i>testMonQRSS</i> from ifExtnsTestType for Port <i>n</i> <i>testMon511</i> from ifExtnsTestType for Port <i>n</i>
Stat→LED→Prtn: DTR CTS RTS	Read: rs232InSigState from rs232InSigName == dtr rs232outSigState from rs232OutSigName == cts rs232InSigState from rs232InSigName == rts
Stat→ID: Ser Mod SRev HRevCCA1 HRevCCA2	Read the sysDescr object from the System Group
Test→Rlpbk→DCLBUP→Prtn	Set IfExtnsTestType for port <i>n</i> to <i>testSendV54Up</i>
Test→Rlpbk→DCLBDN→Prtn	Set IfExtnsTestType for port <i>n</i> to <i>testSendV54Down</i>
Test→Lpbk→LLB Test→Lpbk→Abort→LLB	Set dsx1LoopbackConfig for Net E1 to <i>dsx1LineLoop</i> Set dsx1LoopbackConfig for Net E1 to <i>dsx1NoLoop</i>
Test→Lpbk→PLB Test→Lpbk→Abort→PLB	Set dsx1LoopbackConfig for Net E1 to <i>dsx1PayloadLoop</i> Set dsx1LoopbackConfig for Net E1 to <i>dsx1NoLoop</i>
Test→Lpbk→DLB Test→Lpbk→Abort→DLB	Set dsx1LoopbackConfig for DTE E1 to <i>dsx1LineLoop</i> Set dsx1LoopbackConfig for DTE E1 to <i>dsx1NoLoop</i>
Test→Lpbk→RLB Test→Lpbk→Abort→RLB	Set dsx1LoopbackConfig for DTE E1 to <i>dsx1PayloadLoop</i> Set dsx1LoopbackConfig for DTE E1 to <i>dsx1NoLoop</i>
Test→Lpbk→DCLB→Prtn Test→Lpbk→Abort→DCLB→Prtn	Set IfExtnsTestType for port <i>n</i> to <i>testFullDuplexLoopBack</i> Set dsx1LoopbackConfig for port <i>n</i> to <i>noTest</i>
Test→Lpbk→DTLB→Prtn Test→Lpbk→Abort→DTLB→Prtn	Set IfExtnsTestType for port <i>n</i> to <i>testLoopDTLB</i> Set dsx1LoopbackConfig for port <i>n</i> to <i>noTest</i>
Test→Ptrns→Send→QRSS→Prtn Test→Ptrns→Abort→Send→Prtn	Set IfExtnsTestType for port <i>n</i> to <i>testSendQRS</i> Set IfExtnsTestType for port <i>n</i> to <i>noTest</i>
Test→Ptrns→Send→1in8 Test→Ptrns→Abort→Send→NET	Set ifExtnsTestType for Net E1 to <i>testSend1in8</i> Set dsx1SendCode for Net E1 to <i>dsx1SendNoCode</i>

**Table E-1
(3 of 3)
SNMP MIB to Front Panel Command Cross-Reference**

Front Panel Command	SNMP MIB Object
Test->Ptrns->Send->511->Prtn Test->Ptrns->Abort->Send->Prtn	Set ifExtnsTestType for port <i>n</i> to <i>testSend511</i> Set ifExtnsTestType for port <i>n</i> to <i>noTest</i>
Test->Ptrns->Mon->QRSS->Prtn Test->Ptrns->Abort->Mon->Prtn	Set ifExtnsTestType for port <i>n</i> to <i>testMonQRSS</i> Set ifExtnsTestType for port <i>n</i> to <i>noTest</i>
Test->Ptrns->Mon->511->Prtn Test->Ptrns->Abort->Mon->Prtn	Set ifExtnsTestType for port <i>n</i> to <i>testMon511</i> Set ifExtnsTestType for port <i>n</i> to <i>noTest</i>
Cnfig->Load Cnfig->Save	Set devConfigAreaCopy to desired choice (Active to Customer1, etc.)
Cnfig->Activ->Edit->DTE->DTE->Frame	Set/Display dsx1LineType for DTE E1 to <i>dsx1E1</i> or <i>dsx1E1-CRC</i>
Cnfig->Activ->Edit->DTE->DTE->Coding	Set/Display dsx1LineCoding for DTE E1 to <i>dsx1HDB3</i> or <i>dsx1AMI</i>
Cnfig->Activ->Edit->Port->Prtn->Port Type	Display rs232PortType for port <i>n</i> to <i>rs422</i> or <i>v35</i>
Cnfig->Activ->Edit->Port->Prtn->TxClock	Set/Display rs232SyncPortClockSource for port <i>n</i> to <i>internal</i> or <i>external</i>
Cnfig->Activ->Edit->NET->NET Frame	Set/Display dsx1LineType for NET E1 to <i>dsx1E1</i> or <i>dsx1E1-CRC</i>
Cnfig->Activ->Edit->NET->Mgmt Link	Set/Display dsx1Fdl for NET E1 to <i>dsx1other</i> or <i>dsx1FDL-none</i>
Cnfig->Activ->Edit->Chan->DTE->Assign	Set/Display dsx1FracNumber and dsx1FracIndex for DTE E1
Cnfig->Activ->Edit->Chan->DTE->TS16	Display dsx1SignalMode for DTE E1 to <i>none</i> or <i>messageOriented</i>
Cnfig->Activ->Edit->Chan->Prtn->Assign To Cnfig->Activ->Edit->Chan->Dsply	Set/Display dsx1FracNumber and dsx1FracIndex for DTE or NET E1
Cnfig->Activ->Edit->Chan->Prtn->Port Rate	Display rs232PortInSpeed or rs232PortOutSpeed for port <i>n</i>
Cnfig->Activ->Edit->Gen->Pri Clk Src Cnfig->Activ->Edit->Gen->Sec Clk Src	Display dsx1TransmitClockSource for DTE E1 or NET E1 (Displays the active clock only)
Cnfig->Activ->Edit->User->Com Rate Cnfig->Activ->Edit->User->Aux Rate	Set/Display rs232PortInSpeed or rs232PortOutSpeed for COM or AUX port
Cnfig->Activ->Edit->User->Char Length	Set/Display rs232AyncPortBits for COM port
Cnfig->Activ->Edit->User->CParty	Set/Display rs232AyncPortParity for COM port
Cnfig->Activ->Edit->User->CStop Bits	Set/Display rs232AyncPortStopBits for COM port

IP Network Addressing Scenario

F

Overview	F-1
IP Network Addressing	F-1

Overview

This appendix describes a means of configuring 31xx Series devices in an Internet Protocol (IP) network to provide SNMP connectivity to a network management system (NMS). Since there are many possible network addressing schemes, this appendix describes an addressing scheme for a typical customer network scenario. This appendix is not intended to be an IP addressing or routing tutorial, and a basic understanding of IP and 31xx Series features is assumed.

IP Network Addressing

The IP network addressing scenario (Figure F-1) consists of a series of standalone 31xx Series devices daisy chained together, with remotes connected via the FDL. In this scenario, all 31xx Series devices are on the same subnet (135.18.1.0). The subnet mask for each device is FF.FF.FF.00. A static route is set in the NMS host to subnet 135.18.1.0.

The following notes apply to this scenario:

- Connections to remote devices may be via EDL or FDL; however, the FDL is only available on full E1 links (not fractional E1s). Check with the service provider to be sure that the FDL is end-to-end (i.e., not terminated at an intermediate point within the network).
- Interconnected 31xx Series devices automatically pass routing information between them; however, a static route to the subnet(s) must be set in the routing table of the NMS host. This route uses the 31xx Series device connected to the LAN (via the LAN Adapter), or the NMS (via a direct PPP or SLIP connection) as a gateway to the subnet(s). In all instances, the addressing scheme presented works for both the LAN and the direct connections.
- Although routing table entries are maintained automatically by 31xx Series devices, without the need for user configuration, only a maximum of 100 routes is supported for a given device.
- The choice of a host address within a given subnet is completely arbitrary. Choose any legal host address for a given subnet, without regard to the local or remote devices.
- Although the default route (to the NMS) is configurable for all devices, only devices that have a direct external connection to an NMS (via the COM or AUX ports) need a default route set. In the following example, the default port (COM or AUX) is set in the device connected to the LAN Adapter.

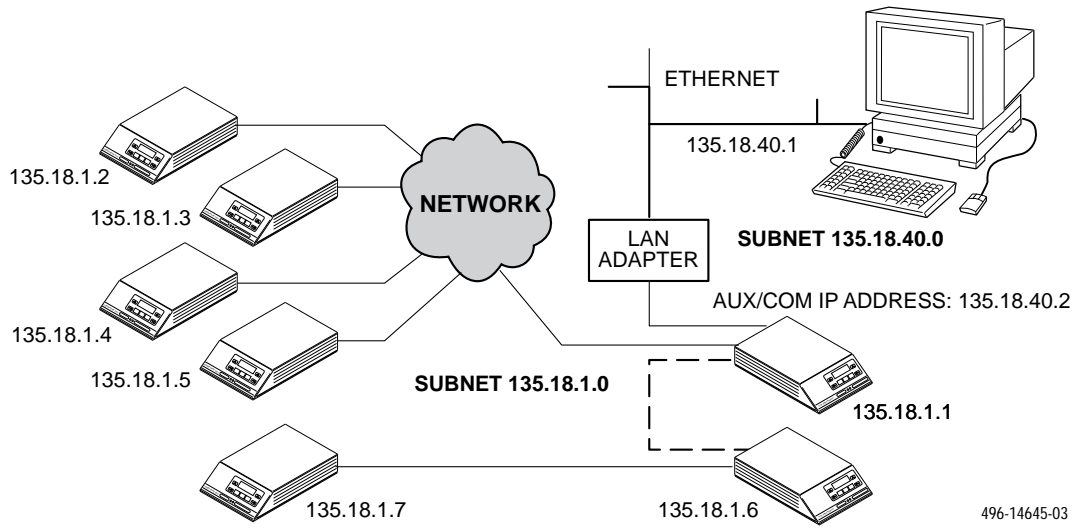

Figure F-1. Daisy-Chained Standalone Devices at the Central Site

Front Panel Emulation **G**

Overview	G-1
Installing Front Panel Emulation Software	G-1
Starting Front Panel Emulation	G-2

Overview

The E1 DSU/CSU offers functionality through Front Panel Emulation software that is similar to that provided by the E1 DSU/CSU front panel. The E1 DSU/CSU can either be locally or remotely attached to a 386 or higher PC that has at least 4 MB of RAM. (An external modem is required for remote attachment.) A copy of the E1 DSU/CSU front panel appears on the PC. The functionality of the front panel is available by clicking on the Function keys with the mouse rather than by pressing keys from the actual front panel.

Installing Front Panel Emulation Software

The Front Panel Emulation software is supplied on a 3.5-inch, 1.44 MB, double-sided, high-density, write-protected diskette, with 15 sectors per track, 80 tracks per side, and 96 tracks per inch.

This software must be installed on a 386 or higher PC with Microsoft Windows Release 3.1 or higher, MS-DOS 3.3 or higher, and at least 4 MB of RAM. A VGA color monitor with VGA adapter (or higher resolution) is required. A mouse is also required. The following procedures must be performed in the Windows environment.

To install Front Panel Emulation software,

1. Insert the diskette into the appropriate drive.
2. Select File from Program Manager.
3. Choose Run.



4. Type the letter of the drive being used by the diskette, followed by a colon. Then,
5. **TYPE:** INSTALL
6. **PRESS:** ENTER
7. An Information screen appears. Choose Continue to continue the installation.
8. Type the letter of the destination drive, followed by a colon (default is C:), then the appropriate directory name (default is C:\FRONTPAN).

If the selected directory already exists, the following message appears: **The specified directory already exists. Do you want to overwrite the directory?**

If the selected directory is new, the following message appears: **The specified directory does not exist. Do you want to create the directory?**
9. Select Yes. A confirmation screen appears. Select Install to continue the installation.
10. A Setup Completed screen appears. Select Continue. The Program Manager screen appears with the Front Panel icon.

Starting Front Panel Emulation

If the E1 DSU/CSU selected is not locally attached to the PC, you must first dial to the remote E1 DSU/CSU before starting front panel emulation. The modem attached to the PC must support AT commands for the Front Panel Emulation software to successfully place the call.

To start front panel emulation,

1. From the PC, open Program Manager from Windows.

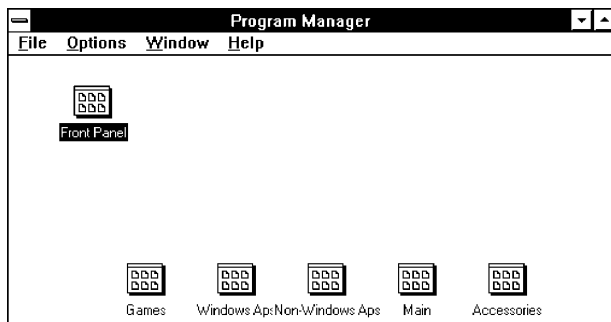

2. The Front Panel Window opens.

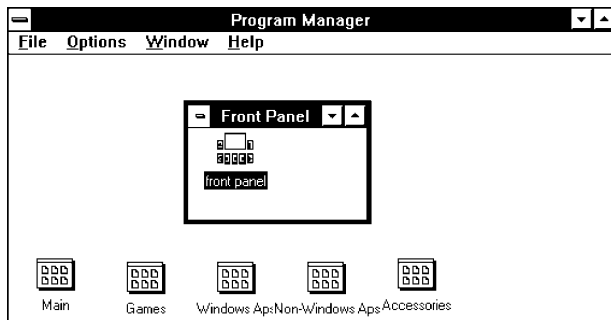

3. Double click on the Front Panel icon that appears after the Front Panel Emulation program is installed on the PC. The Front Panel Emulation screen appears.

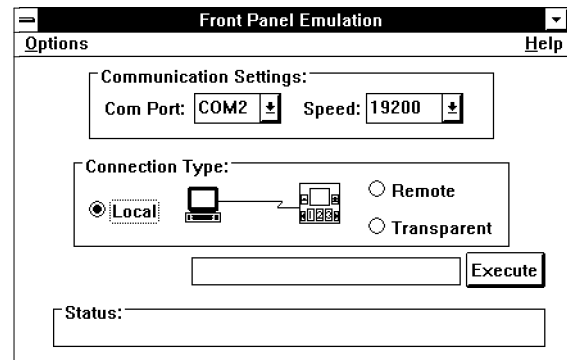

4. Enter the Com Port and Speed from the drop-down selection list boxes.

The **Com Port** field needs to contain the actual communications port name as recorded in the Windows information file (INI).

The **Speed** field needs to contain one of the following communications speeds: 1200, 2400, 4800, 9600, 14400, 19200, or 38400 and should match the DSU/CSU COM port configuration.

5. Choose either a Local (for near-end E1 DSU/CSU) or Remote (for far-end E1 DSU/CSU) destination.
6. If you chose a Local destination, click on the **Execute** button. If you chose a Remote destination, enter the telephone number of the external modem connected to the far-end E1 DSU/CSU in the **Phone Number** field, then click on the **Dial** button.
7. The front panel of the selected E1 DSU/CSU appears on the PC.

NOTE

When using Front Panel Emulation, no LEDs are shown on the PC's screen; you must use the Stat command procedure to get LED information (see the *Displaying LED Conditions* section in Chapter 3, *Operation*).

Equipment List **H**

Equipment	Feature Number	COMCODE
Model 3172 DSU/CSU (120 Vac)	3172-A1-310	107608903
Model 3174 DSU/CSU (120 Vac)	3174-A1-310	107608911
Model 3172 DSU/CSU (100 to 240 Vac)	3172-A1-410	107764516
Model 3174 DSU/CSU (100 to 240 Vac)	3174-A1-410	107764524
Model 3172 DSU/CSU (+24 / -48 Vdc)	3172-A1-510	107765240
Model 3174 DSU/CSU (+24 / -48 Vdc)	3174-A1-510	107765232
E1 120 Ohm Network Interface Cable, 8-pin modular to DB15S	3100-F1-517	107782245
Modular COM Port-to-PC Cable, 8-pin modular to DB9S	3100-F1-550	406941542
COM Port-to-Terminal/Printer Cable, 8-pin modular to DB25P	3100-F1-540	406941534
DC Power Cable	3100-F1-520	406941492
Front Panel Emulation Software	3100-C1-010	406942110
EIA 530A-to-RS449/422 Cable	3100-F1-580	107116543
EIA 530A-to-V.35 Cable	3100-F1-570	107116550
EIA 530A-to-X.21 Cable	3100-F1-571	107768103
Wall-Mount/Rack-Mount Adapter	3100-F1-400	406941674

Glossary

Activ	Active configuration area. The configuration option set that is currently active for the device. Before a configuration option set becomes active, you must save the set to the Active configuration area.
adapter	Hardware that provides some transitional function between two or more devices.
address	A symbol (usually numeric) that identifies the interface attached to a network.
agent (SNMP)	A software program housed within a device to provide SNMP functionality. Each agent stores management information and responds to the manager's request for this information.
aggregate	A single bit stream that combines two or more bit streams.
AIS	Alarm Indication Signal. A signal transmitted instead of the normal signal to maintain transmission continuity and to indicate to the receiving device that a transmission fault exists.
AMI	Alternate Mark Inversion. A line coding technique used to accommodate the ones density requirements of E1 lines.
application	The use to which a device is put.
ASCII	American Standard Code for Information Interchange. A 7-bit code which establishes compatibility between data services.
ASCII terminal/printer	Devices that can be attached, either locally or remotely, to the E1 DSU/CSU to display or print alarm messages.
asynchronous data	Data transmission that is synchronized by a transmission start bit at the beginning of a character (five to eight bits) and one or more stop bits at the end.
authenticationFailure trap	An SNMP trap that indicates that the device has received an SNMP protocol message that has not been properly authenticated.
AUX port	The auxiliary communications port on the E1 DSU/CSU.
AWG	American Wire Gauge. An indication of wire size.
backup capability	The ability to reconfigure the E1 DSU/CSU and restore data circuits through an external backup device.
bandwidth	The range of frequencies that a circuit can pass. The greater the bandwidth, the more information that can be sent in a given amount of time.
BES	Bursty Errored Seconds. Seconds with more than one, but less than 805 CRC errors.
bipolar signal	A signal in which successive "ones" (marks, pulses) are of alternating, positive and negative polarity, and in which a "zero" (space, no pulse) is of zero amplitude.

bit	Binary digit. The smallest unit of information, representing a choice between a one or a zero (sometimes called mark or space).
block allocation method	A method of allocating DS0 channels as a group rather than individually.
BNC	Bayonet-Neill-Concelman. A bayonet-type connector for coaxial cables.
bps	Bits per second. Indicates the speed at which bits are transmitted across a data connection.
BPV	Bipolar Violation. In a bipolar signal, a “one” (mark, pulse) which has the same polarity as its predecessor.
byte	A small group of bits (usually 8) that is handled as a unit of data.
CCITT	The International Consultative Committee for Telegraphy and Telephony. A committee established to recommend communication standards and policies.
CD	Carrier Detect. The received line signal detector. V.24 circuit 109.
cell site	A facility that provides the equipment needed to establish wireless communication links.
CEPT	The European Conference of Postal and Telegraph Authorities. A European standards organization.
channel	An independent data path.
channel allocation	Assigning specific DS0 channels in the E1 DSU/CSU to specific interfaces (Network, DTE Drop/Insert, etc.).
CHAP	Challenge Authentication Protocol.
character	A letter, figure, number, punctuation, or other symbol.
CID branch	Customer Identification branch or the E1 DSU/CSU menu tree.
client	A device that receives a specific service, such as database management, from a server.
CLOCK IN interface	The external clock interface on the E1 DSU/CSU.
ClrReg branch	Clear Performance Registers branch of the E1 DSU/CSU menu tree.
Cnfig branch	Configuration branch of the E1 DSU/CSU menu tree.
coaxial cable	A transmission cable consisting of a conducting outer tube which encloses and is insulated from an inner conducting core.
coding	A technique used to accommodate the ones density requirements of E1 lines.
COMCODE	A code used when ordering parts.
COM port	The communications port on the E1 DSU/CSU.
community name	An identification used by SNMP to grant an SNMP server access rights to a MIB.
configuration	The arrangement of a system or network as defined by the characteristics of its functional units.
configuration option	Device firmware that establishes specific operating parameters for the device. Sometimes referred to as straps.
CPU fail	Central Processing Unit failure. A Self-Test Health message indicating a failure in the device’s central processing unit.
CRC	Cyclic Redundancy Check. A mathematical method of confirming the integrity of received digital data.
CRC4	CRC using four check bits.
CRC5	CRC using five check bits.

CRC6	CRC using six check bits.
CSA	Canadian Standards Association.
CSU	Channel Service Unit. Protects the E1 line from damage and regenerates the E1 signal.
Ctrl branch	Control branch of the E1 DSU/CSU menu tree.
CTS	Clear-to-Send. V.24 circuit 106.
Cust1	Customer 1 configuration area. The first of two sets of customer-defined configuration options.
Cust2	Customer 2 configuration area. The second of two sets of customer-defined configuration options.
DACS	Digital Access and Cross-connect System. A device that allows DS0 channels to be individually rerouted and reconfigured.
daisy chaining	Connecting the COM port of one E1 DSU/CSU to the AUX port of another E1 DSU/CSU to provide SNMP connectivity.
database	An organized compilation of computerized data.
data port	The electrical interface between the E1 DSU/CSU and the synchronous data terminal equipment.
DB15 connector	A 15-position connector used on cables or devices.
DB25 connector	A 25-position connector used on cables or devices.
DCE	Data Circuit-terminating Equipment or Data Communications Equipment. A device which provides signal conversion for communication between the DTE and the network.
DCLB	Data Channel Loopback. Loops the data received from the network interface, for all DS0 channels allocated to the selected port, back to the network.
default	A preset value that is assumed to be correct unless changed by the user.
DevFail	Device Failure. A message that indicates that an internal failure has been detected by the operating firmware. An 8-digit code appears for use by service personnel.
DevHS branch	Device Health and Status branch of the E1 DSU/CSU menu tree.
device	A mechanical, electrical, or electronic unit with a special purpose.
digital signal	A signal composed of discrete elements (zeros and ones) instead of a great multitude of analog elements.
diskette	A thin, flexible magnetic disk enclose in a protective jacket.
DLB	DTE Loopback. Loops the received signal on the DTE Drop/Insert port back to the DTE without change.
DL branch	Download branch of the E1 DSU/CSU menu tree.
download	A process that transfers device firmware from a locally-attached PC to a device, or allows the duplication of firmware from a local device to a remote device.
downstream device	A device that is connected farther from the host computer.
drop/insert	An interconnection point for terminals, multiplexers, and transmission facilities. Individual channels may be inserted into the aggregate stream or dropped out to accommodate specific applications.
DSR	Data Set Ready. V.24 circuit 107.

DSU	Data Service Unit. Data communications equipment that provides an interface between the DTE and the digital network.
DS0	Digital Signal Level 0. A 64 kbps standard signal or channel.
DS0 channel allocation	Assigning specific DS0 channels in the E1 DSU/CSU to specific interfaces (Network, DTE Drop/Insert, etc.).
DS1/E1 MIB	Defines objects for managing E1 interfaces and supports the network and DTE Drop/Insert interfaces on the E1 DSU/CSU.
DTE	Data Terminal Equipment. The equipment, such as a computer or terminal, that provides data in the form of digital signals.
DTE Drop/Insert interface	The drop/insert interface that is labeled "DTE" on the rear panel of the E1 DSU/CSU.
DTLB	Data Terminal Loopback. Loops the data received from the selected port, for all DS0 channels allocated to the port, back out the port.
DTR	Data Terminal Ready. V.24 circuit 108/1, /2.
EDL	Embedded Data Link. The 8 kbps in-band performance channel that provides 4 kbps of user bandwidth for the support of an SNMP management link.
EER	Excessive Error Rate. An error rate that is greater than the threshold that has been configured in the E1 DSU/CSU.
EIA	Electronic Industries Association. An organization providing standards for the data communication industry.
EIA 530A	An EIA standard for a high-speed, 25-position, DCE/DTE interface.
Enterprise MIB	MIB objects unique to Paradyne devices.
enterprise-specific trap	A trap unique to Paradyne devices.
error	A discrepancy between a measured or computed value or condition and the true or specified value or condition.
ES	Errored seconds. Seconds with one or more error events.
ESD	Electrostatic discharge. An undesirable discharge of static electricity that can damage equipment and degrade electrical circuitry.
E1	A wideband digital interface operating at 2.048 Mbps defined by CCITT standards G.703 and G.704.
Fact	Factory configuration area. A configuration option set that is preset at the company (read-only options).
failure	An uncorrected hardware error.
fault	An accidental condition that causes a functional unit to fail to perform its required function.
FCC	Federal Communications Commission. A board of commissioners that regulates electrical communication systems that originate in the United States.
FDL	Facility Data Link. The selected framing bits in a wide-area link that are used for control, monitoring, and testing.
Fractional E1	Individual DS0 channels that may be sold separately or in groups to provide bandwidth that is some fraction of the total E1 capability.
frame	One identifiable group of bits that includes a sequence of bits for control, framing, etc.

frame relay	A switching interface that is designed to get frames from one part of the network to another as quickly as possible.
framing	A technique that separates bits into identifiable groups.
Generic-Interface Extension MIB	An extension to MIB II that defines additional objects for control of generic interfaces in MIB II.
Get command (SNMP)	Read-only access to SNMP MIB objects.
ground	A physical connection to earth or other reference point.
HDB3	High Density Bipolar Three Zeros Substitution. A line coding technique used to accommodate the ones density requirements of E1 lines.
HDLC	High-level Data Link Control. A communications protocol defined by the International Standards Organization (ISO).
host	A computer system used for application processing on a network.
Hz	Hertz. A unit of frequency that equals one cycle per second.
ICMP	Internet Control Management Protocol. The protocol that enables in-band control, diagnostic, and error messages to be passed between nodes in an IP internetwork.
ID branch	Identity branch of the E1 DSU/CSU menu tree.
interface	A shared boundary between functional units.
Internet	The worldwide interconnected collection of networks that predominantly use the TCP/IP protocol.
internetwork	An interconnected collection of networks (also called an internet).
IP address	Internet Protocol address. The address used by the SNMP manager to access the device.
ISO	International Standards Organization.
kbps	Kilobits per second (thousand bits per second).
LAN	Local Area Network. A network that spans a small geographic area (e.g., a building).
LCD	Liquid Crystal Display. Sealed glass plates containing liquid crystal material. When voltage is applied, the amount of light passing through the plates is altered so that messages may be displayed.
LCP	Link Control Protocol.
LED	Light-Emitting Diode. A status indicator that glows in response to the application of a voltage.
link	A communication path between two network nodes.
link layer protocol	The protocol that regulates the communication between two network nodes.
link trap	A trap that identifies the condition of the communications interface (linkDown or linkUp traps).
LLB	Line Loopback. Loops the received signal on the network interface back to the network without change.
LOF	Loss Of Frame. The inability to maintain frame synchronization.
LOFC	Loss Of Frame Count. A count of the number of LOFs declared.
loopback test	A test that verifies a device's operation by connecting the device's output to the device's input.
LOS	Loss Of Signal. The E1 line condition where there are no pulses.

Lpbk branch	Local Loopback branch of the E1 DSU/CSU menu tree.
LQR	Link Quality Reports.
manager (SNMP)	The device that queries agents for management information, or receives unsolicited messages (traps) indicating the occurrence of specific events.
MB	Megabytes. A unit of memory measurement equal to approximately one million bytes (typically 1,048,576 bytes).
Mbps	Megabits per second (million bits per second).
menu tree	A display of E1 DSU/CSU functions that are accessed by selecting various branches (Status, Test, etc.).
MIB	Management Information Base. A database of managed objects used by SNMP to provide network management information.
MIB II	MIB Release 2. The current Internet-standard MIB.
MRU	Maximum Request Unit.
mobile switching center	A facility that provides overall control for a wireless communication system. Cell sites are linked to the public telephone network through a mobile switching center.
network	A configuration of data processing devices for information exchange.
NETWORK interface	The network interface connectors on the rear panel of the E1 DSU/CSU.
NMS	Network Management System. A computer system used for monitoring and controlling network devices.
node	A connection or switching point on the network.
object (SNMP)	A specific item within a Management Information Base (MIB).
OOF	Out Of Frame. An error condition in which frame synchronization bits are in error.
option	A hardware or software function that can be selected or enabled as part of a configuration process.
PAP	Password Authentication Protocol.
parity	A way of checking data accuracy by counting the number of bits that have a value of one.
payload	The information bits in a frame.
PBX	Private Branch Exchange. Telephone switching equipment dedicated to one customer. A PBX connects private telephones to each other and to the public network.
PC	Personal computer. In this document, references to a PC imply an IBM PC or an IBM-compatible PC.
PDU	Protocol Data Unit. Used when adding routes in the Internet.
PDV	Pulse Density Violation. The number of "ones" (marks, pulses) is not adequate for the line requirement.
Perf branch	Performance Report branch of the E1 DSU/CSU menu tree.
PLB	Payload Loopback. Loops the received signal on the network interface back to the network after it has passed through the framing circuitry of the E1 DSU/CSU.
port	An access point for data entry or exit.
PORT (1–4) interface	The synchronous data port interface on the E1 DSU/CSU.
POWER connector	The power input connector on the E1 DSU/CSU.

power-up self-test	A test that checks most hardware components when power is applied to the device or a reset is initiated.
PPP	Point-to-Point Protocol. A link layer protocol used by SNMP.
PRBS	Pseudo-Random Bit Sequence. A test pattern containing any possible combination of digital ones and zeros for a given string length.
primary clock	The primary timing source used to synchronize all of the E1 and data port interfaces on the E1 DSU/CSU.
PRM	Performance Report Message. A message indicating performance data such as errored seconds, unavailable seconds, etc.
protocol	A set of rules that determines the behavior of functional units in achieving communication.
Ptrns branch	Test Patterns branch of the E1 DSU/CSU menu tree.
pulse density	A measure of the number of “ones” (marks, pulses) in relation to the total number of bits transmitted.
QRSS Test	Quasi-Random Signal Test. A test pattern simulating a random pattern of digital ones and zeros used to simulate normal transmission.
RAI	Remote Alarm Indication. A remote alarm on an E1 line.
RAM	Random-access memory. Read/write memory that is volatile and loses its contents when power is removed.
register	A part of the device’s memory that holds stored values.
Rel branch	Release branch of the E1 DSU/CSU menu tree.
reset	A reinitialization of the E1 DSU/CSU that occurs at power-up or in response to a reset command.
RFC	Request for Comments. The set of documents that describes the standard specifications for the TCP/IP protocol suite.
RIP	Routing Information Protocol. A protocol used to add routes in the Internet.
RJ48C	An 8-position modular connector.
RLB	Repeater Loopback. Loops the signal being sent to the network back to the DTE Drop/Insert and data ports after it has passed through the framing circuitry of the E1 DSU/CSU.
Rlpbk branch	Remote Loopback branch of the E1 DSU/CSU menu tree.
router	A device that connects LAN segments.
RS-232	An EIA standard for a low-speed, 25-position, DCE/DTE interface.
RS-232-like MIB	Defines objects for managing RS-232-type interfaces (e.g., RS-422, RS-423, etc.) and supports synchronous data ports and management communication ports on the E1 DSU/CSU.
RS-449	An EIA standard for a general-purpose, 37-position, DCE/DTE interface.
RTS	Request-to-Send. V.24 circuit 105.
RX	Receive. To obtain signals that have been transmitted.
RXC	Receive Clock. V.24 circuit 115.
RXD	Receive Data. V.24 circuit 104.
secondary clock	The secondary clock source used to provide timing to the E1 DSU/CSU when the primary clock fails.

self-test	A test that checks most hardware components when power is applied to the device or a reset is initiated.
server	A device that offers a specific service, such as database management, to a client.
SES	Severely Errored Seconds. Seconds with 805 or more CRC errors or errored frame alignment signals; or one or more LOS, AIS, or OOF events.
Set command (SNMP)	Write access to SNMP MIB objects.
SLIP	Serial Line Internet Protocol. A link layer protocol used by SNMP.
SNMP	Simple Network Management Protocol. A generic network management system that allows the device to be managed by any industry-standard SNMP manager.
Stat branch	Status branch of the E1 DSU/CSU menu tree.
STest branch	Self Test Health branch of the E1 DSU/CSU menu tree.
StEvt	Status Event Register. Records the occurrence of certain alarm conditions.
subnet	An IP addressing standard in which a portion of the host address can be used to create multiple network addresses that are logically a subdivision of the network address.
subnet mask	An integer used with the IP address of the host to determine which bits in the host address are used in the subnet address.
synchronous data	Data transmission that is synchronized by timing signals. Characters are sent at a fixed rate.
TCP/IP	Transmission Control Protocol/Internet Protocol. The dominant protocol in the worldwide Internet.
time slot	The allocated DS0 channel slot when DS0 channels are combined to form an aggregate bit stream.
trap (SNMP)	A notification message to the SNMP manager when an unusual event occurs on a network device, such as a reinitialization.
TStat branch	Test Status branch of the E1 DSU/CSU menu tree.
TS16	Time-slot 16. The time slot which may be reserved for signaling.
TX	Transmit. To send signals from a device.
TXC	Transmit Clock. V.24 circuit 114.
TXD	Transmit Data. V.24 circuit 103.
UAS	Unavailable Seconds. A count of 1-second intervals when service is unavailable.
UDP	User Datagram Protocol. A TCP/IP protocol describing how messages reach application programs within a destination computer.
UL	Underwriter's Laboratories, Inc. An organization which promotes product safety.
Vac	Volts alternating current.
Vdc	Volts direct current.
V.24	A CCITT standard for a low-speed, 25-position, DCE/DTE interface.
V.35	A CCITT standard for a high-speed, 34-position, DCE/DTE interface.
V.54	A CCITT standard for local and remote diagnostic loopback tests.
V.54 Loop 2	A CCITT standard for a data channel loopback (DCLB).
V.54 Loop 3	A CCITT standard for a data terminal loopback (DTLB).
WAN	Wide Area Network. A network that spans a large geographic area (e.g., a country).

warmStart trap	An SNMP trap that indicates that the device has reinitialized itself.
wireless communications	The transmission of voice and/or data over the airwaves.
XTXC	External Transmit Clock. V.24 circuit 113.
1in8 Test	A test pattern consisting of a one (1) followed by seven zeros (on the network only).
511 Test	A pseudo-random bit sequence (PRBS) that is 511 bits long (on the data ports only). This is a PRBS 2^9-1 test.

Index

A

- abort
 - lamp test, 4-24
 - loopback, 4-19–4-20
 - test patterns, 4-22–4-23
- ac power module, 1-5, B-1
- Activ (Active) configuration area
 - functional description, 3-11
 - in the menu tree, A-1
- addressing. *See* IP (Internet Protocol) addressing
- agent, SNMP, 1-2
- AIS (Alarm Indication Signal) condition
 - ASCII terminal/printer message, 4-9
 - Device Health and Status message, 4-4
 - front panel LED indication, 3-5, 3-6
 - Performance Report message, 4-7
 - troubleshooting, 4-11
- Alarm Configuration branch
 - example of use, 3-18
 - in the menu tree, A-1
 - option table, C-16
 - option worksheet, C-23
- alarm messages. *See* messages, alarm
- allocation, DS0 channel. *See* channel allocation
- AMI (Alternate Mark Inversion), C-2
- applications, 1-1, 2-1–2-2
- ASCII terminal/printer
 - cabling example, 2-8
 - used for alarm messages, 1-2
- authenticationFailure trap, 4-10
- AUX Port
 - configuration option, C-15
 - functional description, 1-5
 - physical description, 1-4
 - pin assignments, D-4
 - used with SNMP system, 1-2, 2-3, 3-14, F-1

B

- backup capability, 3-32
- BES (Bursty Errored Seconds) report, 4-7
- block method of channel allocation, 3-29
- BPV (Bipolar Violation) condition
 - front panel LED indication, 3-6
 - Performance Report message, 4-8
 - troubleshooting, 4-12

C

- cabling
 - equipment list, H-1
 - examples, 2-8
 - pin assignments, D-1–D-15
- Chan (Channel) Configuration branch
 - example of use, 3-20–3-32
 - in the menu tree, A-1
 - option table, C-8–C-11
 - option worksheet, C-25, C-26, C-27
- channel allocation
 - configuration options, C-8–C-11
 - procedure for configuring, 3-20–3-32
- CID (Customer Identification) branch
 - example of use, 3-9
 - in the menu tree, A-1
- Circuit Identifier configuration option, C-7
- CLOCK IN interface
 - functional description, 1-5, 3-33
 - physical description, 1-4
 - pin assignments, D-15
- clocking
 - configuration options, C-12
 - principles of operation, 3-33
 - technical specifications, B-2
- ClrReg (Clear Performance Registers) branch
 - example of use, 4-6
 - in the menu tree, A-1
- Cnfig (Configuration) branch. *See* configuration options
- coding, line, C-2
- COM Port
 - acquiring/releasing the user interface, 3-35–3-36
 - cabling example, 2-8
 - configuration option, C-13
 - functional description, 1-5
 - physical description, 1-4
 - pin assignments, D-5–D-6
 - used with ASCII terminal/printer, 1-2, 2-8, 4-9
 - used with SNMP system, 1-2, 2-3, 3-14, F-1
- COMCODE numbers, H-1
- community name
 - configuration option, C-17
 - procedure for configuring, 3-17–3-18
- configuration options
 - procedure for changing, 3-11–3-14
 - tables
 - Alarm, C-16
 - Channel, C-8–C-11

- DTE Interface, C-2
- General, C-12
- Network Interface, C-7
- Port, C-3–C-6
- SNMP, C-17–C-22
- User Interface, C-13–C-15
- worksheets, C-23–C-28
- connectors, rear panel
 - cabling examples, 2-8
 - functional description, 1-5
 - physical description, 1-4
 - pin assignments, D-1–D-15
- CPU failure message, 4-2
- Ctrl (Control) branch
 - examples of use, 3-9, 3-11, 3-36
 - in the menu tree, A-1
- Cust1 (Customer 1) configuration area
 - functional description, 3-11
 - in the menu tree, A-1
- Cust2 (Customer 2) configuration area
 - functional description, 3-11
 - in the menu tree, A-1
- cyclic redundancy check (CRC)
 - configuration option, C-2, C-7
 - error indication, 4-7

D

- DACS (Digital Access and Cross-connect System), 2-1, 2-2
- daisy chaining
 - configuration options, C-13, C-15
 - connectivity, 1-5, 2-3, 2-4
- data channel loopback (DCLB), 4-18, C-3
- data port. *See* PORT (1–4) interface
- data terminal loopback (DTLB), 4-19, C-3
- database, SNMP, 1-2
- DC power option, D-14
- dc power option, 2-5–2-7, B-1, D-14
- default configuration options, C-1
- DevFail (Device Failure) message, 4-4
- DevHS (Device Health and Status) branch
 - example of use, 4-3–4-4
 - in the menu tree, A-1
- dimensions, B-2
- DL (Download) branch
 - in the menu tree, A-1
 - operation, 3-36
- DSO channel allocation. *See* channel allocation
- DTE Configuration branch
 - in the menu tree, A-1
 - option table, C-2
 - option worksheet, C-23
- DTE Drop/Insert interface
 - channel allocation procedure, 3-20–3-26
 - configuration options, C-2
 - failure message, 4-2

- front panel LED indications, 3-6
- functional description, 1-2, 1-5, 2-1
- managed by SNMP, 1-2
- physical description, 1-4
- pin assignments, D-3
- technical specifications, B-1
- troubleshooting, 4-11
- DTE loopback (DLB), 4-17
 - configuration option, C-2
 - external control interface, D-3

E

- EER (Excessive Error Rate) condition
 - ASCII terminal/printer message, 4-9
 - Device Health and Status message, 4-4
 - front panel LED indication, 3-5, 3-6
 - Performance Report message, 4-8
 - troubleshooting, 4-12
- EIA 530A interface, D-7
- Embedded Data Link (EDL)
 - configuration option, C-5, C-6
 - used with SNMP system, 1-2, 2-3, 2-4, F-1
- enterprise-specific trap, 4-10
- environmental specifications, B-2
- equipment list, H-1
- error messages. *See* messages, alarm
- ES (Errored Seconds) report, 4-7

F

- Facility Data Link (FDL)
 - configuration option, C-7
 - used with SNMP system, 1-2, 2-3, 2-4, F-1
- Fact (Factory) configuration area
 - functional description, 3-11
 - in the menu tree, A-1
- failure analysis. *See* troubleshooting
- failure message
 - during power-up self-test, 2-9, 4-4
 - troubleshooting, 4-12
- feature numbers, H-1
- features, 1-1–1-2
- fractional E1, 2-1, 2-2
- framing configuration option, C-2, C-7
- front panel
 - acquiring/releasing the user interface, 3-35–3-36
 - operation, 3-2–3-7
 - physical description, 1-3, 3-2
- Front Panel Emulation
 - cabling example, 2-8
 - feature number, H-1
 - functional description, 1-2, 3-2, G-1
 - installation and operation, G-1–G-2

G

- Gen (General) Configuration branch
 - example of use, 3-34–3-35
 - in the menu tree, A-1
 - option table, C-12
 - option worksheet, C-23

H

- HDB3 (High Density Bipolar 3) coding
 - configuration option, C-2
 - Self-Test Health message, 4-2

I

- ID (Identity) branch
 - example of use, 3-8
 - in the menu tree, A-1
- indicators. *See* LEDs, front panel
- IP (Internet Protocol) addressing
 - configuration option, C-18, C-19, C-20
 - example of use, F-1–F-2
 - procedure for configuring, 3-15–3-16, 3-19

K

- keypad
 - operation, 3-3–3-4
 - physical description, 1-3, 3-2

L

- lamp test, 4-23–4-24
- LAN Adapter, 1-2, 1-5, 2-3, 2-4, 3-14, F-1
- LED Control branch
 - example of use, 3-11
 - in the menu tree, A-1
- LED Status branch
 - example of use, 3-10
 - in the menu tree, A-1
- LEDs, front panel
 - during power-up self-test, 2-9
 - functional description, 3-4–3-7
 - lamp test, 4-23–4-24
 - physical description, 1-3, 3-2
- line coding, C-2
- line loopback (LLB), 4-16
- link layer protocol, 3-14, 3-16
- link trap, 4-10
- liquid crystal display (LCD)
 - failure message, 4-2
 - functional description, 3-3
 - physical description, 1-3, 3-2

- LOF (Loss Of Frame) condition
 - front panel LED indication, 3-5, 3-6
 - Performance Report message, 4-7
- LOFC (Loss Of Frame Count) report, 4-8
- loopback
 - front panel LED indication, 3-5
 - local, 4-15–4-20
 - abort, 4-19–4-20
 - data channel loopback (DCLB), 4-18
 - data terminal loopback (DTLB), 4-19
 - DTE loopback (DLB), 4-17, C-2, D-3
 - line loopback (LLB), 4-16
 - payload loopback (PLB), 4-16
 - repeater loopback (RLB), 4-17–4-18
 - remote, 4-14
- LOS (Loss Of Signal) condition
 - ASCII terminal/printer message, 4-9
 - Device Health and Status message, 4-4
 - front panel LED indication, 3-5, 3-6
 - Performance Report message, 4-7, 4-8
 - Self-Test Health message, 4-2
 - troubleshooting, 4-11
- Lpbk (Local Loopback) branch
 - example of use, 4-15–4-20
 - in the menu tree, A-1

M

- maintenance
 - device health and status, 4-3–4-4
 - performance reporting, 4-5–4-8
 - power-up self-test, 2-9, 4-2
- manager, SNMP, 1-2
- menu tree, A-1
- messages
 - alarm
 - Device Health and Status, 4-4
 - Performance Report, 4-7
 - Self-Test Health, 4-2
 - troubleshooting, 4-11
 - with ASCII terminal/printer, 1-2, 4-9
 - status
 - Device Health and Status, 4-4
 - Performance Report, 4-7
 - Self-Test Health, 2-9, 4-2
 - Test Status, 4-24–4-26
- MIBs, SNMP. *See* SNMP, MIBs
- model numbers, H-1

N

- NET (Network) Configuration branch
 - example of use, 3-12
 - in the menu tree, A-1
 - option table, C-7
 - option worksheet, C-23
- network interface
 - cabling example, 2-8

- channel allocation procedure, 3-20–3-26
- configuration options, C-7
- failure message, 4-2
- front panel LED indications, 3-5
- functional description, 1-5, 2-1
- physical description, 1-4
- pin assignments, D-2
- technical specifications, B-1
- troubleshooting, 4-11

O

- objects, SNMP, 1-2, E-1–E-18
- OOOF (Out Of Frame) condition
 - ASCII terminal/printer message, 4-9
 - Device Health and Status message, 4-4
 - front panel LED indication, 3-5, 3-6
 - Performance Report message, 4-7
 - troubleshooting, 4-11
- options, strap. *See* configuration options

P

- part numbers, H-1
- pattern tests, 4-20–4-23
- payload loopback (PLB), 4-16
- PBX applications, 2-2
- PDV (Pulse Density Violation) condition, 3-6
- Perf (Performance Report) branch
 - example of use, 4-5–4-6
 - in the menu tree, A-1
- performance reporting, 4-5–4-8, C-5, C-6
- physical description of E1 DSU/CSU, 1-3–1-5, B-2
- pin assignments, D-1–D-15
- Point-to-Point Protocol (PPP)
 - procedure for configuring, 3-16
 - used with SNMP system, 1-2, 2-3, 2-4, 3-14, F-1
- PORT (1–4) interface
 - channel allocation procedure, 3-20–3-26
 - configuration options, C-3–C-6
 - failure message, 4-2
 - front panel LED indications, 3-7
 - functional description, 1-5, 2-1
 - managed by SNMP, 1-2
 - physical description, 1-4
 - pin assignments, D-7
 - technical specifications, B-2
- Port Configuration branch
 - example of use, 3-13–3-14
 - in the menu tree, A-1
 - option table, C-3–C-6
 - option worksheet, C-24
- power input
 - cabling example, 2-8
 - connector, 1-4, 1-5, D-14
 - consumption, B-1

- optional power sources, 2-5–2-7, B-1, D-14
- requirement, B-1
- troubleshooting, 4-11
- power module, 1-5, B-1
- power-up self-test
 - displaying results, 4-2
 - front panel indications, 2-9, 3-5
 - troubleshooting, 4-11
- primary clock
 - configuration option, C-12
 - functional description, 3-33
 - procedure for configuring, 3-34
- problem determination. *See* troubleshooting
- protocol, link layer, 3-14, 3-16
- Ptrns (Test Patterns) branch
 - example of use, 4-20–4-23
 - in the menu tree, A-1

Q

- QRSS Test, 4-20

R

- RAI (Remote Alarm Indication) condition
 - ASCII terminal/printer message, 4-9
 - Device Health and Status message, 4-4
 - front panel LED indication, 3-5, 3-6
 - Performance Report message, 4-8
 - troubleshooting, 4-11
- rate
 - auxiliary port, C-15
 - communications port, C-14
 - external clock, C-12
 - synchronous data port, C-3, C-10
- rear panel
 - connectors. *See* connectors, rear panel
 - physical description, 1-3–1-5
 - switch, 1-4, 1-5
- Rel (Release) branch
 - example of use, 3-35–3-36
 - in the menu tree, A-1
- remote loopback, 4-14
- repeater loopback (RLB), 4-17–4-18
- reset
 - front panel indications, 2-9
 - procedure, 3-36
- Reset branch
 - example of use, 3-36
 - in the menu tree, A-1
- Rlpbk (Remote Loopback) branch
 - example of use, 4-14
 - in the menu tree, A-1
- router applications, 2-1, 2-2
- RS-449 interface, D-9
- RX network connector, 1-5
- RX shield, 1-5

S

- secondary clock
 - configuration option, C-12
 - functional description, 3-33
- self-test
 - displaying results, 4-2
 - front panel indications, 2-9, 3-5
 - troubleshooting, 4-11
- Send Ones configuration option, C-2, C-4
- Serial Line Internet Protocol (SLIP)
 - procedure for configuring, 3-16
 - used with SNMP system, 1-2, 2-3, 3-14, F-1
- SES (Severly Errored Seconds) report, 4-7
- shield, RX, 1-5
- SNMP (Simple Network Management Protocol)
 - agent, 1-2
 - configuration options
 - examples of use, 3-14–3-19
 - menu tree branches, A-1
 - option table, C-17–C-22
 - option worksheet, C-28
 - connection examples, 2-3–2-4, 2-8, F-1–F-2
 - database, 1-2
 - IP addressing, F-1–F-2
 - manager, 1-2
 - MIBs
 - functional description, 1-2
 - list of objects, E-1–E-18
 - procedure for configuring access, 3-17–3-18
 - objects, 1-2
 - principles of operation, 1-2
 - SNMP Down message, 4-4, 4-12
 - traps
 - functional description, 1-2, 4-10
 - procedure for configuring, 3-18–3-19
- specifications, environmental, B-1, B-2
- Stat (Status) branch
 - examples of use, 3-8, 3-10, 4-2, 4-3, 4-5, 4-24
 - in the menu tree, A-1
- status messages. *See* messages, status
- STest (Self-Test Health) branch
 - example of use, 4-2
 - in the menu tree, A-1
- StEvt (Status Event) report, 4-8
- straps. *See* configuration options
- subnet, 3-14, C-18, C-19, C-20, F-1
- switch, rear panel, 1-4, 1-5
- synchronous data port. *See* PORT (1–4) interface

T

- technical specifications, B-1
- temperature
 - operating, B-2
 - storage, B-2
- Test branch
 - example of use, 4-14–4-26
 - in the menu tree, A-1
- test commands, 4-14–4-26
 - front panel LED indications, 3-5

- lamp test, 4-23–4-24
- local loopback, 4-15–4-20
 - abort, 4-19–4-20
 - data channel loopback (DCLB), 4-18
 - data terminal loopback (DTLB), 4-19
 - DTE loopback (DLB), 4-17
 - line loopback (LLB), 4-16
 - payload loopback (PLB), 4-16
 - repeater loopback (RLB), 4-17–4-18
- remote loopback, 4-14
- test messages, 4-24–4-26
- test patterns, 4-20–4-23
- test jacks
 - functional description, 4-13
 - physical description, 1-3, 3-2, 3-4
- time-slot 16 (TS16)
 - channel allocation, 3-20, 3-21, 3-22
 - configuration option, C-8
- timing. *See* clocking
- traps, SNMP. *See* SNMP, traps
- troubleshooting
 - device health, 4-3–4-4
 - diagnostic table, 4-11–4-12
 - performance, 4-5–4-8
 - power-up self-test, 2-9, 4-2
- TStat (Test Status) branch
 - example of use, 4-24–4-26
 - in the menu tree, A-1
- TX network connector, 1-5

U

- UAS (Unavailable Seconds) report, 4-7
- User Configuration branch
 - example of use, 3-14–3-15
 - in the menu tree, A-1
 - option table, C-13–C-15
 - option worksheet, C-23
- user interface, acquiring/releasing, 3-35–3-36

V

- V.35 interface, D-11
- V.54 Loop 2. *See* data channel loopback (DCLB)
- V.54 Loop 3. *See* data terminal loopback (DTLB)

W

- warmStart trap, 4-10
- weight, B-2
- wireless communications, 2-1, 2-2
- worksheets, configuration option, C-23–C-28

X

- X.21 interface, D-13

Free Manuals Download Website

<http://myh66.com>

<http://usermanuals.us>

<http://www.somanuals.com>

<http://www.4manuals.cc>

<http://www.manual-lib.com>

<http://www.404manual.com>

<http://www.luxmanual.com>

<http://aubethermostatmanual.com>

Golf course search by state

<http://golfingnear.com>

Email search by domain

<http://emailbydomain.com>

Auto manuals search

<http://auto.somanuals.com>

TV manuals search

<http://tv.somanuals.com>