



**Hotwire[®] TDM SDSL
Termination Units
Models 8777 and 8779
User's Guide**

Document No. 8700-A2-GB20-40

May 2002

PARADYNE[®]

Copyright © 2002 Paradyne Corporation.
All rights reserved.
Printed in U.S.A.

Notice

This publication is protected by federal copyright law. No part of this publication may be copied or distributed, transmitted, transcribed, stored in a retrieval system, or translated into any human or computer language in any form or by any means, electronic, mechanical, magnetic, manual or otherwise, or disclosed to third parties without the express written permission of Paradyne Corporation, 8545 126th Ave. N., Largo, FL 33773.

Paradyne Corporation makes no representation or warranties with respect to the contents hereof and specifically disclaims any implied warranties of merchantability or fitness for a particular purpose. Further, Paradyne Corporation reserves the right to revise this publication and to make changes from time to time in the contents hereof without obligation of Paradyne Corporation to notify any person of such revision or changes.

Changes and enhancements to the product and to the information herein will be documented and issued as a new release to this manual.

Warranty, Sales, Service, and Training Information

Contact your local sales representative, service representative, or distributor directly for any help needed. For additional information concerning warranty, sales, service, repair, installation, documentation, training, distributor locations, or Paradyne worldwide office locations, use one of the following methods:

- **Internet:** Visit the Paradyne World Wide Web site at www.paradyne.com. (Be sure to register your warranty at www.paradyne.com/warranty.)
- **Telephone:** Call our automated system to receive current information by fax or to speak with a company representative.
 - Within the U.S.A., call 1-800-870-2221
 - Outside the U.S.A., call 1-727-530-2340

Document Feedback

We welcome your comments and suggestions about this document. Please mail them to Technical Publications, Paradyne Corporation, 8545 126th Ave. N., Largo, FL 33773, or send e-mail to userdoc@paradyne.com. Include the number and title of this document in your correspondence. Please include your name and phone number if you are willing to provide additional clarification.

Trademarks

ACCULINK, COMSPHERE, FrameSaver, Hotwire, MVL, NextEDGE, OpenLane, and Performance Wizard are registered trademarks of Paradyne Corporation. ReachDSL and TruePut are trademarks of Paradyne Corporation. All other products and services mentioned herein are the trademarks, service marks, registered trademarks, or registered service marks of their respective owners.

Regulatory and Safety Information

Refer to the appropriate Digital Subscriber Line Access Multiplexer (DSLAM) manual for all regulatory notices and safety information.

Contents

About This Guide

- Document Purpose and Intended Audience v
- New Features for this Release v
- Document Summary v
- Product-Related Documents vi

1 About Hotwire 8777 and 8779 TDM SDSL Units

- TDM SDSL Overview 1-1
- TDM SDSL Features 1-2
- Network Configuration 1-3
- SNMP Management Capabilities 1-4
 - Management Information Base (MIB) Support 1-4
 - SNMP Trap Support 1-4

2 Using the Asynchronous Terminal Interface

- User Interface Access 2-1
- Management Serial Port Settings 2-1
- Logging In to the Hotwire DSLAM 2-2
- Initiating an ATI Session 2-2
- Menu Hierarchy 2-4
- Screen Work Areas 2-5
- Navigating the Screens 2-6
 - Keyboard Keys 2-6
 - Function Keys 2-7
 - Switching Between Screen Work Areas 2-8
- Ending an ATI Session 2-9
- Exiting From the DSLAM Session 2-9

3 Initial Startup and Configuration

- Overview 3-1
- Entering Identity Information 3-2
- Configuring the Unit 3-3
 - Configuration Options 3-3

- Accessing and Displaying Configuration Options 3-4
 - Current and Default Factory Configurations 3-5
 - Configuration Loader 3-7
- Saving Configuration Options 3-9
- Restoring Access to the User Interface 3-10
- Resetting the Device 3-10
- Disabling AutoRate 3-11
- Resetting AutoRate 3-11
- Downloading Firmware 3-12

4 Cross-Connecting Ports

- Overview 4-1
- Determining the Configuration 4-2
- Setting the Cross-Connect Modes 4-4
- Assigning Time Slots 4-5

5 IP Addressing

- Selecting an IP Addressing Scheme 5-1
 - Configurations Not Running IP Conservative Software 5-1
 - All Configurations 5-2
- IP Addressing Example 5-2

6 Security

- Overview 6-1
- ATI Access Levels 6-2
- Creating a Login 6-3
- Deleting a Login 6-4
- Controlling SNMP Access 6-5
 - Assigning SNMP Community Names and Access Types 6-5
 - Limiting SNMP Access through the IP Addresses of the Managers 6-5

7 Monitoring and Troubleshooting

- What to Monitor 7-1
- Viewing System and Test Status 7-2
 - Health and Status Messages 7-3
 - Self-Test Results Messages 7-7
 - Test Status Messages 7-9
- Device Messages 7-10

■ Performance Statistics	7-11
Viewing Network Error Statistics	7-12
Viewing Network Performance Statistics	7-13
Viewing DSX-1 Performance Statistics	7-15
Viewing G.703 Performance Statistics	7-17
Viewing Current Network Performance Statistics	7-19
Viewing Inband Management Statistics	7-20
■ Viewing LED Status	7-22
■ Front Panel LEDs	7-24
■ Changing the Meaning of the PORTS LEDs	7-25
■ Troubleshooting	7-25

8 Testing

■ Accessing the Test Menu	8-1
■ Running Network Tests	8-2
Network Line Loopback	8-4
Repeater Loopback	8-5
DTE Loopback	8-6
Remote Send Line Loopback	8-7
Send and Monitor 511	8-8
■ Device Tests	8-9
Lamp Test	8-9
■ Ending an Active Test	8-10
■ Telco-Initiated Tests	8-11
Telco-Initiated Line Loopback	8-11
Telco-Initiated Payload Loopback	8-11
Telco-Initiated Remote Line Loopback	8-12

9 Transferring Firmware and Configurations Using TFTP

■ Downloading Firmware	9-1
■ Configuration Loader	9-4

A Configuration Options

■ Overview	A-1
■ Network Interface Options Menu	A-2
■ DSX-1 Interface Options (Model 8777)	A-7
■ G.703 Interface Options (Model 8779)	A-9
■ Copy Ports Options	A-12
■ System Options	A-13

- System Clock A-15
- Cross-Connect A-19
 - Setting Cross-Connect Mode. A-20
 - Assigning Time Slots A-24
- Management and Communication Options Menu A-28
 - Telnet Session Options A-28
 - General SNMP Management Options A-30
 - SNMP NMS Security Options A-32
 - SNMP Traps Options. A-34
 - Inband Management Channel (Model 8779) A-37
 - Configuring and Testing Inband Management. A-39

B Standards Compliance for SNMP Traps

- SNMP Traps. B-1
- ifIndex. B-1
- warmStart. B-2
- authenticationFailure B-2
- linkUp and linkDown. B-2
- Enterprise-Specific Traps. B-4

C Connector Pin Assignments

- Overview C-1
- Front Panel 50-pin DTE Connector Pinouts. C-1
- 8610/8620 and 8810/8820 DSLAM Telco 50-pin Connector Pinouts C-3

D Technical Specifications

E Cross-Connection Worksheets

- Using the Worksheets E-1
- Port Connection Diagram. E-2
- DSX-1 Time Slot Assignments. E-3
- G.703 Time Slot Assignments E-11

Index

About This Guide

Document Purpose and Intended Audience

This guide contains information needed to set up, configure, and operate Hotwire 8777 and 8779 Time Division Multiplexer Symmetric Digital Subscriber Line (TDM SDSL) Termination Units, and is intended for installers and operators.

New Features for this Release

This version of the *Hotwire TDM SDSL Termination Units, Models 8777 and 8779, User's Guide* adds the inband management feature for the Model 8779 Termination Unit.

Document Summary

Section	Description
Chapter 1, About Hotwire 8777 and 8779 TDM SDSL Units	Describes the Hotwire Termination Unit's features and capabilities.
Chapter 2, Using the Asynchronous Terminal Interface	Provides instructions for accessing the user interface and navigating the screens.
Chapter 3, Initial Startup and Configuration	Provides procedures for setting up the user interface and configuring the unit.
Chapter 4, Cross-Connecting Ports	Provides instructions for cross-connecting the time slots of the DSL and DTE ports.
Chapter 5, IP Addressing	Provides IP addressing requirements and examples.
Chapter 6, Security	Presents procedures for creating a login, setting the effective access levels, and controlling SNMP access.
Chapter 7, Monitoring and Troubleshooting	Describes using the LEDs, status messages, and network statistics to monitor the unit and diagnose problems.
Chapter 8, Testing	Provides instructions for running network, DSX-1, and G.703 tests.

Section	Description
Chapter 9, <i>Transferring Firmware and Configurations Using TFTP</i>	Shows how to upload and download firmware and configuration files.
Appendix A, <i>Configuration Options</i>	Contains all configuration options, default settings, and possible settings.
Appendix B, <i>Standards Compliance for SNMP Traps</i>	Contains SNMP trap compliance information.
Appendix C, <i>Connector Pin Assignments</i>	Lists the pin assignments for the front panel DTE connector.
Appendix D, <i>Technical Specifications</i>	Contains physical and regulatory specifications, network and port interfaces, power consumption values, and accessory part numbers.
Appendix E, <i>Cross-Connection Worksheets</i>	Contains worksheets to help plan and configure cross-connection of DTE and DSL ports.
Index	Lists key terms, acronyms, concepts, and sections in alphabetical order.

A master glossary of terms and acronyms used in Paradyne documents is available on the World Wide Web at www.paradyne.com. Select *Library* → *Technical Manuals* → [Technical Glossary](#).

Product-Related Documents

Complete documentation for this product is available on the World Wide Web at www.paradyne.com. Select *Library* → *Technical Manuals* → [Hotwire DSL Systems](#).

Document Number	Document Title
7900-A2-GB21	<i>Hotwire TDM SDSL Standalone Termination Units, Models 7974-A2, 7975-A2, and 7976-A2, User's Guide</i>
8000-A2-GB22	<i>Hotwire Management Communications Controller (MCC) Card, IP Conservative, User's Guide</i>
8000-A2-GB29	<i>Hotwire Management Communications Controller (MCC) Card User's Guide</i>
8610-A2-GN20	<i>Hotwire 8610 DSLAM Installation Guide</i>
8620-A2-GN20	<i>Hotwire 8620 GrandSLAM Installation Guide</i>
8810-A2-GN20	<i>Hotwire 8810 DSLAM Installation Guide</i>
8820-A2-GN20	<i>Hotwire 8820 GrandSLAM Installation Guide</i>

To order a paper copy of a Paradyne document:

- Within the U.S.A., call 1-800-PARADYNE (1-800-727-2396)
- Outside the U.S.A., call 1-727-530-8623

About Hotwire 8777 and 8779 TDM SDSL Units

1

TDM SDSL Overview

Hotwire® Time Division Multiplexer Symmetric Digital Subscriber Line (TDM SDSL) products maximize customer service areas by varying the DSL line rate. This ensures symmetric DSL connectivity over a wide range of telephone line distances and transmission line qualities. Hotwire 2-wire TDM SDSL products transmit data over 14,000 feet (4.6 km) at rates up to 2.048 Mbps.

Hotwire products support autorate. Units first synchronize to the highest line rate that the 2-wire loop supports, then automatically configures the unit to the highest multiple of 64 Kbps supported by that line rate. Eight line rates are available. At all rates, an 8 Kbps management channel is available, which enables functions such as firmware downloads to remote units. Units can also be configured manually to full or fractional T1 or E1 rates.

TDM SDSL Features

The 2-wire Hotwire 8777 or 8779 TDM SDSL Termination Unit is a circuit board that is mounted in a Hotwire 8610 or 8810 Digital Subscriber Line Access Multiplexer (DSLAM), or an 8620 or 8820 GrandSLAM, and used to transport signals at high speeds over a twisted-pair connection.

Model . . .	Has eight . . .	And eight . . .
8777	TDM SDSL ports	DSX-1 ports
8779	TDM SDSL ports	G.703 ports

Hotwire 8777 and 8779 TDM SDSL Termination Units have these standard features:

- **Cross-Connection Capability.** Any DSL port and time slot can be connected to any DTE port and time slot.
- **Embedded Operations Channel (EOC).** Provides remote management via SNMP or Telnet session capability over the DSL network. The bandwidth of the EOC is a 4 Kbps dedicated channel for the Model 8777 and 8 Kbps for the Model 8779.
- **Asynchronous Terminal Interface (ATI).** Provides a menu-driven VT100-compatible terminal interface for configuring and managing the unit locally or remotely by Telnet session.
- **Local Management.** Provides local management using the DSLAM management card with a:
 - Terminal or PC via the Management Serial port of the DSLAM
 - Network Management System (NMS) via the Management MCC port of the DSLAM through the port card's 10BaseT port
- **Remote Management.** Provides remote management:
 - Out-of-band, using an external modem through the Management Serial port of the DSLAM
 - Inband using one of the DS0 channels as the management channel to transport SNMP traffic to the MCC card (Model 8779 only).
 - Via Telnet over the EOC
- **Alarm Indication.** Activates front panel LEDs.
- **Diagnostics.** Provides the capability to diagnose device and network problems and perform tests, including digital loopbacks, pattern tests, and self-test.
- **Device and Test Monitoring.** Provides the capability of tracking and evaluating the unit's operation, including health and status, and error-rate monitoring.

Network Configuration

Figure 1-1, [Sample CO-to-CP Configuration](#), shows a T1 network application using a Hotwire 8777 or 8779 Termination Unit for access concentration in a central office (CO). A frame relay switch and a router are connected to partner units through the termination unit, supporting a host or router and frame relay encapsulated data.

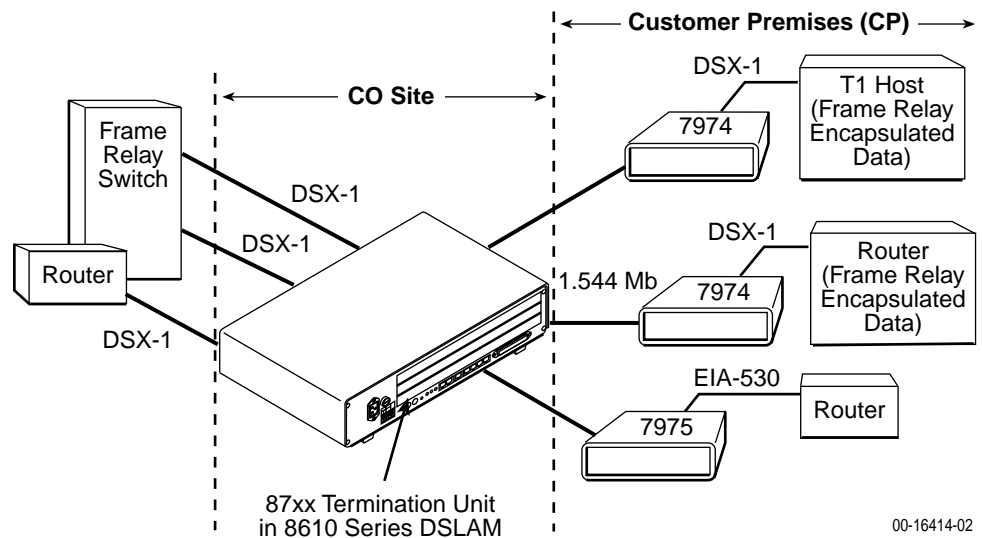

Figure 1-1. Sample CO-to-CP Configuration

SNMP Management Capabilities

The termination unit supports SNMP Version 1, and can be managed by any industry-standard SNMP manager and accessed using SNMP by external SNMP managers.

Management Information Base (MIB) Support

For a detailed description of supported MIBs, visit Paradyne's Web site at www.paradyne.com. The following MIBs are supported:

- **MIB II (RFC 1213 and RFC 2863 (was 1573))** – Defines the general objects for use with a network management protocol in TCP/IP internets and provides general information about the unit. MIB II is backward-compatible with MIB I.
- **DS1/E1 MIB (RFC 2495 (was 1406))** – Reports the performance status of the DSX-1 or G.703 interface and supports the features found on the DSX-1 or G.703 Performance Statistics screen.
- **Entity MIB (RFC 2037)** – Supports all DSLAM cards.
- **Enterprise MIBs** – Supports configuration, status, statistics, and tests.

SNMP Trap Support

The Hotwire 8777 or 8779 TDM SDSL Termination Unit supports SNMP traps as shown in [Appendix B, Standards Compliance for SNMP Traps](#).

Using the Asynchronous Terminal Interface

2

User Interface Access

You can communicate with the asynchronous terminal interface (ATI) using one of the following methods:

- Direct connection through the Management Serial port of the DSLAM (locally or via an external modem).
- Telnet session using a Network Management System (NMS) connected to a LAN/WAN port on the DSLAM.
- Telnet session through the Embedded Operations Channel (EOC).

NOTE:

Only one asynchronous terminal interface session can be active at a time, and another user's session cannot be forced to end. To automatically log out a user due to inactivity, enable the Inactivity Timeout option (see [Table A-12, Telnet Session Options](#), in Appendix A, *Configuration Options*).

Security can limit ATI access in several ways. To set up security or a login ID, refer to [Chapter 6, Security](#).

Management Serial Port Settings

Ensure that the device you connect communicates using these settings:

- Data rate set to 9.6 Kbps.
- Character length set to 8.
- Parity set to None.
- Stop Bits set to 1.

Refer to the installation document for your DSLAM. See [Product-Related Documents](#) in *About This Guide*.

Logging In to the Hotwire DSLAM

You can log in to the Hotwire DSLAM system using either a local VT100-compatible terminal or a remote Telnet connection.

After you enter your user ID and password, the system displays the Hotwire Chassis Main Menu. See your management card documentation for information about selecting the unit from the card selection screen.

Initiating an ATI Session

The Main Menu screen is displayed unless a login ID and password is required or the ATI is already in use.

If security is enabled on the termination unit and Telnet is used to access the unit directly (you did not log in through the MCC), the system prompts you for a login ID and password.

```
Login
Slot: 4                                     Model: 87xx

                                LOGIN

      Login ID:      _____
Enter Password:    _____

-----
Ctrl-a to access these functions                Exit
```

If you enter an invalid login ID and password three times, the Telnet session closes or the terminal connection returns to an idle state. Refer to [Chapter 6, Security](#).

If the ATI is already in use, the message **connection refused** is sent to a terminal attempting Telnet access.

After you enter a valid login ID and password, the Main Menu appears.

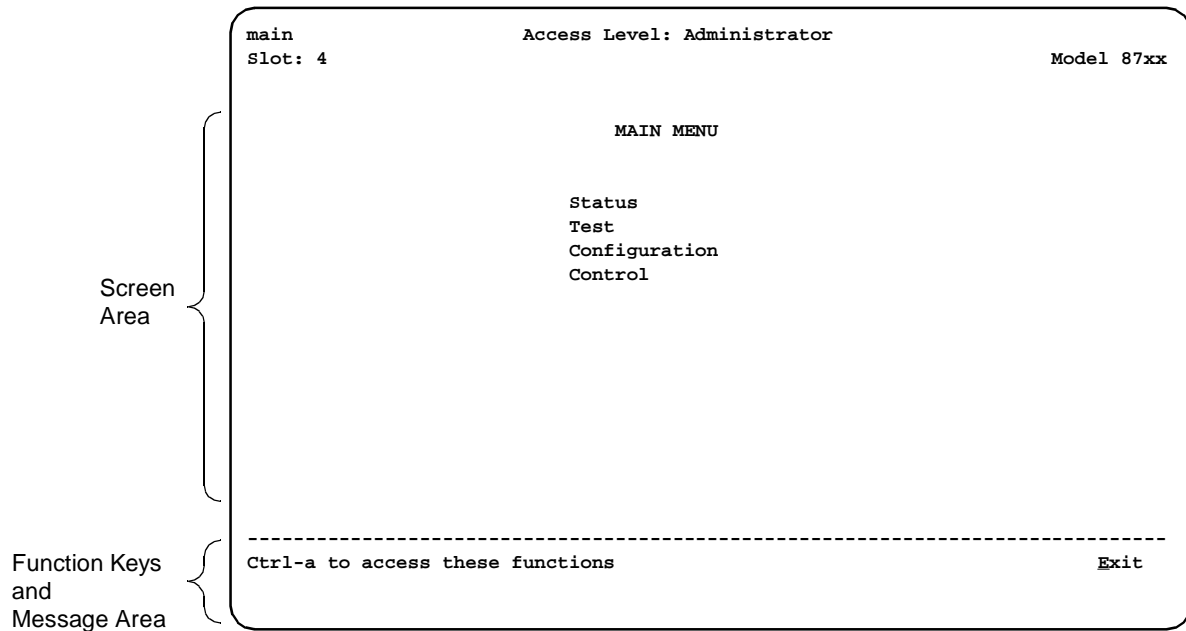

Entry to all of the termination unit's tasks begins at the Main Menu screen.

Select ...	To ...
Status	View system status, diagnostic test results, statistics, LED, and device identity information.
Test	Select, start, stop and cancel tests for the unit's interfaces.
Configuration	Display and edit the configuration options and download configuration files.
Control	Change the device identity, administer logins, download new firmware, or initiate a power-up reset of the unit.

What appears on the screens depends on the:

- **Current configuration** – How your unit is currently configured.
- **Effective security access level** – An access level that is typically set by the system administrator for each interface and each user.
- **Data selection criteria** – What you entered in previous screens.

Menu Hierarchy

The following illustration shows the paths to the various ATI screens.

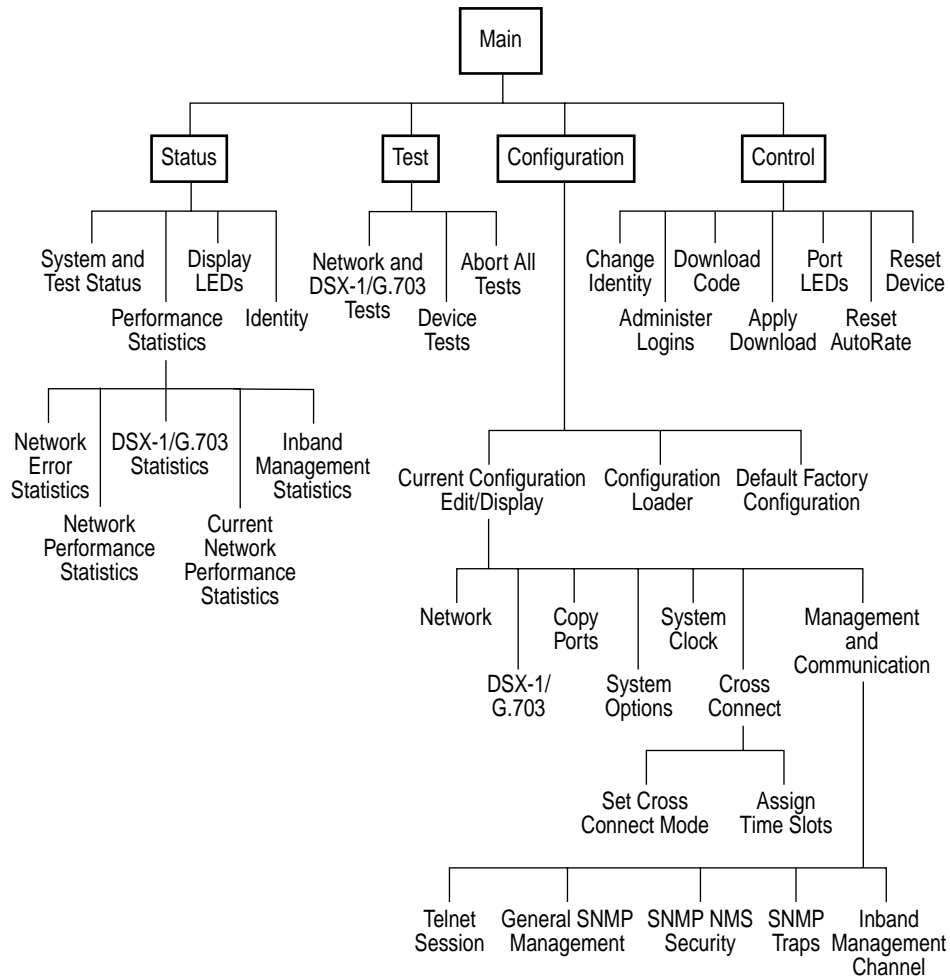

02-16607-03

Screen Work Areas

There are two user work areas:

- **Screen area** – This is the area above the dotted line that provides the menu path, menus, and input fields.

The menu path appears as the first line on the screen. In this manual, the menu path is presented as a menu selection sequence:

Main Menu → Configuration → Current Configuration → Network

- **Function keys and message area** – This is the area below the dotted line that lists function keys specific to the screen, field value choices, and system messages (displays the highest level alarm from the Health and Status screen).

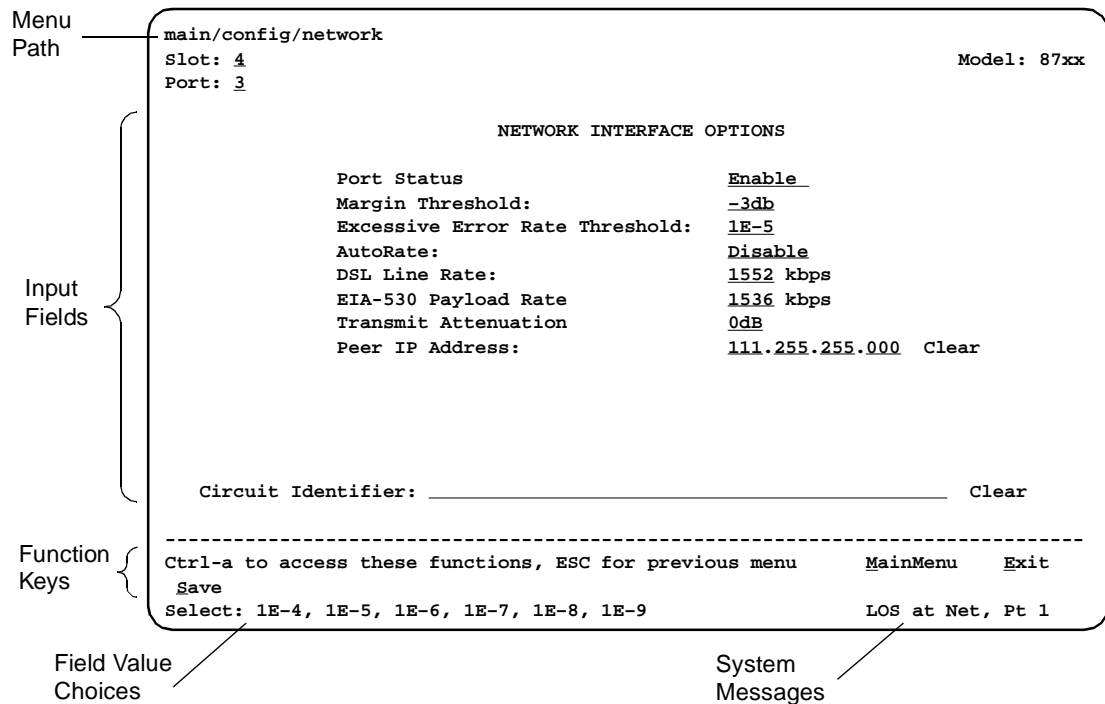

Navigating the Screens

You can navigate the screens by:

- Using keyboard keys
- Using function keys
- Switching between the two screen areas

Keyboard Keys

Use the following keyboard keys to navigate within the screen.

Press . . .	To . . .
Ctrl-a	Move cursor between the screen area and the function keys and messages area below the dotted line at the bottom of the screen.
Esc	Return to the previous screen.
Tab	Move cursor to the next field on the screen.
Backspace	Move cursor to the previous field on the screen.
Enter	Accept entry or display valid options on the last row of the screen when pressed before entering data or after entering invalid data.
Ctrl-k	Tab backwards (move cursor one field to the left).
Spacebar	Select the next valid value for the field.
Delete (Del)	Delete character that the cursor is on.
Up Arrow or Ctrl-u	Move cursor up one field within a column on the same screen.
Down Arrow or Ctrl-d	Move cursor down one field within a column on the same screen.
Right Arrow or Ctrl-f	Move cursor one character to the right if in edit mode.
Left Arrow or Ctrl-b	Move cursor one character to the left if in edit mode.
Ctrl-l	Redraw the screen display, clearing information typed in but not yet entered.

► Procedure

To make a menu or field selection:

1. Press the Tab or Down Arrow key to position the cursor on a menu or field selection. Each selection is highlighted as you press the key to move the cursor from position to position.
2. Press Enter. The selected menu or screen appears.
3. Continue Steps 1 and 2 until you reach the screen you want.

The current setting or value appears to the right of the field name. You can enter information into a selected field by:

- Typing in the first letter(s) of a field value or command.
- Switching from the screen area to the function key and message area below the dotted line, and selecting or entering the designated function key.

If a field is blank and the Field Value Choices display valid selections, press the spacebar; the first valid value for the field will appear in the field. Continue pressing the spacebar to scroll through other valid values. Press Enter to select the value.

Function Keys

All function keys located below the dotted line operate the same way (upper- or lowercase) throughout the screens.

For the screen function . . .	Select . . .	And press Enter to . . .
Clr <u>F</u> ar	F or f	Clear far-end network statistics and refresh the screen.
Clr <u>N</u> ear	N or n	Clear near-end network statistics and refresh the screen.
De <u>L</u> ete	L or l	Delete data.
<u>E</u> xit	E or e	Terminate the asynchronous terminal session.
<u>M</u> ainMenu	M or m	Return to the Main Menu screen.
<u>N</u> ew	N or n	Enter new data.
Pg <u>D</u> n	D or d	Display the next page, or group of entries.
Pg <u>U</u> p	U or u	Display the previous page, or group of entries.
<u>R</u> esetMon	R or r	Reset an active Monitor 511 test counter to zero.
<u>S</u> ave	S or s	Save information.

Switching Between Screen Work Areas

Select Ctrl-a to switch between the two screen work areas to perform all screen functions.

► Procedure

To access the function key and message area below the dotted line:

1. Press Ctrl-a to switch from the screen area to the function key and message area below the dotted line.
2. Select either the function's designated (underlined) character or press the Tab key until you reach the desired function key.

Example:

To save the current options, type **s** or **S** (Save).

3. Press Enter. The function is performed.
4. To return to the screen area above the dotted line, press Ctrl-a again.

```
main/config/network
Slot: 4
Port: 2
Model: 87xx

NETWORK INTERFACE OPTIONS

Margin Threshold:      -3db
Excessive Error Rate Threshold:  1E-5
AutoRate:              Disable
DSL Line Rate:         1552

Circuit Identifier:_____ Clear

-----
Ctrl-a to access these functions, ESC for previous menu      MainMenu  Exit
Save
```

Ending an ATI Session

Use the Exit function key from any screen to terminate the session.

► Procedure

To end a session with the asynchronous terminal interface:

1. Press Ctrl-a to go to the function keys below the dotted line.
2. Save changes if required. A confirmation message appears if you have made but not saved changes to your configuration.
3. Tab to Exit (or type **e** or **E**) and press Enter. If you have accessed the unit through the management card, the Hotwire Chassis Card Selection menu appears.

Exiting From the DSLAM Session

You can manually log out of the system or, after five minutes of inactivity, the system will automatically log you out.

► Procedure

To manually exit from the Hotwire DSLAM system:

1. Return to the Hotwire Chassis Main Menu by selecting Exit from either the Hotwire – MCC menu or the Hotwire – DSL menu.

The Hotwire Card Selection menu appears.

2. Press Ctrl-z.

The Hotwire Chassis Main Menu appears.

3. From the Hotwire Chassis Main Menu, select Logout.

The system exits from the current login session on the Hotwire DSLAM.

Initial Startup and Configuration

3

Overview

This chapter provides instructions on how to access and configure your Hotwire TDM SDSL Termination Unit for the first time, display configuration options, disable or reset the AutoRate feature, and download firmware. These procedures include:

- [Entering Identity Information](#) on page 3-2
- [Configuring the Unit](#) on page 3-3
- [Accessing and Displaying Configuration Options](#) on page 3-4
 - [Configuration Options](#)
 - [Current and Default Factory Configurations](#)
 - [Configuration Loader](#)
- [Saving Configuration Options](#) on page 3-9
- [Restoring Access to the User Interface](#) on page 3-10
- [Resetting the Device](#) on page 3-10
- [Disabling AutoRate](#) on page 3-11
- [Resetting AutoRate](#) on page 3-11
- [Downloading Firmware](#) on page 3-12

Entering Identity Information

After accessing your unit for the first time, use the Change Identity screen to determine SNMP administrative system information that will be displayed on the Identity screen of the Status branch. To access the Card Identity screen, follow this menu selection sequence:

Main Menu → *Control* → *Change Identity*

```

main/control/change_identity
Slot: 4                                     Model: 87xx

                                IDENTITY

System Name:      Prez 111QJ98-001_____ Clear
System Location:  Bldg. A412, 2nd Floor, Left cabinet_____ Clear
System Contact:   L. Young 800-727-2396 pager 888-555-1212 Clear

-----
Ctrl-a to access these functions, ESC for previous menu   MainMenu  Exit
Save

```

The three System entry fields are alphanumeric and provide up to 128 characters per field. These SNMP System entry fields are:

- **System Name:** The general SNMP system name.
- **System Location:** The physical location of the SNMP-managed device.
- **System Contact:** Identification information, such as contact name, phone number, or mailing address.

Valid entry values are any printable ASCII character. ASCII printable characters include:

- Numeric 0–9
- Upper- or lowercase A–Z
- Space
- All ASCII symbols except the caret (^)

Select Clear to reset a field to a null value.

► Procedure

To enter Change Identity screen information:

1. Position the cursor in the System Name field. Enter a name unique in your network to identify the SNMP managed node (or unit)
2. Position the cursor in the System Location field. Enter the physical location of the unit.
3. Position the cursor in the System Contact field. Enter the name and contact information for the person responsible for the unit.
4. Press Ctrl-a to switch to the function key and message area below the dotted line.
5. Select Save and press Enter. **Command Complete** appears.

Configuring the Unit

Configuration option settings determine how the termination unit operates. Use the Configuration branch menu to display or change configuration option settings.

Configuration Options

The termination unit is shipped with factory settings in the Default Factory Configuration area. You can find default information by:

- Referring to [Appendix A, Configuration Options](#).
- Accessing the Configuration branch of the termination unit's menu.

The termination unit has two sets of configuration option settings.

Configuration Option Area	Configuration Option Set
Current Configuration	The unit's currently active set of configuration options.
Default Factory Configuration	A read-only configuration area containing the factory default configuration options.

The Current Configuration matches the Default Factory Configuration until modified and saved by the user. If the factory default settings do not support your network's configuration, you can customize the configuration options for your application.

Accessing and Displaying Configuration Options

To display configuration options, you must first load a configuration into the edit area.

To load a configuration option set into the configuration edit area, follow this menu selection sequence:

Main Menu → *Configuration (Load Configuration From)*

```

main/configuration
Slot: 4
Model: 87xx

LOAD CONFIGURATION FROM:

Current Configuration
Configuration Loader
Default Factory Configuration

-----
Ctrl-a to access these functions, ESC for previous menu      MainMenu  Exit

```

Make a selection by placing the cursor at your choice and pressing Enter.

If you select ...	Then ...
Current Configuration	The selected configuration option set is loaded and the Configuration Edit/Display menu screen appears.
Configuration Loader	The Configuration Loader screen is displayed allowing you to upload or download configurations from a TFTP server or the MCP Flash File System (FFS).
Default Factory Configuration	The factory-set configuration option set is loaded and the Configuration Edit/Display menu screen appears.

Current and Default Factory Configurations

The Configuration Edit/Display screen appears when the current or default configuration is loaded. To access the Configuration Edit/Display screen, follow this menu selection sequence:

Main Menu→*Configuration*→*Current Configuration*

– or –

Main Menu→*Configuration*→*Default Factory Configuration*

```
main/config/edit                                     Model: 87xx
Slot: 4

                                CONFIGURATION EDIT/DISPLAY

                                Network
                                DSX-1 | G.703
                                Copy Ports
                                System Options
                                System Clock
                                Cross-Connect
                                Management and Communication

-----
Ctrl-a to access these functions, ESC for previous menu      MainMenu  Exit
Save
```

In the menu selection sequences contained in this manual, Current Configuration is assumed and shown.

See [Appendix A, Configuration Options](#), for a list and explanation of the configuration options available

Select . . .	To Access the . . .	To Configure the . . .
Network	Network Interface Options (Table A-1)	DSL interface ports.
DSX-1	DSX-1 Interface Options – Model 8777 (Table A-4)	DSX-1 interface ports (Model 8777).
G.703	G.703 Interface Options – Model 8779 (Table A-5)	G.703 interface ports (Model 8779).
Copy Ports	Copy Port Options (Table A-6)	DSL network and DTE interface ports by copying options from port to port.
System Options	System Options (Table A-7)	General system options of the unit.
System Clock	System Clock Options (Table A-8)	LTU system clock options.
Cross-Connect	<ul style="list-style-type: none"> ■ Cross-Connect Mode Options – Model 8779 (Table A-10) ■ Assign Time Slots Options (Table A-11) 	DS1 and DS0 cross-connect ports.
Management and Communication	<ul style="list-style-type: none"> ■ Telnet Session Options (Table A-12) ■ General SNMP Management Options (Table A-13) ■ SNMP NMS Security Options (Table A-14) ■ SNMP Traps Options (Table A-15) ■ Inband Management Channel Options – Model 8779 (Table A-16) 	Management support of the unit through SNMP, Telnet and the Inband Management Channel.

Configuration Loader

The Configuration Loader screen allows you to upload configurations to and download configurations from a TFTP server or the MCP FFS. To access the Configuration Loader screen, follow this menu selection sequence:

Main Menu → *Configuration* → *Configuration Loader*

```

main/configuration/config_loader                                     Model: 87xx

                                CONFIGURATION LOADER

Configuration File Name: _____ Clear
TFTP Server IP Address:  IP 000.000.000.000 Clear
TFTP Transfer Direction: Download from Server
Destination:             DSL

Start Transfer:          Yes

Packets Sent:           0000000
Packets Received:       0000000
Bytes Sent:              0000000
Bytes Received:         0000000
Transfer Status:        Transfer Pending

Activate new configuration? No

-----
Ctrl-a to access these functions, ESC for previous menu      MainMenu  Exit

```

► Procedure

To upload or download a configuration:

1. Position the cursor in the Image File Name field. Type the name of the file to be downloaded, or the name to be used for the file to be uploaded.

The filename may be a regular path name expression of directory names separated by a forward slash (/) ending with the filename. The total path name length can be up to 128 characters.

- **DOS machine:** If the TFTP server is hosted by a DOS machine, then directory and filenames must consist of eight or less characters with an optional suffix of up to three characters. The system will automatically upload the configuration file and create directories and filenames, as needed.
- **UNIX machine:** If your server is hosted by a UNIX machine, the configuration file you name must already exist. It will not be created on the UNIX system by the TFTP server. It is critical that you work with your system administrator to plan the naming conventions for directories, filenames, and permissions so that anyone using the system has read and write permissions.
- **MCP FFS:** When uploading configuration files to the MCP FFS, the directory and filename must be entered, otherwise the download will fail.

2. Position the cursor in the TFTP Server IP Address field. Enter the TFTP server IP address or **M1** for the MCP FFS.

The first three digits of the IP address cannot be 000 or greater than 223.

3. Position the cursor in the TFTP Transfer Direction field. Use the spacebar to select Download from Server or Upload to Server.
4. For a Line Termination Unit (LTU), go to [Step 5](#). For a Network Termination Unit (NTU), position the cursor in the Destination field. Use the spacebar to select a network destination for the TFTP server. Select DSL if the TFTP server destination is the DSL link port or IMC (Internal Management Channel) if the TFTP destination is the Management port of the MCC.
5. Position the cursor at the Start Transfer field. Use the spacebar to select Yes. Press Enter.

When the data transfer is complete, the Transfer Status field changes to **Completed successfully**.

6. Position the cursor at the **Activate new configuration?** prompt and select Yes to activate a new downloaded configuration. Press Enter.

NOTE:

Configuration options DSL Mode and Telnet Session are **not** changed when a new configuration is loaded. You must change these settings with the appropriate configuration menus after the new configuration is activated. See [Table A-7, System Options](#), and [Table A-10, Cross-Connect Mode Options – Model 8779](#), in Appendix A, *Configuration Options*.

Saving Configuration Options

When changes are made to the configuration options through the Configuration Edit/Display branch, the changes must be saved to take effect. Use the Save key or Save Configuration screen.

► Procedure

To save configuration options changes:

1. Press Ctrl-a to switch to the function key and message area.
2. Select Save and press Enter.

NOTE:

When Exit is selected before Save, or Save has been selected from any menu in the Configuration/Edit branch, a Save Configuration screen appears requiring a Yes or No response.

```

main/config/saveprompt
Slot: 4
Model: 87xx

SAVE CONFIGURATION

Save Changes? No_

WARNING:

An answer of "yes" will cause the system
to reset as if it had been powered off and on!

-----
Ctrl-a to access these functions, ESC for previous menu      MainMenu  Exit
Command Complete

```

If the Telnet Session configuration option is changed, a message displays on the Save Configuration screen warning that an answer of Yes will cause the Telnet session to disconnect. Do not answer Yes unless you are prepared to disconnect.

If the DSL Mode configuration option is changed, the Save Configuration screen bears the warning that an answer of Yes will cause the system to reset. Do not answer Yes unless you are prepared to reset the unit.

If you select . . .	Then . . .
Yes	The configuration is saved.
No	The Main Menu appears and changes are not saved.

Restoring Access to the User Interface

Improper configuration of the unit could render the user interface inaccessible. If this occurs, access can be restored using the management card of the DSLAM.

► Procedure

To reset the DSL Card using the DSLAM's management card:

1. Follow this menu selection sequence:

Configuration → DSL Cards → Reset Slot

2. Enter **DSLnn**, where *nn* is the slot number for the DSL card you wish to reset.
3. Enter **Reset**.
4. Enter **Y** if you want to clear NVRAM also, otherwise enter **N**.
5. Enter **Y** at the prompt to confirm.

NOTE:

When you enter **Y**, all data connectivity is interrupted.

Resetting the Device

If the user interface is functional and you would like to reset the card without removing the card from the DSLAM, follow this procedure.

► Procedure

To reset the card using the Control branch:

1. Follow this menu selection sequence:

Main Menu → Control → Reset Device

2. The message **Are you sure?** appears.
3. Enter **Yes**.

Disabling AutoRate

The AutoRate function is controlled from the Network Interface Options screen and allows you to enable or disable the AutoRate feature. The AutoRate option is only available if the unit is configured as an LTU.

To access the Network Interface screen, follow this menu selection sequence:

Main Menu → *Configuration* → *Current Configuration* → *Network*

```

main/config/network
Slot: 4
Port: 1
Model: 87xx

NETWORK INTERFACE OPTIONS

Margin Threshold:      -3db
Excessive Error Rate Threshold:  1E-5
AutoRate              Enable
Max DSL AutoRate      144

-----
Ctrl-a to access these functions, ESC for previous menu   MainMenu  Exit
Save

```

The AutoRate option defaults to Enable.

► Procedure

To disable AutoRate:

1. Position the cursor in the AutoRate field and press the spacebar.
The AutoRate field toggles to Disable and the DSL Line Rate field appears.
2. Enter a DSL Line Rate and press Enter.

Resetting AutoRate

The Reset AutoRate function of the Control branch causes the unit to repeat the AutoRate sequence. The unit attempts to establish the DSL link at the highest rate (or the value of DSL Line Rate, which represents the AutoRate ceiling when AutoRate is enabled). If the link fails, the next lower rate is tried until the link is established.

To access the Reset AutoRate screen, follow this menu selection sequence:

Main Menu → *Control* → *Reset AutoRate*

Downloading Firmware

The Download Code screen allows you to download firmware from a TFTP server or MCP FFS. To access the Download Code screen, follow this menu selection sequence:

Main Menu → Control → Download Code

```

main/control/download_code
Slot: 4                                     Model: 87xx
Port: 1

                                DOWNLOAD CODE

Image File Name: _____ Clear
TFTP Server IP Address: IP 000.000.000.000 Clear
Destination: DSL
Immediately Apply Download: Yes
Start Transfer: No_

Packets Sent: 0000000
Packets Received: 0000000
Bytes Sent: 0000000
Bytes Received: 0000000
Transfer Status: Transfer Pending

-----
Ctrl-a to access these functions, ESC for previous menu      MainMenu  Exit

```

► Procedure

To download firmware:

1. Position the cursor in the Image File Name field. Type the name of the file to be downloaded.

The file name may be a regular path name expression of directory names separated by a forward slash (/) ending with the file name. The total path name length can be up to 128 characters.

2. Position the cursor in the TFTP Server IP Address field. Enter the TFTP server IP address or **M1** for the MCP FFS.
3. For an LTU, go to [Step 4](#). For an NTU, position the cursor in the Destination field. Use the spacebar to select a network destination for the TFTP server. Select one of the following:
 - DSL if the TFTP server destination is the EOC.
 - IMC if the TFTP destination is via the MCP.
4. Position the cursor in the Immediately Apply Download field. If you would like the download to be effective immediately, select **Yes**.

5. Position the cursor at the Start Transfer field. Use the spacebar to select Yes. Press Enter.

When the data transfer is complete:

- If you selected Yes in Step 4, the unit is reset.
- If you selected No in Step 4, the Transfer Status field changes to **Completed successfully**.

If you specified **No** (the default) in the Immediately Apply Download field in Step 4 above, you must now apply the download.

```

main/control/apply_download
Slot: 4                                     Model: 87xx
Port: 1

                APPLY DOWNLOAD

                Switch To Code Revision A01.00.02: No_

                WARNING:
                An answer of "yes" will cause the system
                to reset as if it had been powered off and on!

-----
Ctrl-a to access these functions, ESC for previous menu      MainMenu  Exit
Select: Yes, No                                             LOS at Net, Pt 1

```

► Procedure

To apply the downloaded firmware:

1. Press the Escape key to return to the Control menu. Select Apply Download.
2. On the Apply Download screen, type **Yes** to reset the card and activate the code.

Selecting Yes causes the termination unit to reset.

NOTE:

The termination unit has two flash memory banks to hold executable firmware. You can switch between these two firmware versions by applying the firmware listed on the Apply Download screen.

Cross-Connecting Ports

4

Overview

Configuration of the cross-connections consists of the following steps:

- Determine how the ports will be connected and configured.
- On the Network Interface Options screen, enable the DSL ports that will be in the cross-connection if necessary. The ports are enabled by default.
- On the DSX-1 or G.703 Interface Options screen, enable the DSX-1 or G.703 ports that will be in the cross-connection.

For G.703, specify whether Time Slot 16 is used for signaling (voice mode).

- On the System Clock screen, configure the system clock.
- On the Cross-Connect Mode screen:
 - Define all DS1 Bypass ports.
 - Define all DS1 Cross-Connect ports.
 - Define all DS0 Cross-Connect ports.
- On the Assign Time Slots screen, configure the DS0 cross-connections.

This chapter describes the use of the Cross-Connect Mode and Assign Time Slots screens. See [Appendix A, Configuration Options](#), for information about configuration options presented on the other screens.

Examples in this chapter show screens for DSX-1 models. The principles of cross-connection are the same for G.703 models.

IMPORTANT:

All DSL time slots are available for cross-connect regardless of DSL line rate, but all time slots are available for data transport only if the DSL line rate is the full rate (1552 for DSX-1 or 2064 for G.703). Configure only the time slots intended for use.

Determining the Configuration

The Hotwire cross-connect system allows you to connect the DSX-1 or G.703 ports to the DSL ports in a variety of ways:

- **DS1 Bypass mode** – The entire DSX-1 or G.703 interface is connected to the DSL interface.
- **DS1 Cross-Connect mode (8777)** – The entire DSX-1 interface is connected to the DSL interface through cross-connect circuitry. Ports can be switched through software.
- **DS1 Cross-Connect mode (8779)** – The entire G.703 interface can be connected to any DSL or G.703 interface. The entire DSL interface can be connected to any DSL or G.703 interface through cross-connect circuitry. Ports can be switched through software.
- **DS0 Cross-Connect mode (8777)** – Any time slot of any DSX-1 interface can be connected to any time slot of any DSL interface. Time slots can be individually allocated for voice or data.
- **DS0 Cross-Connect mode (8779)** – Any time slot of any DSL interface can be connected to any time slot of any G.703 or DSL interface. Any time slot of any G.703 interface can be connected to any time slot of any G.703 or DSL interface. Time slots can be individually allocated for voice or data.

The example below shows a DS0 cross-connection between DSX-1 Ports 1 and 2. DSX-1 Port 1 is dedicated to voice and Port 2 to data.

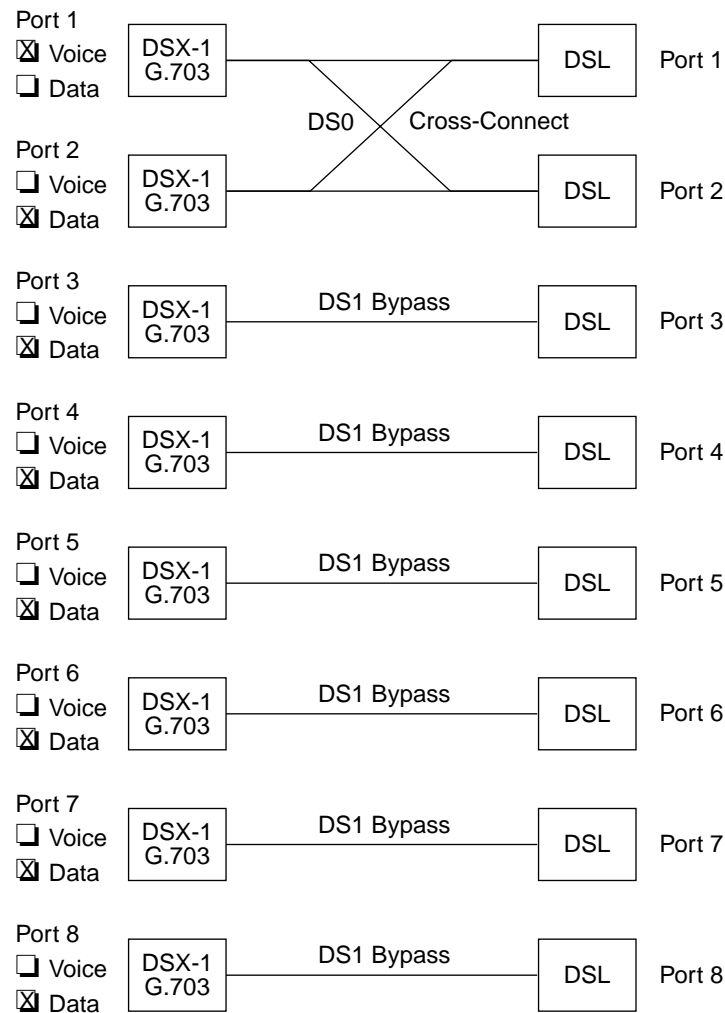

99-16603

NOTES:

- Although the example shows ports dedicated to voice or data, a port can be configured for both voice and data.
- For G.703 ports using Common Channel Signaling (CCS) that are in DS0 Cross-Connect mode, you must explicitly configure the cross-connections for Time Slot 16 and related time slots.

You may find it useful to diagram your configuration. [Appendix E, Cross-Connection Worksheets](#), contains a skeleton diagram for this purpose. It also contains worksheets for documenting your time slot cross-connections before you begin to configure them.

Setting the Cross-Connect Modes

To access the Set Cross-Connect Mode screen, follow this menu selection sequence:

Main Menu → *Configuration* → *Current Configuration* → *Cross-Connect* → *Set Cross-Connect Mode*

When the screen is first displayed, all ports are set to DS1 Bypass mode. In this example, Ports 1 and 2 have been changed to **DS0 Cross-connect**, and Ports 3–8 have been changed to **DS1 Bypass**. **Unassigned** appears next to Ports 1 and 2 because time slots associated with the cross-connection have not yet been assigned.

```

main/config/xconnect_mode
Slot: 18                                     Model: 8777

                                CROSS-CONNECT MODE

DSX-1 Port      MODE                DSL Port
      1      DS0 Cross-connect    Unassigned
      2      DS0 Cross-connect    Unassigned
      3      DS1 Bypass           3
      4      DS1 Bypass           4
      5      DS1 Bypass           5
      6      DS1 Bypass           6
      7      DS1 Bypass           7
      8      DS1 Bypass           8

                                Assign_DS0s

-----
Ctrl-a to access these functions, ESC for previous menu      MainMenu  Exit
Save                                                         Clear_All

```

Assigning Time Slots

You may find it helpful to map your cross-connection assignments on a worksheet before configuring them in the unit. In the following example, the worksheet for DSX-1 Port 1, odd-numbered time slots from DSL Ports 1 and 2 are assigned to the time slots of DSX-1 Port 1 and configured for voice.

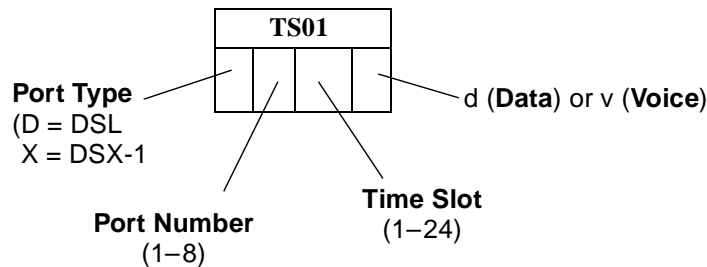

TS01				TS02				TS03				TS04				TS05				TS06				TS07			
D	1	1	v	D	2	1	v	D	1	3	v	D	2	3	v	D	1	5	v	D	2	5	v	D	1	7	v
TS08				TS09				TS10				TS11				TS12				TS13				TS14			
D	2	7	v	D	1	9	v	D	2	9	v	D	1	11	v	D	2	11	v	D	1	13	v	D	2	13	v
TS15				TS16				TS17				TS18				TS19				TS20				TS21			
D	1	15	v	D	2	15	v	D	1	17	v	D	2	17	v	D	1	19	v	D	2	19	v	D	1	21	v
TS22				TS23				TS24																			
D	2	21	v	D	1	23	v	D	2	23	v																

DSX-1 Port 2 is configured for data and is connected to the even-numbered time slots of DSL Ports 1 and 2:

TS01				TS02				TS03				TS04				TS05				TS06				TS07			
D	1	2	d	D	2	2	d	D	1	4	d	D	2	4	d	D	1	6	d	D	2	6	d	D	1	8	d
TS08				TS09				TS10				TS11				TS12				TS13				TS14			
D	2	8	d	D	1	10	d	D	2	10	d	D	1	12	d	D	2	12	d	D	1	14	d	D	2	14	d
TS15				TS16				TS17				TS18				TS19				TS20				TS21			
D	1	16	d	D	2	16	d	D	1	18	d	D	2	18	d	D	1	20	d	D	2	20	d	D	1	22	d
TS22				TS23				TS24																			
D	2	22	d	D	1	24	d	D	2	24	d																

To access the Assign Time Slots screen, follow this menu selection sequence:

Main Menu→*Configuration*→*Current Configuration*→*Cross-Connect*→*Assign Time Slots*

When the screen is first displayed, port and time slot assignments are blank. The following example shows the configuration for DSX-1 Port 1, transferred from the worksheet.

```

main/config/cross_connect/timeslot
Slot: 18
Model: 8777
          ASSIGN TIME SLOTS
DSX-1 Port: 1      DS0s to Allocate:      Start TS:      Assign To: D

  TS01      TS02      TS03      TS04      TS05      TS06      TS07
D 1 01 y   D 2 01 y   D 1 03 y   D 2 03 y   D 1 05 y   D 2 05 y   D 1 07 y

  TS08      TS09      TS10      TS11      TS12      TS13      TS14
D 2 07 y   D 1 09 y   D 2 09 y   D 1 11 y   D 2 11 y   D 1 13 y   D 2 13 y

  TS15      TS16      TS17      TS18      TS19      TS20      TS21
D 1 15 y   D 2 15 y   D 1 17 y   D 2 17 y   D 1 19 y   D 2 19 y   D 1 21 y

  TS22      TS23      TS24
D 2 21 y   D 1 23 y   D 2 23 y

Key:      D = DSL, X = DSX-1, I = IBMC
          d = data, v = voice
-----
Ctrl-a to access these functions, ESC for previous menu      MainMenu      Exit
Save                                                         Clear_All

```

The following example shows the configuration for DSX-1 Port 2.

```

main/config/cross_connect/timeslot
slot: 18
Model: 8777
          ASSIGN TIME SLOTS
DSX-1 Port: 2      DS0s to Allocate:      Start TS:      Assign To: D

  TS01      TS02      TS03      TS04      TS05      TS06      TS07
D 1 02 d   D 2 02 d   D 1 04 d   D 2 04 d   D 1 06 d   D 2 06 d   D 1 08 d

  TS08      TS09      TS10      TS11      TS12      TS13      TS14
D 2 08 d   D 1 10 d   D 2 10 d   D 1 12 d   D 2 12 d   D 1 14 d   D 2 14 d

  TS15      TS16      TS17      TS18      TS19      TS20      TS21
D 1 16 d   D 2 16 d   D 1 18 d   D 2 18 d   D 1 20 d   D 2 20 d   D 1 22 d

  TS22      TS23      TS24
D 2 22 d   D 1 24 d   D 2 24 d

Key:      D = DSL, X = DSX-1, I = IBMC
          d = data, v = voice
-----
Ctrl-a to access these functions, ESC for previous menu      MainMenu      Exit
Save                                                         Clear_All

```

When the Cross-Connect Mode screen is displayed now, 1,2 appears next to DSX-1 Ports 1 and 2 because time slots associated with the cross-connection have been assigned.

```
main/config/xconnect_mode
slot: 18                                     Model: 8777

                                CROSS-CONNECT MODE

    DSX-1 Port      MODE          DSL Port
    1      DS0 Cross-connect  1,2
    2      DS0 Cross-connect  1,2
    3      DS1 Bypass         3
    4      DS1 Bypass         4
    5      DS1 Bypass         5
    6      DS1 Bypass         6
    7      DS1 Bypass         7
    8      DS1 Bypass         8

                                Assign_DS0s

-----
Ctrl-a to access these functions, ESC for previous menu   MainMenu  Exit
Save                                                         Clear_All
```

Selecting an IP Addressing Scheme

Your IP addressing scheme depends in part whether the management card controlling the chassis is running IP Conservative software.

Configurations Not Running IP Conservative Software

In a configuration not running IP Conservative software, the NTU's network interface IP address is assigned through the peer IP address of the LTU's Network Interface menu.

The termination unit is assigned an IP address and subnet through the DSLAM's *Configuration* → *DSL Cards* → *Set IP Address* menu. Once the address is assigned, you can use the ATI to assign:

- Peer IP addresses to the DSL ports. These addresses are used as the IP addresses of the remote units, and must be in the same subnet as the DSLAM management card. See [Table A-1, Network Interface Options](#), in Appendix A, *Configuration Options*.
- An IP address for each NMS to act as a trap manager. See [Table A-15, SNMP Traps Options](#), in Appendix A, *Configuration Options*.

All Configurations

The NTU obtains its IP address when the PPP link is established over the EOC.

Use the ATI to assign:

- An IP address for each NMS. See [Table A-14, SNMP NMS Security Options](#), in Appendix A, *Configuration Options*.
- An IP address for the TFTP server you wish to use to upload and download configurations. See [Configuration Loader](#) in Chapter 9, *Transferring Firmware and Configurations Using TFTP*, and the documentation for your TFTP server.

Review the following information in preparation for selecting an IP addressing scheme.

- Any legal host address is allowed for a given subnet. The address choice within the subnet is arbitrary.
- A single route to a subnet is all that is needed to reach every device on a subnet. The unit's routing table supports a maximum of 20 routes.

IP Addressing Example

[Figure 5-1, Peer IP Address Assignments](#), shows IP addressing in a typical network. Note that the Peer IP Address:

- Refers to the IP address of the unit configured as an NTU.
- Is assigned by the LTU.

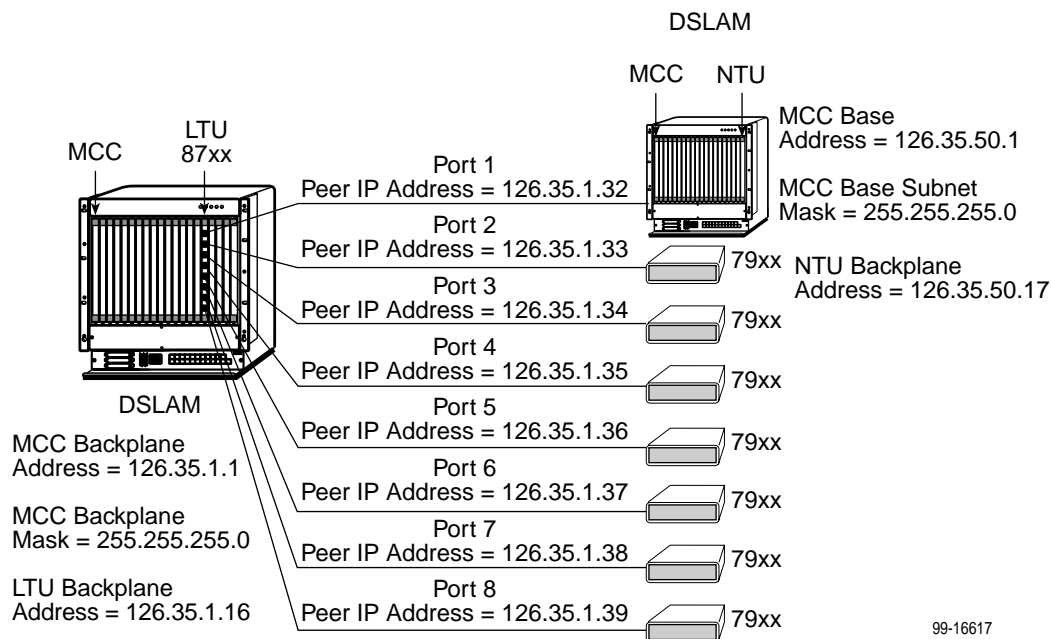

99-16617

Figure 5-1. Peer IP Address Assignments

Overview

The Hotwire Termination Unit in IP Complex mode provides several methods of limiting user access to the ATI through option settings. You can:

- Enable the Telnet Login Required option.
- Limit the access by setting a Session Access Level option of Operator for the Telnet Session.
- Disable the access with the Telnet Session option.

See [Table A-12, Telnet Session Options](#), in Appendix A, *Configuration Options*.

For information on configuring user accounts in IP Conservative mode, see the [Hotwire Management Communications Controller \(MCC\) Card, IP Conservative, User's Guide](#).

ATI Access Levels

The Hotwire Termination Unit has two access levels: Administrator and Operator. The access level determines what functions are accessible, as shown in [Table 6-1, Access Levels](#).

Table 6-1. Access Levels

ATI Access to Menu Functions	Administrator	Operator
Status	Read-Only	Read-Only
Test	Full Access	No Access
Configuration	Full Access	Read-Only
Control	Full Access	No Access

Access levels can be applied to Login IDs and Telnet sessions. When access is through Telnet and a login is required for Telnet, the effective access level is the more restrictive of the Telnet session access level or the login access level. (See [Table A-12, Telnet Session Options](#), in Appendix A, *Configuration Options*.)

When an access level of Operator is applied to Telnet sessions, a Login ID with Administrator authority is effectively reduced to Operator. It is no longer possible to change configuration options, and full access can be restored only by reloading factory defaults. (See [Restoring Access to the User Interface](#) in Chapter 3, *Initial Startup and Configuration*.)

Creating a Login

Logins apply to Telnet access directly to the ATI of the Hotwire Termination Unit. The Administer Logins menu option is not presented when you access the unit through the management card of the DSLAM and when in IP Conservative mode.

Six login ID/password combinations are available. Each Login ID and Password must be unique and include an access level.

► Procedure

1. To create a login record, follow this menu selection sequence:

Main Menu→Control→Administer Logins

```

main/control/admin_logins
Slot: 4                                     Model: 87xx

                                ADMINISTER LOGINS                                Page 1 of 1

Login ID:          newuser
Access Level:      Administrator

                                Are You Sure? Yes

-----
Save  PgUp  PgDn                ESC for previous menu      MainMenu  Exit
                                New                          Delete

```

2. Select New and press Enter. The Login Entry screen is displayed.

```

main/control/admin_logins
Slot: 4                                     Model: 87xx

                                LOGIN ENTRY

Login ID:          newuser_____
Password:          e34t136_____
Re-enter Password: e34t136_____
Access Level:      Administrator

                                WARNING
New logins will not become permanent until saved
through the "ADMINISTER LOGINS" screen!

-----
Ctrl-a to access these functions  ESC for previous menu      MainMenu  Exit
Save  PgUp  PgDn                New                          Delete

```

3. Create the login by entering the following fields. Login IDs and passwords are case-sensitive.

On the Login Entry screen, for the . . .	Enter . . .
Login ID	1 to 10 ASCII printable characters (hex21 through 7E). Blanks are not allowed.
Password	1 to 10 ASCII printable characters that can consist of 0–9, a–z, A–Z, # (pound), . (period), – (dash), and / (slash).
Re-enter Password	1 to 10 ASCII printable characters that can consist of 0–9, a–z, A–Z, # (pound), . (period), – (dash), and / (slash).
Access Level	Administrator, Operator

NOTE:

Assign at least one Administrator-level Login ID. Full access is necessary to make configuration option changes and administer logins.

4. Press Ctrl-a to switch to the function keys area below the dotted line. Select Save and press Enter.
5. Press Ctrl-a to switch to the screen function key area below the dotted line. Select Save and press Enter.
6. When Save is complete, **Command Complete** appears at the bottom of the screen.
7. If additional logins are required, repeat Steps 3 through 5.
8. When all logins are entered, press Esc to return to the Administer Logins screen.
9. Select Save and press Enter.

Deleting a Login

► **Procedure**

1. To delete a login record, follow this menu selection sequence:

Main Menu→*Control*→*Administer Logins*

2. Select PgUp or PgDn and press Enter to page through login pages/records until you find the one to be deleted.
3. Once the correct record is displayed, select Delete and press Enter.
4. To complete the delete action, select Save and press Enter.

When the deletion is complete, **Command Complete** appears at the bottom of the screen. The number of login pages/records reflects one less record, and the record following the deleted record appears.

Controlling SNMP Access

There are three methods for limiting SNMP access.

- Disable the SNMP management option. Refer to [Table A-13, General SNMP Management Options](#), in Appendix A, *Configuration Options*.
- Assign SNMP community names and access types.
- Limit SNMP access through validation of the IP address of each allowed SNMP manager.

Assigning SNMP Community Names and Access Types

The unit can be managed by an SNMP manager supporting SNMP. The community name must be supplied by an external SNMP manager accessing an object in the MIB.

To define SNMP community names, follow this menu selection sequence:

Main Menu → *Configuration* → *Current Configuration* →
Management and Communication → *General SNMP Management*

Refer to [Table A-13, General SNMP Management Options](#), in Appendix A, *Configuration Options*, to:

- Enable SNMP Management.
- Assign the SNMP community names of the SNMP Managers that are allowed to access the unit's Management Information Base (MIB).
- Specify Read or Read/Write access for each SNMP community name.

Limiting SNMP Access through the IP Addresses of the Managers

The unit provides an additional level of security through validation of the IP addresses.

The SNMP Management option must be enabled. To control SNMP access with IP addresses, follow this menu selection sequence:

Main Menu → *Configuration* → *Current Configuration* →
Management and Communication → *SNMP NMS Security*

Refer to [Table A-14, SNMP NMS Security Options](#), in Appendix A, *Configuration Options*. The SNMP access can be limited by:

- Enabling NMS IP address checking.
- Add each IP address and access level.

NOTE:

Do not change or delete the IP address or access level of the NMS performing the sets or enable IP address checking prior to adding the NMS to the table.

Monitoring and Troubleshooting

7

What to Monitor

This chapter presents information on how to monitor termination unit status, assess performance, and diagnose problems as described in the following sections:

- [Viewing System and Test Status](#) on page 7-2
 - [Health and Status Messages](#)
 - [Self-Test Results Messages](#)
 - [Test Status Messages](#)
- [Device Messages](#) on page 7-10
- [Performance Statistics](#) on page 7-11
 - [Viewing Network Error Statistics](#)
 - [Viewing Network Performance Statistics](#)
 - [Viewing DSX-1 Performance Statistics](#)
 - [Viewing DSX-1 Performance Statistics](#)
 - [Viewing G.703 Performance Statistics](#)
- [Viewing LED Status](#) on page 7-22
- [Front Panel LEDs](#) on page 7-24
- [Changing the Meaning of the PORTS LEDs](#) on page 7-25
- [Troubleshooting](#) on page 7-25

Viewing System and Test Status

To view System and Test Status information, follow this menu selection sequence:

Main Menu → *Status* → *System and Test Status*

```

main/status/system
slot: 2
Model: 87xx

SYSTEM AND TEST STATUS
Page 1 of 1

HEALTH AND STATUS          SELF-TEST RESULTS          TEST STATUS
-----
LOS at Net, Pt n           CPU Failed                 No Test Active
OOF at Net, Pt n           Device Failed              LLB Test Active, Pt n
EER at Net, Pt n           Net DSL Failed, Pt n      RLB Test Active, Pt n
LOS at DSX-1 Pt n          DSX-1 Pt Failed, Pt n    Lamp Test Active
Net Margin Threshold, Pt n Memory Failed              DLB Test Active, Pt n
Device Failed yyyyyyyy     Passed
Download Failed

-----
ESC for previous menu      MainMenu  Exit

```

The System and Test Status screen has three sections:

- **Health and Status** – Displays messages in priority order (highest to lowest). Refer to [Table 7-1, Health and Status Messages](#).
- **Self-Test Results** – Results of the Diagnostic test run on the device itself. Refer to [Table 7-2, Self-Test Results Messages](#).
- **Test Status** – Currently active tests. Refer to [Table 7-3, Test Status Messages](#).

Health and Status Messages

The following messages appear in the first column of the System and Test Status screen. The highest priority Health and Status message also appears on all ATI screens on the bottom right.

Table 7-1. Health and Status Messages (1 of 4)

Message	What Message Indicates	What To Do
AIS at DSX-1, Pt <i>n</i>	An AIS (Alarm Indication Signal) is being received by the DSX-1 interface.	A fault exists in the network connected to the DSX-1 port. Contact network provider.
AIS at G.703, Pt <i>n</i>	An AIS is being received by the G.703 interface.	A fault exists in the network connected to the G.703 port. Contact network provider.
Device Failed <i>yyyyyyyy</i>	An internal error has been detected by the operating software. <i>yyyyyyyy</i> indicates the 8-digit hexadecimal failure code.	<ol style="list-style-type: none"> 1. Provide the 8-digit failure code shown (<i>yyyyyyyy</i>) to your service representative. 2. Reset the unit to clear the condition and message.
Download Failed	A firmware download was interrupted.	Ensure that the file exists on the TFTP server. Repeat the download.
EER at DSX-1, Pt <i>n</i>	An Excessive Error Rate (EER) condition has been detected on the DSX-1 interface.	<ol style="list-style-type: none"> 1. Verify the attached equipment coding is compatible. 2. Verify the clock configuration. 3. Contact network provider.
EER at G.703, Pt <i>n</i>	An EER condition has been detected on the G.703 interface.	<ol style="list-style-type: none"> 1. Verify that the network cable is securely attached at both ends. 2. Verify the attached equipment coding is compatible. 3. Verify the G.703 line termination is configured correctly. 4. Contact network provider.
EER at Net, Pt <i>n</i>	An EER condition has been detected on the network interface at Port <i>n</i> . The condition is cleared when the error rate falls below the threshold value currently configured.	<ol style="list-style-type: none"> 1. Check the Network Performance Statistics screen for possible line impairments. 2. Set the unit to run at a lower DSL line rate.
Fallback Rate, Pt <i>n</i>	The LTU, set to AutoRate enable, synchronized at a lower rate when the line was restored after an LOS.	Reset AutoRate, or run at a fixed rate.

Table 7-1. Health and Status Messages (2 of 4)

Message	What Message Indicates	What To Do
IBMC Not Supported on MCP	The Inband Management Channel (IBMC) is enabled, but the MCP card does not support Inband Management.	<ol style="list-style-type: none"> 1. Disable the Inband Management Channel. 2. Download the MCP with a version of code that supports inband management.
IP Mismatch, Pt <i>n</i>	The NTU and the LTU are operating in different NMS management modes: one is in IP Conservative mode and one is not.	In a DSLAM-to-DSLAM configuration, use the same software in the management cards of both DSLAMs.
LOF at DSX-1, Pt <i>n</i>	An LOF (Loss Of Frame) condition has been detected on the DSX-1 interface. LOF is declared when an OOF state exists longer than 2.5 seconds.	<ol style="list-style-type: none"> 1. Verify that the network cable is securely attached at both ends. 2. Verify the unit's line framing and line coding are compatible with the attached equipment. 3. Contact network provider.
LOF at G.703, Pt <i>n</i>	An LOF condition has been detected on the G.703 interface. LOF is declared when any three consecutive frame synchronization bits are incorrect, frames not containing the frame alignment signal are received with an error three times consecutively, or, for CRC-4 framing, CRC multiframe bit alignment fails.	<ol style="list-style-type: none"> 1. Verify that the network cable is securely attached at both ends. 2. Verify that the units line framing and line coding are compatible with the attached equipment. 3. Contact network provider.
LOS at DSX-1, Pt <i>n</i>	An LOS (Loss Of Signal) condition has been detected on the DSX-1 interface. No signal is being received on Port <i>n</i> . LOS is declared when 175 consecutive zeros are received.	<ol style="list-style-type: none"> 1. Verify that the network cable is securely attached at both ends. 2. Contact network provider to troubleshoot the line.
LOS at G.703, Pt <i>n</i>	An LOS condition has been detected on the G.703 interface. No signal is being received on Port <i>n</i> . LOS is declared when 175 consecutive pulse transmissions are received with no pulse transitions.	<ol style="list-style-type: none"> 1. Verify that the network cable is securely attached at both ends. 2. Contact network provider to troubleshoot the line.

Table 7-1. Health and Status Messages (3 of 4)

Message	What Message Indicates	What To Do
LOS at Net, Pt <i>n</i>	An LOS (Loss Of Signal) condition has been detected on the network interface. No signal is being received on Port <i>n</i> , possibly due to a local network problem.	<ol style="list-style-type: none"> 1. Verify that the network cable is securely attached at both ends. 2. Verify proper NTU and LTU configuration. 3. Contact network provider to troubleshoot the line.
Mismatch Rate, Pt <i>n</i>	The LTU, set to a fixed DSL rate, is attempting to operate at a rate the NTU is not capable of.	Set the LTU to a compatible rate or replace the NTU.
Net Margin Threshold, Pt <i>n</i>	The signal-to-noise margin has dropped below the configured threshold.	<ol style="list-style-type: none"> 1. Check the Network Performance Statistics screen for possible line impairments. 2. Set the unit to run at a lower DSL line rate. 3. Reconfigure the margin threshold (if appropriate). 4. Contact network provider to troubleshoot the line.
NTU/LTU Mismatch, Pt <i>n</i>	The NTU is not compatible with the LTU.	Contact network provider.
NTU TS16 Not Supported	The LTU is configured for TS16 signaling and the NTU is not configured to support TS16 signaling.	<ol style="list-style-type: none"> 1. Verify endpoint is a G.703 product. EIA-530-A products do not support signaling. 2. Replace endpoint or reconfigure TS16 to data.
OOF at Net, P <i>n</i>	An Out Of Frame (OOF) condition has been detected. An OOF condition is declared when 2 out of 4 frame synchronization bits are in error.	<ol style="list-style-type: none"> 1. Check the Transmit Clock on the unit and attached equipment. 2. Set the unit to run at a lower DSL line rate. 3. Contact network provider.
Payload Rate Mismatch Pt <i>n</i>	The endpoint device is an EIA-530-A model that does not support the configured EIA-530-A payload rate.	Reconfigure the EIA-530 Payload Rate configuration option to an acceptable rate. See Network Interface Options Menu in Appendix A, Configuration Options for acceptable rates.

Table 7-1. Health and Status Messages (4 of 4)

Message	What Message Indicates	What To Do
Primary Clock Failed, Pt <i>n</i>	A failure has occurred in the primary clock source for the DSX-1 or G.703 port.	<ol style="list-style-type: none"> 1. Verify that the network cable is securely attached at both ends. 2. Verify the clock configuration on the unit and attached equipment. 3. Contact network provider.
Primary System Clock Failed	A failure has occurred in the clock common to all cross-connect circuitry.	Contact your service representative.
RAI at G.703, Pt <i>n</i>	An RAI (Remote Alarm Indication) signal is being received by the G.703 interface.	<ol style="list-style-type: none"> 1. Check the status of the attached device. 2. Verify that the Line Coding, Line Framing, and Time Slot 16 configuration options selected are compatible with the connected G.703 equipment's configurations. See G.703 Interface Options (Model 8779) in Appendix A, <i>Configuration Options</i>.
Secondary System Clock Failed	A failure has occurred in the fallback clock for the system clock.	Contact your service representative.
System Operational	There are no problems detected.	No action is needed.
Yellow Alarm at DSX-1, Pt <i>n</i>	A Yellow Alarm Indication signal is being received by the DSX-1 interface.	<ol style="list-style-type: none"> 1. Verify that the unit's line framing and line coding are compatible. 2. Contact network provider.

Self-Test Results Messages

The results of the last power-on or reset self-test appear in the middle column of the System and Test Status screen.

Table 7-2. Self-Test Results Messages (1 of 2)

Message	What Message Indicates	What To Do
CPU Fail	The Central Processing Unit failed internal testing.	1. Reset the unit and try again. 2. Call your service representative for assistance.
CPU CPLD Fail	The Complex Programmable Logic Device serving the Central Processing Unit failed.	
Data Path Fail, Pt <i>n</i>	The port shown failed to loop data on the full data path test.	
DeviceFailed	One or more of the unit's integrated circuits has failed device-level testing.	
DSL Framer <i>x</i> Fail	The DSL framer for Ports 1–4 (Framer A) or 5–8 (Framer B) failed.	
DSL xcvr Fail, Pt <i>n</i>	The DSL transceiver failed on Port <i>n</i> .	
DSX-1 Failed, Pt <i>n</i>	The unit failed to internally loop data on the DSX-1 Port <i>n</i> .	
DTE Framer <i>x</i> Fail	The DTE framer for Ports 1–4 (Framer A) or 5–8 (Framer B) failed.	
DTE LIU <i>x</i> Fail	The DTE Line Interface Unit for Ports 1–2 (LIU A), 3–4 (LIU B), 5–6 (LIU C), or 7–8 (LIU D) failed.	
EEPROM Fail	The unit failed Electrically Erasable Programmable Read-Only Memory verification.	
Failure xxxxxxxx	An internal failure occurred. (xxxxxxx represents an 8-digit hexadecimal failure code for use by service personnel.)	Record the failure code and contact your service representative.

Table 7-2. Self-Test Results Messages (2 of 2)

Message	What Message Indicates	What To Do
FPGA Failed	The Field Programmable Gate Array serving all ports failed.	<ol style="list-style-type: none"> 1. Reset the unit and try again. 2. Call your service representative for assistance.
G.703 Failed, Pt 1	The unit failed to loop data on the G.703 on Port <i>n</i> .	
Memory Test <i>n</i> Fail	The unit failed memory data verification (Test 1) or memory address verification (Test 2).	
Passed	No errors were detected.	No action is needed.
PLD Failed, Pt <i>n</i>	An error was detected in a Programmable Logic Device.	<ol style="list-style-type: none"> 1. Reset the unit and try again. 2. Call your service representative for assistance.
TSI CPLD Fail	The Complex Programmable Logic Device serving the Timeslot Interchanger failed.	
TSI Fail	The Timeslot Interchanger failed.	

Test Status Messages

The Test Status messages in the following table appear in the right column of the System and Test Status screen.

Table 7-3. Test Status Messages

Test Status Message	Meaning
511 Test Active, Pt <i>n</i>	A 511 Test and Monitor is active on the DSL Port <i>n</i> network interface.
DLB Test Active, Pt <i>n</i>	A Data Terminal Loopback test is active on Port <i>n</i> .
Lamp Test Active	The Lamp Test is active, causing the LEDs on the front panel to light.
LLB Test Active, Pt <i>n</i>	A network Line Loopback test is active on Port <i>n</i> .
No Test Active	No tests are currently running.
Remote LLB Dn Active, Pt <i>n</i>	A Remote Line Loopback Down command is being sent.
Remote LLB Up Active, Pt <i>n</i>	A Remote Line Loopback Up command is being sent.
RLB Test Active, Pt <i>n</i>	A network Repeater Loopback test is active on Port <i>n</i> .
Telco LLB Active, Pt <i>n</i>	A Telco-initiated Line Loopback is active on the specified DSX-1 port.
Telco PLB Active, Pt <i>n</i>	A Telco-initiated Payload Loopback is active on the specified DSX-1 port.

For further information on testing, refer to [Chapter 8, Testing](#).

Device Messages

The Device Messages in [Table 7-4](#), listed in alphabetical order, may appear in the messages area at the bottom of the ATI screens.

Table 7-4. Device Messages (1 of 2)

Device Message	What Message Indicates	What To Do
0.0.0.0 is an invalid IP address	An IP address of all zeros was entered.	Enter a valid, non-zero IP address.
Access level is Operator. Configuration is read-only.	The operator requested that configuration options be loaded, but does not have authority to edit them.	If configuration options are to be edited, use a Login ID that has Administrator authority.
Cannot Save – no Login IDs with Access Administrator	All of the login IDs being saved have an access level below Administrator.	Change the access level of at least one Login ID to Administrator so that configuration changes can be made. (Operator-level users cannot make configuration changes.) Save the Login IDs.
Command Complete	Action requested has successfully completed.	No action is needed.
Invalid Character (x)	A nonprintable ASCII character (x) has been entered.	Re-enter information using valid characters.
Invalid Password	Login is required and an incorrect password was entered; access is denied.	<ul style="list-style-type: none"> ■ Try again. ■ Contact your system administrator to verify your password.
Invalid – Send Pattern Already Active	A pattern test was already in progress when the Start field was selected.	<ul style="list-style-type: none"> ■ Allow test to continue. ■ Select another test. ■ Stop the test.
Invalid – [Test] Already Active	The described test was already in progress when another selection was made.	<ul style="list-style-type: none"> ■ Allow test to continue. ■ Select another test. ■ Stop the test.
Invalid Test Combination	A loopback or pattern test was in progress when Start was selected to start another test, or was active on the same or another interface when Start was selected.	<ul style="list-style-type: none"> ■ Wait until other test ends and message clears. ■ Abort all tests from the Test menu screen. ■ Stop the test from the same screen the test was started from.
IP address not in MCC subnet <i>nnn.nnn.nnn.nnn</i>	The Peer IP address specified is not in the same subnet as the MCC.	Enter an IP address that is in the same subnet as the MCC.

Table 7-4. Device Messages (2 of 2)

Device Message	What Message Indicates	What To Do
Limit of six Login IDs reached	An attempt to enter a new login ID was made, and the limit of six login/password combinations has been reached.	<ol style="list-style-type: none"> 1. Delete another login/password combination. 2. Re-enter the new login ID.
No Security Records to Delete	Delete was selected from the Administer Login screen, and no security records had been defined.	<ul style="list-style-type: none"> ■ No action is needed. ■ Enter a security record.
Password Matching Error – Re-enter Password	Password entered in the Re-enter Password field of the Administer Logins screen does not match what was entered in the Password field.	<ul style="list-style-type: none"> ■ Try again. ■ Contact your system administrator to verify your password.
Please Wait	Command takes longer than 5 seconds.	Wait until message clears.
Test Active	A test is running and no higher priority health and status messages exist.	<ul style="list-style-type: none"> ■ Contact service provider if test initiated by the network. ■ Wait until the other test ends and message clears. ■ Cancel all tests from the Test screen. ■ Stop the test from the same screen the test was started from.

Performance Statistics

Performance statistics can assist you in determining the duration of specific conditions and provide a historical context for problem detection and analysis. Statistics are maintained for up to 96 15-minute intervals (24 hours).

Select a port to view the performance statistics. Port 1 is the default.

Use the applicable virtual function keys to page through the intervals and clear statistics.

- Select PgUp or PgDn to view more statistics.
- Select ClrNear or ClrFar to clear the near- and far-end statistics to zero.
- For DSX-1 and G.703 statistics, select ClrStats to clear all statistics to zero.

Viewing Network Error Statistics

The terminal unit maintains error statistics on the network DSL interface for each port.

To view Network Error Statistics, follow this menu selection sequence:

Main Menu → *Status* → *Performance Statistics* → *Network Error Statistics*

```

main/status/performance/net_error
Slot: 4:                                     Model: 87xx
Port: 2                                     NETWORK ERROR STATISTICS

Current Interval Timer: 002                 Error Events Counter: 0034
-----
      ---ES---      ---SES---      --FEBE--      -Complete-
        Near Far        Near Far        Near Far        Near Far
Current Int: 000 000        000 000        000 000        Yes No
Interval 01 000 000        000 000        000 000        Yes Yes
Interval 02 000 000        000 000        000 000        Yes Yes
Interval 03 000 000        000 000        000 000        Yes Yes
Interval 04 000 000        000 000        000 000        Yes Yes
Interval 05 000 000        000 000        000 000        Yes Yes
Interval 06 000 000        000 000        000 000        Yes Yes
Interval 07 000 000        000 000        000 000        Yes Yes

Worst Interval: 24 09          14 08          18 18
Near Tot(valid): 00010        00000        00000
Far Tot (valid): 00010        00000        00000
-----
Ctrl-a to access these functions, ESC for previous menu      MainMenu  Exit
PgUp   PgDn   ClrNear  ClrFar

```

The following Network Error Statistics are collected for the selected port:

- **ES (Errored Seconds):** Seconds during which one or more Cyclical Redundancy Check (CRC) error events occurred. Maximum value is 900.
- **SES (Severely Errored Seconds):** Seconds during which more than 320 or more CRC error events occurred. Maximum value is 900.
- **FEBE (Far-End Block Errors):** Errors reported by the remote equipment. Maximum value is 900.
- **Complete:** Whether the interval register contains data for all 900 seconds of the interval.

Fields on this screen include:

Field ...	Contains ...
Current Interval Timer	The number of seconds which have elapsed in the current 15-minute interval. Maximum value is 900 seconds (15 minutes). This counter is reset every 15 minutes. When zero, the port is disabled.
Error Events Counter	A running total of CRC errors. Range 0–65535. This counter resets when the near-end data is cleared. When zero, the port is disabled.
Current Int	Performance data for the current 15-minute interval. When blank, the port is disabled.
Interval xx	Historical performance data for up to 96 15-minute intervals (24 hours). When blank, the port is disabled.
Worst Interval	The number of the interval with the worst (highest) performance data for both the near- and far-end statistics. If two or more intervals are equal, the oldest interval is displayed. When blank, the port is disabled.
Near and Far Tot	A running 24-hour total of the near- and far-end performance statistics.

Viewing Network Performance Statistics

Network performance statistics allow you to monitor the current status of network DSL operations.

To view Network Performance Statistics, follow this menu selection sequence:

Main Menu → *Status* → *Performance Statistics* →
Network Performance Statistics

```

main/status/performance/net_perf
Slot: 4:
Port: 2
Model: 87xx
NETWORK PERFORMANCE STATISTICS
Payload Rate: 1536 kbps
Current Interval Timer: 002
DSL Line Rate: 1552 kbps
-----
--Mrgn--      --XmtPw-      --RxGn--      -Complete-
Near Far      Near Far      Near Far      Near Far
Current Int: +02 +01      +03 +03      +02 +02      Yes Yes
Interval 01  +02 +02      +03 +03      +02 +02      Yes No
Interval 02  +02 +01      +03 +03      +02 +02      Yes Yes
Interval 03  +02 +01      +03 +03      +02 +02      Yes Yes
Interval 04  +02 +01      +03 +03      +02 +02      Yes Yes
Interval 05  +02 +01      +03 +03      +02 +02      Yes Yes
Interval 06  +02 +01      +03 +03      +02 +02      Yes Yes
Interval 07  +02 +01      +03 +03      +02 +02      Yes Yes
-----
Ctrl-a to access these functions, ESC for previous menu      MainMenu  Exit
PgUp      PgDn

```

The following Network Performance Statistics are collected for the selected port:

- **Mrgn:** Signal to Noise Ratio (SNR) Margin, the amount (in dB) that the Receive signal has exceeded the value needed to maintain a Bit Error Rate (BER) of 10^{-6} or better.
- **XmtPw:** The transmit power level.
- **RxGn:** The receiver gain level.
- **Complete:** Whether the interval register contains data for all 900 seconds of the interval.

Fields on this screen include:

Field . . .	Contains . . .
Current Interval Timer	The number of seconds which have elapsed in the current 15-minute interval. Maximum value is 900 seconds (15 minutes). This counter is reset every 15 minutes. When zero, the port is disabled.
Payload Rate	The rate of data transfer.
DSL Line Rate	The rate of the DSL line.
Current Int	Performance data for the current 15-minute interval. When blank, the port is disabled.
Interval xx	Historical performance data for up to 96 15-minute intervals (24 hours). When blank, the port is disabled.

Viewing DSX-1 Performance Statistics

DSX-1 performance statistics allow you to monitor the current status of the DSX-1 interface when ESF framing is selected.

To view DSX-1 Performance Statistics, follow this menu selection sequence:

Main Menu → *Status* → *Performance Statistics* → *DSX-1 Performance Statistics*

```

main/status/performance/DSX-1
Slot: 4                               Model: 87xx
Port: 2                               DSX-1 PERFORMANCE STATISTICS

Current Interval Timer: 2              Error Events Counter: 0000
-----
--ES--  --UAS--  --SES--  --BES--  --CSS--  -LOFC-  -Status-
Current Int:    000    000    000    000    000    000    Y
Interval 01:    000    000    000    000    000    000    none
Interval 02:    000    000    000    000    000    000    none
Interval 03:    000    000    000    000    000    000    none
Interval 04:    000    000    000    000    000    000    none
Interval 05:    000    000    000    000    000    000    none
Interval 06:    000    000    000    000    000    000    none
Interval 07:    000    000    000    000    000    000    none

Worst Interval:   24     14     14     09     18     12
Tot (valid 96): 00010  00000  00000  00000  0020  0000
-----
Ctrl-a to access these functions, ESC for previous menu      MainMenu  Exit
PgUp      PgDn      ClrStats

```

The following DSX-1 Performance Statistics are collected:

- **ES (Errored Seconds):** Seconds during which one or more Extended Superframe (ESF) events occurred. Maximum value is 900.
- **UAS (Unavailable Seconds):** Seconds during which service is unavailable. UAS is received at the start of 10 consecutive SES and cleared at the start of 10 seconds with no SES. Maximum value is 900.
- **SES (Severely Errored Seconds):** Seconds during which 320 or more CRC error events or at least one Out of Frame (OOF) event occurred. Maximum value is 900.
- **BES (Bursty Errored Seconds):** Contains the number of bursty errored seconds for the current interval. A bursty errored second is any second with more than one but less than 320 CRC errors. Maximum value is 900.
- **CSS (Controlled Slip Seconds):** Seconds during which one or more controlled slips (as defined in TR 54016) occurred. Maximum value is 900.
- **LOFC (Loss of Frame Count):** Contains the number of times that an LOF is declared. Maximum value is 255.

- **Status:** Contains the contents of the status events register. The status events register maintains a history of specific events that have occurred during an interval. Values include:
 - **Y:** Remote alarm indication signal (yellow alarm) received at the DSX-1 interface
 - **L:** Loss of signal detected at the DSX-1 interface
 - **E:** Excessive error rate threshold exceeded
 - **F:** Frame synchronization bit error detected
 - **V:** Line code violation detected
 - **None:** No significant events have occurred

Fields on this screen include:

Field . . .	Contains . . .
Current Interval Timer	The number of seconds which have elapsed in the current 15-minute interval. Maximum value is 900 seconds (15 minutes). This counter is reset every 15 minutes. When zero, the port is disabled.
Error Events Counter	A running total of CRC and OOF events. Range = 0–65535. This counter is reset when the statistics are cleared. When zero, the port is disabled.
Current Int	Performance data for the current 15-minute interval. When blank, the port is disabled.
Interval xx	Historical performance data for up to 96 15-minute intervals (24 hours) where the value of xx is from 01 to 96. When blank, the port is disabled.
Worst Interval	Identifies the interval during which the most error events were detected. When blank, the port is disabled.
Tot	A running total of the performance statistics.

Viewing G.703 Performance Statistics

G.703 performance statistics allow you to monitor the current status of the G.703 interface when Framed mode is selected.

To view G.703 Performance Statistics, follow this menu selection sequence:

Main Menu→*Status*→*Performance Statistics*→*G.703 Performance Statistics*

```

main/status/performance/G.703
Slot: 4                                     Model: 87xx
Port: 2                                     G.703 PERFORMANCE STATISTICS

Current Interval Timer: 004                Error Events Counter: 012
-----
--ES--  --UAS--  --SES--  --BES--  --CSS--  -LOF-  -Status-
Current Int:    000    000    000    000    000    000    Y
Interval 01:    000    000    000    000    000    000    none
Interval 02:    000    000    000    000    000    000    none
Interval 03:    000    000    000    000    000    000    none
Interval 04:    000    000    000    000    000    000    none
Interval 05:    000    000    000    000    000    000    none
Interval 06:    000    000    000    000    000    000    none
Interval 07:    000    000    000    000    000    000    none

Worst Interval:  24     14     14     09     18     12
Tot (valid 96): 00010  00000  00000  00000  0020  0000
-----
Ctrl-a to access these functions, ESC for previous menu      MainMenu  Exit
PgUp   PgDn   ClrStats

```

The following G.703 Performance Statistics are collected for the selected port:

- **ES (Errored Seconds):** Seconds during which one or more CRC error events occurred. Maximum value is 900.
- **UAS (Unavailable Seconds):** Seconds during which service is unavailable. UAS is received at the start of 10 consecutive SES and cleared at the start of 10 seconds with no SES. Maximum value is 900.
- **SES (Severely Errored Seconds):** Seconds during which 805 or more CRC error events, 16 or more Frame Alignment Signal (FAS) errors, or at least one Loss of Signal (LOS) or Alarm Indication Signal (AIS) event occurred.
- **BES (Bursty Errored Seconds):** Contains the number of bursty errored seconds for the current interval. A bursty errored second is any second with more than one but less than 805 CRC error events (CRC mode) or more than one but less than 16 FAS errors (non-CRC mode). Maximum value is 900.
- **CSS (Controlled Slip Seconds):** Seconds during which one or more controlled slips (as defined in TR 54016) occurred.
- **LOF (Loss of Frame Seconds):** Contains the number of seconds that contain one or more LOF events. Maximum value is 900.

- **Status:** Contains the contents of the status events register. The status events register maintains a history of specific events that have occurred during an interval. Values include:
 - **Y:** Remote alarm indication signal received at the G.703 interface
 - **L:** Loss of signal detected at the G.703 interface
 - **E:** Excessive error rate threshold exceeded
 - **F:** Frame synchronization bit error detected
 - **V:** Line code violation detected
 - **None:** No significant events have occurred

Fields on this screen include:

Field . . .	Contains . . .
Current Interval Timer	The number of seconds which have elapsed in the current 15-minute interval. Maximum value is 900 seconds (15 minutes). This counter resets every 15 minutes. When zero, the port is disabled.
Error Events Counter	A running total of CRC errors. Range 0–65535. This counter resets when the statistics are cleared. When zero, the port is disabled.
Current Interval	Performance data for the current 15-minute interval. When blank, the port is disabled.
Interval xx	Historical performance data for up to 96 15-minute intervals (24 hours). When blank, the port is disabled.
Worst Interval	The number of the interval with the worst (highest) performance data statistics. If two or more intervals are equal, the oldest interval is displayed. When zero, the port is disabled.
Tot	A running total of the performance statistics.

Viewing Current Network Performance Statistics

The Current Network Performance Statistics screen allows you to monitor selected current network status and error information for both the near- and far-end units from a single screen.

To view Current Network Performance Statistics, follow this menu selection sequence:

Main Menu → *Status* → *Performance Statistics* →
Current Network Performance Statistics

```

main/status/performance/current
Slot: 4:                               Model: 87xx
Port: 2                                CURRENT NETWORK PERFORMANCE STATISTICS
                                         Payload Rate: 1536 kbps
                                         DSL Line Rate: 1552 kbps
Current Interval Timer: 002
-----
      Near End      Far End
Margin             +02      +01
XmtPw              +03      +03
RxGn               +02      +02

ES                 002      000
SES                002      000
FEBE               000      000
-----
Ctrl-a to access these functions, ESC for previous menu      MainMenu  Exit
                        ClrNear  ClrFar
Select: 1, 2, 3, 4                                LOS at Net, Pt 1

```

The following Network Performance Statistics are collected for the selected port:

- **Margin:** Signal to Noise Ratio (SNR) Margin, the amount (in dB) that the Receive signal has exceeded the value needed to maintain a Bit Error Rate (BER) of 10^{-6} or better.
- **XmtPw:** The transmit power level.
- **RxGn:** The receiver gain level.

The following Network Error Statistics are collected for the selected port:

- **ES (Errored Seconds):** Seconds during which one or more ESF error events occurred.
- **SES (Severely Errored Seconds):** Seconds during which more than 320 cyclic redundancy check (CRC) error events or at least one Out of Frame (OOF) event occurred.
- **FEBE (Far-End Block Errors):** Errors reported by the remote equipment.

Fields on this screen include:

Field ...	Contains ...
Current Interval Timer	The number of seconds which have elapsed in the current 15-minute interval. Maximum value is 900 seconds (15 minutes). This counter is reset every 15 minutes. When zero, the port is disabled.
Payload Rate	The rate of data transfer.
DSL Line Rate	The rate of the DSL line.

Viewing Inband Management Statistics

The Inband Management Statistics screen allows you to monitor the Inband Management Channel (IMC).

NOTE:

The Inband Management Statistics screen is only available for Model 8779 Termination Units.

To view Inband Management Statistics, follow this menu selection sequence:

Main Menu → *Status* → *Performance Statistics* → *Inband Management Statistics*

```

main/status/performance/inband
Slot: 4:                                     Model: 8779

                                INBAND MANAGEMENT STATISTICS

Inband Management Type: PPP                 Inband Management TimeSlot: 1
Inband Management Port: 3

-----
Total:          TX Frames    TX Octets                RX Frames    RX Octets
                45354        357                      9576        467

-----

                                ESC for previous menu      MainMenu  Exit

Clr                                                    LOS at DSL, Pt 1

```

The following Inband Management Statistics are collected:

- **TX Frames:** A count of the total number of frames sent to the IBMC, the number of frames sent to the Data Link Connection Identifier (DLCI), and the number of frames sent to the Local Management Interface (LMI) (0 – 4,294,967,295). The counts of DLCI and LMI frames are not displayed if Inband Management Type is PPP.
- **TX Octets:** A count of the total number of octets sent to the IBMC, the number of octets sent to the DLCI, and the number of octets sent to the LMI (0 – 4,294,967,295). The counts of DLCI and LMI octets are not displayed if Inband Management Type is PPP.
- **RX Frames:** A count of the total number of frames received on the IBMC, the number of frames received from the DLCI, and the number of frames received from the LMI (0 – 4,294,967,295). The counts of DLCI and LMI frames are not displayed if Inband Management Type is PPP.
- **RX Octets:** A count of the total number of octets received on the IBMC, the number of octets received from the DLCI, and the number of octets received from the LMI (0 – 4,294,967,295). The counts of DLCI and LMI octets are not displayed if Inband Management Type is PPP.

Fields on this screen include:

Field ...	Contains ...
DLCI	The DLCI configured for the Inband Management Channel (16 – 1007).
LMI	The LMI Type configured for the Inband Management Channel (Annex A, Annex D, or Standard).
Inband Management Type	The type of Inband Management Channel configured for the card (only PPP is available).
Inband Management Port	The port assigned to the Inband Management Channel.
Inband Management TimeSlot	The time slot assigned to the Inband Management Channel.

Viewing LED Status

The unit LEDs can be viewed on the Display LEDs Status screen, available locally and remotely.

The LEDs are organized into three groups:

- **System** LEDs display the status of the unit
- **DSX-1 or G.703** LEDs provide the status of the DTE interface
- **DSL Loop** LEDs display the activity on the DSL network

To view the Display LEDs status screen, follow this menu selection sequence:

Main Menu → *Status* → *Display LEDs*

```

main/status/leds
Slot: 18
Model: 87xx

                DISPLAY LEDs

      SYSTEM      DSX-1|G.703 Port  DSL LOOP
-----
Alarm Off        P1:Link Up         P1:Link Up
Test Off         P2:Link Up         P2:Link Up
                 P3:Link Up         P3:Disabled
                 P4:Link Up         P4:Link Up
                 P5:Link Up         P5:Link Up
                 P6:Link Up         P6:Link Up
                 P7:Link Up         P7:Link Up
                 P8:Link Up         P8:Link Up

-----
                ESC for previous menu      MainMenu      Exit

```

The LED status display screen is updated every 5 seconds.

Table 7-5 shows the meaning of the possible values for each LED represented.

Table 7-5. Display LEDs Screen

Type	Label	Value is . . .	Indicating . . .
SYSTEM	Alarm	On Off	Device failure, Power-On Self-Test (POST) failure, ports inoperable or unable to train. No alarms.
	Test	On Off	Loopback test or 511 test pattern in progress. No tests.
DSX-1 PORT	P1 through P8	Link Up Link Down LOF EER Yellow AIS Disabled	Recoverable signal present on the DSX-1 network. No signal on the port. The port has a Loss of Frame alignment. The port has an Excessive Error Rate condition. The port received a Yellow Alarm. The port received an Alarm Indication Signal. The port has been administratively disabled.
G.703 PORT	P1 through P8	Link Up Link Down LOF EER RAI AIS Disabled	Recoverable signal present on the G.703 network. No signal on the port. The port has a Loss of Frame alignment. The port has an Excessive Error Rate condition. The port received a Remote Alarm Indication. The port received an Alarm Indication Signal. The port has been administratively disabled.
DSL LOOP	P1 through P8	Link Up Link Down Startup OOF Disabled	DSL link is up. DSL link is down. DSL training in progress. Out Of Frame condition. The port has been administratively disabled.

Front Panel LEDs

The following table describes the meaning and states of the LEDs on the faceplate. The LEDs for PORTS represent the DTE or DSL ports, depending upon the Port LEDs selection on the Control screen (see [Changing the Meaning of the PORTS LEDs](#) on page 7-25).

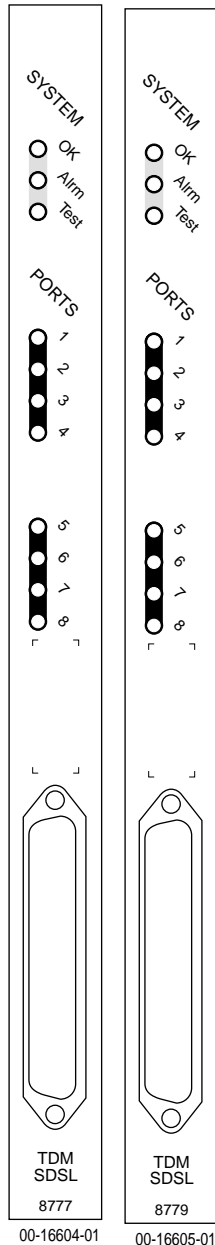

Type	LED	LED is . . .*	Indicating . . .
SYSTEM	OK (Green)	On	Unit failure; system processing functions have stopped.
		Off	No power to card.
		Pulsing Slow Cycling	Normal operation; card functioning normally. Unit is in minimum mode and a download is required.
	Alarm (Amber)	On	Device failure, Power-On Self-Test (POST) is not complete, or an alarm was reported on a DSL, DSX-1, or G.703 port.
		Off	No alarms.
	Test (Amber)	On	Loopback test or 511 test pattern in progress.
		Off	No tests.
		Slow Cycling	POST in progress.
PORTS (when DSX-1 or G.703 selected)	1, 2, 3, 4, 5, 6, 7, 8 (Green)	On	Recoverable signal present on the DSX-1 or G.703 network.
		Off	No signal on the port.
		Slow Cycling Fast Cycling	Yellow Alarm Indication (DSX-1) or Remote Alarm Indication (G.703). An OOF, LOF, EER, or AIS condition exists.
PORTS (when DSL selected)	1, 2, 3, 4, 5, 6, 7, 8 (Green)	On	DSL link is up.
		Off	DSL link is down.
		Slow Cycling	DSL training in progress.
		Fast Cycling	OOF condition.

* Slow Cycling: LED turns off and on in equal duration once per second.
Fast Cycling: LED turns off and on in equal duration 5 times per second.
Pulsing: LED turns off momentarily once per second.

Changing the Meaning of the PORTS LEDs

The LEDs for PORTS on the front panel represent the status of the DSL network or DTE ports, depending on the Port LEDs configuration option. The LED display can also be selected at any time through the Control branch.

► Procedure

To change the meaning of the LEDs for PORTS using the Control branch:

1. From the Main Menu, select Control.
2. Move the cursor to the Port LEDs entry.
3. Toggle the selection using the spacebar.
4. Press Enter.

Troubleshooting

The termination unit is designed to provide many years of trouble-free service. If a problem occurs, however, refer to [Table 7-6, Troubleshooting](#), for possible solutions. If an error message is displayed under Health and Status on the System and Test Status screen, refer to [Table 7-1, Health and Status Messages](#), for the recommended action.

Table 7-6. Troubleshooting (1 of 2)

Symptom	Possible Cause	Solutions
Alarm LED is on.	A system failure has occurred.	Refer to Table 7-1, Health and Status Messages , for recommended action.
Cannot access the unit via the ATI.	The terminal is not set up for the correct rate or data format, or the unit is configured so it prevents access.	<ul style="list-style-type: none"> ■ Check the cable and connections. ■ Ensure that the unit is configured properly in the DSLAM. Verify its IP address. ■ Reset the unit.
Device Fail appears on the System and Test Status screen under Self-Test results.	The unit detects an internal hardware failure.	<ul style="list-style-type: none"> ■ Reset the unit. ■ Contact your service representative.
Power-On Self-Test fails. Only Alarm LED is on after power-on.	The unit has detected an internal hardware failure.	
No power, or the LEDs are not lit.	The unit is not properly seated in the DSLAM.	Verify that the unit is properly inserted.
	There is no power to the DSLAM.	Verify that the DSLAM has power.

Table 7-6. Troubleshooting (2 of 2)

Symptom	Possible Cause	Solutions
An LED is not lit.	LED is out.	Run the Lamp Test. If the LED in question does not flash with the other LEDs, then contact your service representative.
Not receiving data.	<ul style="list-style-type: none"> ■ The network or DTE port cables are not connected (check front panel LEDs for more information). ■ A test is being executed on the unit (check the TEST LED on the front panel). ■ The far-end device is offline. 	<ul style="list-style-type: none"> ■ Check network and DTE port cables. ■ Check Health and Status menu. ■ Run Loopback tests. Refer to Chapter 8, Testing. ■ Stop the test or wait for the test to end. ■ Make sure the far-end device is on.
Not receiving data on one or more time slots.	The DSL line rate does not support the number of DSL time slots defined.	Match the number of DSL time slots to the DSL line rate. See Table A-2, Payload Rates and DSL Line Rates for Model 8777 , Table A-3, Payload Rates and DSL Line Rates for G.703 , for information about payload rates for different DSL line rates.
	The associated port is administratively disabled.	Check the Display LEDs screen to determine if the port is disabled. Enable the port if necessary using the Network, DSX-1, or G.703 Interface Options screen.

Accessing the Test Menu

From the Test menu, you can run network tests, data port tests, and a front panel lamp test.

To access the Test menu, follow this menu selection sequence:

Main Menu → *Test*

```
main/test
Slot: 18                                     Model: 87xx

                                TEST

Network & DSX-1 | G.703 Tests
Device Tests
Abort All Tests

-----
Ctrl-a to access these functions, ESC for previous menu   MainMenu  Exit
```

Select ...	To ...
Network & DSX-1 Tests Network & G.703 Tests	Start and stop tests on the DSX-1, G.703, or network interface.
Device Tests	Start and stop the Lamp Test.
Abort All Tests	To abort current tests excluding network-initiated loopback tests. An aborted test may continue to run for a few seconds as the abort command is sent to the remote end and processed.

Running Network Tests

Network tests require the participation of your network service provider. To access the Network Tests screen, follow this menu selection sequence:

Main Menu → *Test* → *Network & DSX-1 Tests*

– or –

Main Menu → *Test* → *Network & G.703 Tests*

```
main/test/network_DSX1
Slot: 18
Port: 1
Model: 8777
```

NETWORK & DSX-1 TESTS			
Test	Command	Status	Results

Local Loopbacks			
Network Line Loopback:	Start	Inactive	00:00:00
Network Repeater Loopback:	Start	Inactive	00:00:00
DSX-1 DTE Loopback:	Start	Inactive	00:00:00
Remote Loopbacks			
Send Line Loopback: <u>Down</u>	Send	Inactive	00:00:00
Pattern Tests			
Send and Monitor 511	Stop	Active	10:12:42 - Errors 99999+

Ctrl-a to access these functions, ESC for previous menu <u>M</u> ainMenu <u>E</u> xit			
<u>R</u> esetMon			

```
main/test/network_G703
Slot: 4
Port: 2
Model: 8779
```

NETWORK & G.703 TESTS			
Test	Command	Status	Results

Local Loopbacks			
Network Line Loopback:	Start	Inactive	00:00:00
Network Repeater Loopback:	Start	Inactive	00:00:00
G.703 DTE Loopback:	Start	Inactive	00:00:00
Network Remote Loopbacks			
Send Line Loopback: <u>Down</u>	Send	Inactive	00:00:00
Network Pattern Tests			
Send and Monitor 511	Stop	Active	11:37:52 - Errors 99999+

Ctrl-a to access these functions, ESC for previous menu <u>M</u> ainMenu <u>E</u> xit			
<u>R</u> esetMon			

Use the **Command** column to start or stop a test. When the **Status** column shows that a test is Inactive, **start** is displayed; when a test is Active, **stop** is displayed.

Position the cursor at the desired Start or Stop command and press Enter. The **Results** column displays the test duration.

Selecting Abort All Tests from the Test menu will not disrupt a Send and Monitor 511 test. When the Send and Monitor 511 test is active, ResetMon is available to reset the error counter to zero.

Network Line Loopback

A Network Line Loopback (LLB) loops the received signal on the network interface back to the network without change.

For DSX-1 models:

- If the DSL port is in a DS0 cross-connection, corresponding DSX-1 time slots are sent all ones.
- If the DSL port is in Bypass mode or a DS1 cross-connection, an AIS is sent to the corresponding DSX-1 port.

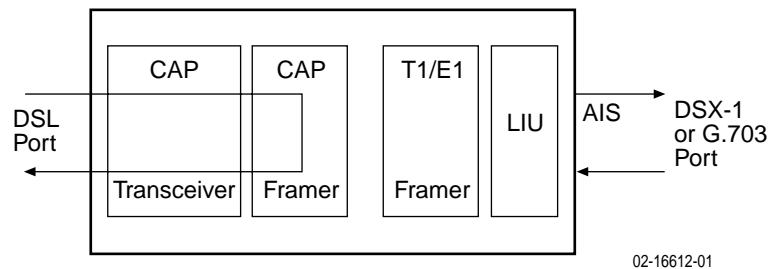

► Procedure

To run a Network Line Loopback:

1. Position the cursor at the Start command next to Network Line Loopback on the Network & DSX-1 or Network & G.703 Tests screen.
2. Press Enter.
The Start command is changed to Stop. Status is changed to Active.
3. To manually stop the test, verify that the cursor is positioned at the Stop command.
4. Press Enter.
Status is changed to Inactive.

The Network Line Loopback cannot be started when another loopback or pattern test is in progress.

Repeater Loopback

A Repeater Loopback (RLB) loops the data normally sent to the DSL port back to the connected DTE ports.

The DSL port is sent all ones and data received on the DSL link is ignored.

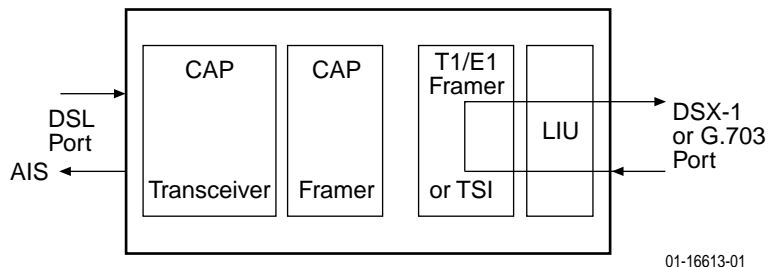

► Procedure

To run a Repeater Loopback:

1. Position the cursor at the Start command next to Repeater Loopback on the Network & DSX-1 or Network & G.703 Tests screen.
2. Press Enter.
The Start command is changed to Stop. Status is changed to Active.
3. To manually stop the test, verify that the cursor is positioned at the Stop command.
4. Press Enter.
Status is changed to Inactive.

A Repeater Loopback cannot be started when any other loopback test is in progress.

DTE Loopback

DTE Loopback loops the DSX-1 or G.703 signal back to itself, retaining (bipolar violation) BPV transparency. Also:

- If the DSX-1 or G.703 port is in a DS0 cross-connection, the time slots cross-connected to the DSX-1 or G.703 port are sent all ones.
- If the DSX-1 or G.703 port is in Bypass mode or a DS1 cross-connection, all ones are sent to the corresponding port and data received on the connected ports will be ignored.

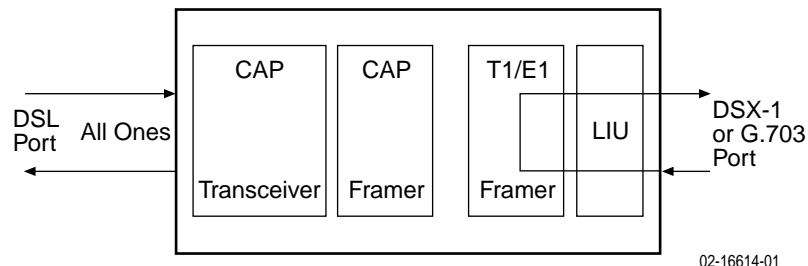

► Procedure

To run a DTE Loopback:

1. Position the cursor at the Start command next to DTE Loopback on the Network & DSX-1 or Network & G.703 Tests screen.
2. Press Enter.
The Start command is changed to Stop. Status is changed to Active.
3. To manually stop the test, verify that the cursor is positioned at the Stop command.
4. Press Enter.
Status is changed to Inactive.

The DTE Loopback cannot be started when any other loopback test is in progress.

Remote Send Line Loopback

The local unit initiates this test by sending a line loopback Up or Down command to the remote unit for 10 seconds. When the remote unit detects the loopback Up command, it puts itself in line loopback and lights the front panel Test LED. The remote unit remains in loopback until it receives a loopback Down command or the remote unit's test timeout value is exceeded. The Send Line Loopback tests both units. External equipment can be used to verify the link.

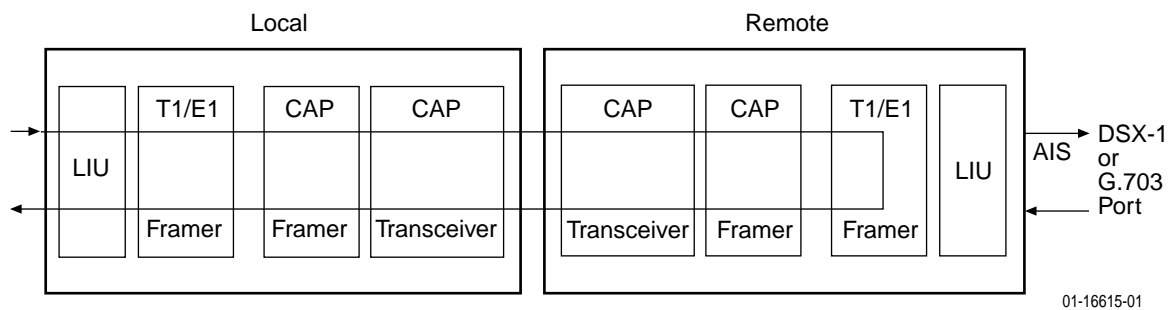

► Procedure

To run a Remote Send Line Loopback:

1. Position the cursor at the Up or Down selection next to Send Line Loopback on the Network & DSX-1 or Network & G.703 Tests screen.
2. Press the spacebar to select either Up or Down.
3. Position the cursor at the Send command next to Up or Down selection.
4. Press Enter.

The local unit stops sending the loopback command automatically after 10 seconds. Status is changed to Sending for 10 seconds, then back to Inactive.

The Remote Send Line Loopback cannot be started when any other loopback or a Send and Monitor 511 test is active on the network interface.

Remote Send Line Loopback cannot be used in cross-connect mode.

► Procedure

To manually stop a Remote Send Line Loopback:

1. Press the spacebar to select either Up or Down.
2. Position the cursor at the Send command next to Up or Down selection.
3. Press Enter.

Send and Monitor 511

The Send and Monitor 511 test causes the local and remote units to send a 511 test pattern to each other. The front panel Test LEDs of both units are on during the test. The duration and results of the test are displayed on the Network Test screen of the initiating unit. The card will send ones in the G.703 timeslots that are mapped to the DSL port in test.

NOTE:

The Send and Monitor 511 test is not a loopback test. Each unit independently sends and monitors a 511 pattern.

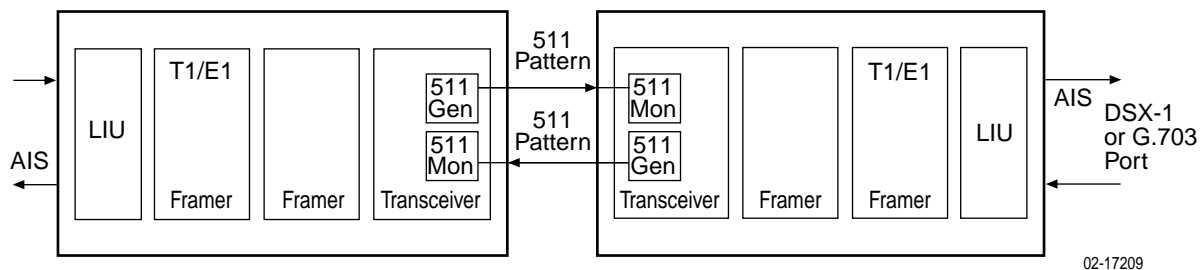

► Procedure

To run a Send and Monitor 511 test:

1. Position the cursor at the Start command next to Send and Monitor 511 on the Network & DSX-1 Tests screen or the Network & G.703 Tests screen.
2. Press Enter.
The Start command is changed to Stop.
3. To manually stop the test, verify that the cursor is positioned at the Stop command.
4. Press Enter.

When a Send and Monitor 511 test is active, a count of bit errors is displayed next to the test duration, and the ResetMon virtual function key is available for use. Type r or R or select the ResetMon virtual function key to reset the error count.

The Remote Send Line Loopback cannot be started when any other loopback or a Send and Monitor 511 test is active on the Network interface.

Device Tests

The Device Tests branch is only used to access the card-level test, the Lamp Test. To access the Device Tests screen, follow this menu selection sequence:

Main Menu → *Test* → *Device Tests*

```

main/test/card
Model: 87xx

                DEVICE TESTS

      Test      Command      Status
-----
Lamp Test:    Start      Inactive

-----
Ctrl-a to access these functions, ESC for previous menu      MainMenu  Exit

```

Lamp Test

The Lamp Test determines whether all LEDs are lighting and functioning properly.

► Procedure

To test the LEDs:

1. Position the cursor at the Start command next to Lamp Test on the Device Tests screen.

2. Press Enter.

The Start command is changed to Stop. During the Lamp Test, all LEDs blink simultaneously every second.

3. To stop the Lamp Test, position the cursor at the Stop command. The LEDs are restored to their normal condition.

4. Press Enter.

Ending an Active Test

Except for the Remote Send Line Loopback, a test initiated by the user can be ended by the user with the following methods:

- **Test Timeout option** – Enable the Test Timeout system option so the unit can automatically terminate tests, and set the Test Duration (min) option to specify the amount of time that tests can run before the unit terminates the test. The default is 10 minutes. Refer to [Table A-7, System Options](#), in Appendix A, *Configuration Options*.
- **Command column** – Under the Command column on any test screen, position the cursor at Stop next to the active test and press Enter to stop a specific test.
- **Abort All Tests menu selection** – Select Abort All Tests from the Test menu to stop all tests running on all interfaces. **Command Complete** appears when all tests on all interfaces have been terminated. Network-initiated loopbacks cannot be stopped from the Test menu.

An aborted test may continue to run for a few seconds as the Stop command is sent to the remote end and processed.

Telco-Initiated Tests

Hotwire 8777 Termination Units support Telco-initiated tests, as shown in the following table.

Activation and Deactivation	Line Loopback	Payload Loopback	Remote Line Loopback
In-Band Signal	Supported	Not Applicable	Not Supported
Bit-Oriented	Supported	Supported	Supported
Message-Oriented	Not Applicable	Not Supported	Not Applicable

Telco-Initiated Line Loopback

Hotwire 8777 Termination Units support line loopback, as specified in AT&T TR 54016, AT&T TR 62411, and ANSI T1.403. A Telco-Initiated Line Loopback loops the received signal on the DSX-1 interface back to the DSX-1 interface without modification. Framing, CRC, and FDL bits are returned unaltered, and no BPVs or other line coding errors are removed. DSL time slots mapped to the DSX-1 port are sent all ones.

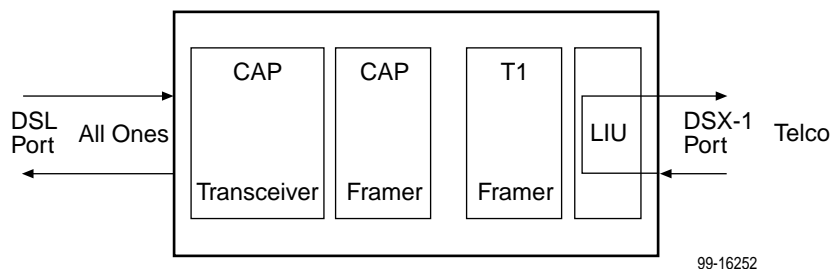

Telco-Initiated Payload Loopback

Hotwire 8777 Termination Units support payload loopback, as specified in AT&T TR 54016 and ANSI T1.403. A Telco-initiated line loopback loops the received signal on the DSX-1 interface back to the DSX-1 interface. Framing, CRC, and FDL bits are regenerated at the point of the loopback, and BPVs are removed. DSL time slots mapped to the DSX-1 port are sent all ones.

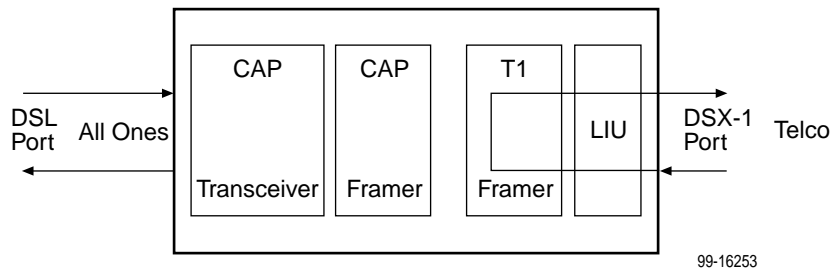

Telco-Initiated Remote Line Loopback

If Remote Telco Loopback is enabled, a Telco-Initiated Line Loopback loops received data at the remote unit and passes it back to the Telco through the local unit.

The following figure shows the data flow for a remote Telco-initiated payload loopback.

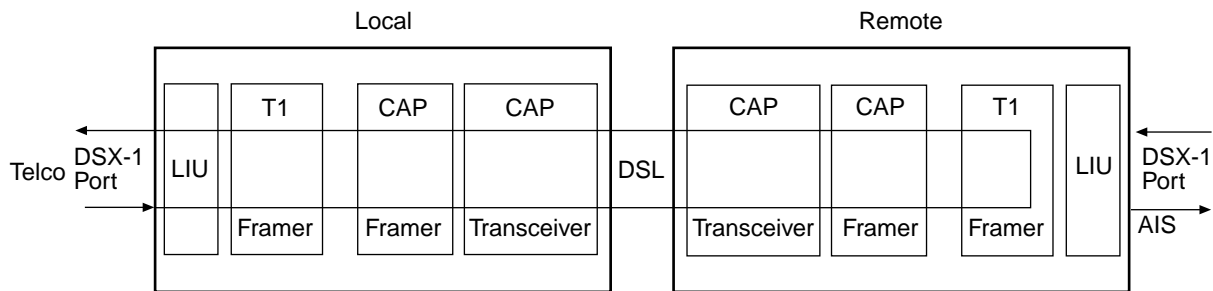

99-16626

Telco-Initiated Remote Line Loopback cannot be used in cross-connect mode.

Transferring Firmware and Configurations Using TFTP

9

Downloading Firmware

The Download Code screen allows you to download firmware from a TFTP server or MCP Flash File System (FFS). To access the Download Code screen, follow this menu selection sequence:

Main Menu → Control → Download Code

```
main/control/download_code
Slot: 4                                     Model: 87xx

                                DOWNLOAD CODE

Image File Name: _____ Clear
TFTP Server IP Address: IP 000.000.000.000 Clear
Destination: DSL1
Immediately Apply Download: No_
Start Transfer: Yes

Packets Sent: 0000000
Packets Received: 0000000
Bytes Sent: 0000000
Bytes Received: 0000000
Transfer Status: Transfer Pending

-----
Ctrl-a to access these functions, ESC for previous menu      MainMenu  Exit
```

► Procedure

To download firmware:

1. Position the cursor in the Image File Name field. Type the name of the file to be downloaded.

The file name must be a regular path name expression of directory names separated by a forward slash (/) ending with the file name. The total path name length can be up to 128 characters.

2. Position the cursor in the TFTP Server IP Address field. Enter the TFTP server IP address or **M1** for the MCP FFS.

The first three digits of the IP address cannot be 000 or greater than 223.

3. For an LTU, go to [Step 4](#). For an NTU, position the cursor in the Destination field. Use the spacebar to select a network destination for the TFTP server.
4. Position the cursor in the Immediately Apply Download field. If you would like the download to be effective immediately, select **Yes**.
5. Position the cursor at the Start Transfer field. Use the spacebar to select **Yes**. Press Enter.

When the data transfer is complete:

- If you selected Yes in [Step 4](#), the card is reset.
- If you selected No, the Transfer Status field changes to **Completed successfully**.

If you specified **No** (the default) in the Immediately Apply Download field in [Step 4](#), you must now apply the download.

```

main/control/apply_download                                     Model: 87xx

                                APPLY DOWNLOAD

                                Switch To Code Revision A01.00.02: No_

                                WARNING:
                                An answer of "yes" will cause the system
                                to reset as if it had been powered off and on!

-----
Ctrl-a to access these functions, ESC for previous menu      MainMenu  Exit
Select: Yes, No                                             LOS at Net, Pt 1

```

► **Procedure**

To apply the downloaded firmware:

1. Press the Escape key to return to the Control menu. Select Apply Download.
2. On the Apply Download screen, type **Yes** to reset the card and activate the code.

Selecting Yes causes the termination unit to reset.

NOTE:

The termination unit has two flash memory banks to hold executable firmware. You can switch between these two firmware versions by applying the firmware listed on the Apply Download screen.

Configuration Loader

The Configuration Loader screen allows you to upload configurations to and download configurations from a TFTP server or the MCP FFS. To access the Configuration Loader screen, follow this menu selection sequence:

Main Menu → *Configuration* → *Configuration Loader*

```

main/config/config_loader
Slot: 4
Model: 87xx

                                CONFIGURATION LOADER

Image File Name: _____ Clear
TFTP Server IP Address: IP 000.000.000.000 Clear
TFTP Transfer Direction: Download from Server
Destination: DSL1

Start Transfer: Yes

Packets Sent: 0000000
Packets Received: 0000000
Bytes Sent: 0000000
Bytes Received: 0000000
Transfer Status: Transfer Pending

Activate new configuration? No_

-----
Ctrl-a to access these functions, ESC for previous menu      MainMenu Exit

```

► Procedure

To upload or download a configuration:

1. Position the cursor in the Image File Name field. Type the name of the file to be downloaded, or the name to be used for the file to be uploaded.

The file name may be a regular path name expression of directory names separated by a forward slash (/) ending with the file name. The total path name length can be up to 128 characters.

- **DOS machine:** If the TFTP server is hosted by a DOS machine, then directory and filenames must consist of eight or less characters with an optional suffix of up to three characters. The system will automatically upload the configuration file and create directories and filenames as needed.
- **UNIX machine:** If your server is hosted by a UNIX machine, the configuration file you name must already exist. It will not be created on the UNIX system by the TFTP server. It is critical that you work with your system administrator to plan the naming conventions for directories, filenames, and permissions so that anyone using the system has read and write permissions.
- **MCP FFS:** When uploading configuration files to the MCP FFS, the directory and filename must be entered, otherwise the download will fail.

2. Position the cursor in the TFTP Server IP Address field. Enter the TFTP server IP address or **M1** for the MCP FFS.

The first three digits of the IP address cannot be 000 or greater than 223.

3. Position the cursor in the TFTP Transfer Direction field. Use the spacebar to select Download from Server or Upload to Server.
4. For an LTU, go to [Step 5](#). For an NTU, position the cursor in the Destination field. Use the spacebar to select a network destination for the TFTP server. Select DSL if the TFTP server destination is the DSL link port or IMC (Internal Management Channel) if the TFTP destination is the Management port of the MCC card.
5. Position the cursor at the Start Transfer field. Use the spacebar to select Yes. Press Enter.

When the data transfer is complete, the Transfer Status field changes to **Completed successfully**.

6. Position the cursor at the **Activate new configuration?** prompt and select **Yes** to activate a new downloaded configuration. Press Enter.

NOTE:

The following options are not changed:

- DSL Mode and Telnet Session configuration options
- Peer IP address

You must change these settings with the appropriate configuration menus after the new configuration is activated. See [Table A-7, System Options](#), and [Table A-12, Telnet Session Options](#), in Appendix A, *Configuration Options*.

Configuration Options



Overview

The tables in this appendix summarize the configuration options accessed when you select Current Configuration on the Main Menu. The configuration options are arranged into groups based upon functionality.

Select . . .	To Access the . . .	To Configure the . . .
Network	Network Interface Options (Table A-1)	DSL interface ports.
DSX-1	DSX-1 Interface Options – Model 8777 (Table A-4)	DSX-1 interface ports (Model 8777).
G.703	G.703 Interface Options – Model 8779 (Table A-5)	G.703 interface ports (Model 8779).
Copy Ports	Copy Port Options (Table A-6)	DSL network and DTE interface ports by copying options from port to port.
System Options	System Options (Table A-7)	General system options of the unit.
System Clock	System Clock Options (Table A-8)	System clock options.
Cross-Connect	Cross-Connect Mode Options – Model 8777 (Table A-9) Cross-Connect Mode Options – Model 8779 (Table A-10) Assign Time Slots Options (Table A-11)	DS1 and DS0 cross-connect ports.
Management and Communication	<ul style="list-style-type: none">■ Telnet Session Options (Table A-12)■ General SNMP Management Options (Table A-13)■ SNMP NMS Security Options (Table A-14)■ SNMP Traps Options (Table A-15)■ Inband Management Channel Options – Model 8779 (Table A-16)	Management support of the unit through SNMP, Telnet, and the Inband Management Channel.

NOTE:

All changes to configuration options must be saved. Refer to [Saving Configuration Options](#) in Chapter 3, *Initial Startup and Configuration*.

Network Interface Options Menu

For Network Interface Options, refer to [Table A-1, Network Interface Options](#). To access the Network Interface Options screen, follow this menu selection sequence:

Main Menu → *Configuration* → *Current Configuration* → *Network*

```

main/config/network
Slot: 18
Port 2
Model: 87xx

NETWORK INTERFACE OPTIONS

Port Status          Enable_
Margin Threshold:    0db
Excessive Error Rate Threshold: 1E-6
AutoRate:            Disable
DSL Line Rate:       1552 Kbps
EIA-530 Payload Rate 1536 Kbps
Transmit Attenuation 0db
Peer IP Address:     111.255.255.000 Clear
DS0 Cross Connect Line Framing: ESF

Circuit Identifier: _____ Clear

-----
Ctrl-a to access these functions, ESC for previous menu   MainMenu  Exit
Save
    
```

Table A-1. Network Interface Options (1 of 4)

Port Status
Possible Settings: Enable, Disable Default Setting: Enable
Determines whether the port can be configured and used. Enable – The port can be configured and used. Disable – The port cannot be configured or used.
Margin Threshold
Possible Settings: -5db, -4db, -3db, -2db, -1db, 0db, 1db, 2db, 3db, 4db, 5db, 6db, 7db, 8db, 9db, 10db Default Setting: 0db
Determines the level, expressed in decibels, at which a signal-to-noise margin condition is recognized. -5db to 10db – Sets the margin threshold to this value.

Table A-1. Network Interface Options (2 of 4)

Excessive Error Rate Threshold
Possible Settings: 1E-4, 1E-5, 1E-6, 1E-7, 1E-8, 1E-9 Default Setting: 1E-6
Determines the error rate at which an excessive error rate (EER) condition is recognized. The rate is the ratio of the number of CRC errors to the number of bits received in a certain period. 1E-4 – 1E-9 – The rate at which EER is recognized.
AutoRate
Possible Settings: Enable, Disable Default Setting: Disable
Determines whether the unit automatically adjusts to the best line rate for conditions, or is fixed at the rate in the DSL Line Rate field. The automatically set rate cannot exceed Max DSL AutoRate. <ul style="list-style-type: none"> ■ AutoRate is only available when the unit is configured as an LTU. Enable – The LTU adjusts to the best line rate. Disable – The LTU's line rate is the DSL Line Rate selected.
DSL Line Rate
Possible Settings (Model 8777): 144, 272, 400, 528, 784, 1040, 1552 Default Setting: 1552 Possible Settings (Model 8779): 144, 272, 400, 528, 784, 1040, 1552, 2064 Default Setting: 2064
Specifies the fixed line rate of the LTU when AutoRate is disabled. See Table A-2, Payload Rates and DSL Line Rates for Model 8777 , or Table A-3, Payload Rates and DSL Line Rates for G.703 , for information about maximum payload rates for different DSL line rate. <ul style="list-style-type: none"> ■ DSL Line Rate is only available when the unit is configured as an LTU and AutoRate is disabled. 144 – 2064 – The fixed DSL Line Rate, in Kbps.
Max DSL AutoRate
Possible Settings (Model 8777): 144, 272, 400, 528, 784, 1040, 1552 Default Setting: 1552 Possible Settings (Model 8779): 144, 272, 400, 528, 784, 1040, 1552, 2064 Default Setting: 2064
Specifies the maximum rate to which the unit can AutoRate. See Table A-2, Payload Rates and DSL Line Rates for Model 8777 , or Table A-3, Payload Rates and DSL Line Rates for G.703 , for information about maximum payload rates for different DSL line rates. <ul style="list-style-type: none"> ■ Max DSL AutoRate is only available when the unit is configured as an LTU and AutoRate is enabled. 144 – 2064 – The AutoRate ceiling, in Kbps.

Table A-1. Network Interface Options (3 of 4)

EIA-530 Payload Rate
<p>Possible Settings (Model 8777): 64, 128, 256, 384, 512, 768, 1024, 1536 Default Setting: 1536</p> <p>Possible Settings (Model 8779): 64, 128, 192, 256, 320, 384, 448, 512, 576, 640, 768, 960, 1024, 1536, 1920, 1984, 2048 Default Setting: 2048</p>
<p>Specifies the synchronous port speed of a remote NTU that is an EIA-530 model so the unit can run at the highest DSL line rate supported.</p> <ul style="list-style-type: none"> ■ EIA-530 Payload Rate is only available when the unit is configured as an LTU. ■ For the Model 8779 to achieve the payload rates listed above, both the 8779 card and the 7975-A2 endpoint must be operating with firmware 02.03.12 or greater. In lower firmware versions, the payload rate is only selectable at a DSL line rate of 144 Kbps while all other rates default to the maximum, depending on the DSL line rate selected. <p>64 – 2048 – The synchronous port speed of the remote NTU, in Kbps.</p>
Transmit Attenuation
<p>Possible Settings: 0dB – 15dB Default Setting: 0dB</p>
<p>Determines how much the unit's transmit power is reduced to accommodate a short line length.</p> <p>0dB – The full transmit power is used (no attenuation).</p> <p>1dB – 15dB – The unit's transmit power is reduced by the specified amount.</p>
Peer IP Address
<p>(LTU) Possible Settings: 001.000.000.000 – 223.255.255.255, Clear Default Setting: 000.000.000.000</p>
<p>Specifies the peer IP address providing the remote management link on the DSL loop.</p> <ul style="list-style-type: none"> ■ Peer IP Address is only available when the unit is configured as an LTU and the unit is in not running in IP Conservative mode. <p>Address Field – (001.000.000.000 – 223.255.255.255) – Enter an address for the peer unit. The range for the first byte is 001 to 223, with the exception of 127. The range for the remaining three bytes is 000 to 255. The IP address must be in the same subnet as the MCC backplane address.</p> <p>Clear – Clears the IP address and sets to all zeros.</p>

Table A-1. Network Interface Options (4 of 4)

DS0 Cross Connect Line Framing
(Model 8777, LTU) Possible Settings: ESF, D4 Default Setting: ESF
Specifies the framing format to be used at the DSL interface for DS0 cross connects, regardless of the framing format specified for the DSX-1 ports. <ul style="list-style-type: none"> ■ DS0 Cross Connect Line Framing is only available on the Model 8777, only when the unit is configured as an LTU, and only when the port is in a DS0 cross connect. ESF – ESF framing formatting is used for transmitted and received data over the DSL Interface. D4 – D4 framing format is used for transmitted and received data over the DSL Interface.
Circuit Identifier
Possible Settings: ASCII text field Default Setting: [blank]
Uniquely identifies the circuit number of the transmission vendor's DSL line for troubleshooting purposes. ASCII text field – Enter a maximum of 128 characters. All printable ASCII characters except the ^ (caret) are allowed. Clear – Clears the field.

[Table A-2, Payload Rates and DSL Line Rates for Model 8777](#), and [Table A-3, Payload Rates and DSL Line Rates for G.703](#), provide the maximum payload rates achievable for each DSL line rate and the number of time slots required to achieve that payload rate. For G.703, the payload rate depends on whether you are using signaling (time slots 0 and 16) or data only (time slot 0).

Table A-2. Payload Rates and DSL Line Rates for Model 8777

DSL Line Rate (Kbps)	DSX-1-to-DSX-1		DSX-1- to-EIA-530-A	
	Payload Rate (Kbps)	Time Slots	Payload Rate (Kbps)	Time Slots
1552	1536	24	1536	24
1040	960	15	1024	16
784	704	11	768	12
528	448	7	512	8
400	320	5	384	6
272	192	3	256	4
144	64	1	64, 128	1, 2

Table A-3. Payload Rates and DSL Line Rates for G.703

DSL Line Rate (Kbps)	Voice Mode G.703-to-G.703		Data Mode G.703-to-G.703		Data Mode G.703-to-EIA-530-A	
	Payload Rate (Kbps)	Time Slots	Payload Rate (Kbps)	Time Slots	Possible Payload Rate (Kbps)*	Time Slots
2064	1920	30	1984	31	1920, 1984, 2048	30, 31, 32
1552	1408	22	1472	23	1536	24
1040	896	14	960	15	960, 1024	15, 16
784	640	10	704	11	576, 640, 768	9, 10, 12
528	384	6	448	7	448, 512	7, 8
400	256	4	320	5	320, 384	5, 6
272	128	2	192	3	192, 256	3, 4
144	N/A	N/A	64	1	64, 128	1, 2
* For firmware versions N2.03.05 and below, the payload rate is only selectable at a DSL line rate of 144 Kbps, while all other rates default to the maximum, depending on the DSL line rate selected.						

DSX-1 Interface Options (Model 8777)

For the Model 8777's DSX-1 Interface Options, refer to [Table A-4, DSX-1 Interface Options – Model 8777](#). To access the DSX-1 Interface Options screen, follow this menu selection sequence:

Main Menu → *Configuration* → *Current Configuration* → *DSX-1*

```

main/config/DSX-1
Slot: 18
Port 2
Model: 8777

DSX-1 INTERFACE OPTIONS

Port Status:          Enable
Line Coding           B8ZS
Line Framing:        ESF
Line Equalization:    0 -133
Excessive Error Rate Threshold: 1E-4

Primary Clock Source: DSX-1

-----
Ctrl-a to access these functions, ESC for previous menu   MainMenu   Exit
Save

```

Table A-4. DSX-1 Interface Options – Model 8777 (1 of 2)

Port Status
Possible Settings: Enable, Disable Default Setting: Enable
Determines whether the port can be configured and used. Enable – The port can be configured and used. Disable – The port cannot be configured or used. Configuration fields for the port are inaccessible, no alarms or traps associated with the port are generated, and the LED associated with the port is OFF. NOTE: Cross-connections are not cleared when a port is disabled.
Line Coding Format
Possible Settings: AMI, B8ZS Default Setting: B8ZS
Specifies the line coding format to be used by the DSX-1 interface. AMI – Indicates the line coding format used by the DSX-1 interface is Alternate Mark Inversion (AMI). B8ZS – Indicates the line coding format used by the DSX-1 interface is B8ZS.

Table A-4. DSX-1 Interface Options – Model 8777 (2 of 2)

Line Framing
Possible Settings: ESF, D4 Default Setting: ESF
Specifies the framing format to be used by the DSX-1 interface. <ul style="list-style-type: none"> ■ Line Framing is only available when the unit is configured as an LTU. The NTU is automatically configured to match the framing format used by the LTU. ESF – ESF framing formatting is used for transmitted and received data over the DSX-1 Interface. D4 – D4 framing format is used for transmitted and received data over the DSX-1 Interface.
Line Equalization
Possible Settings: 0–133, 133–266, 266–399, 399–533, 533–655 Default Setting: 0–133
Compensates for signal distortion for a DSX-1 signal over a given distance. 0–133 feet – Provides equalization for a cable length up to 133 feet. 133–266 feet – Provides equalization for a cable length up to 266 feet. 266–399 feet – Provides equalization for a cable length up to 399 feet. 399–533 feet – Provides equalization for a cable length up to 533 feet. 533–655 feet – Provides equalization for a cable length up to 655 feet.
Excessive Error Rate Threshold
Possible Settings: 1E–4, 1E–5, 1E–6, 1E–7, 1E–8, 1E–9 Default Setting: 1E–4
Determines the error rate at which an excessive error rate (EER) condition is recognized. The rate is the ratio of the number of CRC errors to the number of bits received in a certain period. 1E–4 – 1E–9 – The rate at which EER is recognized.
Primary Clock Source
Possible Settings: Internal, DSX-1 Default Setting: DSX-1
Specifies where the unit will derive its timing from. <ul style="list-style-type: none"> ■ Primary Clock Source is available only when the unit is configured as an LTU. Internal – Timing is derived from the internal oscillator. DSX-1 – Timing is derived from the DSX-1 interface.

G.703 Interface Options (Model 8779)

For the Model 8779's G.703 Interface Options, refer to [Table A-5, G.703 Interface Options – Model 8779](#). To access the G.703 Interface Options screen, follow this menu selection sequence:

Main Menu → *Configuration* → *Current Configuration* → *G.703*

```

main/config/G.703
Slot: 4
Port: 2
Model: 8779

G.703 INTERFACE OPTIONS

Port Status:          Enable
Framing:              Framed
Line Coding:          HDB3
Line Framing:         noCRC4
Time Slot 16:         Data
Primary Clock Source: G703

-----
Ctrl-a to access these functions, ESC for previous menu   MainMenu   Exit
Save

```

Table A-5. G.703 Interface Options – Model 8779 (1 of 3)

Port Status
Possible Settings: Enable, Disable Default Setting: Enable
Determines whether the port can be configured and used. This field is read-only when the port is configured as the inband management port.
Enable – The port can be configured and used.
Disable – The port cannot be configured or used. Configuration fields for the port are inaccessible, no alarms or traps associated with the port are generated, and the LED associated with the port is OFF.
NOTE: Cross-connections are not cleared when a port is disabled.

Table A-5. G.703 Interface Options – Model 8779 (2 of 3)

Framing
Possible Settings: Framed, Unframed Default Setting: Framed
Specifies whether G.704 framing is used for the G.703 interface. Framed – The unit conforms to G.704 framing format, using time slot 0. Unframed – G.704 framing is disabled. When selected, the port is not available for DS0 cross-connect mode. ■ Unframed is only available when DSL line rate is 2064 Kbps.
Line Coding
Possible Settings: AMI, HDB3 Default Setting: HDB3
Specifies the line coding format to be used by the G.703 interface. AMI – Indicates the line coding format used by the G.703 interface is Alternate Mark Inversion (AMI). HDB3 – Indicates the line coding format used by the G.703 interface is HDB3.
Line Framing
Possible Settings: CRC4, noCRC4 Default Setting: noCRC4
Specifies the framing format to be used by the G.703 interface. ■ Line Framing is only available when the unit is configured as an LTU. The NTU is automatically configured to match the framing format used by the LTU. CRC4 – CRC4 framing formatting is used for transmitted and received data over the G.703 Interface. noCRC4 – Non-CRC4 framing format is used for transmitted and received data over the G.703 Interface.
Time Slot 16
Possible Settings: Signaling_CAS, Signaling_CCS, Data Default Setting: Signaling_CCS
Specifies whether the G.703 interface is used for voice or data. Signaling_CAS – Time slot 16 contains Channel Associated Signaling (CAS) information (the unit is in voice mode). Signaling_CCS – Time slot 16 contains Common Channel Signaling (CCS) information (the unit is in voice mode). Data – Time slot 16 contains data (the unit is in data mode).

Table A-5. G.703 Interface Options – Model 8779 (3 of 3)

Primary Clock Source
Possible Settings: Internal, G.703 Default Setting: Internal
Determines the primary clock source for the unit in Bypass mode. <ul style="list-style-type: none">■ Primary Clock Source is available only when the unit is configured as an LTU. When configured as an NTU, the clock source is derived from the DSL. <p>Internal – Timing is derived from the internal oscillator.</p> <p>G.703 – Timing is derived from the G.703 interface.</p>

Copy Ports Options

You can copy the configuration options of one DSX-1 or G.703 interface, or DSL loop to another using the Copy Ports screen. For Copy Ports options, refer to [Table A-6, Copy Port Options](#). To access the Copy Ports screen, follow this menu selection sequence:

Main Menu → *Configuration* → *Current Configuration* → *Copy Ports*

```

main/config/copy
Slot: 18
Model: 87xx

COPY PORTS

From: Port 1
To: Port 2

Perform Copy

Perform Copy Then Increment

-----
Save          ESC for previous menu          MainMenu  Exit

```

Table A-6. Copy Port Options

From: Port <i>n</i>
Possible Settings: 1, 2, 3, 4, 5, 6, 7, 8 Default Setting: 1
Controls the source of the configuration options. 1–8 – The configuration of the selected port is copied.
To: Port <i>y</i>
Possible Settings: 1, 2, 3, 4, 5, 6, 7, 8, All Default Setting: 1
Controls the target of the configuration options. 1–8 – The configuration of the selected port is replaced. If Perform Copy Then Increment is selected, the port number is incremented by 1 after the copy. All – The configurations of all ports are replaced by the configuration of the selected From: Port. NOTE: Peer IP Address and Circuit Identifier are <i>not</i> copied.

System Options

For System Options, refer to [Table A-7, System Options](#). To access the System Options screen, follow this menu selection sequence:

Main Menu → *Configuration* → *Current Configuration* → *System Options*

```

main/config/system
slot: 18
Model: 87xx

SYSTEM OPTIONS

DSL Mode:           LTU
Test Timeout:      Enable
Test Duration (min): 10
Telco Initiated Loopbacks: Enable (Model 8777)
Remote Telco Line Loopback: Disabled (Model 8777)
G.703 Line Termination 120 Ohm (Model 8779)

-----
Ctrl-a to access these functions, ESC for previous menu   MainMenu Exit
Save

```

Table A-7. System Options (1 of 2)

DSL Mode
Possible Settings: LTU, NTU Default Setting: LTU
Controls whether the unit is configured as a control unit or tributary unit. LTU – The unit is configured as a control unit (Line Termination Unit). NTU – The unit is configured as a tributary unit (Network Termination Unit). This unit will request its IP address from the LTU during establishment of the PPP link. NOTE: Changing this option will reset the card.
Test Timeout
Possible Settings: Enable, Disable Default Setting: Enable
Allows tests to end automatically. The feature should be enabled when the unit is remotely managed, so that control can be regained after a test is accidentally executed. Enable – Loopback and pattern tests end when test duration is reached. Disable – Tests run until manually terminated from the Network Tests screen or remotely (network initiated tests). Refer to Running Network Tests in Chapter 8, <i>Testing</i> .

Table A-7. System Options (2 of 2)

Test Duration (min)
Possible Settings: 1 – 120 Default Setting: 10
Number of minutes for a test to be active before automatically ending. <ul style="list-style-type: none"> ■ Test Duration (min) option appears when Test Timeout is enabled. 1 – 120 – Amount of time in minutes for a test to run before terminating.
Telco Initiated Loopback
(Model 8777) Possible Settings: Enable, Disable Default Setting: Enable
Determines if the unit will respond to Telco loopback commands on the DSX-1 interface. See Telco-Initiated Tests in Chapter 8, <i>Testing</i> . Enable – The unit will respond to Telco loopback commands. Disable – The unit will not respond to Telco loopback commands.
Remote Telco Line Loopback
(Model 8777) Possible Settings: Enable, Disable Default Setting: Disable
Determines if the unit will perform a Telco initiated loopback on just the local unit or if the loopback will be performed on the remote DSL unit. See Telco-Initiated Tests in Chapter 8, <i>Testing</i> . Enable – The loopback will be in the remote unit. Disable – The loopback will be local.
G.703 Line Termination
(Model 8779) Possible Settings: 75 ohms, 120 ohms Default Setting: 120 ohms
Specifies the impedance of the G.703 interface. 75 ohms – The G.703 interface impedance is 75 ohms unbalanced (for short-haul use only). 120 ohms – The G.703 interface impedance is 120 ohms balanced.

System Clock

The Primary and Secondary System Clock References determine the clock used by ports in a cross-connect configuration. For System Clock configuration options, refer to [Table A-8, System Clock Options](#). To access the System Clock screen, follow this menu selection sequence:

Main Menu → *Configuration* → *Current Configuration* → *System Clock*

```

main/config/system_clock
Slot: 18                                     Model: 87xx

                SYSTEM CLOCK

System Primary Clock Reference      Internal
System Secondary Clock Reference    Internal

-----
Ctrl-a to access these functions, ESC for previous menu      MainMenu  Exit
Save

```

All ports configured as system clock sources must be traceable to the same clock reference. Ports in a cross-connect configuration that are not providing timing themselves receive their timing from the system clock reference. All ports in a cross-connect configuration are therefore synchronized to the system clock reference.

On an LTU, the system clocks may be sourced from the DSX-1/G.703 interface which is generating timing, or from the internal oscillator on the card (providing a Stratum 4 reference). Typically, the primary clock source is a DSX-1/G.703 port which is being used in a cross-connection. The LTU secondary clock sources are restricted to G.703 ports configured for Bypass mode. On an LTU when the system clock is configured for something other than internal, DSX-1/G.703 ports configured for Bypass mode and internal timing will use the user-specified clock as their reference.

On an NTU, the system clock may only be sourced from DSL ports being used in a cross-connection. If all ports on an NTU are configured for Bypass mode, no configuration for system clock is required (primary and secondary clock should remain set to their default values).

When a system clock source fails or is misconfigured, an alarm is reported. Secondary clock failures are not reported unless the primary clock has also failed. When the primary clock fails, clocking is switched to the secondary clock source, if available. If a secondary clock is not available, the clock switches to secondary holdover mode. In holdover mode, the system attempts to generate timing which is consistent with the last clock reference. A switch is made back to the primary clock when it becomes available. Holdover mode is meant to be used for short durations while network synchronization is temporarily disrupted. The switch back to primary/secondary clock is made when they become available again.

Figure A-1, [System Timing](#), shows clocking in an LTU.

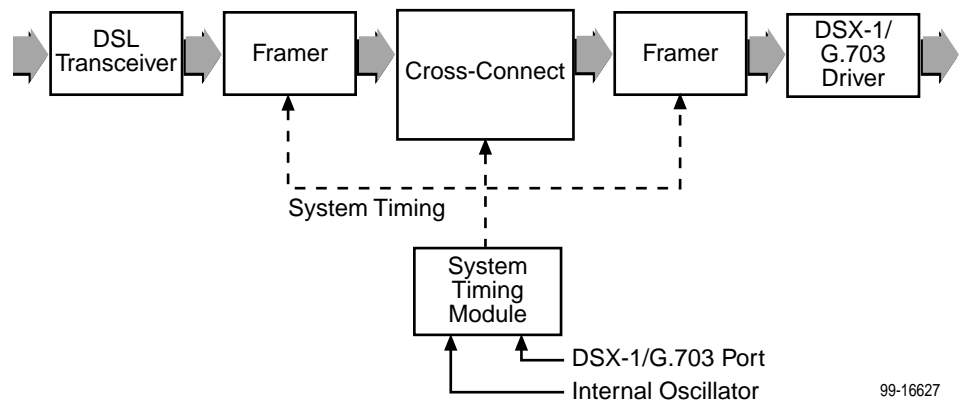

99-16627

Figure A-1. System Timing

Figure A-2, [System Clock Configuration Examples](#), shows sample system clock configurations.

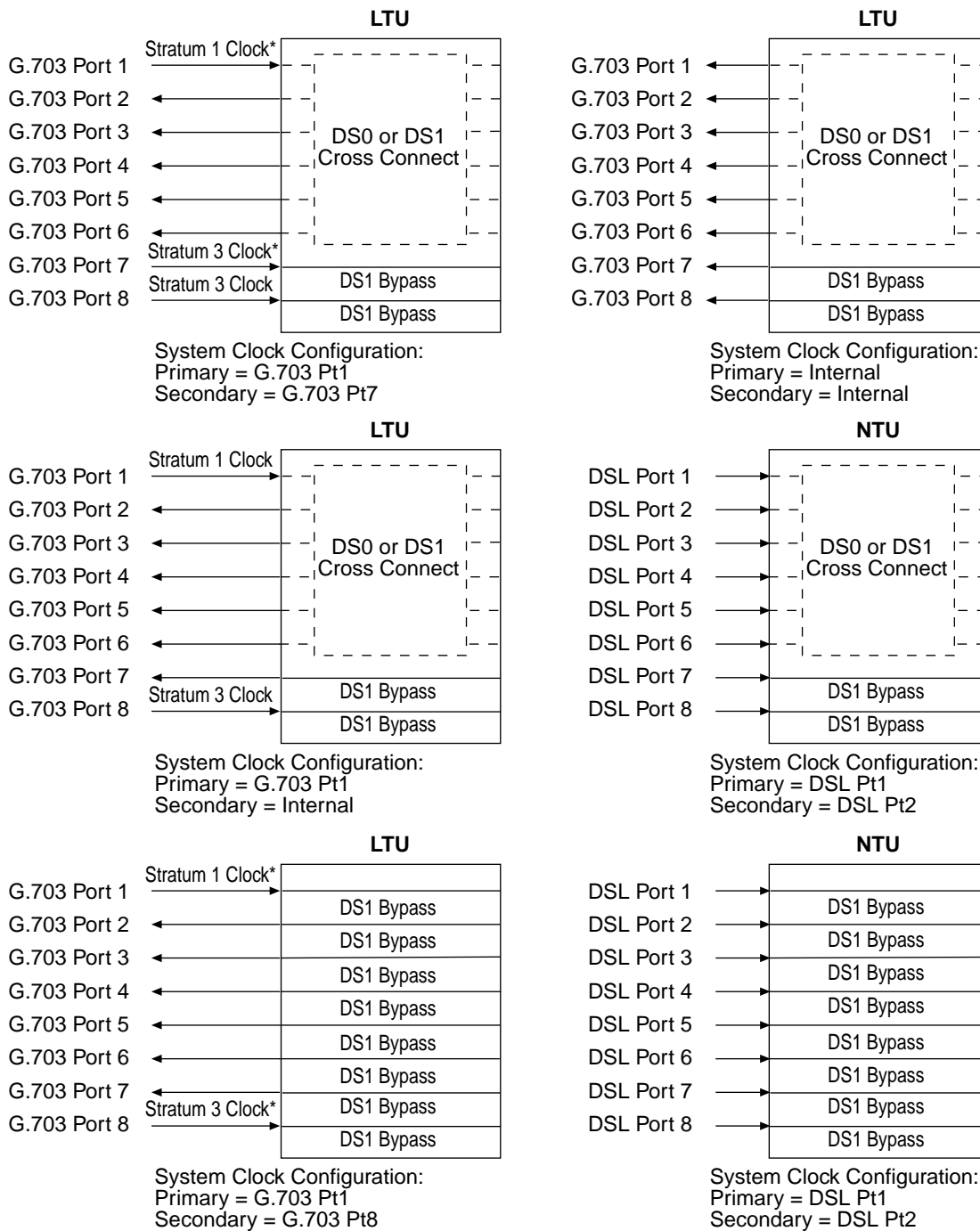

* Must be traceable to the same clock source

02-16650-01

Figure A-2. System Clock Configuration Examples

Table A-8. System Clock Options

Primary System Clock Reference
<p>Possible Settings (LTU, Model 8777): DSX-1 Port 1, DSX-1 Port 2, DSX-1 Port 3, DSX-1 Port 4, DSX-1 Port 5, DSX-1 Port 6, DSX-1 Port 7, DSX-1 Port 8, Internal Default Setting: Internal</p> <p>Possible Settings (LTU, Model 8779): G.703 Port 1, G.703 Port 2, G.703 Port 3, G.703 Port 4, G.703 Port 5, G.703 Port 6, G.703 Port 7, G.703 Port 8, Internal Default Setting: Internal</p> <p>Possible Settings (NTU): DSL Port 1, DSL Port 2, DSL Port 3, DSL Port 4, DSL Port 5, DSL Port 6, DSL Port 7, DSL Port 8 Default Setting: DSL Port 1</p>
<p>Determines the source of system timing. Select the most accurate clock available.</p> <p>DSX-1 Port <i>n</i> (Model 8777) – Timing is derived from the specified port. To be a valid clock source, the port must be enabled and must derive its timing from the DSX-1 network.</p> <p>NOTE: If the DSX-1 port is configured for Bypass mode, the Primary Clock Source configuration option on the DSX-1 Interface Options screen must be set to DSX-1, not Internal (see Table A-4). All ports configured as system clock sources must be traceable to the same clock reference.</p> <p>G.703 Port <i>n</i> (Model 8779) – Timing is derived from the specified port. To be a valid clock source, the port must be enabled and must derive its timing from the G.703 network.</p> <p>NOTE: If the G.703 port is configured for Bypass mode, the Primary Clock Source configuration option on the G.703 Interface Options screen must be set to G.703, not Internal (see Table A-5). All ports configured as system clock sources must be traceable to the same clock reference.</p> <p>DSL Port <i>n</i> – Timing is derived from the specified port. The port must be enabled and in a cross-connection.</p> <p>Internal – Timing is derived from the internal oscillator, which provides a Stratum 4 reference.</p>
Secondary System Clock Reference
<p>Possible Settings (LTU, Model 8777): DSX-1 Port 1, DSX-1 Port 2, DSX-1 Port 3, DSX-1 Port 4, DSX-1 Port 5, DSX-1 Port 6, DSX-1 Port 7, DSX-1 Port 8, Internal Default Setting: Internal</p> <p>Possible Settings (LTU, Model 8779): G.703 Port 1, G.703 Port 2, G.703 Port 3, G.703 Port 4, G.703 Port 5, G.703 Port 6, G.703 Port 7, G.703 Port 8, Internal Default Setting: Internal</p> <p>Possible Settings (NTU): DSL Port 1, DSL Port 2, DSL Port 3, DSL Port 4, DSL Port 5, DSL Port 6, DSL Port 7, DSL Port 8 Default Setting: DSL Port 1</p>
<p>Determines the source of system timing if the primary system clock source fails. If the secondary clock source fails, the unit switches to the internal clock.</p> <p>DSX-1 or G.703 Port <i>n</i> – Timing is derived from the specified port. To be a valid clock source, the port must be enabled and must derive its timing from the DSX-1 or G.703 network.</p> <p>DSL Port <i>n</i> – Timing is derived from the specified port. The port must be enabled.</p> <p>Internal – Timing is derived from the internal oscillator, which provides a Stratum 4 reference.</p>

Cross-Connect

For Cross-Connect configuration options, refer to [Table A-10, Cross-Connect Mode Options – Model 8779](#). To access the Cross-Connect screen, follow this menu selection sequence:

Main Menu → *Configuration* → *Current Configuration* → *Cross-Connect*

```
main/config/cross_connect
slot: 18                                     Model: 87xx

                                CROSS-CONNECT CONFIGURATION

                                Set Cross-Connect Mode
                                Assign Time Slots

-----
Ctrl-a to access these functions, ESC for previous menu   MainMenu   Exit
Save
```

Select:

- **Set Cross-Connect Mode** to configure the cross-connect mode for each port.
- **Assign Time Slots** to assign time slots for each cross-connected port.

Setting Cross-Connect Mode

For Cross-Connect Mode configuration options for Model 8777, refer to [Table A-9, Cross-Connect Mode Options – Model 8777](#). For Cross-Connect Mode configuration options for Model 8779, refer to [Table A-10, Cross-Connect Mode Options – Model 8779](#). To access the Set Cross-Connect Mode screen, follow this menu selection sequence:

Main Menu → *Configuration* → *Current Configuration* → *Cross-Connect* → *Set Cross-Connect Mode*

The following screen is displayed for Model 8777:

```
main/config/xconnect_mode
Slot: 18                                     Model: 8777

                                CROSS-CONNECT MODE

DSX-1 Port      MODE                DSL Port
  1      DS1 Bypass                1
  2      DS1 Bypass                2
  3      DS1 Bypass                3
  4      DS1 Bypass                4
  5      DS1 Bypass                5
  6      DS1 Bypass                6
  7      DS1 Bypass                7
  8      DS1 Bypass                8

                                Assign_DS0s

-----
Ctrl-a to access these functions, ESC for previous menu      MainMenu  Exit
Save                                                         Clear_All
```

The following screen is displayed for Model 8779:

```

main/config/xconnect_mode
Slot: 18
Model: 8779

CROSS-CONNECT MODE

Source          Destination
  G.703          DSL
  1      DS1 Bypass      1
  2      DS1 Bypass      2
  3      DS1 Bypass      3
  4      DS1 Bypass      4
  5      DS1 Bypass      5
  6      DS1 Bypass      6
  7      DS1 Bypass      7
  8      DS1 Bypass      8

Assign_DS0s

-----
Ctrl-a to access these functions, ESC for previous menu   MainMenu  Exit
Save                                                       Clear_All

```

If any port Mode is DS0 Cross-connect, select Assign_DS0s for the Assign Time Slots screen to be displayed.

Select Clear_All to change the Mode of all enabled ports to DS0 Cross-Connect. All DSL port numbers and time slot assignments are cleared.

For information about the cross-connection system, see [Chapter 4, Cross-Connecting Ports](#).

Table A-9. Cross-Connect Mode Options – Model 8777

Cross-Connect Mode
Possible Settings: DS1 Bypass, DS1 Cross-connect, DS0 Cross-connect, Unassigned, Disabled Default Setting: DS1 Bypass
Determines the cross-connect mode for the port. DS1 Bypass – The entire DSX-1 interface is connected directly to the DSL interface. DS1 Cross-connect – The entire DSX-1 interface is connected through cross-connect circuitry to the DSL port. DS0 Cross-connect – Individual time slots of the DSX-1 interface may be connected to any time slot of any of the DSL interfaces. Unassigned – None of the time slots associated with the port are assigned. Disabled – The DSX-1 port is disabled. No time slot assignments can be made to the port. To enable the port use the DSX-1 Interface screen. This value is displayed but cannot be entered.
DSL Port
Possible Settings: 1 – 8, Unassigned Default Setting: [Blank]
Determines the DSL port that is cross-connected to the specified DSX-1 port. 1 – 8 – The DSL interface that is cross-connected to the DSX-1 interface. Unassigned – None of the time slots associated with the DSX-1 interface is assigned to a DSL port.

Table A-10. Cross-Connect Mode Options – Model 8779

Source
Possible Settings: DSL, G.703
Selects a reference for how cross-connection information is displayed. The values in the Mode column refer to the ports entered as the source. DSL – The DSL port configuration is displayed. G.703 – The G.703 port configuration is displayed.
Cross-Connect Mode
Possible Settings: DS1 Bypass, DS1 Cross-connect, DS0 Cross-connect, Unassigned, Disabled, Unframed Default Setting: DS1 Bypass
Determines the cross-connect mode for the port. DS1 Bypass – The entire G.703 interface is connected directly to the DSL interface. DS1 Cross-connect – The entire G.703 or DSL interface is connected through cross-connect circuitry to any of the other G.703 interfaces or DSL interfaces. DS0 Cross-connect – Individual time slots of the G.703 or DSL interface may be connected to any time slot of any of the interfaces configured for DS0 cross-connect. Unassigned – None of the time slots associated with the port are assigned. Disabled – The G.703 port is disabled. No time slot assignments can be made to the port. To enable the port use the G.703 Interface screen. This value is displayed but cannot be entered. Unframed – Framing is disabled on the port. Since there are no time slots, the port is set to DS1 Bypass mode. This value is displayed but cannot be entered.
Destination
Possible Settings: DSL (1 – 8), G.703 (1 – 8), Unassigned, I Default Setting: DSL
Specifies which destination port is cross-connected to the selected source port (read-only). DSL or G.703 1 – 8 – The port that is cross-connected to the source port. Unassigned – None of the time slots associated with the source port are assigned to a destination port. I – The Inband Management Channel is the destination port. This selection is only available when the source port is G.703.

Assigning Time Slots

For Assign Time Slots configuration options, refer to [Table A-11, Assign Time Slots Options](#). To access the Assign Time Slots screen, select **Assign_DS0s** on the Cross-Connect Mode screen, or follow this menu selection sequence:

Main Menu → *Configuration* → *Current Configuration* → *Cross-Connect* → *Assign Time Slots*

The following screen is displayed for a DSX-1 port (Model 8777):

```

main/config/cross_connect/timeslot
Slot: 18
Model: 8777
                                ASSIGN TIME SLOTS
DSX-1 Port: 1      DSOs to Allocate:      Start TS:      Assign To: D

  TS01      TS02      TS03      TS04      TS05      TS06      TS07
D ___ d    D ___ d    D ___ d    D ___ d    D ___ d    D ___ d    D ___ d

  TS08      TS09      TS10      TS11      TS12      TS13      TS14
D ___ d    D ___ d    D ___ d    D ___ d    D ___ d    D ___ d    D ___ d

  TS15      TS16      TS17      TS18      TS19      TS20      TS21
D ___ d    D ___ d    D ___ d    D ___ d    D ___ d    D ___ d    D ___ d

  TS22      TS23      TS24
D ___ d    D ___ d    D ___ d

                                Key:  D = DSL,  X = DSX-1
                                       d = data,  v = voice
-----
Ctrl-a to access these functions, ESC for previous menu      MainMenu  Exit
Save                                                         Clear_All

```

The following screen is displayed for a G.703 port (Model 8779):

```

main/config/cross_connect/timeslot
Slot: 18
Model: 8779
                                ASSIGN TIME SLOTS
G.703 Port: 1      DSOs to Allocate:      Start TS:      Assign To: D

  TS01      TS02      TS03      TS04      TS05      TS06      TS07
D ___ d    D ___ d    D ___ d    D ___ d    D ___ d    D ___ d    D ___ d

  TS08      TS09      TS10      TS11      TS12      TS13      TS14
D ___ d    D ___ d    D ___ d    D ___ d    D ___ d    D ___ d    D ___ d

  TS15      TS16      TS17      TS18      TS19      TS20      TS21
D ___ d    D ___ d    D ___ d    D ___ d    D ___ d    D ___ d    D ___ d

  TS22      TS23      TS24      TS25      TS26      TS27      TS28
D ___ d    D ___ d    D ___ d    D ___ d    D ___ d    D ___ d    D ___ d

  TS29      TS30      TS31
D ___ d    D ___ d    D ___ d

                                Key:  D = DSL,  G = G.703 I = IBMC
                                       d = data,  v = voice
-----
Ctrl-a to access these functions, ESC for previous menu      MainMenu  Exit
Save                                                         Clear_All

```

The following screen is displayed for a DSL port on a DSX-1 unit:

```

main/config/cross_connect/timeslot
Slot: 18                                     Model: 87xx
                                           ASSIGN TIME SLOTS
DSL Port: 1      DSOs to Allocate:      Start TS:      Assign To: D
TS01      TS02      TS03      TS04      TS05      TS06      TS07
X ___ d   X ___ d   X ___ d   X ___ d   X ___ d   X ___ d   X ___ d
TS08      TS09      TS10      TS11      TS12      TS13      TS14
X ___ d   X ___ d   X ___ d   X ___ d   X ___ d   X ___ d   X ___ d
TS15      TS16      TS17      TS18      TS19      TS20      TS21
X ___ d   X ___ d   X ___ d   X ___ d   X ___ d   X ___ d   X ___ d
TS22      TS23      TS24
X ___ d   X ___ d   X ___ d

                                           Key:   D = DSL, X = DSX-1
                                                 d = data, v = voice
-----
Ctrl-a to access these functions, ESC for previous menu      MainMenu Exit
Save                                                         Clear_All

```

Select Clear_All to clear all time slot assignments for the port.

For an example showing how to configure the cross-connection system, see [Chapter 4, Cross-Connecting Ports](#).

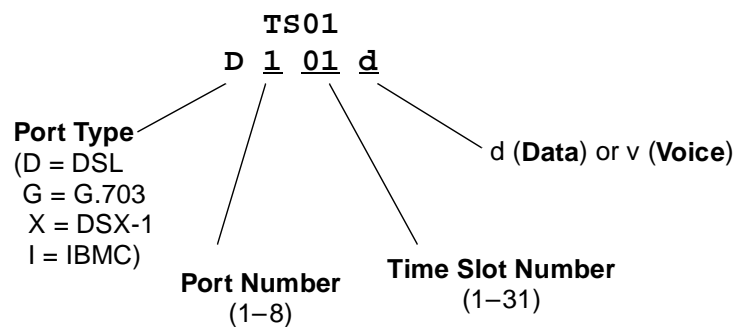

Refer to [Table A-11, Assign Time Slots Options](#), for additional information about these entries.

NOTES:

- If a G.703 port is configured for Signaling_CAS, time slot 16 is used for signaling and is not available for cross-connection.
- Make sure that the number of DSL time slots defined are supported by the DSL line rate. The maximum number of useful DSL time slots is the DSL line rate divided by 64, rounded down to a whole number. See [Table A-2, Payload Rates and DSL Line Rates for Model 8777](#), and [Table A-3, Payload Rates and DSL Line Rates for G.703](#), for more information on available time slots at different DSL line rates.

Table A-11. Assign Time Slots Options (1 of 2)

DSX-1/DSL or G.703/DSL
Possible Settings (Model 8777): DSX-1, DSL Default Setting: DSX-1 Possible Settings (Model 8779): G.703, DSL Default Setting: G.703
Determines the port for which time slots are displayed. The unit can be configured using the viewpoint of the DSX-1 or G.703 interface, or the DSL network interface. DSX-1 or G.703 – Time slots for the specified DTE port are displayed. DSL – Time slots for the specified DSL port are displayed.
Port Type
Possible Settings (Model 8777): D, X Default Setting: D Possible Settings (Model 8779): D, G Default Setting: D
Shows the type of port to which this time slot is connected. D – The time slot is connected to a DSL port. G – The time slot is connected to a G.703 port (Model 8779). X – The time slot is connected to a DSX-1 port (Model 8777). I (Model 8779 only)– The time slot is connected to an Inband Management Channel (IBMC) (read only).
Port
Possible Settings: 1 – 8 Default Setting: [Blank]
Selects the port to which this time slot is connected. 1 – 8 – The port number is specified.
DS0s to Allocate
Possible Settings (Model 8777): 1 – 24 Default Setting: [Blank] Possible Settings (Model 8779): 1 – 31 Default Setting: [Blank]
Specifies the number of contiguous time slots to be assigned at this time for the selected port. Only unassigned time slots can be selected. 1 – 31 – The number of time slots to be assigned is specified.

Table A-11. Assign Time Slots Options (2 of 2)

Start TS
Possible Settings (Model 8777): 1 – 24 Default Setting: [Blank]
Possible Settings (Model 8779): 1 – 31 Default Setting: [Blank]
Specifies the time slot where time slot assignment is to begin in the contiguous time slots specified in the DS0s to Allocate option for the selected port. Only unassigned time slots can be selected. 1 – 31 – The number of the first time slot that can be assigned.
Assign To
Possible Settings (Model 8777): D, X Default Setting: D
Possible Settings (Model 8779): D, G Default Setting: D
Assigns the corresponding port and beginning time slot specified in the DS0s to Allocate and Start TS options to a Port Type and Data or Voice setting. After the time slot is assigned, the Data or Voice setting can be changed. D – The time slot is assigned to a DSL port. G – The time slot is assigned to a G.703 port (Model 8779). X – The time slot is assigned to a DSX-1 port (Model 8777).
Time Slot Number
Possible Settings (Model 8777): 1 – 24 Default Setting: [Blank]
Possible Settings (Model 8779): 1 – 31 Default Setting: [Blank]
Determines the time slot to which this time slot is connected. 1 – 31 – The time slot to be assigned.
Data or Voice
Possible Settings: d, v Default Setting: d
Determines whether the time slot is dedicated to the transmission of voice or data. d – The time slot is used for data. v – The time slot is used for voice.

Management and Communication Options Menu

The Management and Communication Menu allows you to access the following:

- Telnet Session Options ([Table A-12](#))
- General SNMP Management Options ([Table A-13](#))
- SNMP NMS Security Options ([Table A-14](#))
- SNMP Traps Options ([Table A-15](#))
- Inband Management Channel Options – Model 8779 ([Table A-16](#))

Telnet Session Options

The Telnet Session configuration options control whether a Telnet session is allowed through an interconnected IP Network. If allowed, these options determine what level of security to apply to the session to control access. Only one Telnet session is allowed at a time. Initial values are determined by the configuration you currently have loaded.

NOTE:

Telnet Session is only available for IP Complex systems.

To access the Telnet Sessions Options screen, follow this menu selection sequence:

Main Menu → *Configuration* → *Current Configuration* →
Management and Communication → *Telnet Session*

```

main/config/management/telnet
slot: 18                                     Model: 87xx

                                TELNET SESSION OPTIONS

Telnet Session:                       Enable
Telnet Login Required:                 Enable
Session Access Level:                 Administrator
Inactivity Timeout:                   Enable
Disconnect Time (Minutes)             5

-----
Ctrl-a to access these functions, ESC for previous menu   MainMenu  Exit
Save

```

Table A-12. Telnet Session Options

Telnet Session
Possible Settings: Enable, Disable Default Setting: Enable
Specifies if the unit will respond to a Telnet session request from a Telnet client on an interconnected IP network. Enable – Allows Telnet sessions between the unit and a Telnet client. Disable – No Telnet sessions allowed.
Telnet Login Required
Possible Settings: Enable, Disable Default Setting: Disable
Specifies whether a user ID and password are required to access to the ATI through a Telnet session. Login IDs are created with a password and access level. Refer to Creating a Login in Chapter 6, <i>Security</i> . Enable – Security is enabled. When access is attempted via Telnet, the user is prompted for a Login ID and password. Disable – No Login required for a Telnet session.
Session Access Level
Possible Settings: Administrator, Operator Default Setting: Administrator
The Telnet session access level is interrelated with the access level of the Login ID. Refer to ATI Access Levels in Chapter 6, <i>Security</i> , for more information. Administrator – This is the higher access level, permitting full control of the 87xx Termination Unit. Access level is determined by the Login ID. If Telnet Login Required is disabled, the session access level is Administrator. Operator – This is the lower access level, permitting read-only access to status and configuration screens.
Inactivity Timeout
Possible Settings: Enable, Disable Default Setting: Disable
Provides automatic logoff of a Telnet session. Enable – The Telnet session terminates automatically after the Disconnect Time. Disable – A Telnet session will not be closed due to inactivity.
Disconnect Time (Minutes)
Possible Settings: 1 – 60 Default Setting: 5
Number of minutes of inactivity before a Telnet session terminates automatically. Timeout is based on no keyboard activity. <ul style="list-style-type: none"> ■ Disconnect Time (minutes) option only appears when Inactivity Timeout is enabled. 1 – 60 – The Telnet session is closed after the selected number of minutes.

General SNMP Management Options

To access the General SNMP Management Options screen, follow this menu selection sequence:

Main Menu → *Configuration* → *Current Configuration* → *Management and Communication* → *SNMP*

```

main/config/management/SNMP
Slot: 4                                     Model: 87xx

                                GENERAL SNMP MANAGEMENT OPTIONS

SNMP Management:      Enable

Community Name 1:    Public                Clear
Name 1 Access:      Read/Write
Community Name 2:    Public                Clear
Name 2 Access:      Read/Write

-----
Ctrl-a to access these functions, ESC for previous menu   MainMenu  Exit
Save
    
```

The Community Name and Name Access configuration options are not available if the unit is an LTU in a DSLAM running in IP Conservative mode.

Table A-13. General SNMP Management Options (1 of 2)

SNMP Management
Possible Settings: Enable, Disable Default Setting: Enable
Enable or disables the SNMP management features. Enable – Enables SNMP management capabilities. Disable – Disables SNMP management capabilities.

Table A-13. General SNMP Management Options (2 of 2)

Community Name 1
Possible Settings: ASCII text field Default Text: public
<p>Identifies the name of the community allowed to access the unit's MIB. The community name must be supplied by an external SNMP manager when that manager attempts to access an object in the MIB.</p> <ul style="list-style-type: none"> ■ This field does not appear if the unit is an LTU in a DSLAM running in IP Conservative mode. <p>ASCII text field – Enter or edit a community name.</p> <p>public – The community name is set to public.</p> <p>Clear – Clears the community name field.</p>
Name 1 Access
Possible Settings: Read, Read/Write Default Setting: Read/Write
<p>Determines the access level for Community Name 1.</p> <ul style="list-style-type: none"> ■ This field does not appear if the unit is an LTU in a DSLAM running in IP Conservative mode. <p>Read – Allows read-only access (get) for Community Name 1.</p> <p>Read/Write – Allows read/write access (get) for Community Name 1.</p>
Community Name 2
Possible Settings: ASCII text field Default Text: [null string]
<p>Identifies the name of the second community allowed to access the unit's MIB. The community name must be supplied by an external SNMP manager when that manager attempts to access an object in the MIB.</p> <ul style="list-style-type: none"> ■ This field does not appear if the unit is an LTU in a DSLAM running in IP Conservative mode. <p>ASCII text field – Enter or edit a community name.</p> <p>Clear – Clears the community name field.</p>
Name 2 Access
Possible Settings: Read, Read/Write Default Setting: Read
<p>Determines the access level for Community Name 2.</p> <ul style="list-style-type: none"> ■ This field does not appear if the unit is an LTU in a DSLAM running in IP Conservative mode. <p>Read – Allows read-only access (get) for Community Name 2.</p> <p>Read/Write – Allows read/write access (get/set) for Community Name 2.</p>

SNMP NMS Security Options

To access the SNMP NMS Security Options screen, follow this menu selection sequence:

Main Menu → *Configuration* → *Current Configuration* → *Management and Communication* → *Security*

```
main/config/management/security
Slot: 4
Model: 87xx

SNMP NMS SECURITY OPTIONS

NMS IP Validation:  Enable
Number of Managers:  5

NMS 1 IP Address: 135.014.040.001 Clear Access Type: Read/Write
NMS 2 IP Address: 135.014.003.027 Clear Access Type: Read/Write
NMS 3 IP Address: 135.014.001.008 Clear Access Type: Read
NMS 4 IP Address: 135.014.002.024 Clear Access Type: Read
NMS 5 IP Address: 204.128.146.035 Clear Access Type: Read

-----
Ctrl-a to access these functions, ESC for previous menu   MainMenu  Exit
Save
```

Table A-14. SNMP NMS Security Options

NMS IP Validation
Possible Settings: Enable, Disable Default Setting: Disable
Specifies whether security checking is performed on the IP address of SNMP management systems attempting to access the node. Enable – Security checking is performed on the IP address of SNMP management systems attempting to access the node. Disable – No security checking is performed.
Number of Managers
Possible Settings: 1, 2, 3, 4, 5, 6, 7, 8, 9, 10 Default Setting: 1
Specifies the number of SNMP management systems that can send SNMP messages. 1 – 10 – Number of trap managers. An NMS IP address is required for each manager.
NMS <i>n</i> IP Address
Possible Settings: 001.000.000.000 – 223.255.255.255, Clear Default Setting: 000.000.000.000
Specifies the Internet Protocol address used to identify each SNMP manager. 001.000.000.000 – 223.255.255.255 – Enter an address for each SNMP manager. The range for the first byte is 001 to 223, with the exception of 127. The range for the remaining three bytes is 000 to 255. Clear – Clears the IP address and sets to all zeros.
Access Type
Possible Settings: Read, Read/Write Default Setting: Read
Determines the access level allowed for an authorized NMS when IP address validation is being performed. Read – Allows read-only access (get) to the accessible objects in the MIB for this device. Read/Write – Allows read/write access (get/set) to the accessible objects in the MIB for this device.

SNMP Traps Options

An SNMP trap can be automatically sent out through the EOC or the Management port to the SNMP manager when the unit detects conditions set by the user. These traps enable the SNMP manager to gauge the state of the network. Refer to [Appendix B, Standards Compliance for SNMP Traps](#), for details of SNMP traps supported by the Hotwire Termination Unit.

To configure the unit for SNMP traps, use the SNMP Traps Options screen to:

- Enable SNMP traps.
- Set the number of SNMP managers that receive SNMP traps from the unit.
- Enter an IP address and network destination for each SNMP manager specified.
- Select the type of SNMP traps to be sent from the unit.

To access the SNMP Traps Options screen, follow this menu selection sequence:

Main Menu → *Configuration* → *Current Configuration* → *Management and Communication* → *SNMP Traps*

```

main/config/management/trap
Slot: 4                                     Model: 87xx

                                SNMP TRAPS OPTIONS

SNMP Traps:          Enable_                Number of Trap Managers: 9

NMS 1 IP Address: 135.014.040.001   Clear
NMS 2 IP Address: 135.014.003.027   Clear
NMS 3 IP Address: 135.014.001.008   Clear
NMS 4 IP Address: 135.014.002.024   Clear
NMS 5 IP Address: 204.128.146.035   Clear
NMS 6 IP Address: 135.014.003.028   Clear
NMS 7 IP Address: 135.014.001.009   Clear
NMS 8 IP Address: 135.014.002.025   Clear
NMS 9 IP Address: 204.128.146.036   Clear

General Traps:      Both_                Enterprise Specific Traps: Disable_
Link Traps:         Both_                Link Traps Interfaces:  All_

-----
Ctrl-a to access these functions, ESC for previous menu   MainMenu  Exit
Save

```

Table A-15. SNMP Traps Options (1 of 2)

SNMP Traps
Possible Settings: Enable, Disable Default Setting: Disable
Controls the generation of SNMP trap messages. Enable – SNMP trap messages are sent out to SNMP managers. Disable – No SNMP trap messages are sent out.
Number of Trap Managers
Possible Settings: 1, 2, 3, 4, 5, 6, 7, 8, 9 Default Setting: 1
Sets the number of SNMP management systems that will receive SNMP traps. <ul style="list-style-type: none"> ■ Number of Trap Managers is not available when the unit is running in IP Conservative mode. 1 – 9 – Number of trap managers. An NMS IP address is required for each manager.
NMS <i>n</i> IP Address
Possible Settings: 001.000.000.000 – 223.255.255.255, Clear Default Setting: 000.000.000.000
Specifies the Internet Protocol address used to identify each SNMP trap manager. <ul style="list-style-type: none"> ■ NMS <i>n</i> IP Address is not available when the unit is running in IP Conservative mode. 001.000.000.000 – 223.255.255.255 – Enter an address for each SNMP trap manager. The range for the first byte is 001 to 223, with the exception of 127. The range for the remaining three bytes is 000 to 255. Clear – Clears the IP address and sets to all zeros.
NMS <i>n</i> Destination
Possible Settings: IMC, DSL1, DSL2, DSL3, DSL4, DSL5, DSL6, DSL7, DSL8 Default Setting: IMC
Provides the network destination path of each trap manager. <ul style="list-style-type: none"> ■ NMS <i>n</i> Destination is available only when the unit is configured as an NTU and not running in IP Conservative mode. Disabled ports cannot be specified. IMC – The Internal Management Channel (IMC) is the default network destination. This is the management interface to the MCC card in the DSLAM. DSL1 – DSL8 – The specified port is the network destination.

Table A-15. SNMP Traps Options (2 of 2)

General Traps
Possible Settings: Disable, Warm, AuthFail, Both Default Setting: Both
Determines which SNMP traps are sent to each trap manager. Disable – No general trap messages are sent. Warm – Sends trap message for <i>warmStart</i> events. AuthFail – Sends trap message for <i>authenticationFailure</i> events. Both – Sends both trap messages. NOTE: Refer to Appendix B, Standards Compliance for SNMP Traps .
Enterprise Specific Traps
Possible Settings: Enable, Disable Default Setting: Disable
Determines if SNMP traps are generated for enterprise-specific events. Enable – SNMP traps are generated for <i>enterpriseSpecific</i> events. NOTE: Refer to Enterprise-Specific Traps in Appendix B, <i>Standards Compliance for SNMP Traps</i> . Disable – No enterprise-specific event traps are sent.
Link Traps
Possible Settings: Disable, Up, Down, Both Default Setting: Both
Determines if SNMP traps are generated for link up and link down for one of the communication interfaces. Disable – No <i>linkUp</i> or <i>linkDown</i> SNMP traps are generated. Up – A <i>linkUp</i> trap is generated when the unit recognizes that one of the communication interfaces is operational. Down – A <i>linkDown</i> trap is generated when the unit recognizes a failure in one of the communication interfaces. Both – Sends trap messages for detection of both <i>linkUp</i> and <i>linkDown</i> . NOTE: Refer to linkUp and linkDown in Appendix B, <i>Standards Compliance for SNMP Traps</i> .
Link Traps Interfaces
Possible Settings: Network, DSX-1, All Default Setting: All
Determines if the SNMP <i>linkUp</i> , SNMP <i>linkDown</i> , and interface-related <i>enterpriseSpecific</i> traps are generated for the network DSL interface and/or DSX-1 interface (DTE). Network – SNMP trap messages are generated for the DSL network interface. DSX-1 – SNMP trap messages are generated for the DSX-1 interface. All – SNMP trap messages are generated for the DSL network interface, COM port, and DSX-1 interface.

Inband Management Channel (Model 8779)

To access the Inband Management Channel screen, follow this menu selection sequence:

Main Menu→*Configuration*→*Current Configuration*→*Management and Communication*→*Inband Management Channel*

NOTE:

Inband Management Channel is only available for Model 8779 Termination Units configured as an LTU.

```
main/config/management/inband
slot: 4                                     Model: 8779

                                INBAND MANAGEMENT CHANNEL

Inband Management Select:      Enable
Inband Management Type:       PPP
Inband Management Port:       1
Inband Management Time Slot:  1
Inband Management DLCI:       16
Inband Management LMI:        Standard

-----
Ctrl-a to access these functions, ESC for previous menu   MainMenu  Exit
Save
```

Table A-16. Inband Management Channel Options – Model 8779

Inband Management Select
Possible Settings: Enable, Disable Default Setting: Disable
Specifies whether data on the selected port and time slot will be sent according to the cross-connect configuration or to the MCC card instead. Enable – Enables the Inband Management Channel. Disable – Disables the Inband Management Channel.
Inband Management Type
Possible Setting: PPP, Frame Relay Default Setting: PPP
Specifies the type of data the Inband Management Channel will accept. PPP – The Inband Management Channel will accept Point-to-Point Protocol (PPP) data. Frame Relay – The Inband Management Channel will accept Frame Relay data.
Inband Management Port
Possible Settings: 1 – 8 Default Setting: 1
Selects the G.703 port for the Inband Management Channel. Only ports configured for DS0 cross-connection or Unassigned are eligible for inband management.
Inband Management Time Slot
Possible Settings: 1 – 15 or 17 – 31 Default Setting: 1
Selects the G.703 time slot for the Inband Management Channel.
Inband Management DLCI
Possible Settings: 16 – 1007 Default Setting: 16
Selects the Data Link Connection Identifier (DLCI) the Inband Management Channel will use when Inband Management Type is set to Frame Relay.
Inband Management LMI
Possible Settings: Annex A, Annex D, Standard Default Setting: Standard
Selects the Local Management Interface (LMI) the Inband Management Channel will use when Inband Management Type is set to Frame Relay. Annex A – The LMI supported is specified by Q933 Annex A. Annex D – The LMI supported is specified by ANSI T1.617 Annex D. Standard – The standard LMI is supported.

Configuring and Testing Inband Management

The Model 8779 Termination Unit allows you to set up remote inband management using one of the DS0 channels as the management channel to transport SNMP traffic to the MCP card.

► Procedure

To set up inband management for the 8779 unit:

1. Ensure that MCP card is operating with firmware release M04.03.19 or later and that the 8779 unit is operating with firmware release A02.03.22 or later.
2. Configure the MCP card for inband management using a console session (not Telnet session). From the MCP card, follow this menu selection sequence:

Main Menu→*Configuration*→*Ports*→*Ethernet Port*

The Ethernet Ports screen appears.

Ethernet Ports	
Port Name:	e1a
Full Duplex:	disable
Management Port Type:	internal
Management Port Card/Slot#:	16
Reset Port:	no
Save Changes:	no

yes/no:
 Hotwire 8820: MCP: 8000c: _ _ _ U

3. Enter **Internal** for Management Port Type and the slot number of the 8779 unit to be tested for Management Port Card/Slot #. Then Enter **yes** to reset the port and save your changes.
4. Use the Cross Connect Mode screen on the 8779 unit to configure the G.703 port to be used for inband management as a DS0 cross-connection. From the 8779 unit, follow this menu selection sequence:

Main Menu→*Configuration*→*Current Configuration*→*Cross Connect*→*Set Cross Connect Mode*

The Cross Connect Mode screen appears.

```

main/config/xConnect_mode
Slot: 18
Model: 8779

CROSS CONNECT MODE

Source          Destination
G.703          DSL
1      DS0 Cross-connect  Unassigned
2      DS0 Cross-connect  Unassigned
3      DS0 Cross-connect  Unassigned
4      DS0 Cross-connect  Unassigned
5      DS0 Cross-connect  Unassigned
6      DS0 Cross-connect  Unassigned
7      DS0 Cross-connect  Unassigned
8      DS0 Cross-connect  Unassigned

Assign_DS0s

-----
Ctrl-a to access these functions, ESC for previous menu   MainMenu  Exit
Save                                                       Clear_All

```

5. Configure the G.703 port to be used for Inband Management to DS0 Cross-connect and save your changes.
6. Use the Inband Management Channel screen on the 8779 unit to configure Inband Management. From the 8779 unit, follow this menu selection sequence:

Main Menu → *Configuration* → *Current Configuration* →
Management and Communication → *Inband Management Channel*

```

main/config/management/inband
Slot: 4
Model: 8779

INBAND MANAGEMENT CHANNEL

Inband Management Select:  Enable_
Inband Management Type:    PPP_
Inband Management Port:    1_
Inband Management Time Slot: 1_

-----
Ctrl-a to access these functions, ESC for previous menu   MainMenu  Exit
Save                                                       Clear_All

```

7. Set Inband Management Select to Enable, and enter the port (1) and time slot (1) to support Inband Management. Save your changes.
8. Use the Assign Time Slots screen to verify that Inband Management has been assigned to Port 1 TS 1. Follow this menu selection sequence:

Main Menu→*Configuration*→*Current Configuration*→*Cross-Connect*→*Assign Time Slots*

The following screen appears:

```

main/config/cross_connect/timeslot
Slot: 18
Model: 8779
          ASSIGN TIME SLOTS
G.703 Port: 1   DSOs to Allocate:   Start TS:   Assign To: D
  TS01   TS02   TS03   TS04   TS05   TS06   TS07
I  _ _ _  D  _ _ _  D  _ _ _  D  _ _ _  D  _ _ _  D  _ _ _
  TS08   TS09   TS10   TS11   TS12   TS13   TS14
D  _ _ _  D  _ _ _  D  _ _ _  D  _ _ _  D  _ _ _  D  _ _ _
  TS15   TS16   TS17   TS18   TS19   TS20   TS21
D  _ _ _  D  _ _ _  D  _ _ _  D  _ _ _  D  _ _ _  D  _ _ _
  TS22   TS23   TS24   TS25   TS26   TS27   TS28
D  _ _ _  D  _ _ _  D  _ _ _  D  _ _ _  D  _ _ _  D  _ _ _
  TS29   TS30   TS31
D  _ _ _  D  _ _ _  D  _ _ _

Key:  D = DSL,  G = G.703  I = IBMC
      d = data,  v = voice

-----
Ctrl-a to access these functions, ESC for previous menu   MainMenu  Exit
Save                                                         Clear_All

```

► Procedure

To test the inband management configuration:

1. Connect the G.703 port to the MUX/DCAS to be used in the test.
2. Configure the upstream router for PPP mode. The router's WAN port should be configured on the same IP address segment as the MCP card.

3. Perform the following:

- From the upstream router, ping the MCP management IP address. Record the ping response time.
- From the management platform, ping the MCP management address. Record the ping response time.
- From the management platform, Telnet to the MCP card and verify that you can navigate through the DSLAM.
- From the management platform, FTP a firmware file to an external TFTP server on your network.
- From the 8779 unit, download the configuration file to an external TFTP server on your network.
- If an SNMP trap manager is available, generate a trap and verify that the trap was received by the trap manager.
- If OpenLane Service Level Management is available, discover the DSLAM and navigate through the OpenLane screens.

Standards Compliance for SNMP Traps

B

SNMP Traps

This section describes the unit's compliance with SNMP standards and any special operational features for the SNMP traps supported. The unit supports the following traps:

- *warmStart* on page B-2
- *authenticationFailure* on page B-2
- *linkUp and linkDown* on page B-2
- *Enterprise-Specific Traps* on page B-4

ifIndex

The object ifIndex is a variable binding for several traps. The following ifIndex values are supported for Hotwire 87xx TDM SDSL Termination Units:

ifIndex	Description
3–10	DSL Interface Ports 1–8
15–22	DSX-1 or G.703 Interface Ports 1–8
39–46	EOC Management Link Ports 1–8

For a unit defined as an LTU running IP Conservative software or a unit not running IP Conservative software, all traps have at a minimum a variable binding of the Overloaded ifIndex (OI). The formula for the OI is:

$((\text{LTU Slot Number}) * 1,000)$
+ ifIndex.

For a unit defined as an NTU running IP Conservative software, all traps have at a minimum a variable binding of the Super Overloaded ifIndex (SOI). The formula for the SOI is:

((LTU Slot Number) * 1,000,000)
 + ((LTU DSL Port Number) * 1,000)
 + the NTU's ifIndex.

warmStart

SNMP Trap	Description	Possible Cause
warmStart	The unit has reinitialized itself. The trap is sent after the unit resets and stabilizes. No variable bindings.	<ul style="list-style-type: none"> ■ Reset command. ■ Power disruption.

authenticationFailure

SNMP Trap	Description	Possible Cause
authenticationFailure	Failed attempts to access the unit. Variable bindings: <ul style="list-style-type: none"> ■ devAuthenticationFailureIPAddress (Health & Status MIB) Returns zero if the IP address is unknown or the failure came from the terminal port.	Three unsuccessful attempts were made to enter a correct login/password combination.

linkUp and linkDown

The link SNMP traps are:

- **linkUp** – The unit recognizes that one of the communication interface is operational.
- **linkDown** – The unit recognizes that one of the communication interface is not operational.

The network and synchronous port interfaces (physical sublayer) are represented by an entry in the MIB-II interfaces table and supported by the DS1 MIB.

The following list describes the conditions that define linkUp and linkDown:

linkUp/Down variable bindings
<ul style="list-style-type: none"> ■ ifIndex (RFC 2863 (was 1573)) This object provides the index into the ifTable and potentially into tables in other MIBs. The ifIndexes supported are: <ul style="list-style-type: none"> – 3–10DSL Network Interface – 15–22DSX-1 or G.703 Port – 39–46EOC Management Link ■ ifAdminStatus (RFC 2863) This object specifies the operational state of the interface: <ul style="list-style-type: none"> – up(1) The interface is enabled. – down(2) The interface is disabled. ■ ifOperStatus (RFC 2863) This object specifies the operational state of the interface: <ul style="list-style-type: none"> – up(1) DSL Port: DSL link is established and no alarms exist. DSX-1 or G.703 Port: No alarm conditions exist. EOC: Based on the state of the link layer protocol. – down(2) DSL Port: DSL link is not established or alarms exist. DSX-1 or G.703 Port: Alarm condition exists. EOC: Based on the state of the link layer protocol. – testing(3) DSL, DSX-1 or G.703 Port: A test is active on the port. – dormant(5) DSL Port: DSL link is negotiating. ■ ifType (RFC 2863) This object is the type of interface: <ul style="list-style-type: none"> – other(1) Used for the backplane HDLC interface. – ds1(18) Used for DSX-1 interface. – e1(19) Used for G.703 interface. – propPointToPointSerial(22) Used for EOC. – v35(45) Used for the EIA-530-A port. – sdsl(96) Used for the DSL network interface.

Enterprise-Specific Traps

The enterpriseSpecific trap indicates that an enterprise-specific event has occurred. The Specific-trap field identifies the particular trap that occurred. The following table lists the enterprise-specific traps supported by the unit:

SNMP Trap	Description	Possible Cause
enterprisePrimaryClockFail(1)	The unit has lost its primary clock source. No variable bindings.	Hardware failure in the unit or the clock source.
enterpriseSelfTestFail(2)	A hardware failure of the unit is detected during the unit's self-test. The trap is generated after the unit completes initialization. Variable bindings: <ul style="list-style-type: none"> ■ devSelfTestResults 	Failure of one or more of the unit's hardware components.
enterpriseDeviceFail(3)	An internal device failure. No variable bindings.	Operating software has detected an internal device failure.
enterpriseSecondaryClockFail(4)	The unit has lost its secondary clock source. No variable bindings.	Hardware failure in the unit or the clock source.
enterpriseTestStart(5)	A test is running. Variable bindings: <ul style="list-style-type: none"> ■ devSelfTestResults ■ ifIndex (RFC 2863) ■ ifAdminStatus (RFC 2863) ■ ifOperStatus (RFC 2863) ■ ifType (RFC 2863) ■ ifTestType (RFC 2863) 	At least one test has been started on an interface.
enterpriseConfigChange(6)	The configuration changed via the user interface. The trap is sent after 60 seconds have elapsed without another change. This suppresses the sending of numerous traps when multiple changes are made in a short period of time, as is typically the case when changing configuration options. No variable bindings.	Configuration has been changed via the ATU.

SNMP Trap	Description	Possible Cause
enterpriseFallbackAutoRate(13)	<p>After a loss of signal, the unit resynchronized to a lower rate than the last known rate.</p> <p>Variable bindings:</p> <ul style="list-style-type: none"> ■ ifIndex (RFC 2863) ■ ifAdminStatus (RFC 2863) ■ ifOperStatus (RFC 2863) ■ ifType (RFC 2863) 	Variable line conditions.
enterprisePrimaryClockFailClear(101)	<p>The LTU has recovered and is using its primary clock source.</p> <p>No variable bindings.</p>	
enterpriseSecondaryClockFailClear(104)	<p>The LTU has recovered and is using its secondary clock source.</p> <p>No variable bindings.</p>	
enterpriseTestStop(105)	<p>All tests have been halted.</p> <p>Variable bindings:</p> <ul style="list-style-type: none"> ■ ifIndex (RFC 2863) ■ ifAdminStatus (RFC 2863) ■ ifOperStatus (RFC 2863) ■ ifType (RFC 2863) ■ ifTestType (RFC 2863) 	All tests on an interface have been stopped by timeout or an Abort All Tests command.
enterpriseFallbackAutoRateClear(113)	<p>After an AutoRate fallback condition, the unit resynchronized to the last known rate.</p> <p>Variable bindings:</p> <ul style="list-style-type: none"> ■ ifIndex (RFC 2863) ■ ifAdminStatus (RFC 2863) ■ ifOperStatus (RFC 2863) ■ ifType (RFC 2863) 	

The tests that affect the enterpriseTestStart and enterpriseTestStop traps and the variable bindings depend on the interface. The specific tests and variable bindings are described in the following table.

Interface	enterpriseTestStart/Stop variable bindings	Possible Cause
DSL Network	<ul style="list-style-type: none"> ■ ifIndex (RFC 2863) ■ ifAdminStatus (RFC 2863) ■ ifOperStatus (RFC 2863) ■ ifType (RFC 2863) ■ ifTestType (RFC 2863) <p>The following objects control tests in SNMP-managed devices:</p> <ul style="list-style-type: none"> – noTest(0) – Stops the test in progress. – testLoopLLB(4) – Initiates a Local Loopback. – testLoopRLB(5) – Initiates a Repeater Loopback. – testSendMon511(6) – Initiates a Send and Monitor 511 test. – testSendLLBUp(7) – Initiates an LLB Up message to the remote unit. – testSendLLBDown(8) – Initiates an LLB Down message to the remote unit. 	<ul style="list-style-type: none"> ■ enterpriseTest Start – Any one of the following tests is active on the interface: <ul style="list-style-type: none"> – Line Loopback – Repeater Loopback – Remote Line Loopback – Send and Monitor 511 ■ enterpriseTest Stop – No tests currently running on the interface.
DSX-1 or G.703	<ul style="list-style-type: none"> ■ ifIndex (RFC 2863) ■ ifAdminStatus (RFC 2863) ■ ifOperStatus (RFC 2863) ■ ifType (RFC 2863) ■ ifTestType (RFC 2863) <p>The following objects control tests in SNMP-managed devices:</p> <ul style="list-style-type: none"> – noTest(0) – Stops the test in progress. – testLoopDTLB(3) – Initiates a DTE Loopback. – testLoopPLB(1) – A Telco-initiated Payload Loopback is active on the interface (DSX-1 only). 	<ul style="list-style-type: none"> ■ enterpriseTest Start – Any one of the following tests is active on the interface: <ul style="list-style-type: none"> – DTE Loopback – Telco Payload Loopback (DSX-1 only) ■ enterpriseTest Stop – No tests currently running on the interface.

Connector Pin Assignments

C

Overview

This section lists the pin assignments for the front panel 50-pin DTE connector and the 50-pin Telco connectors on the rear of the DSLAM chassis.

Front Panel 50-pin DTE Connector Pinouts

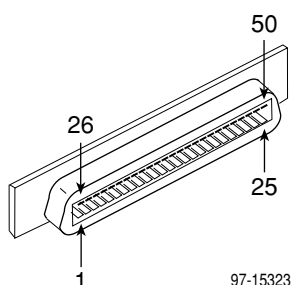

The DTE connectors on the termination unit provide the 4-wire DSX-1 or G.703 interface from each DSL port to the DTE. The following table lists the pin assignments for each of these interfaces.

Table C-1. Front Panel DTE Connector Pinouts (1 of 2)

DSX-1 or G.703 Port	50-Pin Connector Pinout	Function
Port 1	27	Data Out (Ring)
	2	Data Out (Tip)
	26	Data In (Tip)
	1	Data In (Ring)
Port 2	30	Data Out (Ring)
	5	Data Out (Tip)
	29	Data In (Tip)
	4	Data In (Ring)
Port 3	33	Data Out (Ring)
	8	Data Out (Tip)
	32	Data In (Tip)
	7	Data In (Ring)

Table C-1. Front Panel DTE Connector Pinouts (2 of 2)

DSX-1 or G.703 Port	50-Pin Connector Pinout	Function
Port 4	36	Data Out (Ring)
	11	Data Out (Tip)
	35	Data In (Tip)
	10	Data In (Ring)
Port 5	39	Data Out (Ring)
	14	Data Out (Tip)
	38	Data In (Tip)
	13	Data In (Ring)
Port 6	42	Data Out (Ring)
	17	Data Out (Tip)
	41	Data In (Tip)
	16	Data In (Ring)
Port 7	45	Data Out (Ring)
	20	Data Out (Tip)
	44	Data In (Tip)
	19	Data In (Ring)
Port 8	48	Data Out (Ring)
	23	Data Out (Tip)
	47	Data In (Tip)
	22	Data In (Ring)

8610/8620 and 8810/8820 DSLAM Telco 50-pin Connector Pinouts

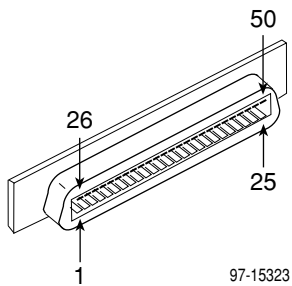

The Telco 50-pin connectors on the rear of the DSLAM chassis (numbered 1–3 in the 8610/8620 DSLAMs and 1–18 in the 8810/8820 DSLAMs) provide the 2-wire loop interface from each DSL port to either the POTS splitter shelf or, if the loop is not being shared with POTS, then to the Main Distribution Frame (MDF). The following table lists the pin assignments for each of these interfaces.

Table C-2. Rear Connector Pinouts

Port	Connector Pins (Tip, Ring)
Port 1	1, 26
Port 2	2, 27
Port 3	3, 28
Port 4	4, 29
Port 5	5, 30
Port 6	6, 31
Port 7	7, 32
Port 8	8, 33

Technical Specifications

D

Table D-1. Technical Specifications for the Hotwire 8777 and 8779 TDM SDSL Termination Unit

Specifications	Criteria*
Size	Length: 25.4 cm (10 inches) Height: 31.1 cm (12.3 inches) Width: 2.0 cm (0.8 inch)
Weight	Approximately 0.56 kg (1.24 lbs.)
Approvals Safety Certifications	Refer to the equipment's label for approvals on product.
Power	The termination unit contains a DC-to-DC converter that requires -48V power input. The -48V power is distributed through the Hotwire DSLAM backplane. Maximum Power Dissipation: 27 watts Result: 92.12 Btu/hr
Physical Environment Operating temperature Storage temperature Relative humidity Shock and vibration	0° to 50° C (32° to 122° F) -20° C to 70° C (-4° F to 158° F) 5% to 85% (noncondensing) Withstands normal shipping and handling.

* Technical specifications are subject to change without notice.

Cross-Connection Worksheets



Using the Worksheets

The following worksheets are designed to help plan, visualize, and configure a cross-connection. Time slot assignment worksheets are supplied to represent a connection from the viewpoint of the DSX-1 or G.703 ports, or the associated DSL ports. The unit can be configured using either viewpoint, so it may not be necessary or useful to fill in all the worksheets.

Use the completed port connection diagram and time slot assignment worksheets to configure the cross-connection using the Cross-Connect Mode and Assign Time Slots screens. See [Chapter 4, Cross-Connecting Ports](#), for an example of cross-connection.

Port Connection Diagram

Select Voice and/or Data for each port. Draw lines to show the connection of DSX-1 or G.703 ports to DSL ports and mark each connections as one of:

- DS1 Bypass
- DS0 Cross-Connect
- DS1 Cross-Connect

See *Determining the Configuration* in [Chapter 4, Cross-Connecting Ports](#), for a sample completed port connection diagram.

Port 1 <input type="checkbox"/> Voice <input type="checkbox"/> Data	DSX-1 G.703	DSL	Port 1
Port 2 <input type="checkbox"/> Voice <input type="checkbox"/> Data	DSX-1 G.703	DSL	Port 2
Port 3 <input type="checkbox"/> Voice <input type="checkbox"/> Data	DSX-1 G.703	DSL	Port 3
Port 4 <input type="checkbox"/> Voice <input type="checkbox"/> Data	DSX-1 G.703	DSL	Port 4
Port 5 <input type="checkbox"/> Voice <input type="checkbox"/> Data	DSX-1 G.703	DSL	Port 5
Port 6 <input type="checkbox"/> Voice <input type="checkbox"/> Data	DSX-1 G.703	DSL	Port 6
Port 7 <input type="checkbox"/> Voice <input type="checkbox"/> Data	DSX-1 G.703	DSL	Port 7
Port 8 <input type="checkbox"/> Voice <input type="checkbox"/> Data	DSX-1 G.703	DSL	Port 8

99-16602

DSX-1 Time Slot Assignments

Fill in the port number and time slot cross-connection and data/voice mode for each time slot. Then transfer the entries to the Assign Time Slots screen.

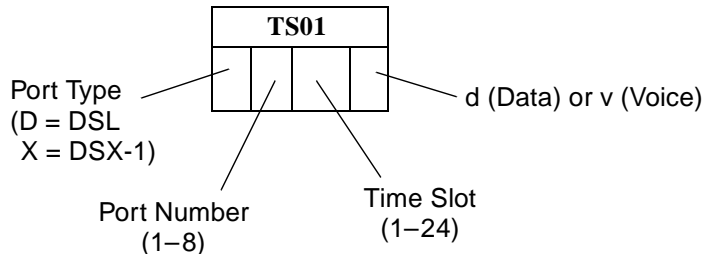

Time Slot Assignments – DSX-1 Port 1

TS01		TS02		TS03		TS04		TS05		TS06		TS07	
D		D		D		D		D		D		D	
TS08		TS09		TS10		TS11		TS12		TS13		TS14	
D		D		D		D		D		D		D	
TS15		TS16		TS17		TS18		TS19		TS20		TS21	
D		D		D		D		D		D		D	
TS22		TS23		TS24									
D		D		D									

Time Slot Assignments – DSX-1 Port 2

TS01		TS02		TS03		TS04		TS05		TS06		TS07	
D		D		D		D		D		D		D	
TS08		TS09		TS10		TS11		TS12		TS13		TS14	
D		D		D		D		D		D		D	
TS15		TS16		TS17		TS18		TS19		TS20		TS21	
D		D		D		D		D		D		D	
TS22		TS23		TS24									
D		D		D									

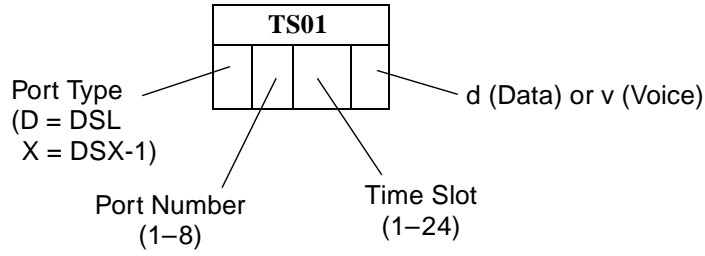

Time Slot Assignments – DSX-1 Port 3

TS01		TS02		TS03		TS04		TS05		TS06		TS07	
D		D		D		D		D		D		D	
TS08		TS09		TS10		TS11		TS12		TS13		TS14	
D		D		D		D		D		D		D	
TS15		TS16		TS17		TS18		TS19		TS20		TS21	
D		D		D		D		D		D		D	
TS22		TS23		TS24									
D		D		D									

Time Slot Assignments – DSX-1 Port 4

TS01		TS02		TS03		TS04		TS05		TS06		TS07	
D		D		D		D		D		D		D	
TS08		TS09		TS10		TS11		TS12		TS13		TS14	
D		D		D		D		D		D		D	
TS15		TS16		TS17		TS18		TS19		TS20		TS21	
D		D		D		D		D		D		D	
TS22		TS23		TS24									
D		D		D									

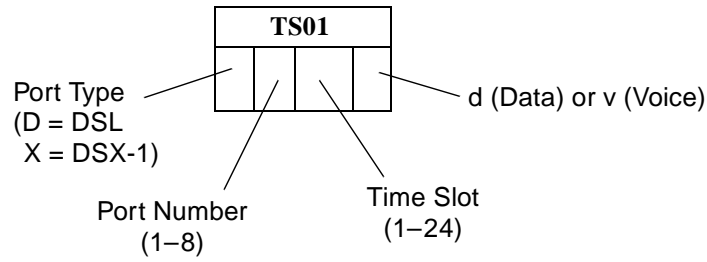

Time Slot Assignments – DSX-1 Port 5

TS01				TS02				TS03				TS04				TS05				TS06				TS07											
D				D				D				D				D				D				D				D							
TS08				TS09				TS10				TS11				TS12				TS13				TS14											
D				D				D				D				D				D				D				D							
TS15				TS16				TS17				TS18				TS19				TS20				TS21											
D				D				D				D				D				D				D				D							
TS22				TS23				TS24																											
D				D				D																											

Time Slot Assignments – DSX-1 Port 6

TS01				TS02				TS03				TS04				TS05				TS06				TS07											
D				D				D				D				D				D				D				D							
TS08				TS09				TS10				TS11				TS12				TS13				TS14											
D				D				D				D				D				D				D				D							
TS15				TS16				TS17				TS18				TS19				TS20				TS21											
D				D				D				D				D				D				D				D							
TS22				TS23				TS24																											
D				D				D																											

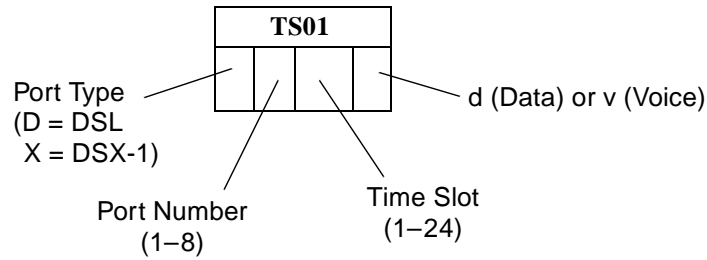

Time Slot Assignments – DSX-1 Port 7

TS01				TS02				TS03				TS04				TS05				TS06				TS07											
D				D				D				D				D				D				D				D							
TS08				TS09				TS10				TS11				TS12				TS13				TS14											
D				D				D				D				D				D				D				D							
TS15				TS16				TS17				TS18				TS19				TS20				TS21											
D				D				D				D				D				D				D				D							
TS22				TS23				TS24																											
D				D				D																											

Time Slot Assignments – DSX-1 Port 8

TS01				TS02				TS03				TS04				TS05				TS06				TS07											
D				D				D				D				D				D				D				D							
TS08				TS09				TS10				TS11				TS12				TS13				TS14											
D				D				D				D				D				D				D				D							
TS15				TS16				TS17				TS18				TS19				TS20				TS21											
D				D				D				D				D				D				D				D							
TS22				TS23				TS24																											
D				D				D																											

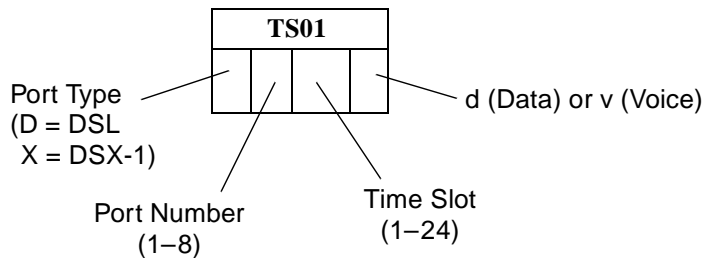

Time Slot Assignments – DSL Port 1

TS01				TS02				TS03				TS04				TS05				TS06				TS07											
X				X				X				X				X				X				X				X							
TS08				TS09				TS10				TS11				TS12				TS13				TS14											
X				X				X				X				X				X				X				X							
TS15				TS16				TS17				TS18				TS19				TS20				TS21											
X				X				X				X				X				X				X				X							
TS22				TS23				TS24																											
X				X				X																											

Time Slot Assignments – DSL Port 2

TS01				TS02				TS03				TS04				TS05				TS06				TS07											
X				X				X				X				X				X				X				X							
TS08				TS09				TS10				TS11				TS12				TS13				TS14											
X				X				X				X				X				X				X				X							
TS15				TS16				TS17				TS18				TS19				TS20				TS21											
X				X				X				X				X				X				X				X							
TS22				TS23				TS24																											
X				X				X																											

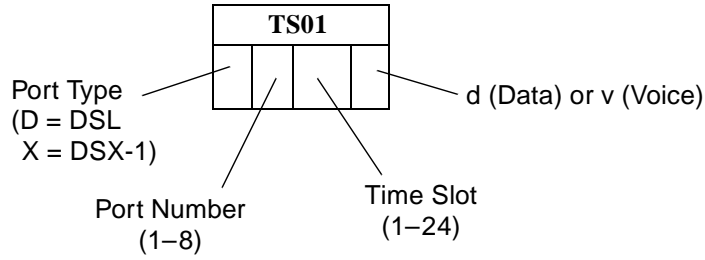

Time Slot Assignments – DSL Port 3

TS01				TS02				TS03				TS04				TS05				TS06				TS07											
X				X				X				X				X				X				X				X							
TS08				TS09				TS10				TS11				TS12				TS13				TS14											
X				X				X				X				X				X				X				X							
TS15				TS16				TS17				TS18				TS19				TS20				TS21											
X				X				X				X				X				X				X				X							
TS22				TS23				TS24																											
X				X				X																											

Time Slot Assignments – DSL Port 4

TS01				TS02				TS03				TS04				TS05				TS06				TS07											
X				X				X				X				X				X				X				X							
TS08				TS09				TS10				TS11				TS12				TS13				TS14											
X				X				X				X				X				X				X				X							
TS15				TS16				TS17				TS18				TS19				TS20				TS21											
X				X				X				X				X				X				X				X							
TS22				TS23				TS24																											
X				X				X																											

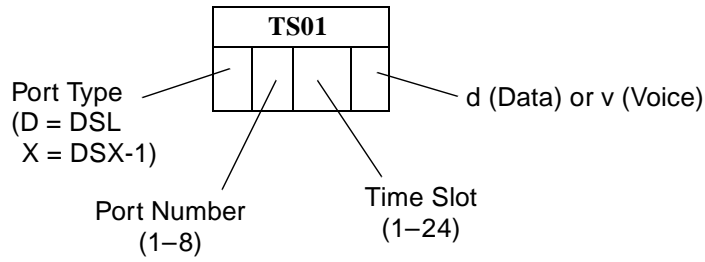

Time Slot Assignments – DSL Port 5

TS01				TS02				TS03				TS04				TS05				TS06				TS07											
X				X				X				X				X				X				X				X							
TS08				TS09				TS10				TS11				TS12				TS13				TS14											
X				X				X				X				X				X				X				X							
TS15				TS16				TS17				TS18				TS19				TS20				TS21											
X				X				X				X				X				X				X				X							
TS22				TS23				TS24																											
X				X				X																											

Time Slot Assignments – DSL Port 6

TS01				TS02				TS03				TS04				TS05				TS06				TS07											
X				X				X				X				X				X				X				X							
TS08				TS09				TS10				TS11				TS12				TS13				TS14											
X				X				X				X				X				X				X				X							
TS15				TS16				TS17				TS18				TS19				TS20				TS21											
X				X				X				X				X				X				X				X							
TS22				TS23				TS24																											
X				X				X																											

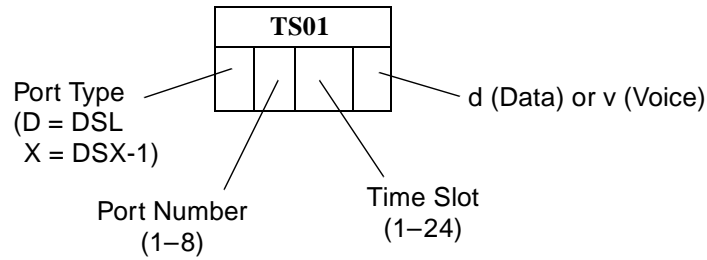

Time Slot Assignments – DSL Port 7

TS01				TS02				TS03				TS04				TS05				TS06				TS07											
X				X				X				X				X				X				X				X							
TS08				TS09				TS10				TS11				TS12				TS13				TS14											
X				X				X				X				X				X				X				X							
TS15				TS16				TS17				TS18				TS19				TS20				TS21											
X				X				X				X				X				X				X				X							
TS22				TS23				TS24																											
X				X				X																											

Time Slot Assignments – DSL Port 8

TS01				TS02				TS03				TS04				TS05				TS06				TS07											
X				X				X				X				X				X				X				X							
TS08				TS09				TS10				TS11				TS12				TS13				TS14											
X				X				X				X				X				X				X				X							
TS15				TS16				TS17				TS18				TS19				TS20				TS21											
X				X				X				X				X				X				X				X							
TS22				TS23				TS24																											
X				X				X																											

G.703 Time Slot Assignments

Fill in the port number and time slot cross-connection and data/voice mode for each time slot. Then transfer the entries to the Assign Time Slots screen.

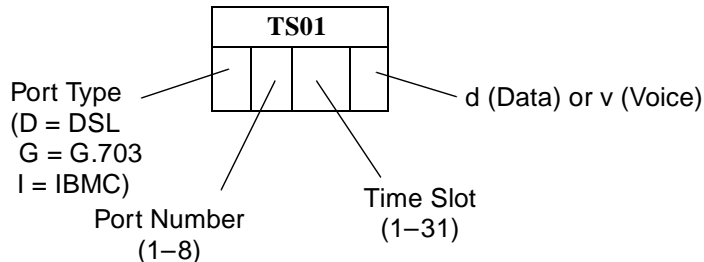

Time Slot Assignments – G.703 Port 1

TS01				TS02				TS03				TS04				TS05				TS06				TS07							
D				D				D				D				D				D				D				D			
TS08				TS09				TS10				TS11				TS12				TS13				TS14							
D				D				D				D				D				D				D				D			
TS15				TS16*				TS17				TS18				TS19				TS20				TS21							
D				D				D				D				D				D				D				D			
TS22				TS23				TS24				TS25				TS26				TS27				TS28							
D				D				D				D				D				D				D				D			
TS29				TS30				TS31																							
D				D				D																							

*** NOTE:**

When a G.703 port is configured for Channel Associated Signaling (CAS), Time Slot 16 is used for signaling and is unavailable for cross-connection.

When a G.703 port is configured for Common Channel Signaling (CCS) in a DS0 Cross Connect, the user must cross-connect Time Slot 16 and any associated time slots.

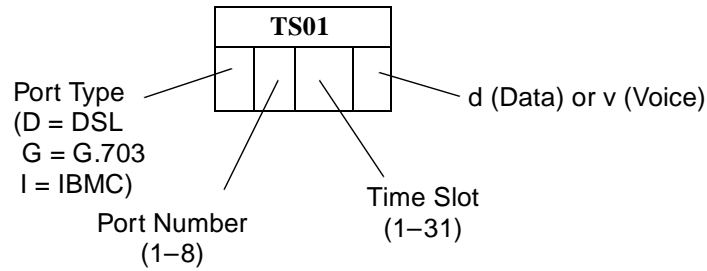

Time Slot Assignments – G.703 Port 2

TS01				TS02				TS03				TS04				TS05				TS06				TS07							
D				D				D				D				D				D				D				D			
TS08				TS09				TS10				TS11				TS12				TS13				TS14							
D				D				D				D				D				D				D				D			
TS15				TS16*				TS17				TS18				TS19				TS20				TS21							
D				D				D				D				D				D				D				D			
TS22				TS23				TS24				TS25				TS26				TS27				TS28							
D				D				D				D				D				D				D				D			
TS29				TS30				TS31																							
D				D				D																							

*** NOTE:**

When a G.703 port is configured for CAS, Time Slot 16 is used for signaling and is unavailable for cross-connection.

When a G.703 port is configured for CCS in a DS0 Cross Connect, the user must cross-connect Time Slot 16 and any associated time slots.

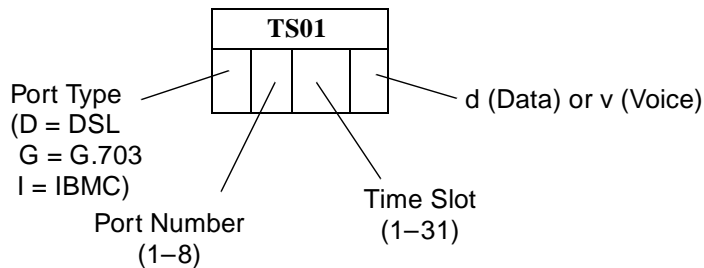

Time Slot Assignments – G.703 Port 3

TS01				TS02				TS03				TS04				TS05				TS06				TS07							
D				D				D				D				D				D				D				D			
TS08				TS09				TS10				TS11				TS12				TS13				TS14							
D				D				D				D				D				D				D				D			
TS15				TS16*				TS17				TS18				TS19				TS20				TS21							
D				D				D				D				D				D				D				D			
TS22				TS23				TS24				TS25				TS26				TS27				TS28							
D				D				D				D				D				D				D				D			
TS29				TS30				TS31																							
D				D				D																							

*** NOTE:**

When a G.703 port is configured for CAS, Time Slot 16 is used for signaling and is unavailable for cross-connection.

When a G.703 port is configured for CCS in a DS0 Cross Connect, the user must cross-connect Time Slot 16 and any associated time slots.

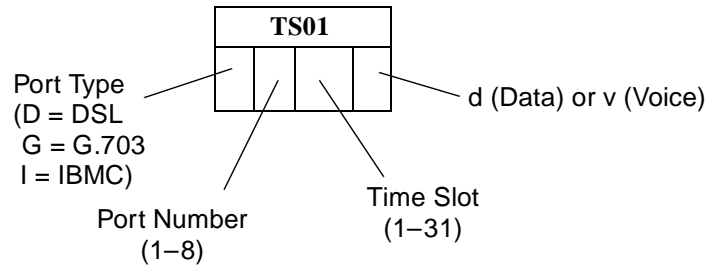

Time Slot Assignments – G.703 Port 4

TS01				TS02				TS03				TS04				TS05				TS06				TS07							
D				D				D				D				D				D				D				D			
TS08				TS09				TS10				TS11				TS12				TS13				TS14							
D				D				D				D				D				D				D				D			
TS15				TS16*				TS17				TS18				TS19				TS20				TS21							
D				D				D				D				D				D				D				D			
TS22				TS23				TS24				TS25				TS26				TS27				TS28							
D				D				D				D				D				D				D				D			
TS29				TS30				TS31																							
D				D				D																							

*** NOTE:**

When a G.703 port is configured for CAS, Time Slot 16 is used for signaling and is unavailable for cross-connection.

When a G.703 port is configured for CCS in a DS0 Cross Connect, the user must cross-connect Time Slot 16 and any associated time slots.

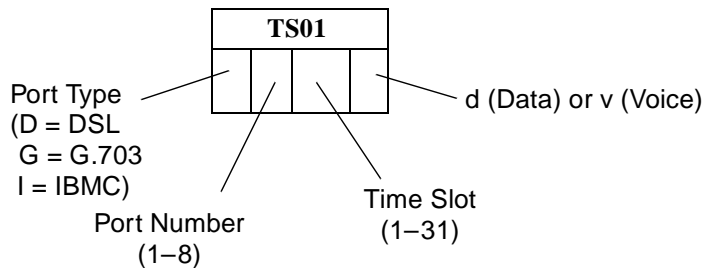

Time Slot Assignments – G.703 Port 5

TS01				TS02				TS03				TS04				TS05				TS06				TS07							
D				D				D				D				D				D				D				D			
TS08				TS09				TS10				TS11				TS12				TS13				TS14							
D				D				D				D				D				D				D				D			
TS15				TS16*				TS17				TS18				TS19				TS20				TS21							
D				D				D				D				D				D				D				D			
TS22				TS23				TS24				TS25				TS26				TS27				TS28							
D				D				D				D				D				D				D				D			
TS29				TS30				TS31																							
D				D				D																							

*** NOTE:**

When a G.703 port is configured for CAS, Time Slot 16 is used for signaling and is unavailable for cross-connection.

When a G.703 port is configured for CCS in a DS0 Cross Connect, the user must cross-connect Time Slot 16 and any associated time slots.

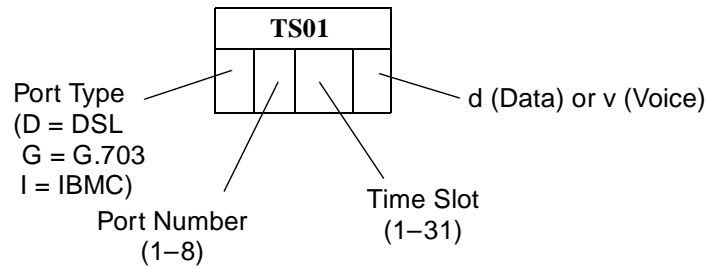

Time Slot Assignments – G.703 Port 6

TS01				TS02				TS03				TS04				TS05				TS06				TS07							
D				D				D				D				D				D				D				D			
TS08				TS09				TS10				TS11				TS12				TS13				TS14							
D				D				D				D				D				D				D				D			
TS15				TS16*				TS17				TS18				TS19				TS20				TS21							
D				D				D				D				D				D				D				D			
TS22				TS23				TS24				TS25				TS26				TS27				TS28							
D				D				D				D				D				D				D				D			
TS29				TS30				TS31																							
D				D				D																							

*** NOTE:**

When a G.703 port is configured for CAS, Time Slot 16 is used for signaling and is unavailable for cross-connection.

When a G.703 port is configured for CCS in a DS0 Cross Connect, the user must cross-connect Time Slot 16 and any associated time slots.

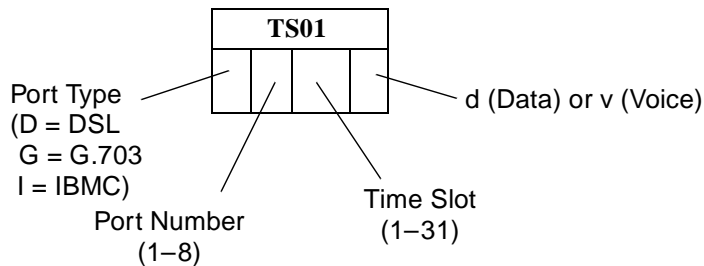

Time Slot Assignments – G.703 Port 7

TS01				TS02				TS03				TS04				TS05				TS06				TS07							
D				D				D				D				D				D				D				D			
TS08				TS09				TS10				TS11				TS12				TS13				TS14							
D				D				D				D				D				D				D				D			
TS15				TS16*				TS17				TS18				TS19				TS20				TS21							
D				D				D				D				D				D				D				D			
TS22				TS23				TS24				TS25				TS26				TS27				TS28							
D				D				D				D				D				D				D				D			
TS29				TS30				TS31																							
D				D				D																							

*** NOTE:**

When a G.703 port is configured for CAS, Time Slot 16 is used for signaling and is unavailable for cross-connection.

When a G.703 port is configured for CCS in a DS0 Cross Connect, the user must cross-connect Time Slot 16 and any associated time slots.

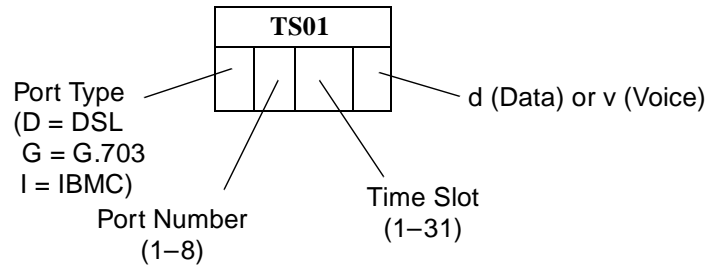

Time Slot Assignments – G.703 Port 8

TS01				TS02				TS03				TS04				TS05				TS06				TS07							
D				D				D				D				D				D				D				D			
TS08				TS09				TS10				TS11				TS12				TS13				TS14							
D				D				D				D				D				D				D				D			
TS15				TS16*				TS17				TS18				TS19				TS20				TS21							
D				D				D				D				D				D				D				D			
TS22				TS23				TS24				TS25				TS26				TS27				TS28							
D				D				D				D				D				D				D				D			
TS29				TS30				TS31																							
D				D				D																							

*** NOTE:**

When a G.703 port is configured for CAS, Time Slot 16 is used for signaling and is unavailable for cross-connection.

When a G.703 port is configured for CCS in a DS0 Cross Connect, the user must cross-connect Time Slot 16 and any associated time slots.

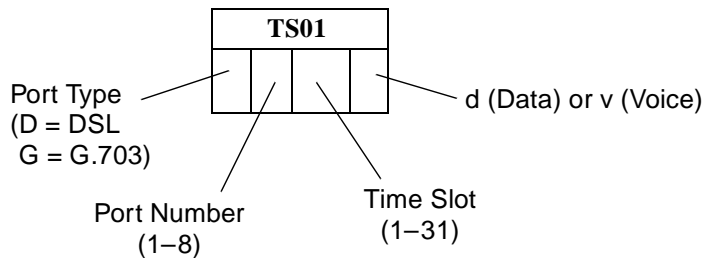

Time Slot Assignments – DSL Port 1

TS01				TS02				TS03				TS04				TS05				TS06				TS07							
G				G				G				G				G				G				G				G			
TS08				TS09				TS10				TS11				TS12				TS13				TS14							
G				G				G				G				G				G				G				G			
TS15				TS16				TS17				TS18				TS19				TS20				TS21							
G				G				G				G				G				G				G				G			
TS22				TS23				TS24				TS25				TS26				TS27				TS28							
G				G				G				G				G				G				G				G			
TS29				TS30				TS31																							
G				G				G																							

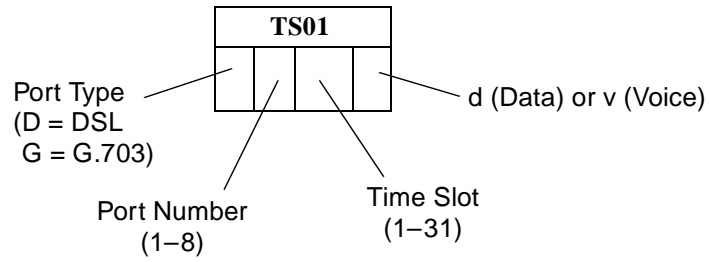

Time Slot Assignments – DSL Port 2

TS01				TS02				TS03				TS04				TS05				TS06				TS07							
G				G				G				G				G				G				G				G			
TS08				TS09				TS10				TS11				TS12				TS13				TS14							
G				G				G				G				G				G				G				G			
TS15				TS16				TS17				TS18				TS19				TS20				TS21							
G				G				G				G				G				G				G				G			
TS22				TS23				TS24				TS25				TS26				TS27				TS28							
G				G				G				G				G				G				G				G			
TS29				TS30				TS31																							
G				G				G																							

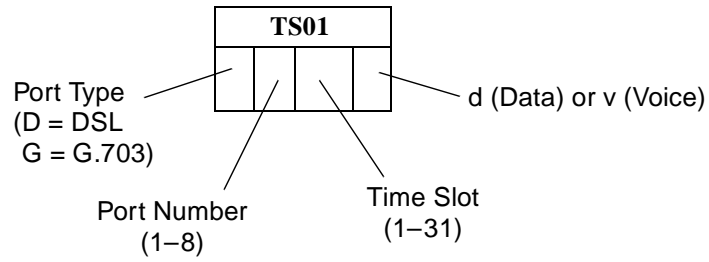

Time Slot Assignments – DSL Port 3

TS01				TS02				TS03				TS04				TS05				TS06				TS07							
G				G				G				G				G				G				G				G			
TS08				TS09				TS10				TS11				TS12				TS13				TS14							
G				G				G				G				G				G				G				G			
TS15				TS16				TS17				TS18				TS19				TS20				TS21							
G				G				G				G				G				G				G				G			
TS22				TS23				TS24				TS25				TS26				TS27				TS28							
G				G				G				G				G				G				G				G			
TS29				TS30				TS31																							
G				G				G																							

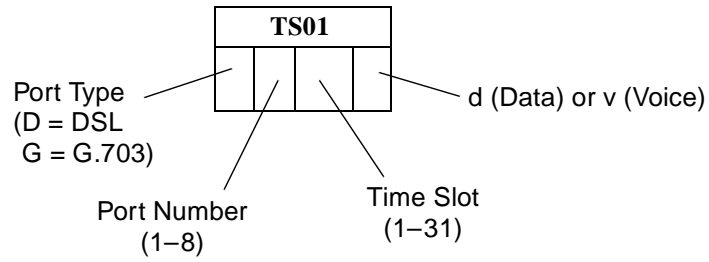

Time Slot Assignments – DSL Port 4

TS01				TS02				TS03				TS04				TS05				TS06				TS07							
G				G				G				G				G				G				G				G			
TS08				TS09				TS10				TS11				TS12				TS13				TS14							
G				G				G				G				G				G				G				G			
TS15				TS16				TS17				TS18				TS19				TS20				TS21							
G				G				G				G				G				G				G				G			
TS22				TS23				TS24				TS25				TS26				TS27				TS28							
G				G				G				G				G				G				G				G			
TS29				TS30				TS31																							
G				G				G																							

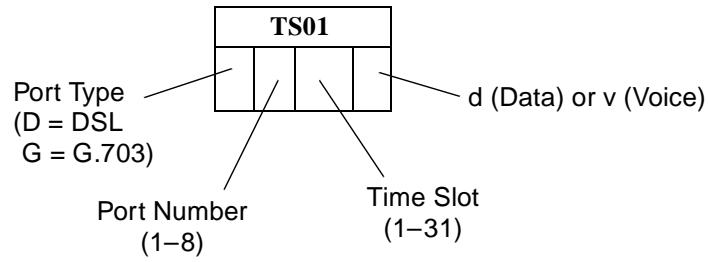

Time Slot Assignments – DSL Port 5

TS01				TS02				TS03				TS04				TS05				TS06				TS07							
G				G				G				G				G				G				G				G			
TS08				TS09				TS10				TS11				TS12				TS13				TS14							
G				G				G				G				G				G				G				G			
TS15				TS16				TS17				TS18				TS19				TS20				TS21							
G				G				G				G				G				G				G				G			
TS22				TS23				TS24				TS25				TS26				TS27				TS28							
G				G				G				G				G				G				G				G			
TS29				TS30				TS31																							
G				G				G																							

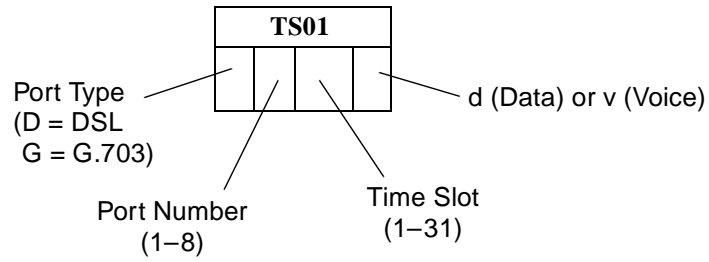

Time Slot Assignments – DSL Port 6

TS01		TS02		TS03		TS04		TS05		TS06		TS07	
G		G		G		G		G		G		G	
TS08		TS09		TS10		TS11		TS12		TS13		TS14	
G		G		G		G		G		G		G	
TS15		TS16		TS17		TS18		TS19		TS20		TS21	
G		G		G		G		G		G		G	
TS22		TS23		TS24		TS25		TS26		TS27		TS28	
G		G		G		G		G		G		G	
TS29		TS30		TS31									
G		G		G									

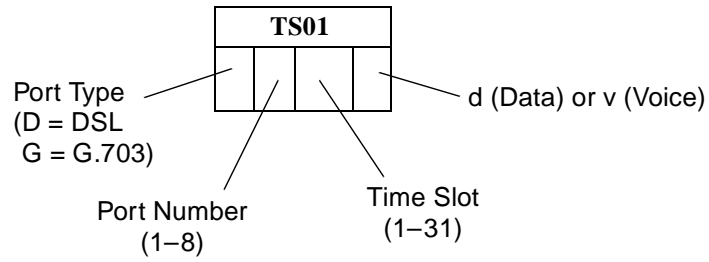

Time Slot Assignments – DSL Port 7

TS01				TS02				TS03				TS04				TS05				TS06				TS07							
G				G				G				G				G				G				G				G			
TS08				TS09				TS10				TS11				TS12				TS13				TS14							
G				G				G				G				G				G				G				G			
TS15				TS16				TS17				TS18				TS19				TS20				TS21							
G				G				G				G				G				G				G				G			
TS22				TS23				TS24				TS25				TS26				TS27				TS28							
G				G				G				G				G				G				G				G			
TS29				TS30				TS31																							
G				G				G																							

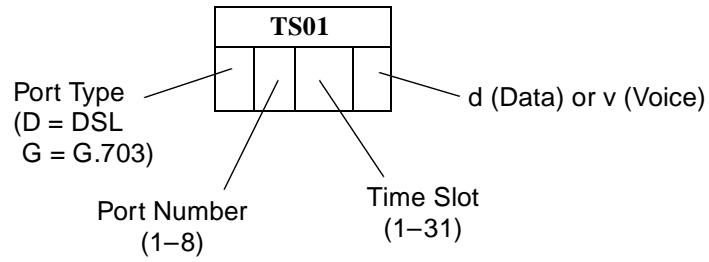

Time Slot Assignments – DSL Port 8

TS01				TS02				TS03				TS04				TS05				TS06				TS07							
G				G				G				G				G				G				G				G			
TS08				TS09				TS10				TS11				TS12				TS13				TS14							
G				G				G				G				G				G				G				G			
TS15				TS16				TS17				TS18				TS19				TS20				TS21							
G				G				G				G				G				G				G				G			
TS22				TS23				TS24				TS25				TS26				TS27				TS28							
G				G				G				G				G				G				G				G			
TS29				TS30				TS31																							
G				G				G																							

Index

A

- Abort All Tests, 8-1
- access
 - SNMP, 6-5
 - to asynchronous terminal interface, 2-3
- access level
 - effective, 6-2
 - functions available for, 6-2
- administer login, 6-2
- AIS (Alarm Indication Signal), status message, 7-3
- Alarm LED, 7-24
- ASCII, printable characters, 3-2
- Assign Time Slots, A-24
- ATI (Asynchronous Terminal Interface)
 - access, 2-1
 - defined, 1-2
 - exiting, 2-9
 - initiating session, 2-2
 - virtual function keys, 2-7
- Attenuation, Transmit, A-4
- authenticationFailure, B-2
- AutoRate
 - ceiling, A-3
 - disabling, 3-11
 - Network Interface Options screen, A-3
 - resetting, 3-11

C

- Card Failed
 - self-test result, 7-7
 - status message, 7-3
- Change Identity, 3-2
- Circuit Identifier, A-5
- Clear_All
 - time slots, A-25
- Clock Failed, status message, 7-6
- clocking
 - DSX-1 clock source, A-8
 - examples, A-16
 - G.703 clock source, A-11
 - System Clock configuration options, A-15
 - system clock references, A-18
- community names
 - for SNMP, 6-5
 - General SNMP Management Options, A-31

- Configuration
 - SNMP
 - Traps Options, A-37
 - configuration
 - AutoRate, 3-11
 - Copy Ports Options, A-12
 - Cross Connect, A-19
 - DSX-1 Interface Options, A-5, A-7
 - editing and displaying options, 3-5
 - example of network, 1-3
 - G.703 Interface Options, A-9
 - General SNMP Management Options, A-30
 - loader, 9-4
 - menu, 3-4
 - Network Interface Options, A-2
 - option tables, A-1
 - saving changes, 3-7
 - SNMP
 - Management, A-30
 - Traps Options, A-34
 - System
 - Clock, A-15
 - Options, A-13
 - Telnet Session Options, A-28
- connectors
 - front panel, C-1
 - Telco 50-pin for DSL loops and POTS splitters, C-3
- Control branch
 - Administer Logins, 6-2
 - Change Identity, 3-2
 - Download Code, 9-1
 - PORTS LEDs, 7-25
 - Reset AutoRate, 3-11
 - Reset Device, 3-10
- CPU
 - CPLD Fail, self-test result, 7-7
 - Fail, self-test result, 7-7
- create login ID, 6-2
- Cross-Connect Configuration Options, A-19
 - Cross-Connect Mode, A-22–A-23
 - Data/Voice Selection, A-27
 - DSL/DTE selection, A-26
 - Port Number, A-26
 - Port Type, A-26–A-27
 - Time Slot Number, A-27

cross-connection
 example, 4-2
 procedures, 4-1
customer configuration areas, 3-3

D

Data Path Failure, self-test result, 7-7
data/voice time slot assignment, A-27
default configuration area, 3-3
delete login ID, 6-4
Destination, A-23
device
 messages, 7-10
 name, 3-2
 reset, 3-10
dimensions, D-1
Disconnect Time for Telnet session, A-29
documents, related, vi
DOS, TFTP server on, 3-7, 9-4
Download
 configuration, 9-4
 Failed status message, 7-3
 firmware, 9-1
DSL
 Framer x Fail, self-test result, 7-7
 line rate
 AutoRate ceiling, A-3
 Network Interface option, A-3
 Port, A-22
 LEDs, 7-24
DSL Line Rate
 and payload rate, A-6
 Fixed Rate, A-6
DSLAM
 defined, 1-2
 exiting from session, 2-9
 login, 2-2
DSX-1
 Failed, self-test result, 7-7
 Interface Options, A-7
 Excessive Error Rate Threshold, A-8
 Line Coding, A-7
 Line Equalization, A-8
 Line Framing, A-8
 Port Status, A-7
 Primary Clock Source, A-8
 port LEDs, 7-24
DTE
 Framer x Fail, self-test result, 7-7
 LIU x Fail, self-test message, 7-7
 LIU x Fail, self-test result, 7-7
 loopback, 8-6

E

EER (Excessive Error Rate)
 status message, 7-3
effective access level, 6-2
EIA-530 Payload Rate, A-4
ending an ATI session, 2-9
Enterprise
 SNMP traps, B-4
 Specific Traps, A-36
environment requirements, D-1
error
 messages, line 24, 7-10
 statistics, 7-12
Excessive Error Rate (EER) Threshold
 DSL network, A-3
 DSX-1, A-8

F

factory defaults, 3-3
Failure
 self-test result, 7-7
features, 1-2
firmware download from server, 9-1
FPGA Failed, self-test result, 7-8
framing
 DS0 Cross Connect, A-5
 DSX-1, A-8
 G.703, A-10
function keys, 2-7

G

G.703
 Failed, self-test result, 7-8
 interface impedance, A-14
 Interface Option settings, A-9
 Line Coding, A-10
 Line Framing, A-10
 Primary Clock Source, A-11
 Time Slot 16, A-10
 Line Termination, A-14
General Traps, A-36

H

health and status messages, 7-3

I

identity, 3-2
impedance, A-14
inactivity timeout
 for Telnet session, A-29

Inband Management Channel (IBMC)

- Options, A-37
- status messages, 7-4

Inband Management Statistics, 7-20

intended audience, v

IP address

- example, 5-2
- selecting, 5-1
- SNMP manager, 6-5

K

keyboard functions, 2-6

L

lamp test, 8-9

LEDs

- front panel, 7-24
- testing, 8-9
- viewing through the ATI, 7-22

Line

- Coding, A-10
 - DSX-1, A-7
- Equalization, A-8
- Framing
 - DS0 Cross Connect, A-5
 - DSX-1, A-8
 - G.703, A-10
- Loopback, 8-4

Link Up LEDs, 7-24

link-layer protocols, 5-1

linkUp and linkDown traps, B-2

loading firmware, 9-4

local line loopback (LLB), 8-4

LOF (Loss Of Frame) status message, 7-4

login

- DSLAM, 2-2
- login ID, 6-1
 - access levels, 6-2
 - adding, 6-2
 - deleting, 6-4

loopback

- DTE Loopback, 8-6
- effect on LEDs, 7-24
- Network Line Loopback, 8-4
- Remote Send Line Loopback, 8-7
- Repeater Loopback, 8-5
- Telco-initiated, 8-11

LOS (Loss Of Signal) status message, 7-4–7-5

M

main menu, 2-2

Management

- and Communication Options, A-28
- port access, 6-1
- port settings, 2-1

Margin Threshold, A-2

Max DSL AutoRate, A-3

MCC, defined, 1-2

MCP FFS, 3-7, 9-4

Memory Test n Fail, self-test result, 7-8

messages

- health and status, 7-3
- line 24, 7-10
- self-test results, 7-7
- test status, 7-9

MIB

- list of supported MIBs, 1-4
- support, 1-4

Monitor and Send 511 pattern, 8-8

monitoring, 7-1

N

navigating the screens, 2-6

Net Margin Threshold

- status message, 7-5

Network

- Interface Options, A-2
 - AutoRate, A-3
 - Circuit Identifier, A-5
 - DS0 Cross Connect Line Framing, A-5
 - Excessive Error Rate Threshold, A-3
 - Margin Threshold, A-2
 - Port Status, A-2
 - Transmit Attenuation, A-4
- Line Loopback, 8-4
- tests, 8-2

NMS

- IP address, A-33
- Number of Trap Managers, A-35
- SNMP access, 6-5
- SNMP connectivity, 5-1

No Test Active, status message, 7-9

O

OK LED, 7-24

OOF (Out Of Frame), status message, 7-5

options, configuration tables, A-1

overview

- device features, 1-2
- user's guide, v

P

- Passed, self-test result, 7-8
- pattern test, 8-8
- payload rate
 - EIA-530, A-4
- Payload Rate Mismatch status message, 7-5
- performance statistics, 7-13, 7-19
 - DSX-1, 7-15
 - G.703, 7-17
 - Inband Management, 7-20
- physical environment requirements, D-1
- pin assignments
 - front panel, C-1
 - Telco 50-pin, C-3
- PLD Failure, self-test result, 7-8
- Port
 - DSL, A-22
 - Status, A-2, A-7, A-9
- PORTS LEDs
 - switching between DSL and DTE, 7-25
- power requirements, D-1
- Primary Clock
 - Failed status message, 7-6
 - Source
 - DSX-1, A-8
 - G.703, A-11
- Primary System Clock
 - Failed status message, 7-6
 - Reference, A-18

R

- related documents, vi
- remote send line loopback, 8-7
- repeater loopback (RLB), 8-5
- reset
 - ATI, 3-10
 - AutoRate, 3-11
 - device, 3-10
 - slot, 3-10
- restore access to ATI, 3-10

S

- Save Configuration screen, 3-9
- saving configuration option changes, 3-7
 - to TFTP server, 9-4
- screen, function keys, 2-7
- screens for user interface, 2-1
- SDSL Mode, A-13
- Secondary
 - holdover mode, A-16
 - System Clock failure, A-16
 - System Clock Reference, A-18

- security, 6-1
- self-test results, 7-7
- Send
 - and Monitor 511, 8-9
 - Remote Line Loopback, 8-7
- Set Cross Connect Mode, A-20
- size of card, D-1
- SNMP
 - enable/disable traps, A-35
 - Enterprise Specific Traps, A-36
 - general management capabilities, 1-4
 - limiting management access, 6-5
 - Link Trap Interfaces, A-36
 - Link Traps, A-36
 - NMS IP Address, A-33
 - Number of Trap Managers, A-35
 - system entries, 3-2
 - trap
 - manager IP Address, A-35
 - NMS destination, A-35
 - Traps, B-1
 - Options, A-34
- Source, A-23
- start-up, ATI, 2-1
- Status menu
 - Performance Statistics
 - Inband Management, 7-20
- status, test messages, 7-9
- System
 - Clock options, A-15
 - device name fields, 3-2
 - LEDs, 7-24
- System Options
 - DSL Mode, A-13
 - Telco-Initiated Loopback, A-14
 - Test Duration, A-14
 - Test Timeout, A-13

T

- Telco-initiated
 - line loopback, 8-11
 - loopback, disabling, A-14
 - payload loopback, 8-11
 - remote line loopback, 8-12
- Telnet session
 - access, 6-1
 - access level, A-29
 - Disconnect Time (Minutes), A-29
 - enable/disable, A-29
 - inactivity timeout, A-29
 - login required, A-29
 - options, A-28
 - Session Access Level, A-29

terminal port, direct connection, 2-1

test

- aborting, 8-10

- Device Tests, A-39

- DTE Loopback, 8-6

- LED, 7-24

- menu, 8-2

- Network Line Loopback, 8-4

- pattern, 8-8

- procedures, 8-1

- Remote Send Line Loopback, 8-7

- Repeater Loopback, 8-5

- Send and Monitor 511, 8-8–8-9

- status messages, 7-9

- stopping a, 8-10

- Telco-initiated, 8-11, A-14

- terminating, 8-10

- Test Duration, A-14

- Test Timeout, A-13

Time Slot 16, A-10

timeout

- Telnet session inactivity, A-29

- Test, A-13

timing

- DSX-1 clock source, A-8

- examples, A-16

- G.703 clock source, A-11

- System Clock

 - configuration options, A-15

 - references, A-18

Transmit Attenuation, A-4

traps, SNMP, B-1–B-2

troubleshooting, 7-25

- DSX-1 performance statistics, 7-15

- error statistics, 7-12

- G.703 performance statistics, 7-17

- Health and Status messages, 7-3

- Inband Management Statistics, 7-20

- performance statistics, 7-13, 7-19

TSI

- CPLD Fail, self-test result, 7-8

- Fail, self-test result, 7-8

U

UNIX, TFTP server on, 3-7, 9-4

upload configuration, 9-4

user interface

- access, 3-10

- asynchronous terminal, 2-1

- how to access, 2-1

V

virtual function keys, 2-7

voice/data time slot assignment, A-27

W

warmStart, B-2

weight, D-1

Free Manuals Download Website

<http://myh66.com>

<http://usermanuals.us>

<http://www.somanuals.com>

<http://www.4manuals.cc>

<http://www.manual-lib.com>

<http://www.404manual.com>

<http://www.luxmanual.com>

<http://aubethermostatmanual.com>

Golf course search by state

<http://golfingnear.com>

Email search by domain

<http://emailbydomain.com>

Auto manuals search

<http://auto.somanuals.com>

TV manuals search

<http://tv.somanuals.com>