



**A 51 Amplifier**  
Owner's Guide

# THANK YOU!

## ***Congratulations and Thank You for Choosing Parasound***

Your new Parasound Halo Series A 51 power amplifier presents the latest advancements in amplifier technology. The A 51 is built to the strict quality and performance standards set by Parasound. We're proud to offer you this exceptional audio component that will bring you many years of enjoyment and dependability.

Here at Parasound, we design our products to perform at a higher level of flexibility and sonic performance than you may have expected. We encourage you to read this entire manual to learn all the features and capabilities of your new Halo Series A 51 Amplifier.

If you're eager to get up and running right away, simply follow the basic step-by-step instructions to connect and operate the A 51. If you want to learn about some of the technical and design aspects of your A 51, refer to the Technically Speaking and Parasound A 51 Design Overview sections in the back of the manual. If you run into difficulties, the Troubleshooting Guide should help you quickly remedy the problem.

We appreciate you taking the time to read these instructions and thank you for selecting Parasound for your listening pleasure.

***The Parasound Staff***

## ***Unpacking Your A 51***

Unpack your A 51 from the shipping carton, remove the enclosed rack mount brackets, banana plugs for your speaker wires, AC power cord, and the control wire with a small plug at each end. (This is the trigger connection wire). While you are unpacking your new amplifier, inspect it thoroughly for possible shipping damage. If you see any, contact your Parasound dealer right away. Be sure to save and store both the inner and outer cartons and the packing inserts for possible future transport. To save room for storage, you can cut the seams on the bottom of the cartons and flatten them.

## ***Keeping Records for Future Reference***

Record the serial number located on the bottom of your A 51 in the space below. Also note your Parasound Dealer's name and phone number. We recommend that you keep your purchase receipt with this manual and store them both in a safe place. You may need to refer to this information sometime in the future.

Parasound A 51 Amplifier Serial #: \_\_\_\_\_

Parasound Dealer: \_\_\_\_\_

Phone Number: \_\_\_\_\_

Date of Purchase: \_\_\_\_\_

### ***YOU SHOULD KNOW***

There is no Parasound warranty for this unit if it was not purchased from an Authorized Parasound Dealer. Investigate any warranty claims made by unauthorized dealers very carefully as you will need to depend entirely upon the dealer, and NOT upon Parasound. Unauthorized dealers may lack the capability to arrange repairs of Parasound equipment. Authorized Parasound Dealers are listed at **www.parasound.com** or you can call **415-397-7100** between 8:30 am and 4:30 pm Pacific time.

A missing or tampered serial number could indicate that this unit was stolen or sold by an unauthorized dealer. If this unit is missing its serial number, you should return it to your dealer immediately for a full refund.

# **TABLE OF CONTENTS**

## **A 51 Amplifier**

<b>PLACEMENT GUIDELINES FOR YOUR A 51</b>	<b>2</b>
<b>CONNECTING A SURROUND CONTROLLER TO THE BALANCED INPUTS ON YOUR A 51</b>	<b>3</b>
<b>CONNECTING A SURROUND CONTROLLER TO THE UNBALANCED INPUTS ON YOUR A 51</b>	<b>4</b>
<b>CONNECTING YOUR SPEAKERS TO THE A 51</b>	<b>5</b>
<b>MANUAL AND AUTOMATIC TURN ON-OFF OPTIONS</b>	<b>6</b>
<b>CONNECTING AN EXTERNAL DC SOURCE FOR AUTOMATIC ON-OFF</b>	<b>7</b>
<b>UNDERSTANDING THE INDICATORS ON THE A 51</b>	<b>8</b>
<b>CONNECTING THE AC POWER CORD</b>	<b>9</b>
<b>MAINTAINING YOUR A 51</b>	<b>10</b>
<b>TROUBLESHOOTING GUIDE</b>	<b>11</b>
<b>SERVICING YOUR A 51</b>	<b>12</b>
<b>TECHNICALLY SPEAKING</b>	<b>13</b>
<b>PARASOUND A 51 DESIGN OVERVIEW</b>	<b>15</b>
<b>PARASOUND A 51 SPECIFICATIONS</b>	<b>17</b>

**Power amplifiers are usually heavier and generate more heat than other components. To avoid damage to the A 51 or other equipment and to reduce risk of fire, you must follow these guidelines:**

- A cable with a 2.5 mm sub-mini plug on each end (provided).
- Place the A 51 on a separate shelf that will adequately support its weight.
- Keep it away from heat sources such as air ducts or radiators.
- Avoid placing it on carpeting or another material that might obstruct airflow into the openings in the chassis bottom.
- Leave at least 3" of space around both sides and 6" of space above the top. The bottom clearance can be a little less.
- Do not block the front of the A 51 behind closed cabinet doors during use.
- Do not stack the A 51 with other components inside a cabinet unless you use a fan to circulate and exhaust the warm air that builds up between them.

### **Rack Mounting Your Parasound A 51**

To mount the A 51 into a 19" wide equipment rack, you must first attach its rack mount brackets (provided). With its four feet removed, the A 51 chassis and front panel height occupies four rack spaces (7" or 176 mm). When mounting equipment below the A 51, you will also need to allow about  $\frac{1}{8}$ " below the unit for the bottom chassis screws. A single standard rack space allows  $1\frac{3}{4}$ " vertical height in a 19" wide equipment rack. This measurement standard was developed by the EIA (Electronic Industries Association) so manufacturers of electronic components and equipment racks could build products in standardized heights that would fit in a uniform space. Please call your Parasound dealer or Parasound Technical Services if you need additional advice about rack mounting the A 51.

### **To attach the rack mount brackets:**

- Remove the three screws from each side of the A 51. These are arranged vertically, behind its front panel and in front of its first heatsink fin.
- Line up the three holes on each bracket with the three holes on the A 51 and reinsert the screws.
- Make sure the screws are tight because they will support the entire weight of the A 51 in the equipment rack.

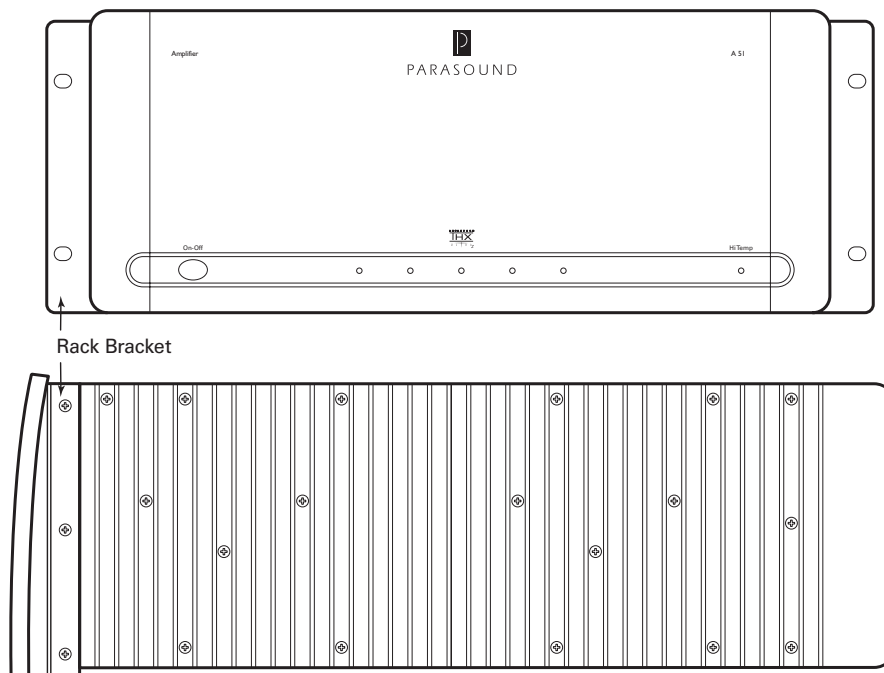

# CONNECTING A SURROUND CONTROLLER TO THE BALANCED INPUTS ON YOUR A 51

## Left and Right Balanced Input Jacks

Balanced connections will give you the best sound. If your surround controller has balanced XLR output jacks, we recommend that you connect them to these inputs. Refer to the Balanced and Unbalanced Lines in the Technically Speaking section for additional information about why we recommend using balanced lines.

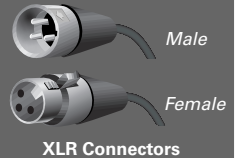

**What You'll Need:**

- Five balanced interconnect cables with XLR connectors
- A surround controller with balanced output connectors

## Before Connecting

- Leave the A 51's AC cord disconnected until you have made all other connections to prevent any surprise burst of sound.
- Make sure that all your cables are long enough so they are not strained or stretched once they are connected.
- Make sure the **Balanced - Unbalanced Input** Select switch on the rear of the A 51 is in its **Balanced** (left) position and the **Ground** switch is in its **Normal** (down) position.

## To Connect

- Plug the male end of the first balanced interconnect cable into the **Balanced Ch 1 input** jack on the A 51.
- Plug the female end of the cable into the balanced output jack for the channel on your surround controller that you wish to correspond to Ch 1 on your A 51.
- - 0 Repeat steps 1 and 2 above to connect **Ch 2, Ch 3, Ch 4, and Ch 5**.

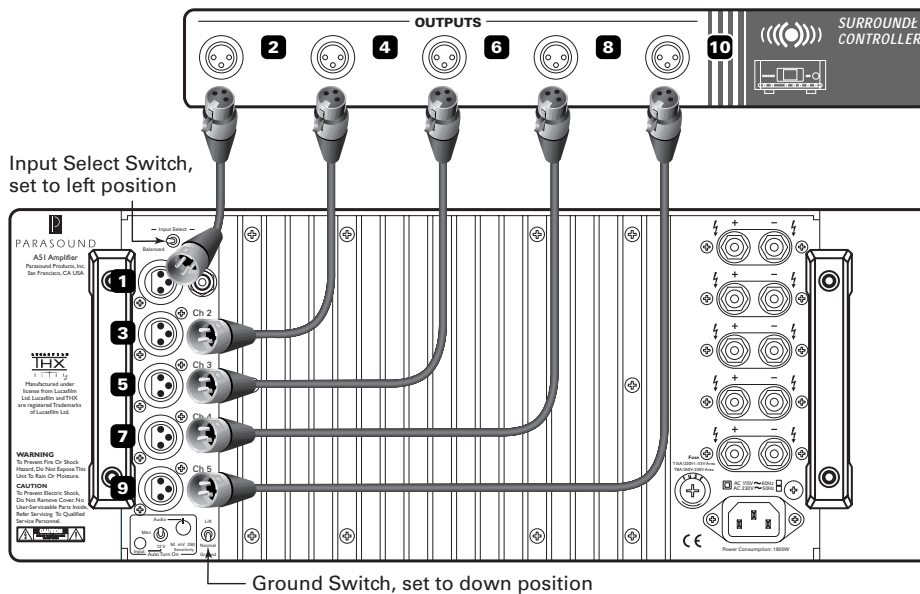

## YOU SHOULD KNOW

### Balanced XLR Jacks and Their Pin Configuration

The balanced inputs of the A 51 use XLR jacks that conform to the industry standard of: Pin 1: Ground, Pin 2: Positive (+), Pin 3: Negative (--). The balanced outputs on some components use terminals with 3 screws instead of XLR jacks. These are compatible with the A 51 as long as you match the bare wires to the corresponding pins on the XLR plug: + to pin 2, - to pin 3, and Ground to pin 1.

# CONNECTING A SURROUND CONTROLLER TO THE UNBALANCED INPUTS ON YOUR A 51

## Ch 1-5 Unbalanced Inputs

Use these inputs if your surround controller doesn't have balanced output connectors or if you simply prefer to use unbalanced connections.



### What You'll Need:

- Five shielded interconnect cables with RCA plugs
- A surround controller with five RCA output jacks

## Before Connecting

- Leave the AC cord on the A 51 disconnected until you have made all other connections to prevent any surprise burst of sound.
- Make sure that all your cables are long enough so they are not pulled or stretched once they are connected.
- Make sure the Balanced-Unbalanced Input Select switch on the A 51 is in its Unbalanced (right) position and the Ground switch is in its Normal (down) position.

## To Connect

- 1 Plug one end of the cable into the **Unbalanced Ch 1 Input jack** on the A 51.
- 2 Plug the other end of the cable into the unbalanced output jack for the channel on your surround controller that you wish to correspond to Ch 1 on your A 51.
- 3 - 5 Repeat steps 1 and 2 for **Ch 2, Ch 3, Ch 4, and Ch 5**.

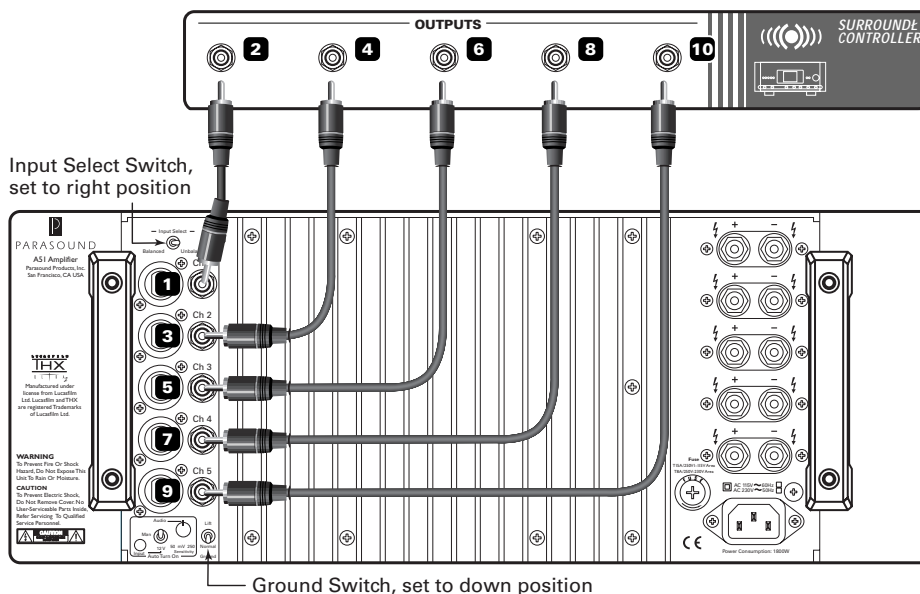

## YOU SHOULD KNOW

### Write Down Your Connections

Make a note of which channel on your surround controller now connects to each channel of the A 51 so you'll always hear the channels in their intended position and to facilitate trouble-shooting in case you encounter a problem later on.

## Speaker Terminals

The A 51 speaker terminals accept speaker wires with banana plugs or bare ends. Refer to Bare Wire Speaker Termination in the **Technically Speaking** section for information about bare wire termination.

**Common Speaker Connectors**



Dual Banana Plug      Single Banana Plug      Stripped AWG wire

**What You'll Need:**

- Five lengths of AWG 16 or thicker speaker wire with banana plugs or bare ends
- Five loudspeakers

## Before Connecting

- ❑ Remove power to all the components in your audio system.

## To Connect

Because the speaker terminals are very close to each other, the bare wire ends insert diagonally into the terminal shafts. The - (negative) wires enter the black - terminals at 8 o'clock. The + (wires) enter the red + terminals at 4 o'clock. The resulting 45 degree angles of the speaker wires routes them outside the terminals of the channels below. It's easier to connect speaker wires if you start with the bottom terminals for Channel 5 and proceed upward.

- Insert one wire with the ridge or other marking into the red **Ch 5 +** (positive) speaker terminal on the A 51. Insert the wire without the ridge or other marking into the adjacent black **Ch 5 -** (negative) speaker terminal on the A 51.
- Insert the other end of the wire with the ridge or other marking to the red + (positive) terminal on the speaker. Insert the other end of the wire without the ridge or other marking to the adjacent black - (minus) terminal on the speaker.
- - 0 Repeat steps 1 and 2 for **Ch 4**, then **Ch 3**, then **Ch 2**, and finally **Ch 1**.

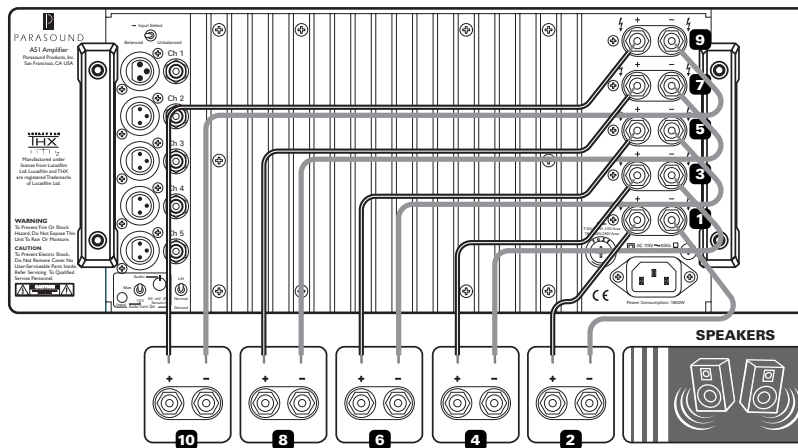

## YOU SHOULD KNOW

### Correct Speaker Polarity is Important

Polarity refers to + and - connections. Speaker wires are coded with printing or a ridge on the insulation on one of the leads so you know which lead was connected to the + and - terminals at the other end. This coding will help you keep the + and - polarity consistent for all channels.

### Speaker Wire Length and Gauge (thickness)

When selecting speaker wire, follow these guidelines:

- Keep the length of your speaker wire as short as possible.
- Use the thickest wire practical. For lengths greater than 50 feet, use speaker wire with an AWG (gauge) of 14 or lower. The smaller the AWG, the thicker the wire.
- Do not use speaker wire that is thinner than 16 AWG.
- Keep wire lengths for both channels as close to equal as possible.

You can manually turn the A 51 on and off with its front panel On-Off button. It can also be triggered to turn on and off automatically when your preamplifier, surround controller, or system controller is turned on and off.

## Manual On-Off from the Front Panel

If you want to manually turn on and off the A 51 at any time, you need to first select the Manual On-Off option by placing the **Auto Turn On** switch (on the rear panel) to its middle **Man** (Manual) position.

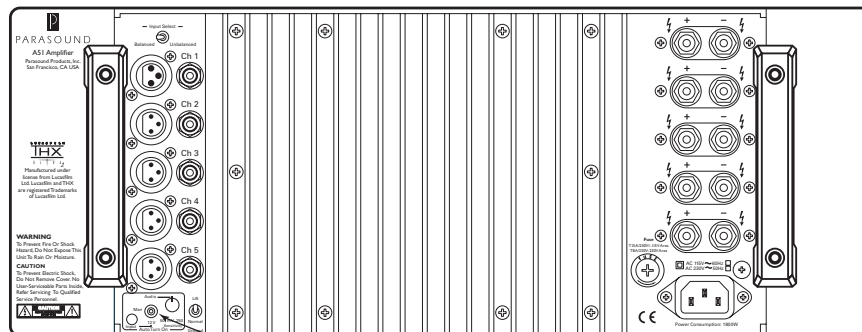

Auto Turn On Switch, set to middle position

## Connecting an Active Audio Source for Automatic On-Off

If you want to automatically turn on the A 51 whenever music is playing (an audio signal is present), choose the audio triggering option by moving the **Auto Turn On** switch to its upper **Audio** position.

### What You'll Need:

- An audio source that's playing

### Before Connecting

- Remove power to all the components in your audio system.
- Make sure the **Auto Turn On** switch on the A 51 is in its **Audio** (up) position.
- Set the **Audio** triggering **Sensitivity** adjustment knob on the rear panel to the desired level. Start with the 12 o'clock position.

### To Connect

Connect an active audio source to either the **Ch 1 Balanced or Unbalanced Input** jacks. (Refer to pages 2 and 3).

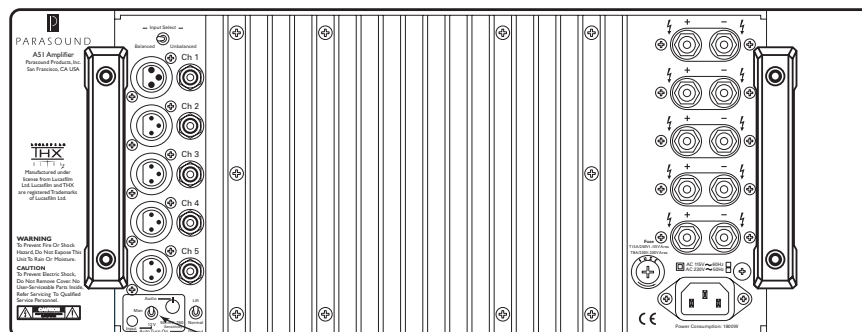

Auto Turn On Switch, set to up position

## YOU SHOULD KNOW

### Turn Off Delay in the Audio Mode

When the music stops, the A 51 will remain on for about five minutes. This delay prevents unwanted turn-off during silent passages in music or during the pauses between tracks.



# CONNECTING AN EXTERNAL DC SOURCE FOR AUTOMATIC TURN ON-OFF

7

To automatically turn on and off the A 51 with an external DC voltage, choose the DC Triggering option by moving the Auto Turn On switch on the rear panel to its lower 12V position.



2.5 mm sub-mini plug

## What You'll Need:

- A cable with a 2.5 mm sub-mini plug on each end (provided)
- A "control" component with +9Vdc to +12Vdc trigger voltage

## Before Connecting

- Remove Power to all the components in your audio system.
- Make sure the **Auto Turn On** switch on the A 51 rear panel is in its **12V** (down) position.

## To Connect

- Plug one end of the trigger wire into the **12V Input** jack on the A 51.
- Plug the other end of this wire into the external DC source.

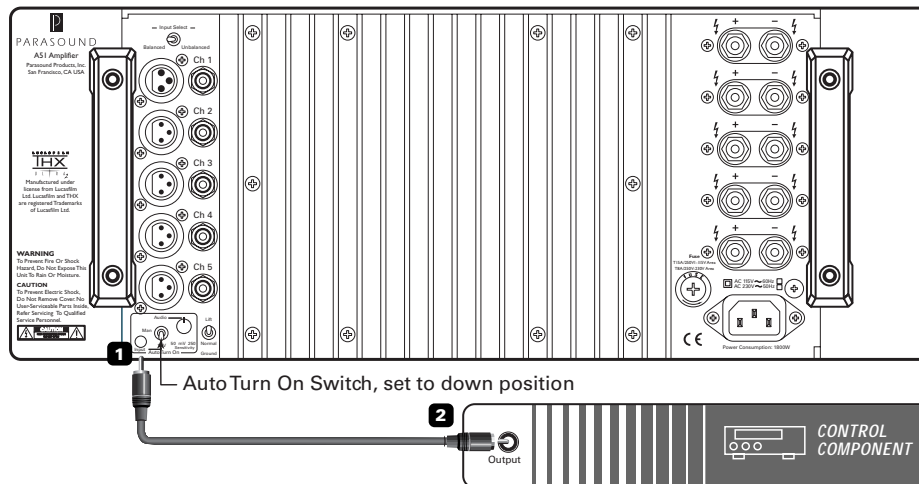

## YOU SHOULD KNOW

If the device you want to use to control your A 51 doesn't have a 2.5 mm trigger output connector, you can cut one plug off the cable and terminate the end as required. The lead with the red stripe is positive and the lead without the stripe is negative.

## **A AC Present Indication**

When the A 51 is plugged into a live AC outlet, a soft blue halo glows behind its On-Off button and its red "P" Badge glows faintly. These indicate that the unit is plugged into a live AC outlet, even when it is turned off.

## **B On, Off and Fault/Protection Status Indicators**

Whenever the A 51 is turned on, the soft blue glow behind its On-Off button will change to red for about five seconds as its internal circuits stabilize. Then the red glow is replaced by a brighter blue glow to indicate normal operation. If the glow remains red after turn on or while the amp is playing, it indicates activation of the A 51's protection circuits and no sound will be heard from the speaker.

The A 51 protects itself from external conditions such as excessive heat, load impedance that is too low, or a short-circuited speaker connection or wire. After you correct the fault, the A 51 will resume operation. If the A 51 remains "in protection" after it has cooled down and you've confirmed there are no external faults, it could indicate an internal problem. Please contact Parasound's Technical Service Department.

## **■ – ■ Channel Status Indicators**

These are the five small round indicators in the center of the recess in the front panel. The indicator on the left displays the status of channel one and the subsequent indicators display the status of channels two through five.

## **■ – ■ All Indicators Illuminated**

When all five channels are operating normally, these will all glow blue.

## **■ – ■ No Illumination:**

When the A 51 is turned off, these indicators are off. An indicator that does not glow when the A 51 is turned on represents a fault in that channel.

## **■ High-Temp Indicator**

This indicator is near the right side of the panel recess. It will glow red if any channel overheats. The On-Off button will also glow red if the A 51 overheats. Refer to the **Troubleshooting Guide** on page 11.

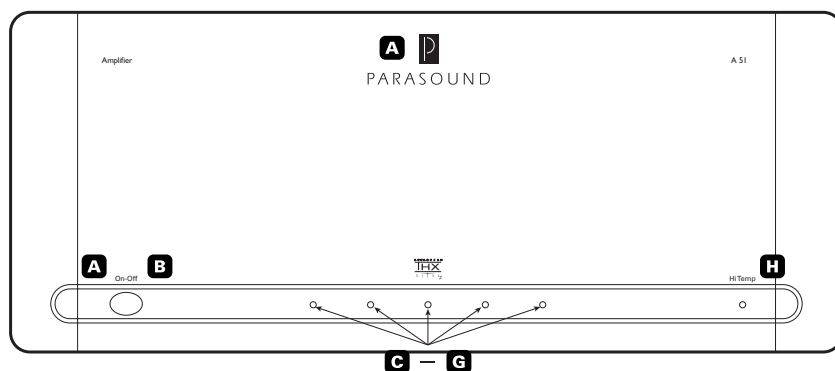

## AC Power Connections

We recommend that you plug your A 51 into the same AC wall outlet or power strip that powers your other audio components, especially the preamplifier or system controller. Having all the audio components on the same power circuit helps prevent hum caused by possible ground loops. The A 51 requires AC power that is continuous rather than switched on and off.

## 110 V - 120 V or 220 V - 240 V Operation

The A 51 can operate on either 110 V - 120 V or 220 V - 240 V. The correct line (or "AC mains") voltage for your unit is marked on its carton. Changing the A 51's operating voltage involves rewiring internal connections for both its main power transformer and standby power transformer, plus changing fuse values. Since there is a risk of electric shock, voltage changes must be referred to a qualified technician.

## What You'll Need:

- An IEC 65 AC Cord (provided)
- An AC outlet or high quality AC power strip within reach of the AC cord

## Before Connecting

- Remove power to all the components in your audio system.

## To Connect

- Plug the female end of the AC cord to the AC receptacle on the rear of the A 51.
- Plug the male end of the AC cord to an AC outlet or power strip.

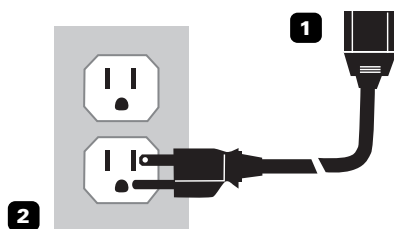
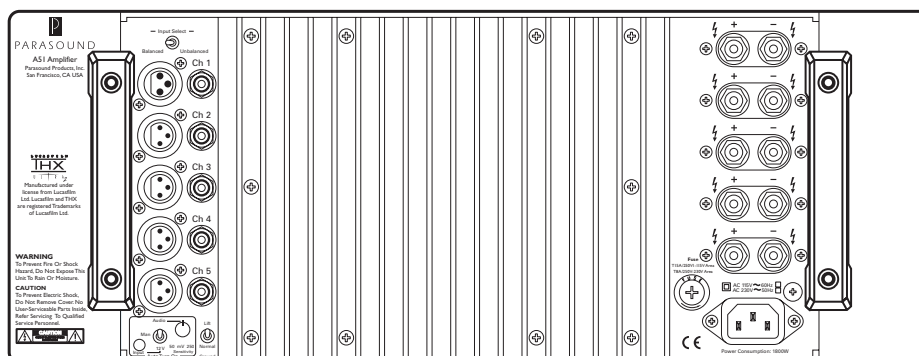



TROUBLE	PROBABLE CAUSE	REMEDY
<b>No power</b>	Power cord is disconnected	Connect power cord
	<b>Auto Turn On</b> selector switch is in wrong position	Check for correct position of the <b>Auto Turn On</b> switch
	AC fuse blown	Replace with same value fuse
<b>Auto turn on doesn't function with a trigger voltage</b>	DC trigger source wired in reverse or voltage too low	Check polarity of DC source with a voltmeter. Try connecting a 9V battery to the <b>12V DC input</b>
	<b>Auto Turn On</b> selector switch is in wrong position	Make sure <b>Auto Turn On</b> selector switch is in its <b>12V</b> position
<b>Auto turn on doesn't function with an audio input signal</b>	<b>Auto Turn On</b> selector switch is in wrong position	Make sure <b>Auto Turn On</b> selector switch is in its <b>Audio</b> position
	Sensitivity incorrectly adjusted	Turn the Audio trigger <b>Sensitivity</b> knob counterclockwise
<b>A 51 will not turn off when audio signal is removed</b>	Sensitivity level too high	Turn <b>Sensitivity</b> knob clockwise toward <b>250 mV</b>
<b>Power on, but no sound</b>	Bad connection from surround controller	Check input connections or try a different set of cables
<b>On-Off button glows red and channel indicator(s) off</b>	Over-current protection circuitry has been activated- one or both blue channel LEDs not illuminated	Check speaker load impedance. Check speaker wires and connections
	A 51 has overheated - red <b>Hi Temp</b> indicator is on	Allow A 51 to cool. Check that there is adequate ventilation around the A 51. Be sure the load impedance of each channel is no less than 4 ohms
<b>Distorted sound</b>	Damaged speaker	Connect each speaker to another channel on the A 51. If the same speaker remains distorted, the speaker or its wire is damaged. If the other speaker distorts, the problem may be with the A 51, the surround controller, or a source component
	Problem with preamplifier or source component	Switch the input cables. If distortion moves to another channel, the problem is with a component other than the A 51
	<b>Balanced-Unbalanced Input</b> switch is in the incorrect position	Move to the correct position for the jacks in use
<b>Hum and / or buzz through speakers</b>	Ground loop between surround controller and A 51 or at the equipment rack	Move the <b>Ground</b> switch to its <b>Lift</b> position. Install nylon shoulder washers on both sides of the panels of all equipment to insulate metal from touching the rack
	Ground loop from cable TV	Move the <b>Ground</b> switch to its <b>Lift</b> position. Install a cable isolation device such as the Xantech 634 Ground Breaker. <a href="http://www.xantech.com">www.xantech.com</a>
	Other ground loop	Contact Parasound Technical Service
<b>A 51 is overheating</b>	Load impedance at speaker terminals is too low	Make sure the speaker or speaker selector load is 4 ohms or higher
	Not enough ventilation	Make sure the A 51 has adequate ventilation

***If All Else Fails –Call Us for Help***

Call your Parasound dealer or Parasound's Technical Service Department toll free at **1-866-770-TECH** (8324). We can often solve the problem with simple diagnostic tests you can perform yourself. If we determine that your A 51 will need further inspection or servicing, we will:

- a) Refer you to an authorized Parasound repair center near you, or
- b) Authorize return of the unit to us and advise you of the correct procedure.

***Procedure for Returning Your A 51 to Parasound for Service***

If Parasound determines that you should send your A 51 to Parasound, you will be given a Return Authorization (RA) number. This RA number must be clearly marked on the **outer carton only**.

**IMPORTANT:** Enclose a copy of your original purchase receipt. **A unit is eligible for warranty repair ONLY when the purchase receipt shows that the unit was purchased from an Authorized Parasound Dealer.** A unit obtained through unauthorized channels is not eligible for warranty repair. Parasound is not responsible for any sellers' misrepresentations about our warranties or other service policies.

**We do not accept any of the following:**

- Units with collect shipping charges
- Units without a valid RA number
- Units without a suitable shipping carton
- Units for which we see or hear evidence of improper packing

For a non-warranty repair, contact us for an estimate of the repair charges before you ship the unit to us. The same packing and Return Authorization number procedures apply.

***Important Notice - Shipping the A 51***

Before shipping the unit to Parasound, you **MUST** re-pack the unit into its fitted molded foam insert sandwich and its original carton. If you do not have the original packing cartons and foam inserts, call us for new packing materials that we can provide to you for a nominal charge. **Use of any other carton and packing materials will probably result in shipping damage, and refusal of the unit.** Common carriers such as UPS seldom pay claims for damage incurred during shipment when a product is surrounded only with Styrofoam "peanuts" or otherwise improperly packed.

We cannot stress enough the importance of properly packing your A 51. Shipping damage resulting from inadequate packing can cost you a lot of money and significantly increase the time required for repair.

Ship the unit with adequate insurance. After repair under warranty, the unit will be returned to you via prepaid UPS within the continental United States.

### **Audio Trigger Sensitivity Adjustment**

The Audio Sensitivity Control sets the threshold of the audio trigger signal. You can adjust this level from a maximum sensitivity of 50 mV (fully counterclockwise) to a minimum sensitivity of 250 mV (fully clockwise). If you set this control to 50 mV, the A 51 might be falsely triggered on by non-musical or noisy signals that can appear in the system, such as when you switch preamp inputs at high volume levels. If you set this control to 250 mV, the A 51 might not turn on during quiet musical passages. The detented position (click stop) at 12 o'clock corresponds to 100 mV. It's a good starting point and will be suitable for most systems.

### **Balanced and Unbalanced Lines**

Recording and broadcast studios use balanced connections exclusively because of their inherent ability to reject noise and hum, thus assuring the best sound. Certain high quality preamplifiers and surround controllers built for residential use utilize balanced connections with XLR jacks for the same reasons. All Parasound Halo series power amplifiers have balanced inputs with XLR jacks so you can take full advantage of their inherent noise reduction capability and superior sound quality.

Unbalanced connections with RCA jacks are found on all home audio equipment. RCA jacks and two-conductor wires are less costly than the additional circuitry, higher priced XLR connectors and three-conductor wiring required for balanced connections.

In an unbalanced line, the positive audio signal appears at the center pin of the RCA jack and the negative signal on the outer shield wire, which also functions as the ground connection. Unbalanced interconnect cables are vulnerable to hum from an AC line, or other noise, such as RF (Radio Frequency), which can be reproduced through your loudspeakers. Since the unbalanced line's ground also carries the audio signal, there is no way for the connected amplifier or preamplifier to distinguish between the audio signals you want and unwanted noise emanating from external sources.

Balanced lines are superior because they utilize separate conductors for audio and ground: two inner conductors carry the positive and negative audio signal, and a third outer wire connects the grounds and also shields the two signal conductors. When the positive and negative signals appear at the component receiving the signal they are equal, but 180 degrees out of phase with each other with respect to ground. To send and receive balanced signals requires special differential circuitry.

A differential input circuit amplifies only the difference between the positive and negative signals. For example, when a 1 Volt signal arrives at a balanced input stage, the differential input "sees" a positive 1 Volt

minus a negative 1 Volt, or 2 Volts total. External hum and noise that somehow gets into a balanced line is common to both its positive and negative conductors with respect to ground. Therefore, it is canceled or rejected by the differential input circuit.

This phenomenon of rejecting noise signals common to both positive and negative conductors is called common mode rejection. Differential inputs are specified according to how well they reject signals common to both conductors. This is measured in dB and is called the common mode rejection ratio or CMRR.

### **Bare Speaker Wire Ends**

If you plan to use connections with bare wire ends, use a wire stripper to remove just enough insulation to expose a 1/2" (13 mm) length of bare wire. You can insert the stripped wire into the hole that goes sideways through the terminal's metal post. Before inserting the wire, twist its bare strands to prevent any of the strands from making contact across the two speaker terminals. If you have a soldering iron, you can "tin" (apply a small amount of molten solder) to each stripped bare wire to prevent it from unraveling, fraying and oxidizing.

### **Speaker Wires - Banana Plugs Instead of Bare Ends**

For convenience, we've supplied ten gold-plated banana plugs with your A 51. To attach these plugs, first pull the flexible red and black insulators off the plugs and slide them on the + and - speaker wires. Next, use a wire stripper to remove insulation to expose about 3/4" (19mm) of bare wire. Insert the bare wire into the barrel of the banana plug and crimp the barrel down with a pliers or crimper to hold it in place. Finally, slide the colored insulator down the wire so it is over the barrel of the plug. The only exposed metal should be the tip of the plug.

### **Choosing Interconnect Cables and Speaker Wire**

We are often asked to recommend specific brands of interconnect cables and speaker wire. It's true that with some amplifiers, sound quality will vary greatly according to interconnect cables and speaker wires. However, Parasound amplifiers use robust circuitry that sounds superb regardless of interconnects and speaker wires. Therefore, we feel that choosing a brand of cable for Parasound amplifiers is purely a matter of personal taste.

### **Ground Loops - Eliminating Hum and Buzz**

Audible hum and buzzing noises in a system are usually related to issues with the component grounds. Ground (sometimes called common) is a point of reference for voltages in virtually all audio and video components. Ground is supposed to remain at zero volts while the audio signal swings positive (voltage above ground) and negative (voltage below ground). If ground isn't at zero, there can be an audible 60 Hz

hum (or 50 Hz hum in regions with 50 Hz AC). The harmonics of these frequencies (120 Hz, 240 Hz, 480 Hz or 100 Hz, 200 Hz, 400 Hz) may add buzz in addition to the hum.

The ideal of zero voltage ground for all the components in a system is practically impossible, because some resistance between the ground points of different components is inevitable. By keeping components close together with their power cords plugged into a common AC outlet or power strip, you'll avoid the problems created by resistance in the house's wiring.

Hum and buzz is also caused when unwanted voltage flows through multiple component ground points called ground loops. Here are three tips to avoid ground loops:

1. Use balanced input lines with your Parasound A 51. (See Balanced and Unbalanced Lines in this section).
2. When rack mounting, always use the insulated "shoulder" washers. These break the ground loops caused by metal-to-metal contact between the rack, the components, and their rack-mount bolts. Extra washers are available from rack manufacturer Middle Atlantic Products, [www.middleatlantic.com](http://www.middleatlantic.com).
3. Use the Ground switch on the A 51 to eliminate most ground loops. This separates the A 51's signal input ground from its chassis ground to isolate unwanted voltage in the ground shield of the unbalanced (RCA) input cable. Be sure your system installation is finished before you try moving the Ground switch from its Normal to its Lift position.

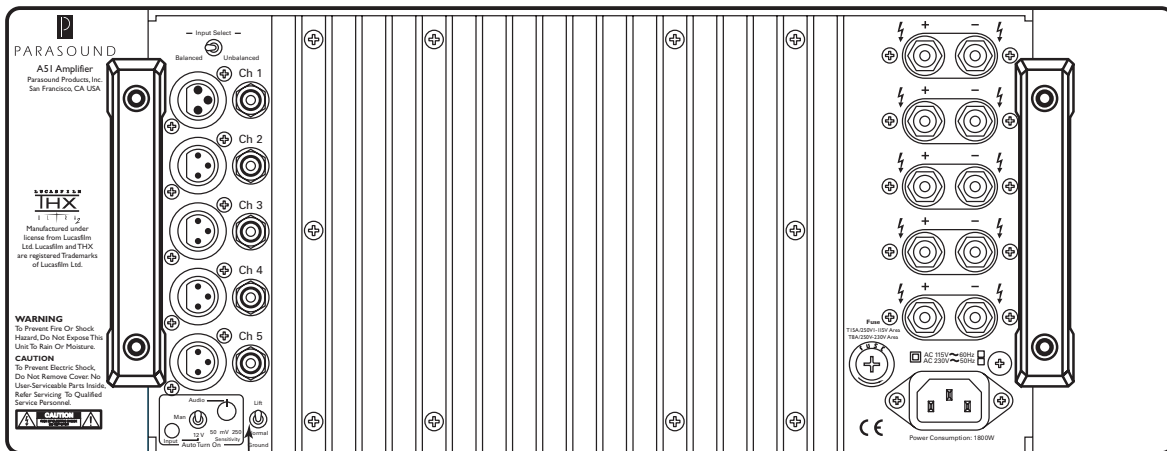

Ground Switch, set to up position



## **Circuit Designed by John Curl**

Parasound design consultant John Curl has been a legend among audiophiles and electronic engineers for decades. He pioneered measurements to correlate musical accuracy with the materials used in parts, worked with world-class touring companies, has designed highly coveted audio classics, including the original Mark Levinson JC-2, Denneson JC-80, Vendetta Phono Preamplifier, and CTC Blowtorch preamplifiers; master recorders for Wilson Audio and Mobile Fidelity; and the mixing consoles used in live concerts by The Grateful Dead and the Montreux Jazz Festival in Switzerland.

As our featured amplifier designer since 1990, he has created many products that have earned Parasound worldwide acclaim. John is particularly proud of what he and Parasound have accomplished together: "The circuits I design for Parasound are extremely sophisticated and are typical of products that are far more expensive. I can't think of any other audio products that offer nearly as much bang for the buck."

## **Parts Selection**

Every part within the A 51 is carefully chosen for its accuracy and reliability. Metal film resistors with 1% tolerance are selected for their precision and because their values don't drift as they heat up during operation. Polypropylene and mica capacitors are used extensively for their superior linearity and low dielectric absorption. Semiconductors are selected for superior performance in their specific roles in the circuit. Gold has the best conductivity of any metal, so we use high quality gold-plated input connectors and speaker terminals. The double-sided circuit boards are FR4 glass epoxy for long-term durability. The chassis is made of heavy gauge steel to safely house the internal circuitry. This attention to detail when selecting parts makes the difference between a very good amplifier and an outstanding amplifier.

## **The Power Supply**

The heart of the power supply is a 2.4 kVA toroidal power transformer, chosen for its efficiency, low hum field, and high power rating. Encapsulating this massive power transformer in an epoxy-filled steel canister assures ultra-quiet performance.

The A 51 power transformer employs multiple independent secondary windings so that each amplifier channel has its own power supply, assuring more than ample DC voltage at all times and under all conditions. It also reduces inter-channel crosstalk that can blur the sound and impair the correct sense of where instruments, dialogue and effect are positioned.

Each channel's +/- 80 Vdc B+ and B- supply rails use high-speed rectifier diodes and four enormous 8,200  $\mu$ F electrolytic filter capacitors, chosen for their low Equivalent Series Resistance (ESR) and dielectric absorption. In addition, these filter capacitors are bypassed with smaller polypropylene capacitors to reduce AC ripple in the DC supply and to further eliminate noise and interference that is generated in AC power lines from computers and other appliances in the home.

## **Relay-Bypassed Soft Start Circuit**

When the A 51 is first turned on, there is a significant amount of in-rush current required to charge the enormous power supply capacitors. In order to suppress this in-rush current and to prevent nuisance tripping of circuit breakers, we employ NTC (negative temperature coefficient) resistors. These resistors cut the in-rush current by approximately 50%. Once they heat up, they essentially become a jumper with zero ohms resistance. However, the A 51 goes one step further for this circuit. After the NTC resistors have done their job of suppressing in-rush current a gold contact relay automatically is activated to jump across the NTC resistors to completely bypass them. This extra step insures that the resistors do not restrict any current whatsoever to the power supply once the A 51 is in full operation.

## **Audio Circuit Path Topology**

Parasound's circuit topology is a hybrid of carefully chosen discrete transistors that result in superior performance at each stage. We use JFETs (Junction Field Effect Transistors) for the input stage; MOSFETs (Metal Oxide Field Effect Transistors) for the driver stage and bipolar transistors for the output stage. Discrete transistors are more sonically accurate than integrated circuits commonly used by other brands.

## **Complementary Configuration**

Each stage of amplification has transistors fed by the positive DC power supply and complementary transistors fed by the negative DC power supply. Thus, half of the devices amplify the positive half of the musical waveform while the other half of the devices amplify the negative half. This complementary topology is inherently linear, which reduces distortion and improves sonic accuracy.

## **The Input Stage**

The A 51's input stage uses matched pairs of discrete JFETs arranged in a differential configuration. JFETs are ideal for the input stage because their inherently high impedance is unaffected by the impedance of source components. Differential configuration provides superior noise reduction. These precision input JFETs are also cascoded to produce the current necessary to drive the MOSFET drivers in the following stage.

**The Driver Stage**

The driver stage provides critical amplification for which we employ a complementary matched pair of MOSFETs selected for their tube-like sonic qualities. MOSFETs tend to generate less odd-order harmonic distortion than bipolar transistors. This is important because odd-order distortion sounds unnatural and fatiguing to the human ear, whereas even-order distortion is less offensive because it is consonant, rather than dissonant. Our MOSFET driver stage prevents the harshness and brittle sound so often found in other amplifiers.

**The Output Stage**

The amplifier's sonic characteristics are established by its input and driver stages. Now, the sole job of its output stage is to deliver the enormous current and voltage from its power supply to the speakers. Bipolar output transistors are better than MOSFETs in the output stage because of their higher safe operating area (SOA) and inherent ruggedness. Each channel's output stage employs four pairs of high current (15-ampere) bipolar transistors to insure long-term reliability, even with continuous high power operation and challenging speaker loads. Lightning-fast (60 MHz) transistors respond instantly to complex demands in the musical signal, virtually eliminating distortions that occur with slower transistors. Slew rate limiting and Transient Intermodulation Distortion (TIM) are simply not an issue in the A 51.

**Class A-A/B Operation**

Pure class A operation provides the purest sound. However, an amplifier operating entirely in class A operation would be enormous, highly inefficient, and generate too much heat. Class A/B combines some of the advantages of Class A with the efficiency of Class B operation. It is a compromise that reduces the heat generated in pure class A operation and the odd-order harmonic distortion created in class B. In class AB, the driver and output stages are always partially turned on, which provides a nominal amount of pure class A operation. At higher power levels, when the musical waveform swings from positive to negative and vice versa, each bank of transistors is allowed to rest momentarily. This resting, or quiescent time, makes it possible to deliver high amounts of power without overheating. It also makes it possible to use passive cooling and avoid fans, whose noise can be heard over the music. The A 51 input and driver stages employ pure Class A while its output stage operates with higher pure Class A power than many amplifiers selling for twice or three times its price. The result is less fatiguing, more natural sound.

**Total Protection - DC Servos**

Direct Current (DC) burns out speakers. Every power amplifier must have some way to insure that DC from its power supply never reaches its + or - speaker terminals. Most amplifiers simply use trim controls to reduce their DC offset or capacitors to block DC. Unfortunately, trim controls can allow DC offset to increase over time, and even the most expensive capacitors in the audio signal path will "veil" sonic clarity and attenuate bass response.

Parasound power amplifiers incorporate ingenious and fast-acting DC servo circuits, completely eliminating the need for coupling and blocking capacitors. The A 51 is direct-coupled from its input jacks to its speaker terminals. This advanced circuitry never needs adjustment or maintenance. It operates outside the audio signal path to keep the DC offset at the output of the A 51 at a constant 0.00 Vdc. The results are startling clarity, freedom from listening fatigue, and formidable bass response.

**Total Protection - Relays**

Each channel of the A 51 has a high-quality protection relay with gold-plated contacts for long-term reliability. These relays function to protect either the amplifier, the speakers, or both. When the A 51 is first powered on, these relays remain open for three seconds as the positive and negative power supplies stabilize and reach equilibrium. This prevents annoying popping or other transient noises. Relay protection also prevents damage to your speakers in case of a catastrophic amplifier failure. Any amplifier that doesn't use relay protection for its speaker outputs compromises the safety of the amplifier and your speakers.

**Total Protection - Current Overload**

Specialized current-sensing transistors are connected to the output stages of the A 51 to constantly monitor the current flow through the output transistors. If the current drawn by this stage exceeds a predetermined safe level due to a load impedance below 1 ohm or a short circuit at the speaker terminals, the output relay will open immediately to prevent any of the output transistors or other parts from failing.

**Total Protection - Fuses**

Each channel of the amplifier has a separate fuse for its positive and negative DC voltage rails. These fuses provide backup protection in case the over-current protection does not work in time, or if an internal part fails. In the event of a part failure, these fuses halt operation to minimize damage to additional parts.

**Power Output - All Channels Driven**

250 watts RMS x 5, continuous,

20 Hz - 20 kHz, 8 $\Omega$

400 watts RMS x 5, continuous,

20 Hz - 20 kHz, 4 $\Omega$

**Current Capacity**

60 amperes peak per channel

**Slew Rate**

> 130 volts per microsecond

**Frequency Response**

5 Hz - 100 kHz, +0/-3 dB at 1 watt

**Total Harmonic Distortion**

< 0.2 % at full power

< 0.03 % at typical listening levels

**IM Distortion**

< 0.04 %

**TIM**

Unmeasurable

**Dynamic Headroom**

> 1.5 dB

**Interchannel Crosstalk**

> 78 dB at 1 kHz

> 63 dB at 20 kHz

**Input Impedance**

Unbalanced: 47k  $\Omega$

Balanced: 94k  $\Omega$

**Input Sensitivity for 28.28 V Output into 8  $\Omega$** 

Unbalanced: 1 V

Balanced: 1 V per leg

**S/N Ratio**

> 112 dB, input shorted, IHF A-weighted

> 102 dB, input shorted, unweigh

**Damping Factor**

> 1100 at 20 Hz

**DC Trigger Requirements**

+9 Vdc to +12 Vdc, 2 mA

**Audio Trigger Requirements**

50 mV AC - 250 mV AC

**Dimensions**

Width: 17½" (445 mm)

Panel height: 7" (178 mm)

Height with feet: 7⅝" (194 mm)

Depth: 20" (508 mm)

**Power Requirement**

Standby: 25 Watts

Full Power into 4 $\Omega$ : 3000 Watts

**Net Weight**

80 lb. (36.4 kg)

**Shipping Weight**

87 lb. (39.5 kg)



PARASOUND

Parasound Products, Inc. 950 Battery Street, San Francisco, CA 94111  
415-397-7100 / Fax 415-397-0144 [www.parasound.com](http://www.parasound.com)

## Free Manuals Download Website

<http://myh66.com>

<http://usermanuals.us>

<http://www.somanuals.com>

<http://www.4manuals.cc>

<http://www.manual-lib.com>

<http://www.404manual.com>

<http://www.luxmanual.com>

<http://aubethermostatmanual.com>

Golf course search by state

<http://golfingnear.com>

Email search by domain

<http://emailbydomain.com>

Auto manuals search

<http://auto.somanuals.com>

TV manuals search

<http://tv.somanuals.com>