



Bulletin 4480-T7-US

Technical Manual Crimping Machine

Effective: July 2005

Supersedes: November 1995

Karrykrimp 2



- Read the entire Technical Manual prior to mounting and operating this crimper.
- View the enclosed video or CD prior to operating this crimper.

WARNING - When using this machine, always exercise basic safety precautions, including, but not limited to the following:

1. Use this machine only for its intended purpose: to fabricate Parker hose assemblies.
2. Parker Hannifin will not accept responsibility for any incidental, consequential or special damages of any kind or nature whatsoever that result from any subsequent alterations to any Parkrimp machine. Parker Hannifin disclaims any warranties on items altered after leaving the Parker Hannifin facility.
3. This machine must be properly installed and located in accordance with the installation instructions before it is used.

To minimize the possibility of injury:

1. The power unit must be connected to a grounded, properly rated, protected and sized power-supply circuit to prevent electrical shock and to avoid electrical overload;
2. **DO NOT OPERATE OVER MAXIMUM RATED WORKING PRESSURE; AND**
3. **CHECK FOR SAFE SYSTEM SETUPS.**

Make sure that the valve, connecting hoses, etc. are protected from any external source of damage, such as: excessive heat, flame, moving machine parts, sharp edges, falling objects, corrosive chemicals, etc.

IMPORTANT SAFETY NOTICE

THIS INFORMATION IS INTENDED FOR USE BY INDIVIDUALS POSSESSING ADEQUATE BACKGROUNDS OF ELECTRICAL, ELECTRONIC AND MECHANICAL EXPERIENCE. ANY ATTEMPT TO REPAIR THIS MACHINE MAY RESULT IN PERSONAL INJURY AND PROPERTY DAMAGE.
THE MANUFACTURER OR SELLER CANNOT BE RESPONSIBLE FOR THE INTERPRETATION OF THIS INFORMATION, NOR CAN IT ASSUME ANY LIABILITY IN CONNECTION WITH ITS USE.

DISCONNECT ANY POWER CORD BEFORE SERVICING IMPORTANT - RECONNECT ALL GROUNDING DEVICES



Parker Safety Guide for Selecting and Using Hose, Tubing, Fittings and Related Accessories

Parker Publication No. 4400-B.1

Revised: May, 2002

WARNING: Failure or improper use of hose, tubing, fittings, assemblies or related accessories ("Products") can cause death, personal injury and property damage. Possible consequences of failure or improper selection or improper use of these Products include but are not limited to:

- Fittings thrown off at high speed
- High velocity fluid discharge
- Explosion or burning of conveyed fluid.
- Electrocutation from high voltage electric power lines.
- Contact with suddenly moving or falling objects that are controlled by the conveyed fluid.
- Injections by high-pressure fluid discharge.
- Dangerously whipping Hose.
- Contact with conveyed fluids that may be hot, cold, toxic or otherwise injurious.
- Sparking or explosion caused by static electricity buildup or other sources of electricity.
- Sparking or explosion while spraying paint or flammable liquids.
- Injuries resulting from inhalation, ingestion or exposure to fluids.

Before selecting or using any of these Products, it is important that you read and follow the instructions below. Only Hose from Parker's Stratoflex Products Division is approved for in flight aerospace applications, and no other Hose can be used for such in flight applications.

Offer of Sale

The items in this document are hereby offered for sale by Parker Hannifin Corporation, its subsidiaries or its authorized distributors. This offer and its acceptance are governed by the provisions stated in the "Offer of Sale".

Table of Contents

Safety Notice 2

Specifications 4

Accessories 5-6

Installation 7

Tools and Dies 8

Tool Selection Chart 9

Crimping Instructions..... 10

Assembly Details and Parts Lists 11

Trouble Shooting 12-13

Maintenance 14

Safety Guide (Parker Publication 4400-B.1) 15-17

Offer of Sale 19

Help us help you...

Read this guide carefully.

It is designed to help you operate and maintain your Karrykrimp 2. If you do not understand something or need more help, call:

Technical Services Department
 Parker Hannifin Corporation
 Hose Products Division
 Phone: (440) 943-5700
 Fax: (440) 943-3129

Write down the Model and Serial Number:

Model Number

or write us at:
 Parker Hannifin Corporation
 Hose Products Division
 30240 Lakeland Blvd..
 Wickliffe, OH 44092

Serial Number

RECEIVING INSTRUCTIONS: UNPACKING - Remove all documents and components from shipping containers.

INSPECTION - Visually inspect all components for shipping damage. If any shipping damage is found, notify the carrier at once. Shipping damage is not covered by the Parker warranty. The carrier is responsible for all repair and replacement costs resulting from such damage.





Specifications

Dimensions: Height 30"
 Depth 15"
 Width 14"

Weight: 100 lbs, without Power Unit

Capabilities: 1-1/4" SAE 100R1AT maximum
 1" DIN 20 022-1SN maximum
 1-1/4" SAE 100R2AT maximum
 1-1/4" DIN 20 022-2SN maximum
 1" SAE 100R3 maximum
 1-1/4" SAE 100R4 maximum
 7/8" SAE 100R5 maximum
 7/8" SAE 100R6 maximum
 7/8" SAE J1402 AI maximum
 7/8" SAE J1402 All maximum
 1-1/4" SAE 100R9AT maximum
 1-1/4" SAE 100R12 maximum
 1" SAE 100R13 maximum
 1" SAE 100R16 maximum
 1-1/4" SAE 100R17 maximum

Note: For the latest crimper compatibility; reference CrimpSource online at www.parkerhose.com or contact your Parker products supplier.

Set-up Time: 20 Seconds

Full Cycle Time: 30 Seconds

Note: Cycle times vary depending on hose and fitting styles and sizes.

Model 85C-061 Includes:

- Base Unit 85C-080
- Die Ring Silver 85C-R01
- Die Ring Black 85C-R02
- Connection Hose 85C-00L
- Stand 832021



Electric Pump

Part No. 82C-0EP

Heavy duty electric pump delivers 10,000 psi.

Length	12-1/8"
Width	12-5/8"
Height	15"
Port Size	3/8" NPTF

115/230 volt, 1 phase, 60 hertz



Electric Pump

Part No. 85C-0EP

Heavy duty electric pump delivers 10,000 psi at a faster cycle time.

Length	14-1/8"
Width	9-1/2"
Height	16-3/8"
Port Size	3/8" NPTF

115/230 volt, 1 phase, 60 hertz

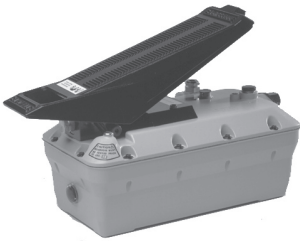

Air/Hydraulic Pump

Part No. 82C-0AP

Lightweight pump operates with 80-120 psi shop air pressure.

Length	14-3/4"
Width	5-5/8"
Height	5-3/4"
Intake Port Size	1/4" NPTF
Output Port Size	3/8" NPTF

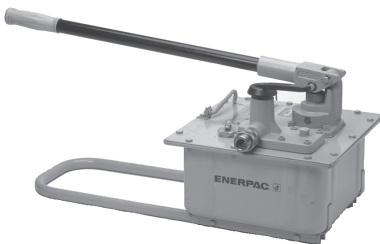

Hand Pump

Part No. 85C-0HP

Ease of operations hand pump delivers 10,000 psi.

Length	28-15/16"
Width	12-1/8"
Height	13-1/4"
Port Size	3/8" NPTF

All pumps shown above are supplied to Parker by Enerpac. For repair or warranty work on an of these pumps, contact your nearest Enerpac Service Center. For the Enerpac Service Center nearest you, call 1-800-558-0530 or visit them on the web at www.enerpac.com.

ENERPAC Warranty Policy

For those ENERPAC items sold as part of the Parker product offering, the following warranty applies.

ENERPAC products are warranted to be free of defects in materials and workmanship under normal use for as long as they are owned by the original purchaser, subject to the exclusions and limitations described below. This warranty does not cover ordinary wear and tear, overloading, alterations, (including repairs or attempted repairs by parties other than ENERPAC or its authorized service representatives), improper fluid, use in a manner for which they are not intended or use which is contrary to instructions for the products.

THIS WARRANTY IS LIMITED TO NEW PRODUCTS SOLD THROUGH ENERPAC AUTHORIZED DISTRIBUTORS, ORIGINAL EQUIPMENT MANUFACTURERS OR OTHER DESIGNATED CHANNELS OF DISTRIBUTION. NO AGENT, EMPLOYEE, OR OTHER REPRESENTATIVE OF ENERPAC HAS THE AUTHORITY TO IN ANY WAY CHANGE OR AMEND THIS WARRANTY.

Electronic products and components are warranted against defects in material and workmanship for a period of two years from the date of purchase.

The following items supplied with ENERPAC products are excluded from this warranty:

- Components not manufactured by ENERPAC, including air motors, electric motors, gasoline engines, and diesel engines. Such items are warranted to the extent of the warranty provided by the manufacturers of such items.

If the customer believes a product is defective, the product must be delivered, or shipped freight prepaid, to the nearest ENERPAC Authorized Service Center. The customer should contact ENERPAC to locate an Authorized Service Center in the customer's area. Products that do not conform to this

warranty will be returned by ground transportation, freight prepaid.

THE FOREGOING WARRANT IS EXCLUSIVE AND IS IN LIEU OF ALL OTHER EXPRESS AND IMPLIED WARRANTIES, INCLUDING BUT NOT LIMITED TO THE IMPLIED WARRANTIES OF MERCHANTABILITY AND FITNESS FOR A PARTICULAR PURPOSE.

The remedy of repair, replacement or refund is customer's exclusive remedy in the event of breach of this warranty.

SELLER SHALL NOT BE SUBJECT TO AND DISCLAIMS:

(a) ANY OTHER OBLIGATIONS OR LIABILITIES ARISING OUT OF BREACH OF CONTRACT OR OF WARRANTY,

(b) ANY OBLIGATIONS WHATSOEVER ARISING FROM TORT CLAIMS (INCLUDING NEGLIGENCE AND STRICT LIABILITY) OR ARISING UNDER THEORIES OF LAW WITH RESPECT TO PRODUCTS SOLD OR SERVICES RENDERED BY SELLER OR ANY UNDERTAKINGS, ACTS OR OMISSIONS RELATING THERETO, AND

(c) ALL CONSEQUENTIAL, INCIDENTAL AND CONTINGENT DAMAGES WHATSOEVER.

ENERPAC's liability in all cases is limited to, and shall not exceed, the purchase price paid.

For the nearest authorized ENERPAC SERVICE CENTER, please call ENERPAC at 800-558-0530 or visit the ENERPAC WEB SITE at www.Enerpac.com.

1. Remove crimper and all accessories from shipping crate.

Verify that you have received the following items:

- Base Machine 85C-080
- Silver Die Ring 85C-R01
- Black Die Ring 85C-R02
- Hose Assembly 85C-00L
- Stand Assembly 832021
- Technical Manual 4480-T7-US
- Grease
- Training Video/CD

2. Assemble crimper base unit to stand as shown in Figure 2.

Place machine on sturdy bench. It is recommended that the machine be bolted to the bench. Two 1/2" holes are provided in the stand for this purpose. Make sure crimper base overhangs bench to allow access from below base plate.

3. Connect hose assembly to power unit and to crimper cylinder. Follow instructions supplied with power unit for venting, checking oil level, or general usage.

4. Place die ring in position on crimper base. Cycle cylinder up and down a few times to purge air from system. Recheck oil level in power units. Make sure cylinder is fully retracted before adding any hydraulic oil.

5. Your machine is now ready for use. Please read the remainder of this manual before proceeding to crimp any hose assembly.

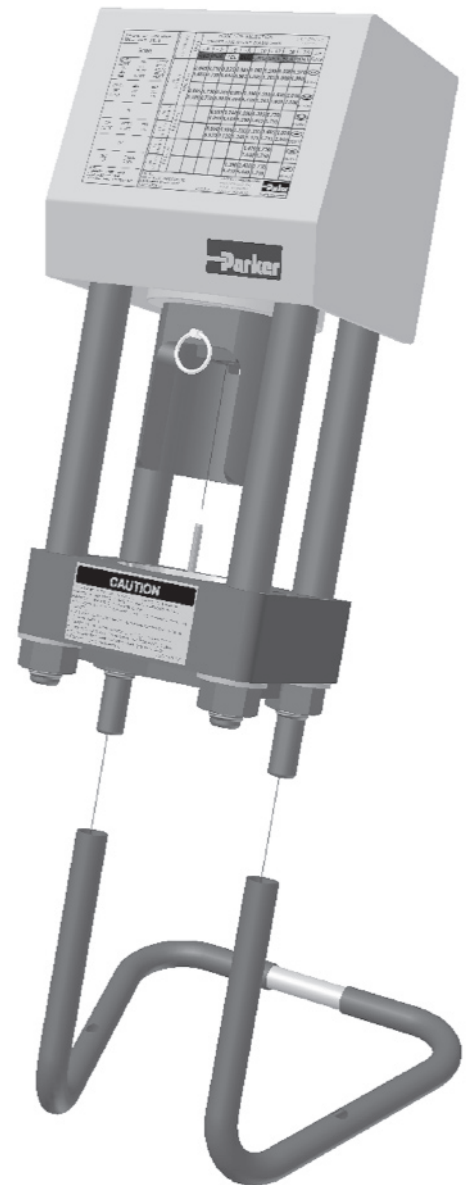

Figure 2

The following crimping dies are available for use with the Karrykrimp 2 machine:

26 Series Fitting Dies (Silver)		
80C-E04	Size -4 (3/16")	Color Coded Red
80C-E05	Size -5 (1/4")	Color Coded Purple
80C-E06	Size -6 (5/16")	Color Coded Yellow
80C-E08	Size -8 (13/32")	Color Coded Blue
80C-E10	Size -10 (1/2")	Color Coded Orange
80C-E12	Size -12 (5/8")	Color Coded Green
80C-E16	Size -16 (7/8")	Color Coded Black

70 & 71 Series Fitting Dies (Black)		
83C-D06	Size -6 (3/8")	Color Coded Yellow
83C-D08	Size -8 (1/2")	Color Coded Blue
83C-D10	Size -10 (5/8")	Color Coded Orange
83C-D12	Size -12 (3/4")	Color Coded Green
83C-D16	Size -16 (1")	Color Coded Black
83C-D20	Size -20 (1-1/4")	Color Coded White

73 & 78 Series Fittings Dies (Olive Drab)		
80C-L12	Size -12 (3/4")	Color Coded Green
80C-L16	Size -16 (1")	Color Coded Black

81 Series Fittings Dies (Silver)		
80C-V12	Size -12 (3/4")	Color Coded Green
80C-V16	Size -16 (1")	Color Coded Black
80C-V20	Size -20 (1-1/4")	Color Coded White

43 Series Fitting Dies (Silver)		
80C-A04	Size -4 (1/4")	Color Coded Red
80C-A05	Size -5 (5/16")	Color Coded Purple
80C-A06	Size -6 (3/8")	Color Coded Yellow
80C-A08	Size -8 (1/2")	Color Coded Blue
80C-A10	Size -10 (5/8")	Color Coded Orange
80C-A12	Size -12 (3/4")	Color Coded Green
80C-A16	Size -16 (1")	Color Coded Black
80C-A20	Size -20 (1-1/4")	Color Coded White

HY Series Fitting Dies for AX hose (Silver)		
80C-H585	Size -4 (1/4")	Color Coded Brown
80C-H735	Size -6 (3/8")	Color Coded Brown
80C-H840	Size -8 (1/2")	Color Coded Brown
80C-H970	Size -10 (5/8")	Color Coded Brown
80C-H1120	Size -12 (3/4")	Color Coded Brown
80C-H1365	Size -16 (1")	Color Coded Brown

HY Series Fitting Dies for BXX hose (Silver)		
80C-H605	Size -4 (1/4")	Color Coded Brown
80C-H775	Size -6 (3/8")	Color Coded Brown
80C-H885	Size -8 (1/2")	Color Coded Brown
80C-H1010	Size -10 (5/8")	Color Coded Brown
80C-H1170	Size -12 (3/4")	Color Coded Brown
80C-H1465	Size -16 (1")	Color Coded Brown

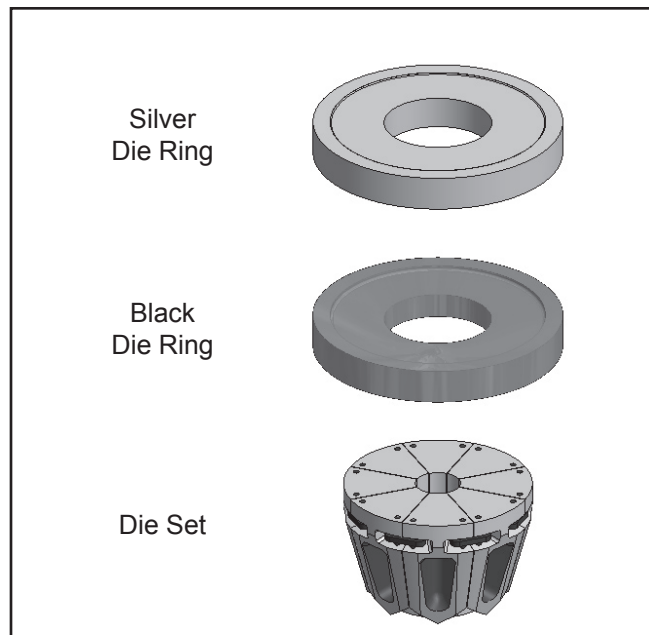

The Karrykrimp 2 can be used to crimp some Parflex Division products. Please contact Parker Parflex Division for more information.

The Karrykrimp 2 is shipped without dies.

The 43 Series dies are silver and inserts are color coded by size. Refer to the die selection chart, Parker Catalog 4400 or CrimpSource online, at www.parkerhose.com to determine which die set and die ring to use when crimping a particular fitting, hose size and type.

The following tooling is used for crimping:













85C-R01 Silver Die Ring

To determine when to use, refer to die selection chart in Parker Catalog 4400 or decal on side of crimper.

85C-R02 Black Die Ring

To determine when to use, refer to die selection chart in Parker Catalog 4400 or decal on side of crimper.

See above for die set part numbers.

PHASTKRIMP / KARRYKRIMP 2 89C-DEC43-78 REV. B			FITTINGS	DIES	HOSE / DIE SELECTION CHART AND CRIMP DIAMETERS								U. S. PATENT NO. 4,577,485		
HOSE					43 SERIES	80C-Axx	- 4	- 5	- 6	- 8	- 10	- 12	- 16	- 20	DIE RING
							RED	PUR	YEL	BLU	ORG	GRN	BLK	WHT	
351TC	431	471TC	43 SERIES	80C-Axx	0.645	0.710	0.825	0.945	1.060	1.245	1.590	1.970			
351ST	436	471ST			0.665	0.730	0.845	0.965	1.080	1.265	1.610	1.990			
421	451TC	472TC			0.685	0.750	0.865	0.985	1.100	1.285	1.630	2.010			
424	451ST	482TC			0.705	0.770	0.885	1.005	1.120	1.305	1.650	2.030			
426		482ST													
421WC	304	601	70 SERIES	83C-Dxx			0.990	1.140	1.260	1.395	1.735				
301	341	604			1.010	1.160	1.280	1.415	1.755						
301LT	381	881	71 SERIES	83C-Dxx			0.950	1.100	1.220	1.355	1.695	2.025			
					0.970	1.120	1.240	1.375	1.715	2.045					
	701		73 SERIES	80C-Lxx						1.420	1.730				
											1.440	1.750			
	721	772TC	78 SERIES	80C-Lxx					1.390	1.420	1.730				
	721TC	772ST			77C	774					1.410	1.440	1.750		
	731														
	78C	782TC													
	781	782ST													

NOTE:
STAINLESS STEEL CRIMP
DIAMETERS ARE 0.010
GREATER THAN TABLES LISTED.

NOTE:
DO NOT USE LUBRICANT TO
ASSEMBLE SPIRAL HOSE
AND FITTINGS.

DEC43-78

PARKER HANNIFIN CORP.
Hose Products Division
30240 Lakeland Blvd.
Wickliffe, Ohio 44092



For Reference Only

Notes:

This chart is displayed on the yellow cover of the Karrykrimp 2 machine.

The 43 Series dies listed are interchangeable between all of the Parkrimp machines. The die rings are not interchangeable between machines. Use only 85C-R01 and 85C-R02 die rings on the Karrykrimp 2 machine.

For a complete selection of hose and fittings, see Parker Catalog 4400.

Caution: To ensure consistent quality, crimp diameters must be checked:

1. After first assembly
2. At regular intervals during the production, such as first, last and every 50th assembly.

If you find your crimp diameters out of tolerance, inspect each assembly made. Never allow hose assemblies with an incorrect crimp diameter to be used. Use the appropriate Parker Machine Trouble Shooting Guide to determine the cause. If you are unable to determine the cause of the problem, call our Hose Products Division Technical Services Department at (440) 943-5700, for assistance.

Additional Hose Die Selection Charts are available upon request from your Parker supplier.



Crimping Instructions for 26, 43, 70, 71, 73, 78 and 81 Series Fittings



1. The Hose Insertion Depth fixture can be used to mark the insertion depth on the hose.



2. Push the hose all the way into the coupling to the insertion depth mark. Do not use lubricant to assemble spiral hose and fittings.



3. Remove pin from inside pusher unit so pusher will swing back. Lubricate the die bowl cavity to prevent wear.



4. Place unitized die-train in bowl. See decal on crimper for proper die set. Note: Die sets are color coded by size.

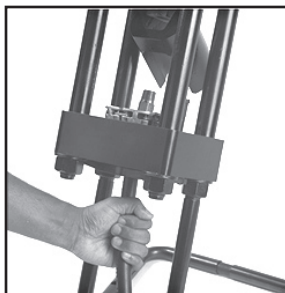

5. Position the hose and fitting in dies from below.

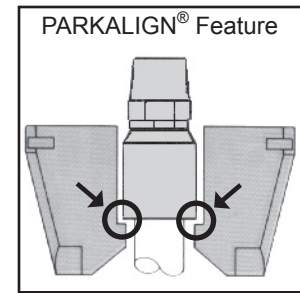

6. Rest bottom of coupling on die step using PARKALIGN® feature.



7. Place the die ring on top of the dies. See decal on crimper for proper die ring; Silver and Black.



8. Reposition pusher, replace pin, operate pump until ring bottoms out on base plate.



9. Release pump pressure and remove finished assembly.

Note: See Hose Insertion Depth table at the right.

Important: Hose assemblies must be inspected for cleanliness and free of all foreign particles.

Note: Parker Hannifin will not accept responsibility for the operations of, or provide warranty coverage for, a crimper that is operated by a power unit other than equipment supplied by Parker Hannifin for the expressed purpose of operating the designated crimper.

Hose Insertion Depth

Hose by Dash Size	Fitting Series					
	26	43	70	71	73/78	81
-4	13/16"	13/16"				
-5	13/16"	15/16"				
-6	13/16"	1-1/8"	1-1/16"	1-1/16"		
-8	13/16"	1-5/16"	1-5/16"	1-1/4"		
-10	7/8"	1-9/16"	1-3/8"	1-5/16"		
-12	7/8"	1-1/2"	1-1/2"	1-7/16"	1-7/8"	1-1/8"
-16	1"	1-3/4"	1-13/16"	1-3/4"	2"	1-1/4"
-20		1-7/8"		1-13/16"		1-5/16"



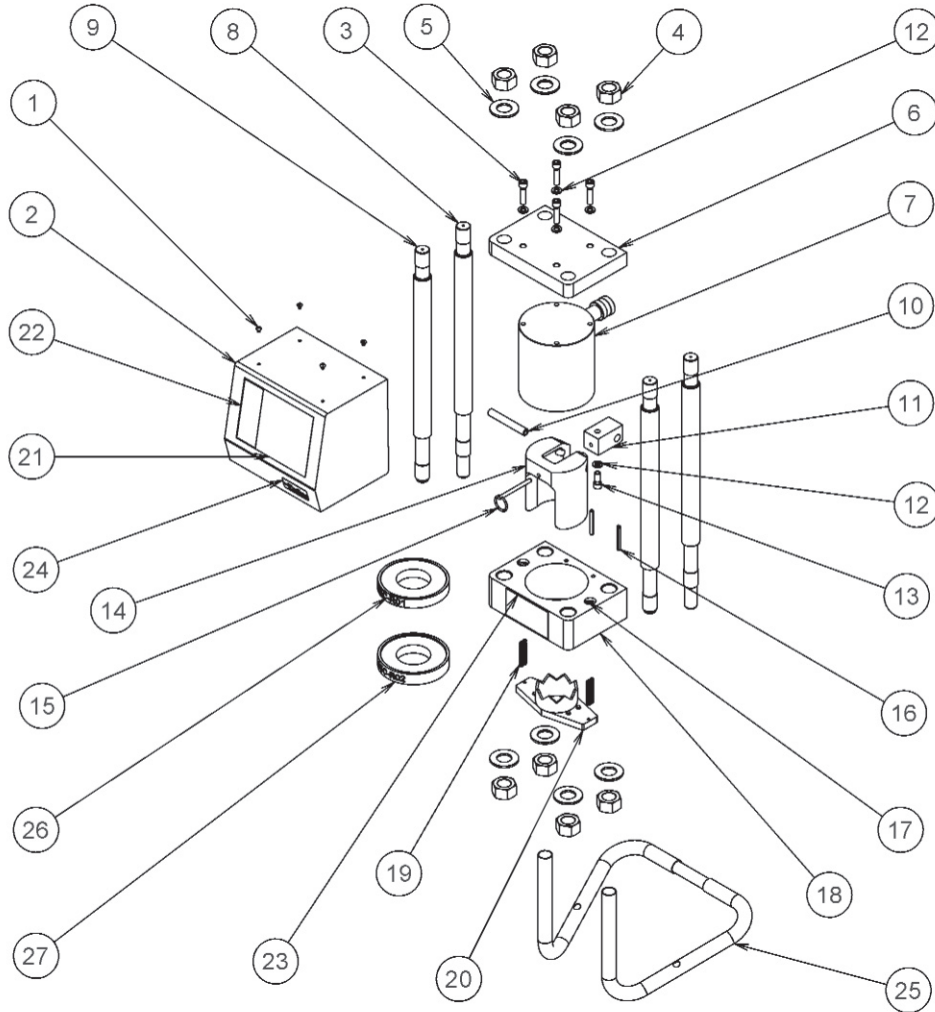

ITEM	QTY	PART NO.	DESCRIPTION
1	4	TH18-B-3	10-24 X 1/4" BHCS
2	1	85C-0CG	Crimper Guard
3	4	TH18-B-1	3/8-16 X 1-1/2" SHCS
4*	8	892033-1	Hex Nut
5*	8	892033-3	Flat Washer
6*	1	85C-0TP	Top Plate
7	1	85C-RAM	Hydraulic Cylinder
8*	2	85C-TIR-A	Rear Tie Rod
9*	2	85C-TIR-B	Front Tie Rod
10	1	TH18-P-1	1/2" X 3-1/2" Spring Pin
11	1	85C-0PB	Pusher Block
12	5	TH18-L-1	3/8" Split Lockwasher
13	1	TH18-B-2	3/8-16 X 7/8" SHCS
14	1	85C-00P	Pusher

ITEM	QTY	PART NO.	DESCRIPTION
15	1	85C-0LP	Locator Speed Pin
16	2	TH18-P-2	1/4" X 2" Spring Pin
17	2	832001	1/8" X 3/4" Spring Pin
18*	1	85C-KBP	Base Plate
19	2	792065	Extension Spring
20	1	85C-00S	Die Seperator
21	1	DEC43-78	Master Crimp Decal
22	1	89C-DEC43-78	Hose Decal
23	1	DEC-CAUTION	Crimp Caution Decal
24	1	881620-B	Parker Logo Decal
25	1	832021	Stand
26	1	85C-R01	Die Ring (Silver)
27	1	85C-R02	Die Ring (Black)

* These components are not sold as individual items, contact Technical Services Department at (440) 943-5700.



If you have a problem with your Karrykrimp 2 machine...

First, check that the proper tooling, hose and fitting combinations are being used.

Then check the following recommendations. If after the following suggested remedy, the problem persists, call our Technical Service Department (440) 943-5700.

SYMPTOMS	POSSIBLE CAUSES	WHAT TO DO
Hand pump, air/hydraulic pump, electric pump, pump hose assembly, quick disconnect problems.		Refer to Enerpac instructions or call Enerpac at 1-800-558-0530
Coupling crimp diameter above or below specification.	Wrong fitting style being used.	Only approved fittings can be used with Karrykrimp 2 machine. For a complete selection and correct combinations of hose and fittings, see Catalog 4400.
	Wrong hose being used.	Only approved hoses can be used with Karrykrimp 2 machine. For a complete selection and correct combinations of hose and fittings, see Catalog 4400.
	Wrong die ring being used.	Refer to die selection chart or Catalog 4400 for correct die ring.
	Pusher is not being bottomed out on die ring and base plate completely (usually inconsistent crimp diameters).	Lubricate die cavity with Citgo MP Lithoplex lithium grease or equivalent. Bottom out the pusher on the die ring completely. Can also check for proper bottoming by placing a piece of paper between die ring and base plate. If properly bottomed, should not be able to remove paper.
	Pump relief valve set too low.	Adjust relief valve setting to 10,000 psi.
	High or low voltage.	Call a qualified electrician.
	Low on oil.	Refill oil reservoir with Enerpac oil.

SYMPTOMS	POSSIBLE CAUSES	WHAT TO DO
Coupling crimp diameter above or below specification.	Crimp dies, die rings damaged, worn, or faulty.	Visually inspect all wear surfaces for raised metal dents or gouges. Replace damaged die sets and die rings. Worn or faulty die sets will crimp above or below specifications by the same amount with and without the die ring. Replace worn or faulty die sets.
	Die cavity in base plate worn or faulty.	<p>Check crimp diameter of several different sizes of die sets with both the silver and black die rings. If all crimp dimeters are out of specification by the same amount, the die cavity in the base plate may be out of specification. Contact Technical Services Department at (440) 943-5700 for repair.</p> <p>Lubricate the die cavity in base plate frequently to prevent wear.</p>

Maintenance

- Check hydraulic oil level every 40 hours of operations.
 - If it is necessary to add oil, use Enerpac oil only.
- Drain and refill the reservoir every 1000 hours of operation.
- Check the crimp bowl weekly for signs of wear.
- Clean the crimp bowl of old grease on a weekly basis. Re-grease the crimp bowl after the bowl has been cleaned.
- Apply approved grease to the dies and crimp bowl each time the dies are changed. If dies are not changed through a day's operation, grease should be applied twice a day.

Safety Guide for Selecting and Using Hose, Fittings and Related Accessories



Parker Safety Guide for Selecting and Using Hose, Tubing, Fittings and Related Accessories

Parker Publication No. 4400-B.1

Revised: May, 2002

WARNING: Failure or improper selection or improper use of hose, tubing, fittings, assemblies or related accessories ("Products") can cause death, personal injury and property damage. Possible consequences of failure or improper selection or improper use of these Products include but are not limited to:

- Fittings thrown off at high speed.
- High velocity fluid discharge.
- Explosion or burning of the conveyed fluid.
- Electrocution from high voltage electric powerlines.
- Contact with suddenly moving or falling objects that are controlled by the conveyed fluid.
- Injections by high-pressure fluid discharge.
- Dangerously whipping Hose.
- Contact with conveyed fluids that may be hot, cold, toxic or otherwise injurious.
- Sparking or explosion caused by static electricity buildup or other sources of electricity.
- Sparking or explosion while spraying paint or flammable liquids.
- Injuries resulting from inhalation, ingestion or exposure to fluids.

Before selecting or using any of these Products, it is important that you read and follow the instructions below. Only Hose from Parker's Stratoflex Products Division is approved for in flight aerospace applications, and no other Hose can be used for such in flight applications.

1.0 GENERAL INSTRUCTIONS

1.1 **Scope:** This safety guide provides instructions for selecting and using (including assembling, installing, and maintaining) these Products. For convenience, all rubber and/or thermoplastic products commonly called "hose" or "tubing" are called "Hose" in this safety guide. All assemblies made with Hose are called "Hose Assemblies". All products commonly called "fittings" or "couplings" are called "Fittings". All related accessories (including crimping and swaging machines and tooling) are called "Related Accessories". This safety guide is a supplement to and is to be used with, the specific Parker publications for the specific Hose, Fittings and Related Accessories that are being considered for use.

1.2 **Fail-Safe:** Hose, and Hose Assemblies and Fittings can and do fail without warning for many reasons. Design all systems and equipment in a fail-safe mode, so that failure of the Hose or Hose Assembly or Fitting will not endanger persons or property.

1.3 **Distribution:** Provide a copy of this safety guide to each person that is responsible for selecting or using Hose and Fitting products. Do not select or use Parker Hose or Fittings without thoroughly reading and understanding this safety guide as well as the specific Parker publications for the products considered or selected.

1.4 **User Responsibility:** Due to the wide variety of operating conditions and applications for Hose and Fittings, Parker and its distributors do not represent or warrant that any particular Hose or Fitting is suitable for any specific end use system. This safety guide does not analyze all technical parameters that must be considered in selecting a product. The user, through its own analysis and testing, is solely responsible for:

- Making the final selection of the Hose and Fitting.
- Assuring that the user's requirements are met and that the application presents no health or safety hazards.
- Providing all appropriate health and safety warnings on the equipment on which the Hose and Fittings are used.
- Assuring compliance with all applicable government and industry standards.

1.5 **Additional Questions:** Call the appropriate Parker technical service department if you have any questions or require any additional information. See the Parker publication for the product being considered or used, or call 1-800-CPARKER, or go to www.parker.com, for telephone numbers of the appropriate technical service department.

2.0 HOSE AND FITTING SELECTION INSTRUCTIONS

2.1 **Electrical Conductivity:** Certain applications require that the Hose be nonconductive to prevent electrical current flow. Other applications require the Hose and the Fitting and the Hose/Fitting interface to be sufficiently conductive to drain off static electricity. Extreme care must be exercised when selecting Hose and Fittings for these or any other applications in which electrical conductivity or nonconductivity is a factor.

The electrical conductivity or nonconductivity of Hose and Fittings is dependent upon many factors and may be susceptible to change. These factors include but are not limited to the various materials used to make the Hose and the Fittings,

Fitting finish (some Fitting finishes are electrically conductive while others are nonconductive), manufacturing methods (including moisture control), how the Fittings contact the Hose, age and amount of deterioration or damage or other changes, moisture content of the Hose at any particular time, and other factors.

The following are considerations for electrically nonconductive and conductive Hose. For other applications consult the individual catalog pages and the appropriate industry or regulatory standards for proper selection.

2.1.1 **Electrically Nonconductive Hose:** Certain applications require that the Hose be nonconductive to prevent electrical current flow or to maintain electrical isolation. For these applications that require Hose to be electrically nonconductive, including but not limited to applications near high voltage electric lines, only special nonconductive Hose can be used. The manufacturer of the equipment in which the nonconductive Hose is to be used must be consulted to be certain that the Hose and Fittings that are selected are proper for the application. Do not use any Parker Hose or Fitting for any such application requiring nonconductive Hose, including but not limited to applications near high voltage electric lines, unless (i) the application is expressly approved in the Parker technical publication for the product, (ii) the Hose is marked "nonconductive", and (iii) the manufacturer of the equipment on which the Hose is to be used specifically approves the particular Parker Hose and Fitting for such use.

2.1.2 **Electrically Conductive Hose:** Parker manufacturers special Hose for certain applications that require electrically conductive Hose. Parker manufactures special Hose for conveying paint in airless paint spraying applications. This Hose is labeled "Electrically Conductive Airless Paint Spray Hose" on its layline and packaging. This Hose must be properly connected to the appropriate Parker Fittings and properly grounded in order to dissipate dangerous static charge buildup, which occurs in all airless paint spraying applications. Do not use any other Hose for airless paint spraying, even if electrically conductive. Use of any other Hose or failure to properly connect the Hose can cause a fire or an explosion resulting in death, personal injury, and property damage. Parker manufactures a special Hose for certain compressed natural gas ("CNG") applications where static electricity buildup may occur. Parker CNG Hose assemblies comply with AGA Requirements 1-93, "Hoses for Natural Gas Vehicles and Fuel Dispensers". This Hose is labeled "Electrically Conductive for CNG Use" on its layline and packaging. This Hose must be properly connected to the appropriate Parker Fittings and properly grounded in order to dissipate dangerous static charge buildup, which occurs in, for example, high velocity CNG dispensing or transfer. Do not use any other Hose for CNG applications where static charge buildup may occur, even if electrically conductive. Use of other Hoses in CNG applications or failure to properly connect or ground this Hose can cause a fire or an explosion resulting in death, personal injury, and property damage. Care must also be taken to protect against CNG permeation through the Hose wall. See section 2.6, Permeation, for more information. Parker CNG Hose is intended for dispenser and vehicle use at a maximum temperature of 180°F. Parker CNG Hose should not be used in confined spaces or unventilated areas or areas exceeding 180°F. Final assemblies must be tested for leaks. CNG Hose Assemblies should be tested on a monthly basis for conductivity per AGA 1-93.



Safety Guide for Selecting and Using Hose, Fittings and Related Accessories

Parker manufacturers special Hose for aerospace in flight applications. Aerospace in flight applications employing Hose to transmit fuel, lubricating fluids and hydraulic fluids require a special Hose with a conductive inner tube. This Hose for in flight applications is available only from Parker's Stratoflex Products Division. Do not use any other Parker Hose for in flight applications, even if electrically conductive. Use of other Hoses for in flight applications or failure to properly connect or ground this Hose can cause a fire or an explosion resulting in death, personal injury, and property damage. These Hose assemblies for in flight applications must meet all applicable aerospace industry, aircraft engine, and aircraft requirements.

2.2 Pressure: Hose selection must be made so that the published maximum recommended working pressure of the Hose is equal to or greater than the maximum system pressure. Surge pressures or peak transient pressures in the system must be below the published maximum working pressure for the Hose. Surge pressures and peak pressures can usually only be determined by sensitive electrical instrumentation that measures and indicates pressures at millisecond intervals. Mechanical pressure gauges indicate only average pressures and cannot be used to determine surge pressures or peak transient pressures. Published burst pressure ratings for Hose is for manufacturing test purposes only and is no indication that the Product can be used in applications at the burst pressure or otherwise above the published maximum recommended working pressure.

2.3 Suction: Hoses used for suction applications must be selected to insure that the Hose will withstand the vacuum and pressure of the system. Improperly selected Hose may collapse in suction application.

2.4 Temperature: Be certain that fluid and ambient temperatures, both steady and transient, do not exceed the limitations of the Hose. Temperatures below and above the recommended limit can degrade Hose to a point where a failure may occur and release fluid. Properly insulate and protect the Hose Assembly when routing near hot objects (e.g. manifolds). Do not use any Hose in any application where failure of the Hose could result in the conveyed fluids (or vapors or mist from the conveyed fluids) contacting any open flame, molten metal, or other potential fire ignition source that could cause burning or explosion of the conveyed fluids or vapors.

2.5 Fluid Compatibility: Hose Assembly selection must assure compatibility of the Hose tube, cover, reinforcement, and Fittings with the fluid media used. See the fluid compatibility chart in the Parker publication for the product being considered or used. This information is offered only as a guide. Actual service life can only be determined by the end user by testing under all extreme conditions and other analysis.

Hose that is chemically compatible with a particular fluid must be assembled using Fittings and adapters containing likewise compatible seals.

2.6 Permeation: Permeation (that is, seepage through the Hose) will occur from inside the Hose to outside when Hose is used with gases, liquid and gas fuels, and refrigerants (including but not limited to such materials as helium, diesel fuel, gasoline, natural gas, or LPG). This permeation may result in high concentrations of vapors which are potentially flammable, explosive, or toxic, and in loss of fluid. Dangerous explosions, fires, and other hazards can result when using the wrong Hose for such applications. The system designer must take into account the fact that this permeation will take place and must not use Hose if this permeation could be hazardous. The system designer must take into account all legal, government, insurance, or any other special regulations which govern the use of fuels and refrigerants. Never use a Hose even though the fluid compatibility is acceptable without considering the potential hazardous effects that can result from permeation through the Hose Assembly.

Permeation of moisture from outside the Hose to inside the Hose will also occur in Hose assemblies, regardless of internal pressure. If this moisture permeation would have detrimental effects (particularly, but not limited to refrigeration and air conditioning systems), incorporation of sufficient drying capacity in the system or other appropriate system safeguards should be selected and used.

2.7 Size: Transmission of power by means of pressurized fluid varies with pressure and rate of flow. The size of the components must be adequate to keep pressure losses to a minimum and avoid damage due to heat generation or excessive fluid velocity.

2.8 Routing: Attention must be given to optimum routing to minimize inherent problems (kinking or flow restriction due to Hose collapse, twisting of the Hose, proximity to hot objects or heat sources).

2.9 Environment: Care must be taken to insure that the Hose and Fittings are either compatible with or protected from the environment (that is, surrounding conditions) to which they are exposed. Environmental conditions including but not limited to ultraviolet radiation, sunlight, heat, ozone, moisture, water, salt water, chemicals, and air pollutants can cause degradation and premature failure.

2.10 Mechanical Loads: External forces can significantly reduce Hose life or cause failure. Mechanical loads which must be considered include excessive flexing, twist, kinking, tensile or side loads, bend radius, and vibration. Use of swivel type Fittings or adapters may be required to insure no twist is put

into the Hose. Unusual applications may require special testing prior to Hose selection.

2.11 Physical Damage: Care must be taken to protect Hose from wear, snagging, kinking, bending smaller than minimum bend radius, and cutting, any of which can cause premature Hose failure. Any Hose that has been kinked or bent to a radius smaller than the minimum bend radius, and any Hose that has been cut or is cracked or is otherwise damaged, should be removed and discarded.

2.12 Proper End Fitting: See instructions 3.2 through 3.5. These recommendations may be substantiated by testing to industry standards such as SAE J517 for hydraulic applications, or MIL-A-5070, AS1339, or AS3517 for Hoses from Parker's Stratoflex Products Division for aerospace applications.

2.13 Length: When establishing a proper Hose length, motion absorption, Hose length changes due to pressure, and Hose and machine tolerances and movement must be considered.

2.14 Specifications and Standards: When selecting Hose and Fittings, government, industry, and Parker specifications and recommendations must be reviewed and followed as applicable.

2.15 Hose Cleanliness: Hose components may vary in cleanliness levels. Care must be taken to insure that the Hose Assembly selected has an adequate level of cleanliness for the application.

2.16 Fire Resistant Fluids: Some fire resistant fluids that are to be conveyed by Hose require use of the same type of Hose as used with petroleum base fluids. Some such fluids require a special Hose, while a few fluids will not work with any Hose at all. See instructions 2.5 and 1.5. The wrong Hose may fail after a very short service. In addition, all liquids but pure water may burn fiercely under certain conditions, and even pure water leakage may be hazardous.

2.17 Radiant Heat: Hose can be heated to destruction without contact by such nearby items as hot manifolds or molten metal. The same heat source may then initiate a fire. This can occur despite the presence of cool air around the Hose.

2.18 Welding or Brazing: When using a torch or arc-welder in close proximity to hydraulic lines, the hydraulic lines should be removed or shielded with appropriate fire resistant materials. Flame or weld spatter could burn through the Hose and possibly ignite escaping fluid resulting in a catastrophic failure. Heating of plated parts, including Hose Fittings and adapters, above 450°F (232°C) such as during welding, brazing, or soldering may emit deadly gases.

2.19 Atomic Radiation: Atomic radiation affects all materials used in Hose assemblies. Since the long-term effects may be unknown, do not expose Hose assemblies to atomic radiation.

2.20 Aerospace Applications: The only Hose and Fittings that may be used for in flight aerospace applications are those available from Parker's Stratoflex Products Division. Do not use any other Hose or Fittings for in flight applications. Do not use any Hose or Fittings from Parker's Stratoflex Products Division with any other Hose or Fittings, unless expressly approved in writing by the engineering manager or chief engineer of Stratoflex Products Division and verified by the user's own testing and inspection to aerospace industry standards.

2.21 Unlocking Couplings: Ball locking couplings or other couplings with disconnect sleeves can unintentionally disconnect if they are dragged over obstructions or if the sleeve is bumped or moved enough to cause disconnect. Threaded couplings should be considered where there is a potential for accidental uncoupling.

3.0 HOSE AND FITTING ASSEMBLY AND INSTALLATION INSTRUCTIONS

3.1 Component Inspection: Prior to assembly, a careful examination of the Hose and Fittings must be performed. All components must be checked for correct style, size, catalog number, and length. The Hose must be examined for cleanliness, obstructions, blisters, cover looseness, kinks, cracks, cuts or any other visible defects. Inspect the Fitting and sealing surfaces for burrs, nicks, corrosion or other imperfections. Do NOT use any component that displays any signs of nonconformance.

3.2 Hose and Fitting Assembly: Do not assemble a Parker Fitting on a Parker Hose that is not specifically listed by Parker for that Fitting, unless authorized in writing by the engineering manager or chief engineer of the appropriate Parker division. Do not assemble a Parker Fitting on another manufacturer's Hose or a Parker Hose on another manufacturer's Fitting unless (i) the engineering manager or chief engineer of the appropriate Parker division approves the Assembly in writing or that combination is expressly approved in the appropriate Parker literature for the specific Parker product, and (ii) the user verifies the Assembly and the application through analysis and testing. For Parker Hose



Safety Guide for Selecting and Using Hose, Fittings and Related Accessories

that does not specify a Parker Fitting, the user is solely responsible for the selection of the proper Fitting and Hose Assembly procedures. See instruction 1.4. The Parker published instructions must be followed for assembling the Fittings on the Hose. These instructions are provided in the Parker Fitting catalog for the specific Parker Fitting being used, or by calling 1-800-CPARKER, or at www.parker.com.

3.3 Related Accessories: Do not crimp or swage any Parker Hose or Fitting with anything but the listed swage or crimp machine and dies in accordance with Parker published instructions. Do not crimp or swage another manufacturer's Fitting with a Parker crimp or swage die unless authorized in writing by the engineering manager or chief engineer of the appropriate Parker division.

3.4 Parts: Do not use any Parker Fitting part (including but not limited to socket, shell, nipple, or insert) except with the correct Parker mating parts, in accordance with Parker published instructions, unless authorized in writing by the engineering manager or chief engineer of the appropriate Parker division.

3.5 Reusable/Permanent: Do not reuse any field attachable (reusable) Hose Fitting that has blown or pulled off a Hose. Do not reuse a Parker permanent Hose Fitting (crimped or swaged) or any part thereof. Complete Hose Assemblies may only be reused after proper inspection under section 4.0. Do not assemble Fittings to any previously used hydraulic Hose that was in service, for use in a fluid power application.

3.6 Pre-Installation Inspection: Prior to installation, a careful examination of the Hose Assembly must be performed. Inspect the Hose Assembly for any damage or defects. Do NOT use any Hose Assembly that displays any signs of nonconformance.

3.7 Minimum Bend Radius: Installation of a Hose at less than the minimum listed bend radius may significantly reduce the Hose life. Particular attention must be given to preclude sharp bending at the Hose to Fitting juncture. Any bending during installation at less than the minimum bend radius must be avoided. If any Hose is kinked during installation, the Hose must be discarded.

3.8 Twist Angle and Orientation: Hose Assembly installation must be such that relative motion of machine components does not produce twisting.

3.9 Securement: In many applications, it may be necessary to restrain, protect, or guide the Hose to protect it from damage by unnecessary flexing, pressure surges, and contact with other mechanical components. Care must be taken to insure such restraints do not introduce additional stress or wear points.

3.10 Proper Connection of Ports: Proper physical installation of the Hose Assembly requires a correctly installed port connection insuring that no twist or torque is transferred to the Hose when the Fittings are being tightened or otherwise during use.

3.11 External Damage: Proper installation is not complete without insuring that tensile loads, side loads, kinking, flattening, potential abrasion, thread damage, or damage to sealing surfaces are corrected or eliminated. See instruction 2.10.

3.12 System Checkout: All air entrapment must be eliminated and the system pressurized to the maximum system pressure (at or below the Hose maximum working pressure) and checked for proper function and freedom from leaks. Personnel must stay out of potential hazardous areas while testing and using.

3.13 Routing: The Hose Assembly should be routed in such a manner so if a failure does occur, the escaping media will not cause personal injury or property damage. In addition, if fluid media comes in contact with hot surfaces, open flame, or sparks, a fire or explosion may occur. See section 2.4.

4.0 HOSE AND FITTING MAINTENANCE AND REPLACEMENT INSTRUCTIONS

4.1 Even with proper selection and installation, Hose life may be significantly reduced without a continuing maintenance program. The severity of the application, risk potential from a possible Hose failure, and experience with any Hose failures in the application or in similar applications should determine the frequency of the inspection and the replacement of the Products so that Products are replaced before any failure occurs. A maintenance program must be established and followed by the user and, at minimum, must include instructions 4.2 through 4.7.

4.2 Visual Inspection Hose/Fitting: Any of the following conditions require immediate shut down and replacement of the Hose Assembly:

- Fitting slippage on Hose,

• Damaged, cracked, cut or abraded cover (any reinforcement exposed);

- Hard, stiff, heat cracked, or charred Hose;
- Cracked, damaged, or badly corroded Fittings;
- Leaks at Fitting or in Hose;
- Kinked, crushed, flattened or twisted Hose; and
- Blistered, soft, degraded, or loose cover.

4.3 Visual Inspection All Other: The following items must be tightened, repaired, corrected or replaced as required:

- Leaking port conditions;
- Excess dirt buildup;
- Worn clamps, guards or shields; and
- System fluid level, fluid type, and any air entrapment.

4.4 Functional Test: Operate the system at maximum operating pressure and check for possible malfunctions and leaks. Personnel must avoid potential hazardous areas while testing and using the system. See section 2.2.

4.5 Replacement Intervals: Hose assemblies and elastomeric seals used on Hose Fittings and adapters will eventually age, harden, wear and deteriorate under thermal cycling and compression set. Hose Assemblies and elastomeric seals should be inspected and replaced at specific replacement intervals, based on previous service life, government or industry recommendations, or when failures could result in unacceptable downtime, damage, or injury risk. See section 1.2.

4.6 Hose Inspection and Failure: Hydraulic power is accomplished by utilizing high-pressure fluids to transfer energy and do work. Hoses, Fittings, and Hose Assemblies all contribute to this by transmitting fluids at high pressures. Fluids under pressure can be dangerous and potentially lethal and, therefore, extreme caution must be exercised when working with fluids under pressure and handling the Hoses transporting the fluids. From time to time, Hose Assemblies will fail if they are not replaced at proper time intervals. Usually these failures are the result of some form of misapplication, abuse, wear, or failure to perform proper maintenance. When Hoses fail, generally the high-pressure fluids inside escape in a stream which may or may not be visible to the user. Under no circumstances should the user attempt to locate the leak by "feeling" with their hands or any other part of their body. High-pressure fluids can and will penetrate the skin and cause severe tissue damage and possibly loss of limb. Even seemingly minor hydraulic fluid injection injuries must be treated immediately by a physician with knowledge of the tissue damaging properties of hydraulic fluid.

If a Hose failure occurs, immediately shut down the equipment and leave the area until pressure has been completely released from the Hose Assembly. Simply shutting down the hydraulic pump may or may not eliminate the pressure in the Hose Assembly. Many times check valves, etc., are employed in a system and can cause pressure to remain in a Hose Assembly even when pumps or equipment are not operating. Tiny holes in the Hose, commonly known as pinholes, can eject small, dangerously powerful but hard to see streams of hydraulic fluid. It may take several minutes or even hours for the pressure to be relieved so that the Hose Assembly may be examined safely.

Once the pressure has been reduced to zero, the Hose Assembly may be taken off the equipment and examined. It must always be replaced if a failure has occurred. Never attempt to patch or repair a Hose Assembly that has failed. Consult the nearest Parker distributor or the appropriate Parker division for Hose Assembly replacement information.

Never touch or examine a failed Hose Assembly unless it is obvious that the Hose no longer contains fluid under pressure. The high-pressure fluid is extremely dangerous and can cause serious and potentially fatal injury.

4.7 Elastomeric seals: Elastomeric seals will eventually age, harden, wear and deteriorate under thermal cycling and compression set. Elastomeric seals should be inspected and replaced.

4.8 Refrigerant gases: Special care should be taken when working with refrigeration systems. Sudden escape of refrigerant gases can cause blindness if the escaping gases contact the eye and can cause freezing or other severe injuries if it contacts any other portion of the body.

4.9 Compressed natural gas (CNG): Parker CNG Hose Assemblies should be tested after installation and before use, and at least on a monthly basis per AGA 1-93 Section 4.2 "Visual Inspection Hose/Fitting". The recommended procedure is to pressurize the Hose and check for leaks and to visually inspect the Hose for damage.

Caution: Matches, candles, open flame or other sources of ignition shall not be used for Hose inspection. Leak check solutions should be rinsed off after use.

MSDS'S (Available upon request.)

Federal OSHA regulation 29 CFR 1910.1200 requires that we transmit to our customers Material Safety Data Sheets for all material covered under the law. If you are an employer in SIC 20-39 who has not yet received them, you are required to obtain them from us and provide the information to employees as directed in Section (b) of the regulation. Please contact the Hose Products Division - Technical Services Department: (PH) 440- 943-5700 (FAX) 440- 943-3129.



The items described in this document and other documents or descriptions provided by Parker Hannifin Corporation, as subsidiaries and its authorized distributors are hereby offered for sale at prices to be established by Parker Hannifin Corporation, its subsidiaries and its authorized distributors. This offer and its acceptance by any customer ("Buyer") shall be governed by all of the following Terms and Conditions. Buyer's order for any such item, when communicated to Parker Hannifin Corporation, its subsidiary or an authorized distributor ("Seller") verbally or in writing, shall constitute acceptance of this offer.

1. **Terms and Conditions of Sale:** All descriptions, quotations, proposals, offers, acknowledgments, acceptances and sales of Seller's products are subject to and shall be governed exclusively by the terms and conditions stated herein. Buyer's acceptance of any offer to sell is limited to these terms and conditions. Any terms or conditions in addition to, or inconsistent with those stated herein, proposed by Buyer in any acceptance of an offer by Seller, are hereby objected to. No such additional, different or inconsistent terms and conditions shall become part of the contract between Buyer and Seller unless expressly accepted in writing by Seller. Seller's acceptance of any offer to purchase by Buyer is expressly conditional upon Buyer's assent to all the terms and conditions stated herein, including any terms in addition to, or inconsistent with those contained in Buyer's offer. Acceptance of Seller's products shall in all events constitute such assent.

2. **Payment:** Payment shall be made by Buyer net 30 days from the date of delivery of the items purchased hereunder. Any claims by Buyer for omissions or shortages in a shipment shall be waived unless Seller receives notice thereof within 30 days after Buyer's receipt of the shipment.

3. **Delivery:** Unless otherwise provided on the face hereof, delivery shall be made F.O.B. Seller's plant. Regardless of the method of delivery, however, risk of loss shall pass to Buyer upon Seller's delivery to a carrier. Any delivery dates shown are approximate only and Seller shall have no liability for any delays in delivery.

4. **Warranty:** Seller warrants that the items sold thereunder shall be free from defects in material or workmanship for a period of 365 days from the date of shipment to Buyer, or 2,000 hours of use, whichever expires first. THIS WARRANTY COMPRISES THE SOLE AND ENTIRE WARRANTY PERTAINING TO ITEMS PROVIDED HEREUNDER. SELLER MAKES NO OTHER WARRANTY, GAURANTEE, OR REPRESENTATION OF ANY KIND WHATSOEVER. ALL OTHER WARRANTIES, INCLUDING BUT NOT LIMITED TO, MERCHANTABILITY AND FITNESS FOR PURPOSE, WHETHER EXPRESS, IMPLIED, OR ARISING BY OPERATION OF LAW, TRADE USAGE, OR COURSE OF DEALING ARE HEREBY DISCLAIMED. NOTWITHSTANDING THE FOREGOING, THERE ARE NO WARRANTIES WHATSOEVER ON ITEMS BUILT OR ACQUIRED WHOLELY OR PARTIALLY, TO BUYER'S DESIGNS OR SPECIFICATIONS.

5. **Limitation Of Remedy:** SELLER'S LIABILITY ARISING FROM OR IN ANY WAY CONNECTED WITH THE ITEMS SOLD OR THIS CONTRACT SHALL BE LIMITED EXCLUSIVELY TO REPAIR OR REPLACEMENT OF THE ITEMS SOLD OR REFUND OF THE PURCHASE PRICE PAID BY BUYER, AT SELLER'S SOLE OPTION. IN NO EVENT SHALL SELLER BE LIABLE FOR ANY INCIDENTAL, CONSEQUENTIAL OR SPECIAL DAMAGES OF ANY KIND OR NATURE WHATSOEVER, INCLUDING BUT NOT LIMITED TO LOST PROFITS ARISING FROM OR IN ANY WAY CONNECTED WITH THIS AGREEMENT OR ITEMS SOLD HEREUNDER, WHETHER ALLEGED TO ARISE FROM BREACH OF CONTRACT, EXPRESS OR IMPLIED WARRANTY, OR IN TORT, INCLUDING WITHOUT LIMITATION, NEGLIGENCE, FAILURE TO WARN OR STRICT LIABILITY.

6. **Changes, Reschedules and Cancellations:** Buyer may request to modify the designs or specifications for the items sold herunder as well as the quantities and delivery dates thereof, or may request to cancel all or part of this order, however, no such requested modification or cancellation shall become part of the contract between Buyer and Seller unless accepted by Seller in a written amendment to this Agreement. Acceptance of any such requested modification or cancellation shall be at Seller's discretion, and shall be upon such terms and conditions as Seller may require.

7. **Special Tooling:** A tooling charge may be imposed for any special tooling, including without limitation, dies, fixtures, molds and patterns, acquired to manufacture items sold pursuant to this contract. Such special tooling shall be and remain Seller's property notwithstanding payment of any charges by Buyer. In no event will Buyer acquire any interest in apparatus belonging to Seller which is utilized in the manufacture of the items sold hereunder, even if such apparatus has been specially

converted or adapted for such manufacture and notwithstanding any charges paid by Buyer. Unless otherwise agreed, Seller shall have the right to alter, discard or otherwise dispose of any special tooling or other property in its sole discretion at any time.

8. **Buyer's Property:** Any designs, tools, patterns, materials, drawings, confidential information or equipment furnished by Buyer or any other items which become Buyer's property, may be considered obsolete and may be destroyed by Seller after two (2) consecutive years have elapsed without Buyer placing an order for the items which are manufactured using such property. Seller shall not be responsible for any loss or damage to such property while it is in Seller's possession or control.

9. **Taxes:** Unless otherwise indicated on the face hereof, all prices and charges are exclusive of excise, sales, use, property, occupational or like taxes which may be imposed by any taxing authority upon the manufacture, sale or delivery of the items sold hereunder. If any such taxes must be paid by Seller of if Seller is liable for the collection of such tax, the amount thereof shall be in addition to the amounts for the items sold. Buyer agrees to pay all such taxes or to reimburse Seller therefore upon receipt of its invoice. If Buyer claims exemption from any sales, use or other tax imposed by any taxing authority, Buyer shall save Seller harmless from and against any such tax, together with any interest or penalties thereon which may be assessed if the items are held to be taxable.

10. **Indemnity For Infringement of Intellectual Property Rights:** Seller shall have no liability for infringement of any patents, trademarks, copyrights, trade dress, trade secrets or similar rights except as provided in this Part 10. Seller will defend and indemnify Buyer against allegations of infringement of U.S. patents, U.S. trademarks, copyrights, trade dress and trade secrets (hereinafter "Intellectual Property Rights"). Seller will defend at its expense and will pay the cost of any settlement or damages awarded in an action brought against Buyer based on an allegation that an item sold pursuant to this contract infringes in the Intellectual Property Rights of a third party. Seller's obligation to defend and indemnify Buyer is contingent on Buyer notifying Seller within ten (10) days after Buyer becomes aware of such allegations of infringement, and Seller having sole control over the defense of any allegations or actions including all negotiations for settlement or compromise. If an item sold hereunder is subject to a claim that it infringes the Intellectual Property Rights of a third party, Seller may, at its sole expense and options, procure for Buyer the right to continue using said item, replace or modify said item so as to make it noninfringing, or offer to accept return of said item and return the purchase price less a reasonable allowance for depreciation. Notwithstanding the foregoing, Seller shall have no liability for claims of infringement based on information provided by Buyer, or directed to items delivered hereunder for which the designs are specified in whole or part by Buyer, or infringements resulting from the modification, combination or use in a system of any item sold hereunder. The foregoing provisions of this Part 10 shall constitute Seller's sole and exclusive liability and Buyer's sole and exclusive remedy for infringement of Intellectual Property Rights.

If a claim is based on information provided by Buyer or if the design for an item delivered hereunder is specified in whole or in part by Buyer, Buyer shall defend and indemnify Seller for all costs, expenses or judgments resulting from any claim that such item infringes any patent, trademark, copyright, trade dress, trade secret or any similar right.

11. **Force Majeure:** Seller does not assume the risk of and shall not be liable for delay or failure to perform any of Seller's obligations by reason of circumstances beyond the reasonable control of Seller (hereinafter "Events of Force Majeure"). Events of Force Majeure shall include without limitation, accidents, acts of God, strikes or labor disputes, acts, laws, rules or regulations of any government or government agency, fires, floods, delays or failures in delivery of carriers or suppliers, shortages of materials and any other cause beyond Seller's control.

12. **Entire Agreement/Governing Law:** The terms and conditions set forth herein, together with any amendments, modifications and any different terms or conditions expressly accepted by Seller in writing, shall constitute the entire Agreement concerning the items sold, and there are no oral or other representations or agreements which pertain thereto. This Agreement shall be governed in all respects by the law of the State of Ohio. No actions arising out of the sale of the items sold hereunder or this Agreement may be brought by either party more than two (2) years after the cause of action accrues.





Parker Hannifin Corporation
Hose Products Division
30240 Lakeland Boulevard
Wickliffe, OH 44092
Phone: (440) 943-5700
Fax: (440) 943-3129
www.parkerhose.com

Bulletin 4480-T7-US 7/05 - 1M
©Parker Hannifin Corporation Printed in U.S.A

Free Manuals Download Website

<http://myh66.com>

<http://usermanuals.us>

<http://www.somanuals.com>

<http://www.4manuals.cc>

<http://www.manual-lib.com>

<http://www.404manual.com>

<http://www.luxmanual.com>

<http://aubethermostatmanual.com>

Golf course search by state

<http://golfingnear.com>

Email search by domain

<http://emailbydomain.com>

Auto manuals search

<http://auto.somanuals.com>

TV manuals search

<http://tv.somanuals.com>