



Lyric 50 M

Gas Cooker

Owners handbook
and
Installation instructions

Introduction

This gas cooker has been designed and manufactured to all the necessary British Standards. The cooker complies with European Council Directive 90/396/EEC. It also carries the C.E. mark.

It is important that you understand how to use and care for the cooker properly before you use it for the first time.

We have written this booklet with your safety in mind. Read the booklet thoroughly before you use the cooker. Keep the booklet in a safe place so that anyone who uses the cooker can read it. Pass the booklet on with the cooker if you give or sell it to someone else.

For your safety

This cooker is designed for domestic use to cook food. You must not use it for any other purpose. It is not designed for commercial use.

Keep children, babies and toddlers away from the cooker at all times.

The installation instructions tell you how and where it can be fitted. If the cooker is already installed you must make sure that all instructions have been followed. If you are in any doubt ask a registered person. More details on installation on page 23.

We have included several drawings to show the right and wrong way of doing things.

The right way will have a smiling face by it.



A sad face shows something is wrong.



Do not remove the rating plate from the cooker as this may invalidate the guarantee.

Contents	Page
Lighting the cooker	4
The grill	6
The hotplate	8
The oven	11
Oven cooking chart	13
Slow cooking	16
Care and cleaning	19
Installing the cooker	23
General information	25
What is wrong and why?	27
Servicing	29
Installation Instructions	31
Technical data	32
Safety requirements/ventilation	33
Location of appliance/installation	34
Testing	36

Lighting the cooker

The ignition system works by means of a battery. Details on how to replace the battery are given on page 25.

Grill and hotplate

To light:

- 1 Push in the control knob and turn to the large flame symbol (highest setting), and press the ignition button immediately. When the burner has lit release the button.

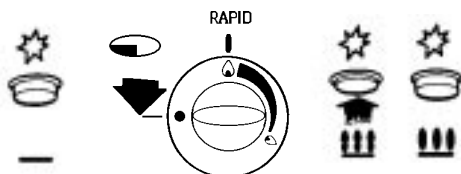

Warning: If the ignition button is not pressed immediately a build up of gas may cause the flame to spread.

For your safety

Never cover the grill pan or grid with foil as this can lead to grill fires.

Oven

To light:

- 1 Open the oven door.
- 2 Push in the control knob and turn it to gas mark 9 and press the ignition button immediately. When the burner has lit release the button. There will only be small flames at first.

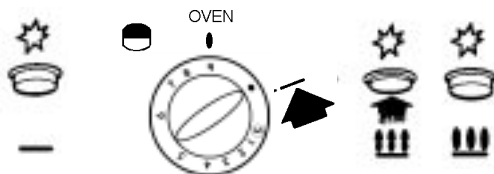

- 3 Now turn the control knob to the gas mark you want.
- 4 Wait until the burner is showing large flames.
5. Close the oven door.

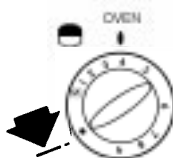

To turn off any burner

- 1 Push in the control knob and turn it to the off position. This is shown by a large dot.

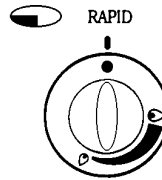
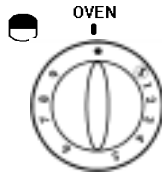

For your safety

When you are lighting any burner check that it has lit before you leave the cooker.

When you are turning off a burner, do not leave the cooker until the flame has gone out.

The grill

The grill is a high-speed grill. The instructions below tell you how to vary the heat setting and how to change the height of the grid to suit the food you are cooking. You should remember to turn the food regularly.

You should not use the grill to keep food warm as it will continue to cook food.

For your safety

Never cover the grill pan or grid with foil as this can lead to grill fires.

Heat control

The grill control gives two heat settings.

The control knob turns to the left from 'OFF' to 'HIGH' and then to 'LOW'. The high setting should be used for fast cooking such as toast. Use the low setting to cook thicker food such as chicken after it has been browned on the high setting.

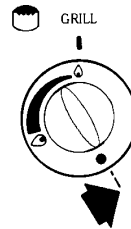

Cooking positions

Place the grill pan so that the bottom of the handle fits into the hole on the shelf.

Most food should be cooked on the grid in the grill pan. The grid can be turned over to suit different thicknesses of food.

You can place some dishes straight on to the grill shelf. This is useful when you are browning the top of food such as cauliflower cheese.

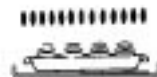

Preheating

You don't usually need to preheat the grill. You may wish to preheat it for a couple of minutes when you are cooking steak or when browning food.

Positioning food on the grid

Place food such as toast, teacakes and muffins towards the centre of the grid.

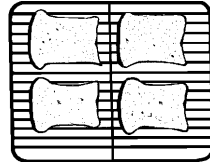

Place food which needs a more gentle heat such as tomatoes and mushrooms towards the edge of the grid.

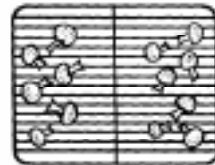

Arrange meat, meat products and fish to suit their thickness and how you like them cooked.

The hotplate

Heat control

The hotplate control knobs turn anticlockwise from 'OFF' to 'HIGH' and then to 'LOW'. You can adjust the heat by turning the control between the highest and lowest settings. These are shown as a large and a small flame symbol.

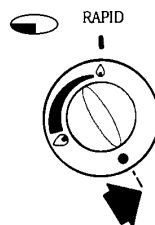

Burner sizes

The hotplate has three burner sizes to suit different types of cooking:

Largest burner (Rapid) - use a large pan for food such as chips.

Medium burners (Normal) - use for everyday cooking.

Small burner (Simmer) - use for simmering food such as soups and stews.

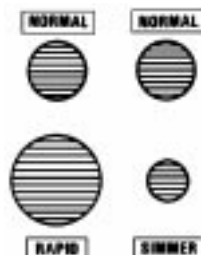

The largest pan which you should use on any burner is 230mm (9").
The base of the smallest pan should not measure less than 100mm (4").



For your Safety



1 Take care to avoid burns and scalds when you are reaching across the hotplate.

2  Use pans with flat bases. They are more stable than pans which are warped.



3  Do not use pans with very heavy handles which cause the pan to tip.



4  Put pans on the centre of the burners.



5  Position pan handles so they cannot be accidentally knocked.



6  Take extra care when you are deep fat frying. Do not cover the pan with a lid.



Do not leave a pan unattended. If the pan catches fire, leave it where it is and turn off all controls.



Place a damp cloth or a fitting lid over the pan to smother the flames.

Never put water on the fire.



Leave the pan to cool for 30 minutes.

7  If you are using a Wok we recommend it has a flat base as it will stand stable on the pan supports. If you use a round based Wok with a collar support, the collar must be of the open wire work type. A closed collar will affect the performance of the burner. Before you use the Wok make sure that the collar is stable on the pan supports. Always follow the instructions that come with the Wok.





Helpful hints



1



Keep flames under the base of pans. If the flames lick round the sides of the pans you are wasting gas.



2



Only heat the amount of liquid you need. Do not overfill pans.



3



Cover pans with a lid whenever possible. The food will heat up more quickly and there will be less steam in the kitchen.



4



Try cooking more than one vegetable in the same pan, for example potatoes and carrots.

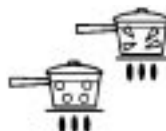

5



Cut vegetables into smaller pieces. This way they will cook more quickly.



6

A pressure cooker will save time and energy.

The oven

Before you use the oven you should wipe it out with a damp cloth to remove any dust.

Heat zones

There are zones of heat within the oven. The temperature in the middle is the gas mark you have chosen. The top of the oven is slightly hotter and the lower shelf slightly cooler. The base of the oven is quite a lot cooler. You can make use of these heat zones when you are cooking foods requiring different temperatures all at the same time.



If you are cooking more than one tray of similar items, for example cakes or biscuits, swap the trays during cooking or you can remove the top tray when the food is cooked and move the lower tray to the higher shelf to finish cooking.

Preheating

You do not need to preheat the oven when casseroles and so on.

Preheat the oven for baking or when you are cooking sensitive food such as Yorkshire puddings, soufflés and yeast mixtures.

When you are cooking or reheating frozen or chilled food read the instructions on the packing.

When you need to preheat the oven, we recommend you do so for 20 minutes.



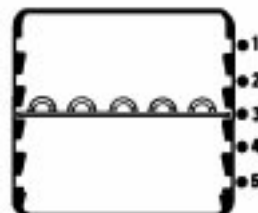

Oven Shelves

You can slot the oven shelves in any of five positions. Positions are counted from the top downwards.

For safety the shelf will only pull out so far. If you want to remove a shelf completely pull it forward as far as it will go, raise the front edge and lift it out. To put the shelf into a different position keep the front edge raised, slot the shelf on to the runner, lower the front edge and slide the shelf in.

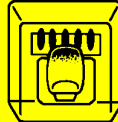

Baking trays and dishes

For your safety	
 	 
	
	

For the best results we recommend that you use a baking tray which is 310mm (12") square. If you use a tray or tin which is larger than this, you may need to turn it around during cooking.

Place single dishes on the centre of the shelf. You may need to turn large items around during cooking.

Roasting

For best results we recommend open roasting using minimal fat or oil to prevent splashing.

It is not necessary to cover meat or poultry or wrap food in foil when roasting as this restricts the circulation of heat and will lead to extended cooktimes.

If you are using a roasting bag or cover chicken breast with foil, be prepared to allow an extra 10 - 15 minutes for each 1/2kg (1lb).

When cooking large items such as turkeys, the use of foil may be required to prevent the breast becoming dry before the rest of the bird is fully cooked.

Condensation

Condensation may form on the cooker. This is quite normal and nothing to worry about. The condensation forms when heat and moisture are present, for example during cooking. Whenever possible try to make sure that food which contains a lot of moisture for example casseroles are covered. If you do notice any condensation, wipe it up straight away.

Oven cooking chart

These instructions are for cooking in the oven after it has been pre-heated for 20 minutes. If you are cooking more than one tray of similar items, for example cakes or biscuits, swap the trays around during cooking or you can take the top tray out of the oven when the food is cooked and move the lower tray to the higher shelf to finish cooking. Always leave at least one shelf position between shelves to allow heat to circulate. The recommended shelf positions give the best results. Put the dishes in the centre of the shelf. You can change the gas marks and cooking times to suit your own tastes. It is important to check that food is piping hot before serving.

Food	Gas mark	Shelf position	Approximate cooking time
Roasting meat: Beef	5	4	Rare: 20 mins. per ½kg (1lb) and 30 mins.
			Medium: 25 mins. per ½kg (1lb) and 25 mins.
			Well Done: 30 mins. per ½kg (1lb) and 30 mins.
Lamb	5	4	Medium: 25 mins. per ½kg (1lb) and 25 mins.
			Well Done: 30 mins. per ½kg (1lb) and 30 mins.
Pork and Veal	5	4	Medium: 30 mins. per ½kg (1lb) and 30 mins.
			Well Done: 35 mins. per ½kg (1lb) and 35 mins.

Thoroughly thaw frozen joints before cooking them.

Food	Gas mark	Shelf position	Approximate cooking time
Poultry:			
Chicken	5	4	20 mins. per ½ kg (1lb) and 20 mins.
Turkey below 4.5kg (10lbs) over 4.5kg (10 lbs)	4	4	25 mins. per ½ kg (1lb) and 25 mins.
Duck and duckling	4	4 or 5	15 mins. per ½ kg (1lb) and 15 mins.
Stuffed poultry	5	4	25 mins. per ½ kg (1lb)
	Cook as above but calculate weight including stuffing.		
Thoroughly thaw frozen joints before cooking them.			
The times given above are for open roasting in a preheated oven. If you cover the food with foil or a lid you should allow an extra 10 - 15 minutes for each ½ kg (1lb).			
Yorkshire pudding			
- large	7	1	25 - 30 mins.
- individual	7	1	15 - 25 mins.
Cakes:			
Christmas cake (8")	2	3	4-5 hours
Rich fruit 180mm (7")	2	3	2¼-2½ hours
205mm (8")	2	3	2½-2¾ hours
Madeira, 180mm (7")	4	4	1 hour
Small cakes	5	1 & 3	15-25 mins.
Scones	7	1 & 3	10-20 mins.
Victoria sandwich 180mm (7")	4	2 & 4	20-30 mins.
205mm (8")	4	2 & 4	20-35 mins.

Food	Gas mark	Shelf position	Approximate cooking time
Pastrys:			
Plate tart (shortcrust)	6	1	25-35 mins.
Fruit pie (shortcrust)	6	1	25-35 mins.
Mince pies (flan pastry)	5	1 & 3	15-25 mins.
To help pastry brown on the underside cook on a metal plate, or if plates are flat and have no rim underneath, place on baking tray to cook.			
Puddings:			
Milk puddings	2	3	2 hrs.
Baked sponge pudding	4	3	45-60 mins.
Baked custards	3	3	50-60 mins.
Yeast Mixtures:			
Bread 0.45kg (1lb loaves)	8 *	3	30-40 mins.
0.90kg (2lb loaves)	8 *	3	30-40 mins.
Rolls and buns	8 *	2	10-20 mins.

* When baking bread cook at Gas mark 8 for 10 minutes before reducing to Gas mark 6 for the remainder of the cook time.
 Note: You must soak dried beans then boil them in an open pan for 15 minutes before you add them to any dish.

Slow cooking

The slow cook setting gives a very low heat in the oven. It is particularly useful when you are cooking soups, stews and casseroles because the long slow cooking will make cheaper, tougher cuts of meat more tender.

You need to cook food at gas mark 6 for 30 minutes before you turn the oven down to the slow cook setting. This makes sure that the temperature of the food gets hot enough to start the food cooking.



Some foods such as pastry and biscuits are not suitable for slow cooking because the temperature is too low.

Cover all food during cooking to prevent it from drying out. You can uncover food for the last half hour if it is normally served golden brown.

Food preparation - slow cooking

Joints of meat and poultry

- Do not cook meat joints over 2.7kg (6lb).
- Do not cook poultry over 2kg (4lb 8oz).
- Cook on the middle shelf of the oven or above.
- Cook stuffing separately.
- Cook for at least 6 hours.
- Only cook joints of Pork if you can make sure, by using a meat thermometer, that the temperature inside the joint is at least 88°C.
- For good air circulation always stand joints on a rack in the roasting tin or casserole.
- Thaw all frozen meat and poultry before you cook it.
- Prime cuts of meat do not benefit from slow cooking.
- Cut off unwanted fat and skin unless it is browned first.
- Cook for 30 minutes at gas mark 6, then reduce to the slow cook setting.

Soups, casseroles and stews

- Do not cook casseroles over 3 kg (6lb).
- Bring to the boil on the hotplate then cook on slow cook.
- Cook in the middle of the oven or above.

Vegetables

- Cut into small pieces.
- Dried beans must be pre-soaked then boiled in an open pan for 15 minutes before adding to any dish.
- Place vegetables under meat in casseroles.
- Cook for 30 minutes at gas mark 6, then reduce to the slow cook setting.

Milk puddings

- Cover the cereal with boiling water and leave it to stand for 30 minutes.
- Drain and make the pudding in the usual way.
- Cook for 30 minutes at gas mark 6, then reduce to the slow cook setting.

General points for slow cooking

Frozen foods

Thaw thoroughly before cooking.

Thickening

Toss meat in flour for casseroles. Blend cornflour with water and add it at the end of cooking.

Flavouring

Flavours are held in the food because there is little evaporation. Adjust flavouring at the end of the cooking time.

Liquid

Use slightly less liquid as there is little evaporation during cooking.

Milk and milk products, for example cream

Add these towards the end of cooking to prevent them from curdling.

Reheating

Cool left over food quickly and then put it in the fridge. Do not reheat food using the slow cook setting. Reheat food in the usual way or in a microwave.

Only reheat food once.

Care and cleaning

For your safety

- 1 For hygiene and safety reasons you must keep this gas cooker clean. A build up of fat or other foodstuff could cause a fire.
- 2 Try to mop up spills and splashes as soon as they happen. But be careful as parts of the appliance will be hot.

Do not use any polishes, caustic cleaners, abrasives, washing soda or soap powder except those recommended in this booklet.

Please note: If we recommend you use hot soapy water we mean hot water with washing up liquid in it and not any other cleaning product.

If you own a dishwasher please read the operating instructions for the machine before you wash any part of your cooker in it.

Clean your cooker regularly using a cloth that has been wrung out in hot soapy water. Rinse and polish it dry using a soft cloth.

When you remove parts of your cooker for cleaning do not plunge them into water whilst they are very hot as this may damage the finish of the parts.

Cleaning the brass plated handle (Where applicable)

It is strongly recommended that only hot soapy water is used for cleaning the door handle. ANY OTHER CLEANING MATERIALS WILL DULL THE BRASS PLATED FINISH.

The hotplate

Clean the hotplate top using a mild abrasive such as 'Jif'. Take care not to damage the spark electrodes. If the spark electrodes are damaged the burners will not light.

You can remove the pan supports, burner caps and burner crowns to clean them. Again take care not to damage the spark electrodes.

If any food spills do occur during cooking you can place the pan on another burner to finish cooking. Then you can remove the dirty parts and clean them before the spill 'burns on'.

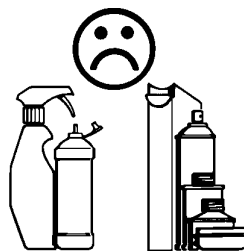

You can wash the removable parts in very hot soapy water. You may use mild abrasives. Make sure that the electrode and the hole and slots in the crown are not blocked with food or cleaning materials.

Clean the burner crowns by soaking them in very hot soapy water. You can remove any stubborn stains by scouring with a soap filled pad such as 'Brillo'. If you look after the burner crowns in this way they will stay reasonably clean. However the surface will dull with time.

Aluminium based saucepans can leave shiny metal marks on the pan supports. To clean the pan supports regularly remove the marks using a mild abrasive like 'Jif' with a soft scourer. For more stubborn marks you can use a soap filled pad such as 'Brillo'.

After cleaning the cooker parts, dry them thoroughly before you put them back.



When replacing hotplate burner parts

1. Crown to body (Do not try to force the crown on to the body). Make sure that the hole in the crown is centrally over the electrode.

Check that the two longer location pegs sit in the slots in the body. When the crown is in the position let it fall freely on to the body.

Check that the crown can be moved slightly from side to side.

2. Cap to crown

Place cap centrally on the top of crown (enamel side up). Move sideways and front to back to check the cap is fitted properly.

3. Check for ignition

If a burner will not light then you need to check the crown and cap positions.

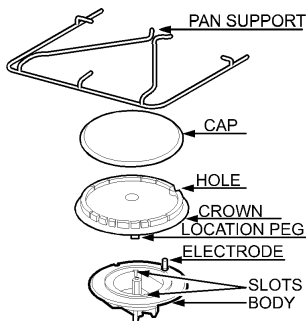

The grill

Clean the area around the grill frequently using hot soapy water.

After use you can soak the pan for a few minutes and then clean it using mild abrasives or a soap filled pad such as 'Brillo'.

Clean the grill shelf using hot soapy water. Mild abrasives can be used if necessary.

The oven

The inside of the oven is finished in vitreous enamel. You should clean the oven regularly using hot soapy water and mild abrasives or a soap filled pad such as 'Brillo'. If you use any oven cleaners they must have the Vitreous Enamel Development Council (VEDC) seal of approval. Follow the instructions on the cleaning agent and protect the oven burner with aluminium foil to prevent it becoming blocked.



- 1  Do not overfill dishes or they will boil over.

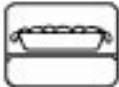

- 2  Do not put dishes too high in the oven. If you do they may stick to the oven roof.



- 3  Cover your roasting tins with foil. This will prevent fat splashing.



- 4  Use a roasting tin which is just large enough for the meat and potatoes. This will help to reduce fat splashing.



- 5  Dry any vegetables that you are going to roast. If they are wet there will be more fat splashing.



General

Clean the oven shelves and the oven door while they are still slightly warm. This way you can easily remove any splashes and spills. Wipe the base with a cloth that has been wrung out in hot soapy water. You may use mild abrasives.

Installing the cooker

For your safety

This cooker must be installed and serviced by a competent person as stated in the Gas Safety (Installation & Use) regulations current editions.

It is important that the cooker is suitable for your gas supply. Your installer should check the data badge.

Ensure that a stability bracket is fitted.

Location

For your safety

The use of a gas cooking appliance results in the production of heat and moisture in the room in which it is installed. Ensure that the kitchen is well ventilated: keep natural ventilation holes open or install a mechanical ventilation device (mechanical extractor hood).

Prolonged intensive use of the appliance may call for additional ventilation, for example opening of a window, or more effective ventilation, for example increasing the level of mechanical ventilation where present.

For further details see page 33.

Positioning

The diagram shows how close to the cooker cupboards, shelves, curtains and so on can be fitted. Refer to the diagram and carefully read the instructions to make sure your cooker is fitted safely. If you are in doubt your installer will give you advice.

- Do not fit any materials which may catch fire for example wood or curtains behind the cooker.

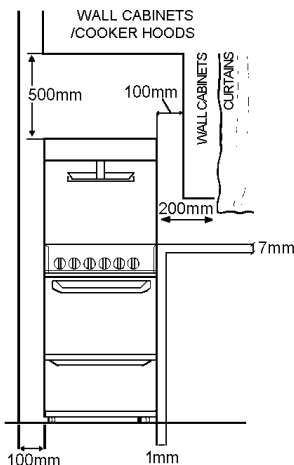

- Base units which are higher than the hotplate must be 100mm away.
- If a cooker hood is fitted refer to the cooker hood installation instructions.
- We recommend that cabinets fitted next to or above the cooker meet British Standards. Your installer will give you advice if you are not sure.

Cooker dimensions

Overall height:	1457mm - 1475mm
Height to hotplate:	902mm - 920mm (adjusted by four screw feet)
Width:	498mm
Depth:	600mm (to front of door panel)

General information

For your safety

Do not block any of the cooker vents.

Never line any part of the cooker with aluminium foil.

Don't let items which can catch fire or electric mains leads such as kettle flexes trail over any part of the cooker.

Moving your cooker

You may damage some soft or badly fitted floor coverings when you move the cooker. The floor covering under the cooker should be securely fixed so it does not ruck up when you move the cooker across it. Alternatively you could remove the floor covering.

To move the cooker open the oven door. Raise the cooker off its front feet by lifting from inside the oven. Pull the cooker forward. When you replace the cooker push it back to the stop and make sure there is the same gap at each rear corner.

The battery

The battery for the ignition will usually last for many months. If the ignition system doesn't work you probably need to replace the battery.

The battery is located at the front left hand side of the bottom storage compartment.

Open the storage compartment to gain access to the battery holder.

Lift up the battery holder lid and replace the battery as shown in the diagram. Use one AA size battery.

Close the lid of the battery holder.

You can light the burners with a match until you have time to change the battery.



Storage

The compartment below the oven is useful for storing baking trays, cake tins and so on. Do not store anything in this compartment which may catch fire.

What is wrong and why?

We strongly recommend that you carry out the following checks on your cooker before calling a Service Engineer.

Problem

The oven, grill or hotplate will not light.

Check

- If you cannot hear any sparking or the sparking is slow when you press the ignition button it may not be enough to light the cooker. You will probably need to replace the battery. For instructions on how to do this see page 25. You can light the burners with a match until you have time to change the battery.
- Check that there is not a problem with your gas supply. You can do this by making sure that other gas appliances such as your central heating or gas fire are working.
- If only the hotplate burners will not light, make sure that the burner parts have been replaced properly. See instructions on page 20.

Problem

Food is cooking too quickly or too slowly.

Check

- Check that you are using the recommended gas marks and shelf positions. See page 13. Be prepared to adjust the gas mark up or down to achieve the results you want.

Problem

The oven is not cooking evenly.

Check

- Check that the cooker is installed properly and is level.
- Check that you are using the recommended temperatures and shelf positions.
- If you are using a tin or tray which is larger than the one we recommend, be prepared to turn it round during cooking.
- If you are cooking a large item be prepared to turn it round during cooking.

Problem

Having difficulty cleaning any part of the cooker.

Check

- Check that you are following the instructions for care and cleaning (see page 19).

Service and spare parts

In the event of your appliance requiring service or if you wish to purchase spare parts please contact your local Parkinson Cowan Service Force Centre by telephoning

08705 929929

Your call will be routed to the Service Force Centre covering your postcode area.

Parkinson Cowan customers in Ireland should telephone (01) 4090755

Before you call an engineer check through the information under the heading 'What is wrong and why?'

In-guarantee customers should ensure that the checks under the heading 'What is wrong and why?' have been made as the engineer will make a charge if the fault is not a mechanical or electrical breakdown.

Please note that it is necessary to provide proof of purchase for any in-guarantee service calls.

When you report a problem try to describe the nature of the fault. Always give your cooker's full name, model and serial number.

Make a note of this information in this space:

Name:

Model Number:

Serial Number:

G.C. Number:

For your safety

Maintenance must only be carried out by a competent /qualified person. Do not try to repair or alter/modify the cooker yourself as this could be dangerous.

We recommend that your cooker has an annual gas safety check carried out by our approved service organisation.

Customer Care Department

For general enquiries concerning your Parkinson Cowan cooker or further information on products, you are invited to contact our Customer Care Department by letter or telephone as follows:

Customer Care Department
Parkinson Cowan
55-77 High Street
Slough
Berkshire
SL1 1DZ

Tel: 08705 950950 *

* calls to this number may be recorded for training purposes.

The Gas Consumers' Council

The Gas Consumers' Council (GCC) is an independent organisation which protects the interests of gas users.

If you need advice, you will find the telephone number in your local telephone directory under Gas.

INSTALLATION INSTRUCTIONS

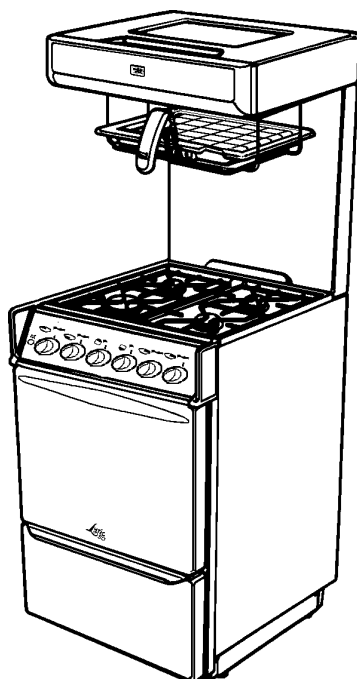

Serial number inside the storage compartment. Data badge on top rear of panel.

For your safety

Natural Gas and L.P. Gas versions of this appliance are available. Check that this model is suitable for the type of supply available. In the interest of safety this appliance must be installed and/or serviced by a competent person, as stated in the Gas Safety (Installation and Use) Regulations Current Editions.

TECHNICAL DATA

DIMENSIONS

Overall	Height 1462mm (nominal)	Width 498mm	Depth 600mm (from elbow to front of door panel)
Height to hotplate	907mm nominal - see important note 'Location of the Appliance' (see Page 34).		
Space for fixing at hotplate level		2mm minimum clearance	600mm Nominal
Space for fixing above hotplate level	100mm each side of appliance		
Minimum space above grill	500mm		
Minimum distance from rear wall	20mm		
Weight of appliance	59.3kg		

CONNECTIONS

Gas	Rear left hand side of appliance at hotplate level Rc½ (½" B.S.P. female)
Electric	None

IGNITION

Spark Generator	APCO 6BG6893
Battery	1.5 volt AA size

GRILL

Heat Input	<i>Natural Gas</i> 3.3kW (11263 Btu/h)	<i>L.P. Gas</i> 3.55kW (255g/h)
Injector Marking	138	95

HOTPLATE

Natural Gas

	R.H.F.	R.H.R.	L.H.R.	L.H.F.
Heat Input	1.0kW (3412 Btu/h)	2.0kW (6824 Btu/h)	2.0kW (6824 Btu/h)	2.8kW (9554 Btu/h)
Injector Marking	079	104	104	130

L. P. Gas

	R.H.F.	R.H.R.	L.H.R.	L.H.F.
Heat Input	1.0kW (71.8g/h)	2.0kW (143.7 g/h)	2.0kW (143.7 g/h)	2.7kW (194 g/h)
Injector Marking	51	72	72	83

OVEN

	<i>Natural Gas</i>	<i>L. P. Gas</i>
Heat Input	2.4kW (8189 Btu/h)	2.4kW (172.4g/h)
Injector Marking	108	78
Flame Supervision Device	Diamond 'H' GSD 100/28	Diamond 'H' GSD 100-30
Thermostat	Diamond 'H' 1100-157/B2	Diamond 'H' 1100 155/B2
Thermostat By-pass Marking	69	78

GENERAL

Ignition	H.T. Spark	H.T. Spark
Spark Gap	3-4mm	3-4mm

IMPORTANT - SAFETY REQUIREMENTS

This appliance must be installed in accordance with the Gas Safety (Installation and Use) Regulations Current Editions. Detailed recommendations are contained in the following British Standard Codes of Practice - BS.6172, BS.5440: Part 2 and BS.6891. All British Standards must be 'Current Editions'.

PROVISION FOR VENTILATION

This appliance is not connected to a combustion products evacuation device. It shall be installed and connected in accordance with the current installation regulations. Particular attention shall be given to the relevant requirements regarding ventilation.

The room containing the appliance should have an air supply in accordance with BS. 5440: Part 2 Current Edition. All rooms require an openable window or equivalent and some rooms will require a permanent vent as well. For room volumes up to 5m³ an air vent of 100cm² is required: for room volumes between 5m³ and 10m³ an air vent of 50cm² is required. If the room has a door that opens directly to the outside, no air vent is required. For room volumes that exceed 11m³ no air vent is required. If there are other fuel burning appliances in the same room, BS.5440: Part 2 Current Edition should be consulted to determine the requisite air vent requirements.

Prolonged intensive use of the appliance may call for additional ventilation, for example opening a window, or more effective ventilation, for example increasing the level of mechanical ventilation where present.

LOCATION OF APPLIANCE

This appliance must not be installed in a bed-sitting room of volume less than 20m³ or in a bathroom, shower room or garage. It is essential that the appliance is positioned as stated below. The appliance must be a minimum of 20mm from the rear wall (note that this dimension is provided by the inlet elbow). Shelves, wall cabinets and cooker hoods must not be fitted closer than 500mm to the top of the grill canopy or within 100mm of the sides of the grill. Curtains must not be fitted immediately behind the appliance or within 200mm of the sides of the grill. If fitted next to or between two base units a minimum space of 1mm must be left between the units and the sides of the appliance. The hotplate must be set to a minimum of 7mm above the adjacent units (note that the levelling feet fitted to the appliance will achieve a nominal height to hotplate level of 907mm -5+13mm). Base units not meeting the above conditions must be a minimum of 100mm away from the hotplate. L.P.G. cookers MUST NOT be installed below ground level, i.e. in a basement or fitted aboard any boat, yacht or other vessel.

INSTALLATION

1. PARTS REQUIRED

The loose hotplate parts are packed in the polystyrene fitment on the top of the hotplate. The grill pan, grill pan handle, fixing screws and splashplate fixing screws can be found in the furniture pack which is located in the bottom compartment. The grill pan requires assembly before use (see Fig. 1).

2. GRILL ASSEMBLY

The two splashplate screws marked A (see Fig. 1a) should be screwed into the back of the appliance about halfway in. Engage the keyhole slots in the splashback behind the two screws taking care not to trap the H.T. wire (see Fig. 1b).

Insert the four splashplate screws marked B (see Fig. 1b). Tighten 6 off splashplate screws (see Fig. 1b).

Connect the grill supply union at the back of the appliance and pull the grill H.T. lead through the opening in the splashplate. Feed lead through the hole in the top right hand side of the splashplate and connect on to the grill electrode. (see Fig. 1b).

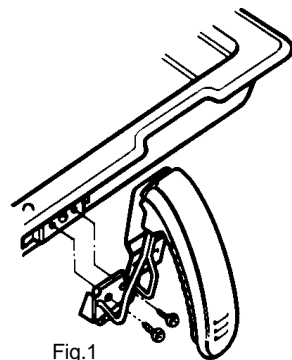

Fig.1

Grill Pan Handle Assembly:
Assemble grill pan (see Fig.1) and secure two screws provided.

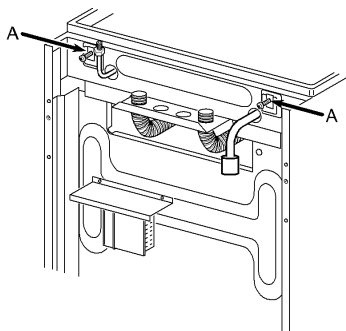

Fig.1a

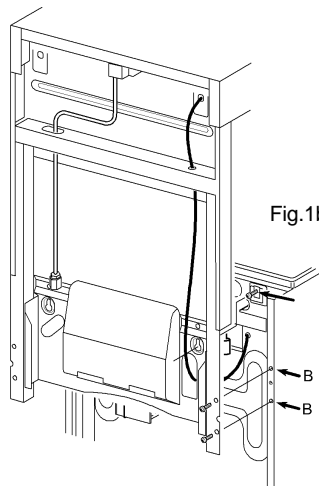

Fig.1b

3. LEVELLING THE APPLIANCE

Adjustable levelling feet at the front and rear are provided on the base of the appliance. Adjustment to suit floor conditions is obtained by rotating in or out the hexagonal feet from the underside of the appliance. A spirit level should be placed on one of the oven shelves to confirm that the appliance is correctly levelled.

4. FITTING THE STABILITY BRACKET

It is recommended that if the appliance is to be installed with a flexible supply pipe a stability bracket (SK.4729.A) is fitted and is available from your supplier (see Important Safety Requirements, page 33). These instructions should be read in conjunction with the leaflet packed with the stability bracket.

1. Place the appliance in its intended position and level appliance.
 2. Mark off 250mm from the left hand side of the appliance as shown (Dimension 'A'), Fig 2a. This is the centre line of the fixing bracket.
 3. Draw a line 100mm from the front edge of the levelling feet (see Fig 2a) and remove appliance from its position. Mark off dimension 'B' (see Fig 2a) back from this line on the centre line of the bracket to locate the front edge of the lower bracket. Fix lower bracket (with two fixing holes) to the floor then measure the height from floor level to engagement edge on back of appliance, dimension 'C' of Fig. 2b.
 4. Assemble upper bracket to lower bracket so that underside of bracket is dimension 'C' +3mm above floor level.
- Reposition appliance and check that top bracket engages into appliance back as shown in Fig. 2b.

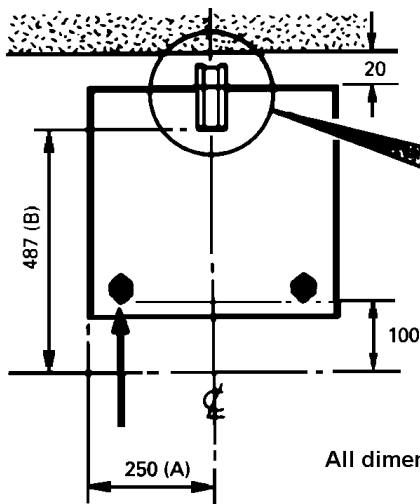

Fig.2a

All dimensions in mm

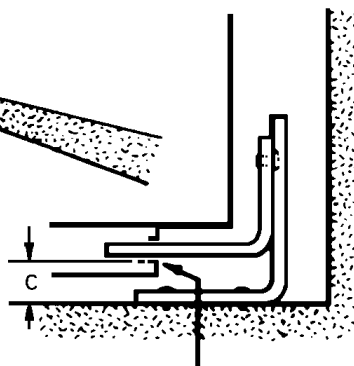

Fig.2b

5. CONNECTING TO GAS

This appliance is designed to be installed with an appliance flexible connection only. Supply piping should not be less than R³/₈ (3/8" B.S.P.). Connection is made to the Rc¹/₂ (1/2" B.S.P.) female threaded entry pipe located just below the hotplate level on the rear left hand side of the appliance.

Check for gas soundness after connecting the gas supply.

The gas bayonet connector must be fitted in the shaded area indicated in Fig. 3. Take into account that it must be possible to pull the appliance forward sufficiently. The hose must not get caught on the stability bracket.

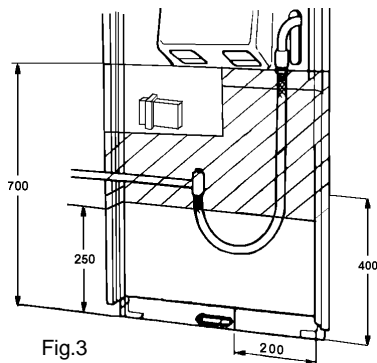

Fig.3
All dimensions in mm

IMPORTANT: FLEXIBLE TUBING USED MUST COMPLY WITH BS. 669 CURRENT EDITION. L.P.G. FLEXIBLE CONNECTIONS MUST BE OF A TYPE SUITABLE FOR L.P.G. AND CAPABLE OF OPERATION UP TO 50MBAR AND TO CARRY A RED STRIPE, BAND OR LABEL.

NOTE: ONLY LIQUID SEALANTS CAN BE USED IN THREADED GAS CONNECTIONS. DO NOT USE P.T.F.E. TAPE.

6. FITTING THE BATTERY

1. The battery holder is located at the front left hand side of the bottom storage compartment (see Fig. 4).
2. Open bottom compartment flap to gain access to the battery holder.
3. From inside the bottom compartment fit the 1.5 volt battery (see Fig.4) ensuring it is fitted as indicated by the symbols on the battery holder.

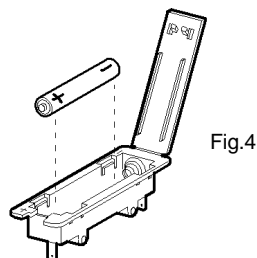

Fig.4

7. PRESSURE TESTING

1. The oven injector is used as the pressure test point.
Remove the oven furniture. Remove oven burner box retaining clips (one spring clip from each side) and remove box front cover. Replace one clip back into the right hand side of the burner box. Remove oven burner by removing the spring clip from the right hand side of the oven burner and slide the burner off the injector whilst easing it towards the front of the appliance, taking care not to strain the F.S.D. phial.
2. Connect the pressure gauge to the oven injector.
3. Check the supply pressure by turning the thermostat on and one hotplate tap full on and light the appropriate burner.
The pressure should be either:
 - (i) For Natural Gas 20mbar
 - (ii) For LP.Gas The pressure must be set to 28 mbar for use on butane or 37 mbar for use on propane.
4. Turn off the taps, disconnect the pressure gauge and replace oven burner and cover, ensuring that the F.S.D. phial is correctly located into the bracket on the burner.
5. Check operation of oven.

8. CHECKING THE GRILL

Fit the grill pan shelf to the splashplate canopy (4 screws).

Place the grill pan containing the grid on to the grill pan shelf. Light the grill burner by turning the tap to its full on position and pressing the ignition button. As soon as the burner is lit the button can be released.

If the ignition of the grill fails ensure the grill H.T. wire is fitted to the generator (see Section 2).

9. CHECKING THE HOTPLATE

Fit the burner crowns, caps and pan supports ensuring that they are correctly seated. Check each of the hotplate burners in turn by turning each hotplate tap to its full on position and pressing the ignition button. As soon as the burner is lit the button can be released.

10. CHECKING THE MAIN OVEN

1. Turn the oven thermostat knob to Mk 9 and press the ignition button. As soon as the burner is alight the button can be released.
2. There should now be a low gas rate to the burner, which is the F.S.D. by-pass rate.
3. When the F.S.D. phial has heated up it opens the F.S.D. valve which allows the main gas supply to the oven burner.
4. After 1 minute check that the flame covers the full width of the burner and is stable.
5. Set the oven control to Mk 2, close the oven door and check that after about 10 minutes the flame size has reduced.
6. Turn off the control and check that the oven flames go out.

GENERAL NOTE

Instruct the user on how to use the appliance and its ignition system.

Refer the user to the wording in the inside cover which gives advice on the safe operation of the appliance.

NOTES

LYRIC 50M - 311536802

Contents Check List

Note:

If you require replacements of the item listed below please contact your local Service Force Centre quoting the relevant part number.

The loose contents of this pack include:-

No. OFF	DESCRIPTION
2	Oven shelves
1	P.C. Guarantee card
1	Hotplate operation card
1	Single handle grill pan (small)
1	Grill pan trivet (small wire) (311419801)
1	Grill pan shelf (small)
1	Green screw pack
4	Burner crowns
4	Burner caps
2	Pan supports
1	Battery

This handbook was correct on the date it was printed. But this handbook will be replaced if the specification or appearance changes during production.

<i>Description</i>	<i>No. Off</i>	<i>Maker's Part Number</i>
Burner Cap - Rapid	1	354000610
Burner Cap - Normal	2	354000609
Burner Cap - Simmer	1	354000608
Burner Crown - Rapid - N.G.	1	359039100
Burner Crown - Rapid - L.P.G.	1	337000302
Burner Crown - Normal	2	337000402
Burner Crown - Simmer	1	337000502
Pan Support	2	359033202

NOTE : Failure to use manufacturers original spares could negate normal BSI approval of the product

Parkinson Cowan

Customer Care

55 - 77 High Street, Slough, Berkshire, SL1 1DZ

Telephone: 0870 5 950950

Drawing No. 311536802



© Electrolux Household Appliances Limited 2000

Free Manuals Download Website

<http://myh66.com>

<http://usermanuals.us>

<http://www.somanuals.com>

<http://www.4manuals.cc>

<http://www.manual-lib.com>

<http://www.404manual.com>

<http://www.luxmanual.com>

<http://aubethermostatmanual.com>

Golf course search by state

<http://golfingnear.com>

Email search by domain

<http://emailbydomain.com>

Auto manuals search

<http://auto.somanuals.com>

TV manuals search

<http://tv.somanuals.com>