

Model 1195/4E1 Optical Multiplexer

Getting Started Guide



Sales Office: **+1 (301) 975-1000**
Technical Support: **+1 (301) 975-1007**
E-mail: **support@patton.com**
WWW: **www.patton.com**

Part Number: **07M1195-GS, Rev. A**
Revised: **February 12, 2009**

Patton Electronics Company, Inc.

7622 Rickenbacker Drive
Gaithersburg, MD 20879 USA
Tel: +1 (301) 975-1000
Fax: +1 (301) 869-9293
Support: +1 (301) 975-1007
Web: www.patton.com
E-mail: support@patton.com

Copyright © 2009, Patton Electronics Company. All rights reserved.

The information in this document is subject to change without notice. Patton Electronics assumes no liability for errors that may appear in this document.

Warranty Information

The software described in this document is furnished under a license and may be used or copied only in accordance with the terms of such license.

Patton Electronics warrants all 1195 components to be free from defects, and will—at our option—repair or replace the product should it fail within one year from the first date of the shipment.

This warranty is limited to defects in workmanship or materials, and does not cover customer damage, abuse or unauthorized modification. If the product fails to perform as warranted, your sole recourse shall be repair or replacement as described above. Under no condition shall Patton Electronics be liable for any damages incurred by the use of this product. These damages include, but are not limited to, the following: lost profits, lost savings and incidental or consequential damages arising from the use of or inability to use this product. Patton Electronics specifically disclaims all other warranties, expressed or implied, and the installation or use of this product shall be deemed an acceptance of these terms by the user.

Summary Table of Contents

1	General information	13
2	Applications overview	21
3	Model 1195/4E1 installation	23
4	Connecting the RS-232 port	29
5	CLI configuration	34
6	GUI configuration	47
7	Contacting Patton for assistance	66
A	Specifications	69
B	Connector pinouts	74

Table of Contents

Safety when working with electricity	11
General observations	11
General conventions	12
1 General information.....	13
Model 1195/4E1 Overview.....	14
Features and Benefits	14
Front View.....	15
Rear View.....	20
2 Applications overview	21
Typical Model 1195/4E1 Application.....	22
3 Model 1195/4E1 installation.....	23
Connecting power	24
AC Power	24
DC Power	24
Grounding	25
Connecting the optical interface.....	26
Connecting the DB-37 connector.....	27
Connecting E1 links	28
Definition for E1 Interfaces	28
Connecting Ethernet Links.....	28
Verifying the connection	28
Definition for Ethernet Interfaces	28
4 Connecting the RS-232 port	29
Connecting the RS-232 port.....	30
RS-232 port cable details	31
RS-232 pin definition	31
Configuring HyperTerminal.....	32
5 CLI configuration.....	34
General Commands.....	35
Specific Commands.....	37
Check current MAC address of the device	37
Check the current IP address of the device	37
Check gateway address of the device	37
View the get / getnext community of SNMP	37
Configure the get / getnext community of SNMP	37
View the set community of SNMP	38
Configure set community of SNMP	38
Change the IP address of the device	38
Change the Subnet mask information of the device	38

Change the Gateway information of the device	38
Change the MAC address of the device	39
Show system information	39
Enable / Disable the loopback of E1 Port	40
Check whether the E1 Port is looped back	40
Check the alarms of E1 Tributary	41
Configure laser port receive mode	41
View the current status of laser port	42
Reset the system	42
Set / configure the default settings in the device	42
Enable / Disable the Ethernet Port	42
Set / configure the Ethernet Port performance parameters	43
Check the Ethernet Port configuration	43
View the performance of ethernet port	44
View the status of ethernet port	44
Clear the performance statics / log of Ethernet, E1, GFP	44
Add a telnet user	45
Delete a Telnet user	45
Check the list of Telnet users	45
View the status of remote system power	45
Mask the unused e1 alarms	45
View the configuration of unused e1 alarm mask	45
Clear the record of E1's CV alarm	46
Configure the status of alarm tone mask	46
View the status of alarm tone mask	46
6 GUI configuration	47
Overview	48
Installing the GUI.....	48
Accessing the 1195.....	49
Adding/Removing a System.....	49
Adding a system	49
Removing a system	50
Editing a system	50
Communicating With a System.....	51
Adding/Removing Users.....	52
Adding a user	52
Removing a user	52
Editing a user entry	52
Status Monitoring.....	53
System Monitoring.....	54
Start/stop monitoring	54
Configure/view alarms	54
Change the Trap Community and/or Port	54

View log	55
Managing Trap Details.....	55
Configuring System Settings.....	55
Configuring IP Settings.....	56
Configuring Trap Settings.....	57
Configuring Default Settings	58
SNMP Community	59
Viewing Settings	60
Back Up.....	61
Restore.....	61
Synchronize.....	62
Report.....	62
List of systems	62
List of traps	63
Read Me	64
System Information.....	65
Exiting the System	65
7 Contacting Patton for assistance.....	66
Introduction.....	67
Contact information.....	67
Patton support headquarters in the USA	67
Alternate Patton support for Europe, Middle East, and Africa (EMEA)	67
Warranty Service and Returned Merchandise Authorizations (RMAs).....	67
Warranty coverage	67
Out-of-warranty service	68
Returns for credit	68
Return for credit policy	68
RMA numbers	68
Shipping instructions	68
A Specifications	69
E1 Interface.....	70
Optical.....	70
Optical Interface Specifications: 1310nm Single Mode	71
Transmitter Optical Characteristics	71
Receiver Optical Characteristics	71
Optical Interface Specifications: 1550nm Single Mode	71
Transmitter Optical Characteristics	71
Receiver Optical Characteristics	72
Safety.....	72
Ethernet Interface.....	72
Configuration, Management and Alarms.....	72
Power Supply	72
Environment.....	73

Physical	73
B Connector pinouts	74
DB-37 connector pinout (Model 1195/4E1).....	75
DB-37 connector pinout details for E1 connections	75

List of Figures

1	Model 1195/4E1	14
2	1195/4E1 front view	15
3	Front LEDs	16
4	Tributary Status LEDs	17
5	Config Switch LEDs	18
6	Interfaces	19
7	1195/4E1 rear view	20
8	Typical application for Model 1195/4E1	22
9	CD flash screen	48
10	Model 1195/4E1 Main Menu window	49
11	Add/Remove System	50
12	Select COM port	51
13	Select TCP/IP address	51
14	Login	52
15	Add user	52
16	Status Monitoring	53
17	System Monitoring	54
18	System settings	55
19	E1 settings	56
20	IP settings	57
21	Trap settings	57
22	Default settings	58
23	SNMP Community	59
24	Show settings	60
25	Back up	61
26	Restore	61
27	Synchronize	62
28	View systems report	62
29	View traps	63
30	Readme file	64
31	View system information	65
32	DB-37 connector pinout	75

About this guide

This guide describes the Model 1195/4E1 hardware, installation and basic configuration.

Audience

This guide is intended for the following users:

- Operators
- Installers
- Maintenance technicians

Structure

This guide contains the following chapters and appendices:

- [Chapter 1](#) on page 13 provides information about features and capabilities
- [Chapter 2](#) on page 21 contains an overview describing the typical application
- [Chapter 3](#) on page 23 provides hardware installation procedures
- [Chapter 4](#) on page 29 provides information for connecting the RS-232 port
- [Chapter 5](#) on page 34 provides information for using the CLI to configure the unit
- [Chapter 6](#) on page 47 provides information for using the GUI to configure the unit
- [Chapter 7](#) on page 66 contains information on contacting Patton technical support for assistance
- [Appendix A](#) on page 69 contains technical specifications
- [Appendix B](#) on page 74 describes the connector pin-outs

For best results, read the contents of this guide *before* you install the unit.

Precautions

Notes, cautions, and warnings, which have the following meanings, are used throughout this guide to help you become aware of potential problems. **Warnings** are intended to prevent safety hazards that could result in personal injury. **Cautions** are intended to prevent situations that could result in property damage or impaired functioning.

Note A note presents additional information or interesting sidelights.



The alert symbol and IMPORTANT heading calls attention to important information.



CAUTION

The alert symbol and CAUTION heading indicate a potential hazard. Strictly follow the instructions to avoid property damage.



CAUTION

The shock hazard symbol and CAUTION heading indicate a potential electric shock hazard. Strictly follow the instructions to avoid property damage caused by electric shock.



WARNING

The alert symbol and WARNING heading indicate a potential safety hazard. Strictly follow the warning instructions to avoid personal injury.



WARNING

The shock hazard symbol and WARNING heading indicate a potential electric shock hazard. Strictly follow the warning instructions to avoid injury caused by electric shock.

Safety when working with electricity



- This device contains no user serviceable parts. The equipment shall be returned to Patton Electronics for repairs, or repaired by qualified service personnel.
- **Mains Voltage:** Line voltages are present when the power cord is connected. The mains outlet shall be within 10 feet (3 meters) of the device, shall be easily accessible, and protected by a circuit breaker.
- For AC powered units, ensure that the power cable used meets all applicable standards for the country in which it is to be installed, and that it is connected to a wall outlet which has earth ground.
- Hazardous network voltages are present in WAN ports, regardless of whether power to the unit is ON or OFF. To avoid electric shock, use caution when near WAN ports. When detaching the cables, detach the end away from the unit first.
- Do not work on the system or connect or disconnect cables during periods of lightning activity.
- For units with an external power adapter, the adapter shall be a listed Limited Power Source.



In accordance with the requirements of council directive 2002/96/EC on Waste of Electrical and Electronic Equipment (WEEE), ensure that at end-of-life you separate this product from other waste and scrap and deliver to the WEEE collection system in your country for recycling.

General observations

- Place the unit on a flat surface and ensure free air circulation
- Avoid exposing the unit to direct sunlight and other heat sources
- Protect the unit from moisture, vapors, and corrosive liquids

Typographical conventions used in this document

This section describes the typographical conventions and terms used in this guide.

General conventions

The procedures described in this manual use the following text conventions:

Table 1. General conventions

Convention	Meaning
Garamond blue type	Indicates a cross-reference hyperlink that points to a figure, graphic, table, or section heading. Clicking on the hyperlink jumps you to the reference. When you have finished reviewing the reference, click on the Go to Previous View button  in the Adobe® Acrobat® Reader toolbar to return to your starting point.
Futura bold type	Commands and keywords are in boldface font.
Futura bold-italic type	Parts of commands, which are related to elements already named by the user, are in boldface italic font.
<i>Italicized Futura type</i>	Variables for which you supply values are in <i>italic</i> font
Futura type	Indicates the names of fields or windows.
Garamond bold type	Indicates the names of command buttons that execute an action.
< >	Angle brackets indicate function and keyboard keys, such as <SHIFT>, <CTRL>, <C>, and so on.
[]	Elements in square brackets are optional.
{a b c}	Alternative but required keywords are grouped in braces ({ }) and are separated by vertical bars ()
screen	Terminal sessions and information the system displays are in <i>screen</i> font.
node	The leading IP address or nodename of a Model 1195 is substituted with node in boldface italic font.
SN	The leading SN on a command line represents the nodename of the Model 1195
#	An hash sign at the beginning of a line indicates a comment line.

Chapter 1 **General information**

Chapter contents

Model 1195.....	14
Features and Benefits.....	14
Front View	15
Rear View.....	20

Model 1195/4E1

Model 1195 FiberLink E1/Ethernet Mux is a point to point high performance optical line transmission equipment, combines 8, ITU-T G.703 compliant standard electrical E1s plus 100BaseT Ethernet signal into an optical data stream for transport over fiber optic pairs. Several transmitter options for different cable types and wave-lengths are available. 1+1 optical path redundancy is offered and available as an option.



Figure 1. Model 1195/4E1



For Testing: Always Install Optical Attenuators. For distances of less than 10 km, optical attenuators must be installed on the Optical Links. Otherwise, the optics will be permanently damaged.

Features and Benefits

- Integrated E1 Plus Ethernet Optical Multiplexer
- Compact design that performs E1 and Ethernet channel multiplexing & de-multiplexing to an optical output
- Provides visible and audible alarm indication
- Provide Remote power detection (RPD)
- Low power consumption
- Orderwire (EOW) channel for end to end installation and maintenance
- Local and remote loop back test for diagnostics
- 1+1 Fiber Path protection
- ALS (Auto Laser Shutdown) facility for eye safety
- 10/100M Ethernet Port - 100 Mbps Ethernet data transmission rate complies with IEEE 802.3
- Supports auto negotiation and flow control (pause)
- Clock options: internal/loop-timed
- Provides visible and audible alarm indications
- Local and remote loopback controls for diagnostics and troubleshooting
- Local configuration management through RS232 Serial Port
- Remote configuration and management through 10/100BaseT Ethernet
- Port - Telnet (english text commands)
- SNMP (V1 and V2C)

Front View

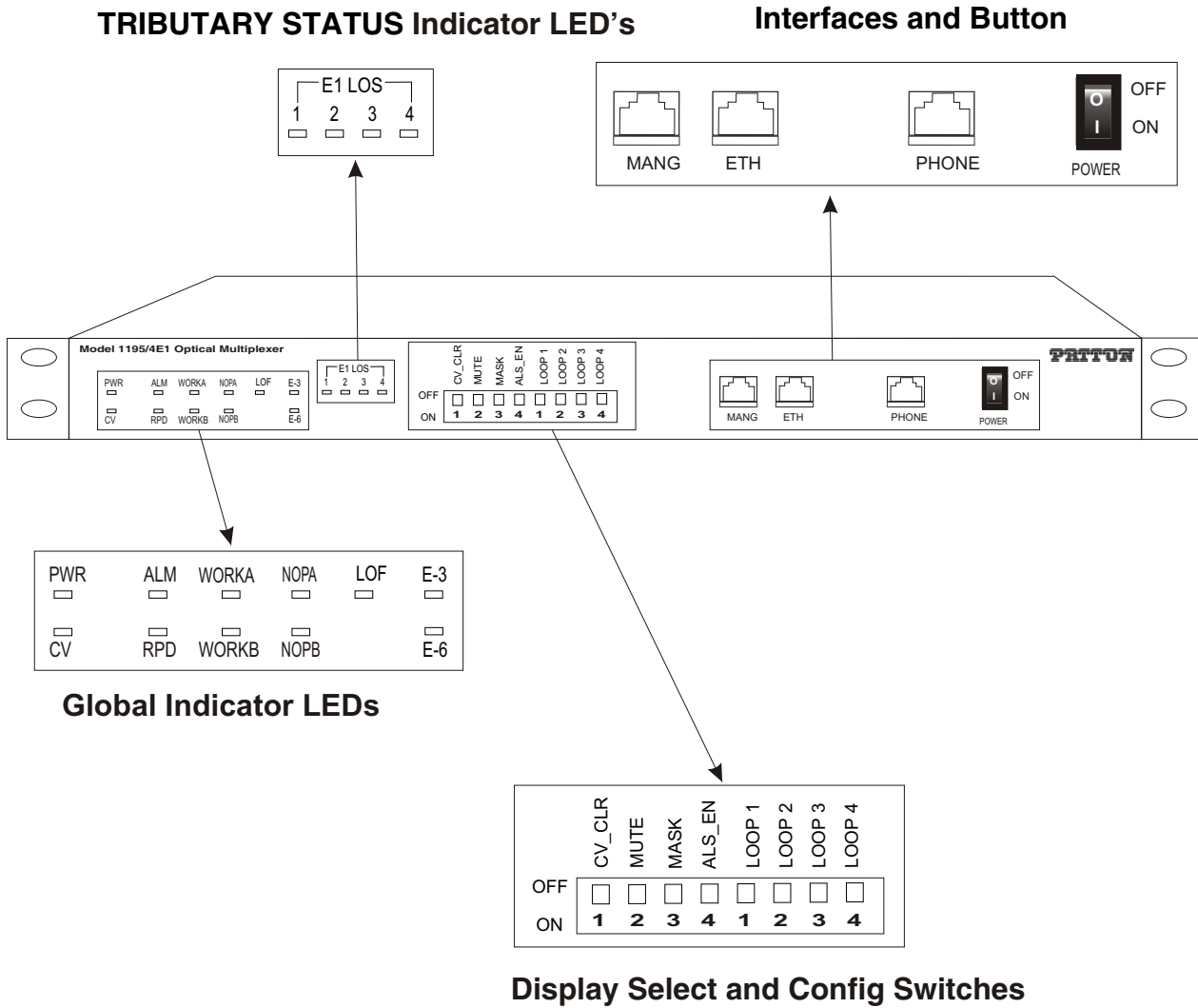

Figure 2. 1195/4E1 front view

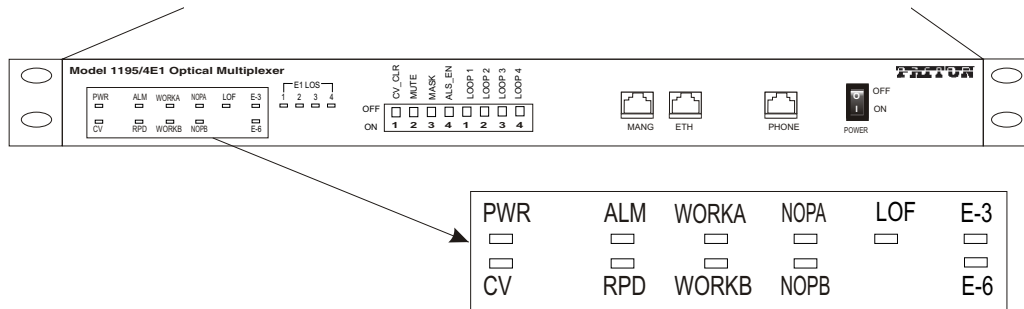

Figure 3. Front LEDs

Name	Color	Function
PWR	Green	ON – Unit is powered OFF – Unit is off
ALM	Red	ON – Local alarm detected Blinking – Remote alarm detected OFF – No alarm currently detected The local alarms take priority over remote alarms.
CV	Yellow	ON – CV alarm OFF – No CV alarm
RPD	Yellow	ON – Remote power off detected OFF – No RPD alarm
WORKA	Green	ON – Optical A is working. Optical B indication is off. OFF – Optical A is not working.
WORKB	Green	ON – Optical B is working. Optical A indication is off. OFF – Optical B is not working.
NOPA	Red	ON – Optical signal loss is detected on port A. Blinking – ALS is enabled on the remote device. OFF – No loss
NOPB	Red	ON – Optical signal loss is detected on port B. Blinking – ALS is enabled on the remote device. OFF – No loss
LOF	Red	ON – Loss of frame detected at optical port
E-3	Red	ON – Line bit error rate is over 10 ⁻⁶ detected at optical port OFF – No loss
E-6	Yellow	ON – Line bit error rate is over 10 ⁻⁶ detected at optical port OFF – No loss

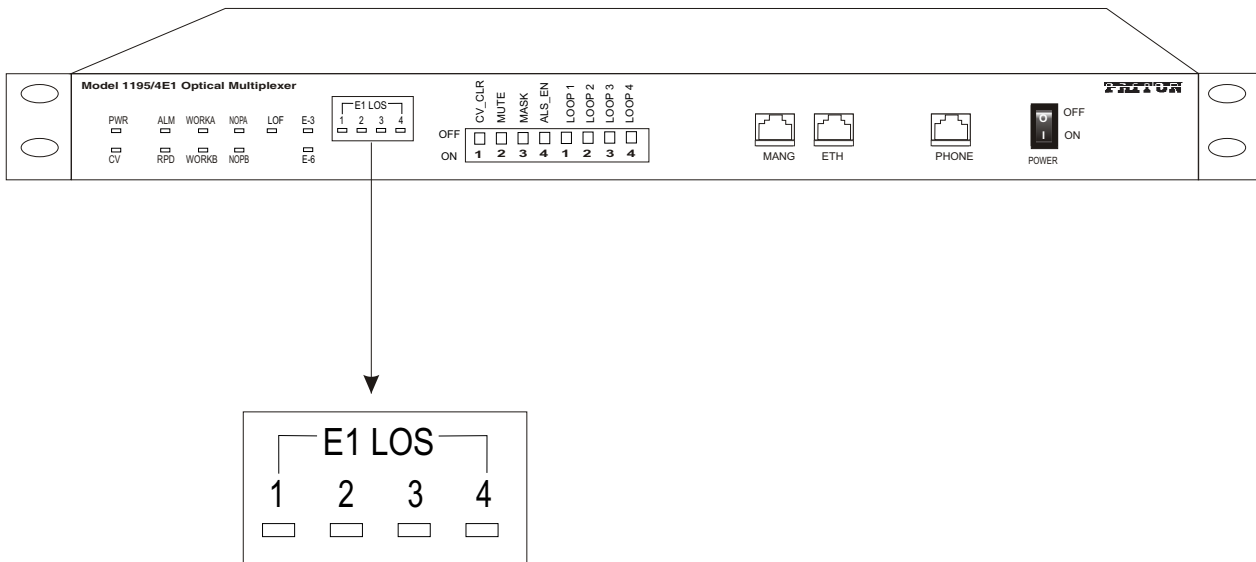

Figure 4. Tributary Status LEDs

Name	Color	Function
E1-LOS	Red	ON – E1 signal loss happened at the corresponding tributary OFF – No loss

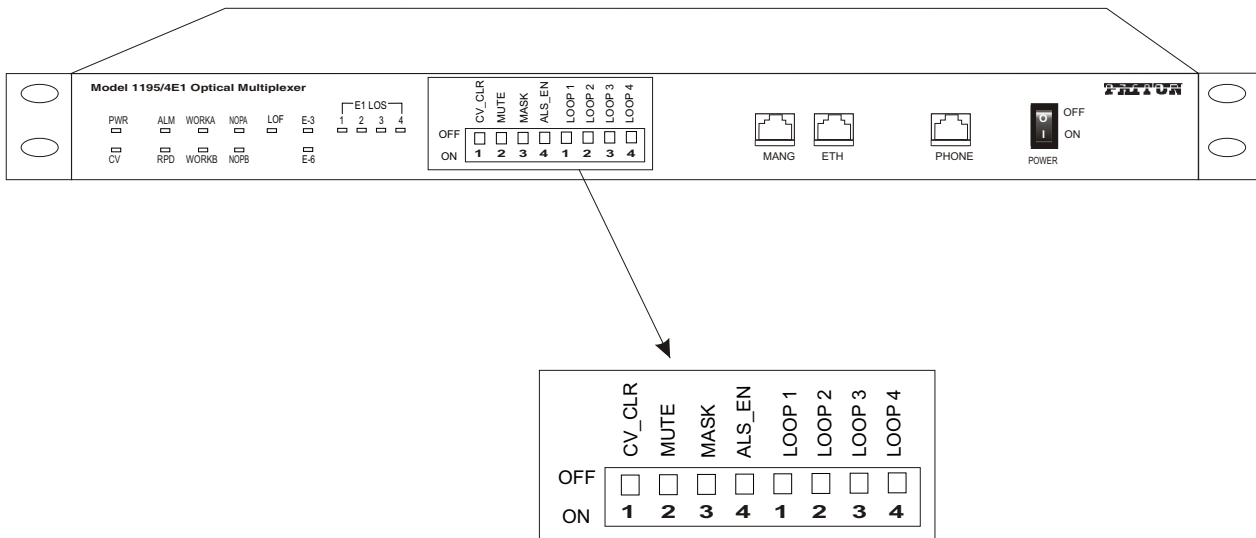

Figure 5. Config Switch LEDs

Name	Function
CV-CLR	ON – Clear CV alarm
MUTE	ON – Alarm sound is muted. Speaker will sound if any alarms have occurred. OFF – Speaker will not sound if there are alarms. Note that the ringing of the order wire cannot be muted.
MASK	ON – All current E1 loss alarms will be masked. In addition, alarms will be triggered if a new event of E1 signal loss occurs, even if MASK is ON.
ALS_EN	ON – Enable ALS function OFF – Disable ALS function
LOOP 1-4	ON – Enable remote loopback of E1 OFF – Disable remote loopback of E1

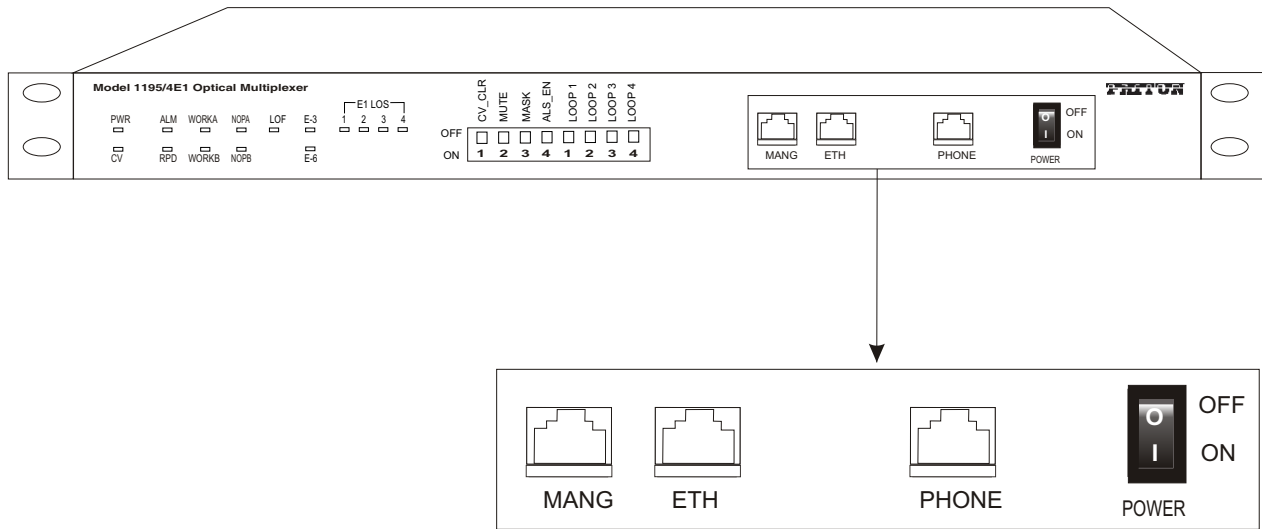

Figure 6. Interfaces

S.No.	Name	Description
1.	MANG	Ethernet Management Interface (RJ-45) Cable: CAT-5 crossover or straight through Note: In default Telnet User Name : superuser (case sensitive) Password: superuser (case sensitive)
2.	ETH	Ethernet Interface (RJ-45) Cable: CAT-5 crossover or straight through
3.	PHONE	Phone Interface (RJ-11) Cable: Standard 2-wire cable (64 Kbps, PCM coding)
4.	POWER	Power Switch ON – Power ON OFF – Power OFF

Rear View



Figure 7. 1195/4E1 rear view

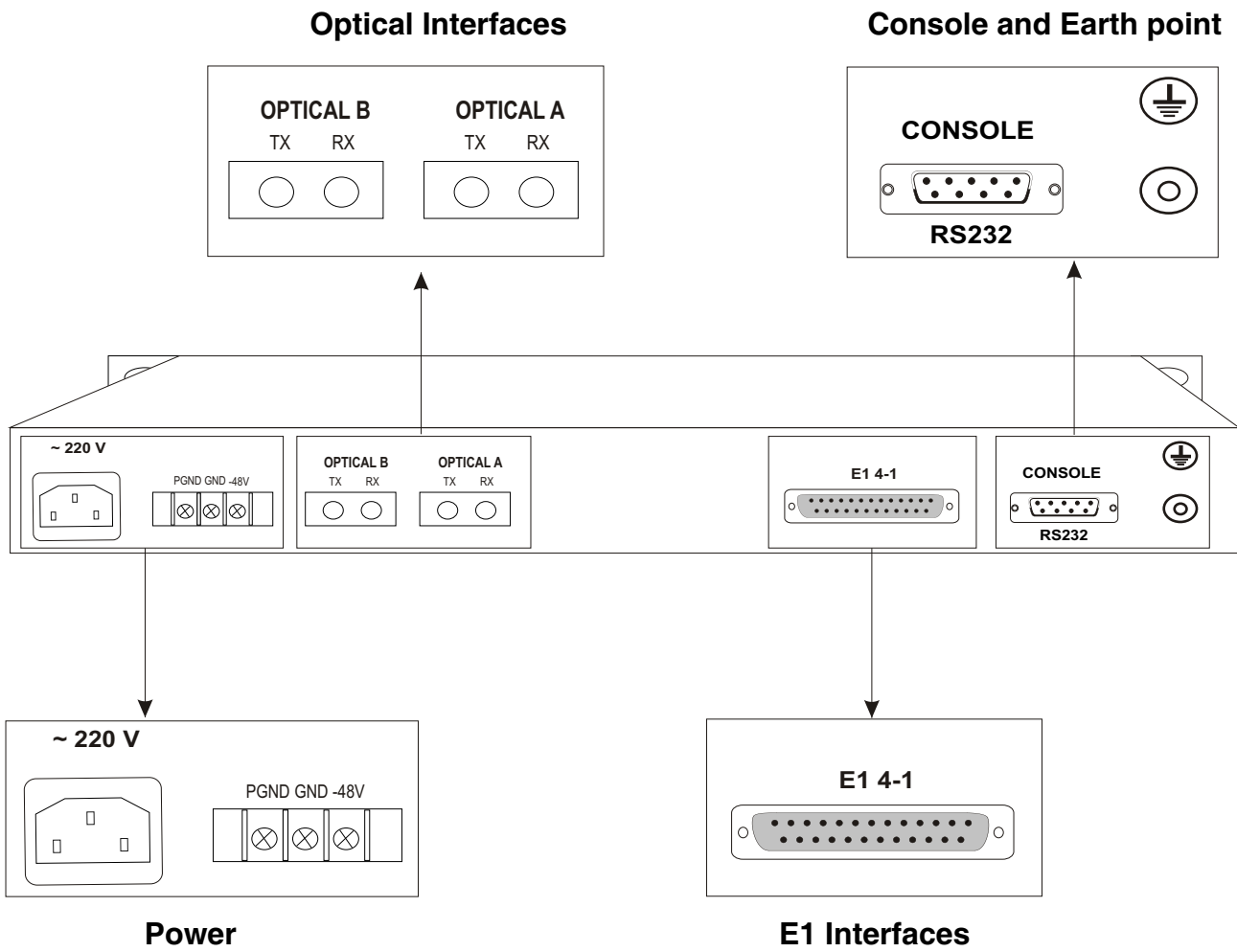

Chapter 2 **Applications overview**

Chapter contents

Typical Model 1195 Application.....	22
-------------------------------------	----

Typical Model 1195 Application

Figure 8 shows the typical application for the 1195 model.

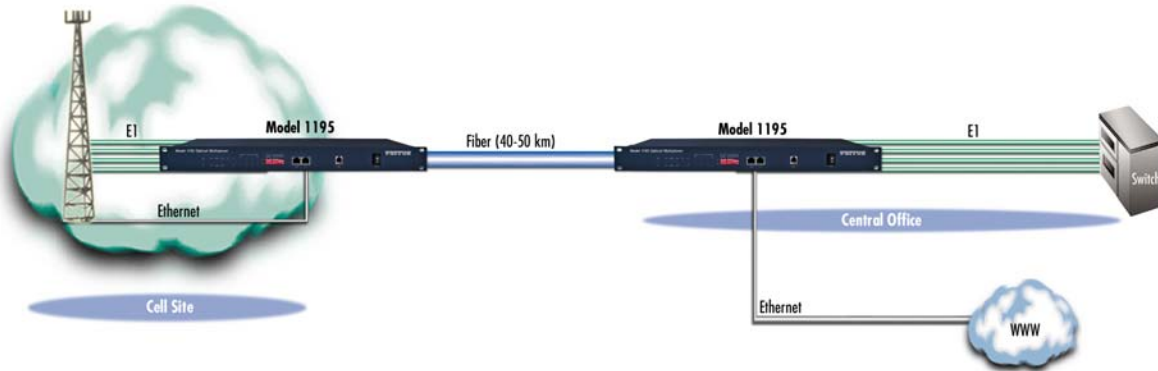

Figure 8. Typical application for Model 1195

Chapter 3 Model 1195/4E1 installation

Chapter contents

Connecting power	24
AC Power	24
DC Power	24
Grounding	25
Connecting the optical interface	26
Connecting the DB-37 connector.....	27
Connecting E1 links.....	28
Definition for E1 Interfaces	28
Connecting Ethernet Links.....	28
Verifying the connection	28
Definition for Ethernet Interfaces	28

Connecting power

AC Mains version: Please use the AC main cable (provided) to connect the system to your AC mains power outlet.

DC Mains version: Please connect the DC mains cable (provided) to the system. The polarity should not be reversed while connecting. Otherwise, you can get your system damaged.

AC Power

To connect the AC 220V power:

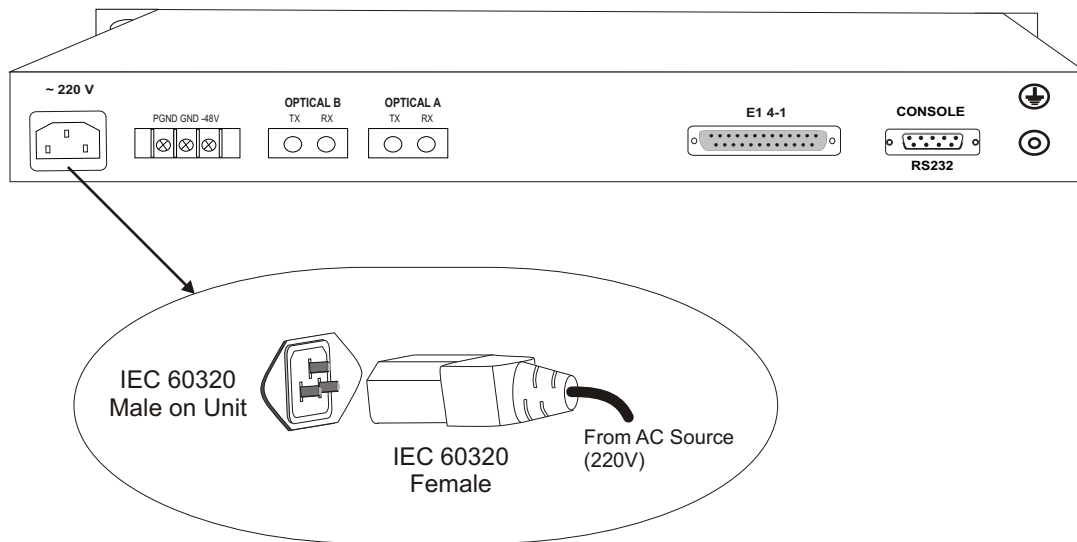

DC Power

To connect the DC -48V:

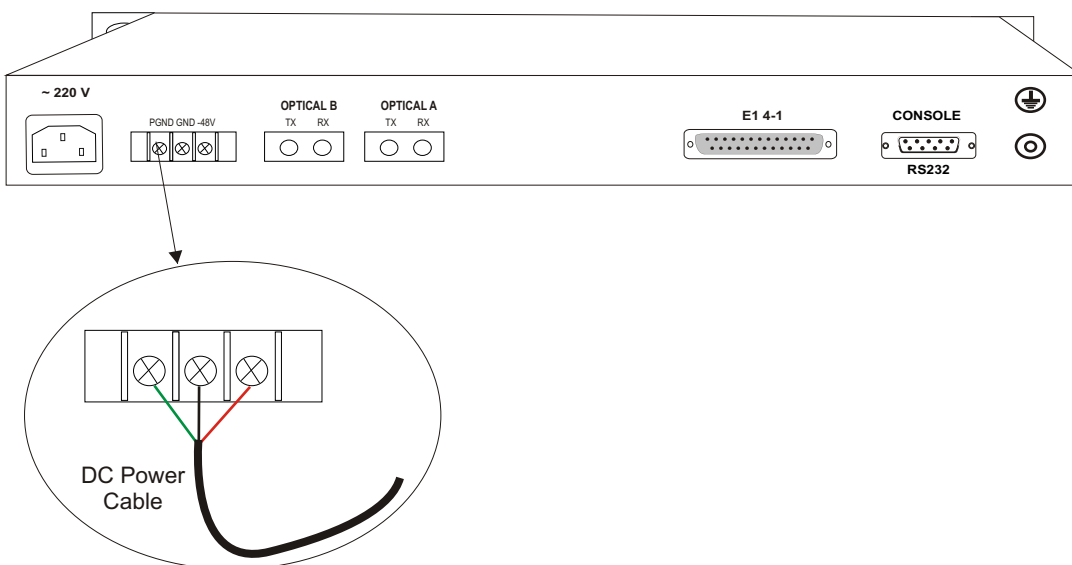

Grounding

When the equipment is used with the AC-220V power supply, the 3-core socket must be grounded for protection. The other equipment, e.g. optical terminal, connected with this equipment must also be grounded.

To connect the Earth:

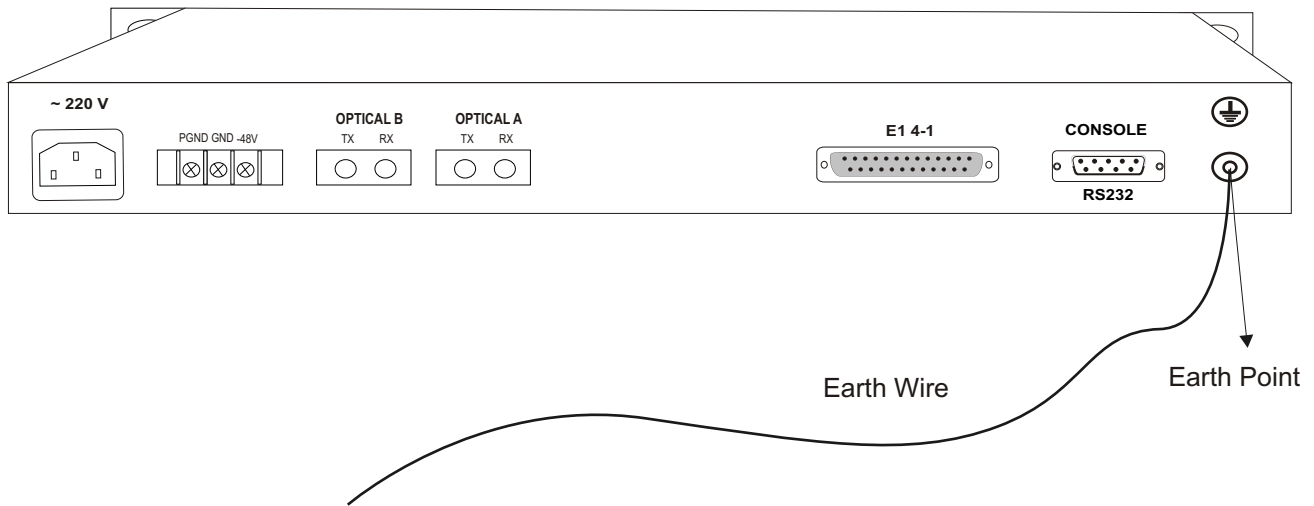

Connecting the optical interface

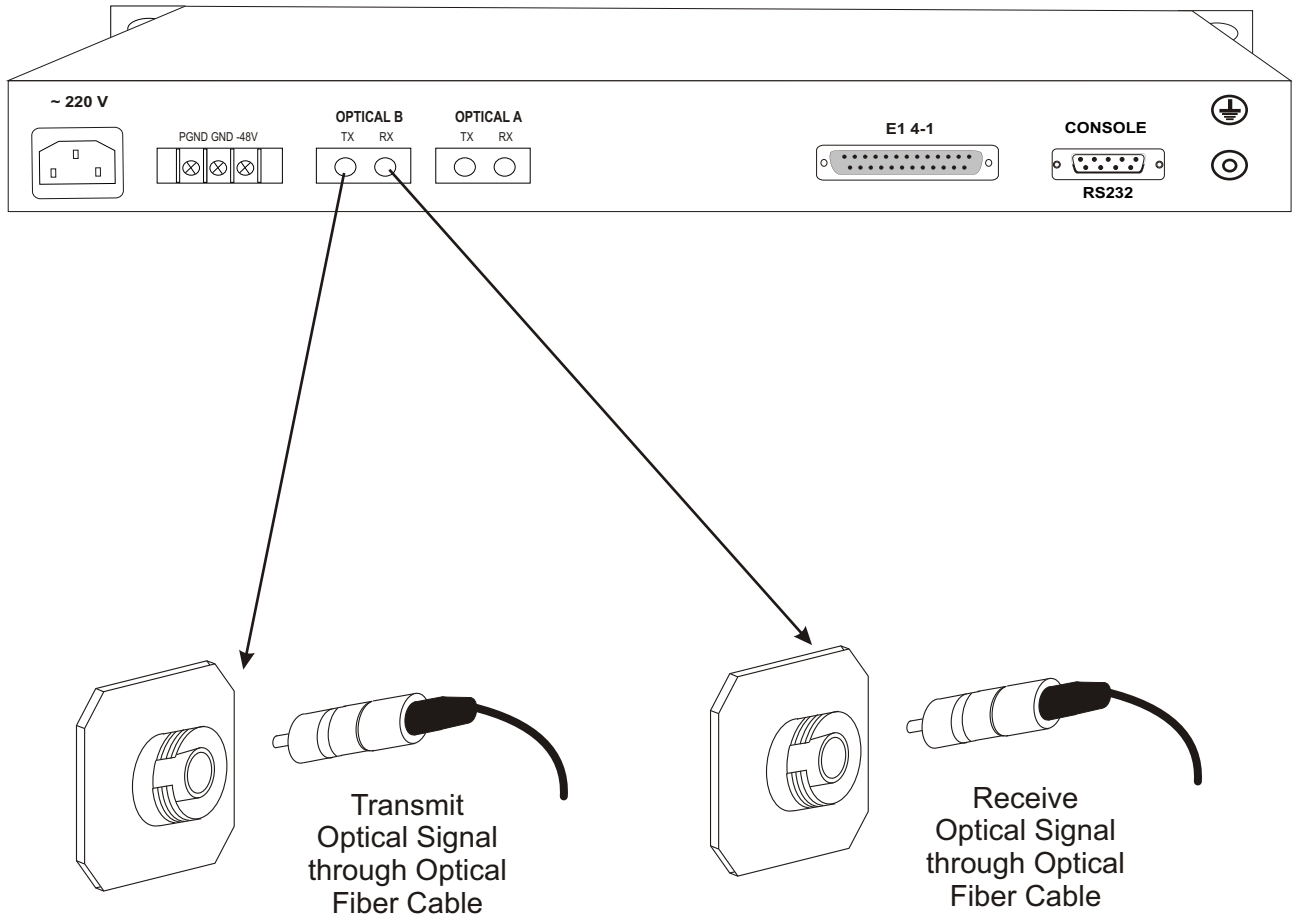

Note: Do not expose to the naked eye. Connect fiber cable to system when power is OFF.



For Testing: Always Install Optical Attenuators. For distances of less than 10 km, optical attenuators must be installed on the Optical Links. Otherwise, the optics will be permanently damaged.

Connecting the DB-37 connector

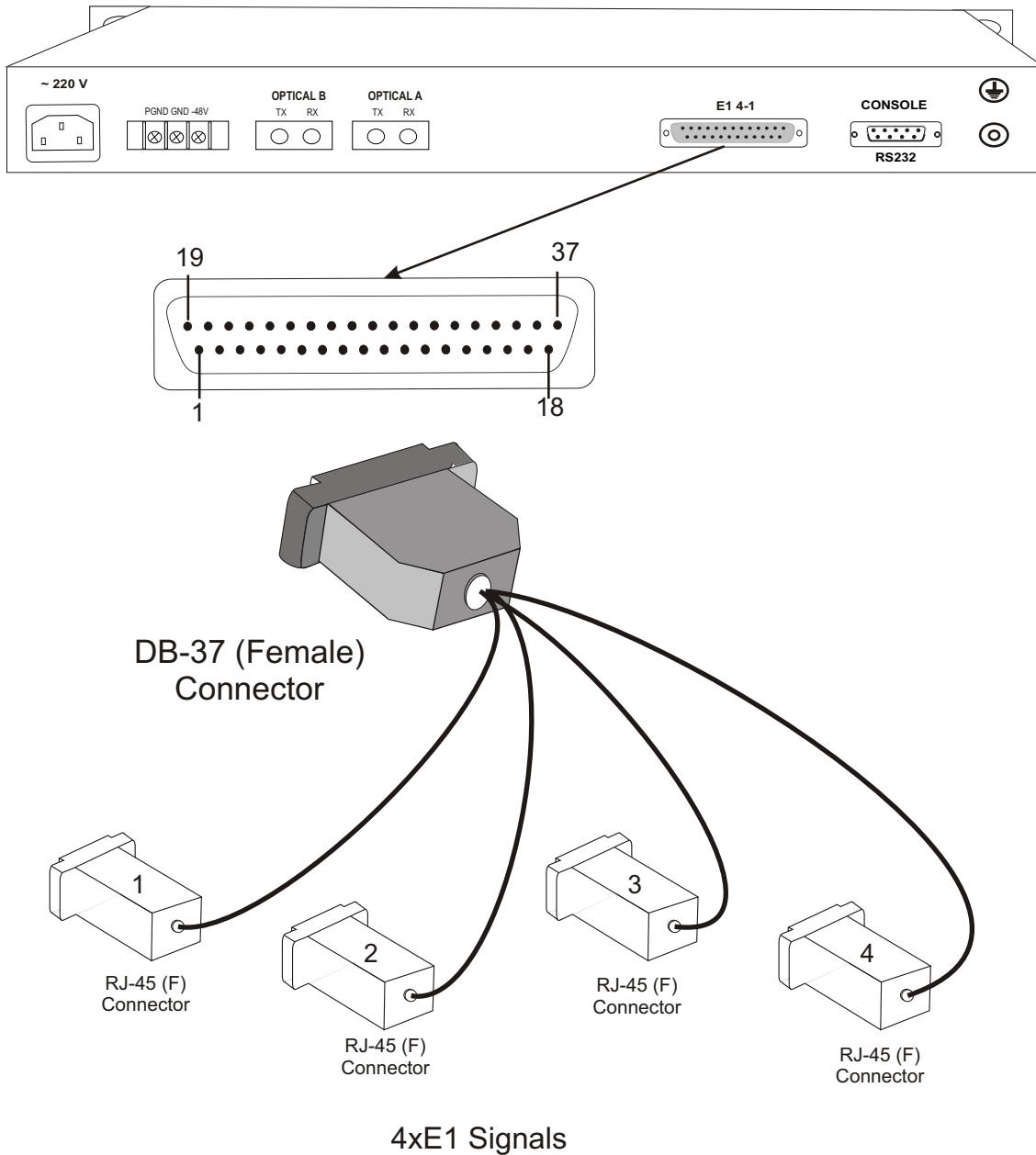

Note See Appendix B on page 74 for DB-37 connector pinouts.

Connecting E1 links

Connect E1 line after ensuring that transmission device have been grounded. A Bit Error Rate (BER) test may be conducted on E1 Link using a BERT tester to ensure that the E1 errors are within the permitted limits / threshold.

Definition for E1 Interfaces

The E1 Interface (RJ-45 connector) is defined as:

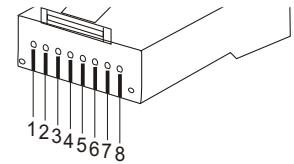

1	2	3	4	5	6	7	8
Rx+	Rx-	N/C	Tx+	Tx-	N/C	N/C	N/C
Data In +	Data In -		Data Out +	Data Out -			

Connecting Ethernet Links

Please configure the Ethernet port of the equipment at both sides as well as the Ethernet Ports of the devices that are connected to the equipment. Connect the Ethernet links.

Please ensure that the connecting LANs on both sides of the link are operating in the same IP domain.

Verifying the connection

Ping over the Ethernet connection from one side to the other (near-end to the far-end) to verify the link.

Definition for Ethernet Interfaces

The Ethernet Interface (RJ-45 connector) is defined as:

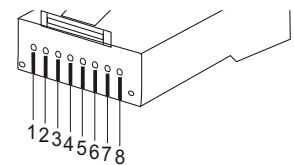

1	2	3	4	5	6	7	8
Tx+	Tx-	Rx+	N/C	N/C	Rx-	N/C	N/C
Data Out+	Data Out-	Data In+			Data In-		

Chapter 4 **Connecting the RS-232 port**

Chapter contents

Connecting the RS-232 port	30
RS-232 port cable details	31
RS-232 pin definition	31
Configuring HyperTerminal	32

Connecting the RS-232 port

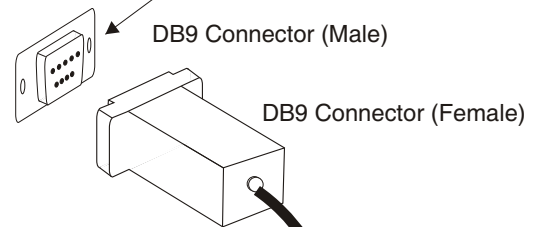
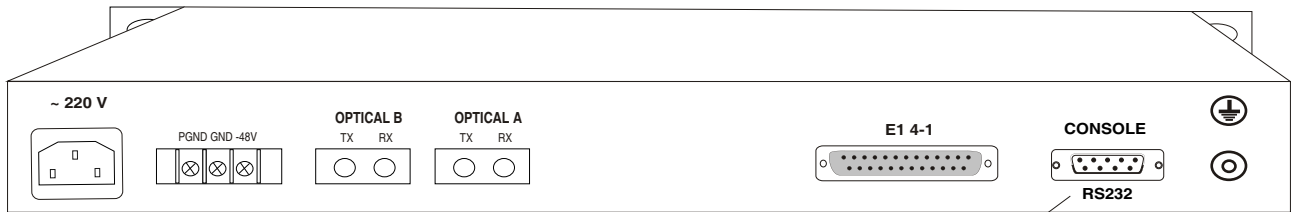

Settings:

1	Bits per second	19200
2	Data bits	8
3	Parity	None
4	Stop bits	1
5	Flow control	None

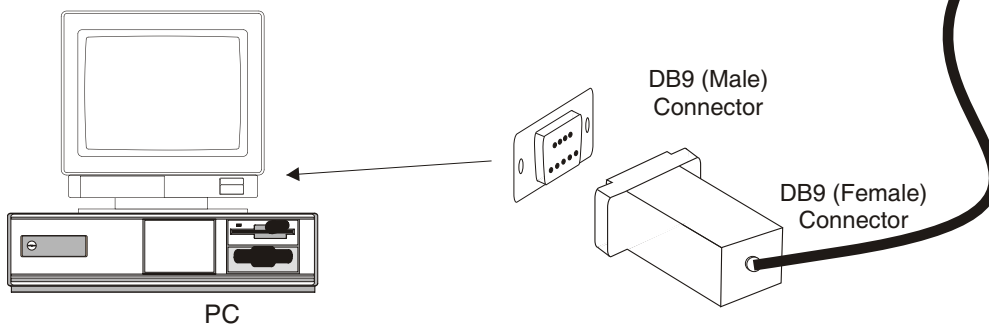

Note: RS232 COM Port cable is provided with the system.

RS-232 port cable details

End 1	DB-9 (Female Connector)
End 2	DB-9 (Female Connector)
Type of cable	Twisted pair cable - solid conductor
Number of pairs	2
Diameter	24 AWG
Length	3 meters
Connections	As per details given below

RS-232 pin definition

DB-9	Pin Number	Definition
RS-232	2	RS-232 input signal for management
	3	RS-232 output signal for management
	5	GND
	Others	NC

DB9—Pin Assignment
Female Connector

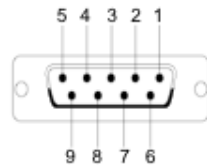

DB-9 (Female)

DB9—Pin Assignment
Female Connector

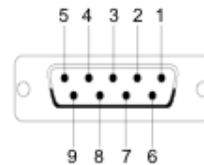

DB-9 (Female)

Configuring HyperTerminal

1. Click on the Start button from the task bar on your PC.
2. Select Programs > Accessories > Communications > HyperTerminal. The following screen will be displayed:

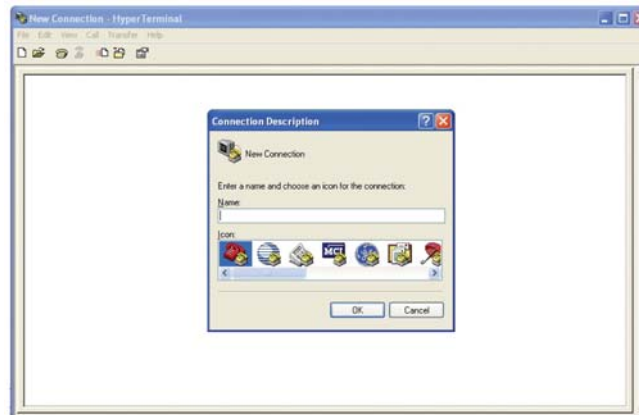

3. Enter a name for the new connection and click OK. The connection window will be displayed:



5. Change the Bits per second option to 19200 and change the flow control option to None. The COM Properties settings should be:

Bits per second	19200
Data bits	8
Parity	None
Stop bits	1
Flow control	None

6. Click Apply, then click OK.
7. A new HyperTerminal session screen will display. Press Enter. The system prompt will appear on the screen. This prompt is generated by the system. Now, you may access/configure the system with the CLI commands.

Note Remember to save the settings for future use before you exit the HyperTerminal window.

Chapter 5 CLI configuration

Chapter contents

General Commands	35
Specific Commands.....	37
Check current MAC address of the device	37
Check the current IP address of the device	37
Check gateway address of the device	37
View the get / getnext community of SNMP	37
Configure the get / getnext community of SNMP	37
View the set community of SNMP	38
Configure set community of SNMP	38
Change the IP address of the device	38
Change the Subnet mask information of the device	38
Change the Gateway information of the device	38
Change the MAC address of the device	39
Show system information	39
Enable / Disable the loopback of E1 Port	40
Check whether the E1 Port is looped back	40
Check the alarms of E1 Tributary	41
Configure laser port receive mode	41
View the current status of laser port	42
Reset the system	42
Set / configure the default settings in the device	42
Enable / Disable the Ethernet Port	42
Set / configure the Ethernet Port performance parameters	43
Check the Ethernet Port configuration	43
View the performance of ethernet port	44
View the status of ethernet port	44
Clear the performance statics / log of Ethernet, E1, GFP	44
Add a telnet user	45
Delete a Telnet user	45
Check the list of Telnet users	45
View the status of remote system power	45
Mask the unused e1 alarms	45
View the configuration of unused e1 alarm mask	45
Clear the record of E1's CV alarm	46
Configure the status of alarm tone mask	46
View the status of alarm tone mask	46
View the contact details.....	46

General Commands

After entering into the application program for CLI commands, press the “?” key in the command line to get the list of the commands.

Command	Description
?/help	To get a list of commands for the system
showmac	View MAC address
showip	View the IP address
showmask	View the subnet mask
showgw	View the gateway
showsnpget	View the GET/GETNEXT community of SNMP
snowsnpset	View the SET community of SNMP
setsnpget	Configure the GET/GETNEXT community of SNMP
setsnpset	Configure the SET community of SNMP
setip	Configure the IP address
setmask	Configure the subnet mask information
setgw	Configure the gateway information
setmac	Configure the Ethernet MAC address
showsysinfo	View the system information
sete1loop	Enable/Disable the loopback of the E1 port
showe1loop	View if the E1 port is looped back
e1alarm	View the alarms of E1 tributary
setcvmode	Configure the receive mode of the laser port
showlaser	View the current status of the laser port
reset	Perform a hot restart
setdefault	Configure the settings as default
enableport	Enable/Disable the Ethernet port
setport	Configure the Ethernet port
showport	View the Ethernet port configuration
ethperform	Clear the perform counter data
ethstatus	View Ethernet status
clearperform	Clear the perform counter data
adduser	Add a manager to TELNET
deluser	Delete a user from TELNET
showuser	View information of the TELNET manager
showrpd	View the status of remote system power destroy alarm
sete1mask	Configure the alarm mask of the unused E1 interface
showe1mask	View the configuration of unused E1's alarm mask
clearcv	Clear the record of E1's CV alarm
settonemask	Configure the status of the alarm tone mask
showtonemask	View the status of alarm tone mask
showcontact	View the contact details

For detailed command format, please key "? cmdname" or "help cmdname".

See the following examples:

Command	Example	Notes
1195#? [cmdname] {enter}	1195#? setelloop	To get further information about any command, type the command followed by "?".
OR	<FORMAT>: setelloop[E1ID] [Local_Loop][Remote_Loop]	
1195#help [cmdname] {enter}	<EXPLAIN>: Enable/Disable the loopback of E1 port, use this command to put the E1 line into loop- back mode or non-loop- back mode <PARAMETER>: E1ID: <0-8>, 0: All: 1-8: E1ID Local_Loop: <0/1>, loop status (0: non-loop ;1: loop) Remote_Loop: <0/1>, loop status (0: non-loop ;1: loop)	

Specific Commands

Check current MAC address of the device

Command	Response	Notes
1195#showmac {enter}	System MAC Address: 00.13.20.E8.86.76	Shows the MAC address of the local device

Check the current IP address of the device

Command	Response	Notes
1195#showip {enter}	System IP Address: 192.168.0.155	Shows the IP address of the local device

Check current subnet mask of the device

Command	Response	Notes
1195#showmask {enter}	System Subnet Mask: 255.255.255.0	Shows the subnet mask of the local device

Check gateway address of the device

Command	Response	Notes
1195#showgw {enter}	System Default Gateway Address: 192.168.0.1	Shows the Gateway of the local device

View the get / getnext community of SNMP

Command	Response	Notes
1195#showsnmpget {enter}	System SNMP get community: public	Shows the GET/GET NEXT community of SNMP of the local device.

Configure the get / getnext community of SNMP

Command	Response	Notes
1195#setsnmpget[string] {enter}	System SNMP get community: [string]	Configure the GET/GET NEXT community of SNMP of the local device, where [string]=0 to 31

View the set community of SNMP

Command	Response	Notes
1195#showsnmpset {enter}	System SNMP set community: public	Shows the SET community of SNMP of the local device

Configure set community of SNMP

Command	Response	Notes
1195#setsnmpset [string] {enter}	System SNMP set community: [string]	Configure the SET community of SNMP of the local device, where [string]=0 to 31

Change the IP address of the device

Command	Response	Notes
1195#setip [ipaddr] {enter}	System IP address: [ipaddr]	Change the IP address of the local device, where [ipaddr]=any valid IP address

Change the Subnet mask information of the device

Command	Response	Notes
1195#setmask [subnetaddr] {enter}	System subnet mask: [subnetaddr]	Change the subnet mask of the local device, where [subnetaddr]=any valid subnet address

Change the Gateway information of the device

Command	Response	Notes
1195#setgw [gwaddr] {enter}	System Default Gateway Address: [gwaddr]	Change the gateway of the local device, where [gwaddr]=any valid gateway address

Change the MAC address of the device

Command	Response	Notes
1195#setmac [macaddr] {enter}	MAC Address: [macaddr]	Change the MAC of the local device, where [macaddr]=any valid MAC address Note: A new MAC address will be activated after a system reset.

Show system information

Command	Response	Notes
1195#showsysinfo {enter}	View the system information. Includes hardware version, software version, and status of the interface.	View the system information. Includes hardware version, software version, and status of the interface.

=====System Information =====

```
System Hardware Version : 7.0.1
System Software Version : 1.0.0A9
Laser_A Interface Status : EXIST
Laser_B Interface Status : EXIST
E1 Interface Number : 8
Ethernet Interface Status : EXIST
EOW Card Status : EXIST
```

Enable / Disable the loopback of E1 Port

Command	Response	Notes
1195#setelloop [E1ID] [local_loop] [remote_loop] {enter}	E1ID: <0-8>,0: All; 1-8 :E1ID Local_Loop: <0/1>, loop status (0: non-loop ;1: loop) Remote_Loop: <0/1>, loop status (0: non-loop ;1: loop)	Enable/Disable the loopback of E1 port. Use this command to put the E1 line into loopback mode or non-loopback mode.

```
1195#setelloop 0 1 0
E1_1--E1_8 Local Loop : 1
E1_1--E1_8 Remote Loop : 0
Description:
    1 : Loop ; 0 : Not Loop
```

Check whether the E1 Port is looped back

Command	Response	Notes
1195#showelloop {enter}	Shows if the E1 port is loopbacked or not. See example below.	Shows if the E1 port is loopbacked or not.

E1_ID	L-LOOP-CFG	L-LOOP-STATUS	R-LOOP-CFG
1	1	1	0
2	1	1	0
3	1	1	0
4	1	1	0
5	1	1	0
6	1	1	0
7	1	1	0
8	1	1	0

Description: 1 : Loop , 0 : Not Loop

Check the alarms of E1 Tributary

Command	Response	Notes
1195#e1alarm {enter}	Shows the alarms of E1 tributary. See example below.	Shows the alarms of E1 tributary.

```

E1_ID      LOS      CV-RECORD
=====
1          1          0
2          1          0
3          1          0
4          1          0
5          1          0
6          1          0
7          1          0
8          1          1

```

Description: 1 : Alarm , 0 : Normal

Configure laser port receive mode

Command	Response	Notes
1195#setrcvmode [mode] {enter}	mode: <1-3>receive mode(1:force_A; 2:force_B; 3:auto)	Configure laser port receive mode.

Laser Interface Receive Mode : FORCED_B

View the current status of laser port

Command	Response	Notes
1195#showlaser {enter}	View the status of laser interface. Include alarm status, the config of receive mode, the current work interface.	View the status of laser interface. Include alarm status, the config of receive mode, the current work interface.

```

LPORT_ID      NOP      LOF      10E-3      10E-6
=====
      1          1          0          0          0
      2          1          0          0          0
Description: 1 : ALarm , 0 : Normal
*****
Laser Port receive mode setting: AUTO
*****
Current work Laser port : PORT_B

```

Reset the system

Command	Response	Notes
1195#reset {enter}	Performs a hot restart.	Performs a hot restart.

Set / configure the default settings in the device

Command	Response	Notes
1195#setdefault {enter}	The default settings have been successfully loaded in the system. Reset the system.	Configures the default setting in the system. Note: You must restart the system after executing this command.

Enable / Disable the Ethernet Port

Command	Response	Notes
1195#enableport [port] [Enable/Disable] {enter}	Port = A Enable/Disable = B	Enable/Disable the Ethernet port, where: A=1 (Ethernet Port No.) B=0:Disable, 1:Enable

Set / configure the Ethernet Port performance parameters

Command	Response	Notes
1195#setport [port] [AN] [rate] [duplex] [flow] {enter}	Port=A, AN=B, Rate=C, Duplex=D, Flow=E	Configure the Ethernet port performance parameters, where: A=1 (Ethernet Port No.) B=0:AN not done, 1:AN done C=0:10Mbit/s; 1:100Mbit/s D=0:half-duplex; 1:full-duplex E=flow-control capability; 0:disable; 1:enable

```

1195#setport 1 0 0 0 0
      PORT-ENABLE PORT-AN  ORT-RATE  PORT-DUPLEX  PORT_FLOW
=====
CONFIG VALUE   0      0      0      0      0
CURRENT VALUE  0      0      0      0      0
    
```

Check the Ethernet Port configuration

Command	Response	Notes
1195#showport {enter}	Shows the Ethernet port configuration. See example below.	Shows the Ethernet port configuration.

```

PORT-ID  PORT-AN  PORT-RATE  PORT-DUPLEX  PORT-FLOW
=====
      1      0      0      0      0
    
```

Description: AN: Auto Negotiation (0: AN not done; 1: AN done)
 RATE: (0: 10Mbit/s; 1: 100Mbit/s)
 DUPLEX: (0: half-duplex; 1: full-duplex)
 FLOW: flow-control capability (0: disable; 1: enable)

View the performance of ethernet port

Command	Response	Notes
1195#ethperform {enter}	View the performance of Ethernet.	View the performance of Ethernet.

```

PORT-ID          RX-ALLPACKETS    RX-ALLBYTES      RX-BROADCAST
=====
1                0,0              0,0              0,0

PORT-ID          TX-ALLPACKETS    TX-ALLBYTES      TX-BROADCAST
=====
1                0,0              0,0              0,0

PORT-ID          RX-ERRORPACKETS
=====
1                0,0
    
```

Description :
 Perform_Counter (H32) , (L32) = (H32) << 32 |(L32) ;
 H32 : High 32 bytes; L32 : low 32 bytes

View the status of ethernet port

Command	Response	Notes
1195#ethstatus {enter}	View the status of Ethernet.	View the status of Ethernet.

```

PORT-ID          PORT-STATUS
=====
1                UNLINK
    
```

Clear the performance statics / log of Ethernet, E1, GFP

Command	Response	Notes
1195#clearperform [A] {enter}	Clear the performance of E1, Ethernet, etc...	Clear the performance of E1, Ethernet, etc., where: A=1, 2; 1:all the performance, 2:Ethernet performance

Add a telnet user

Command	Response	Notes
1195#adduser [Username] [Password] {enter}	TELNET Manage Username: Username TELNET Manage Password: Password	Adds a telnet user, where user-name=<a string (1-31 Bytes)>, user login name. Password=<a string (1-31) Bytes)>, user login password.

Delete a Telnet user

Command	Response	Notes
1195#deluser [Username] [Password] {enter}	SUCCESS TO DELETE TELNET USER!	Deletes a telnet user, where user-name=any valid username, and password=any valid password.

Check the list of Telnet users

Command	Response	Notes
1195#showuser {enter}	TELNET Manage Username: superuser Password : superuser	Shows information of Telnet users.

View the status of remote system power

Command	Response	Notes
1195#showrpd {enter}	View the status of remote system power destroy alarm.	View the status of remote system power destroy alarm.

Mask the unused e1 alarms

Command	Response	Notes
1195#sete1mask [A] {enter}	Enable/disable : disable :0; enable : 1	Configure the alarm mask of unused E1 interface, where A=0,1 disable : 0; enable : 1

View the configuration of unused e1 alarm mask

Command	Response	Notes
1195#showe1mask {enter}	View the configuration of unused E1's alarm mask.	View the configuration of unused E1's alarm mask.

Clear the record of E1's CV alarm

Command	Response	Notes
1195#clearcv [enable] {enter}	enable : 1	Clear the record of E1's CV alarm.

Configure the status of alarm tone mask

Command	Response	Notes
1195#settonemask [A] {enter}	enable/disable : diable : 0 ; enable : 1	Configure the status of alarm tone mask, where A=0,1 disable : 0 ; enable : 1

View the status of alarm tone mask

Command	Response	Notes
1195#showtonemask {enter}	View the status of alarm tone mask.	View the status of alarm tone mask.

View the contact details

Command	Response	Notes
1195#showcontact {enter}	Patton Electronics Company 7622, Rickenbacker Drive Gaithersburg, MD 20879 Email: support@patton.com + (301) 975-1000	View the contact details of the company.

Chapter 6 **GUI configuration**

Chapter contents

Overview	48
Installing the GUI	48
Accessing the 1195/4E1.....	49
Adding/Removing a System.....	49
Adding a system	49
Removing a system	50
Editing a system	50
Communicating With a System.....	51
Adding/Removing Users.....	52
Adding a user	52
Removing a user	52
Editing a user entry	52
Status Monitoring	53
System Monitoring.....	54
Start/stop monitoring	54
Configure/view alarms	54
Change the Trap Community and/or Port	54
View log	55
Managing Trap Details.....	55
Configuring System Settings.....	55
Configuring IP Settings	56
Configuring Trap Settings.....	57
Configuring Default Settings.....	58
SNMP Community.....	59
Viewing Settings.....	60
Back Up	61
Restore	61
Synchronize.....	62
Report	62
List of systems	62
List of traps	63
Read Me.....	64
System Information	65
Exiting the System.....	65

Overview

This chapter describes how to use the Graphical User Interface (GUI) to access and configure the Model 1195.

Installing the GUI

1. Insert the CD that came with the 1195 into the CD-ROM drive. The CD will automatically start and display the main window.

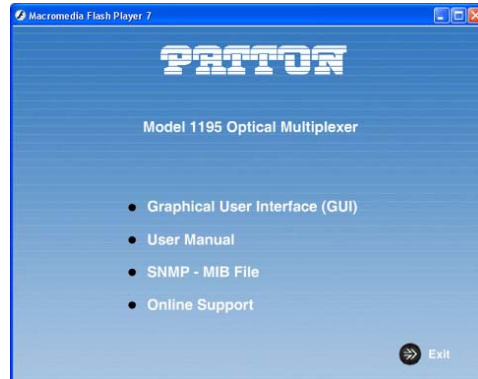

Figure 9. CD flash screen

2. Click on **Graphical User Interface (GUI)** to begin the installation. The Install Wizard window will display.
3. Click **Next** to proceed to the next step. Select the “I accept...” option and click **Next**.
4. Enter your user information and click **Next**.
5. Review the settings for installing the program and click **Install** to proceed.
6. A window will display to confirm the installation was completed. Click **Finish**.

Accessing the 1195

The Model 1195 GUI helps in configuring the 1195 system through a serial port connection between the equipment and a PC or to establish a remote login to the equipment. It also allows the user to configure the system as desired and also provides the information about the status of the system.

To start the GUI, first make a proper connection between the equipment and the computer using a factory-supplied RS-232 cable (DB-9 (Female) to DB-9 (Female) or Ethernet crossover cable provided with the system). Then, open the GUI. The following screen will display:

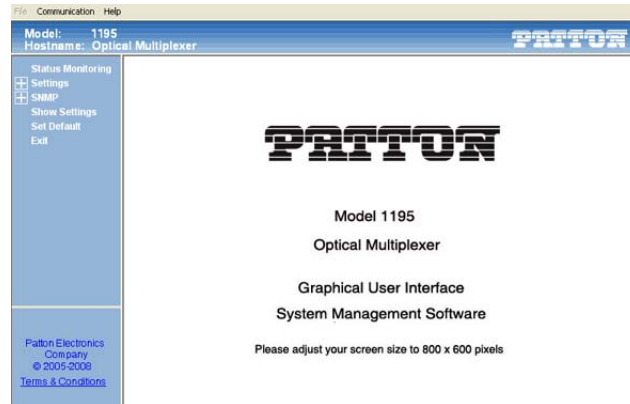

Figure 10. Model 1195 Main Menu window

Adding/Removing a System

Adding a system

To add a new system:

1. Click on **Option** at the top of the screen and select **Add/Remove System**. The following window will appear:

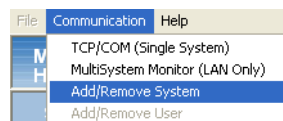

Add/Remove System

Imp: To Make The IP Address Effective Login Through COM Port And Go To 'Settings > IP Settings'

Figure 11. Add/Remove System

2. Click **New**. Enter information for all of the fields.
3. Click **Add**. The system will be added. The GUI supports up to 2,000 systems.

Note When you are entering the information for the new system, assign the correct IP address of that system. If needed, you can change the IP address of the system. To change the IP address of the system, make a local connection (through the COM port), then click on **Settings > IP Settings**.

Removing a system

There are two ways to remove a system.

Option 1: In the Add/Remove System window, select the system, then select **Remove** in the Status field. The entry of the system will be removed temporarily. The entry may be revived later.

Option 2: Click **Remove**. The entry will be removed permanently. To add the same system again, you will need to create a new entry.

Editing a system

To make necessary changes for the current entry, enter the desired changes into the fields in the Add/Remove System window. Then, click **Edit**. The current entry will be updated.

Communicating With a System

To communicate with the system, you have to make a connection with the system through a TCP or COM port.

To select a COM port:

1. Click on the **Option** menu at the top of the screen and select **TCP/COM (Single System)**.

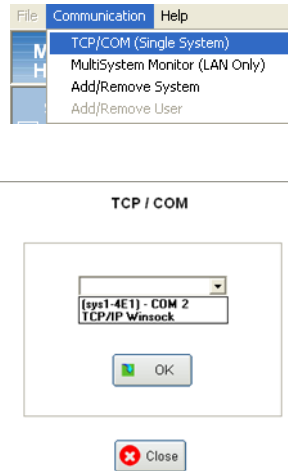

Figure 12. Select COM port

2. From the drop-down menu, select the COM port that is in use. The message “COM X is selected” will display.
3. Click OK.

To access the system remotely, select **TCP/IP Winsock**.

1. Click on the **Option** menu at the top of the screen and select **Communication (Single System)**.

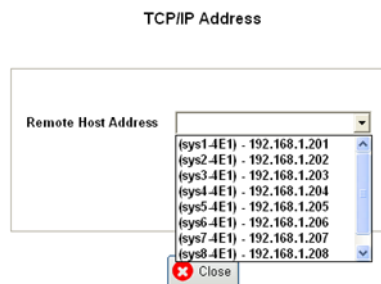

Figure 13. Select TCP/IP address

2. From the drop-down menu, select the **TCP/IP Winsock**.
3. Select the IP address of the equipment in the field **REMOTE HOST IP ADDRESS**.

4. To change the IP address, connect to the system with the COM port using an RS-232 cable.
5. Click on **Settings > IP Settings**. Click **OK**. A login window will display.
6. Enter the **User Name** and **Password**. Click **Submit**.

Figure 14. Login

Note User name and password are case sensitive.

Adding/Removing Users

Adding a user

To add a new user, click on **Option** at the top of the screen and select **Add User**. A window will display. Click **New**. Enter information for all of the fields, then click **Add**.

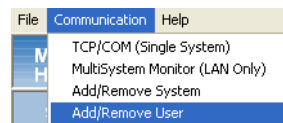

Figure 15. Add user

Removing a user

To remove a user, select a user from the drop-down menu in the User window. Then, click **Remove**.

Editing a user entry

To make changes to an existing user, select the user from the drop-down menu in the User window. Make the desired changes, then click **Edit**. The current entry will be updated.

Status Monitoring

To view the status and current alarms of the 1195 click on **Tributary Interface** at the top of the screen and select **Status Monitoring**.

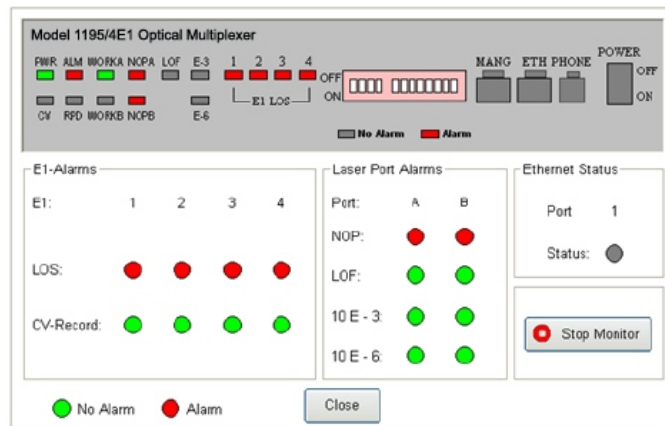
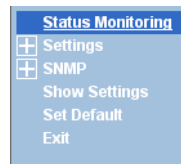

Figure 16. Status Monitoring

If a status is **Red**, there is an alarm.

If the status is **Green**, there is no alarm.

If the status is **Yellow**, the E1 is under physical loopback.

System Monitoring

To monitor the alarms of all the systems present in the network, click on **Communication** at the top of the screen and select **MultiSystem Monitor (NMS)**. A list of the systems will display.

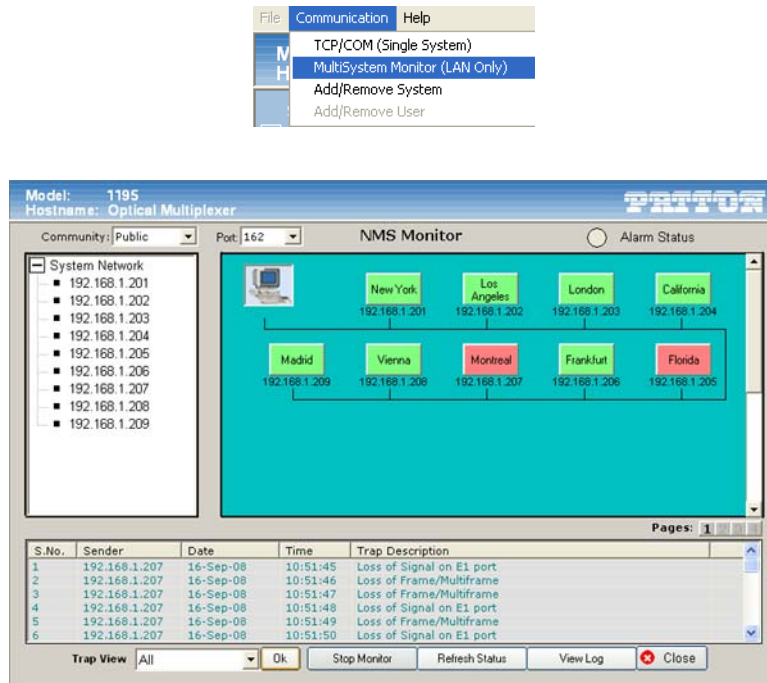

Figure 17. System Monitoring

Start/stop monitoring

- To stop monitoring, click **Stop Monitor**.
- To restart monitoring, click **Start Monitor**.

Configure/view alarms

To configure or view the detailed alarms of any particular system, click the colored button for any selected system in the system list. The color of the system's button indicates the status of alarms for the system. **Red** indicates that there are alarms present on the system. **Green** indicates that there are currently no alarms found on the system. **Grey** indicates that the system cannot be found. **Yellow** indicates that the application is checking for alarms for that particular system.

The alarm indicator at the top of the screen indicates if there is any alarm present in any of the systems in the network.

Change the Trap Community and/or Port

To change the trap community and/or port, you need to stop monitoring first. To stop monitoring, click **Stop Monitor**. You can change the community and port with the drop-down menus at the top of the systems list. After you have made the desired changes, click **Start Monitor**.

View log

Click the **View Log** button at the bottom of the screen to view details of all of the traps received to date.

Note Refresh the systems list to view the most current information.

Managing Trap Details

To view the details of traps for the last ten days, click on **Communication** at the top of the screen and select **Multisystem Monitoring (NMS)**. The list of systems will display.

1. Select the duration of traps from **Trap View** drop down list box at the bottom of the screen.
2. Click **OK** button. The selected trap will appear in the screen.

Configuring System Settings

To configure settings for the system, click on **Settings** at the top of the screen and select **System Settings**. A window will display where you can make the desired changes.

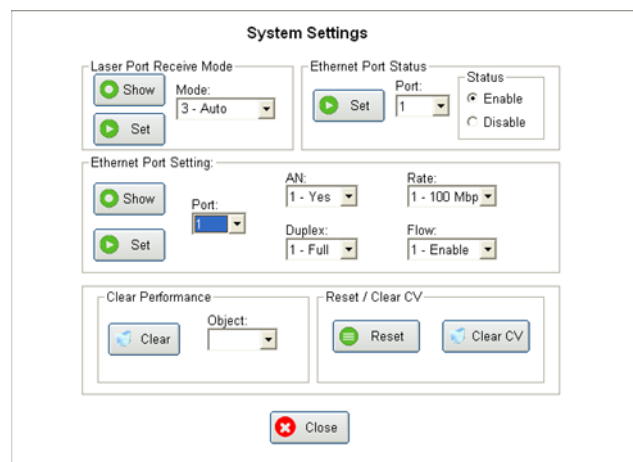
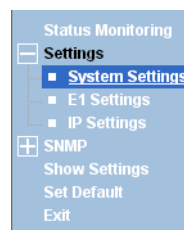

Figure 18. System settings

To configure settings for E1 and Mask, click on **Settings** at the top of the screen and select **E1 Settings**. A window will display where you can make the desired changes.

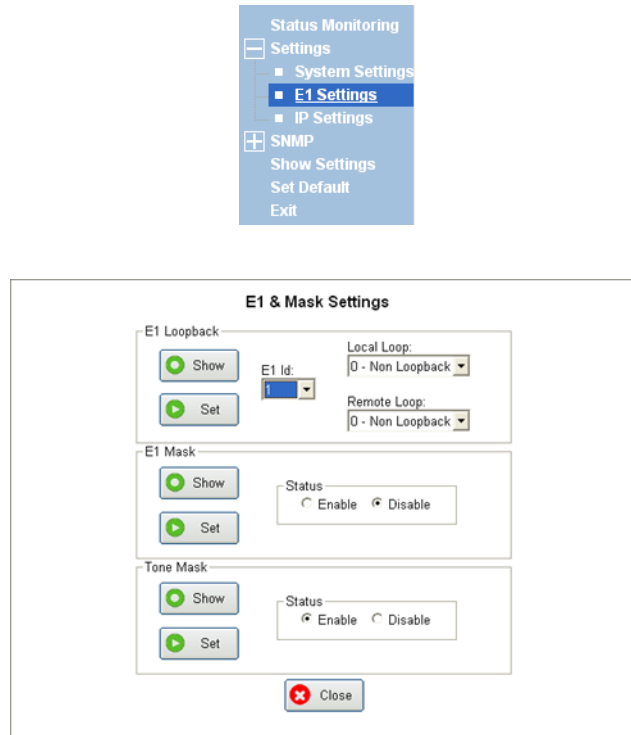
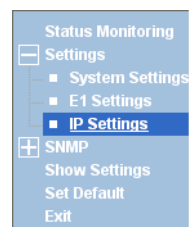

Figure 19. E1 settings

Configuring IP Settings

To configure settings for IP addresses, click on **Settings** at the top of the screen and select **IP Settings**. A window will display where you can make the desired changes.



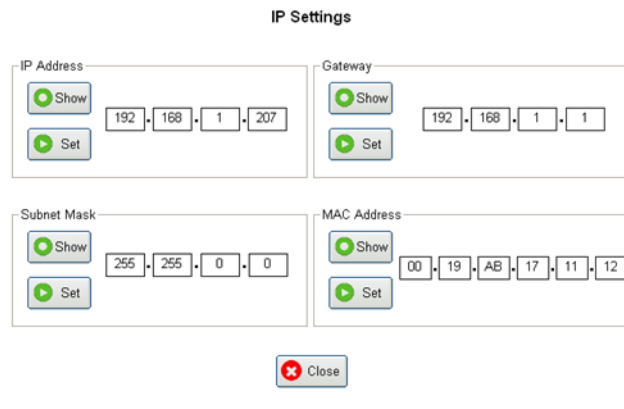

Figure 20. IP settings

Note Changing MAC addresses will reset the system.

Configuring Trap Settings

To configure the settings for receiving traps, click on **SNMP** at the top of the screen and select **Trap Settings**. A window will display where you can create a list of monitoring systems to which traps will be sent by the selected device. The Trap Settings list can have up to 6 monitoring systems.

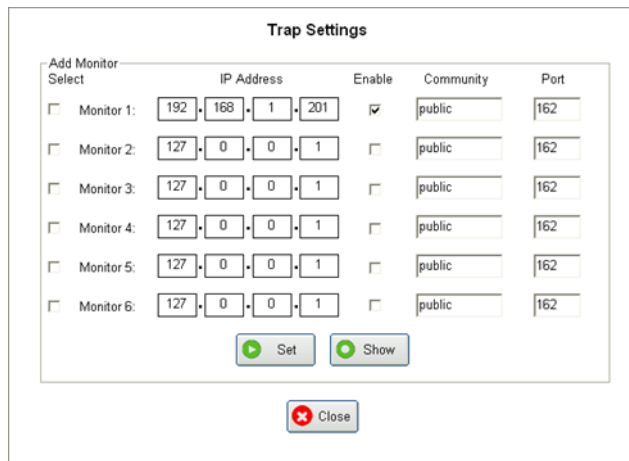

Figure 21. Trap settings

Configuring Default Settings

To restore the default settings, click on **Set Default** at the top of the screen. A window will display. Click **Yes** to begin the process.

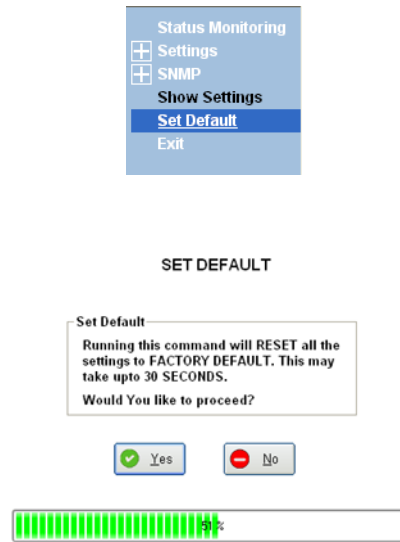

Figure 22. Default settings

The default settings are:

1. Laser Mode 3
2. E1 Local Loop 0
3. E1 Remote Loop 0

For Ethernet Port:

1. AN 1
2. Flow 1
3. Rate 1
4. Duplex 1

SNMP Community

To set and view the SNMP Set and SNMP Get Community options, click on **SNMP** at the top of the screen and select **SNMP Community**. A window will display.

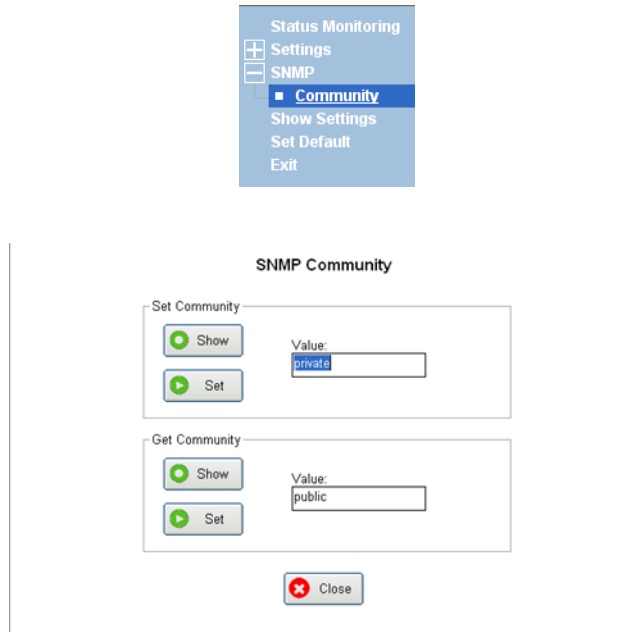

Figure 23. SNMP Community

Note You cannot set or view other SNMP features through the GUI.

Viewing Settings

To view general system settings, click on **Show Settings** at the top of the screen . A window will display that shows current system values. Click on any of the properties displayed in the list and the details will be displayed in the Result window.

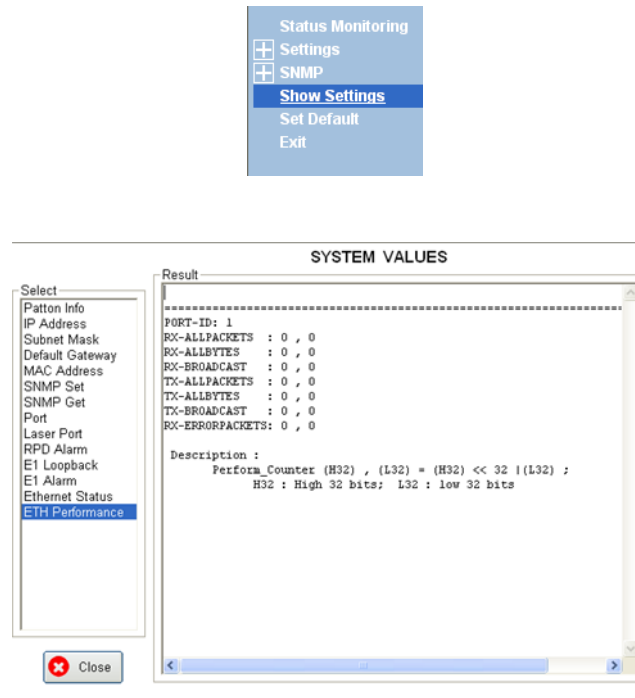

Figure 24. Show settings

Back Up

To create a backup of all of the settings, click on **File** at the top of the screen and select **Back Up**. A screen will display. Click **Open** and select the path where you want to save the backup file. Click **Save**.

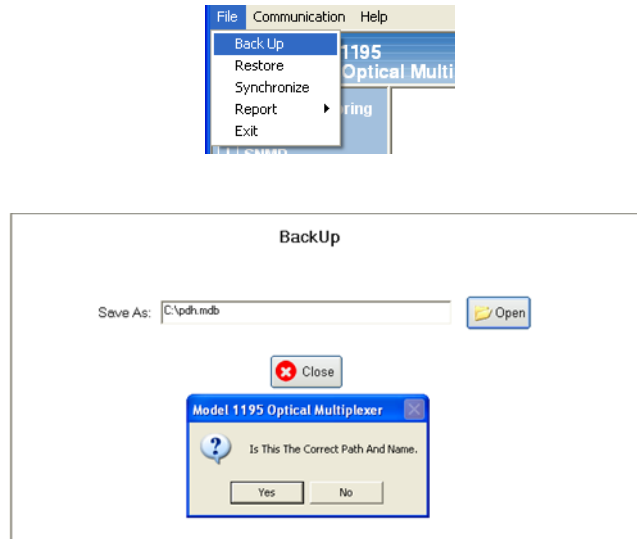

Figure 25. Back up

Restore

To restore settings from the backup file, click on **File** at the top of the screen and select **Restore**. A screen will display. Click **Open File**. A dialog box will appear where you should select the backup file. Click **Submit** to start the restore process..



Figure 26. Restore

Synchronize

To synchronize the system, click on **File** at the top of the screen and select **Synchronize**. A screen will display. Click **Yes** to start the process. The purpose of synchronization is to update the database with the current settings in the system. (For example, if you make any changes to system settings through the CLI).

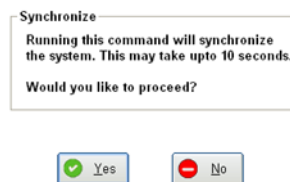
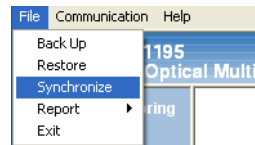
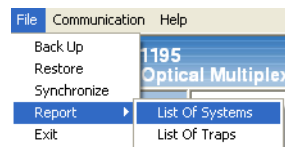

Figure 27. Synchronize

Report

List of systems

To view the report of the list of systems, click on **File** at the top of the screen and select **Report > List of Systems**. A screen will display. Click on **Generate Report**. The report will display in a window.



 A screenshot of a window titled 'List Of Systems' with a date '06/02/2009'. The window has a zoom level of 100%. It displays a table with the following data:

Type	Name	IP Address	COM	Location
Optical Multiplexer	sys1	192.168.1.201	2	New York
Optical Multiplexer	sys2	192.168.1.202	2	Los Angeles
Optical Multiplexer	sys3	192.168.1.203	2	London
Optical Multiplexer	sys4	192.168.1.204	2	California
Optical Multiplexer	sys5	192.168.1.205	2	Florida
Optical Multiplexer	sys6	192.168.1.206	2	Frankfurt
Optical Multiplexer	sys7	192.168.1.207	2	Montreal

Figure 28. View systems report

List of traps

To view the report of the list of traps, click on **File** at the top of the screen and select **Report > List of Traps**. A screen will display. To view the traps of a specific system, click on **Traps of Selected System**. To view traps of all the systems, click on **Traps of All Systems**. The report will display in a window.

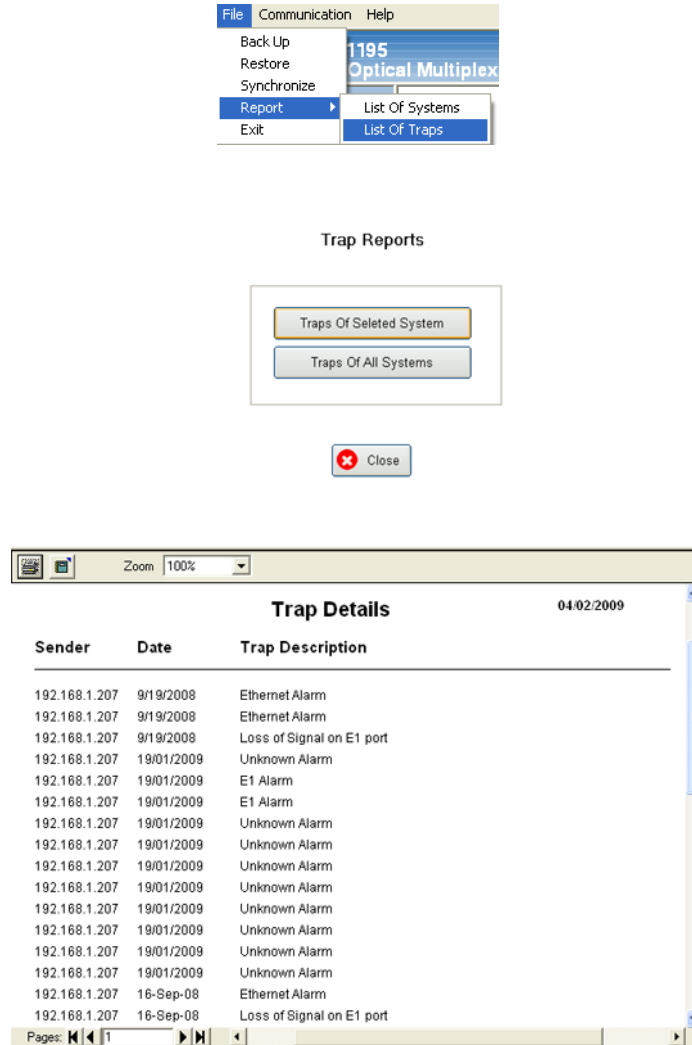

Figure 29. View traps

Read Me

To learn about system requirements for running the GUI, click on **Help** at the top of the screen and select **Read Me**. The instructions will display in a window.

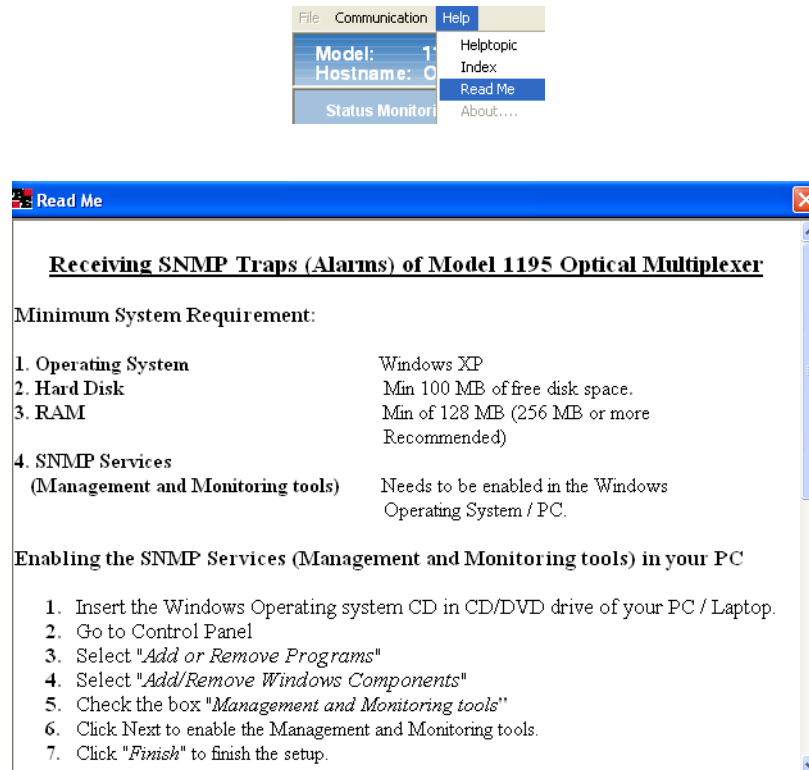

Figure 30. Readme file

System Information

To learn about firmware and GUI release versions, click on **Help** at the top of the screen and select **About**. A window will display with the system information.

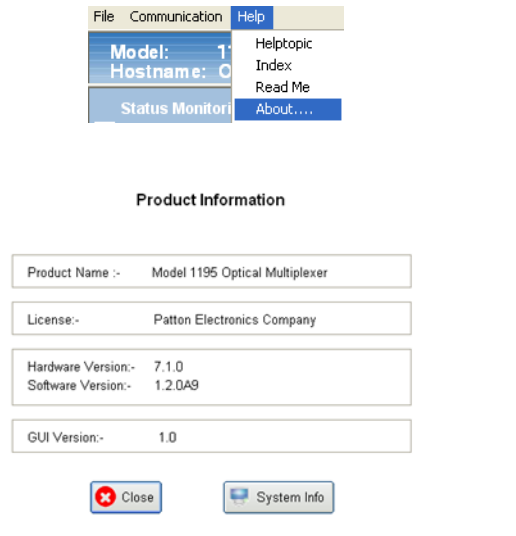
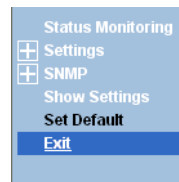

Figure 31. View system information

Exiting the System

To disconnect from the system, click on **File** at the top of the screen and select **Exit**.



Chapter 7 **Contacting Patton for assistance**

Chapter contents

Introduction	67
Contact information	67
Patton support headquarters in the USA	67
Alternate Patton support for Europe, Middle East, and Africa (EMEA)	67
Warranty Service and Returned Merchandise Authorizations (RMAs)	67
Warranty coverage	67
Out-of-warranty service	68
Returns for credit	68
Return for credit policy	68
RMA numbers	68
Shipping instructions	68

Introduction

This chapter contains the following information:

- “[Contact information](#)”—describes how to contact Patton technical support for assistance.
- “[Warranty Service and Returned Merchandise Authorizations \(RMAs\)](#)”—contains information about the warranty and obtaining a return merchandise authorization (RMA).

Contact information

Patton Electronics offers a wide array of free technical services. If you have questions about any of our other products we recommend you begin your search for answers by using our technical knowledge base. Here, we have gathered together many of the more commonly asked questions and compiled them into a searchable database to help you quickly solve your problems.

Patton support headquarters in the USA

- Online support: available at www.patton.com
- E-mail support: e-mail sent to support@patton.com will be answered within 1 business day
- Telephone support: standard telephone support is available five days a week—from 8:00 am to 5:00 pm EST (1300 to 2200 UTC/GMT)—by calling +1 (301) 975-1007
- Fax: +1 (253) 663-5693

Alternate Patton support for Europe, Middle East, and Africa (EMEA)

- Online support: available at www.patton-inalp.com
- E-mail support: e-mail sent to support@patton-inalp.com will be answered within 1 business day
- Telephone support: standard telephone support is available five days a week—from 8:00 am to 5:00 pm CET (0900 to 1800 UTC/GMT)—by calling +41 (0)31 985 25 55
- Fax: +41 (0)31 985 25 26

Warranty Service and Returned Merchandise Authorizations (RMAs)

Patton Electronics is an ISO-9001 certified manufacturer and our products are carefully tested before shipment. All of our products are backed by a comprehensive warranty program.

Note If you purchased your equipment from a Patton Electronics reseller, ask your reseller how you should proceed with warranty service. It is often more convenient for you to work with your local reseller to obtain a replacement. Patton services our products no matter how you acquired them.

Warranty coverage

Our products are under warranty to be free from defects, and we will, at our option, repair or replace the product should it fail within one year from the first date of shipment. Our warranty is limited to defects in workmanship or materials, and does not cover customer damage, lightning or power surge damage, abuse, or unauthorized modification.

Out-of-warranty service

Patton services what we sell, no matter how you acquired it, including malfunctioning products that are no longer under warranty. Our products have a flat fee for repairs. Units damaged by lightning or other catastrophes may require replacement.

Returns for credit

Customer satisfaction is important to us, therefore any product may be returned with authorization within 30 days from the shipment date for a full credit of the purchase price. If you have ordered the wrong equipment or you are dissatisfied in any way, please contact us to request an RMA number to accept your return. Patton is not responsible for equipment returned without a Return Authorization.

Return for credit policy

- Less than 30 days: No Charge. Your credit will be issued upon receipt and inspection of the equipment.
- 30 to 60 days: We will add a 20% restocking charge (crediting your account with 80% of the purchase price).
- Over 60 days: Products will be accepted for repairs only.

RMA numbers

RMA numbers are required for all product returns. You can obtain an RMA by doing one of the following:

- Completing a request on the RMA Request page in the *Support* section at **www.patton.com**
- By calling **+1 (301) 975-1007** and speaking to a Technical Support Engineer
- By sending an e-mail to **returns@patton.com**

All returned units must have the RMA number clearly visible on the outside of the shipping container. Please use the original packing material that the device came in or pack the unit securely to avoid damage during shipping.

Shipping instructions

The RMA number should be clearly visible on the address label. Our shipping address is as follows:

Patton Electronics Company

RMA#: xxxx

7622 Rickenbacker Dr.

Gaithersburg, MD 20879-4773 USA

Patton will ship the equipment back to you in the same manner you ship it to us. Patton will pay the return shipping costs.

Appendix A **Specifications**

Chapter contents

E1 Interface	70
Optical	70
Optical Interface Specifications: 1310nm Single Mode.....	71
Transmitter Optical Characteristics	71
Receiver Optical Characteristics	71
Optical Interface Specifications: 1550nm Single Mode.....	71
Transmitter Optical Characteristics	71
Receiver Optical Characteristics	72
Safety.....	72
Ethernet Interface.....	72
Configuration, Management and Alarms.....	72
Power Supply	72
Environment	73
Physical	73

E1 Interface

- Electrical Interface: E1
- Channel capacity: Up to 8E1
- Bit rate: 2.048 Mbps + 50 ppm
- Line code: HDB3
- Frame Structure: As per G.704
- Electrical Interface: As per G.703
- Nominal impedance: 120 Ω balanced / 75 Ω unbalanced (optional)
- Jitter character: ITU-T G.742, G.823 compliant
- Connectors: Male DB37 interface with RJ-45 connectors (120 Ω balanced) or Male DB37 interface with BNC coaxial connectors (75 Ω unbalanced)

Optical

- Type of Transmitter: Class 1 Laser
- Transmitter power: >- 3dBm, >- 6dBm, >- 9dBm options, as ordered
- Bit rate: 155 Mbps
- Wavelength: 1310/1550nm (optional)
- Optical connector: FC/PC
- Receiver Sensitivity: < - 36 dBm
- Typical output power: > -9dBm
- Fully Compliant with ITU-T G.957, G.958 Specification
- Class 1 Laser Product, Compliant with IEC 60825-1
- Compliant with Telcordia (Bellcore) GR-468-CORE

Optical Interface Specifications: 1310nm Single Mode

Transmitter Optical Characteristics

Parameter	Minimum	Typical	Maximum
Data Rate		125Mb/s	
Center Wavelength	1260nm	1310nm	1360nm
Output Spectral Width (RMS)			6nm
Average Output power	-10dBm	-12dBm	-8dBm
Output optical Eye	Complaint with ITU-T G.957		
Connectors	FC		

Receiver Optical Characteristics

Parameter	Minimum	Typical	Maximum
Data Rate		125Mb/s	
Receive Sensitivity	-32dBm		
Maximum Input Power			-15dBm
Operating Wavelength	1100nm		1600nm
Connectors	FC		

Optical Interface Specifications: 1550nm Single Mode

Transmitter Optical Characteristics

Parameter	Minimum	Typical	Maximum
Data Rate		125Mb/s	
Center Wavelength	1480nm	1550nm	1580nm
Output Spectral Width (RMS)			4nm
Average Output power	-15dBm	-12dBm	-8dBm
Output optical Eye	Complaint with ITU-T G.957		
Connectors	FC		

Receiver Optical Characteristics

Parameter	Minimum	Typical	Maximum
Data Rate		125Mb/s	
Receive Sensitivity	-32dBm		
Maximum Input Power			-15dBm
Operating Wavelength	1100nm		1600nm
Connectors	FC		

Safety

- Class 1 Laser
- Auto Laser Shut Down in the event of fiber break.

Ethernet Interface

- 10/100BaseT
- Number of Interfaces: 1
- Interface: RJ-45 Ethernet 10BaseT or 100BaseT-TX (auto sensing)
- Compliance: Ethernet Version 2.0 IEEE802.3
- 10Base-T & 100Base-TX Activity, Full/half duplex.
- Interface Rate: 100 Mbps Ethernet data transmission rate
- Connector: RJ-45

Configuration, Management and Alarms

- Serial Management Port - RS232 interface
- 10/100 BaseT for Remote Management over a LAN
- 10/100 BaseT Telnet over a TCP-IP Network
- SNMP V2

Power Supply

- Power Input: AC, DC, AC + DC
- DC power:DC - 48V(-36--72V)
- AC power:AC 220V (185-265V)
- Power consumption: 18 Watts maximum

Environment

- Temperature: -5°C ~ +55°C for operation
- - 40°C to +70°C for storage
- Humidity: 5% to 95% (35°C) - non-condensing

Physical

- Width: 1552 mm
- Depth: 434 mm
- Height: 44 mm
- Weight: 2 kg.
- Rack Type: EIA 19-Inch

Appendix B **Connector pinouts**

Chapter contents

DB-37 connector pinout (Model 1195).....	75
DB-37 connector pinout details for E1 connections	75

DB-37 connector pinout (Model 1195)

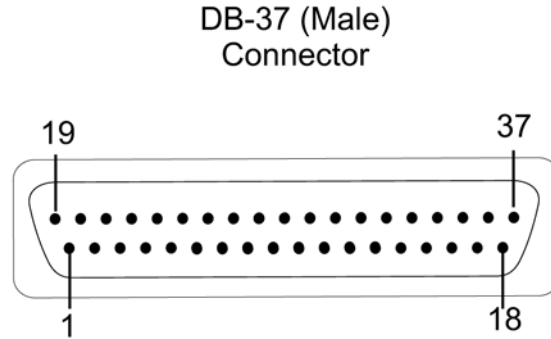

Figure 32. DB-37 connector pinout

DB-37 connector pinout details for E1 connections

DB-37 (Male) Connector Pin Number #	Description	DB-37 (Male) Connector Pin Number #	Description
16	Tx Signal of first E1	15	Rx Signal of first E1
34	Tx EGND of first E1	33	Rx EGND of first E1
12	Tx Signal of second E1	11	Rx Signal of second E1
30	Tx EGND of second E1	29	Rx EGND of second E1
8	Tx Signal of third E1	7	Rx Signal of third E1
26	Tx EGND of third E1	25	Rx EGND of third E1
4	Tx signal of fourth E1	3	Rx Signal of fourth E1
22	Tx EGND of fourth E1	21	Rx EGND of fourth E1

Free Manuals Download Website

<http://myh66.com>

<http://usermanuals.us>

<http://www.somanuals.com>

<http://www.4manuals.cc>

<http://www.manual-lib.com>

<http://www.404manual.com>

<http://www.luxmanual.com>

<http://aubethermostatmanual.com>

Golf course search by state

<http://golfingnear.com>

Email search by domain

<http://emailbydomain.com>

Auto manuals search

<http://auto.somanuals.com>

TV manuals search

<http://tv.somanuals.com>