

USER MANUAL

MODEL 2017P
RS-232 to 20mA and
MODEL 2017P60
RS-232 to 60mA
Current Loop Converters



PA PATTON
Electronics Co.

07M2017P-E
Doc# 073051UE
Revised 5/7/96

SALES OFFICE
(301) 975-1000
TECHNICAL SUPPORT
(301) 975-1007

1.0 WARRANTY INFORMATION

Patton Electronics warrants all Model 2017P components to be free from defects, and will—at our option—repair or replace the product should it fail within one year from the first date of shipment.

This warranty is limited to defects in workmanship or materials, and does not cover customer damage, abuse or unauthorized modification. If this product fails or does not perform as warranted, your sole recourse shall be repair or replacement as described above. Under no condition shall **Patton Electronics** be liable for any damages incurred by the use of this product. These damages include, but are not limited to, the following: lost profits, lost savings and incidental or consequential damages arising from the use of or inability to use this product. **Patton Electronics** specifically disclaims all other warranties, expressed or implied, and the installation or use of this product shall be deemed an acceptance of these terms by the user.

1.1 RADIO AND TV INTERFERENCE

The Model 2017P generates and uses radio frequency energy, and if not installed and used properly—that is, in strict accordance with the manufacturer's instructions—may cause interference to radio and television reception. The Model 2017P has been tested and found to comply with the limits for a Class A computing device in accordance with the specifications in Subpart J of Part 15 of FCC rules, which are designed to provide reasonable protection from such interference in a commercial installation. However, there is no guarantee that interference will not occur in a particular installation. If the Model 2017P does cause interference to radio or television reception, which can be determined by disconnecting the RS-232 interface, the user is encouraged to try to correct the interference by one or more of the following measures: moving the computing equipment away from the receiver, re-orienting the receiving antenna and/or plugging the receiving equipment into a different AC outlet (such that the computing equipment and receiver are on different branches).

1.2 SERVICE

All warranty and non-warranty repairs must be returned freight prepaid and insured to Patton Electronics. All returns must have a Return Materials Authorization number on the outside of the shipping container. This number may be obtained from Patton Electronics Technical Service at **(301) 975-1007**. *Packages received without an RMA number will not be accepted.*

Patton Electronics' technical staff is also available to answer any questions that might arise concerning the installation or use of your converter. Hours: **8AM to 5PM EST, Monday through Friday.**

2.0 GENERAL INFORMATION

Thank you for your purchase of this Patton Electronics product. This product has been thoroughly inspected and tested and is warranted for One Year parts and labor.

If any questions or problems arise during installation or use of this product, please do not hesitate to contact Patton Electronics Technical Support at **(310) 975-1000**.

2.1 FEATURES

- Full duplex, asynchronous operation over 4 wires
- Data rates to 115,200 bps
- Model 2017P works with active 20mA devices
- **Model 2017P60** works with active 60mA devices
- Range to 4 miles on 24 AWG twisted pair
- No AC power required
- Optically isolated and surge protected
- Twisted pair connection via terminal blocks, RJ-11 or RJ-45 jacks
- External DCE/DTE switch
- Made in the USA

2.2 DESCRIPTION

The Model 2017P RS-232 to 20mA current loop converter lets an asynchronous RS-232 device communicate with a 20mA current loop device (the **Model 2017P60** works with 60mA current loop devices). The Model 2017P requires no AC power or batteries to operate and supports data rates to 115.2 Kbps.

Operating full duplex, the Model 2017P supports communication distances up to 4 miles over two unconditioned 24 AWG twisted pair. To guard against data loss due to ground loops, the Model 2017P is equipped with 2500V RMS optical isolators on the line side.

The Model 2017P connects directly to the RS-232 interface using a male or female DB-25 connector. Two-pair cable running to the 20mA current loop device attaches to the Model 2017P by RJ-11 jack, RJ-45 jack or terminal blocks with built-in strain relief. An external DCE/DTE switch on the Model 2017P eliminates the need for a cross-over cable on the RS-232 interface. Like all Patton products, the Model 2017P is manufactured in the USA.

3.0 CONFIGURATION

The Model 2017P is designed to be easy to use. There are no internal jumpers or DIP switches to set, so there is no need to open the case to configure the unit (you may need to open the case for wire connection—refer to Section 4.0). The only configuration necessary for operation is proper setting of the external DCE/DTE switch.

The diagram below shows the location of the DCE/DTE switch on the PC board, as well as the location of the terminal block and surge suppressors ("S" model only).

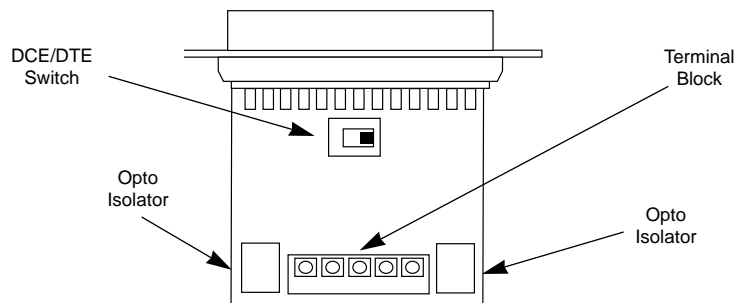

3.1 SETTING THE DCE/DTE SWITCH

For your convenience, the Model 2017P has an externally accessible DCE/DTE switch (see diagram below). If the RS-232 device connected to the Model 2017P is a modem or multiplexer (or is wired like one), set the switch to "DTE". This setting causes the Model 2017P to behave like Data Terminal Equipment and transmit data on pin 2.

If the RS-232 device connected to the Model 2017P is a PC, terminal or host computer (or is wired like one), set the switch to "DCE". This setting causes the Model 2017P to behave like Data Communications Equipment and transmit data on pin 3.



4.0 INSTALLATION

The Model 2017P is simple to install. After configuring the DTE/DCE switch, connect the two twisted pairs using one of three methods: terminal blocks with strain relief, RJ-11 jack or RJ-45 jack. The method you use will depend on the specific model you have.

4.1 TWISTED PAIR WIRING OVERVIEW

Only one Model 2017P is needed for each RS-232 to 20mA (or 60mA) current loop circuit. The Model 2017P is connected to the current loop device using two twisted pairs. The pairs must be "dry" (unconditioned) metallic wire, 19 - 26 AWG. Best distance is achieved with larger gauges. When you have completed wiring for your data circuit, the pin connections should be as shown below:

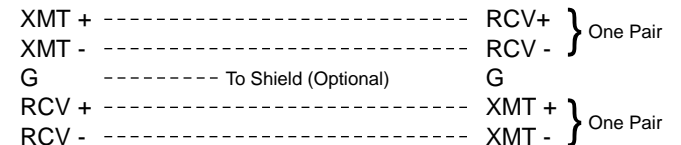

4.1.1 TWISTED PAIR CONNECTION USING TERMINAL BLOCKS

The terminal block/strain relief version of the Model 2017P allows you to hook up the line side interface using bare wires. The following instructions will tell you how to open the case, connect the bare wires and fasten the strain relief collar in place.

1. Open the unit by gently inserting a screw driver between the DB-25 connector and the lip of the plastic case (see below). You don't have to worry about breaking the plastic, but be careful not to bend the D-sub connector.

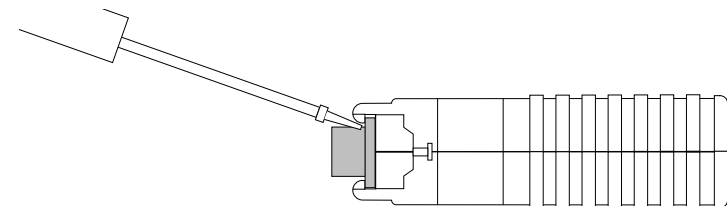

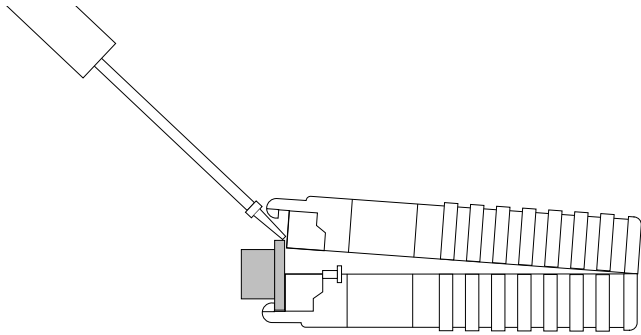

Once the unit has been opened, you will be able to see the terminal blocks located at the rear of the PC board.

2. Strip the outer insulation from the twisted pairs about one inch from the end.

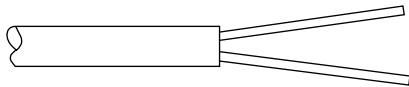

3. Strip back the insulation on each of the 2 twisted pair wires about .25".

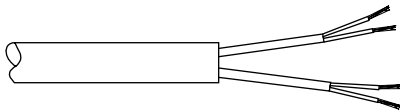

4. Connect one pair of wires in the telephone cable to "XMT" (Transmit) on the terminal block, being careful to observe the polarity. (The wire connected to "XMT+" must be connected at the other end of the telephone line to "RCV+" in the other unit and the wire connected to "XMT-" must be connected at the other end of the telephone line to "RCV-" in the other unit).

5. Connect the other pair of wires in the telephone cable to "RCV" (Receive), again being careful to observe the polarity. (The wire connected to "RCV+" must be connected at the other end of the telephone line to "XMT+" in the other unit and the wire connected to "RCV-" must be connected at the other end of the telephone line to "XMT-" in the other unit).

6. If there is a shield around the telephone cable, it may be connected to "G" on the terminal block. To avoid ground loops, we recommend connecting the shield at the computer end only. A ground wire is not necessary for proper operation of these units.

7. When you finish connecting the wires to the terminal block, the assembly should resemble the diagram below:

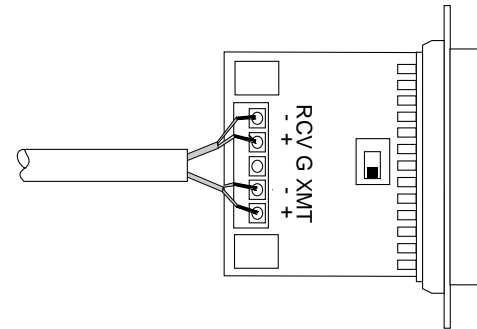

8. Place the 2 halves of the strain relief assembly on either side of the telephone wire and press together very lightly. Slide the assembly so that it is about 2 inches from the terminal posts and press together firmly. If your cable diameter is too small or too large for our strain relief, please contact our technical support. We have strain relief assemblies to accommodate most cable diameters.

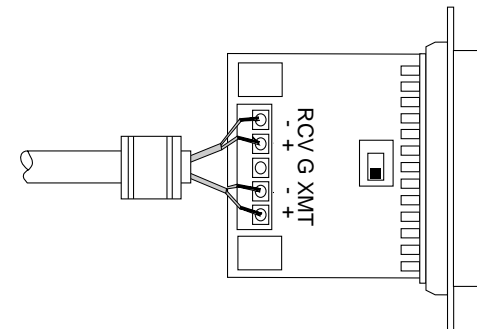

9. Insert the strain relief assembly with the wire going through it into the slot in the bottom half of the modem case and set it into the recess in the case.

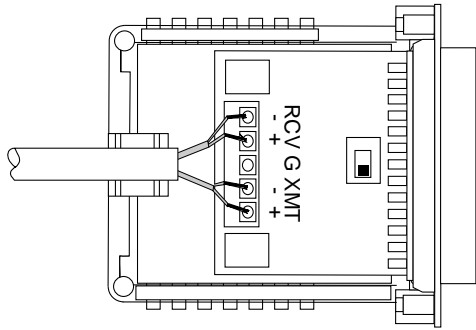

10. BEND the top half of the case as necessary to place it over the strain relief assembly. Do not snap the case together yet.

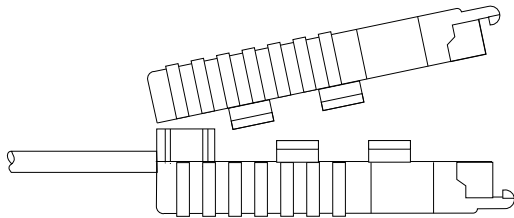

11. Insert one captive screw through a saddle washer and then insert the captive screw with the washer on it, through the hole in the DB-25 end of the case. Snap that side of the case closed. Repeat the process for the other side. This completes the cable installation process.

4.1.2 TWISTED PAIR CONNECTION USING MODULAR JACKS

The modular versions of the Model 2017P have an RJ-11 or RJ-45 jack mounted in the case. These jacks are prewired for a standard TELCO wiring environment. To be sure you have the right wiring, use the table below as a guide.

<u>RJ-11</u>	<u>SIGNAL</u>	<u>RJ-45</u>	<u>SIGNAL</u>
1-----	GND [†]	1-----	N/C
2-----	RCV-	2-----	GND
3-----	XMT+	3-----	RCV-
4-----	XMT-	4-----	XMT+
5-----	RCV+	5-----	XMT-
6-----	GND	6-----	RCV+
		7-----	GND
		8-----	N/C

[†]Connection to ground is optional

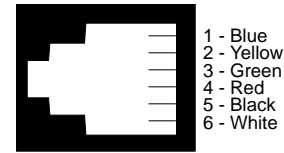

AT&T standard modular color codes

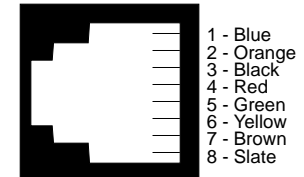

4.2 COMPLETING THE INSTALLATION

Once you have configured the unit for DTE or DCE and connected the twisted pair wires correctly, simply plug the Model 2017P into the RS-232 data port. Remember to insert and tighten the two captive connector screws.

The Model 2017P requires no power supply or batteries for operation. It will work automatically at any data rate from 50 to 19,200 bps, as long as there is any data or control voltage being applied.

**APPENDIX A
SPECIFICATIONS**

Transmission Line: 19 to 26 AWG twisted pair

Range: 4 miles on 24 AWG twisted pair

Interfaces: Asynchronous, EIA RS-232, CCITT V.24 full duplex, 20mA current loop (Model 2017P60 connects to 60mA current loop)

Data Rates: 0 - 115.2 Kbps

Isolation: 2500V RMS via opto-isolators

Surge Suppression: Over-voltage protection for opto-isolators via Silicon Avalanche Diodes

Connectors: DB-25 male or female on RS-232 side; RJ-11, RJ-45 or terminal block with strain relief on current loop side

Power Supply: No external power required; uses power from NIC data signals

Temperature Range: 0-50°C (32-122°F)

Altitude: 0-15,000 feet

Humidity: Up to 95% non-condensing

Dimensions: 2.50"L x 1.2"H x 0.75"W

Weight: 1.5 oz

**APPENDIX B
RS-232C PIN CONFIGURATIONS**

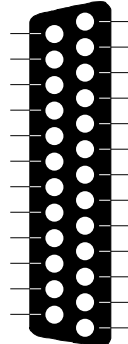
DIRECTION	STANDARD "DCE" SETTING	DIRECTION
To Mdl 2017P	 <ul style="list-style-type: none"> 1- (FG) Frame Ground 2- (TD) Transmit Data 3- (RD) Receive Data 4- (RTS) Request to Send 5- (CTS) Clear to Send 6- (DSR) Data Set Ready 7- (SG) Signal Ground 8- (DCD) Data Carrier Detect 	To Mdl 2017P From Mdl 2017P To Mdl 2017P From Mdl 2017P From Mdl 2017P

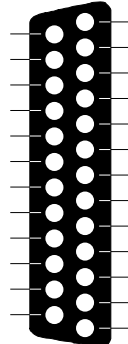
DIRECTION	STANDARD "DTE" SETTING	DIRECTION
From Mdl 2017P	 <ul style="list-style-type: none"> 1- (FG) Frame Ground 2- (TD) Transmit Data 3- (RD) Receive Data 4- (RTS) Request to Send 5- (CTS) Clear to Send 6- (DSR) Data Set Ready 7- (SG) Signal Ground 8- (DCD) Data Carrier Detect 	From Mdl 2017P To Mdl 2017P From Mdl 2017P To Mdl 2017P To Mdl 2017P To Mdl 2017P

APPENDIX C BLOCK DIAGRAM

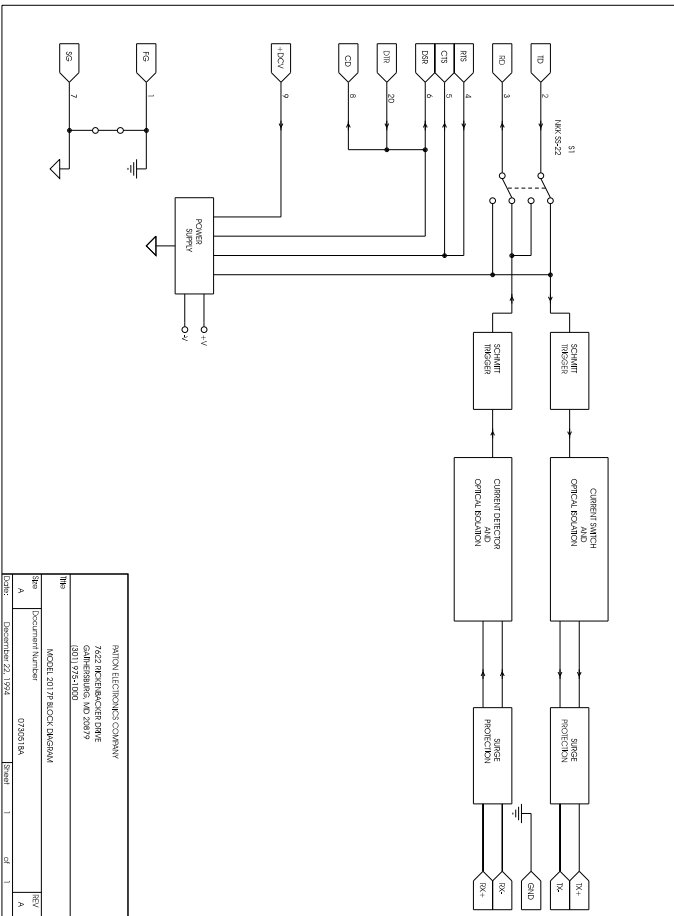

Free Manuals Download Website

<http://myh66.com>

<http://usermanuals.us>

<http://www.somanuals.com>

<http://www.4manuals.cc>

<http://www.manual-lib.com>

<http://www.404manual.com>

<http://www.luxmanual.com>

<http://aubethermostatmanual.com>

Golf course search by state

<http://golfingnear.com>

Email search by domain

<http://emailbydomain.com>

Auto manuals search

<http://auto.somanuals.com>

TV manuals search

<http://tv.somanuals.com>