

# USER MANUAL

---

## MODEL 1060RC AC Powered, Asynchronous Short Range Modem: Rack Mount Card



**PA PATTON**  
**IE Electronics Co.**



An ISO-9001  
Certified Company

Part #07M1060RC-B  
Doc #058021U, Rev C  
Revised 1/23/08

SALES OFFICE  
(301) 975-1000  
TECHNICAL SUPPORT  
(301) 975-1007  
<http://www.patton.com>

## 1.0 WARRANTY INFORMATION

**Patton Electronics** warrants all Model 1060RC components to be free from defects, and will—at our option—repair or replace the product should it fail within one year from the first date of shipment.

This warranty is limited to defects in workmanship or materials, and does not cover customer damage, abuse or unauthorized modification. If this product fails or does not perform as warranted, your sole recourse shall be repair or replacement as described above. Under no condition shall **Patton Electronics** be liable for any damages incurred by the use of this product. These damages include, but are not limited to, the following: lost profits, lost savings and incidental or consequential damages arising from the use of or inability to use this product. **Patton Electronics** specifically disclaims all other warranties, expressed or implied, and the installation or use of this product shall be deemed an acceptance of these terms by the user.

### 1.1 RADIO AND TV INTERFERENCE

The Model 1060RC generates and uses radio frequency energy, and if not installed and used properly—that is, in strict accordance with the manufacturer's instructions—may cause interference to radio and television reception. The Model 1060RC has been tested and found to comply with the limits for a Class A computing device in accordance with the specifications in Subpart J of Part 15 of FCC rules, which are designed to provide reasonable protection from such interference in a commercial installation. However, there is no guarantee that interference will not occur in a particular installation. If the Model 1060RC does cause interference to radio or television reception, which can be determined by turning the power off or removing the card, the user is encouraged to try to correct the interference by one or more of the following measures: moving the computing equipment away from the receiver, re-orienting the receiving antenna and/or plugging the receiving equipment into a different AC outlet (such that the computing equipment and receiver are on different branches). In the event the user detects intermittent or continuous product malfunction due to nearby high power transmitting radio frequency equipment, the user is strongly advised to take the following steps: use only data cables with an external outer shield bonded to a metal or metalized connector; and, configure the rear card as shown in section 3.4 of this manual.

### 1.2 CE NOTICE

The CE symbol on your Patton Electronics equipment indicates that it is in compliance with the Electromagnetic Compatibility (EMC) directive and the Low Voltage Directive (LVD) of the Union European (EU). A Certificate of Compliance is available by contacting Technical Support.

### 1.3 SERVICE

All warranty and nonwarranty repairs must be returned freight prepaid and insured to Patton Electronics. All returns must have a Return Materials Authorization number on the outside of the shipping container. This number may be obtained from Patton Electronics Technical Support: **(301) 975-1007**; **<http://www.patton.com>**; or, **support@patton.com**.

**NOTE:** Packages received without an RMA number will not be accepted.

Patton Electronics' technical staff is also available to answer any questions that might arise concerning the installation or use of your Model 1060RC. Technical Service hours: **8AM to 5PM EST, Monday through Friday**.

## 2.0 GENERAL INFORMATION

Thank you for your purchase of this Patton Electronics product. This product has been thoroughly inspected and tested and is warranted for One Year parts and labor. If any questions or problems arise during installation or use of this product, please do not hesitate to contact Patton Electronics Technical Support at (301) 975-1007.

### 2.1 FEATURES

- Data rates to 57.6 kbps
- Receiver optical isolation
- High speed surge protection
- Supports distances up to 14 miles (22.5 km)
- Mounts in Patton's 16-card rack chassis
- Bi-state LED indicators
- Point-to-point or multipoint operation
- Local and remote loopback test modes
- Hardware and software flow control support
- Pin assignable control signals

### 2.2 DESCRIPTION

**The Model 1060RC Asynchronous Short Range Modem Rack Card** operates full duplex over two unconditioned twisted pair. Supporting data rates to 57.6 kbps, the Model 1060RC has a maximum range of 14 miles (22.5 km) (at 1200 bps over 19 AWG wire). The Model 1060RC passes one control signal in each direction, and features both optical isolation and Silicon Avalanche Diode surge protection on the data line side.

The Model 1060RC is designed to mount in Patton's 2U high 19" rack chassis. This 16 card chassis has a switchable 120/240 volt power supply and mounts cards in a mid-plane architecture: The front "brains" card can be plugged into different rear "interface" cards. This means that the 1060RC can have several interface options, and can be switched with other Patton short haul cards.

The Model 1060RC has two built-in diagnostic tools: local and remote loopback test. Additionally, bi-level LEDs on the 1060RC's front panel allow you to visually monitor communication.

### 3.0 CONFIGURATION

This section describes the location and orientation of the Model 1060RC's configuration switches and provides detailed instructions on setting each of the switches.

#### 3.1 FRONT CARD CONFIGURATION

The Model 1060RC uses a set of eight DIP switches that allow configuration to a wide range of asynchronous applications. These DIP switches are accessible when the card is slid out of the rack chassis (see Figure 1, below). Once configured, the Model 1060RC is designed to operate transparently, without need for frequent re-configuration.

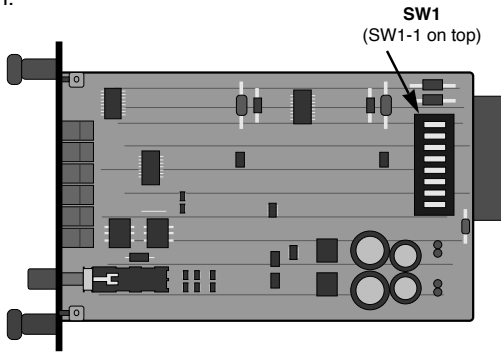

Figure 1. Model 1060RC board, showing location of DIP switches

The eight DIP switches on the Model 1060RC board allow you to specify control signal pin assignments and carrier control method. Figure 2 (below) shows the orientation of the DIP switches with respect to "ON" and "OFF" positions.

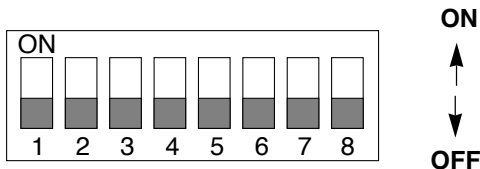

Figure 2. Close up of DIP switches showing ON/OFF positions.

### 3.2 "QUICK SET-UP" INSTRUCTIONS

In the majority of applications, you will not need an in-depth knowledge of the Model 1060RC's capabilities to get up and running. The following "quick set-up" DIP switch configurations cover most Model 1060RC operating environments.

#### 3.2.1 Point-to-Point Applications

If you are installing these units in a point-to-point application with a computer, printer or terminal, configure the DIP switches on both Model 1060s as follows:

<u>Switch Number:</u>	<u>1</u>	<u>2</u>	<u>3</u>	<u>4</u>	<u>5</u>	<u>6</u>	<u>7</u>
Positions	ON	ON	ON	OFF	OFF	OFF	OFF

#### 3.2.2 Multi-Point Applications

If you are installing these units in a multipoint application, configure the DIP switches for master and slave units as follows:

<u>Switch Number:</u>	<u>1</u>	<u>2</u>	<u>3</u>	<u>4</u>	<u>5</u>	<u>6</u>	<u>7</u>
Master positions	ON	ON	ON	OFF	OFF	OFF	OFF
Slave positions	ON	ON	ON	OFF	OFF	OFF	ON

### 3.3 SPECIAL CONFIGURATION

If your installation requires special configuration of the Model 1060RC, use the table below as a guide. This table shows all possible Model 1060RC switch settings. Following the table are brief descriptions of the Control Input, Control Output, +Voltage Output and Carrier Controlled by ( $C_{in}$ ) parameters shown in the table below.

Mode (DCE/DTE)	Control Input ( $C_{in}$ )	Control Output ( $C_{out}$ )	+Voltage Output ( $V_{out}$ )	Carrier Controlled by ( $C_{in}$ )	Switch Settings						
					1	2	3	4	5	6	7
DCE	4	8	6	Disabled	ON	ON	ON	OFF	OFF	OFF	OFF
DCE	4	8	6	Enabled	ON	ON	ON	OFF	OFF	OFF	ON
DCE	4,11,20*	8	6	Disabled	OFF	ON	ON	ON	OFF	OFF	OFF
DCE	4,11,20*	8	6	Enabled	OFF	ON	ON	ON	OFF	OFF	ON
DCE	4	6	8	Disabled	ON	OFF	OFF	OFF	ON	ON	OFF
DCE	4	6	8	Enabled	ON	OFF	OFF	OFF	ON	ON	ON
DCE	4,11,20*	6	8	Disabled	OFF	OFF	OFF	ON	ON	ON	OFF
DCE	4,11,20*	6	8	Enabled	OFF	OFF	OFF	ON	ON	ON	ON

\*Multiple input pins are "or-tied"—if any input goes low, carrier is dropped

**Control Input (C<sub>in</sub>):**

The Control Input signal is used by the local Model 1060RC as an input signal to “turn on” (in the “Enabled” settings) and allow data transmission to the remote device. This is required for half-duplex/switched-carrier environments as well as in hardware flow control applications. In the “Disabled” settings, the 1060RC is always “turned on” and sends a continuous carrier to the remote 1060RC.

**Control Output (C<sub>out</sub>):**

The Control Output signal is transmitted by the local Model 1060RC to its attached DTE device. This signal should be the same logic state as the Control Input signal on the remote 1060RC. This signal is required in half-duplex/switched carrier environments or in hardware flow control applications.

**+Voltage Output (+V<sub>out</sub>):**

The +Voltage Output signal is a constant positive voltage that is sent from the 1060RC to its attached DTE device.

**Carrier Controlled by (C<sub>in</sub>):**

When Carrier Controlled by Control Input is “Enabled”, the Model 1060RC is “turned on” by the corresponding C<sub>in</sub> Signal from the DTE. In effect, the Control Input signal on the local 1060RC "controls" the presence of "carrier" and the Control Output signal on the remote 1060RC. This setting is required in half-duplex/switched carrier environments or in hardware flow control applications. When Carrier Control by Control Input is “Disabled”, the 1060RC sends a continuous carrier and is always “turned on”.

### 3.4 REAR CARD CONFIGURATION

The 1060RC has four interface card options: DB-25/RJ-11, DB-25/RJ-45, RJ-45/RJ-11 and dual RJ-45. Each of these options supports one RS-232 connection and one 4-wire connection (the RS-232 port is always the *lower* port on the interface card). Figure 4 (below) illustrates the four different interface options for the Model 1060RC:

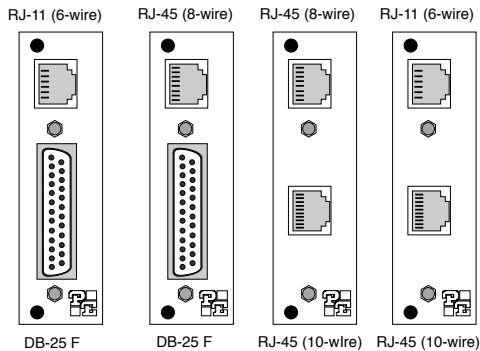

**Figure 4.** Model 1060RC interface card options

Prior to installation, you will need to examine the rear card that you have selected and ensure that it is configured properly for your application. Each rear card is configured by setting straps located on the PC board. Sections 3.4.1 and 3.4.2 describe the strap locations and possible settings for each rear card.



### 3.4.1 DB-25/RJ-11 & DB-25/RJ-45 Strap Settings

Figure 5 (below) shows strap locations for the Model 1000RCM12511 (DB-25/RJ-11) and the Model 1000RCM12545 (DB-25/RJ-45) rear cards. These straps determine various grounding characteristics for the RS-232 and twisted pair lines.

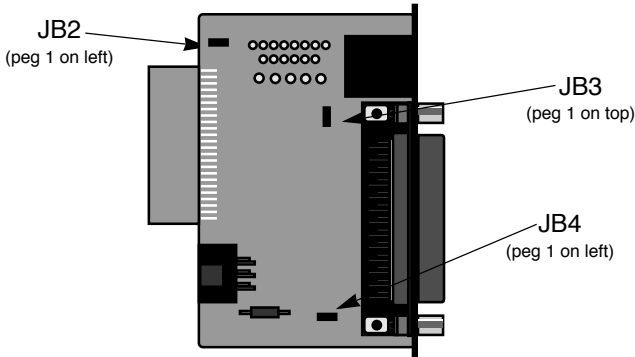

Figure 5. DB-25/RJ-11 & DB-25/RJ-45 strap locations

Figure 6 (below) shows the orientation of the rear interface card straps. Observe that the strap can either be on pegs 1 and 2, or on pegs 2 and 3.

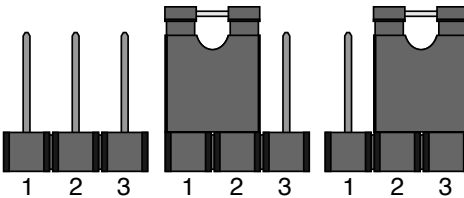

Figure 6. Orientation of interface card straps

The table below provides an overview of strap functions for the DB-25/modular cards. Following this overview is a detailed description of each strap's function.

<b>INTERFACE CARD STRAP SUMMARY TABLE #1</b>			
<b>Strap</b>	<b>Function</b>	<b>Position 1&amp;2</b>	<b>Position 2&amp;3</b>
JB2	Line Shield & FRGND	Connected	Open*
JB3	DTE Shield (Pin1) & FRGND	Connected	Open*
JB4	FRGND & SGND	Connected	Open*

\* indicates factory default

### **Line Shield & FRGND (JB2)**

This strap pertains to the line interface. In the connected (closed) position, this strap links RJ-11 pins 1 and 6, or RJ-45 pins 2 and 7 to frame ground. These pins can be used as connections for the twisted pair cable shield. In the open (disconnected) position, pins 1 and 6 (or 2 and 7) remain connected to each other, but are "lifted" from the frame ground.

#### JB2

Position 1&2 = Line Shield and FRGND Connected

Position 2&3 = Line Shield and FRGND Not Connected

### **DTE Shield (Pin 1) & FRGND (JB3)**

In the connected (closed) position, this strap links DB-25 pin 1 and frame ground. In the open (disconnected) position, pin 1 is "lifted" from frame ground.

#### JB3

Position 1&2 = DTE Shield (Pin 1) and FRGND Connected

Position 2&3 = DTE Shield (Pin 1) and FRGND Not Connected

### **SGND & FRGND (JB4)**

In the connected (closed) position, this strap links DB-25 pin 7 (Signal Ground) and frame ground. In the open (disconnected) position, pin 1 is "lifted" from frame ground.

#### JB4

Position 1&2 = SGND (pin 7) and FRGND Connected

Position 2&3 = SGND (Pin 7) and FRGND Not Connected

### 3.4.2 RJ-45/RJ-11 & RJ-45/RJ-45 Strap Settings

Figure 8 (opposite page) shows strap locations for the Model 1000RCM1D11 (RJ-45/RJ-11) and the Model 1000RCM1D45 (RJ-45/RJ-45) rear cards. These straps determine various grounding characteristics for the RS-232 and twisted pair lines.

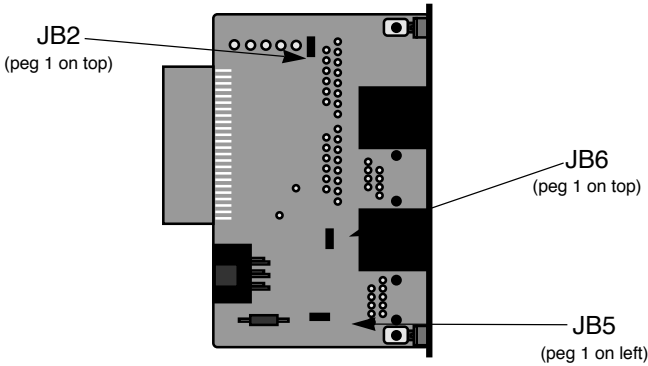

**Figure 8.** RJ-45/RJ-11 & RJ-45/RJ-45 strap locations

The table below provides an overview of strap functions for the modular/modular cards. Following the table is a detailed description of each strap's function.

<b>INTERFACE CARD STRAP SUMMARY TABLE #2</b>			
<b>Strap</b>	<b>Function</b>	<b>Position 1&amp;2</b>	<b>Position 2&amp;3</b>
JB2	Line Shield & FRGND	Connected	Open*
JB5	SGND & FRGND	Connected	Open*
JB6	DTE Pin 2	DSR*	RI

\* indicates factory default

#### **Line Shield & FRGND (JB2)**

This strap pertains to the line interface. In the connected (closed) position, this strap links RJ-11 pins 1 and 6, or RJ-45 pins 2 and 7 to frame ground. These pins can be used as connections for the twisted pair cable shield. In the open (disconnected) position, pins 1 and 6 (or 2 and 7) remain connected to each other, but are "lifted" from frame ground.

#### JB2

Position 1&2 = Line Shield and FRGND Connected

Position 2&3 = Line Shield and FRGND Not Connected

### **SGND & FRGND (JB5)**

This strap pertains to the DTE interface, which is a 10-position modular RJ-45 jack. In the connected (closed) position, this strap links modular pin 5 (Signal Ground) and frame ground. In the open (disconnected) position, pin 5 is "lifted" from frame ground.

#### JB5

Position 1&2 = SGND (pin 5) and FRGND Connected

Position 2&3 = SGND (Pin 5) and FRGND Not Connected

### **DTE Interface Pin 2 (JB6)**

This strap configures DTE interface pin 2 for Ready Start (DSR) operation when placed on pegs 1 & 2. Placing the strap on pegs 2 & 3 is *not a valid option* when using this rear interface card in conjunction with the Model 1060RC.

#### JB6

Position 1&2 = Ready Start (DSR) Operation

Position 2&3 = Not a valid option

## 4.0 INSTALLATION

This section describes the functions of the Model 1000R16 rack chassis, tells how to install front and rear Model 1060RC cards into the chassis, and provides diagrams for wiring up the interface connections correctly.

### 4.1 THE MODEL 1000R16 RACK CHASSIS

The 1000R16 Rack Chassis (shown in figure 10, below) has sixteen short range modem card slots, plus its own power supply. Measuring only 3.5" high, each Model 1060RC is designed to occupy only 2U in the 19" Model 1000R16. Sturdy front handles allow the 1000R16 to be extracted and transported conveniently.

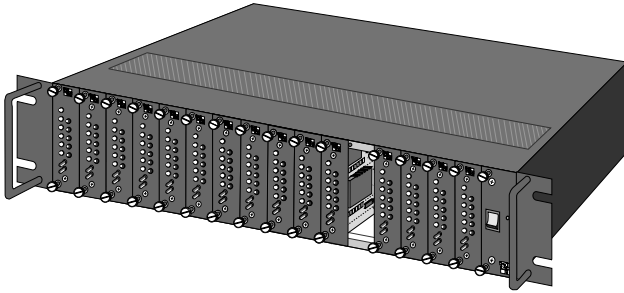

Figure 10: Model 1000R16 Rack Chassis with power supply

#### 4.1.1 The Rack Power Supply

The power supply included in the Model 1000R16 rack uses the same mid-plane architecture as the modem cards. The front card of the power supply slides in from the front, and the rear card slides in from the rear. They plug into one another in the middle of the rack. The front card is then secured by thumb screws and the rear card by conventional metal screws.

**WARNING!** There are no user-serviceable parts in the power supply section of the Model 1060RC Series. Voltage setting changes and fuse replacement should only be performed by qualified service personnel. Contact Patton Electronics Technical support at (301)975-1007 for more information.

## Switching the Power Supply On and Off

The power supply on/off switch is located on the front panel. When plugged in and switched on, a red front panel LED will glow. Since the Model 1000R16 is a "hot swappable" rack, *it is not necessary for any cards to be installed before switching on the power supply*. The power supply may be switched off at any time without harming the installed cards.

**NOTE:** Please refer to the Model 1000RP Series User Manual *AC and DC Rack Mount Power Supplies* for fuse and power card replacement information.

## 4.2 INSTALLING THE MODEL 1060RC INTO THE CHASSIS

The Model 1060RC is comprised of a front "brains" card and a rear "connections" card. The two cards meet inside the rack chassis and plug into each other by way of mating 50 pin card edge connectors. Use the following steps as a guideline for installing each Model 1060RC into the Model 1000R16 rack chassis:

1. Slide the rear "connections" card into the back of the chassis along the metal rails provided.
2. Secure the rear card using the metal screws provided.
3. Slide the "brains" card into the front of the chassis. It should meet the rear card when it's almost all the way into the chassis.
4. Push the front card *gently* into the card-edge receptacle of the rear card. It should "click" into place.
5. Secure the front card using the thumb screws.

**NOTE:** Since the Model 1000R16 chassis allows "hot swapping" of cards, it is *not necessary to power down* the rack when you install or remove a Model 1060RC.

## 4.3 RS-232 CONNECTION

The Model 1060RC offers two port options for connecting the RS-232 interface to your computing hardware: DB-25 female and 10-pin RJ-45 female (the RS-232 port is always the *lower* port on the interface card). The DB-25 is pinned according to the RS-232C/V.24 interface standard. The 10-pin RJ-45 is pinned according to the EIA/TIA-561 interface standard. For specific interface pin-outs, please refer to the diagrams in Appendix D of this manual.

The Model 1060RC is wired to connect to a DTE. If your RS-232 output device is a DTE, use a *straight through cable* to connect to the Model 1060RC. If your RS-232 output device is DCE, call Patton Technical Support at (301) 975-1007 for specific installation instructions.

**Notice!** Any terminal cable connected to the Model 1060RC must be shielded cable, and the outer shield must be 360 degree bonded—at both ends—to a metal or metalized backshell.

#### 4.4 TWISTED PAIR CONNECTION

The Model 1060RC operates over two twisted pair. In *all* applications, the twisted pair wire must be 26 AWG or thicker, unconditioned, dry, metallic wire. Both shielded and unshielded wire yield favorable results. **Note:** The Model 1060RC can only communicate in a closed data circuit with another Model 1060RC. Dial-up analog circuits, such as those used with a standard Hayes-type modem, are *not acceptable*. For further information about acceptable wire grades, please refer to the diagrams in Appendix B.

##### 4.4.1 Point-to-Point Twisted Pair Connection

The 6-position RJ-11 and 8-position RJ-45 jack options for the Model 1060RC (always the *upper* jack on the rear interface card) are prewired for a standard TELCO wiring environment. Connection of a 4-wire twisted pair circuit between two or more Model 1060RCs requires a *crossover cable* as shown in the figures below and on the following page.

##### RJ-11

<u>SIGNAL</u>	<u>PIN#</u>	<u>COLOR</u>	<u>COLOR</u>	<u>PIN#</u>	<u>SIGNAL</u>
GND	1	Blue .....	White	6	GND
RCV-	2	Yellow .....	Red	4	XMT-
XMT+	3	Green .....	Black	5	RCV+
XMT-	4	Red .....	Yellow	2	RCV-
RCV+	5	Black .....	Green	3	XMT+
GND	6	White .....	Blue	1	GND

### RJ-45

<u>SIGNAL</u>	<u>PIN#</u>	<u>COLOR</u>	<u>COLOR</u>	<u>PIN#</u>	<u>SIGNAL</u>
GND	2	Orange.....	Brown	7	GND
RCV-	3	Black.....	Green	5	XMT-
XMT+	4	Red .....	Yellow	6	RCV+
XMT-	5	Green.....	Black	3	RCV-
RCV+	6	Yellow .....	Red	4	XMT+
GND	7	Brown .....	Orange	2	GND

#### 4.4.2 Multipoint Twisted Pair Connection

Figure 11 (below) shows how to wire two-pair cables properly for a Model 1060RC star topology.

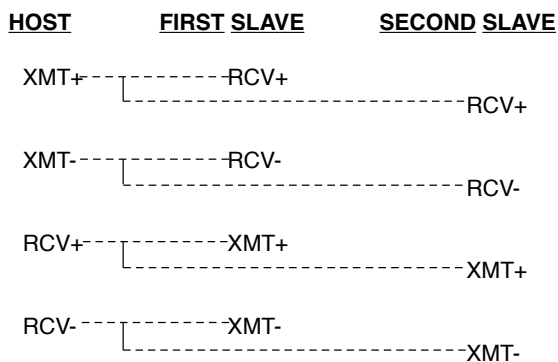

**Figure 11.** Two-pair star wiring for Model 1060RC host and slaves

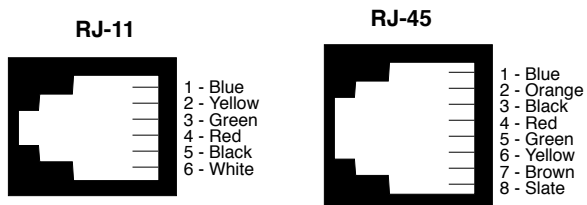

**Notice!** Any modular twisted pair cable connected to the Model 1060RC must be shielded cable, and the outer shield must be properly terminated to a shielded modular plug on both ends of the cable.



## 5.0 OPERATION

Once you have configured each Model 1060RC and connected the cables, you are ready to operate the units. Section 5.0 describes the LED status monitors, the power-up procedure and the use of the built-in loopback test modes.

### 5.1 LED STATUS MONITORS

The Model 1060RC features ten front panel status LEDs that indicate the condition of the modem and communication link. Figure 12 (below) shows the relative front panel positions of the LEDs. Following figure 12 is a description of each LED's function.

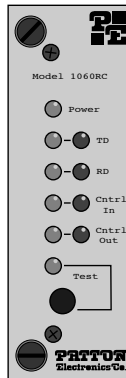

Figure 12. The Model 1060RC front panel, showing LED positions

- |   |   |
|---|---|
| <b>Power</b>                                      | glows green when power is applied to the Model 1060RC front card.   |
| <b>TD &amp; RD</b>                                | The green "TD" and "RD" indicators blink to show positive state data activity. The red "TD" and "RD" indicators blink to show negative state data activity. Solid red indicates a connection in an idle state.  |
| <b>Cntrl<sub>in</sub> and Cntrl<sub>out</sub></b> | glow red to show that either control signal is off. Glow green to show that either control signal is on. When the 1060RC is connected to a DTE, Control In will glow green for a positive polarity on the Control Input signal. Control Out will glow green for an incoming signal from the line. |
| <b>Test</b>                                       | glows green when the loopback test modes are activated.   |

## 5.2 POWER-UP

There is no power switch on the Model 1060RC: Power is automatically applied to the 1060RC when its card-edge connector makes contact with the chassis' mid-plane socket, or when the chassis' power supply is turned on. *Note: The 1060RC is a "hot swappable" card—it will not be damaged by plugging it in or removing it while the rack is powered up.*

When the local and remote Model 1060RCs are *both* powered up, and are passing data *normally*, the following LED conditions will exist:

- PWR = green
- TD & RD = flashing red and green
- Control In & Control Out = green
- TEST = off

### 5.3 TEST MODES

The Model 1060RC offers two diagnostic modes: local analog loop and remote analog loop. These test modes are activated *simultaneously* by depressing the "Test" button on the front panel of the Model 1060RC.

#### Local Analog Loop

The Local Analog Loop test mode causes any data sent to the local 1060RC by the local RS-232 device to be echoed *back* to that RS-232 device. For example, characters typed on the keyboard of a terminal will appear on the terminal screen (see Figure 13 on the following page). If characters are not echoed back, check the connection between the local RS-232 device and the local 1060RC. All 1060RCs in the system should be tested in this manner.

#### Remote Analog Loop

The Remote Analog Loop test mode causes any characters sent from the *remote* 1060RC to the local 1060RC to be returned back to the *remote* device (see figure 13 on the following page). **Note: Only the local 1060RC should be in "test" mode.** The remote 1060RC should be in "normal" operating mode or this test will not work. If no characters are echoed back, check the wiring between the two 1060RCs. Be sure to wire the units according to the instructions in section 4.0.

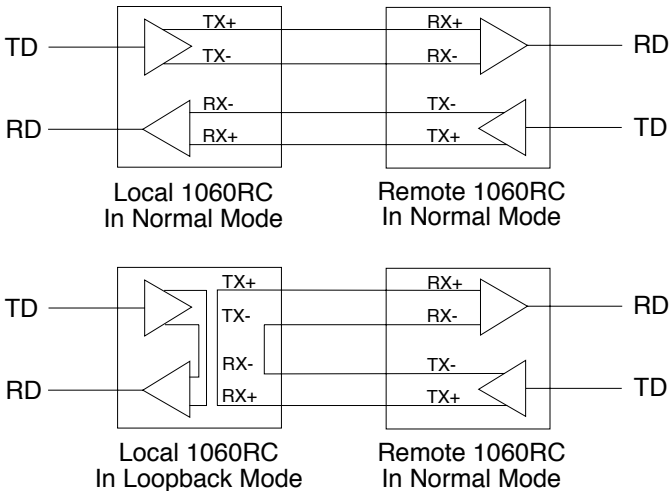

Figure 13. Normal operating mode vs. loopback test mode

## **APPENDIX A SPECIFICATIONS**

**Transmission Format:** Asynchronous

**External Interface:** RS-232C/CCITT V.24 connection via DB-25 female; EIA/TIA-561 connection via RJ-45 (10 wire); twisted pair connection via RJ-11 or RJ-45 (8 wire)

**Internal Interface:** Connection to Model 1000R16 rack chassis via 50 pin male card edge

**Transmission Line:** 4-wire, unconditioned twisted pair, 19-26 AWG, 20pf/ft or better

**Data Rates:** 0 - 57.6 Kbps

**Controls:** Carrier constantly "ON" or "controlled by RTS"

**Applications:** Point-to-point or multi-point

**Indicators:** Bi-level LED indicators (two each) for Transmit Data, Receive Data, Control In and Control Out; bi-level indicators (one each) for Power and Test

**Diagnostics:** Local and remote analog loopback, activated by front panel push button

**Receiver Optical Isolation:** 150V AC

**Surge Protection:** Silicon Avalanche Diodes, 600 watts RMS power dissipation @ 1 ms, with response time of less than 1 pS

**Power Supply:** Rack-mount power supply is switchable between 120V and 240V AC; rack chassis supplies 10V AC to the Model 1060RC, typical Model 1060RC consumption is 700 mW

**Fuse:** 400 mA for 120V applications; 200 mA for 240V applications

**Temperature:** 0-50°C / 32-122°F

**Humidity:** 0-95%, non-condensing

**Dimensions:** 0.95"h x 3.1"w x 5.4"l

## APPENDIX B CABLE RECOMMENDATIONS

The Patton Model 1060RC operates at frequencies of 100kHz or less and has been performance tested by Patton technicians using twisted-pair cable with the following characteristics:

<u>Wire Gauge</u>	<u>Capacitance</u>	<u>Resistance</u>
19 AWG	83nf/mi or 15.72 pf/ft.	.0163W/ft.
22 AWG	83nf/mi or 15.72 pf/ft.	.0326W/ft.
24 AWG	83nf/mi or 15.72 pf/ft.	.05165W/ft.

Using or simulating cable with the above characteristics, the following data rate/distance results were obtained by Patton during bench tests:

<u>Data Rate (Bps)</u>	<u>Gauge (AWG) / Distance (Mi)</u>		
	<u>19</u>	<u>22</u>	<u>24</u>
57,600	2.5	1.8	1.3
38,400	3.7	2.3	1.7
19,200	5.1	3.4	2.4
9,600	6.7	4.6	3.7
4,800	9.4	6.6	5.3
2,400	11.5	9.3	7.6
1,200	14.0	12.0	9.6

To gain optimum performance from the 1060RC, please keep the following guidelines in mind:

- *Always* use **twisted pair** wire—this is not an option.
- Use twisted pair wire with a capacitance of 20pf/ft or less.
- Avoid twisted pair wire thinner than 26 AWG (i.e. avoid higher AWG numbers than 26).
- Use of twisted pair with a resistance greater than the above specifications may cause a reduction in maximum distance obtainable. Functionality should not be affected.
- Environmental factors too numerous to mention can affect the maximum distances obtainable at a particular site. Use the above data rate/distance table as a *general guideline only*.

## **APPENDIX C**

### **FACTORY REPLACEMENT PARTS**

The Patton Model 1060RC rack system features interchangeable rear half cards, power cords/fuses for international various operating environments and other user-replaceable parts. Model numbers and descriptions for these parts are listed below:

<b><u>Patton Model #</u></b>	<b><u>Description</u></b>
1000RPEM.....	120/240V Rear Power Entry Module
1000RPSM-2.....	120/240V Front Power Supply Module
1000RPEM-DC .....	DC Rear Power Entry Module
1000RPSM-48A .....	48V Front Power Supply Module
1000RPEM-V .....	120/240V CE Compliant Rear Power Entry Module
1000RPSM-V .....	120/240V CE Compliant Front Power Supply Module
0805US .....	American Power Cord
0805EUR.....	European Power Cord CEE 7
0805UK .....	United Kingdom Power Cord
0805AUS.....	Australia/New Zealand Power Cord
0805DEN.....	Denmark Power Cord
0805FR .....	France/Belgium Power Cord
0805IN.....	India Power Cord
0805IS.....	Israel Power Cord
0805JAP.....	Japan Power Cord
0805SW .....	Switzerland Power Cord
05R16FPB1.....	Single Width Blank Front Panel
05R16FPB4.....	4-Wide Blank Front Panel
05R16RPB1 .....	Single Width Blank Rear Panel
05R16RPB4 .....	4-Wide Blank Rear Panel
0821R4.....	400 mA Fuse (5x20mm) Littlefuse 239.400 or equivalent
0821R2.....	200 mA Fuse (5x20mm) Littlefuse 239.200 or equivalent
056S1 .....	Set of 16 #4 pan head screws/washers

## APPENDIX D INTERFACE STANDARDS

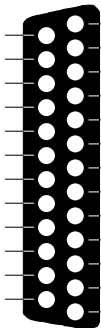
DIRECTION	STANDARD RS-232C/V.24 "DCE" SETTING	DIRECTION
To 1060RC	Data Term. Ready (DTR) - 20	 <ul style="list-style-type: none"> <li>1- (FG) Frame Ground</li> <li>2- (TD) Transmit Data</li> <li>3- (RD) Receive Data</li> <li>4- (RTS) Request to Send</li> <li>5- (CTS) Clear to Send</li> <li>6- (DSR) Data Set Ready</li> <li>7- (SG) Signal Ground</li> <li>8- (DCD) Data Carrier Detect</li> </ul>
		To 1060RC From 1060RC To 1060RC From 1060RC From 1060RC From 1060RC

### EIA/TIA-561 REFERENCE - 8 Wire RJ-45

Contact Number	Circuit	Description
1	125	Ring Indicator or DSR
2	109	Received Line Signal Indicator
3	108 / 2	DTE Ready
4	102	Signal Common
5	104	Received Data
6	103	Transmitted Data
7	106	Clear to Send
8	105 / 133	Request to Send / Ready for Receiving

### PATTON MODIFIED MODULAR INTERFACE - 10 Wire RJ-45

Contact Number	Circuit	Description
1	N/A	Receive Clock (Not Used for 1060RC)
2	125	Ring Indicator or DSR
3	109	Received Line Signal Indicator
4	108 / 2	DTE Ready
5	102	Signal Common
6	104	Received Data
7	103	Transmitted Data
8	106	Clear to Send
9	105 / 133	Request to Send / Ready for Receiving
10	N/A	Transmit Clock (Not Used for 1060RC)

# APPENDIX E BLOCK DIAGRAM

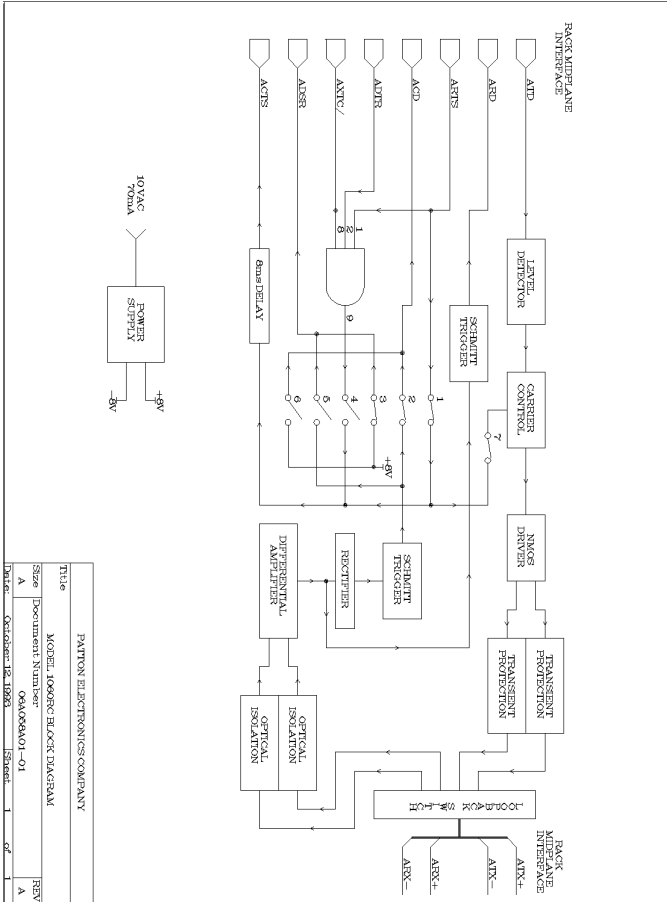

PANTON ELECTRONICS COMPANY	
Title	MOSEL JOSEPH BLOCK DIAGRAM
Size	Document Number OSA008A01-01
REV	A
Date	October 12, 1978
Sheet	1 of 1









Dear Valued Customer,

Thank you for purchasing Patton Electronics products! We do appreciate your business. I trust that you find this user manual helpful.

We manufacture one of the widest selections of data communications products in the world including CSU/DSU's, network termination units, powered and self-powered short range modems, fiber optic modems, interface converters, baluns, electronic data switches, data-line surge protectors, multiplexers, transceivers, hubs, print servers and much more. We produce these products at our Gaithersburg, MD, USA, facility, and can custom manufacture products for your unique needs.

We would like to hear from you. Please contact us in any of the following ways to tell us how you like this product and how we can meet your product needs today and in the future.

Web:	<a href="http://www.patton.com">http://www.patton.com</a>
Sales E-mail:	<a href="mailto:sales@patton.com">sales@patton.com</a>
Support E-mail:	<a href="mailto:support@patton.com">support@patton.com</a>
Phone - Sales	(301) 975-1000
Phone - Support	(301) 975-1007
Fax:	(301) 869-9293
Mail:	Patton Electronics Company 7622 Rickenbacker Drive Gaithersburg, MD 20879 USA

We are committed to a quality product at a quality price. Patton Electronics is ISO 9001 certified. We meet and exceed the highest standards in the industry (CE, UL, etc.).

It is our business to serve you. If you are not satisfied with any aspect of this product or the service provided from Patton Electronics or its distributors, please let us know.

Thank you.

Burton A.Patton  
Vice President

P.S. Please tell us where you purchased this product.

---

---

---

---

---

---

---

## Free Manuals Download Website

<http://myh66.com>

<http://usermanuals.us>

<http://www.somanuals.com>

<http://www.4manuals.cc>

<http://www.manual-lib.com>

<http://www.404manual.com>

<http://www.luxmanual.com>

<http://aubethermostatmanual.com>

Golf course search by state

<http://golfingnear.com>

Email search by domain

<http://emailbydomain.com>

Auto manuals search

<http://auto.somanuals.com>

TV manuals search

<http://tv.somanuals.com>