

# Model 6081RC EdgeRoute Network Access Server

## User Manual

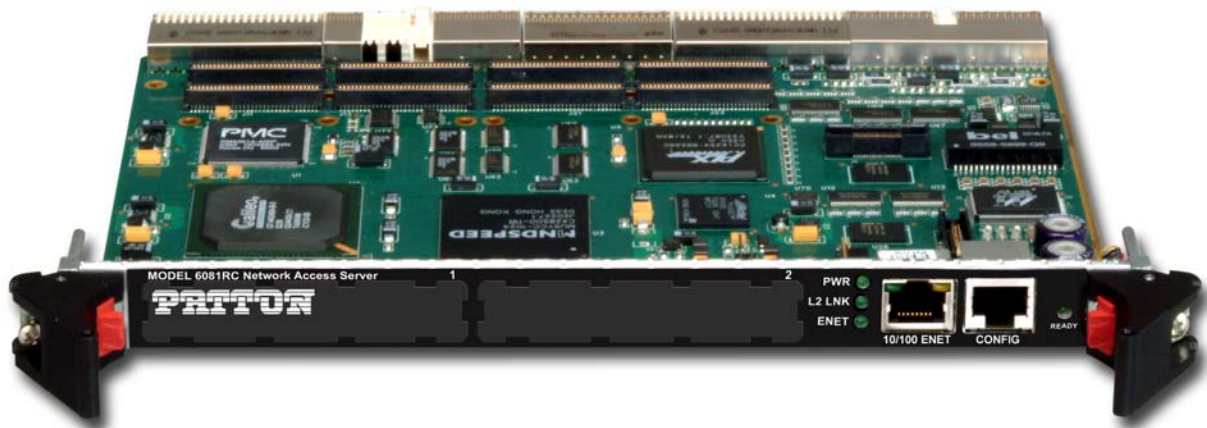

Sales Office: +1 (301) 975-1000  
Technical Support: +1 (301) 975-1007  
E-mail: [support@patton.com](mailto:support@patton.com)  
WWW: [www.patton.com](http://www.patton.com)

POWERED BY \_\_\_\_\_  
**TRINITYAE**<sup>®</sup>

Part Number: **07MD6081RC-GS, Rev. D**  
Revised: **February 20, 2012**

**Patton Electronics Company, Inc.**

7622 Rickenbacker Drive  
Gaithersburg, MD 20879 USA

Tel: +1 (301) 975-1000

Fax: +1 (301) 869-9293

Support: +1 (301) 975-1007

Web: [www.patton.com](http://www.patton.com)

E-mail: [support@patton.com](mailto:support@patton.com)

**Copyright © 2012, Patton Electronics Company. All rights reserved.**

The information in this document is subject to change without notice. Patton Electronics assumes no liability for errors that may appear in this document.

The software described in this document is furnished under a license and may be used or copied only in accordance with the terms of such license.

# Summary Table of Contents

<b>1</b>	<b>Model 6081RC overview</b> .....	<b>12</b>
<b>2</b>	<b>Hardware installation</b> .....	<b>20</b>
<b>3</b>	<b>Initial configuration</b> .....	<b>28</b>
<b>4</b>	<b>Contacting Patton for assistance</b> .....	<b>32</b>
<b>A</b>	<b>Compliance information</b> .....	<b>35</b>
<b>B</b>	<b>Specifications</b> .....	<b>38</b>
<b>C</b>	<b>Cabling</b> .....	<b>41</b>
<b>D</b>	<b>Port pin-outs</b> .....	<b>44</b>
<b>E</b>	<b>End user license agreement</b> .....	<b>47</b>

# Table of Contents

<b>Summary Table of Contents</b> .....	<b>3</b>
<b>Table of Contents</b> .....	<b>4</b>
<b>List of Figures</b> .....	<b>7</b>
<b>List of Tables</b> .....	<b>8</b>
<b>About this guide</b> .....	<b>9</b>
Audience.....	9
Structure.....	9
Precautions .....	10
Typographical conventions used in this document.....	10
General conventions .....	10
Mouse conventions .....	11
<b>1 Model 6081RC overview</b> .....	<b>12</b>
Introduction.....	13
Product overview.....	13
Hardware overview.....	15
LAN Ethernet port .....	17
Packet switched Ethernet bus (PSB) .....	17
Backplane Ethernet interfaces .....	17
RS-232 control port .....	18
Power system .....	18
Central processing unit .....	18
Temperature .....	18
Altitude .....	18
Humidity .....	18
Physical dimensions .....	18
Management services .....	18
LED display .....	19
<b>2 Hardware installation</b> .....	<b>20</b>
Introduction.....	21
Unpacking the Model 6081RC.....	21
Installing the PMC Ethernet Access Module onto the 6081RC front blade.....	22
Model 6081RC blades installation.....	23
Cable installation.....	25
Connecting the Ethernet ports .....	25
Connecting the 10/100Base-T Ethernet port to an Ethernet switch or hub .....	26
Connecting the 10/100Base-T Ethernet port to an Ethernet-capable workstation or PC .....	26
Connecting the EIA-561 RS-232 configuration port (DCE configured) .....	27
Completing the hardware installation .....	27

- 3 Initial configuration ..... 28**
  - Introduction ..... 29
  - 1. Connecting the 6081RC to your PC ..... 29
    - Connecting and logging in via the Ethernet port ..... 29
    - Connecting and logging in via the Console port ..... 30
  - 2. Configuring the desired IP address ..... 30
    - Factory-default IP settings ..... 30
    - Login ..... 30
    - Changing the IP address ..... 31
  - 3. Connecting the 6081RC to the network..... 31
- 4 Contacting Patton for assistance ..... 32**
  - Introduction ..... 33
  - Contact information ..... 33
  - Warranty Service and Returned Merchandise Authorizations (RMAs) ..... 33
    - Warranty coverage ..... 33
      - Out-of-warranty service ..... 33
      - Returns for credit ..... 33
      - Return for credit policy ..... 34
    - RMA numbers ..... 34
    - Shipping instructions ..... 34
- A Compliance information ..... 35**
  - Compliance ..... 36
    - RTTE Directive (CE Mark) ..... 36
    - EMC ..... 36
  - Radio and TV Interference ..... 36
  - FCC Part 68 (ACTA) Statement ..... 36
  - 6081RCCE Declaration of Conformity ..... 37
  - Authorized European Representative ..... 37
- B Specifications ..... 38**
  - Routing ..... 39
  - RADIUS client ..... 39
  - IP Services ..... 39
  - Ethernet Ports ..... 39
  - Front Panel Indicators ..... 39
  - Ethernet Services ..... 40
  - HDLC Services ..... 40
  - Management Service ..... 40
  - Alarm Reporting ..... 40
  - Safety ..... 40
  - Physical ..... 40
- C Cabling ..... 41**
  - Introduction ..... 42

Console .....	42
Ethernet .....	43
<b>D Port pin-outs .....</b>	<b>44</b>
Introduction .....	45
Console port .....	45
Ethernet .....	46
<b>E End user license agreement .....</b>	<b>47</b>
End User License Agreement .....	48
1. Definitions .....	48
2. Title .....	48
3. Term .....	48
4. Grant of License .....	48
5. Warranty .....	48
6. Termination .....	49
7. Other licenses .....	49

## List of Figures

1	Model 6081RC EdgeRoute Network Access Router	13
2	Model 6081RC front panel	16
3	Model 6081RC Ethernet port LEDs	17
4	Model 6081RC LEDs	19
5	Installing the PMC card	22
6	Alignment/ESD pin and card handle	24
7	Model 6081RC network and configuration ports	25
8	Ethernet RJ-45 pin and signal definitions for Model 6081RC	26
9	Cross-over RJ-45-to-RJ-45 Ethernet cable diagram	26
10	DB-9-to-RJ-45 cable diagram	27
11	Connecting the 6081RC to your laptop PC via the Ethernet port	29
12	Connecting the 6081RC to your laptop PC via the console port	30
13	Connecting a serial terminal	42
14	Typical Ethernet straight-through cable diagram for 10/100Base-T	43
15	Typical Ethernet straight-through cable diagram for 1000Base-T	43
16	EIA-561 (RJ-45 8-pin) port	45

## List of Tables

---

1	General conventions .....	10
2	Mouse conventions .....	11
3	LED definitions .....	19
4	Factory default IP address and network mask configuration .....	30
5	RJ45 socket 10/100Base-T .....	46
6	RJ45 socket 1000Base-T .....	46



## About this guide

---

This guide describes installing and configuring a Patton Electronics Model 6081RC EdgeRoute Network Access Router. By the time you are finished with this guide, your Network Access Router will be ready to accept routing or bridging configurations. The instructions in this guide are based on the following assumptions:

- The Model 6081RC will be installed in a Patton ForeFront chassis
- There is a LAN connected to the Ethernet port of the Network Access Router
- There are function cards (i.e. 3096RC, 3196RC, 2616RC, etc.) already installed in the ForeFront chassis

## Audience

---

This guide is intended for the following users:

- Operators
- Installers
- Maintenance technicians

## Structure

---

This guide contains the following chapters and appendices:

- [Chapter 1](#) describes the Model 6081RC Network Access Router
- [Chapter 2](#) describes installing the Model 6081RC hardware
- [Chapter 3](#) describes initial Model 6081RC configuration
- [Chapter 4](#) contains information on contacting Patton technical support for assistance
- [Appendix A](#) lists compliance information
- [Appendix B](#) contains specifications for the router
- [Appendix C](#) provides cable recommendations
- [Appendix D](#) describes the router's ports and pin-outs
- [Appendix E](#) provides license information that describes acceptable usage of the software provided with the 6081RC

For best results, read the contents of this guide *before* you install the Model 6081RC.

## Precautions

Notes and cautions, which have the following meanings, are used throughout this guide to help you become aware of potential Model 6081RC problems. *Warnings* relate to personal injury issues, and *Cautions* refer to potential property damage.

**Note** Calls attention to important information.



The shock hazard symbol and **WARNING** heading indicate a potential electric shock hazard. Strictly follow the warning instructions to avoid injury caused by electric shock.



The alert symbol and **WARNING** heading indicate a potential safety hazard. Strictly follow the warning instructions to avoid personal injury.



The shock hazard symbol and **CAUTION** heading indicate a potential electric shock hazard. Strictly follow the instructions to avoid property damage caused by electric shock.



The alert symbol and **CAUTION** heading indicate a potential hazard. Strictly follow the instructions to avoid property damage.

## Typographical conventions used in this document

This section describes the typographical conventions and terms used in this guide.

### General conventions

The procedures described in this manual use the following text conventions:

Table 1. General conventions

Convention	Meaning
Garamond blue type	Indicates a cross-reference hyperlink that points to a figure, graphic, table, or section heading. Clicking on the hyperlink jumps you to the reference. When you have finished reviewing the reference, click on the <b>Go to Previous View</b> button  in the Adobe® Acrobat® Reader toolbar to return to your starting point.
<b>Futura bold type</b>	Indicates the names of menu bar options.
<i>Italicized Futura type</i>	Indicates the names of options on pull-down menus.
Futura type	Indicates the names of fields or windows.
Garamond bold type	Indicates the names of command buttons that execute an action.

Table 1. General conventions

Convention	Meaning
< >	Angle brackets indicate function and keyboard keys, such as <b>&lt;Shift&gt;</b> , <b>&lt;Ctrl&gt;</b> , <b>&lt;C&gt;</b> , and so on.
Are you ready?	All system messages and prompts appear in the Courier font as the system would display them.
% dir *.*	Bold Courier font indicates where the operator must type a response or command

### Mouse conventions

The following conventions are used when describing mouse actions:

Table 2. Mouse conventions

Convention	Meaning
Left mouse button	This button refers to the primary or leftmost mouse button (unless you have changed the default configuration).
Right mouse button	This button refers the secondary or rightmost mouse button (unless you have changed the default configuration).
Point	This word means to move the mouse in such a way that the tip of the pointing arrow on the screen ends up resting at the desired location.
Click	Means to quickly press and release the left or right mouse button (as instructed in the procedure). Make sure you do not move the mouse pointer while clicking a mouse button.
Double-click	Means to press and release the same mouse button two times quickly
Drag	This word means to point the arrow and then hold down the left or right mouse button (as instructed in the procedure) as you move the mouse to a new location. When you have moved the mouse pointer to the desired location, you can release the mouse button.

# Chapter 1 **Model 6081RC overview**

## **Chapter contents**

Introduction .....	13
Product overview .....	13
Hardware overview .....	15
LAN Ethernet port .....	17
Packet switched Ethernet bus (PSB) .....	17
Backplane Ethernet interfaces .....	17
RS-232 control port .....	18
Power system .....	18
Central processing unit .....	18
Temperature .....	18
Altitude .....	18
Humidity .....	18
Physical dimensions .....	18
Management services .....	18
LED display .....	19

## Introduction

The Model 6081RC Network Access Router (see [figure 1](#)) is a MIPS-based processor blade for the ForeFront Access Infrastructure System (AIS). With hardware and software features optimized for Layer-2/Layer-3 networking, the 6081RC enables the AIS to deliver IP as an access infrastructure element as well as support the delivery of advanced broadband IP services and applications.

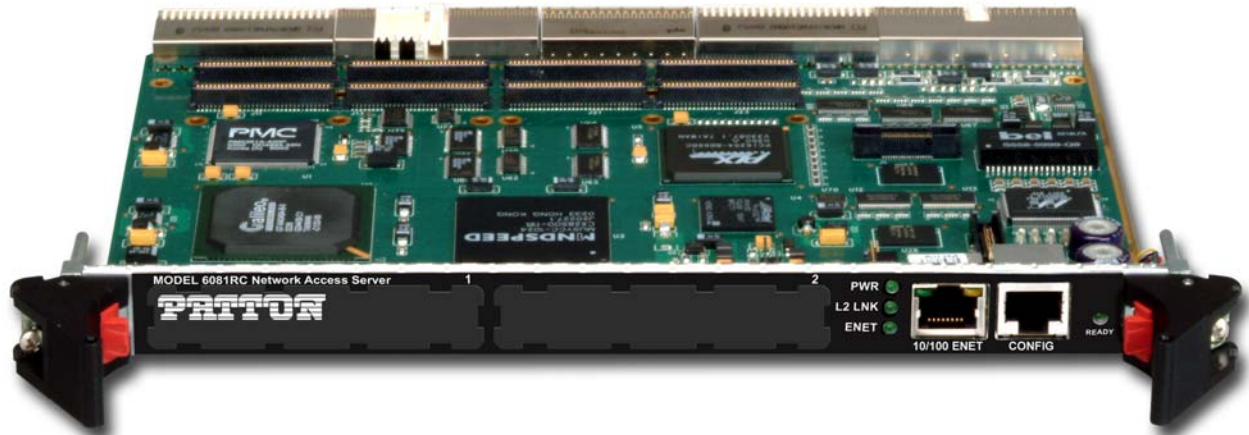

Figure 1. Model 6081RC EdgeRoute Network Access Router

When installed into the 2U, 4U, or 6U ForeFront chassis, the Model 6081RC adds IP routing and access services to installed interfaces, such as xDSL, T1/E1, and STM ports. With the addition of data termination packages, as well as select edge services packages (e.g. DNS), the Model 6081RC provides full-featured ipDSLAM functionality to any ForeFront system.

The Model 6081RC preserves legacy TDM services while providing Layer-2/Layer-3 services. TDM data communications can operate seamlessly within the same hardware, the same chassis, even over the same wired infrastructure.

## Product overview

The Model 6081RC is a frame and service edge-routing resource that provides access-to-edge, packet-based services for IP termination; forwarding; and frame services within a ForeFront AIS chassis. Ideal for use by service providers, the Model 6081RC provides:

- Aggregation for customer DSL/T1/E1 to framed network services, including Ethernet bridging and VLAN v1 and v2
- IP routing and forwarding
- IP access services (including QoS class-based queuing, NAT, and ACLs)

The Model 6081RC interfaces to ForeFront line cards via the TDM chassis. The 6081RC processes packets at 50k packets per second (pps). The main differences based on the processor chosen. With access to *all* 4,096 DS0s the 6081RC allows up to 2,048 discreet full-duplex data connections from a single card.

Network connections may come from any number of ForeFront interfaces. The 6018RC allows any resource card within ForeFront to deliver TDM *and* IP/packet services on a DS0-by-DS0, connection-by-connection basis.

The ForeFront system with the 6081RC allows:

- Any DSL or T1/E1 port to deliver IP access
- This access can be offered *simultaneously* with other TDM services
- This access can be on the same DSL or T1/E1 link as the same time

Leveraging ForeFront's any-to-any architecture packet services expands the scope of services from a single installed system. Providers can now use ForeFront for simultaneous TDM/leased-line and packet service delivery. The smart carrier today wishes to incorporate IP/L2/L3 services as an infrastructure element into their service offering. Based on the foundation of intelligent TDM switching and integrated DACsing, the Patton ForeFront architecture is highlighted by the following key features:

- Any DS0 level timeslot can be used for either TDM or IP Accesses. This is operator selectable and not limited by a module, external equipment, or backplane capabilities.
- Access to any DS0 is completely non-blocking. In other words, you are not limited to a specific data path/backplane, service selection based on the capabilities of a module, or it's location within a shelf.
- Delivery using Integrated wires through the use of the standard and integrated DACS. Now, both TDM and IP can be offered on the same DSL, E1, or STM/VC12 ports at the same time. For example, using the Patton 3086 IAD, you can deliver nx64kbps for TDM access and select the remaining bandwidth for Packet access. Both services can run at the same time over the same port and terminate at the customer premise in a single low-cost unit.
- Local network based and processing and termination. We continue legacy TDM services without disruption, but add value-added protocol internetworking to those TDM applications.

The 6081RC connects directly to all channels (4,096) on the H.110 bus and is agnostic to the line interface method. The current set of compatible ForeFront resources which interface to the 6081RC include:

- 3096RC G.SHDSL 16 port, 64-kbps–4.6 Mbps, 2-wire access
- 3196RC iDSL 16 port, 64/128/144-kbps, 2-wire access
- 2616RC T1/E1 DACs bulk DS0 cross-connecting
- 6511RC STM-1 (63 E1s, 84 T1s per connection)

Since the 6081RC can go into any of the available slots processing and routing/switching power can be increased by simply adding more cards to a system. The following tables indicates the number of 6081RCs that can be placed into a single chassis:

Chassis	Card support
Model 6276 (2U)	Supports up to 4 6081RC
Model 6476 (4U)	Supports up to 8 6081RC
Model 6676 (6U)	Supports up to 17 6081RC

The 6081RC's applications give life to the hardware features of the 6081RC. Details of the software applications are indicated in the section 6081RC IP Access Server Functionality.

- PPP Bridging and Routing
- VLAN Ethernet Support
- RIPv1 and v2 and static routing
- SNMPv1,2,3
- RADIUS AAA Client
- HTTP/web for management
- NTP Network Time
- Syslog

Additionally, new applications such as L2TP, IPSEC, and MPLS will be added in releases subsequent releases.

The HTTP WEB GUI provides for easy configuration, provisioning, and management. Full SNMP control of the device allows standardized OSS configuration and provisioning when used with an external FCAPS NMS.

Using SNMP management, the 6081RC is fully configured, managed and monitored via Patton's ForeSight EMS solutions. With ForeSight, a Graphical User Interface provides an intuitive, real-life representation of all installed ForeFront equipment and enables network managers to control and monitor device functions, port settings and receive device status information and statistics via SNMP. Features include management, a routable configuration utility, SNMP trap manager, device autoscan, automatic configuration and device firmware downloads and more. The user and NMS have full remote control for provisioning, alarms, accounting, and security.

## Hardware overview

---

- 6U single-slot card
- MIPS64 CPU (800-MHz)
- 128 Mbytes of RAM
- 32 Mbytes or 64 Mbytes of Flash memory
- Capacitor-backed real-time clock with two week's duration of standby power
- 16 kbytes of non-volatile data storage in EEPROM

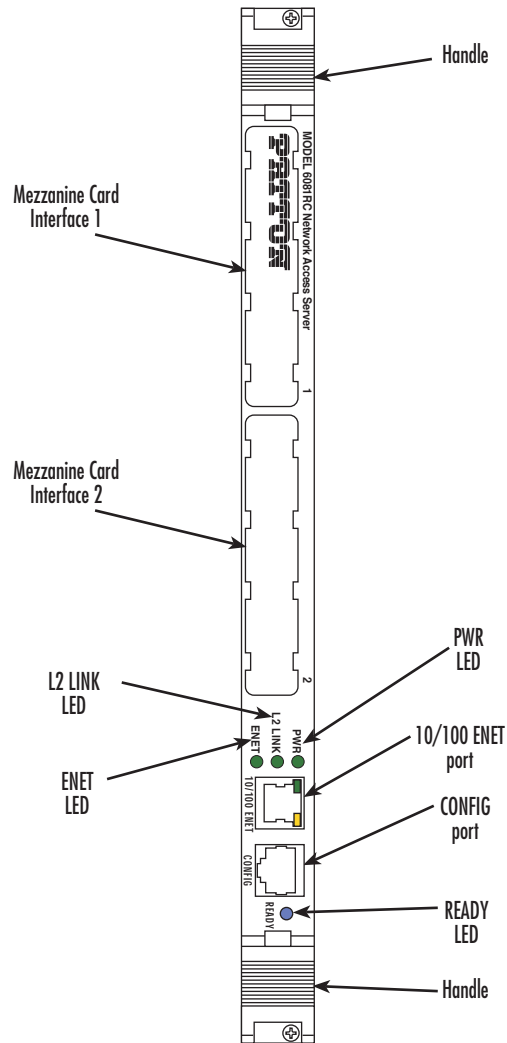

Figure 2. Model 6081RC front panel

- One front panel 10/100Mbps Ethernet port (see [figure 2](#)) with two LEDs
- One front-panel RS232 console port (see [figure 2](#))
- Three front-panel LEDs (see [figure 2](#))
- Two packet switch buss 10/100 Mbps Ethernet ports
- Optional full termination of TDM chassis bus into 1024-channel HDLC controller
- Hot-swap support



### LAN Ethernet port

Front panel 10/100-Mbps Ethernet LAN port labeled *ENET* (*ETH0*) is presented on a RJ-45 connector with an auto-sensing/full-duplex 10Base-T or 100Base-T interface. Also included are:

- 100Base-TX half-/full-duplex operation (100 + 100)
- 10Base-T half-/full-duplex operation (10 + 10)
- Auto negotiation and fallback
- 10/100 Mbps link and status indicators on the RJ-45 connector
- Two LEDs per port (see figure 3): link/traffic LED (solid green when link is established; flashing green when the port has traffic) and 10/100 Mbps LED (solid yellow at 100 Mbps; off at 10 Mbps)

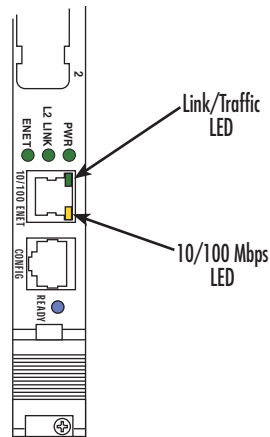

Figure 3. Model 6081RC Ethernet port LEDs

### Packet switched Ethernet bus (PSB)

- Two internal Ethernet buses connecting over the mid-plane for intercard communication within the chassis (or chassis segments of the Model 6676)
- Hash-table-based address filtering for up to 8k MAC addresses, unicast and multicast
- Wire-speed DMA transfer of entire MAC frame to system memory

### Backplane Ethernet interfaces

- Two internal Ethernet ports connecting to backplane for intercard communication
- Auto-sensing full/half-duplex 10Base-T/100Base-TX operation, IEEE 802.3 compliant
- Hash-table-based address filtering for up to 8k MAC addresses, unicast and multicast
- Wire-speed DMA transfer of entire MAC frame to system memory

- Two LEDs per port (see [figure 3](#)): link/traffic LED (solid green when link is established; flashing green when the port has traffic) and 10/100 Mbps LED (solid yellow at 100 Mbps; off at 10 Mbps)

**Note** When the Fast-Ethernet PMC module (part number PEC1/FENET/2/TX) is installed in PMC slot 2, you may redirect one or both internal Ethernet ports B and C to the front-panel RJ-45 connectors B and C. Redirecting an Ethernet port to the front panel disables the backplane interface for that port.

### RS-232 control port

The RS-232 port provides for initial configuration of the Model 6081RC's IP and gateway addresses. The RS-232 port supports:

- Asynchronous data rates of 19.2 kbps, 8 data bits, no parity, 1 stop bit.
- An RJ-45 connector with EIA-561 pinouts
- A management interface that supports VT-100 terminals
- Hardware flow control (RTS and CTS)

### Power system

The Model 6081RC is powered internally by the ForeFront chassis power system.

### Central processing unit

Model 6081RC CPU processing power and memory are listed in the following table:

Model	Processor	Memory	Throughput <sup>a</sup>
6081RC/800	RM7965 processor, 800MHz.	128Mb RAM, 32 Mb Flash	50 kpps

a. Packets per second routing without filtering and QoS

### Temperature

32 to 104°F (0 to 40°C)

### Altitude

Maximum operating altitude: 15,000 feet (4,752 meters)

### Humidity

5 to 90% relative humidity (RH), non-condensing

### Physical dimensions

- 1.75 inches (4.44 cm) height, standard 19-inch (48.26 cm) width, 12-inch (30.48 cm) depth
- Weight: 1.5 lbs (0.7 kg)

### Management services

- Out-of-band RS-232 configuration port for management and control
- SNMP version 1,2,3 MIB II configuration management

- SYSLOG client
- Remote software upgrade via FTP
- Built-in HTTP server for complete configuration and control using a standard WWW browser

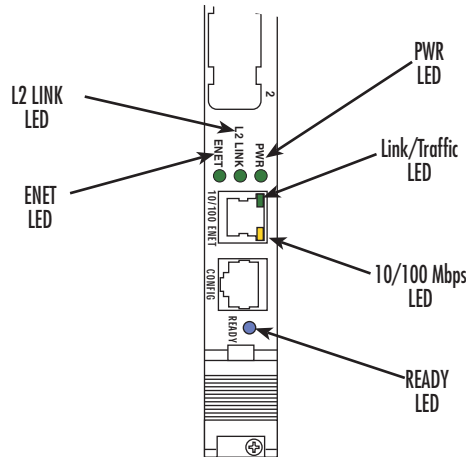

Figure 4. Model 6081RC LEDs

**LED display**

Front panel LEDs (see figure 4) display the status of the power system, layer-2 link, the Ethernet LAN port, power, and the alarms. The LEDs are described in table 3.

Table 3. LED definitions

LED	Color	Status	Meaning
PWR	Green	On solid	Power is being applied.
		Flashing	The 6081RC is in boot-up sequence.
		Off	No input power is being applied.
L2 LINK (Layer 2 Link)	Green	Flashing	The 6081RC is operating properly.
		Off	Link has not been established.
ENET	Green	On solid	Indicates at least one of three Ethernet ports is active
		Off	None of the Ethernet ports is active
Link/traffic (front panel ENET port)	Green	On solid	Link is established
		Flashing	The port has traffic.
		Off	Link has not been established.
10/100 Mbps (front panel ENET port)	Yellow	On solid	Port is operating at 100 Mbps
		Off	Port is operating at 10 Mbps
READY	Blue	On	Card ready for removal from ForeFront chassis.
		Off	Card not ready for removal from ForeFront chassis.

## Chapter 2 **Hardware installation**

### **Chapter contents**

Introduction.....	21
Unpacking the Model 6081RC .....	21
Installing the PMC Ethernet Access Module onto the 6081RC front blade.....	22
Model 6081RC blades installation.....	23
Cable installation.....	25
Connecting the Ethernet ports .....	25
Connecting the 10/100Base-T Ethernet port to an Ethernet switch or hub .....	26
Connecting the 10/100Base-T Ethernet port to an Ethernet-capable workstation or PC .....	26
Connecting the EIA-561 RS-232 configuration port (DCE configured) .....	27
Completing the hardware installation .....	27

## Introduction

---

This chapter contains the following procedures for installing the Model 6081RC:

- “Unpacking the Model 6081RC”—lists the contents in the 6081RC shipping container
- “Model 6081RC blades installation”—describes installing the Network Access Router in a ForeFront chassis
- “Cable installation” on page 25—describes installing network interface and terminal cables
- “Completing the hardware installation” on page 27—describes testing the 6081RC hardware to verify that it is ready for software configuration

## Unpacking the Model 6081RC

---

Inspect the shipping carton for external damage. Note any damage before removing the container contents. Report equipment damage to the shipping carrier immediately for claim purposes. Save all packing materials in case you need to return an item to the factory for servicing.

The Model 6081RC comes with the following items:

- The Model 6081RC rack card unit
- One RJ45-to-RJ45 cable for use with the console and Ethernet ports
- A DB9-RJ45 (EIA-561) adapter for connecting a PC's serial port to the 6081RC console port

## Installing the PMC Ethernet Access Module onto the 6081RC front blade

You may purchase an optional PMC Ethernet Access Module for the Model 6081RC. The PMC Ethernet Access Module may be factory installed, or you may order it separately for installation in the field. The Model 6081RC has two PMC expansion slots, numbered 1 and 2 (see [figure 5](#)). The PMC Ethernet Access Module must only be installed in PMC slot 2, *do not install it in PMC slot 1*.

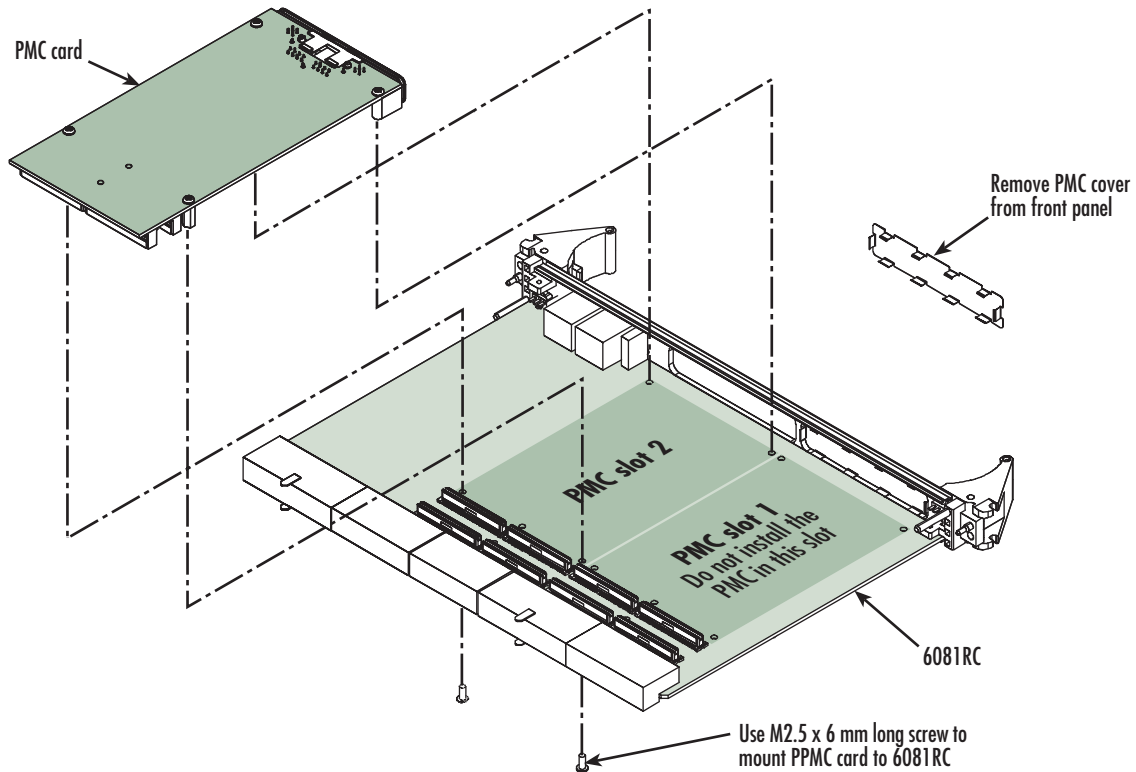

Figure 5. Installing the PMC card

To install the Ethernet Access Module in your Model 6081RC, do the following:



You must wear the anti-static strap to avoid electrostatic damage to the 6081RC or to the PMC Ethernet Access Module.



The 6081RC must not be installed in the chassis when installing the PMC Ethernet Access Module.



The PMC Ethernet Access Module must be installed in PMC slot 2. Do not install it in PMC slot 1.

1. Set the Model 6081RC on a flat anti-static surface with the circuitry facing upward.
2. Remove the PMC slot 2 protective cover from the Model 6081RC front panel (see [figure 5](#) on page 22).
3. Insert the front panel of the PMC card into the cutout for PMC slot 2 on the front panel of the Model 6081RC.
4. Align the two connectors on the PMC card with the corresponding connectors on the Model 6081RC (see [figure 5](#) on page 22).
5. Gently and firmly press down on the rear of the PMC card, so that the connectors mate and snap into place.
6. Install the 4 fastening screws as shown in [figure 5](#) on page 22. Gently tighten the screws into place.

## Model 6081RC blades installation

The Model 6081RC installs in a Patton ForeFront chassis. The 6081RC is hot-swappable so it is not necessary to power down the chassis before installing the blade.



**Do not work on the system or connect or disconnect cables during periods of lightning activity.**



Ultimate disposal of this equipment must be handled according to all applicable national laws and regulations.

**Note** Verify that the rack chassis is properly grounded before installing the Model 6081RC blades. An adequate ground can be achieved by connecting a #10 AWG ground wire between the rack chassis grounding stud and one of the following ground sources:

- The building ground rod (generally located at the site's main service entrance)
- A sprinkler system pipe
- A cold-water pipe
- Building structural steel

1. If you have not done so already, remove the Model 6081RC from its shipping container.

**Note** Be sure to wear the anti-static strap to prevent electrostatic damage to the blade.

**Note** The location should be well ventilated. Do not block the rack chassis' cooling vents.

2. Insert the rear blade into the desired slot in the rack chassis. Make sure the blade is seated properly in the slot guides.

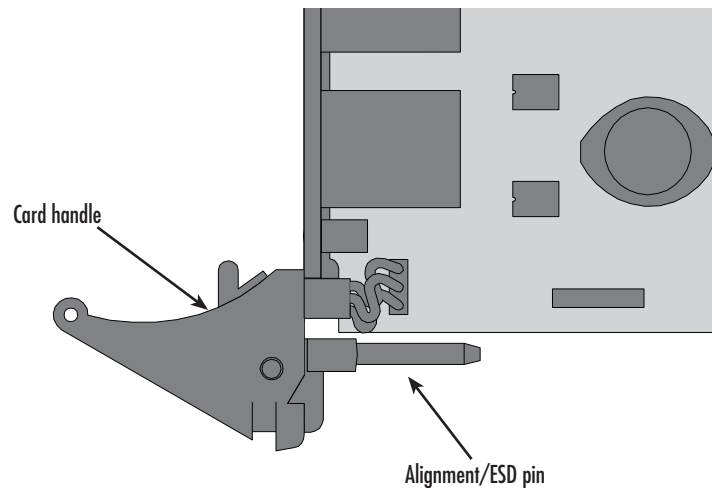

Figure 6. Alignment/ESD pin and card handle

3. Gently press the blade into the chassis until the alignment/ESD pin (see [figure 6](#)) engages the chassis. When the blade is fully seated, the red buttons in the handles click up automatically, thus locking the handle and activating the switch (closed position). The click of the button gives a visual and audible confirmation that the board is fully seated.



## Cable installation

This section describes installing the network interface cables.



CAUTION

The interconnecting cables shall be acceptable for external use and shall be rated for the proper application with respect to voltage, current, anticipated temperature, flammability, and mechanical serviceability.

### Connecting the Ethernet ports

The Model 6081RC comes with three Ethernet ports. One Ethernet port is presented on the front panel via an RJ-45 connector (figure 7), and two internal Ethernet ports that connect to the PICMG 2.16 backplane for inter-card communication. All Ethernet ports will autosense the correct speed (10 or 100 Mbps) of the connection and automatically negotiate half or full-duplex operation. This section describes connecting the front panel Ethernet port on the Model 6081RC to an Ethernet LAN via an Ethernet hub, switch, or workstation.

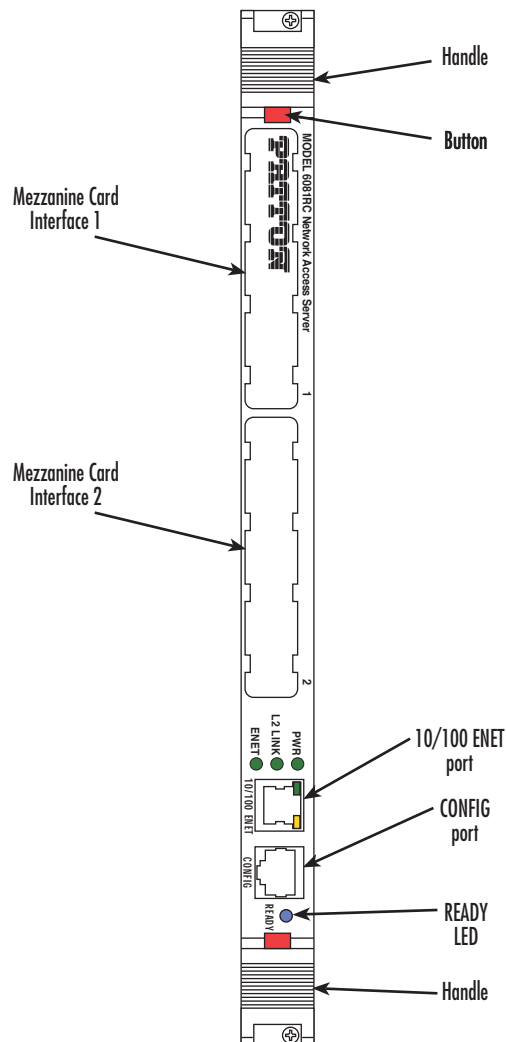

Figure 7. Model 6081RC network and configuration ports

**Connecting the 10/100Base-T Ethernet port to an Ethernet switch or hub**

The 10/100Base-T Ethernet port (see figure 7 on page 25) is designed to connect to an Ethernet switch or hub. The Ethernet RJ-45 pin and signal definitions for the Network Access Router or for a NIC card in a workstation/PC are shown in figure 8. Connect a straight-through CAT-5 cable (one wired as shown in figure 8) between the Model 6081RC and the hub/switch.

6081RC RJ-45 Jack	Signal Name	Direction
1	(TX+) Transmit Data +	Output
2	(TX-) Transmit Data -	Output
3	(RX+) Receive Data +	Input
4		
5		
6	(RX-) Receive Data -	Input
7		
8		

Figure 8. Ethernet RJ-45 pin and signal definitions for Model 6081RC

**Connecting the 10/100Base-T Ethernet port to an Ethernet-capable workstation or PC**

The 10/100Base-T Ethernet port can connect to a single Ethernet-capable workstation or PC by means of a cross over cable. Refer to figure 9 to assemble a cross-connect cable that will connect between the NIC Ethernet port in the workstation and the Network Access Router 10/100Base-T Ethernet port.

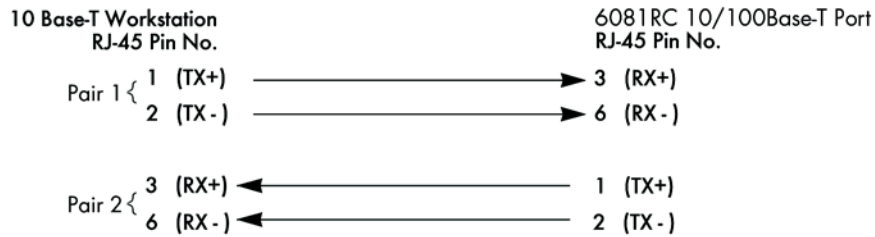

Figure 9. Cross-over RJ-45-to-RJ-45 Ethernet cable diagram

### Connecting the EIA-561 RS-232 configuration port (DCE configured)

Install the supplied RJ-45-to-RJ-45 cable with the DB9-RJ45 adapter between the Model 6081RC RS-232 port (see [figure 7](#) on page 25) and an open serial port on your computer. If you need to assemble your own cable, refer to the pinout diagram in [figure 10](#).

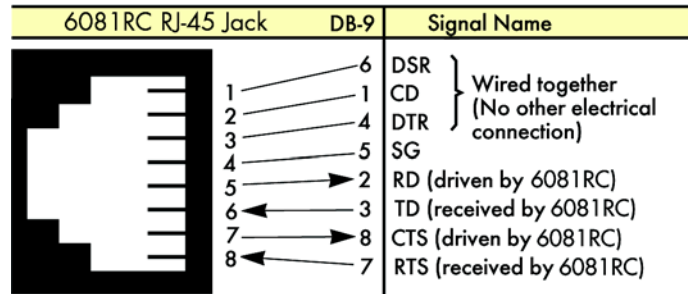

Figure 10. DB-9-to-RJ-45 cable diagram

## Completing the hardware installation

This section verifies that the Model 6081RC hardware is operational to the point where you can begin configuring the software settings.

Power is delivered from the chassis backplane through the power connectors on the 6081RC blades. Upon insertion into the ForeFront chassis, the Model 6081RC immediately powers up and begins its boot cycle. During the boot cycle the following should occur:

1. The POWER LED illuminates, indicating normal power is being applied to the 6081RC.
2. The L2 LINK LED begins flashing, indicating the 6081RC is operating normally.

Hardware installation is now complete. To configure the 6081RC for operation, refer to Chapter 3, [“Initial configuration”](#).

## Chapter 3 **Initial configuration**

### **Chapter contents**

Introduction .....	29
1. Connecting the 6081RC to your PC .....	29
Connecting and logging in via the Ethernet port .....	29
Connecting and logging in via the Console port .....	30
2. Configuring the desired IP address .....	30
Factory-default IP settings .....	30
Login .....	30
Changing the IP address .....	31
3. Connecting the 6081RC to the network.....	31

## Introduction

This chapter leads you through the basic steps to set up a new 6081RC and to download a configuration. Setting up a new 6081RC consists of the following main steps:

**Note** If you haven't already installed the 6081RC, refer to Chapter 2, "Hardware installation" on page 20.

- Connecting the 6081RC to your laptop PC
- Configuring the desired IP address
- Connecting the 6081RC to the network

## 1. Connecting the 6081RC to your PC

First the 6081RC must be connected to the mains power supply with the power cable. Wait until the *Power* LED stops blinking and stays lit constantly. Now the 6081RC is ready.



The interconnecting cables shall be acceptable for external use and shall be rated for the proper application with respect to voltage, current, anticipated temperature, flammability, and mechanical serviceability.

### Connecting and logging in via the Ethernet port

The 6081RC is equipped with an Auto-MDX Ethernet port, so you can use straight-through cables for host or hub/switch connections (see figure 11).

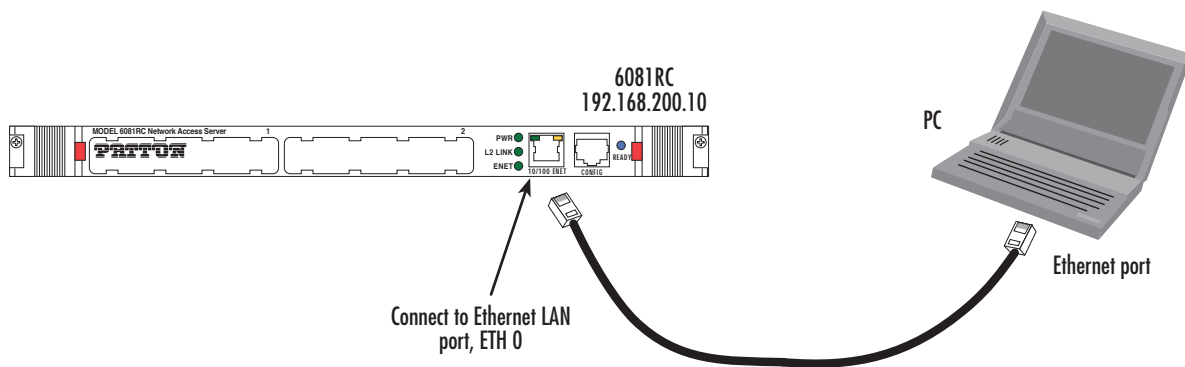

Figure 11. Connecting the 6081RC to your laptop PC via the Ethernet port

The 6081RC comes with a built-in DHCP server to simplify configuration. Therefore, to automatically configure the PC for IP connectivity to the 6081RC, the laptop PC must be configured for DHCP. The 6081RC will provide the PC with an IP address. You can check the connection to the 6081RC by executing the ping command from the PC command window as follows:

```
ping 192.168.200.10
```

### Connecting and logging in via the Console port

To access the 6081RC configuration via the Console port, connect the DB9-RJ45 adapter to the DB-9 serial port on the PC or dumb terminal. Use the RJ45 straight-through cable between the adapter and the Console port on the 6081RC. (see [figure 12](#)). Do NOT connect the device to the Ethernet LAN now. On the PC, start a HyperTerminal session at 19200 bps, 8 data bits, 1 stop bit, no flow control, and no parity. Log into the unit using the username *admin*. Leave the password field empty.

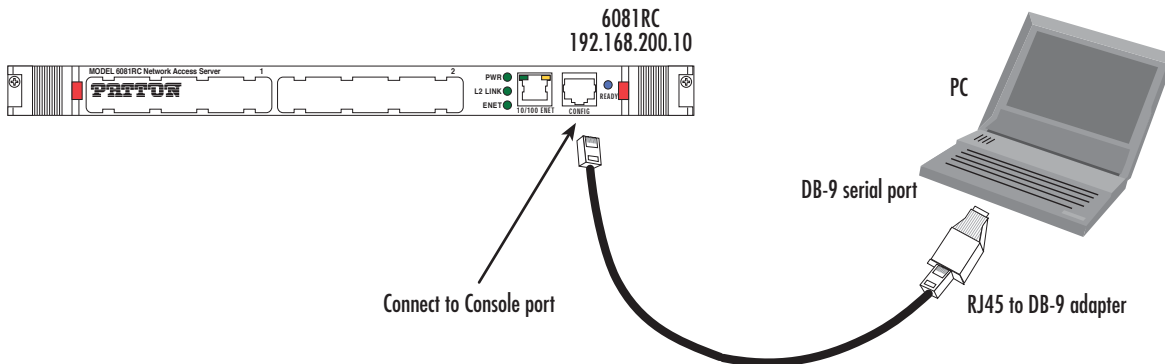

Figure 12. Connecting the 6081RC to your laptop PC via the console port

## 2. Configuring the desired IP address

### Factory-default IP settings

The factory default configuration for the Ethernet interface IP address and network mask is listed in [table 4](#). The Ethernet interface is activated upon power-up.

Table 4. Factory default IP address and network mask configuration

	IP Address	Network Mask
<b>LAN interface Ethernet 0 (ETH 0)</b>	192.168.200.10	255.255.255.0

If this address matches with those of your network, go to section “[3. Connecting the 6081RC to the network](#)” on page 31. Otherwise, refer to the following sections to change the address and network mask.

### Login

To access the 6081RC, start the Telnet application. Type the default IP address for the router into the address field: **192.168.200.10**. Accessing your 6081RC via a Telnet session displays the login screen. Type the factory default login: *admin* and password: *<blank>*.

```
login: admin
password:
Trinity#
```

### Changing the IP address

You can set your IP address and network mask for the interface *ETH 0 (LAN)*. Within this example a network 192.168.1.1/24 address is assumed. The IP address in this example is set to *192.168.1.1* (you should set this the IP address given to you by your network provider).

```
Trinity# configure
Trinity[config]# interface ethernet eth0
Trinity[eth-eth0]# no ip address 192.168.200.10
Trinity[eth-eth0]# ip address 192.168.1.1 netmask 255.255.255.0
```

Copy this modified configuration to your new start-up configuration. This will store your changes in non-volatile memory. Upon the next start-up the system will initialize itself using the modified configuration.

```
Trinity#copy running-config startup-config
Trinity#
```

The 6081RC can now be connected to your network.

## 3. Connecting the 6081RC to the network

In general, the 6081RC will connect to the network via the *LAN (ETH 0)* port. The 6081RC is equipped with Auto-MDX Ethernet port, so you can use straight-through or crossover cables for host or hub/switch connections.



The interconnecting cables shall be acceptable for external use and shall be rated for the proper application with respect to voltage, current, anticipated temperature, flammability, and mechanical serviceability.

You can check the connection with the ping command from the 6081RC to another host on the network.

```
Trinity#ping <IP Address of the host>
```

**Note** If the WAN address is *not* set to DHCP, to ping a device outside your local LAN you must first configure the default gateway.

**Note** For more detailed configuration instructions, see the *Trinity Administrator's Reference Guide* available online at [www.patton.com/manuals/Trinity-arg.pdf](http://www.patton.com/manuals/Trinity-arg.pdf).

**Note**

## Chapter 4 **Contacting Patton for assistance**

### **Chapter contents**

Introduction.....	33
Contact information.....	33
Warranty Service and Returned Merchandise Authorizations (RMAs).....	33
Warranty coverage .....	33
Out-of-warranty service .....	33
Returns for credit .....	33
Return for credit policy .....	34
RMA numbers .....	34
Shipping instructions .....	34



## Introduction

---

This chapter contains the following information:

- “Contact information”—describes how to contact Patton technical support for assistance.
- “Warranty Service and Returned Merchandise Authorizations (RMAs)” —contains information about the RAS warranty and obtaining a return merchandise authorization (RMA).

## Contact information

---

Patton Electronics offers a wide array of free technical services. If you have questions about any of our other products we recommend you begin your search for answers by using our technical knowledge base. Here, we have gathered together many of the more commonly asked questions and compiled them into a searchable database to help you quickly solve your problems.

- Online support—available at [www.patton.com](http://www.patton.com).
- E-mail support—e-mail sent to [support@patton.com](mailto:support@patton.com) will be answered within 1 business day
- Telephone support—standard telephone support is available Monday through Friday, from 8:00 A.M. to 5:00 P.M. EST (8:00 to 17:00 UTC-5), Monday through Friday by calling +1 (301) 975-1007

## Warranty Service and Returned Merchandise Authorizations (RMAs)

---

Patton Electronics is an ISO-9001 certified manufacturer and our products are carefully tested before shipment. All of our products are backed by a comprehensive warranty program.

**Note** If you purchased your equipment from a Patton Electronics reseller, ask your reseller how you should proceed with warranty service. It is often more convenient for you to work with your local reseller to obtain a replacement. Patton services our products no matter how you acquired them.

### Warranty coverage

Our products are under warranty to be free from defects, and we will, at our option, repair or replace the product should it fail within one year from the first date of shipment. Our warranty is limited to defects in workmanship or materials, and does not cover customer damage, lightning or power surge damage, abuse, or unauthorized modification.

### *Out-of-warranty service*

Patton services what we sell, no matter how you acquired it, including malfunctioning products that are no longer under warranty. Our products have a flat fee for repairs. Units damaged by lightning or elephants may require replacement.

### *Returns for credit*

Customer satisfaction is important to us, therefore any product may be returned with authorization within 30 days from the shipment date for a full credit of the purchase price. If you have ordered the wrong equipment or you are dissatisfied in any way, please contact us to request an RMA number to accept your return. Patton is not responsible for equipment returned without a Return Authorization.

### *Return for credit policy*

- Less than 30 days: No Charge. Your credit will be issued upon receipt and inspection of the equipment.
- 30 to 120 days: We will add a 20% restocking charge (crediting your account with 80% of the purchase price).
- Over 120 days: Products will be accepted for repairs only.

### **RMA numbers**

RMA numbers are required for all product returns. You can obtain an RMA by doing one of the following:

- Completing a request on the RMA Request page in the *Support* section at [www.patton.com](http://www.patton.com)
- By calling +1 (301) 975-1000 and speaking to a Technical Support Engineer
- By sending an e-mail to [returns@patton.com](mailto:returns@patton.com)

All returned units must have the RMA number clearly visible on the outside of the shipping container. Please use the original packing material that the device came in or pack the unit securely to avoid damage during shipping.

### *Shipping instructions*

The RMA number should be clearly visible on the address label. Our shipping address is as follows:

**Patton Electronics Company**

RMA#: xxxx

7622 Rickenbacker Dr.

Gaithersburg, MD 20879-4773 USA

Patton will ship the equipment back to you in the same manner you ship it to us. Patton will pay the return shipping costs.

## Appendix A **Compliance information**

### **Chapter contents**

Compliance .....	36
RTTE Directive (CE Mark) .....	36
EMC .....	36
Radio and TV Interference .....	36
FCC Part 68 (ACTA) Statement .....	36
6081RCCE Declaration of Conformity .....	37
Authorized European Representative .....	37

## Compliance

---

The Model 6081RC EdgeRoute Network Access Server has achieved the following approvals and certifications:

### **RTTE Directive (CE Mark)**

- EMC Directive 89/336/EEC
- Low Voltage Directive 73/23/EEC (EN 60950)

### **EMC**

- FCC Part 15, Subpart B, Class A

## Radio and TV Interference

---

The 6081RC router generates and uses radio frequency energy, and if not installed and used properly—that is, in strict accordance with the manufacturer’s instructions—may cause interference to radio and television reception. The 6081RC router have been tested and found to comply with the limits for a Class A computing device in accordance with specifications in Subpart B of Part 15 of FCC rules, which are designed to provide reasonable protection from such interference in a commercial installation. However, there is no guarantee that interference will not occur in a particular installation. If the 6081RC router does cause interference to radio or television reception, which can be determined by disconnecting the unit, the user is encouraged to try to correct the interference by one or more of the following measures: moving the computing equipment away from the receiver, re-orienting the receiving antenna and/or plugging the receiving equipment into a different AC outlet (such that the computing equipment and receiver are on different branches).

## FCC Part 68 (ACTA) Statement

---

This equipment complies with Part 68 of FCC rules and the requirements adopted by ACTA. On the bottom side of this equipment is a label that contains—among other information—a product identifier in the format US: AAAEQ##TXXXX. If requested, this number must be provided to the telephone company.

The method used to connect this equipment to the premises wiring and telephone network must comply with the applicable FCC Part 68 rules and requirements adopted by the ACTA.

If this equipment causes harm to the telephone network, the telephone company will notify you in advance that temporary discontinuance of service may be required. But if advance notice isn’t practical, the telephone company will notify the customer as soon as possible. Also, you will be advised of your right to file a complaint with the FCC if you believe it is necessary.

The telephone company may make changes in its facilities, equipment, operations or procedures that could affect the operation of the equipment. If this happens the telephone company will provide advance notice in order for you to make necessary modifications to maintain uninterrupted service.

If trouble is experienced with this equipment, for repair or warranty information, please contact our company. If the equipment is causing harm to the telephone network, the telephone company may request that you disconnect the equipment until the problem is resolved.

Connection to party line service is subject to state tariffs. Contact the state public utility commission, public service commission or corporation commission for information.

## 6081RCCE Declaration of Conformity

---

This equipment conforms to the requirements of Council Directive 1999/5/EC on the approximation of the laws of the member states relating to Radio and Telecommunication Terminal Equipment and the mutual recognition of their conformity.

The safety advice in the documentation accompanying this product shall be obeyed. The conformity to the above directive is indicated by CE sign on the device.

The signed Declaration of Conformity can be downloaded at [www.patton.com/certifications](http://www.patton.com/certifications).

## Authorized European Representative

---

D R M Green

European Compliance Services Limited.

Oakdene House, Oak Road

Watchfield, Swindon, Wilts SN6 8TD, UK

## Appendix B **Specifications**

### **Chapter contents**

Routing .....	39
RADIUS client .....	39
IP Services .....	39
Ethernet Ports .....	39
Front Panel Indicators .....	39
Ethernet Services .....	40
HDLC Services .....	40
Management Service .....	40
Alarm Reporting .....	40
Safety .....	40
Physical .....	40

## Routing

---

RIPv1 (RFC 1058)

RIPv2 (RFC 2453)

VLSM (RFC 1878)

## RADIUS client

---

Authentication (RFC 2865 & 2868)

Accounting (RFC 2866 & 2867)

PAP (RFC 1332)

CHAP (RFC 1334 & 1994)

## IP Services

---

ARP (RFC0826)

Proxy-ARP (RFC1027)

ICMP (RFC0950, RFC1256)

NTPv3 (RFC1305)

IGMP & IGMPv2 (RFC2236)

NAT (RFC 1631/2663/2766/2993)

GRE

IPSec

AES/DES/3DES

## Ethernet Ports

---

Dual 10/100BaseT (RJ-45 connector)

Auto-negotiating

Half or full duplex operation

## Front Panel Indicators

---

LEDs for power, CPU, system, Ethernet, External clock, and test mode

## Ethernet Services

---

802.1q VLAN tagging

Transparent passing of VLAN tagged Ethernet frames

## HDLC Services

---

PPP (RFC 1661, 2153)

LCP (RFC 1570, 2484)

BCP (RFC 1638)

IPCP (RFC 1332)

## Management Service

---

HTTP

SNMP

Telnet Ethernet

RS-232 Console Port

SYSLOG Client

Software upgrade via FTP

SSH

SNTP

## Alarm Reporting

---

Configurable alarms

Remote SNMP Traps

Front Panel LEDs

## Safety

---

UL/CSA per UL1950 (METS) Canadian cMET and CS-03.

## Physical

---

**Dimensions—Front Blade:** 0.75 H x 10.5 W x 6.3 D in. (1.9 H x 26.7 W x 16.0 D cm)

**Dimensions—Rear Blade:** 0.75 H x 10.5 W x 3.15 D in. (1.9 H x 26.7 W x 8.0 D cm)

**Operating temperature:** 0-40°C (32-104°F)

**Operating humidity:** 5-90% non-condensing



# Appendix C **Cabling**

---

## **Chapter contents**

Introduction.....	42
Console.....	42
Ethernet.....	43

## Introduction

This section provides information on the cables used to connect the 6081RC and the interface cards to the existing network infrastructure and to third party products.

## Console

The 6081RC can be connected to a serial terminal over its serial console port, as depicted in [figure 13](#).



The interconnecting cables shall be acceptable for external use and shall be rated for the proper application with respect to voltage, current, anticipated temperature, flammability, and mechanical serviceability.

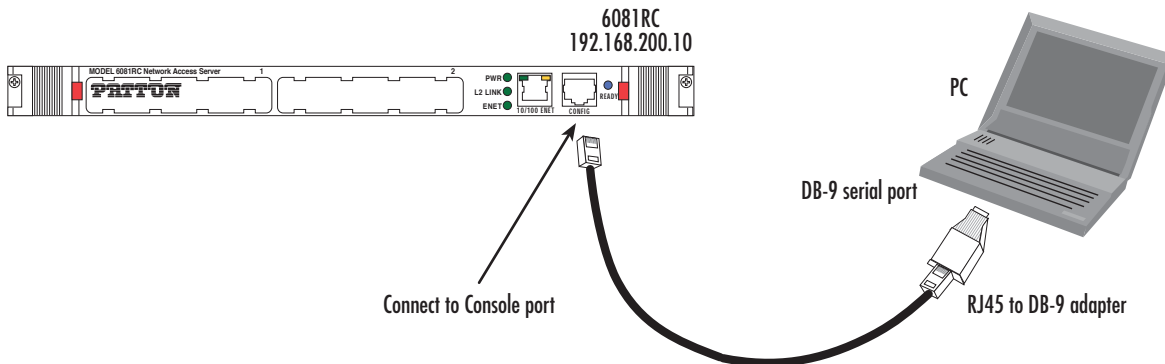

Figure 13. Connecting a serial terminal

**Note** See section “[Console port](#)” on page 45 for console port pin-outs.

## Ethernet

Ethernet devices (10Base-T/100Base-T/1000Base-T) are connected to the 6081RC over a cable with RJ-45 plugs. The Ethernet port on the 6081RC is Auto-MDX use any straight or crossover cable to connect to hubs, switches, PCs or other devices.



The interconnecting cables shall be acceptable for external use and shall be rated for the proper application with respect to voltage, current, anticipated temperature, flammability, and mechanical serviceability.

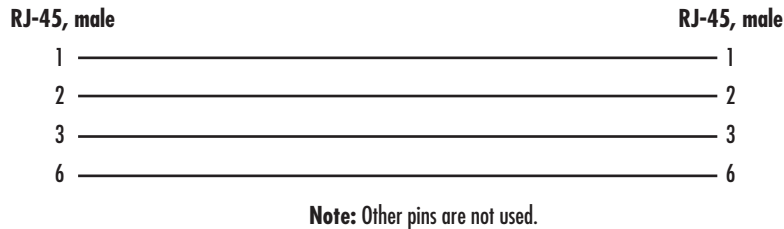
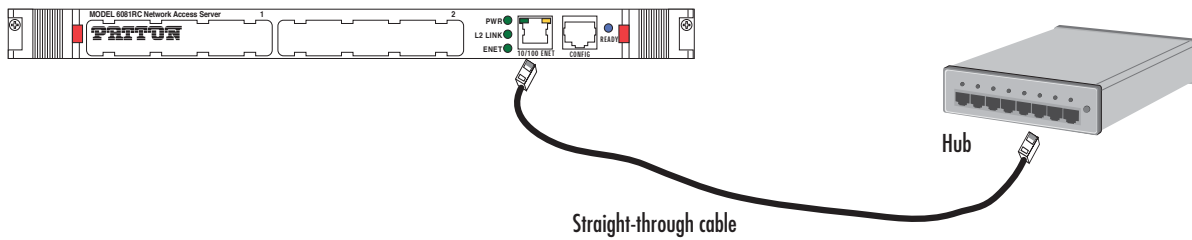

Figure 14. Typical Ethernet straight-through cable diagram for 10/100Base-T

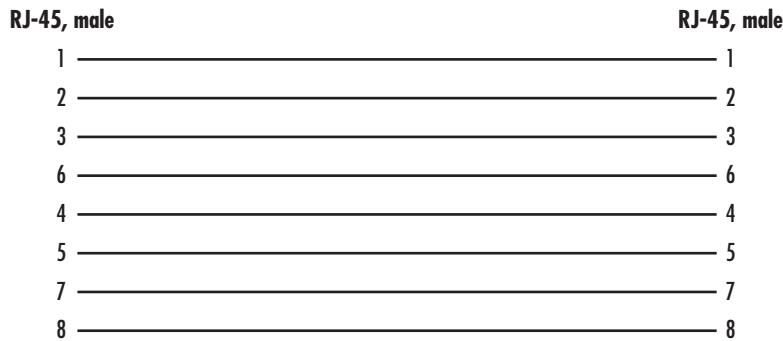

Figure 15. Typical Ethernet straight-through cable diagram for 1000Base-T

## Appendix D **Port pin-outs**

---

### **Chapter contents**

Introduction.....	45
Console port.....	45
Ethernet .....	46

## Introduction

This section provides pin-out information for the ports of the 6081RC.

## Console port

**Configuration settings:** 9600 bps, 8 bits, no parity, 1 stop bit, no flow control

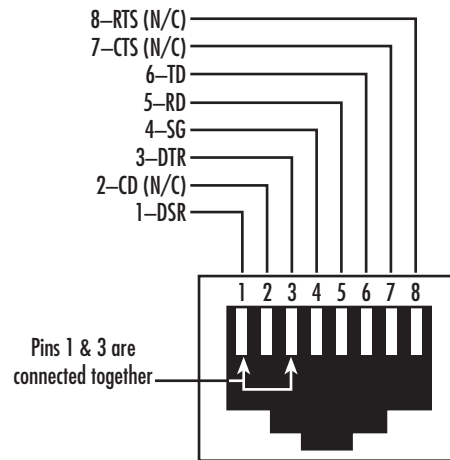

Figure 16. EIA-561 (RJ-45 8-pin) port

**Note** *N/C* means no internal electrical connection.

## Ethernet

---

Table 5. RJ45 socket 10/100Base-T

Pin	Signal
1	TX+
2	TX-
3	RX+
6	RX-

**Note** Pins not listed are not used.

Table 6. RJ45 socket 1000Base-T

Pin	Signal
1	TRD0+
2	TRD0-
3	TRD1+
6	TRD1-
4	TRD2+
5	TRD2-
7	TRD3+
8	TRD3-

## Appendix E **End user license agreement**

### **Chapter contents**

End User License Agreement .....	48
1. Definitions .....	48
2. Title .....	48
3. Term .....	48
4. Grant of License .....	48
5. Warranty .....	48
6. Termination .....	49
7. Other licenses .....	49

## End User License Agreement

---

By opening this package, operating the Designated Equipment or downloading the Program(s) electronically, the End User agrees to the following conditions:

### 1. Definitions

- A) *Effective Date* shall mean the earliest date of purchase or download of a product containing the Patton Electronics Company Program(s) or the Program(s) themselves.
- B) *Program(s)* shall mean all software, software documentation, source code, object code, or executable code.
- C) *End User* shall mean the person or organization which has valid title to the Designated Equipment.
- D) *Designated Equipment* shall mean the hardware on which the Program(s) have been designed and provided to operate by Patton Electronics Company.

### 2. Title

Title to the Program(s), all copies of the Program(s), all patent rights, copyrights, trade secrets and proprietary information in the Program(s), worldwide, remains with Patton Electronics Company or its licensors.

### 3. Term

The term of this Agreement is from the Effective Date until title of the Designated Equipment is transferred by End User or unless the license is terminated earlier as defined in section “6. Termination” on page 49.

### 4. Grant of License

- A) During the term of this Agreement, Patton Electronics Company grants a personal, non-transferable, non-assignable and non-exclusive license to the End User to use the Program(s) only with the Designated Equipment at a site owned or leased by the End User.
- B) The End User may copy licensed Program(s) as necessary for backup purposes only for use with the Designated Equipment that was first purchased or used or its temporary or permanent replacement.
- C) The End User is prohibited from disassembling; decompiling, reverse-engineering or otherwise attempting to discover or disclose the Program(s), source code, methods or concepts embodied in the Program(s) or having the same done by another party.
- D) Should End User transfer title of the Designated Equipment to a third party after entering into this license agreement, End User is obligated to inform the third party in writing that a separate End User License Agreement from Patton Electronics Company is required to operate the Designated Equipment.

### 5. Warranty

The Program(s) are provided *as is* without warranty of any kind. Patton Electronics Company and its licensors disclaim all warranties, either express or implied, including but not limited to the implied warranties of merchantability, fitness for a particular purpose or non-infringement. In no event shall Patton Electronics Company or its licensors be liable for any damages whatsoever (including, without limitation, damages for loss of business profits, business interruption, loss of business information, or other pecuniary loss) arising out of the use of or inability to use the Program(s), even if Patton Electronics Company has been advised of the possibility of such damages. Because some states do not allow the exclusion or limitation of liability for consequential or incidental damages, the above limitation may not apply to you.



If the Program(s) are acquired by or on behalf of a unit or agency of the United States Government, the Government agrees that such Program(s) are *commercial computer software* or *computer software documentation* and that, absent a written agreement to the contrary, the Government's rights with respect to such Program(s) are limited by the terms of this Agreement, pursuant to Federal Acquisition Regulations 12.212(a) and/or DEARS 227.7202-1(a) and/or sub-paragraphs (a) through (d) of the "Commercial Computer Software - Restricted Rights" clause at 48 C.F.R. 52.227-19 of the Federal Acquisition Regulations as applicable.

## 6. Termination

- A) The End User may terminate this agreement by returning the Designated Equipment and destroying all copies of the licensed Program(s).
- B) Patton Electronics Company may terminate this Agreement should End User violate any of the provisions of section "4. Grant of License" on page 48.
- C) Upon termination for A or B above or the end of the Term, End User is required to destroy all copies of the licensed Program(s)

## 7. Other licenses

The Program may be subject to licenses extended by third parties. Accordingly, Patton Electronics Company licenses the Programs subject to the terms and conditions dictated by third parties. Third party software identified to the Programs includes:

- A routing license is included at no charge.
- MGCP capabilities will require the purchase of an additional license.
- The LGPL (Lesser General Public License) open source license distributed to you pursuant to the LGPL license terms (<http://www.gnu.org/licenses/lgpl.html>).
- RedBoot (Red Hat Embedded Debug and Bootstrap) embedded system debug/bootstrap environment from Red Hat distributed to you pursuant to the eCos license terms (<http://ecos.sourceware.org/license-overview.html>) and GNU General Public License (GPL) terms (<http://www.gnu.org/copyleft/gpl.html>). Source code is available upon request.

## Free Manuals Download Website

<http://myh66.com>

<http://usermanuals.us>

<http://www.somanuals.com>

<http://www.4manuals.cc>

<http://www.manual-lib.com>

<http://www.404manual.com>

<http://www.luxmanual.com>

<http://aubethermostatmanual.com>

Golf course search by state

<http://golfingnear.com>

Email search by domain

<http://emailbydomain.com>

Auto manuals search

<http://auto.somanuals.com>

TV manuals search

<http://tv.somanuals.com>