

Preface

Chapter 1

General Introductions

Chapter 2

Getting Started

Chapter 3

Customizing this Notebook

Chapter 4

BIOS setup



Regulations Information

FCC-B Radio Frequency Interference Statement

This equipment has been tested and found to comply with the limits for a Class B digital device, pursuant to part 15 of the FCC rules. These limits are designed to provide reasonable protection against harmful interference in a residential installation. This equipment generates, uses and can radiate radio frequency energy and, if not installed and used in accordance with the instructions, may cause harmful interference to radio communications. However, there is no guarantee that interference will not occur in a particular installation. If this equipment does cause harmful interference to radio or television reception, which can be determined by turning the equipment off and on, the user is encouraged to try to correct the interference by one or more of the following measures:

- w Reorient or relocate the receiving antenna.
- w Increase the separation between the equipment and receiver.
- w Connect the equipment into an outlet on a circuit different from that to which the receiver is connected.
- w Consult the dealer or an experienced radio TV technician for help.

NOTE

1. *The changes or modifications not expressly approved by the party responsible for compliance could void the user's authority to operate the equipment.*
2. *Shield interface cables and AC power cord, if any must be used in order to comply with the emission limits.*

FCC Conditions

This device complies with part 15 of the FCC Rules. Operation is subject to the following two conditions:

1. This device may not cause harmful interference.
2. This device must accept any interference received, including interference that may cause undesired operation.



廢電池請回收

For better environmental protection, waste batteries should be collected separately for recycling or special disposal.

Safety Guideline for Using Lithium Battery

(Danish) ADVARSEL! Lithiumbatteri --- Eksplosionsfare ved fejlagtig håndtering. Udskiftning må kun ske med batteri af same fabrikat og type. Levé det brugte batteri tilbage til leverandøren.

(Deutsch) VORSICHT: Explosionsgefahr bei unsachgemäßem Austausch der Batterie. Ersatz nur durch denselben oder einen vom Hersteller empfohlenen gleich-wertigen Typ. Entsorgung gebrauchter Batterien nach Angaben des Herstellers.

(English) CAUTION: Danger of explosion if battery is incorrectly replaced. Replace only with the same or equivalent type recommended by the equipment manufacturer. Discard used batteries according to manufacturer's instructions.

(Finnish) VAROITUS: Paristo voi räjähtää, jos se on virheellisesti asennettu. Vaihda paristo ainoastaan valmistajan suosittelemaan tyyppiin. Hävitä käytetty paristo valmistajan ohjeiden mukaisesti.

(French) ATTENTION: Il y a danger d'explosion si il y a remplacement incorrect de la batterie. Remplacer uniquement avec une batterie du meme type ou d'un type équivalent recommandé par le constructeur. Mettre au rebut les batteries usages conformément aux instructions du fabricant.

(Norwegian) ADVARSEL: Eksplosjonsfare ved feilaktig skifte av batteri. Benytt same batteritype eller en tilsvarende type anbefalt av apparatfabrikanten. Brukte batterier kasseres i henhold til fabrikantens instruksjoner.

(Swedish) VARNING: Explosionsfara vid felaktigt batteribyte. Använd samma batterityp eller en ekvivalent typ som rekommenderas av apparatillverkaren. Kassera använt batteri enligt fabrikantens instruction.

Caution on Using Modem

1. Never install telephone wiring during a lightning storm.
2. Never install telephone jacks in wet locations unless the jack is specifically designed for wet locations.
3. Never touch uninsulated telephone wires or terminals unless the telephone line has been disconnected at the network interface.
4. Use caution when installing or modifying telephone lines.
5. Avoid using the telephone function (other than a cordless type) during an electrical storm. There may be a remote risk of electric shock from lightning.
6. Do not use the telephone function to report a gas leak in the vicinity of the leak.

Optical Device Drive Notice

CAUTION: This appliance contains a laser system and is classified as a "CLASS 1 LASER PRODUCT." To use this model properly, read the instruction manual carefully and keep this manual for your future reference. In case of any trouble with this model, please contact your nearest "AUTHORIZED service station." To prevent direct exposure to the laser beam, do not try to open the enclosure.

Macrovision Notice

This product incorporates copyright protection technology that is protected by U.S. patents and other intellectual property rights. Use of this copyright protection technology must be authorized by Macrovision, and is intended for home and other limited viewing uses only unless otherwise authorized by Macrovision. Reverse engineering or disassembly is prohibited.

Safety Instructions

1. Read the safety instructions carefully and thoroughly.
2. Save this User Guide for possible use later.
3. Keep this equipment away from humidity and high temperature.
4. Lay this equipment on a stable surface before setting it up.
5. The openings on the enclosure are used for air convection and to prevent the equipment from overheating. Do not cover the openings.
6. Make sure that the power voltage is within its safety range and has been adjusted properly to the value of 100~240V before connecting the equipment to the power inlet.
7. Place the power cord in a way that people are unlikely to step on it. Do not place anything on the power cord.
8. Always unplug the power cord before inserting any add-on card or module.
9. All cautions and warnings on the equipment should be noted.
10. If any of the following situations arises, get the equipment checked by a service personnel:
 - w The power cord or plug is damaged.

- w Liquid has penetrated into the equipment.
 - w The equipment has been exposed to moisture.
 - w The equipment has not worked well or you can not get it work according to User's Manual.
 - w The equipment was dropped and damaged.
 - w The equipment has obvious signs of breakage.
11. Never pour any liquid into the opening that could damage the equipment or cause an electrical shock.
 12. Do not leave the equipment in an unconditioned environment with a storage temperature of 60°C (140°F) or above, which may damage the equipment.
 13. To prevent explosion caused by improper battery replacement, use the same or equivalent type of battery recommended by the manufacturer only.

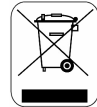

WEEE Statement

(English) Under the European Union ("EU") Directive on Waste Electrical and Electronic Equipment, Directive 2002/96/EC, which takes effect on August 13, 2005, products of "electrical and electronic equipment" cannot be discarded as municipal waste anymore and manufacturers of covered electronic equipment will be obligated to take back such products at the end of their useful life.

(Deutsch) Gemäß der Richtlinie 2002/96/EG über Elektro- und Elektronik-Altgeräte dürfen Elektro- und Elektronik-Altgeräte nicht mehr als

kommunale Abfälle entsorgt werden, die sich auf 13. August, 2005 wirken. Und der Hersteller von bedeckt Elektronik-Artgeräten gesetzlich zur gebrachten Produkte am Ende seines Baruchbarkeitsdauer zurückzunehmen.

(Français) Au sujet de la directive européenne (EU) relative aux déchets des équipements électriques et électroniques, directive 2002/96/EC, prenant effet le 13 août 2005, que les produits électriques et électroniques ne peuvent être déposés dans les décharges ou tout simplement mis à la poubelle. Les fabricants de ces équipements seront obligés de récupérer certains produits en fin de vie.

(Русский) В соответствии с директивой Европейского Союза (ЕС) по предотвращению загрязнения окружающей среды использованным электрическим и электронным оборудованием (директива WEEE 2002/96/EC), вступающей в силу 13 августа 2005 года, изделия, относящиеся к электрическому и электронному оборудованию, не могут рассматриваться как бытовой мусор, поэтому производители вышеперечисленного электронного оборудования обязаны принимать его для переработки по окончании срока службы.

(Español) Bajo la directiva 2002/96/EC de la Unión Europea en materia de desechos y/o equipos electrónicos, con fecha de rigor desde el 13 de agosto de 2005, los productos clasificados como "eléctricos y equipos electrónicos" no pueden ser depositados en los contenedores habituales de su municipio, los fabricantes de equipos electrónicos, están obligados a hacerse cargo de dichos productos al término de su período de vida.

(Nederlands) De richtlijn van de Europese Unie (EU) met betrekking tot

Vervuiling van Elektrische en Electronische producten (2002/96/EC), die op 13 Augustus 2005 in zal gaan kunnen niet meer beschouwd worden als vervuiling. Fabrikanten van dit soort producten worden verplicht om producten retour te nemen aan het eind van hun levenscyclus..

(Srpski) Po Direktivi Evropske unije ("EU") o odbačenoj eelektronskoj i električnoj opremi, Direktiva 2002/96/EC, koja stupa na snagu od 13. Avgusta 2005, proizvodi koji spadaju pod "elektronsku i električnu opremu" ne mogu više biti odbačeni kao običan otpad i proizvođači ove opreme biće prinuđeni da uzmu natrag ove proizvode na kraju njihovog uobičajenog veka trajanja.

(Polski) Zgodnie z Dyrektywą Unii Europejskiej ("UE") dotyczącą odpadów produktów elektrycznych i elektronicznych (Dyrektywa 2002/96/EC), która wchodzi w życie 13 sierpnia 2005, tzw. "produkty oraz wyposażenie elektryczne i elektroniczne " nie mogą być traktowane jako śmieci komunalne, tak więc producenci tych produktów będą zobowiązani do odbierania ich w momencie gdy produkt jest wycofywany z użycia.

(TÜRKÇE) Avrupa Birliği (AB) Kararnamesi Elektrik ve Elektronik Malzeme Atığı, 2002/96/EC Kararnamesi altında 13 Ağustos 2005 tarihinden itibaren geçerli olmak üzere, elektrikli ve elektronik malzemeler diğer atıklar gibi çöpe atılamayacak ve bu elektronik cihazların üreticileri, cihazların kullanım süreleri bittikten sonra ürünleri geri toplamakla yükümlü olacaktır.

(ČESKY) Podle směrnice Evropské unie ("EU") o likvidaci elektrických a elektronických výrobků 2002/96/EC platné od 13. srpna 2005 je zakázáno likvidovat "elektrické a elektronické výrobky" v běžném komunálním odpadu a výrobci elektronických výrobků, na které se tato směrnice vztahuje, budou

povinni odebírat takové výrobky zpět po skončení jejich životnosti.

(MAGYAR) Az Európai Unió („EU”) 2005. augusztus 13-án hatályba lépő, az elektromos és elektronikus berendezések hulladékairól szóló 2002/96/EK irányelve szerint az elektromos és elektronikus berendezések többé nem kezelhetők lakossági hulladékként, és az ilyen elektronikus berendezések gyártói kötelessé válnak az ilyen termékek visszavételére azok hasznos élettartama végén.

(Italiano) In base alla Direttiva dell'Unione Europea (EU) sullo Smaltimento dei Materiali Elettrici ed Elettronici, Direttiva 2002/96/EC in vigore dal 13 Agosto 2005, prodotti appartenenti alla categoria dei Materiali Elettrici ed Elettronici non possono più essere eliminati come rifiuti municipali: i produttori di detti materiali saranno obbligati a ritirare ogni prodotto alla fine del suo ciclo di vita..

Trademarks

All trademarks are the properties of their respective owners.

- w Microsoft is a registered trademark of Microsoft Corporation.
Windows®98/ME, 2000/XP are registered trademarks of Microsoft Corporation.
- w AMI® is a registered trademark of American Megatrends Inc.
- w PCMCIA and CardBus are registered trademarks of the Personal Notebook Memory Card International Association.

Release History

Version	Revision Note	Date
1.0	First Release	06, 2007

Table of Content

Preface

Regulations Information	II
FCC-B Radio Frequency Interference Statement	II
FCC Conditions	III
Safety Guideline for Using Lithium Battery	IV
Caution on Using Modem	V
Optical Device Drive Notice.....	V
Macrovision Notice	VI
Safety Instructions	VI
WEEE Statement	VII
Trademarks	XI
Release History	XI

Introductions

How to Use This Manual	1-2
Unpacking	1-4

Getting Started

Specification	2-2
Product View	2-6
Top-open View	2-6
Front View	2-10
Right-side View	2-11
Left-side View	2-13
Rear View	2-14
Bottom View	2-15
Power Management	2-16
AC Adapter	2-16
Battery Pack	2-18
Using the Battery Pack	2-21
Basic Operations	2-23
Safety and Comfort Tips	2-23
Have a Good Work Habit	2-24
Knowing the Keyboard	2-25
Knowing the Touchpad	2-31
About Hard Disk Drive	2-35
Using the Optical Device Drive	2-36

Customizing this Notebook

Connecting the External Devices	3-2
Connecting the Peripheral Devices	3-3
Connecting the Communication Devices.....	3-6
PC Card Installation.....	3-7
Installing the PC card	3-7
Removing the PC card	3-8
Safely Remove Hardware.....	3-9

BIOS Setup

About BIOS Setup.....	4-2
When to Use BIOS Setup	4-2
How to Run BIOS Setup.....	4-2
Control Keys	4-3
BIOS Setup Menu.....	4-4
Main menu	4-7
Advanced menu.....	4-10
Boot menu.....	4-12
Security menu.....	4-13
Exit menu	4-15

	Preface
Chapter 1	General Introductions
Chapter 2	Getting Started
Chapter 3	Customizing this Notebook
Chapter 4	BIOS setup



Congratulations on becoming a new user of this notebook, the finely designed notebook. This brand-new exquisite notebook will give you a delightful and professional experience in using notebook. We are proud to tell our users that this notebook is thoroughly tested and certified by our reputation for unsurpassed dependability and customer satisfaction.

How to Use This Manual

This User's Manual provides instructions and illustrations on how to operate this notebook. It is recommended to read this manual carefully before using this notebook.

Chapter 1, General Introductions, includes the descriptions of all the accessories of this notebook. It is recommended to check out that if you have all the accessories included when you open the packing box. If any item is damaged or missing, please contact the vendor where you purchased this notebook.

Chapter 2, Getting Started, provides the specification of this notebook, and introduces the function buttons, quick launch buttons, connectors, LEDs and externals of this notebook. Also, this chapter instructs the correct procedure of installing or uninstalling the battery pack, and the brief ideas on how to use this notebook.

Chapter 3, Customizing this Notebook, gives instructions not only in connecting the mouse, keyboard, webcam, printer, external monitor, IEEE 1394 devices, and communication devices, but also in installing and removing the PC card.

Chapter 4, BIOS setup, provides information on BIOS Setup program and allows you to configure the system for optimum use.

Unpacking

First, unpack the shipping carton and check all items carefully. If any item contained is damaged or missing, please contact your local dealer immediately. Also, keep the box and packing materials in case you need to ship the unit in the future.

The package should contain the following items:

- w Notebook
- w User's Manual or Quick Start Guide
- w All-in-one application disk, containing the drivers, utilities, and optional recovery function.
- w High-capacity Li-ion battery pack
- w AC adapter and power cord
- w Phone cable/Phone jack (optional)
- w Notebook carry bag (optional)

These accessories listed above may change without notice.

	Preface
Chapter 1	General Introductions
Chapter 2	Getting Started
Chapter 3	Customizing this Notebook
Chapter 4	BIOS setup



Specification

Physical Characteristic	
Dimension	358 (W) x 259 (D) x 27~33(H) mm
Weight	2.75 kg (1636 Series)/ 2.68 kg (1637/163C Series)
CPU	
Processor Type	Intel® PBGA (478pin)
Support Processor	Intel® Merom dual core and Celeron processor
L2 Cache	1M/2M/4M
Core Chips	
North Bridge	Intel® 965GM or 960GL—1637/163C Series Intel® 965PM --1636 Series
South Bridge	Intel® ICH8-M Base type
Memory	
Technology	DDR2 533/667MHz
Memory	DDR2 SO-DIMM X 2 slots 512/1024 MB DDR2 SDRAM
Maximum	2GB (1024MB DDR2 SO-DIMM x 2)
NAND Flash	
Intel Robson	512MB/1G (1637 Series)
Power	
AC Adapter	90W/19V --1636 Series 65W/19V –1637/163C Series

Battery Type	6 cells (4800mAh)
RTC Battery	Yes
Storage	
HDD form factor	2.5", 9.5mm High, 5400rpm
Optical Device	DVD COMBO drive/Super Multi drive/Light Scribe
I/O Port	
Monitor(VGA)	15 pin D-Sub x 1
USB	x 4 (USB version 2.0)
IEEE1394	x 1
Mic-in	x 1
Line-in	x 1
Headphone Out	x 1 (SPDIF supported)
Internal Microphone	x 1
RJ11	x 1
RJ45	x 1
TV-Out	x 1 (S-Video)
Communication Port	
56K Fax/MODEM	I/F --- Azalia (Modem) Q-com
MDC v1.5	Support on S3/S4 (AC mode) state PTT Approval --- Yes (FCC/CTR21/JATE)
LAN	10/100/1000 mega bit/sec Wake on LAN --- Support on S3/S4/S5 state LAN Boot --- Yes

	Wfm --- Wfm 2.0 support
Wireless LAN	Support
Bluetooth	Support
PCMCIA	
Controller	O2 OZ711SP1
Slot	Type II x 1 SD+MMC+MS+MS Pro 4-in-1 card reader
Display	
LCD Type	15.4" WXGA (Glare type)
Brightness	Brightness controlled by K/B hot-keys
Video	
LCD Resolution	15.4" 1280 x 800 WXGA (Glare) type
CRT Resolution	640x480, max. 32bit color 800x600, max. 32bit color 1024x768, max. 32bit color 1152 x 768, max 32bit color 1280 x 1024, max. 32bit color 1400 x 1050, max. 32bit color 1600 x 1200, max.32bit color 1800 x 1440, max.32bit color
Camera	
CMOS (optional, it may vary depending on the model you purchase)	1.3Mega Pixel

Audio	
Sound Controller	Embedded in South Bridge
Sound Codec chip	Azalia Interface
Internal Speaker	2 Speakers with housing
Internal Microphone	yes
Sound Volume	Adjust by volume button, K/B hot-key & SW
Software & BIOS	
USB Flash Boot	Yes, USB floppy boot up DOS only
BIOS	Fast Boot Support --- Yes
Others	
Kensington Lock Hole	x 2
Compliance	WHQL --- PC2001

Product Overview

This section provides the description of basic aspects of the notebook. It will help you to know more about the appearance of this Notebook before using it. Note the notebook shown here may vary from the actual one.

Top-open View

Press the Cover Latch to open the top cover (LCD Panel). The figure of top-open view and description showing below will lead you to browse the main operating area of your notebook.

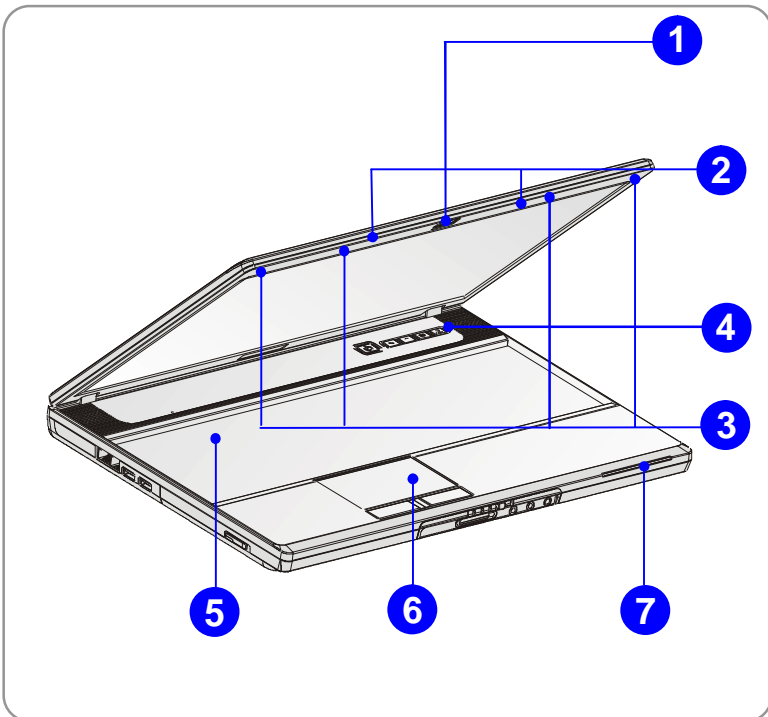

1. Camera (optional, it may vary depending on the model you purchase)

This built-in Camera can be used for picture taking, video recording or conferencing, and any other interactive applications.





2. Cover Latch (Internal View)

It is a bounce-back device to lock the cover with the deck when closing your Notebook.

3. Rubber Pads

Protect your Notebook PC from random closing.

4. Quick Launch Buttons and Power Button

	<p>Power Button: To turn your Notebook power ON and OFF.</p>
<p>Quick Launch Buttons: Simply click the quick launch buttons to speed up the starting of the programs in common use. It helps you to do works more efficiently.</p>	
 E-mail	<p>Press the E-mail Quick Launch Button to launch the E-mail application.</p>
 Internet	<p>Press the Internet Quick Launch Button to activate the Internet browser.</p>
 WLAN & BT	<p>Press the WLAN & BT Quick Launch Button to enable/disable the Wireless LAN or Bluetooth function.</p>

P1

Press the P1 Quick Launch Button to activate the Webcam or Search function. (It may vary depending on the model you purchase.)





5. Keyboard



The built-in keyboard provides all the functions of a full-sized keyboard.

6. Touchpad

It is the pointing device of the computer..

7. Status LED

	<p>Power On/ Off/ Suspend:</p> <ul style="list-style-type: none"> w Blinking blue when the system is in suspend mode. w Glowing blue when the system is activated. w LED goes out when the system is turned off.
	<p>Hard Disk In-use: Glowing blue when the Notebook PC is accessing the hard disk drive.</p>
	<p>Battery:</p> <ul style="list-style-type: none"> w Glowing blue when the battery is being charged. w Glowing Orange when the battery is in low battery status. w Blinking Orange if the battery fails and it is recommended to replace a new battery. w Battery LED goes out when recharging is done or when the AC adapter is disconnected.
	<p>Num Lock: Glowing blue when the Num Lock function is activated.</p>

	Caps Lock: Glowing blue when the Caps Lock function is activated.
	Scroll Lock: Glowing blue when the Scroll Lock function is activated.
	Wireless LAN and Bluetooth: <ul style="list-style-type: none">w Glowing yellow green when wireless LAN function is enabled.w Glowing blue when Bluetooth function of is enabled.w Glowing yellow green and (blue) at the same time when Wireless LAN and Bluetooth function are both enabled.

Front View

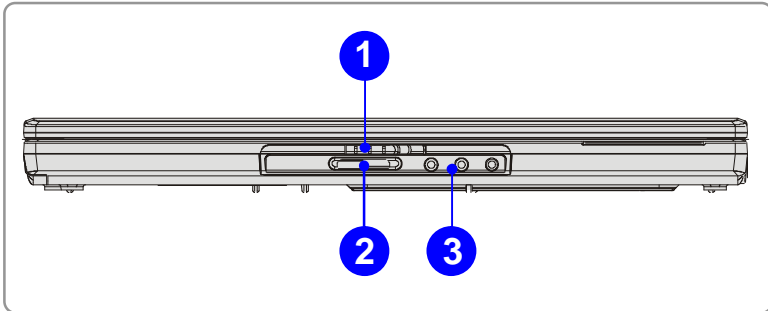

1. Cover Latch (External View)

Press Cover Latch rightward and lift the cover. The Cover Latch will bounce back when loosing it.

2. 4 in 1 Card Reader

The built-in card reader supports MMC (multi-media card), SD (secure digital), MS (memory stick) and MS pro (memory stick pro) cards.

3. Audio Port Connectors

Make high quality sound blaster with stereo system and Hi-Fi function supported.

		<p>Headphone/SPDIF Out: A connector for speakers or headphones.</p>
		<p>Line In: Used for an external audio device.</p>
		<p>Microphone: Used for an external microphone.</p>

Right-side View

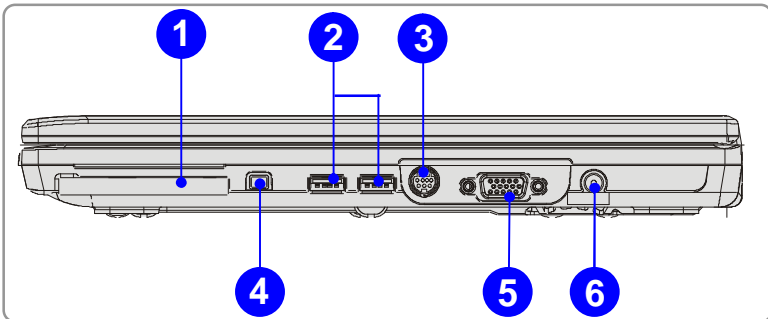

1. PC Card Slot

The computer provides a PC card slot to support one Type-II PC card for expansion functions, such as LAN/WLAN card, modem card, memory card, etc.

2. USB Port

The USB 2.0 port allows you to connect USB-interface peripheral devices, such as the mouse, keyboard, modem, portable hard disk module, printer and more.

3. S-Video Connector

By using a Super VHS (S-Video) cable, this connector allows you to connect a television (NTSC/PAL system) to use as a computer display.

4. IEEE 1394

The IEEE 1394 port is a high-speed bus that allows you to connect high-end digital devices such as the DV (digital video camera).

5. **VGA Port**

The 15-pin-D-sub VGA port allows you to connect an external monitor or other standard VGA-compatible device (such as a projector) for a great view of the computer display.

6. **Power Connector**

To connect the AC adapter and supply power for the computer.

Left-side View

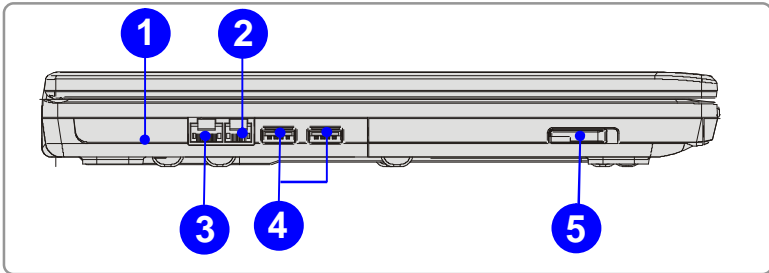

1. Kensington Lock

This port is used to lock the computer to location for security.

2. RJ-11 Connector

The computer provides a built-in modem that allows you to connect an FJ-11 telephone line through this connector. With the 56K V.90 modem, you can make a dial-up connection.

3. RJ-45 Connector

The Ethernet connector is used to connect a LAN cable for network connection.

4. USB Port

5. Optical Storage Device

A slim DVD Combo drive or Super Multi drive (DVD Dual and DVD RAM) or Light scribe drive is available in the computer, depending on the model you purchased. The optical device allows you to use the CD/DVD disc for installing software, accessing data and playing music/movie on the computer. Light scribe function allows users to have brief texts curved on the disks.

Rear View

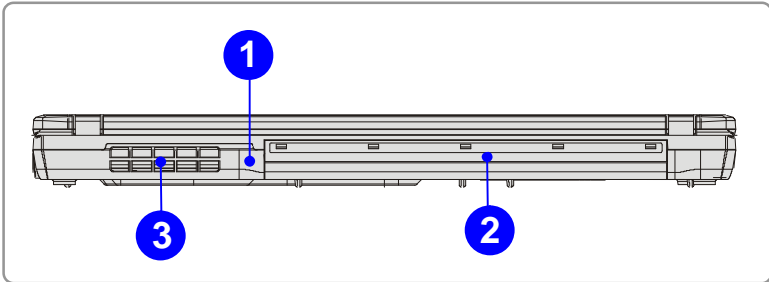

1. Kensington Lock

This port is used to lock the computer to location for security.

2. Battery Pack (Rear View)

Supply power to your computer when the AC adapter is not connected.

3. Ventilator

The ventilator is designed to cool the system. DO NOT block the ventilator for air circulation.

Bottom View

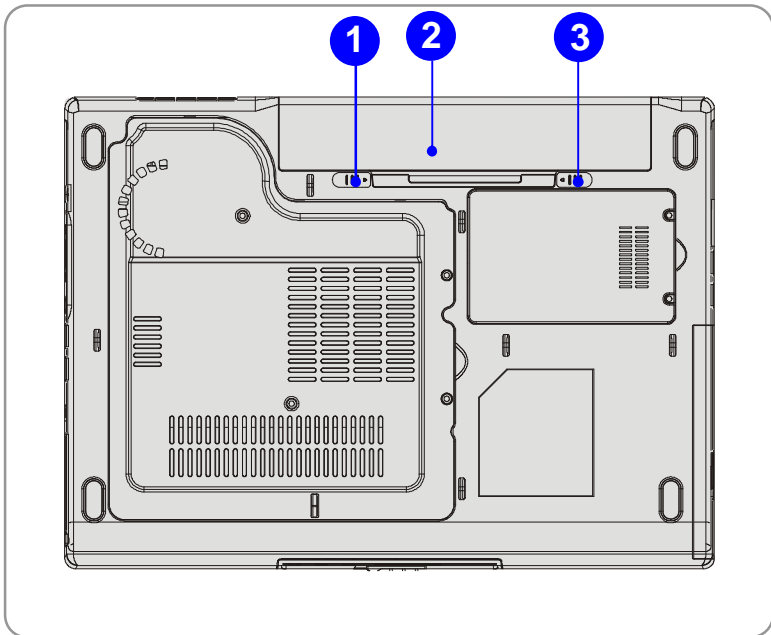

1. Battery Lock/Unlock Button

Battery cannot be moved when the button is positioned on lock status.

Once the button is pushed to unlock position, the battery is removable.

2. Battery Pack

Supply power to your computer when the AC adapter is not connected.

3. Battery Release Button

It is a bounce-back device as a preparation for releasing the battery pack.

Press it with one hand and pull the battery pack carefully with the other.

Power Management

AC Adapter

Please be noted that it is strongly recommended to connect the AC adapter and use the AC power while using this Notebook for the first time. When the AC adapter is connected, the battery is being charged immediately.

NOTE that the AC adapter included in the package is approved for your Notebook; using other adapter model may damage the Notebook or other devices on the Notebook.

Connecting the AC Power

1. Unpack the package to find the AC adapter and power cord.
2. Attach the power cord to the connector of the AC adapter.
3. Plug the DC end of the adapter to the Notebook, and the male end of the power cord to the electrical outlet.

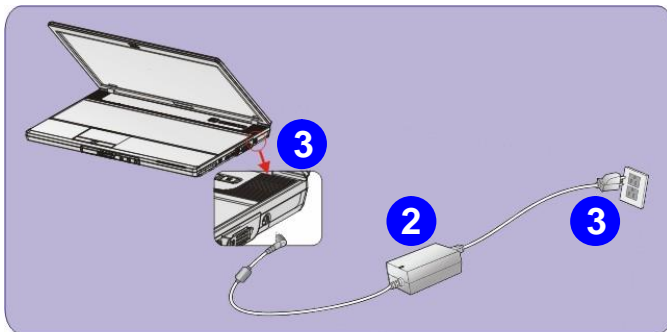

Note: The notebook shown here may vary from the actual one.

Disconnecting the AC Power

When you disconnect the AC adapter, you should:

1. Unplug the power cord from the electrical outlet first.
2. Unplug the connector from the Notebook.
3. Disconnect the power cord and the connector of AC adapter.
4. When unplugging the power cord, always hold the connector part of the cord. Never pull the cord directly!

Battery Pack

This Notebook is equipped with a high-capacity Li-ion Battery pack. The rechargeable Li-ion battery pack is an internal power source of the Notebook.

Releasing the Battery Pack

It's a better way to have extra battery for enough power supply, so you don't have to worry about the lack of battery power. It's recommend to buy a battery pack from your local dealer.

To remove the battery pack:

1. Make sure the Notebook is turned off.
2. Check the Lock/Unlock button is in unlocked status.
3. Locate the Battery Release Button on the bottom side.
4. Push the Release Button to the direction of arrow showing below the button.
5. Slide the left side of the battery pack first out of the compartment and then pull the right side of the battery pack.

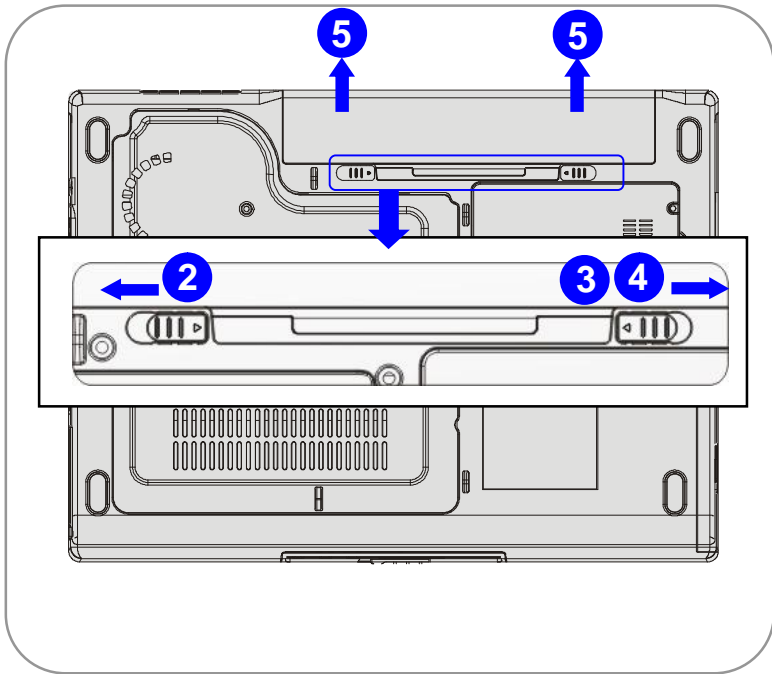

Replacing the Battery Pack

1. Insert the right side of battery pack into the compartment.
2. Slightly slide and press the battery pack into the right place.
3. After the right side of the battery pack fitting the right track, then slightly press the left side of battery pack into the battery chamber.
4. Make sure the Lock/Unlock Button is in lock position.

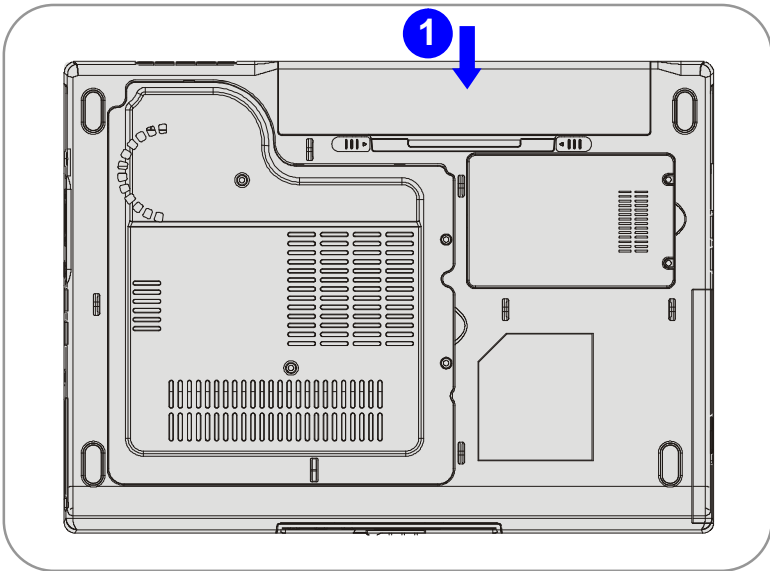

Using the Battery Pack

Battery Safety Tips

Replacing or handling the battery incorrectly may present a risk of fire or explosion, which could cause serious injury.

- w Only replace the main battery pack with the same or equivalent type of battery.
- w Do not disassemble, short-circuit or incinerate batteries or store them to temperatures above +60° C (+140° F).
- w Do not temper with batteries. Keep them away from children.
- w Do not use rusty or damaged batteries.
- w Dispose of batteries according to local regulations. Check with your local solid waste officials for details about recycling options or for proper disposal in your area.

Conserving Battery Power

Efficient battery power is critical to maintain a normal operation. If the battery power is not managed well, the saved data and customized settings may be lost.

Follow these tips to help optimizing battery life and avoid a sudden power loss.

- w Suspend system operation if the system will be idle for a while or shorten the Suspend Timer's time period.
- w Turn off the system if you won't be using it for a period of time.
- w Disable unneeded settings or remove idle peripherals to conserve power.
- w Connect an AC adapter to the system whenever possible.

Charging the Battery Pack

The battery pack can be recharged while it is installed in the Notebook. Please pay attention to the following tips before recharging the battery:

- w If a charged battery pack is not available, save your work and close all running programs and shut down the system or Save-to-Disk.
- w Plug in an external AC/DC power source.
- w You can use the system, suspend system operation or shut down and turn off the system without interrupting the charging process.
- w The battery pack uses Lithium-ion battery cells that have no “memory effect.” You do not need to discharge the battery pack before you begin charging. However, to optimize the life of battery, we suggest that consuming the battery power completely once a month is necessary.
- w If you do not use the Notebook for a long time, it is suggested to remove the battery pack from your Notebook. This may be helpful to extend your battery life.
- w The actual charging time will be determined by the applications in use.



info

Warning

1. Do not try to disassemble THE BATTERY PACK.
2. Please follow your local laws and regulations to recycle the unused battery pack.

Basic Operations

If you are a beginner to the Notebook, please read the following tips to make yourself safe and comfortable during the operations.

Safety and Comfort Tips

The Notebook is a portable platform that allows you to work anywhere. However, choosing a good workspace is important if you have to work with your Notebook for long periods of time.

- w Your work area should have enough illumination.
- w Choose the proper desk and chair and adjust their height to fit your posture when operating.
- w When sitting on the chair and adjust the chair's back (if available) to support your back comfortably.
- w Place you feet flat and naturally on the floor, so that your knees and elbows have the proper position (about 90-degree) when operating.
- w Put your hands on the desk naturally to support your wrists.
- w Adjust the angle/position of the LCD panel, so that you can have the optimal view.
- w Avoid using your Notebook in the space where may cause your discomfort (such as on the bed).
- w The Notebook is an electrical device, please treat it with great care to avoid personal injury.

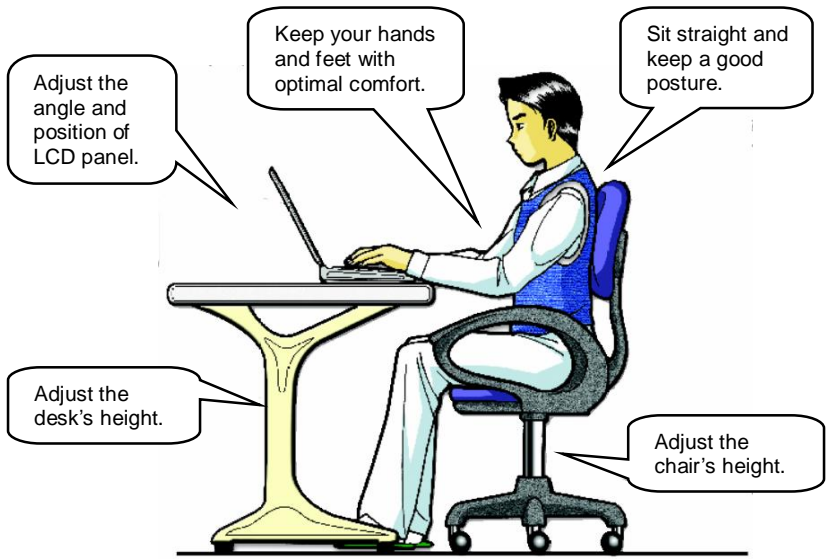

Have a Good Work Habit

Have a good work habit is important if you have to work with your Notebook for long periods of time; otherwise, it may cause discomfort or injury to you. Please keep the following tips in mind when operating.

- w Change your posture frequently.
- w Stretch and exercise you body regularly.
- w Remember to take breaks after working for a period of time.

Knowing the Keyboard

The Notebook's keyboard provides all the functions of a full-sized keyboard and an additional [Fn] key for specific functions on the Notebook. The keyboard can be divided into four categories: **Typewriter keys**, **Cursor keys**, **Numeric keys** and **Function keys**.

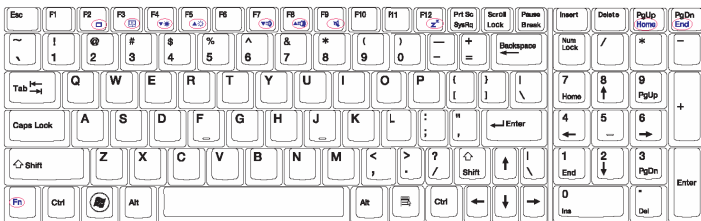

103-Key series

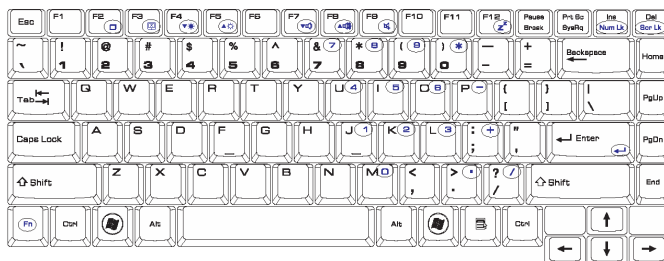

87-Key series

Typewriter Keys

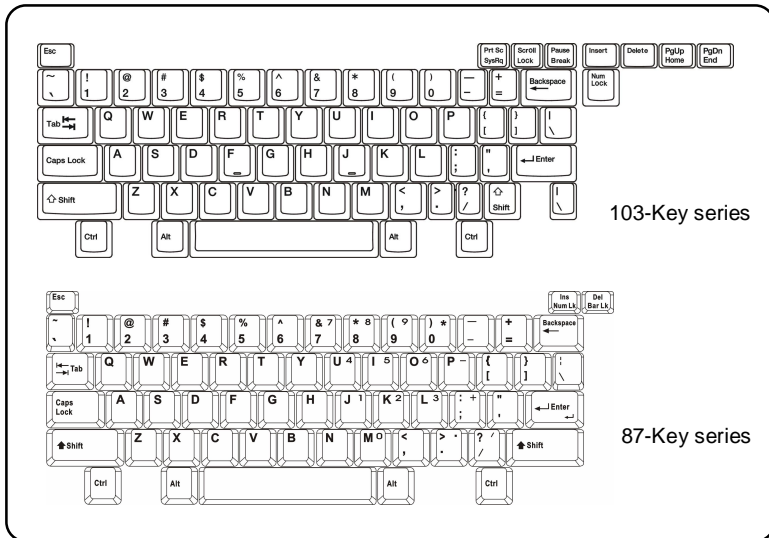

The function of these Typewriter keys is the major function of the keyboard, which is similar to the keys on a typewriter. It also provides several keys for special purposes, such as the **[Ctrl]**, **[Alt]** and **[Esc]** key.

When the lock keys are pressed, the corresponding LEDs will light up to indicate their status:





- n **Num Lock:** Press and hold the [Fn] key and press this key to toggle the Num Lock on and off. When this function is activated, you can use the numeric keys that are embedded in the typewriter keys.
- n **Caps Lock:** Press this key to toggle the Caps Lock on and off. When this function is activated, the letters you type are kept in uppercase.
- n **Scroll Lock:** Press and hold the [Fn] key and press this key to toggle the Scroll Lock on and off. This function is defined by individual programs,



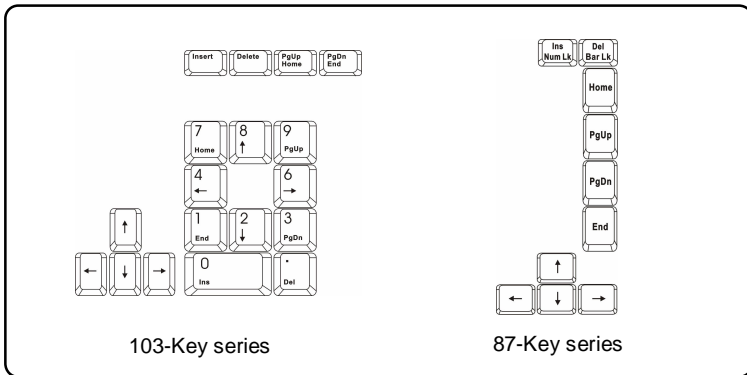



and it is usually used under DOS.

Cursor Keys



The keyboard provides four cursor (arrow) keys and [Home], [PgUp], [PgDn], [End] keys at the lower right corner, which are used to control the cursor movement.



	Move the cursor left for one space.
	Move the cursor right for one space.
	Move the cursor up for one line.
	Move the cursor down for one line.

 + 	Move to the previous page.
 + 	Move to the next page.
	Move to the beginning of the line (or document).
	Move to the end of the line (or document).

The Backspace key, **[Ins]** and **[Del]** keys at upper right corner are use for editing purpose.

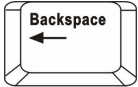
	This key is used to switch the typing mode between “insert” and “overtypе” modes.
	Press this key to delete one character to the right of the cursor and move the following text left for one space.
	Press this key to delete one character to the left of the cursor and move the following text left for one space.

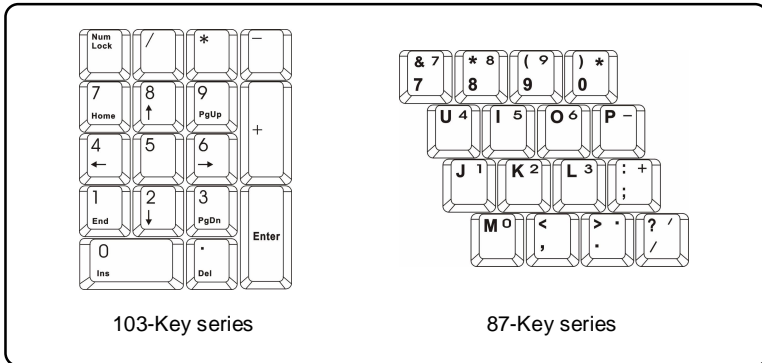

Numeric Keys

The keyboard provides a set of numeric keypad, which is embedded in the typewriter keys. When the Num Lock is activated, you can use these numeric keys to enter numbers and calculations.





Function Keys

n Windows Keys

You can find the Windows Logo key  and one Application Logo key  on the keyboard, which are used to perform Windows-specific functions, such as opening the Start menu and launching the shortcut menu. For more information of the two keys, please refer to your Windows manual or online help.

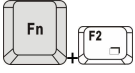
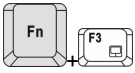
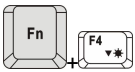
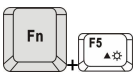
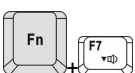
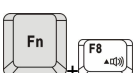
n [Fn] Key

	Switch the display output mode between the LCD, external monitor and Both.
	Enable or disable the touchpad function.
	Decrease the LCD brightness.
	Increase the LCD brightness.
	Decrease the built-in speaker's volume.
	Increase the built-in speaker's volume.
	Disable the computer's audio function.
	Force the computer into suspend mode (depending on the system configuration).

Knowing the Touchpad

The touchpad integrated in your Notebook is a pointing device that is compatible with standard mouse, allowing you to control the Notebook by pointing the location of the cursor on the screen and making selection with its two buttons.

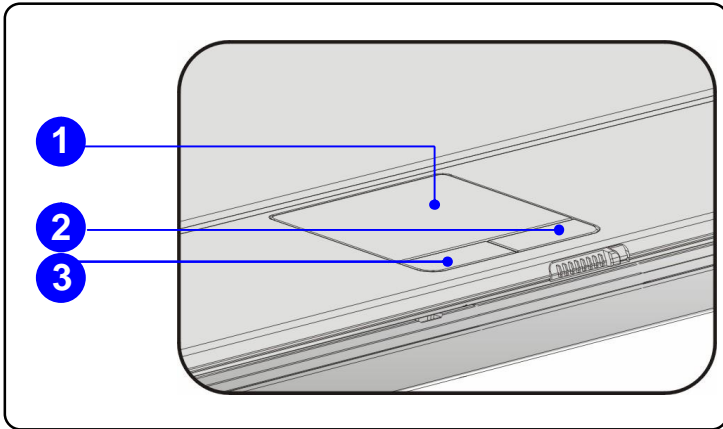

1. Cursor Movement Area

This pressure-sensitive area of the touchpad, allows you to place your finger on it and control the cursor on the screen by moving your finger.

2. Right Button

Acts as the mouse's right button.

3. Left Button

Acts as the mouse's left button.

Using the Touchpad

Read the following description to learn how to use the touchpad:

n Positioning and Moving

Place your finger on the touchpad (usually using the forefinger), and the rectangular pad will act as a miniature duplicate of your display. When you move your fingertip across the pad, the cursor on the screen will move simultaneously in the same direction. When your finger reaches the edge of the pad, lift your finger and replace it on a proper location of the touchpad.

n Point and Click

When you have moved and placed the cursor over an icon, a menu item or a command that you want to execute, simply tap slightly on the touchpad or press the left button to select. This procedure, called as point and click is the basics of operating your Notebook. Unlike the traditional pointing device such as the mouse, the whole touchpad can act as a left button, so that your each tap on the touchpad is equivalent to pressing the left button. Tapping twice more rapidly on the touchpad is to execute a double-click.

n Drag and Drop

You can move files or objects in your Notebook by using drag-and-drop. To do so, place the cursor on the desired item and slightly tap twice on the touchpad, and then keep your fingertip in contact with the touchpad on the second tap. Now, you can drag the selected item to the desired location by moving your finger on the touchpad, and then lift your finger from the touchpad to drop the item into place. Alternately, you can press and hold the left button when you select an item, and then move your finger to the

desired location; finally, release the left button to finish the drag-and-drop operation.

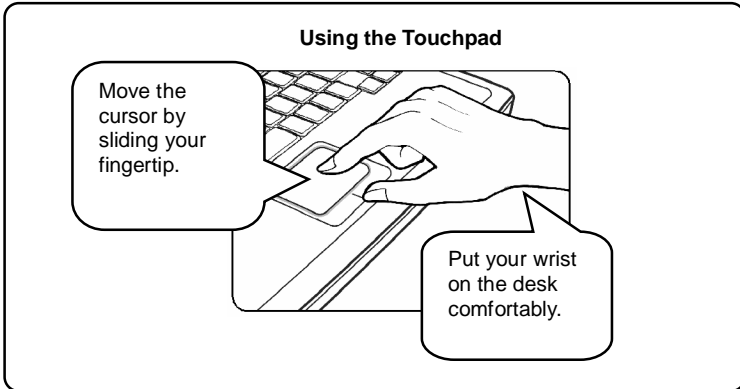

n Configuring the Touchpad

You can customize the pointing device to meet your personal needs. For example, if you are a left-hand user, you may want to swap the functions of the two buttons. In addition, you can change the size, shape, moving speed and other advanced features of the cursor on the screen.

To configure the touchpad, you can use the standard Microsoft or IBM PS/2 driver in your Windows operating system. The **Mouse Properties** in **Control Panel** allows you to change the configuration.

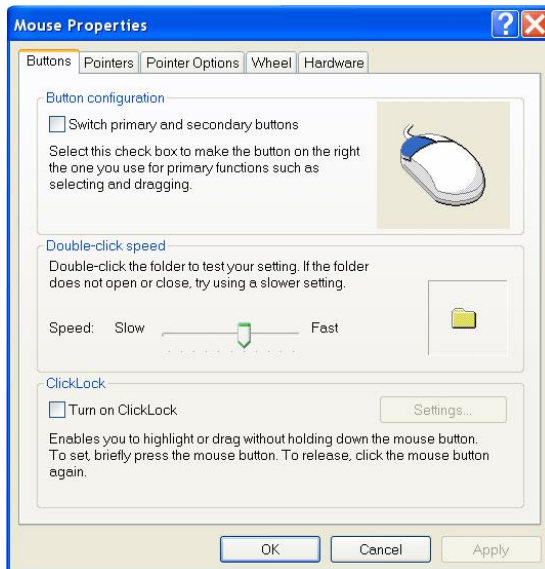

Mouse Properties Window

About Hard Disk Drive

Your Notebook is equipped with a 2.5-inch hard disk drive. The hard disk drive is a storage device with much higher speed and larger capacity than other storage devices, such as the floppy disk drive and optical storage devices. Therefore, it is usually used to install the operating system and software applications.



1. To avoid unexpected data loss in your system, please backup your critical files regularly.
2. Do not turn off the Notebook when the Hard Disk In-use LED is on.
3. Do not remove or install the hard disk drive when the Notebook is turned on. The replacement of hard disk drive should be done by an authorized retailer or service representative.

Using the Optical Device Drive

Your Notebook is equipped with an optical device drive. The actual device installed in your Notebook depends on the model you purchased.

- n **DVD Combo Drive:** This device allows you to read DVD and CD, and record CD format.
- n **Super Multi:** Works as a multi-functional DVD Dual Drive and a DVD RAM Drive.
- n **Light scribe:** Allows users to have brief texts curved on the obverse side of the disks with the laser read/write head of the Optical Device Drive.



1. The optical device drives are classified as a Class 1 Laser products. Use of controls or adjustments or performance of procedures other than those specified here in may result in hazardous radiation exposure.
2. Do not touch the lens inside the drive.

Inserting the Disk

The following instruction describes the general procedure when operating the optical storage device.

1. Confirm that the Notebook is turned on.
2. Press the Eject Button on the drive's panel and the disk tray will slide out partially. Then, gently pull the tray out until fully extended.
3. Place your disk in the tray with its label facing up. Slightly press the center of the disk to secure it into place.
4. Push the tray back into the drive.

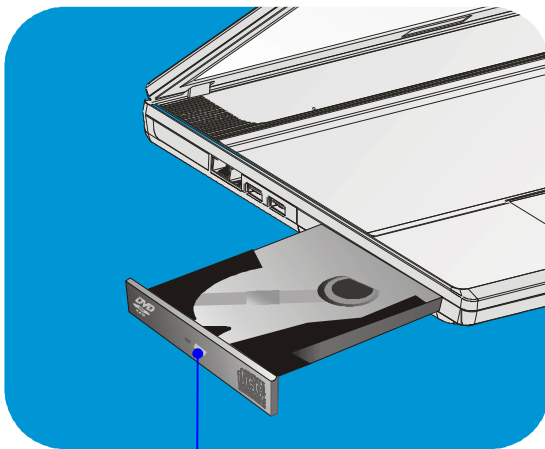

Eject Button

Removing the disk

1. Press the Eject Button on the drive's panel and the disk tray will slide out partially. Then, gently pull the tray out until fully extended.
2. Hold the disk by its edge with your fingers and lift it up from the tray.
3. Push the tray back into the drive.



info

1. Confirm that the disk is placed correctly and securely in the tray before closing the tray.
2. Do not leave the disk tray open.

	Preface
Chapter 1	General Introductions
Chapter 2	Getting Started
Chapter 3	Customizing this Notebook
Chapter 4	BIOS setup



Connecting the External Devices

The I/O (input/output) ports on the Notebook allow you to connect peripheral devices. All devices listed here are for reference only.

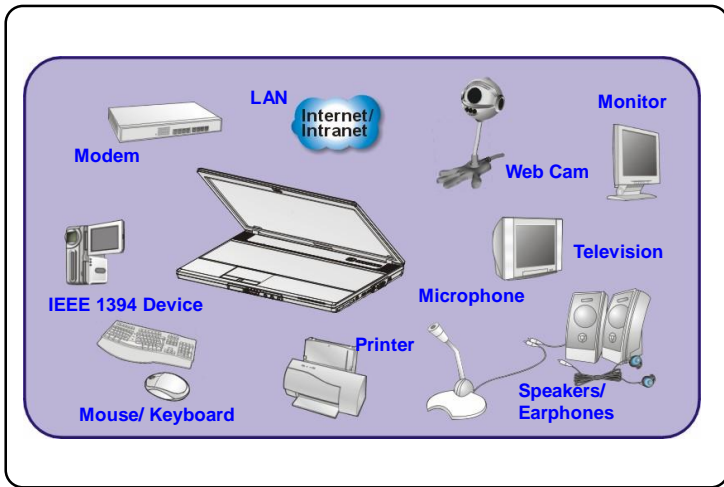

Note: The notebook shown here may vary from the actual one.

Connecting the Peripheral Devices

Connecting the Mouse

You can connect a mouse to your Notebook through the USB port. To connect the mouse:

1. Turn on the Notebook and install the mouse driver.
2. Connect your mouse to the Notebook.
3. The Notebook may auto detect your mouse driver and enable the mouse function. If there is no detection of you mouse you can manually enable the mouse by going to **Start Menu à Control Panel à Add Hardware** to add the new device.

Connecting the Keyboard

You can connect a keyboard to your Notebook through the USB port. To connect the keyboard:

1. Turn on the Notebook and install the keyboard driver.
2. Connect your keyboard to the Notebook.
3. The Notebook may auto detect your keyboard driver and enable the keyboard function. If there is no detection of you keyboard you can manually enable the keyboard by going to **Start Menu à Control Panel à Add Hardware** to add the new device.

Connecting the WebCam

You can connect a WebCam to your Notebook through the USB port. To connect the WebCam:

1. Turn on the Notebook and install the WebCam driver.
2. Connect your WebCam to the Notebook.
3. The Notebook may auto detect your WebCam driver and enable the WebCam function. If there is no detection of you WebCam you can manually enable the WebCam by going to **Start Menu à Control Panel à Add Hardware** to add the new device.

Connecting the Printer

If your printer has a USB interface, you can then use the USB port on the Notebook to connect the printer. The following instruction describes the general procedure to connect a printer:

1. Turn off the Notebook.
2. Connect one end of the printer cable to the Notebook's USB port and the other end to the printer.
3. Connect the power cord and turn on the printer.
4. Turn on the Notebook and the system will detect a new device. Install the required driver.

For further instructions, please refer to your printer's manual.

Connecting the External Monitor or TV

You can connect an external monitor to your Notebook through the VGA port for a larger view with higher resolution. To connect the monitor:

1. Make sure that the Notebook is turned off.

2. Plug the monitor's D-type connector into the Notebook's VGA port.
3. Connect the monitor's power cord and turn on the monitor.
4. Turn on the Notebook and the monitor should respond by default. If not, you can switch the display mode by pressing **[Fn]+[F2]**. Alternately, you can change the display mode by configuring the settings in **Display Properties** of Windows operating system.

Connecting the IEEE 1394 devices

The IEEE 1394 port of your Notebook is a next-generation serial bus that features a high-speed transfer rate and the connection of up to 63 devices, allowing you to connect many high-end peripheral devices and consumer electronic appliances, such as the DV (digital video camera). The IEEE 1394 standard interface supports "**plug-and-play**" technology, so that you can connect and remove the IEEE 1394 devices without turning off the Notebook.

To connect the IEEE 1394 device, simply connect the cable of the device to the IEEE 1394 port of your Notebook.

Connecting the Communication Devices

Using the LAN

The RJ-45 connector of the Notebook allows you to connect the LAN (local area network) devices, such as a hub, switch and gateway, to build a network connection. This built-in 10/100/1000 Base-T LAN module supports data transfer rate up to 1000 mega bit per second.

For more instructions or detailed steps on connecting to the LAN, please ask your MIS staff or network manager for help.

Using the Modem or Combo Modem

The built-in 56Kbps fax/data modem or Combo Modem (with built-in Bluetooth function) allows you to use a telephone line to communicate with others or to dial-up to connect the Internet.

For more instructions or detailed steps on dialing-up through the modem, please consult your MIS staff or Internet service provider (ISP) for help.



info

1. To reduce the risk of fire, use only No. 26 AWG or larger telecommunication lone cord.
2. You are strongly recommended to install the modem driver included in the software disk of your Notebook to take full advantage of the modem feature.

PC Card Installation

The PC card slot of your Notebook allows you to install comprehensive Type-II PC cards that support various functions for your necessary, including the LAN/WLAN card, modem card, and memory card.

The following instruction provides you with a basic installation for the PC card, including how to install and remove it. For more information, please refer to the manual of your PC card.

Installing the PC Card

1. Locate the PC card slot on your notebook. If there is the dummy card in the slot, remove it first.
2. Insert the PC card into the slot (usually with its label facing up) and push it until it is firmly seated.

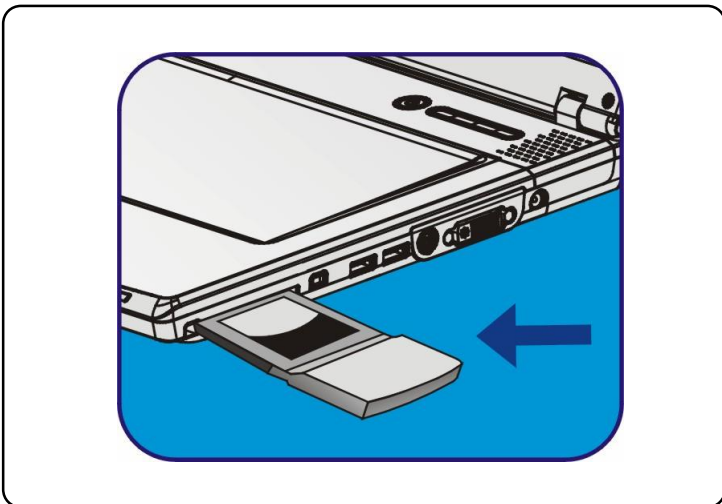

Removing the PC Card

1. Press the Eject Button to make it stretch out.
2. Push the Eject Button and the PC card will slide out. Pull it out of the slot.
3. Reattach the dummy card back to the slot.

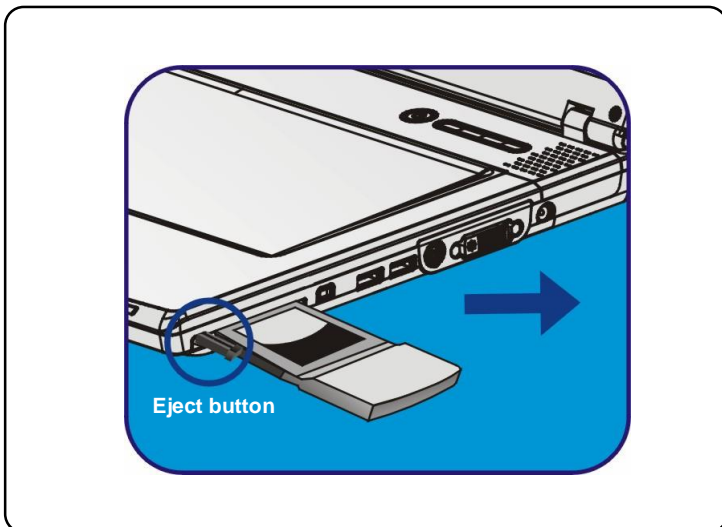

info

1. Do not hold the "golden finger" when installing the PC card; otherwise, it may cause interference or damage to the PC card.
2. Before removing the PC card, you should stop the device in Windows operating system.

Safely Remove Hardware

If you connect any peripheral device to your system, the **Safely Remove Hardware** icon  will appear on the taskbar. Double-click the icon to bring up the Safely Remove Hardware dialog box. You can see all connected peripheral devices here. If you want to remove any of the devices, move the cursor to the device and click **Stop**.

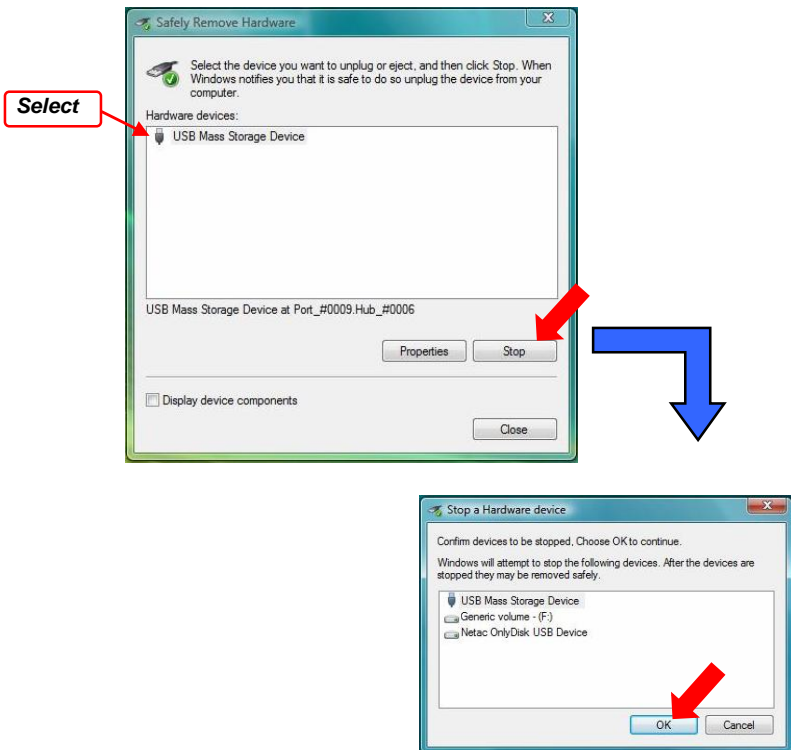

	Preface
Chapter 1	General Introductions
Chapter 2	Getting Started
Chapter 3	Customizing this Notebook
Chapter 4	BIOS setup



About BIOS Setup

When to Use BIOS Setup?

You may need to run the BIOS Setup when:

- w An error message appears on the screen during the system booting up and requests you to run SETUP.
- w You want to change the default settings for customized features.
- w You want to reload the default BIOS settings.

How to Run BIOS Setup?

To run the BIOS Setup Utility, turn on the Notebook and press the [Del] key during the POST procedure.

If the message disappears before you respond and you still wish to enter Setup, restart the system by turning it OFF and ON, or simultaneously pressing [Ctrl]+[Alt]+[Delete] keys to restart.













info

The screen snaps and setting options in this chapter are for your references only. The actual setting screens and options on your Notebook may be different because of BIOS update.

Control Keys

You can use only the keyboard to control the cursor in the BIOS Setup Utility.

	Press left arrow to select one menu title.
	Press right arrow to select one menu title.
	Press up arrow to select one item under the menu title.
	Press down arrow to select one item under the menu title.
	Increase the setting value or make changes.
	Decrease the setting value or make changes.
	<ol style="list-style-type: none"> 1) Open the selected item to change setting options. 2) Bring up a sub-menu when available.
	In some items, press this key to change setting field.
	Bring up help screen providing the information of control keys.
	<ol style="list-style-type: none"> 1) Exit the BIOS Setup Utility. 2) Return to the previous screen in a sub-menu.

BIOS Setup Menu

Once you enter the BIOS Setup Utility, the Main menu will appear on the screen.

The Main menu displays the system information, including the basic configuration.

1636 Series



1637 Series

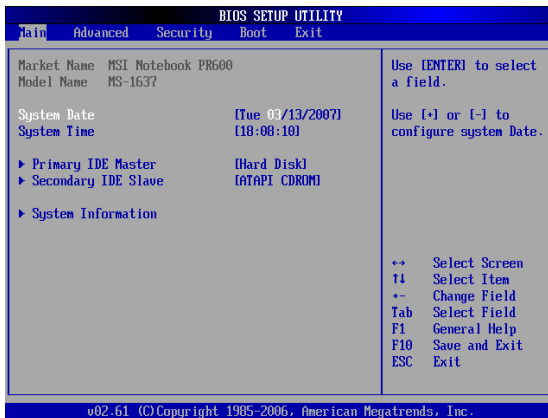

163C Series

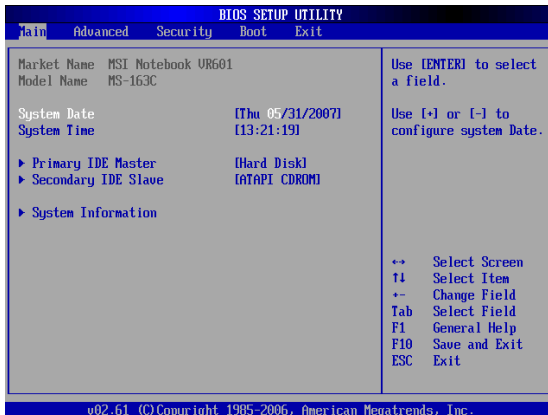

Main menu

Show System Overview information about BIOS version, CPU features, Memory size and setting of System Time and Date.

Advanced menu

Configure IDE and USB settings.

Boot menu

Set up Boot Type and Boot Sequence.

Security menu

Install or clear Supervisor's and User's Password settings.

Exit menu

Choose decided status before leaving the BIOS menu.

Main menu

1636 Series

BIOS SETUP UTILITY				
Main	Advanced	Security	Boot	Exit
Market Name	MSI Notebook EX600 EX601		Use [ENTER] to select a field.	
Model Name	MS-1636X			
System Date	[Tue 02/06/2007]		Use [+] or [-] to configure system Date.	
System Time	[19:20:57]			
▶ Serial-ATA	[Hard Disk]			
▶ Secondary IDE Slave	[Not Detected]			
▶ System Information				
			++ Select Screen ↑ Select Item -- Change Field Tab Select Field F1 General Help F10 Save and Exit ESC Exit	
v02.61 (C) Copyright 1985-2006, American Megatrends, Inc.				

1637 Series

BIOS SETUP UTILITY				
Main	Advanced	Security	Boot	Exit
Market Name	MSI Notebook PR600		Use [ENTER] to select a field.	
Model Name	MS-1637			
System Date	[Tue 03/13/2007]		Use [+] or [-] to configure system Date.	
System Time	[18:08:10]			
▶ Primary IDE Master	[Hard Disk]			
▶ Secondary IDE Slave	[ATAPI CDROM]			
▶ System Information				
			↔ Select Screen ↑ Select Item -- Change Field Tab Select Field F1 General Help F10 Save and Exit ESC Exit	
v02.61 (C) Copyright 1985-2006, American Megatrends, Inc.				

163C Series**System Overview**

System Overview will show you BIOS version and other information about its build date and update notes. Following is CPU's information about its Type and Speed.

w System Time

This item allows you to set the system time. The system clock will go on no matter you shut down the PC or get into sleep mode. The set format is [hour:minute:second].

w System Date

This item allows you to set the system date. The date format is [day:month:date:year].

Day Day of the week, from Sun to Sat, which is determined by BIOS (read-only).

Month The month from 01 (January) to 12 (December).

Date The date from 01 to 31.

Year The year can be adjusted by users.

w Primary/Secondary IDE Master/Slave

The two items display the types of the primary/secondary IDE master/slave devices installed in the Notebook. Press [Enter] to bring up a window showing the detailed information of the device, including the device name, vendor, LBA mode, PIO mode and more.

w System Information

This item indicates the information of firmware, processor, and system memory.

Advanced menu

1636 Series

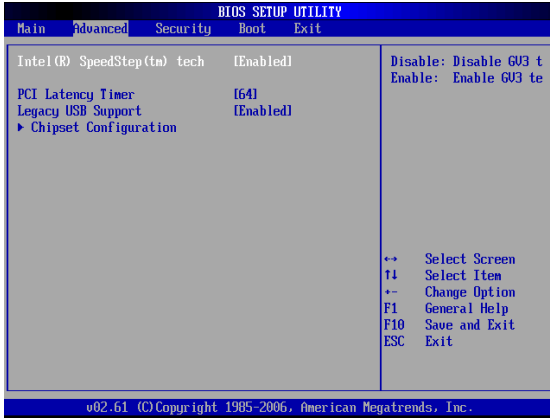

1637/163C Series

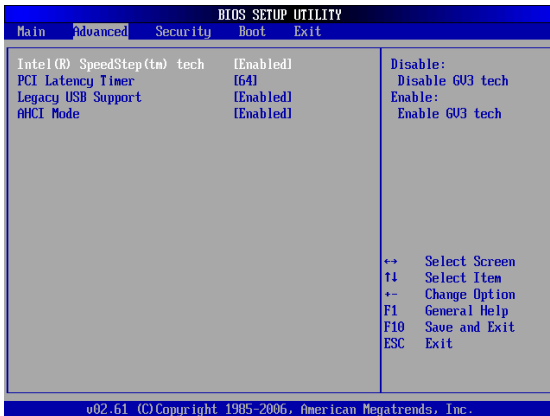

Advanced Settings

w **Intel(R) SpeedStep(tm) tech.**

This item allows you to enable or disable Intel SpeedStep technology. When set to **Disabled**, the system always operates in a conserve power mode (the processor works at FSB400-600MHz or FSB533-800MHz). If you want optimize the processor, set this item to **Enabled**, so that the processor's speed will be controlled by the use of your operating system and applications. Setting options: **Enabled**, and **Disabled**.

w **PCI Latency Timer**

Value in units of PCI clocks for PCI device latency timer register.

w **Legacy USB Support**

Select **Enabled** to enable the legacy support for USB devices. Setting options: **Enabled**, and **Disabled**.

w **Chipset Configuration**

This item allows you to enable automatically or disable HD audio Azalia device.

w **AHCI Mode**

This item allows you to enable/disable AHCI mode.

Security menu

1636/1637/163C Series

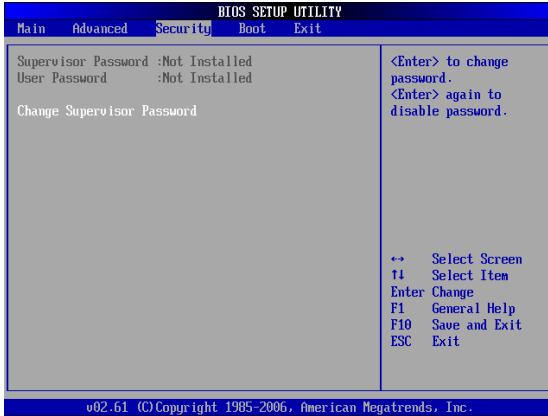

Security Settings

w Change Supervisor/User Password

When you select the function, a message box will appear on the screen as below:

Enter New Password

Type the password *you* want, up to six characters in length and press [Enter]. The password typed now will replace any previously set password from CMOS memory. You may also press [ESC] to abort the selection and not enter a password.

When the Supervisor Password is set, the new item **User Access Level** and **Password Check** will be added in the menu. You can make further settings of access right in the **User Access Level** item. Setting options: **No Access, View Only, Limited** and **Full Access**. The Password Check item is used to specify the type of BIOS password protection that is implemented. Settings are described below:

Setup The password prompt appears only when end users try to run Setup.

Always A password prompt appears every time when the Notebook is powered on or when end users try to run Setup.

To clear a set password, just press [Enter] when you are prompted to enter the password. A message box will show up confirming the password will be disabled. Once the password is disabled, the system will boot and you can enter Setup without entering any password.



info

About Supervisor Password and User Password

Supervisor Password allows the user to enter and change the settings of the setup menu; User Password only allows the user to enter the setup menu, but do not have the right to make changes.

Exit menu

1636/1637/163C Series

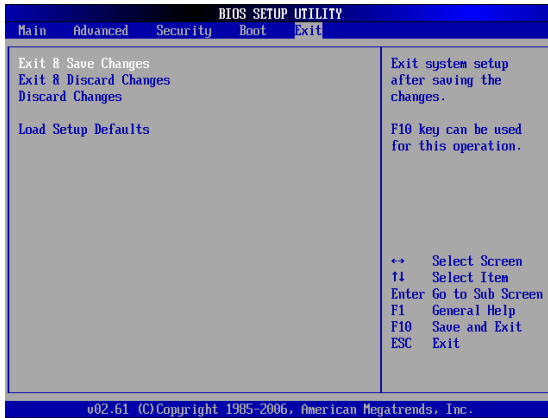

w Exit & Save Changes

Save the changes you have made and exit the utility.

w Exit & Discard Changes

Exit the utility without saving the changes you have made.

w Discard Changes

Abandon your changes and reload the previous configuration before running the utility.

w Load Setup Defaults

Select this item to load the default settings for optimal system performance.

Free Manuals Download Website

<http://myh66.com>

<http://usermanuals.us>

<http://www.somanuals.com>

<http://www.4manuals.cc>

<http://www.manual-lib.com>

<http://www.404manual.com>

<http://www.luxmanual.com>

<http://aubethermostatmanual.com>

Golf course search by state

<http://golfingnear.com>

Email search by domain

<http://emailbydomain.com>

Auto manuals search

<http://auto.somanuals.com>

TV manuals search

<http://tv.somanuals.com>