

.50

OWNER'S GUIDE

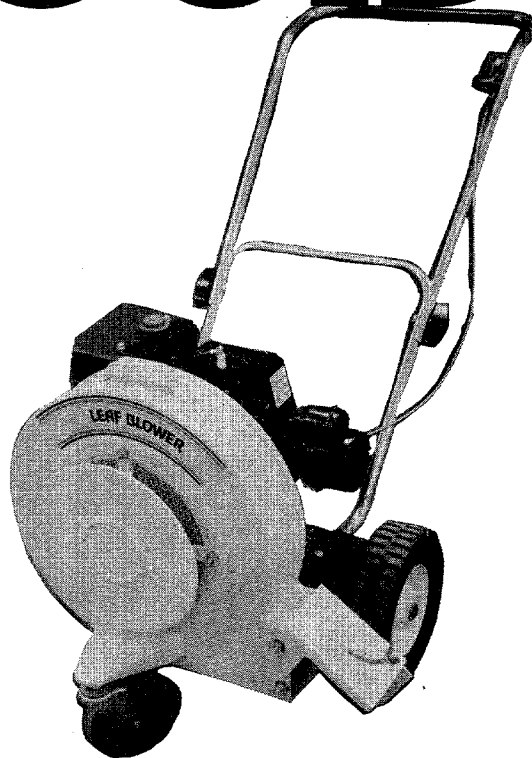

**ASSEMBLY
OPERATION
MAINTENANCE
PARTS LIST**

**IMPORTANT:
Read Safety Rules
and Instructions**

**MODEL NUMBERS
240-688A
240-690A**

LEAF BLOWERS

INDEX

Safe Operation Practices	3	Off-Season Storage	7
Assembly Instructions	4	Illustrated Parts	8
Operation	6	Parts List	9
Adjustments	6	Parts Information	Back Cover
Maintenance and Lubrication	7		

LIMITED WARRANTY

For one year from the date of original retail purchase, MTD PRODUCTS INC will either repair or replace, at its option, free of charge, F.O.B. factory or authorized service firm, any part or parts found to be defective in material or workmanship. Transportation charges under this warranty must be paid by the purchaser unless return is requested by MTD PRODUCTS INC.

This warranty will not apply to any part which has become inoperative due to misuse, excessive use, accident, neglect, improper maintenance, alterations, or unless the unit has been operated and maintained in accordance with the instructions furnished. This warranty does not apply to the engine, motor, battery, battery charger or component parts thereof. Please refer to the applicable manufacturer's warranty on these items.

This warranty will not apply where the unit has been used commercially.

Warranty service is available through your local authorized service dealer or distributor. If you do not know the dealer or distributor in your area, please write to the Customer Service Department of MTD.

This warranty gives you specific legal rights. You may also have other rights which vary from state to state.

WARNING TO PURCHASERS OF INTERNAL COMBUSTION ENGINE EQUIPPED MACHINERY OR DEVICES IN THE STATE OF CALIFORNIA

The equipment which you have just purchased does not have a spark arrester. If this equipment is used on any forest covered land, brush covered land, or grass covered unimproved land in the State of California, before using on such land, the California law requires that a spark arrester be provided. In addition, spark arrester is required by law to be in effective working order. The spark arrester must be attached to the exhaust system and comply with Section 442 of the California Public Resources Code.

IMPORTANT

It is suggested that this manual be read in its entirety before attempting to assemble or operate. Keep this manual in a safe place for future reference and for ordering replacement parts.

This unit is shipped **WITHOUT GASOLINE** or **OIL**. After assembly, see operating section of this manual for proper fuel and amount.

SAFE OPERATION PRACTICES FOR LEAF BLOWERS

1. Read the operating and service instructing manual carefully. Be thoroughly familiar with the controls and proper use of the Power Leaf Blower.
2. Never allow children to operate this power Leaf Blower.
3. Keep the area of operation clear of all persons, particularly small children and pets.
4. Check fuel before starting engine. Do Not fill fuel tank indoors, when engine is running, or while engine is hot. Wipe off any spilled fuel before starting engine.
5. Do Not change engine governor settings.
6. Do Not put hands near rotating parts for any reason.
7. If the power Leaf Blower should start to vibrate abnormally, stop the engine and check immediately for the cause. Vibration is generally a warning of trouble.
8. Before cleaning, repairing or inspecting make certain all moving parts have come to a complete stop. Disconnect spark plug wire and keep wire away from plug to prevent accidental starting. Also keep throttle control lever in the stop position.
9. If the power Leaf Blower should become blocked with debris at any point shut engine off and wait until the impeller comes to a complete stop before attempting to remove the obstruction. Disconnect spark plug wire to prevent accidental starting.
10. Check all bolts for tightness at frequent periods.
11. Never store this power Leaf Blower with fuel in the tank. Allow engine to cool before starting in any enclosure.
12. Keep equipment free of debris when not in use.
13. Never operate this Leaf Blower unless impeller guard and guard assembly are properly affixed in their place.
14. Never change inlet nozzle or auxiliary hose attachment when engine is running.
15. The manufacturer recommends that the operator wear safety glasses or some other suitable eye protection when operating this machine.
16. Exercise caution whenever operating Leaf Blower. Do Not allow exhaust to be pointed in the persons.

PRE-ASSEMBLY



The right and left side of your Leaf Blower is determined from operator's position.

Before any step is undertaken, the instructions for that step should be read through.

TOOLS REQUIRED:

- A. (1) 5/16" wrench
- B. (1) 3/8" wrench
- C. (2) 1/2" wrenches

MATERIALS REQUIRED:

- 1. Funnel (for gas and oil—NOTE: Do not mix).
- 2. S.A.E. 30 Oil — 1-1/4 pints.
- 3. Gas (regular).
- 4. Cleaning rag.

PARTS IN CARTON

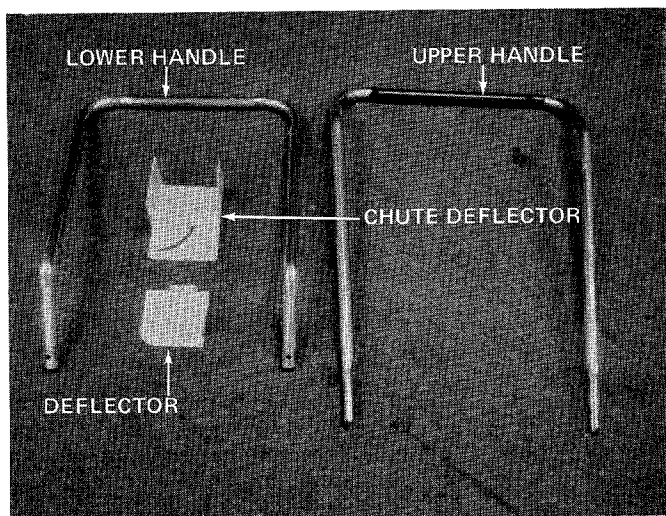

FIGURE 1



The letters listed below will be referred to throughout the following text for easier hardware identification.

LIST OF CONTENTS IN HARDWARE PACK: (See figure 2)

- A. (2) Hand Knobs
- B. (2) Curved Head Bolts
- C. (2) Hex Screws 5/16-18 x 1.25" Lg.
- D. (2) Lockwashers for 5/16" Bolts
- E. (2) Hex Nuts 5/16-18 Thread
- F. (5) Wing Nuts
- G. (5) Flat Washers
- H. (2) Hex Screws #10-32 x 1.25" Lg.
- I. (2) Hex Lock Nuts #10-32 Thread
- J. (1) Carriage Bolt 1/4-20 x .62" Lg.
- K. (1) Cable Tie

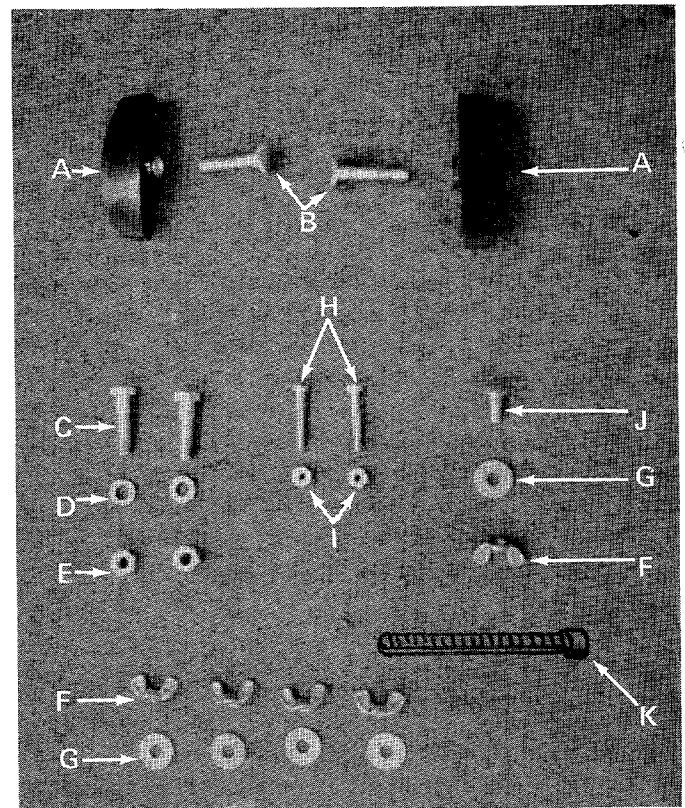

FIGURE 2

ASSEMBLY INSTRUCTIONS

- 1. Remove the Leaf Blower, hardware pack and all literature from the carton before discarding carton.

- Place the lower handle into holes located in rear of Leaf Blower Frame.
- Secure lower handle to frame with two hex screws (C), lock washers (D) and hex nuts (E). See figure 3. Two 1/2" wrenches are required.

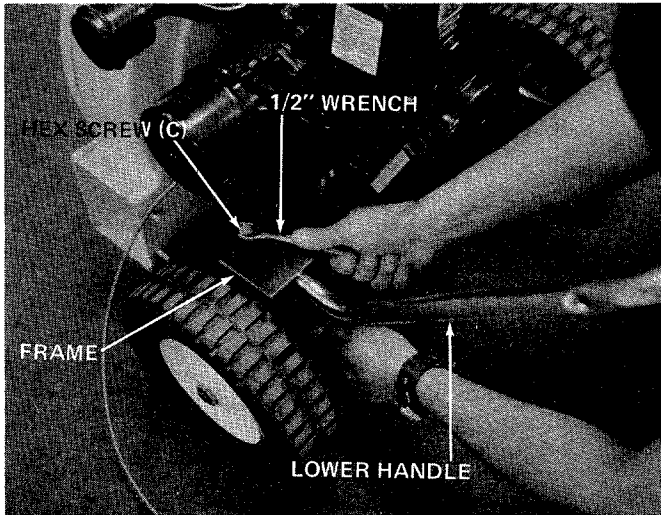

FIGURE 3

- Place the throttle control to the inside of upper handle as shown in figure 5. Secure with hex screws (H) and lock nuts (I). A 3/8" wrench and a 5/16" wrench is required. Tighten securely.

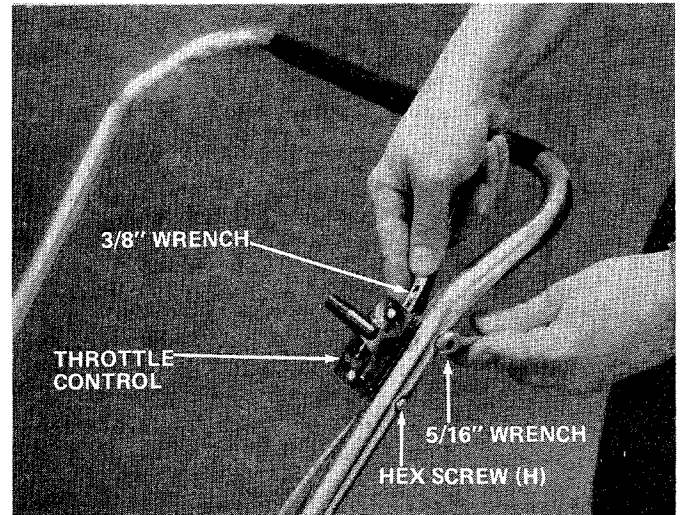

FIGURE 5

- Place the upper handle over the lower handle, lining up the holes. Secure with curved head bolts (B) and hand knobs (A). See figure 4.

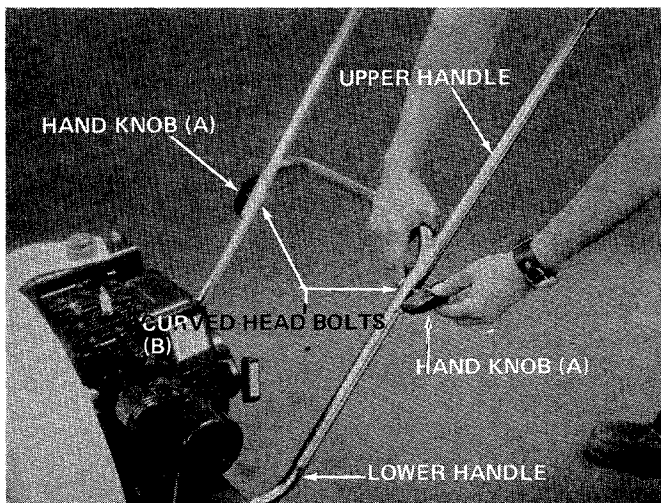

FIGURE 4

- Secure throttle control cable to handle with cable tie (K) provided in hardware pack.
- Pre-assemble the chute deflector and deflector. Slide tab on deflector into slot on chute deflector. Secure deflector to chute deflector with carriage bolt (J), flat washer (G) and wing nut (F). See figure 6.

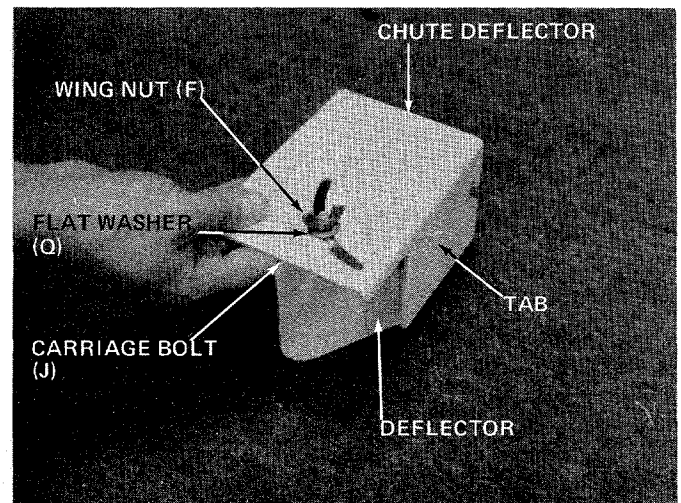

FIGURE 6

- Place the pre-assembled chute deflector on the blower housing. See figure 7. Secure in place with four flat washers (G) and wing nuts (F).

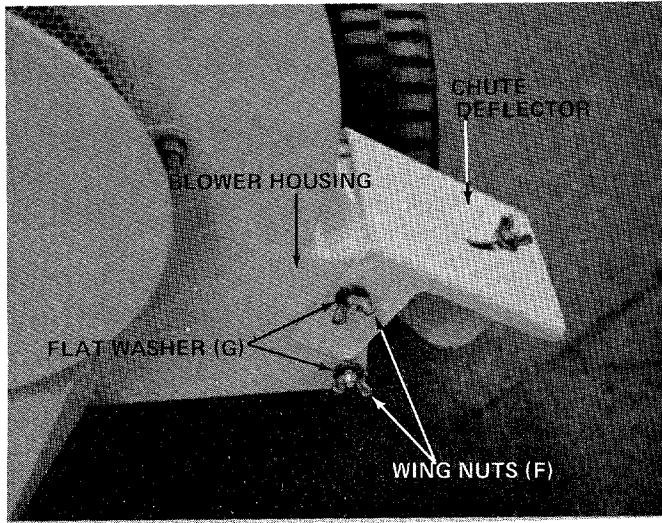

FIGURE 7

OPERATION

BEFORE STARTING ENGINE

- Remove oil fill plug and fill crankcase with 1-1/4 pints S.A.E. No. 30 oil. See figure 8.
- Clean fuel tank with good grade regular, clean, fresh gasoline. DO NOT MIX OIL WITH GASOLINE. FOR COMPLETE ENGINE INFORMATION, READ ENGINE INSTRUCTION BOOKLET BEFORE STARTING OR OPERATING.

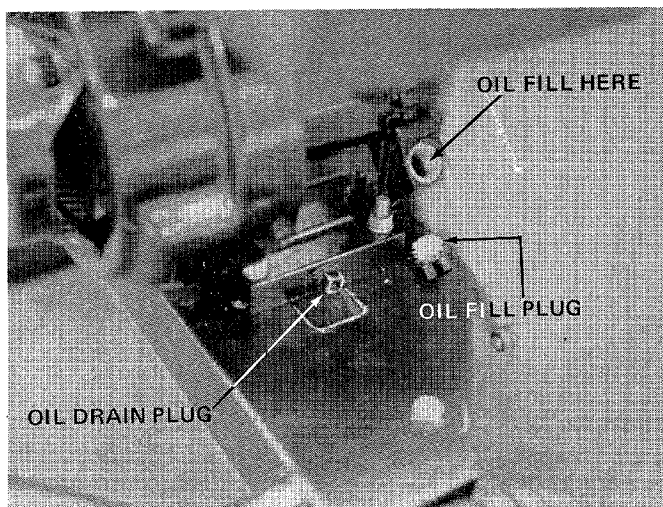
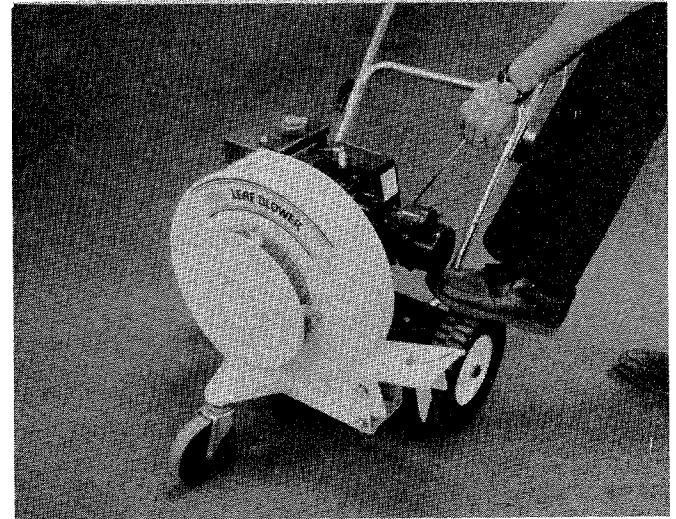

FIGURE 8

TO START ENGINE

- Move throttle to start position.
- Pull starter rope once with quick, full stroke. Move hand throttle to fast position and pull starter rope again. See figure 9.
- When engine starts, move throttle to "RUN" position until engine warms up.



TO STOP ENGINE

Move throttle control lever to "OFF" position.

ADJUSTMENTS



Do Not make this adjustment or any adjustment with the engine running. Stop the engine, disconnect the spark plug wire and ground plug wire to engine block.

TWO-WAY AIR DISCHARGE

Your Leaf Blower is equipped with an adjustable chute deflector. Simply loosen two wing nuts at each side of deflector to raise or lower. You also can direct the air by loosening the wing nut on top and moving the deflector from side to side. See figure 10.

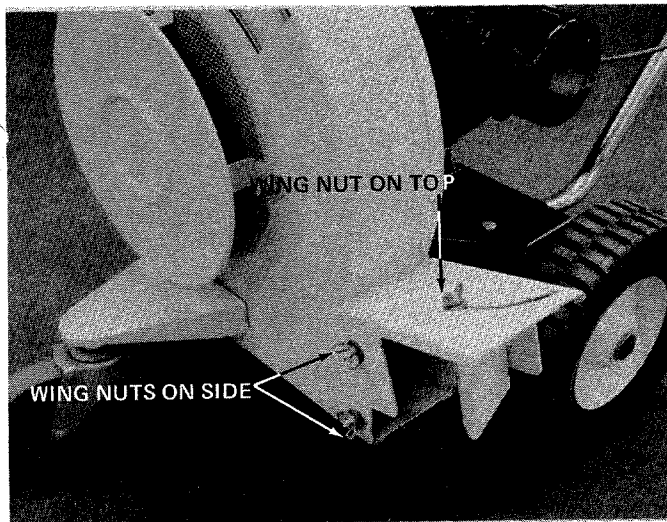

FIGURE 10

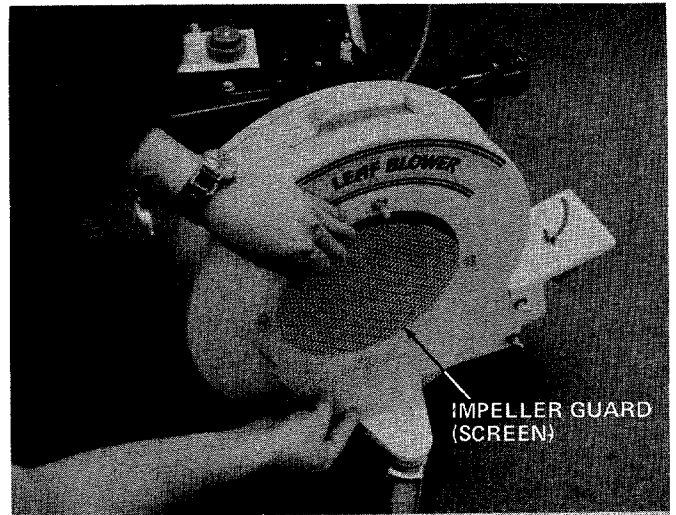

FIGURE 12

USE OF OPTIONAL EQUIPMENT

If you use optional equipment (such as inlet nozzle or auxiliary hose) proceed as follows.



Do Not make any adjustment with the engine running. Stop the engine, disconnect the spark plug wire and ground plug wire to engine block.

1. Remove the guard assembly by removing four hex nuts and lock washers. See figure 11.
2. Lift off impeller guard (screen). See figure 12.
3. Whenever attachments are removed, guard assembly and impeller guard (screen) **Must Be** reassembled.

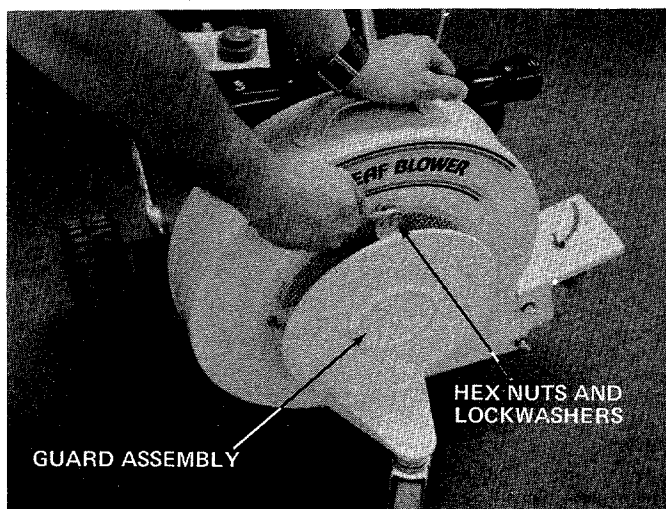

FIGURE 11

MAINTENANCE AND LUBRICATION

Your Leaf Blower, like all machines with moving parts, must receive care and maintenance. The following tips, if used, will contribute many trouble-free hours to your blower.

1. Check oil level frequently. When changing oil, make sure dirt and debris is cleaned off oil sump before removing oil plug.
2. Keep blower clean, especially the engine, and engine air filter.
3. Check all nuts, bolts and screws occasionally to be sure blower is in good operating condition.
4. The wheel bearings are pre-lubricated at the factory and should require no further attention until blower is serviced. However, it is advisable to remove the wheels and apply a small amount of light oil to each axle, at least once a season.

OFF-SEASON STORAGE

If you are going to store your blower for any length of time (30 days or longer), it is important that the following steps be taken:

1. Drain the gas tank. Start the engine. Allow it to run out of gas. Gasoline left in the engine will leave gum deposits in the carburetor and gas tank.
2. Clean engine of all foreign matter.
3. Lubricate cylinder by removing the spark plug and pour in one ounce of clean lubricating oil through the spark plug hole into the cylinder. Crank engine slowly to spread oil and replace spark plug. To start after storage, remove spark plug and rotate engine with starter to remove excess oil.

240-688A 240-690A

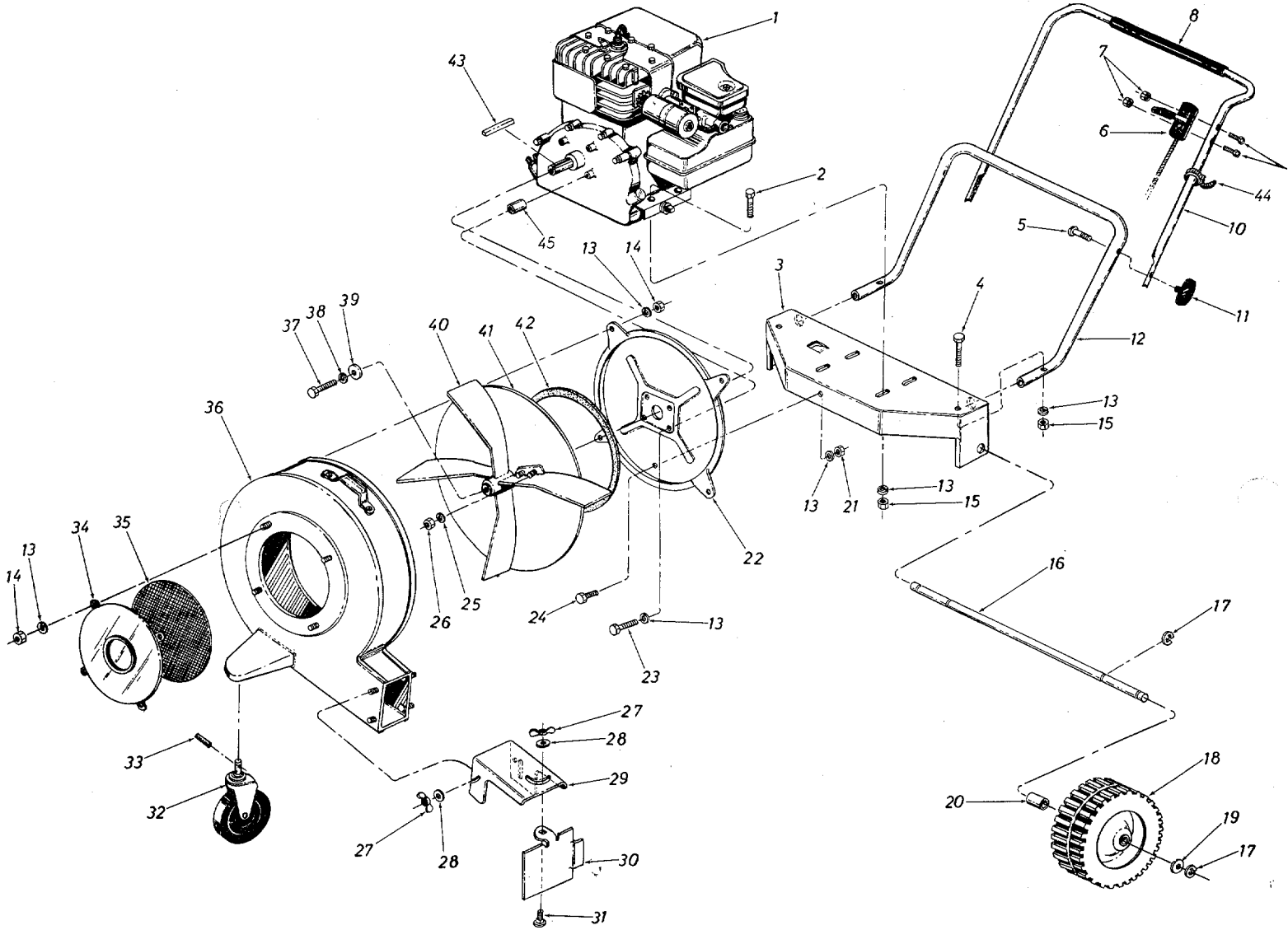

PARTS LIST FOR LEAF BLOWER MODELS 240-688A AND 240-690A

Ref. No.	PART No.	COLOR CODE	DESCRIPTION	New Part
1	-----		Engine (3) or (5) H.P.	
2	710-0118		Hex Bolt 5/16-18 x .75" Lg.*	
3	13739		Engine Plate Assembly	
4	710-0528		Hex Bolt 5/16-18 x 1.25" Lg.*	
5	710-0405		Curved Hd. Carriage Bolt 5/16-18 x 1.75	
6	2142-073		Throttle Control Complete	
7	712-0162		Hex L-Nut #10-32 Thd.	
8	1710-051		Grip - Handle	
9	1509-003		Hex Bolt #10-32 x 1.25" Lg.	
10	3712-163		Upper Handle	
11	09966		Hand Knob	
12	3712-106		Lower Handle	
13	736-0119		L-Wash. 5/16" Scr.*	
14	712-0267		Hex Nut 5/16-18 Thd.*	
15	712-0267		Hex Nut 5/16-18 Thd.*	
16	2631-043		Axle	
17	716-0106		"E" - Ring	
18	2108-220		Wheel Assembly Complete	
19	736-0290		Fl.-Wash. 21/32 x 1.0" x 1/16 Thk.	
20	1624-165		Wheel Spacer	
21	712-0267		Hex Nut 5/16-18 Thd.*	
22	11452		Mounting Plate	
23	710-0117		Hex Bolt 5/16-24 x 1.00" Lg.*	
24	710-0118		Hex Bolt 5/16-18 x .75" Lg.*	
25	736-0217		L-Wash. 3/8" Scr. Heavy Duty	
26	712-0241		Hex Nut 3/8-24 Thd.*	
27	712-0109		Wing Nut 1/4-20 Thd.	
28	736-0173		Fl.-Wash. 1/4" I.D.	
29	13742		Deflector - Chute	
30	13741		Deflector	
31	710-0134		Carriage Bolt 1/4-20 x .62" Lg.	
32	2192-002		Caster Assembly	
33	1548-021		Roll Pin	
34	13738		Guard Assembly	
35	13796		Impeller Guard	
36	13735		Housing Assembly Complete	
37	710-0152		Hex Bolt 3/8-24 x 1.00" Lg.*	
38	736-0169		L-Wash. 3/8" Scr.*	
39	07386		Fl.-Wash.	
40	12230		Air Vane	
41	13734		Vane Plate Assembly	
42	721-0128		Gasket	
43	714-0133		Sq. Key 3/16 x 3/16 x 1.50" Lg.	
44	726-0178		Cable Tie	
45	40301		Spacer	

*For faster service obtain standard nuts, bolts and washers locally. If these items cannot be obtained locally, order by part number and size as shown on parts list.

(488 - Mack Truck Yellow) When ordering parts if color or finish is important, use color code shown at left. (e.g. Mack Truck Yellow Finish - 11907 (488).

The engine is not under warranty by the mower manufacturer. If repairs or service is needed on the engine, please contact your nearest authorized engine service outlet. Check the "Yellow Pages" of your telephone book under "Engines - Gasoline."



PARTS INFORMATION

POWER EQUIPMENT PARTS AND SERVICE

Parts and service for all MTD manufactured power equipment are available through the authorized service firms listed below. All orders should specify the model number of your unit, parts number, description of parts and the quantity of each part required.

ALABAMA	BIRMINGHAM	
Auto Electric & Carburetor Co.	2625 4th Ave. S.	35233
ARKANSAS	FORT SMITH	
Mity Mite Motors, Inc.	4515 South 16th Street	72901
	NORTH LITTLE ROCK	
Sutton's Lawn Mower Shop	Rt. 4 Box 368.	72117
CALIFORNIA	PORTERVILLE	
Billious	75 North D Street	93257
	SAN BERNARDINO	
Lawn Mower Supply Co.	25608 E. Baseline	92410
	SAN FRANCISCO	
J.W. Jewett Co.	981 Folsom St.	94107
COLORADO	DENVER	
South Denver Lawn Equip.	527 West Evans	80223
FLORIDA	JACKSONVILLE	
Radco Distributors	2403 Market St.	32206
	OPA LOCKA	
Small Eng. Dist.	2351 N.W. 147th St.	33054
GEORGIA	EAST POINT	
East Point Cycle & Key.	2834 Church St.	30344
ILLINOIS	LYONS	
Keen Edge Co.	8615 Ogden Ave.	60534
INDIANA	ELKHART	
Parts & Sales Inc.	2101 Industrial Pkwy.	46514
IOWA	DUBUQUE	
Power Lawn & Garden Equip.	2551 J.F. Kennedy.	52001
LOUISIANA	NEW ORLEANS	
Suhren Engine Co.	8330 Earhart Blvd.	70118
MARYLAND	TAKOMA PARK	
Center Supply Co.	6867 New Hampshire Ave.	20012
MASSACHUSETTS	SPRINGFIELD	
Morton B. Collins Co.	300 Birnie Ave.	01107
MICHIGAN	LANSING	
Lorenz Service Co.	2500 S. Pennsylvania.	48910
	MOUNT CLEMENS	
Power Equipment Dist.	36463 South Gratiot.	48043
MINNESOTA	HOPKINS	
Hance Distributing Inc.	420 Excelsior Ave. W.	55343
	ST. PAUL	
Power Tools Inc.	3771 Sibley Memorial Hwy.	55122
MISSISSIPPI	BILOXI	
Biloxi Sales & Service, Inc.	506 Caillavet St.	39533
MISSOURI	KANSAS CITY	
Automotive Equip. Service	3117 Holmes St.	64109
	ST. JOSEPH	
Ross-Frazier Supply Co.	8th and Monteray	64503
	ST. LOUIS	
Henzler, Inc.	2015 Lemay Ferry Rd.	63125
NEW JERSEY	BELLMAWR	
Lawnmower Parts Inc.	717 Creek Rd.	08030
	RUTHERFORD	
Feld Distributor	28 Glen Rd.	07070
NEW YORK	CARTHAGE	
Gamble Dist., Inc.	West End Ave.	13619

BRIGGS AND STRATTON, TECUMSEH AND PEERLESS PARTS AND SERVICE

Briggs & Stratton, Tecumseh and Peerless parts and service should be handled by your nearest authorized engine service firm. Check the yellow pages of your telephone directory under the list **Engines—Gasoline, Briggs & Stratton or Tecumseh Lauson.**

	SYRACUSE	
GTP Leisure Products Inc.	420 Marcellus St.	13204
NORTH CAROLINA	GOLDSBORO	
Smith Hardware Co.	515 N. George St.	27530
	GREENSBORO	
Dixie Sales Company	327 Battleground Ave.	27402
OHIO	CARROLL	
Stebe's Mid-State Mower Supply ...	Box 366-71 High St. ...	43112
	CLEVELAND	
Bleckrie, Inc.	7900 Lorain Ave.	44102
	WADSWORTH	
National Central.	687 Seville Rd.	44281
	YOUNGSTOWN	
Burton Supply Co.	1301 Logan Ave. Box 929 ...	44501
OKLAHOMA	ADA	
Ada Auto Supply	301 E. 12th St.	74820
	MUSKOGEE	
Victory Motors, Inc.	605 S. Cherokee.	74401
	OKLAHOMA CITY	
Forest Sales Inc.	1039 N.W. 63rd St.	73116
OREGON	PORTLAND	
Kenton Supply Co.	8216 N. Denver Ave.	97217
PENNSYLVANIA	CHESTER	
Stull Equipment Corp.	742 W. Front St.	19013
	HARRISBURG	
EECO Inc.	4021 N. 6th St.	17110
	PHILADELPHIA	
Thompson Rubber Co.	5222-24 N. Fifth St.	19120
	PITTSBURGH	
Bluemont Co.	11125 Frankstown Rd.	15235
TENNESSEE	KNOXVILLE	
Master Repair Service.	2000 Western Ave.	37920
	MEMPHIS	
Memphis Cycle & Supply Co.	421 Monroe Ave.	38100
American Sales & Service, Inc.	1922 Lynnbrook.	38116
TEXAS	DALLAS	
Marr Brothers, Inc.	423 E. Jefferson.	75203
	FORT WORTH	
Woodson Sales Corp.	1702 N. Sylvania	76111
	HOUSTON	
Bullard Supply Co.	2409 Commerce St.	77003
	SAN ANTONIO	
Catto & Putty, Inc.	414 Live Oak	78298
UTAH	SALT LAKE CITY	
A-1 Engine & Mower Co.	437 E. 9th St.	84111
VERMONT	BURLINGTON	
Vermont Hdwe. Co. Inc.	180 Flynn Ave.	05401
VIRGINIA	RICHMOND	
RBI Corp.	963 Myers St.	23260
WASHINGTON	SEATTLE	
Bailey's Inc.	1414 14th Ave.	98102
WEST VIRGINIA	CHARLESTON	
Young's, Inc.	233 Virginia St., E.	25301
WISCONSIN	APPLETON	
Automotive Supply Co.	123 S. Linwood Ave.	54911

WARRANTY PARTS AND SERVICE POLICY

The purpose of warranty is to protect the customer from defects in workmanship and materials, defects which are NOT detected at the time of manufacture. It does not provide for the unlimited and unrestricted replacement of parts. Use and maintenance are the responsibility of the customer. The manufacturer cannot assume responsibility for conditions which it has no control. Simply put, if it's the manufacturer's fault, it's the manufacturer's responsibility; if it's the customer's fault, it's the customer's responsibility.

CLAIMS AGAINST THE MANUFACTURER'S WARRANTY INCLUDES

1. Replacement of Missing Parts on new equipment.
2. Replacement of Defective Parts within the warranty period.
3. Repair of Defects within the warranty period.

All claims MUST be substantiated with the following information:

1. Model Number of unit involved.
2. Date unit was purchased or first put into service.
3. Date of failure.
4. Nature of failure.

Free Manuals Download Website

<http://myh66.com>

<http://usermanuals.us>

<http://www.somanuals.com>

<http://www.4manuals.cc>

<http://www.manual-lib.com>

<http://www.404manual.com>

<http://www.luxmanual.com>

<http://aubethermostatmanual.com>

Golf course search by state

<http://golfingnear.com>

Email search by domain

<http://emailbydomain.com>

Auto manuals search

<http://auto.somanuals.com>

TV manuals search

<http://tv.somanuals.com>