

---

# MX Blueprint<sup>®</sup> series

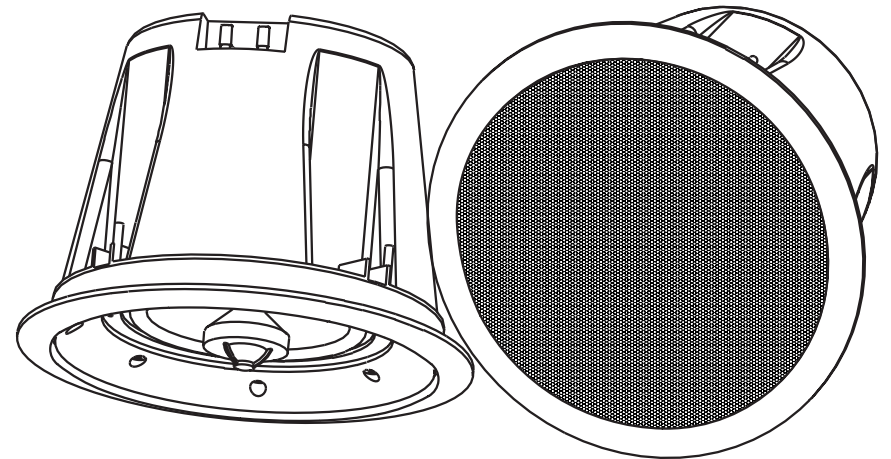

FIRST  
CLASS  
STAMP  
HERE

**MX**  
4545 E BASELINE RD  
PHOENIX AZ 85040-6400

**MODEL 620CE**

IN CEILING ENCLOSED LOUDSPEAKER

---

OWNERS MANUAL



## CONGRATULATIONS

We appreciate your choice of MTX Blueprint Series In-Ceiling Loudspeakers. Properly installed and operated, MTX In-Ceiling Loudspeakers should provide years of worry-free listening pleasure. It's important that you follow each step in this guide carefully to insure proper installation. If you have any questions regarding MTX In-Ceiling Loudspeakers, please call us at 1-800-223-5266.

## SPECIFICATIONS

<b>Frequency Response</b>	62-20kHz
<b>Impedance</b>	4 Ohms
<b>Nom. Power Handling</b>	55 Watts RMS
<b>Total Power Handling</b>	180 Watts
<b>Sensitivity</b>	82dB
<b>Woofer Diameter</b>	6 1/2"
<b>Woofer Cone</b>	Injection Molded Polypropylene
<b>Tweeter</b>	1" Soft Dome
<b>Mounting Depth</b>	7.390"
<b>Grill</b>	Aluminum Mesh

## PAINTING YOUR MTX IN-WALLS

MTX In-Ceiling speakers are designed to accept all types of interior and exterior paints. Spray or roller application should provide excellent results. A paint shield is included with all Blueprint Series In-Ceiling speakers to protect the speakers during the painting process.

## WARRANTY

MTX Blueprint Series In-Ceiling Loudspeakers are guaranteed against defects in parts and workmanship for a period of ten (10) years from the date of purchase. Speakers found defective during that period will be repaired by MTX without charge for parts.

This warranty is void if it is determined that unauthorized parties have attempted repairs or alterations of any nature. Before assuming that a defect is present in the loudspeakers, be certain that all associated equipment is operating properly.

If a defect is present, your authorized MTX dealer may be able to effect repairs. If not, you are responsible for providing transportation to the factory. Your MTX dealer can recommend the safest method of transportation. Proof of purchase is required when requesting service, so please retain your sales slip.

Specifications subject to change without notice.

(Cut out on dotted line and mail to address on reverse side.)

### WARRANTY REGISTRATION

*To register your purchase and insure your investment, please fill out and return this card.*

NAME \_\_\_\_\_ AGE \_\_\_\_\_

ADDRESS \_\_\_\_\_

DATE PURCHASED \_\_\_\_\_

DEALER NAME \_\_\_\_\_

PURPOSE:  Main Music Listening  Background  Video/surround

Other \_\_\_\_\_

ROOM(S) INSTALLED \_\_\_\_\_

INSTALLED BY \_\_\_\_\_

HOW DID YOU FIRST LEARN OF MTX IN-WALLS?

Dealer  Friend  Magazine  Radio  Newspaper  Other

COMMENTS \_\_\_\_\_

## OTHER BLUEPRINT SERIES PRODUCTS FROM MTX

MTX offers a wide assortment of audio components. Ranging from in-wall speakers to amplifiers to accessories. Each component is value engineered and must meet strict quality control standards before it becomes part of the MTX product line.

Listed below you will find a sampling of MTX components available from your authorized Blueprint Series dealer.

### IN-WALL LOUDSPEAKERS

#### MODEL 520W

5-1/4" Two-Way In-Wall Speaker  
1" Soft Dome Tweeter  
8 Ohm Impedance/84dB Sensitivity  
53Hz-20kHz Frequency Response  
50 Watts RMS/160 Watts Total  
11"H x 7-1/2"W x 2-1/2"D

#### MODEL 620W

6-1/2" Two-Way In-Wall Speaker  
1" Soft Dome Tweeter  
8 Ohm Impedance/85dB Sensitivity  
43Hz-20kHz Frequency Response  
55 Watts RMS/180 Watts Total  
12-1/16"H x 8-9/16"W x 2-7/8"D

#### MODEL 820W

8" Two-Way In-Wall Speaker  
1" Soft Dome Tweeter  
8 Ohm Impedance/86dB Sensitivity  
33Hz-20kHz Frequency Response  
60 Watts RMS/200 Watts Total  
14-1/16"H x 10-1/16"W x 3-1/2"D

#### MODEL 502W

5-1/4" Two-Way In-Wall Speaker  
1/2" Polycarbonate Dome Tweeter  
8 Ohm Impedance/84dB Sensitivity  
53Hz-20kHz Frequency Response  
45 Watts RMS/140 Watts Total  
11"H x 7-1/2"W x 2-1/2"D

#### MODEL 602W

6-1/2" Two-Way In-Wall Speaker  
1/2" Polycarbonate Dome Tweeter  
8 Ohm Impedance/85dB Sensitivity  
43Hz-20kHz Frequency Response  
50 Watts RMS/160 Watts Total  
12-1/16"H x 8-9/16"W x 2-7/8"D

#### MODEL 600WM

6-1/2" Water Resistant Co-Axial In-Wall Speaker  
1/2" Polycarbonate Dome Tweeter  
8 Ohm Impedance/88dB Sensitivity  
64Hz-20kHz Frequency Response  
35 Watts RMS/140 Watts Total  
8-5/8"H x 8-5/8"W x 2-3/4"D

### SPEAKER/AMPLIFIER SELECTOR

#### LPS-600

Accommodates up to 6 pair of speakers  
Handles up to 250 Watts/channel continuous (RMS)  
Impedance Protection Circuitry  
Low profile-full size component  
Two-piece, plug in connectors on the rear panel  
Accommodates up to 14 gauge wire  
TV-5 UL Approved Switches  
A/B Amplifier and Input Selector

### ACCESSORIES

#### VC-30B/VC-30W

Decora-Style Volume Control (Bone or White)  
10 Step 25 Watts per channel (RMS) 150 Watts Peak

#### AB-1SB/AB-1SW

Decora-Style A/B Switch (Bone or White)

#### PCK65C

Pre-Construction Kit for Model 610RCM

#### PCK85C

Pre-Construction Kit for Model 810RCM

## FEATURES

The Model 620CE in-ceiling enclosed loudspeaker is a unique design unlike any other before it. It allows you to bring concert-quality sound to virtually any area of your home that may have been previously off-limits because of building code restrictions or weather conditions.

The Model 620CE utilizes its mounting wings to mount into a ceiling like conventional in-ceiling speakers, while incorporating an integral enclosure to provide a vapor barrier between you and the outside world.

The long excursion, high performance woofer was designed specifically to work with its integral enclosure to insure deep, accurate bass. While the soft dome tweeter perfectly complements the woofer with its sweet sound and excellent off-axis frequency response.

All of the Model 620CE components have been manufactured with high quality, weather resistant materials. This completes the Model 620CE's package of versatility, performance and durability.

## STEP 1

Using a stud finder (available at low cost at most hardware stores) or other accurate method, locate center point between two joists and mark. Using template provided, trace hole pattern on surface of ceiling.

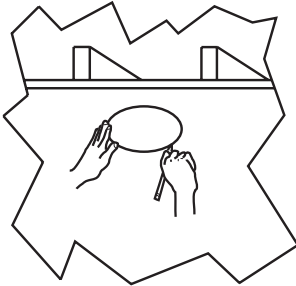

## STEP 2

Using a sabre saw, keyhole saw or very sharp utility knife, cut hole in ceiling, following traced pattern.

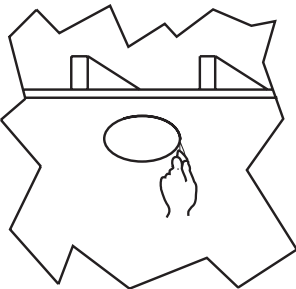

## STEP 3

Run loudspeaker wires to sound source location. There are several methods you can use to accomplish wiring, depending on the construction characteristics of the room or house. You can add a professional touch to your installation by using a speaker terminal plate at the source location. Leave sufficient amount of wire at speaker location (8 to 10 inches) to complete connection.

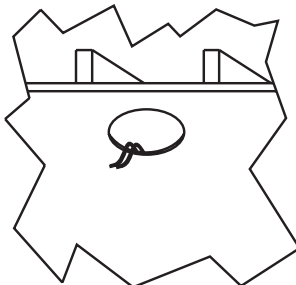

## STEP 4

Attach loudspeaker wires to speaker terminals, observing correct polarity, and position speaker frame up into cutout. Be careful not to pinch wires in the process.

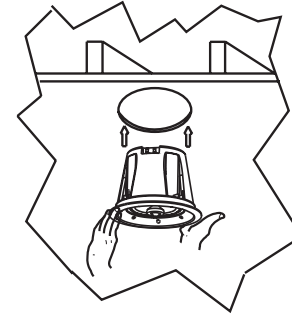

## STEP 5

Carefully tighten the four mounting screws, using a phillips screwdriver. This will cause the mounting wings to rotate out behind the mounting surface and secure the speaker in place. *Note: the phillips head screws are for tightening the mounting wings. The torx head screws are for the enclosure which should not be tightened or loosened.*

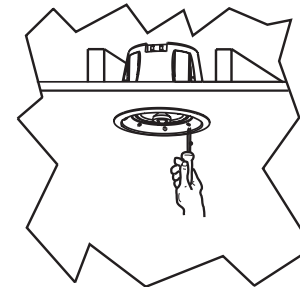

## STEP 6

After speaker panel is secured tightly, test for sound. When you are satisfied the speaker is operational, affix grill. As the grill is designed for a snug fit, you'll need to position one edge into the slot first, press or squeeze around perimeter of the grill, while pushing leading edge into the grill slot.

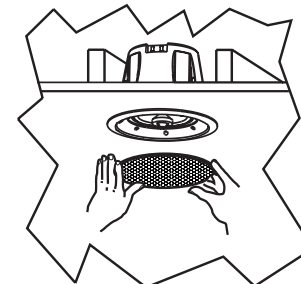

## Free Manuals Download Website

<http://myh66.com>

<http://usermanuals.us>

<http://www.somanuals.com>

<http://www.4manuals.cc>

<http://www.manual-lib.com>

<http://www.404manual.com>

<http://www.luxmanual.com>

<http://aubethermostatmanual.com>

Golf course search by state

<http://golfingnear.com>

Email search by domain

<http://emailbydomain.com>

Auto manuals search

<http://auto.somanuals.com>

TV manuals search

<http://tv.somanuals.com>