

# VPort 2140

---

## User's Manual

[www.moxa.com/product](http://www.moxa.com/product)



**First Edition, March 2004**

**MOXA™**

**Moxa Networking Co., Ltd.**

Tel: +886-2-29191230 Fax: +886-2-29191231

[www.moxa.com](http://www.moxa.com)

[support@moxanet.com.tw](mailto:support@moxanet.com.tw) (worldwide)

[support@moxa.com](mailto:support@moxa.com) (The Americas)

# VPort 2140 User's Manual

The software described in this manual is furnished under a license agreement and may be used only in accordance with the terms of that agreement.

## Copyright Notice

Copyright © 2004 Moxa Networking Co., Ltd.  
All rights reserved.  
Reproduction without permission is prohibited.

## Trademarks

MOXA is a registered trademark of the Moxa Group.  
All other trademarks or registered marks in this manual belong to their respective manufacturers.

## Disclaimer

Information in this document is subject to change without notice and does not represent a commitment on the part of Moxa.

Moxa provides this document "as is," without warranty of any kind, either expressed or implied, including, but not limited to, its particular purpose. Moxa reserves the right to make improvements and/or changes to this manual, or to the products and/or the programs described in this manual, at any time.

Information provided in this manual is intended to be accurate and reliable. However, Moxa Technologies assumes no responsibility for its use, or for any infringements on the rights of third parties that may result from its use.

This product might include unintentional technical or typographical errors. Changes are periodically made to the information herein to correct such errors, and these changes are incorporated into new editions of the publication.

# Before getting started

Before using your VPort 2140, pay attention to the following items.

- ❑ After opening the VPort 2140 box, compare the contents of the box with the **Package Checklist in Chapter 1**. Notify your sales representative if any of the items is missing or damaged.
- ❑ To prevent damage or problems caused by improper usage, read the **Quick Installation Guide** (printed handbook in the package) or **Chapter 1, Introduction**, under **Product Description**, and **Chapter 2, Getting Started**, before assembling and operating the device and peripherals.
- ❑ If you experience a system error, and the system does not recover easily, refer to the **Troubleshooting** section in **Chapter 7** to learn how to restore factory default settings and reinstall the system.
- ❑ VPort 2140 Video Server has been designed for various environments and can be used to build various applications for general security or demonstration purposes. For standard applications, refer to the appropriate section in the **Chapter 2, Getting Started**, under **Accessing VPort 2140 Video Server for the First Time** section to find your application, and then follow the steps to set up the system. To make the best use of VPort, read **Chapter 5, Advanced Applications**, in the **URL Command for Advanced Functions** section to get creative ideas, and review **Chapter 4, System Configuration** for detailed explanations of system configurations.

## Note

- ❑ Surveillance devices may be prohibited by law in your country. Though VPort is both a high performance surveillance system and networked video server, ensure that the operations of such devices are legal in your local area before installing this unit for surveillance purposes.

**ATTENTION**

- ❑  Paragraphs preceded by the ATTENTION indicator must be fully understood and heeded. Ignoring these warnings could result in serious hazards.

# Table of Contents

<b>Chapter 1</b>	<b>Introduction .....</b>	<b>1-1</b>
	Overview .....	1-2
	Package Checklist.....	1-3
	Product Features.....	1-3
	Typical Applications .....	1-4
	Ethernet Connection .....	1-4
	Modem Dial-up Connection .....	1-4
	Product Descriptions .....	1-5
	Front Panel.....	1-5
	Rear Panel.....	1-7
<b>Chapter 2</b>	<b>Getting Started .....</b>	<b>2-1</b>
	Before Getting Started .....	2-2
	Setting up an Ethernet Environment.....	2-2
	Cable Connection.....	2-2
	Running the IP Installer Program.....	2-3
	Powering on the VPort 2140 Video Server.....	2-4
	Assigning an IP Address to VPort 2140 Video Server .....	2-4
	Accessing VPort 2140 Video Server for the First Time .....	2-6
	Setting up a Modem Environment.....	2-7
	Cable Connection.....	2-7
	Powering on VPort 2140 Video Server.....	2-8
	Configuring a Modem (Under Windows 2000 Environment) .....	2-9
	Accessing VPort 2140 Video Server for the First Time .....	2-14
	Mounting VPort 2140 .....	2-14
	Panel Mounting.....	2-14
<b>Chapter 3</b>	<b>Accessing VPort 2140 Video Server for the First Time .....</b>	<b>3-1</b>
	Accessing VPort 2140 Video Server.....	3-2
	Opening Your Browser .....	3-2
	Authentication.....	3-2
	Installing the Plug-in Application .....	3-3
	Functions Featured on the Main Page.....	3-3
	Image Mode and Text Mode.....	3-3
	Logo and Host Name .....	3-4
	Video Quality Selection.....	3-4
	Image Size Selection.....	3-4
	Camera View selection .....	3-5
	System Configuration .....	3-5
	Relay Output Control.....	3-5
	Motorized (PTZ) Camera Control.....	3-5
	Custom Camera Commands .....	3-5
<b>Chapter 4</b>	<b>System Configuration.....</b>	<b>4-1</b>
	System Configuration Via Web Access .....	4-3
	Using Setup Wizard.....	4-3
	Using the Application Wizard .....	4-4
	System.....	4-4
	Security.....	4-5
	Network .....	4-6
	Video.....	4-9
	COM 1 & COM 2 .....	4-11

	Application .....	4-13
	Demo.....	4-17
	Homepage layout .....	4-17
	View log file .....	4-18
	View parameters .....	4-19
	Factory default .....	4-19
	System Configuration Via FTP .....	4-20
	CONFIG.INI.....	4-20
	System Configuration Via Telnet.....	4-27
	Telnet Commands .....	4-27
	System core debugging .....	4-27
	Monitor changed status of digital inputs .....	4-27
	Stop information dumping .....	4-28
	Query status of digital inputs .....	4-28
	Set digital outputs .....	4-28
	Erase snapshots stored in Flash memory .....	4-28
	Skip installation at next boot.....	4-28
	Reset network for new settings .....	4-28
	Restore factory default settings .....	4-28
	Reset system .....	4-28
<b>Chapter 5</b>	<b>Advanced Applications .....</b>	<b>5-1</b>
	Capturing Up-to-date Still Images .....	5-2
	Getting snapshot via URL.....	5-2
	Getting snapshot via FTP.....	5-2
	Video Embedded in Customers' Homepage.....	5-2
	Download Event-triggered Snapshots .....	5-3
	Getting triggered snapshots via URL.....	5-3
	Getting triggered snapshots via FTP.....	5-3
	Customizing Graphics in Homepage.....	5-4
	Command Script for DI/DO & Camera's Actions Setting .....	5-4
	Command format .....	5-5
	Parameter Explanations .....	5-5
	Practical Examples.....	5-6
	URL Commands for DI/DO & Camera's Actions Setting .....	5-7
	Query status of digital inputs .....	5-7
	Drive digital outputs .....	5-7
	Moving motorized camera in PTZ direction.....	5-7
	Recalling camera position.....	5-7
	Transparent Remote Serial Driver .....	5-7
	URL Commands for System Maintenance.....	5-8
	Download System Log via FTP .....	5-8
	Restart System via URL.....	5-8
	Restore Factory Default Settings via URL.....	5-8
<b>Chapter 6</b>	<b>Upgrading System Firmware .....</b>	<b>6-1</b>
	Using Upgrade Wizard to Upgrade Firmware Easily .....	6-2
	Using FTP to Upgrade Firmware .....	6-3
<b>Chapter 7</b>	<b>Troubleshooting.....</b>	<b>7-1</b>
	Power On Self Test (POST).....	7-2
	Frequently Asked Questions .....	7-2
<b>Appendix A</b>	<b>URL Commands of Video Server.....</b>	<b>A-1</b>
	Page URL.....	A-1
	System Resource URL.....	A-2
	General Format of Command URL .....	A-2
	System Configuration URL.....	A-2
	Security Configuration URL.....	A-2

	Network Configuration URL .....	A-3
	Video Configuration URL .....	A-4
	Image Quality Configuration URL .....	A-4
	COM 1 Configuration URL .....	A-5
	COM 2 configuration URL .....	A-5
	Camera custom command configuration URL .....	A-6
	Camera preset configuration URL.....	A-6
	Custom camera configuration URL .....	A-7
	Application configuration URL.....	A-7
	Motion detection configuration URL.....	A-8
	Demo configuration URL.....	A-8
	Homepage layout configuration URL .....	A-8
<b>Appendix B</b>	<b>Settings of Supported PTZ Cameras.....</b>	<b>B-1</b>
<b>Appendix C</b>	<b>Camera Control Cable .....</b>	<b>C-1</b>
<b>Appendix D</b>	<b>Time Zone Table.....</b>	<b>D-1</b>
<b>Appendix E</b>	<b>Technical Specifications .....</b>	<b>E-1</b>
<b>Appendix F</b>	<b>Service Information .....</b>	<b>F-1</b>
	MOXA Internet Services.....	F-2
	Problem Report Form.....	F-3
	Product Return Procedure .....	F-4

VPort 2140 is a high-performance networking video transmitter. In addition to meeting the basic needs of video feed, many advanced features are included to help you set up surveillance or web attraction applications. The state-of-the-art design strikes a good balance between stability, robustness, ease-of-use, and flexibility.

The following topics are covered in this chapter:

- ❑ **Overview**
- ❑ **Package Checklist**
- ❑ **Product Features**
- ❑ **Typical Applications**
  - Ethernet connection
  - Modem Dial-up Connection
- ❑ **Product Descriptions**
  - Front Panel
  - Rear Panel

---

## Overview

Video Server is a high-performance networking video transmitter. Its powerful VLIW DSP core and fully optimized algorithm compresses and transmits high quality real-time video over a standard TCP/IP network. In addition to meeting the basic needs of video feed, many advanced features are included to help you set up surveillance or web attraction applications. The state-of-the-art design strikes a good balance between stability, robustness, ease-of-use, and flexibility.

### **Real-time Motion-JPEG compression**

Video input can be efficiently compressed into packets of JPEG images without delay, and the optimized compression engine creates excellent images that take up much less memory space. This is done without sacrificing remote monitoring capability or storage. Five levels of compression ratio and three different image resolutions are provided to provide more versatility.

### **Robust system operation**

The industrial real-time operating system prevents hackers and viruses from wreaking havoc on both Windows and Linux systems, and the on-board watchdog improves reliability by continually monitoring the system's operation.

### **Easy Web access via standard browser**

There is no need to install new software to access Video Server, since the embedded Web Server allows users to access the Video Server anywhere over the Internet with any popular Web browser. As long as you are connected to the network, you will be able to view the same images seen by your cameras.

### **User's Password protection**

User's Password protection is provided to prevent malicious intruders from accessing your system. Once the administrator password is configured, all users will need a password to access the Video Server.

### **Built-in VMD (Video Motion Detection)**

External sensors are not required, since the video channel can be configured to detect motion, making it easy to set up a security system in either your home or office. And the customizable settings allow you to tune the system for both object size and sensitivity, making the Video Server adaptable to different environments.

### **Weekly schedule for automated surveillance**

The user-defined time period will repeat weekly to check security settings and send notifications or drive external devices, making it easy to install in SOHOs, retail shops, and home security systems.

### **Flexible I/O control for external devices**

One opto-isolated sensor input and one relay output are provided to control external devices, giving system integrators the option of turning an analog system into an advanced security system.

### **MOXA SoftDVR™ Lite IP Surveillance Software**

To extend the Video Server's capabilities, MOXA SoftDVR Lite IP Surveillance Software, which supports a maximum of 4 cameras in quad, is included free of charge, allowing users to turn their PC into a digital video recorder. Scheduling or one-click recording saves important images on your local hard disk, and the reliable motion detection and instant warning features make you ready for any situation. A quick and easy to use search and playback function lets you easily find the image you're looking for, so that you can inspect the images more carefully, and also save the output to an AVI file.

### **Remote system upgrade**

Video Server users have round-the-clock access to the most up-to-date firmware on our website, with a free upgrade wizard included to facilitate firmware installation.

### **Technical support for developers**

The high-performance Video Server can be integrated into many applications—without busting your budget—and the complete programming interface and standard JPEG format helps make the developer's job easy and straightforward. More ideas for Video Server applications can be found



on our website.

## Package Checklist

- 1 VPort 2140 Video Server



- Camera control cable

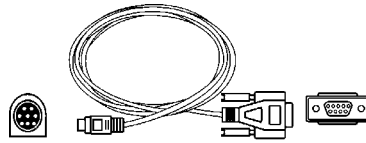

- Power adaptor



- Null modem cable

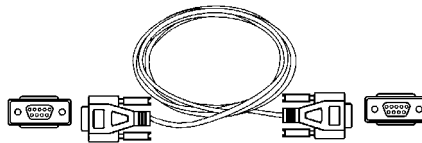

- 2 GPIO terminal connectors



- Software CD



- L-type Fixed Aluminum pieces and 8 screws



NOTE: Notify your sales representative if any of the above items is missing or damaged.

## Product Features

VPort 2140 products enjoy the following features:

- Compact size, 4-ch MJPEG Video Server
- 4 BNC video inputs, 4 BNC video outputs (75Ω resistance switch off)
- Stand-alone, with built-in web server for network interface
- Industry-standard real-time operating system without virus threat
- Real-time performance with powerful DSP
- Optimal solution by adjustable frame rate, bandwidth, and quality
- Video Motion Detection (VMD) with Pre/Event/Post images
- General I/O for external sensor and alarm
- Supports 2 RS-232/485 COM ports for PTZ camera control or Modem dial-up connection
- Remote access of images via FTP or e-mail
- Password protection and administrator privilege
- Customized personal homepage
- Remotely upgrade the firmware to keep it up to date
- Easy but powerful utilities for installation and maintenance
- MOXA SoftDVR™ IP Surveillance Software for viewing and recording bundled free

NOTE: ActiveX Control SDK is supported with flexible interface and sample codes for third-party developers (please contact Moxa sales representatives if you require this SDK.)

## Typical Applications

### Ethernet Connection

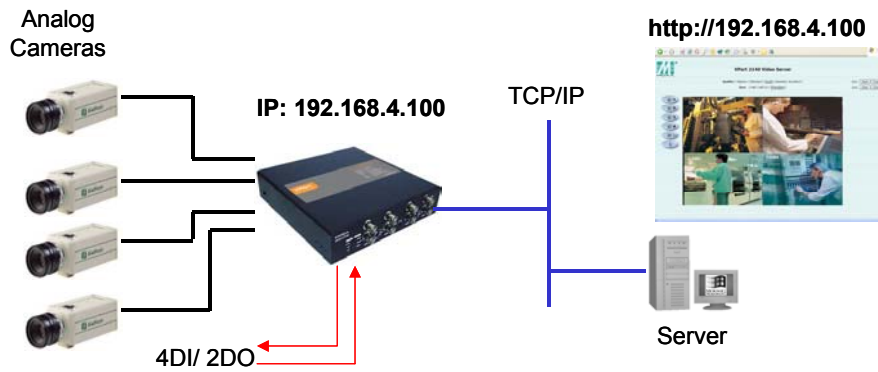

### Modem Dial-up Connection

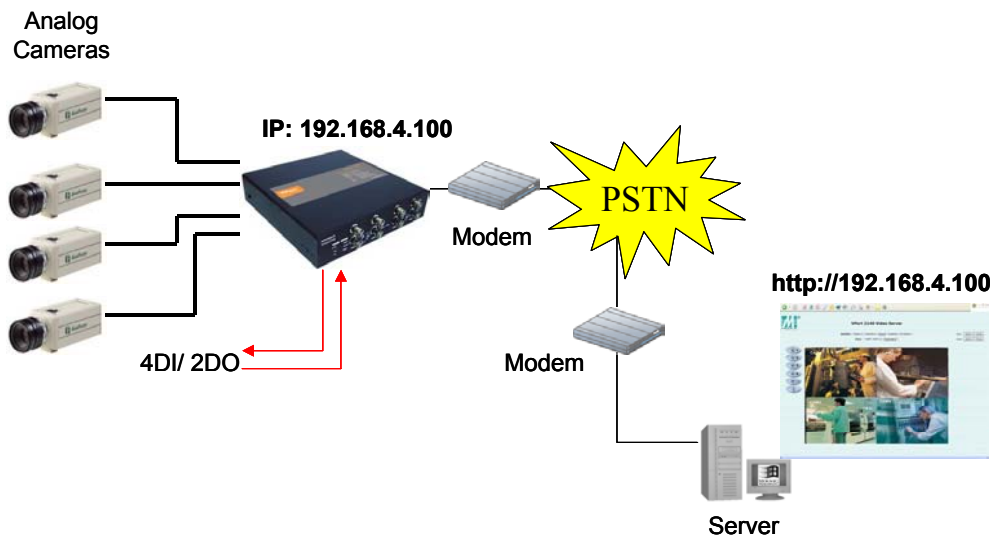

#### ATTENTION



Since VPort 2140 Video Server only supports the Modem Dial-up connection, the snapshots triggered by VMD, DI event or sequential mode will not be sent via the modem connection.

## Product Descriptions

### Front Panel

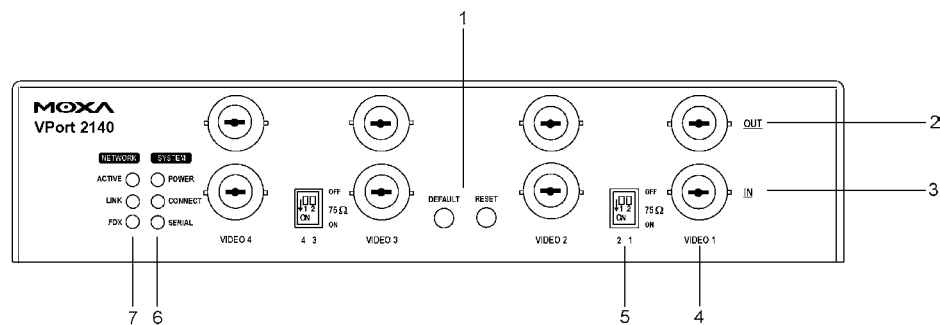

#### 1: RESET & DEFAULT buttons for restoring the system

There are two buttons located at the center of the front panel. One is labeled “RESET” and the other is labeled “DEFAULT.” “RESET” will force the system to restart at any point, meaning the system will perform the system diagnosis, and software installation may be necessary if the IP address is not fixed. “DEFAULT” will restore the default settings, and then force the system to restart.

When the system does not work properly, or VPort 2140’s IP address is not known, the administrator can use the restore function to restore VPort 2140’s factory default settings.

**Step1:** Click the “RESET” button once.

**Step2:** Press the “DEFAULT” button firmly until the “CONNECT” and “SERIAL” LEDs flash 2 times to run the system diagnosis and erase the system parameters.

#### 2 & 3: BNC video outputs “OUT” & inputs “IN”

VPort 2140 allows up to 4 cameras to be attached at the same time. To ensure that the correct video modulation type is detected, cameras should be connected sequentially from “VIDEO 1” to “VIDEO 4” and powered on before the VPort is powered on. Video outputs also have four loop-through connectors for connecting with other capture devices, such as a time-lapsed VCR. To use the video outputs, the 75 Ohm DIP switch should be turned to the “OFF” position.

#### ATTENTION



Although the analog cameras have 2 different standards, NTSC or PAL, all of the cameras connected to VPort 2140 Video Server should use the same standard.

#### 4: Camera ID: “VIDEO 1,” “VIDEO 2,” “VIDEO 3,” and “VIDEO 4”

Each camera connected to VPort 2140 has a Camera ID used by VPort to identify the camera.

#### 5: 75 Ohm DIP Switch

There are four 75 Ohm DIP switches numbered from “1” to “4” on the front panel. They are used to enable the 75-Ohm resistance video impedance. DIP switches should be turned to the “ON” position if cameras are connected to the video inputs. If users want to connect another device to the video output, such as a VCR or multiplexer, the switches should be turned to the “OFF” position to disable the impedance.

#### 6: System LEDs: “POWER,” “CONNECT,” and “SERIAL”

Each time the Video Server starts up, it will perform a Power-On-Self-Test (POST) to examine each hardware module. VPort 2140 has 3 LEDs:

- a. **POWER**: power indicator
- b. **CONNECT**: checks if the Video Server is alive
- c. **SERIAL**: checks if the RS-232/485 COM ports are in use

As soon as the administrator plugs in the power connector, both the CONNECT and SERIAL LED's will flash, one by one, until the diagnosis is finished. If the result is good, these 2 LEDs will turn off momentarily, and then follow the pattern shown in the table below. If any of the modules fails, refer to **Chapter 7, Troubleshooting**, under **Power On Self Test** for the error pattern, and then follow the troubleshooting procedures. If the system still does not operate normally, please contact your reseller for technical service.

Mode	Condition	LED1 (POWER)	LED2 (CONNECT)	LED3 (SERIAL)
Ethernet Connection	Before installation	ON	OFF	OFF
	After installation	ON	Flash	OFF
	During camera control	ON	Flash	Flash
Modem Dial-up Connection	After POST	ON	Flash	ON
Null Modem Dial-up Connection	Before connected	ON	ON	ON
	After connected	ON	Flash	ON

#### 7: Network LEDs: "ACTIVE," "LINK," and "FDX"

When using the 10/ 100 Mbps Ethernet connection, VPort 2140 has 3 LEDs to show network status:

Name	Description	Work Status
ACTIVE	Check if the network is alive	Flashing: Network alive OFF: Network not alive
LINK	Check the 10/ 100 Mbps Ethernet speed	ON: 100 Mbps OFF: 10 Mbps
FDX	Check if transmission is full or half duplex	ON: Full Duplex OFF: Half Duplex

## Rear Panel

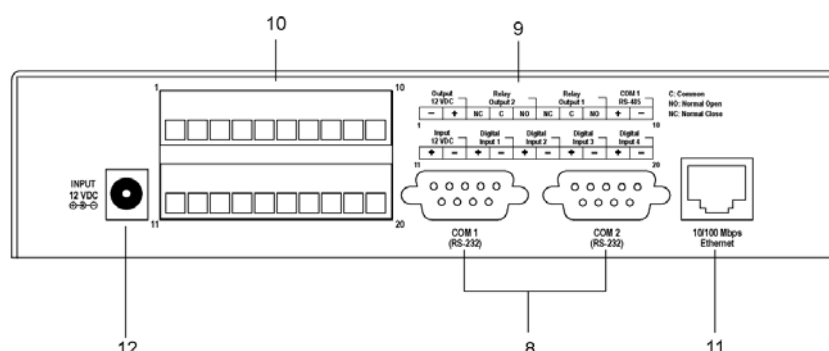
**8: COM1 & COM 2**

There are 2 COM ports on VPort 2140's rear panel.

- a. **COM 1 (RS-232):** This RS-232 serial port can connect with an RS-232 PTZ camera. For RS-485 PTZ cameras, the administrator can use the General I/O terminal block's COM 1 (RS-485) .
- b. **COM 2 (RS-232):** This RS-232 serial port can connect to a modem, or you can use the included null modem cable to utilize a dial-up network when Ethernet is not available. If the Video Server is connected to the network via the Ethernet interface, you can also use this RS-232 serial port to control an RS-232 PTZ camera.

**9 & 10: General I/O terminal block**

VPort 2140 provides a very flexible general I/O interface that can be used with security devices, such as sensors, alarms, lighting fixtures, or door locks. Two green connectors are included in the package to connect external devices. The general I/O terminal block has 20 pins for device control. These pins can be divided into three categories based on their functions, including power source, RS-485 and digital inputs and outputs.

No.	Pin description	Regulation
1	Output 12 VDC	-
2		+
3	Relay Output 2	NC
4		C
5		NO
6	Relay Output 1	NC
7		C
8		NO
9	COM 1	+ RS-485, Data+
10	RS-485	- RS-485, Data-
11	Input 12 VDC	+ External Power Input, Min. 1.5A, 12-15V AC or DC
12		-
13	Digital Input 1	+ Max. 50 mA, 12V DC
14		- Ground
15	Digital Input 2	+ Max. 50 mA, 12V DC
16		- Ground
17	Digital Input 3	+ Max. 50 mA, 12V DC
18		- Ground
19	Digital Input 4	+ Max. 50 mA, 12V DC
20		- Ground

- a. **Power Source:** There are 2 ways to connect to the power source. One is using the power adaptor. The other is using Pin 11 and Pin 12 of the terminal block, which are for DC power input. This DC power source can be either AC or DC, and should fall in the output

---

range between 12V and 15V. Polarity does not matter if you use AC. The DC output through Pin 1 and Pin 2 is fed from the power adaptor of the Video Server or pin 11 and pin 12 if an external power source is attached. The current of external devices is limited to less than 500 mA.

- b. **COM 1 RS-485:** If the device connected to the COM1 port has an RS-485 interface, such as a PTZ camera control, wire the RS-485 Data+ and Data- control lines to COM RS-485 pin “+” and pin “-”. If the distance from the controlled device is too long to allow accurate function, an external power source may be used to pull the RS-485 signal to “high” status.
- c. **Digital Input/Relay Output:** VPort 2140 Video Server provides 4 digital inputs and 2 relay outputs. The Digital Input’s “+” pin and “-” pin can be connected to an external sensor to monitor the voltage according to the programmed scripts in configuration (see the “Command Script for DI/DO & Camera’s Actions Setting” in Chapter 5). The Relay Output’s “NO” pin (Normal Open), “NC” (Normal Close) pin, and “C” pin (Common) can be used to turn an external alarm on or off. When the system starts up, both relay outputs’ “Common” pin will short the “NC” pin. A simple example is illustrated in the diagram below.

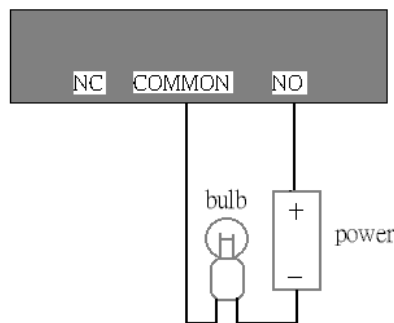

If DI1 is configured to “rising” status, so that DO1 is driven to “high” status (resulting in DO1’s “Common” pin shorting the “NO” pin), the light bulb will light up when DI1’s signal changes from 0V to 12V.

---

**ATTENTION**



COM 1 RS-485 and COM 1 RS-232 share the same UART chip. If one of the ports is being used, the other port will not be available.

---

### 11: 10/100 Mbps Ethernet

An RJ45 10/100 Mbps Ethernet connector can be connected to an Ethernet network with a UTP category 5 cable of length shorter than 100 meters (according to the Ethernet standard). Once the Ethernet cable is connected correctly, the Video Server will use the Ethernet interface before using the modem attached to COM 2.

### 12: INPUT 12 VDC

Connect the power jack of the included 12 VDC power adaptor. Connecting the power adaptor should be the last step involved in the Video Server hardware installation. Administrators may feed an external power source through pins 11 and 12 of the GPIO terminal block to replace the power adapter.

---

**ATTENTION**



The Video Server power adaptor and the external power supply (from pins 11 and 12 of the Terminal Block) cannot be used at the same time. Only one power source can be used to feed power to the Video Server. Improper usage will result in serious damage to your Video Server.

---

# 2

## Getting Started

---

This chapter includes information about how to install a VPort 2140 Video Server.

The following topics are covered:

- ❑ **Before Getting Started**
- ❑ **Setting up an Ethernet Environment**
  - Cable Connection
  - Running the IP Installer Program
  - Powering on VPort 2140 Video Server
  - Assigning an IP Address to VPort 2140 Video Server
  - Accessing VPort 2140 Video Server for the First Time
- ❑ **Setting up a Modem Environment**
  - Cable Connection
  - Powering on VPort 2140 Video Server
  - Configuring a Modem (Under Windows 2000 Environment)
  - Accessing VPort 2140 Video Server for the First Time
- ❑ **Mounting VPort 2140**
  - Panel Mounting

## Before Getting Started

To adapt easily to different environments, the Video Server automatically detects the attached interfaces and configures itself appropriately. For this reason, users do not need to worry about whether the connected cameras are either NTSC or PAL, how to select between Ethernet or modem, and whether the Ethernet speed is 10 Mbps or 100 Mbps.

The Video Server supports both Ethernet and modem dial-in connections. Refer to the installation section that applies to your network environment. If both interfaces are available, we recommend using Ethernet, which will be chosen automatically if an Ethernet cable and modem are both connected to the Video Server.

### ATTENTION



Installing a different interface will automatically clear the previous network settings to start a new installation.

In what follows, “user” refers to those who can access the Video Server, and “administrator” refers to the person who knows the root password that allows changes to the Video Server’s configuration, in addition to providing general access. Administrators should read this part of the manual carefully, especially during installation.

## Setting up an Ethernet Environment

Before installing multiple Video Servers at different locations, the administrator should record the MAC Address (located on the Video Server’s label) for future use, and then shut down all peripheral devices prior to connecting the devices. The video BNC, Ethernet cable, and power adaptor are needed to take advantage of the basic viewing function provided by the Video Server.

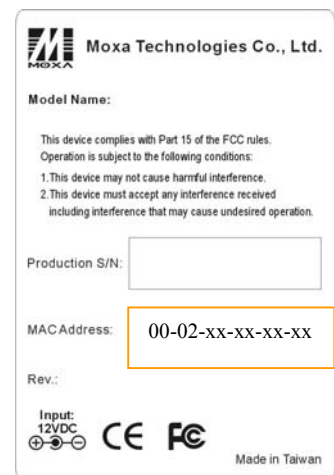

## Cable Connection

### Front Panel

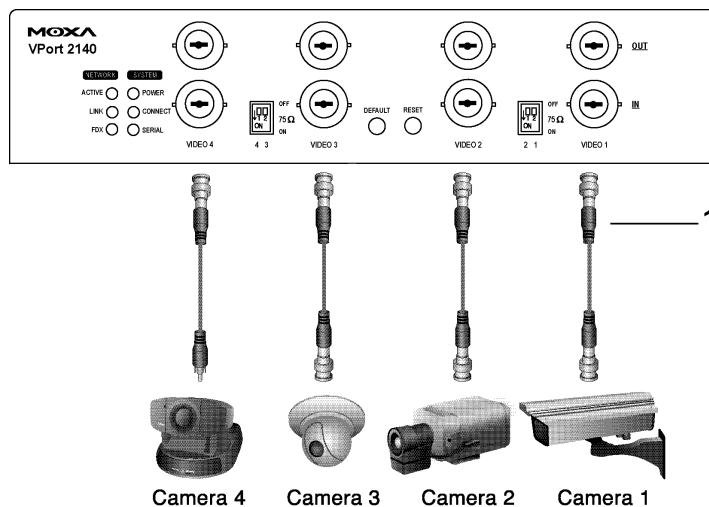



## Rear Panel

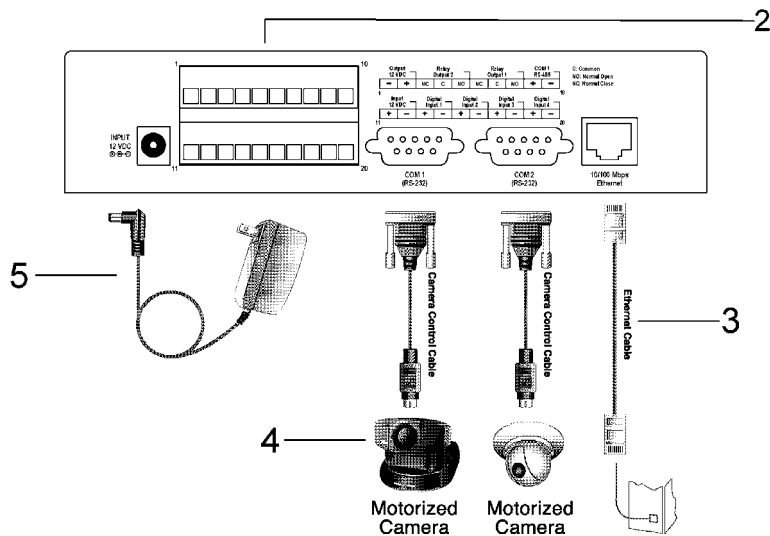

Before powering on the VPort 2140 Video Server:

1. Connect your camera's video output with the BNC video input.
2. Connect I/O devices (such as sensors or alarms) with VPort's GPIO Terminal Block.
3. Connect the hub or switch on the LAN to the VPort's 10/100 Mbps Ethernet port.
4. Connect VPort's COM port with your camera's COM port if you are using a PTZ Camera.

## Running the IP Installer Program

To run the IP installer program, double click on the "IPinstaller.exe" program located on the software CD.

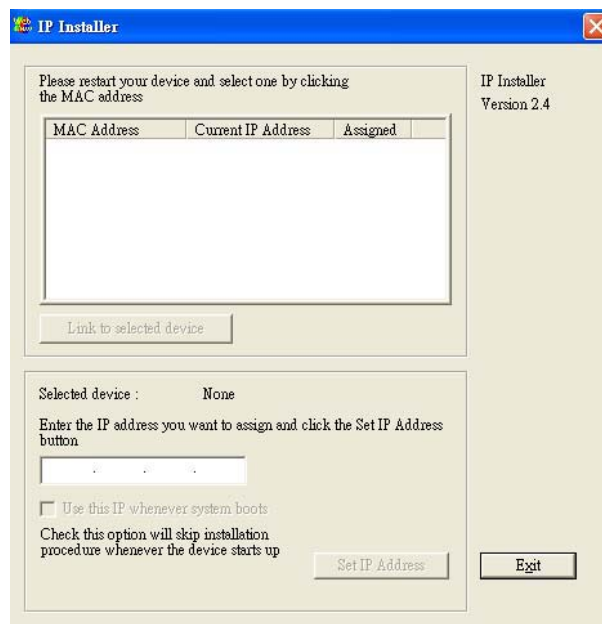

## Powering on the VPort 2140 Video Server

First, make sure that all cables are correctly and firmly connected, and then turn on the cameras, sensors, and alarm devices.

Next, power on the video server by attaching the Video Server's power adaptor to an electrical outlet. After the POST (Power-On Self Test) is completed successfully, the Video Server is ready to be configured. At this point, the network speed and video modulation type will be detected automatically.

## Assigning an IP Address to VPort 2140 Video Server

### Using the IP Installer Program

1. Power on the VPort after running IPinstaller.exe.
2. Wait for auto-search to locate new video servers.
3. Click on the VPort whose MAC address matches the one you just installed to assign it an IP address.

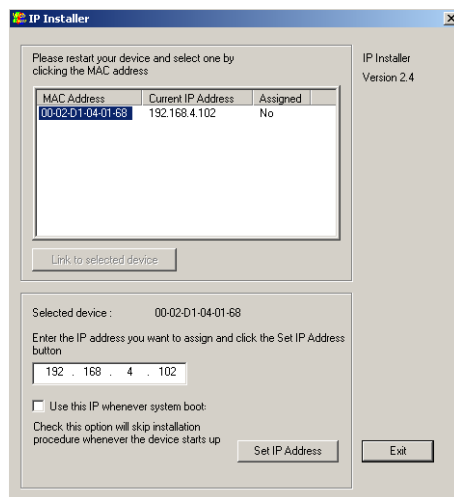

4. To assign an IP address to this VPort, manually type in the IP address you want to use if it differs from the IP address given by the DHCP server.

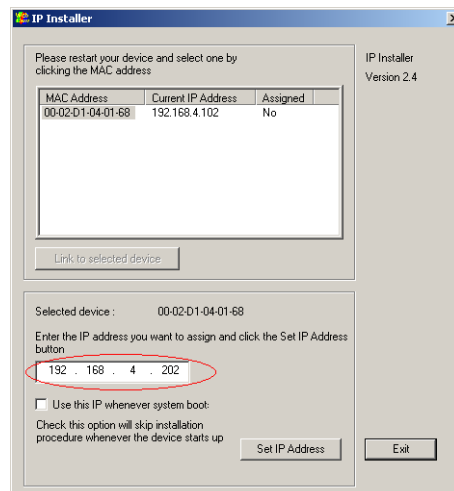

5. Check **Use the IP whenever system boots** option if you wish to continue using this IP

address for this VPort.

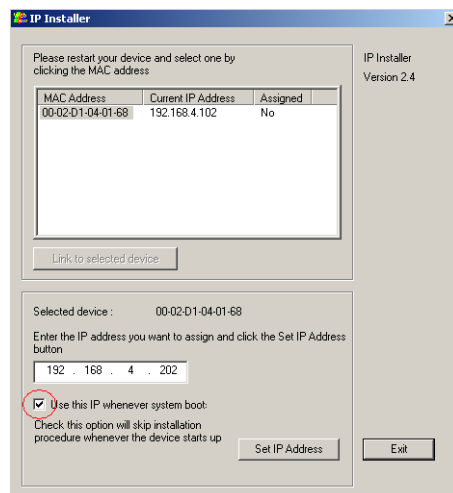
**ATTENTION**

If you check **Use this IP whenever system boots** option, you will not see this VPort the next time you run the IP installer program, unless you have restored the VPort. As a matter of convenience, we strongly recommend that you check this option.

6. Click on **Set IP Address** to assign the IP address to this VPort.

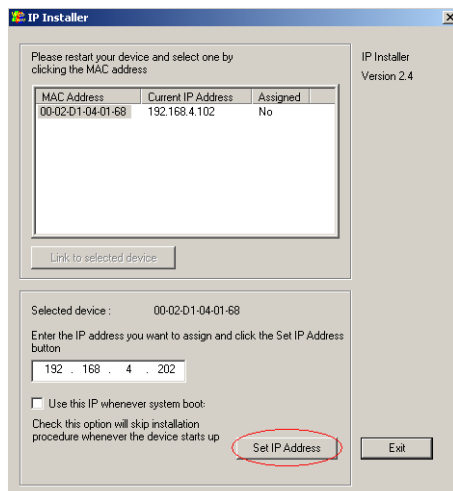

- If you check **Use the IP whenever system boots** option, then whenever you change the root password and restart the system, a dialog window will open to ask for **Server FTP Port** and **Root Password**, since they were already changed by the administrator to something other than the default settings. If the settings made by the administrator are lost, restore default settings and then rerun the IP installer program.



- The system will check if the IP address is valid.

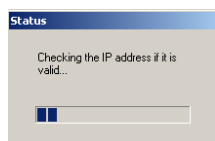

- An **Install OK** message will appear if the installation is successful. Click on **OK** to close the window.



## Using DOS Commands under Windows

For some environments, such as MAC, DOS, Linux, and UNIX, some common network tools, including ARP and PING, can be used to install the VPort. Before proceeding further, make sure that the ARP and PING programs are provided by your system.

- Open a DOS command window.
- Type `arp -s <VPort's IP Address> <MAC address>`, and press enter.
- Type `ping <VPort's IP address>`, and then press enter.
- A reply message will appear if the VPort is successfully installed.

```

C:\>arp -s 192.168.4.202 00-02-D1-04-01-68
C:\>ping 192.168.4.202
Pinging 192.168.4.202 with 32 bytes of data:
Reply from 192.168.4.202: bytes=32 time<1ms TTL=64
Reply from 192.168.4.202: bytes=32 time<1ms TTL=64
Reply from 192.168.4.202: bytes=32 time<1ms TTL=64
Reply from 192.168.4.202: bytes=32 time<1ms TTL=64

Ping statistics for 192.168.4.202:
    Packets: Sent = 4, Received = 4, Lost = 0 (0% loss),
    Approximate round trip times in milli-seconds:
        Minimum = 0ms, Maximum = 0ms, Average = 0ms
C:\>

```

## Accessing VPort 2140 Video Server for the First Time

Once the installation is complete, administrators should follow the instructions described in the next chapter, **First Time Accessing VPort 2140 Video Server**, to make necessary configurations.

## Setting up a Modem Environment

VPort 2140 Video Server provides 2 modem modes: Modem and Null Modem. The null modem mode can be used for point-to-point connections in a local environment. Although the baud rate can be set up to 115.2 Kbps, the actual data rate depends on the Modem connection. For dial-up connections, the VPort 2140 Video Server waits passively for a phone call to establish a point-to-point connection.

### ATTENTION



The Modem and Null Modem dial-up connections are for initial usage of Video Server. If you have already used an Ethernet connection, reset Video Server to factory defaults before using a dial-up connection. In addition, when using a dial-up connection, the Ethernet socket must be disconnected.

### ATTENTION



The Modem and Null Modem connections for VPort 2140 Video Server only support the dial-in function, which means that you can access the VPort 2140 Video Server, but VPort 2140 Video Server cannot send alarm messages to you automatically via the Modem and Null Modem connection.

## Cable Connection

### Null Modem

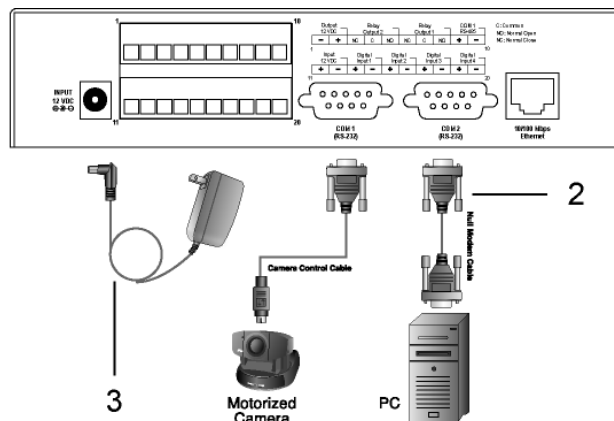
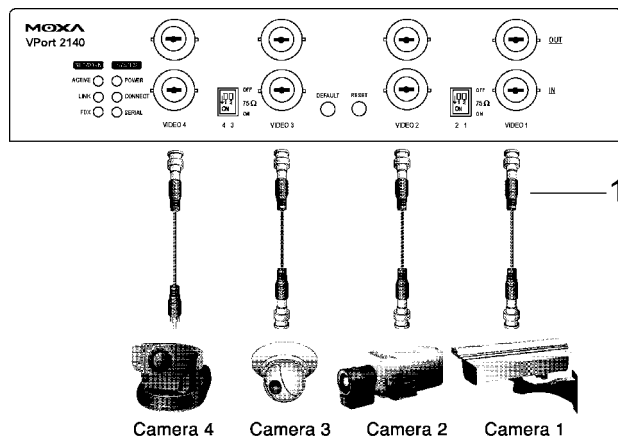

Before powering on the VPort 2140 Video Server:

1. Connect your cameras' video outputs to the BNC video inputs.
2. Connect VPort's COM port with your PC's COM port.
3. Connect the power adaptor.

### Modem

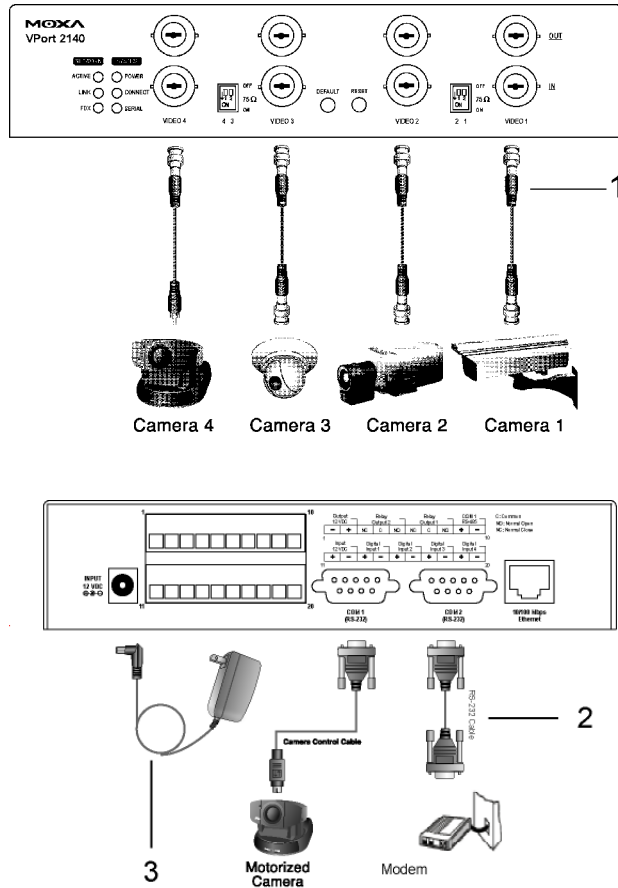

Before powering on the VPort 2140 Video Server:

1. Connect your cameras' video outputs with the BNC video inputs.
2. Connect VPort's COM port with your modem's COM port.
3. **Power on the Modem.**
4. Connect the power adaptor.

## Powering on VPort 2140 Video Server

After all cables are correctly and firmly connected, turn on all peripheral devices, including cameras, sensors, and alarm devices. And then connect the VPort 2140 to the power supply.

After being powered on, the VPort will automatically detect if an external modem is connected to the modem port. As soon as an external modem is detected, the **CONNECT** LED will blink periodically. If no modem is detected, the VPort will assume that the included null modem cable is connected to perform system configuration. Both **CONNECT** and **SERIAL** LEDs will show as "steady on" until the dial-up connection over the null modem is established.

## Configuring a Modem (Under Windows 2000 Environment)

### Installing a new modem

#### Null Modem Mode

1. Click on **Start**→**Control Panel**→**Modems**.



2. An **Install New Modem** message will appear. Check **Don't detect my modem; I will select it from a list**, and click on **Next** to continue.

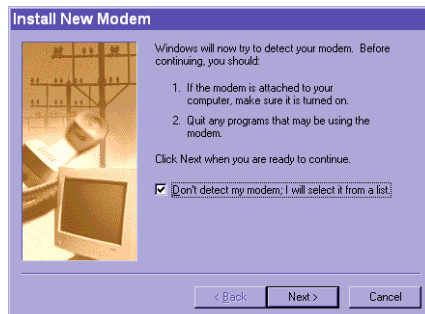

- Under the **Manufacturers** column, select **(Standard Modem Types)**. A number of modem models will appear in the **Models** column. Select **Standard 33600 bps Modem**, and click on **Next** to continue.

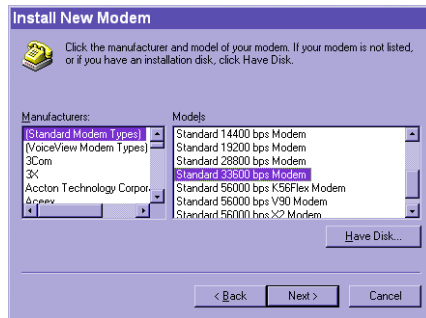

- Select the serial port that the included null modem cable is connected to, and click on **Next** to continue. The null modem is now ready for use.

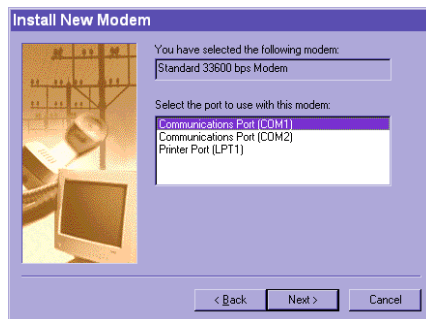

- If a Dial-Up adapter is not installed, Windows will automatically prompt you to install it. Click on **OK** to continue. If the adapter does not start automatically, double click on the **Control Panel** network icon install the **Microsoft Dial-Up Adapter**.





## Modem Mode

1. Click on **Start** → **Control Panel** → **Modems**.
2. If you already have a Modem, read the [Setting up a new connection](#) section below. If you don't have a modem, an **Install New Modem** message will appear. Click on **Next**, and the system will detect the modem automatically. If your modem is not detected, you can select the Modem from the manufacturers column.

## Setting up a new connection.

1. After the modem is installed, open the dialup network folder in Windows to set up a new connection.



2. Select the newly-installed **Modem** (for Modem connection) or **Standard 33600 bps Modem (for null modem connection)**, and then click on **Next** to continue.

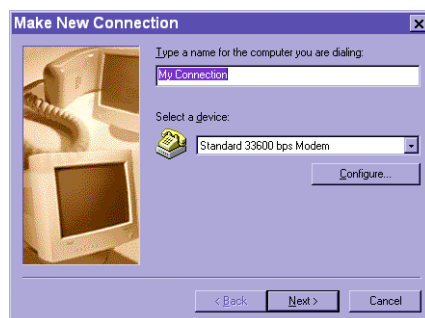

3. In modem mode, enter the phone number used to connect to your VPort 2140; in null modem mode, enter an arbitrary phone number, and then click on **Next** to continue.



- Click on **Finish** to complete the installation of the new modem. The new connection will be displayed in the Dial-up Networking folder and will be used for modem or null modem connections.



- Open the **Dial-Up Networking** window, and then click on the icon for the connection (My Connection) that was just installed to configure the connection's properties.

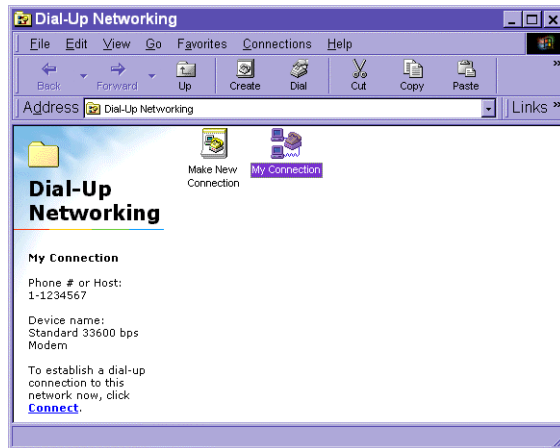

- When the **My Connection** window opens, right click on the **General** tab. In null modem mode, you should uncheck **Use area code and Dialing Properties**. Then click on **OK** to continue.

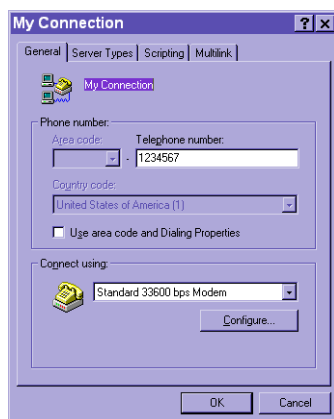

7. Click on **Configure** to modify the modem's properties. Under **Maximum speed**, select **115200**, and then click **OK** to continue.

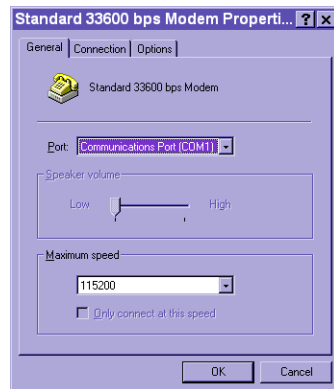

8. Under the **Server Types** tab of my connection, checkmark the **Enable software compression** option under **Advanced options**, and checkmark the **TCP/IP** option under **Allowed network protocols**, as shown below. Leave settings under the other tabs as default values, and then click on **OK** to continue.

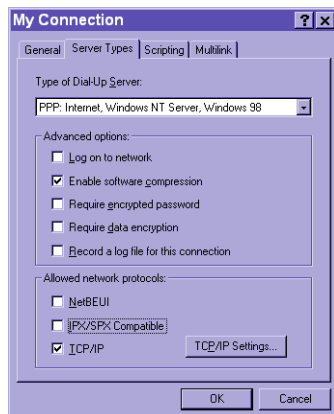
**ATTENTION**

Note that the location of the **Enable software compression** option and **TCP/IP** option might be different from OS to OS.

9. The connection is now ready to use for modem and null modem mode. Double click on the newly-installed connection icon. A dialing information window will appear. Enter **root** as user name and the **MAC address** shown at the bottom of the window as the password, and then click on **Connect** to connect to the Internet. Note that the letters in the MAC address should be in capitals (for example, type **A** instead of **a**).



---

## Accessing VPort 2140 Video Server for the First Time

### In Null Modem Mode

Administrators can connect to <http://200.1.1.1> from the web browser directly via the null modem cable. 200.1.1.1 is VPort's default IP address for the dial-up connection; and 200.1.1.100 is the IP address assigned by VPort to the user's PC. The user name and password are the same as what were entered during the software installation. After successful authentication, administrators should see the motion pictures on the main page. When using Microsoft Internet Explorer, administrators must allow the installation of a plug-in provided by the VPort prior to viewing motion pictures.

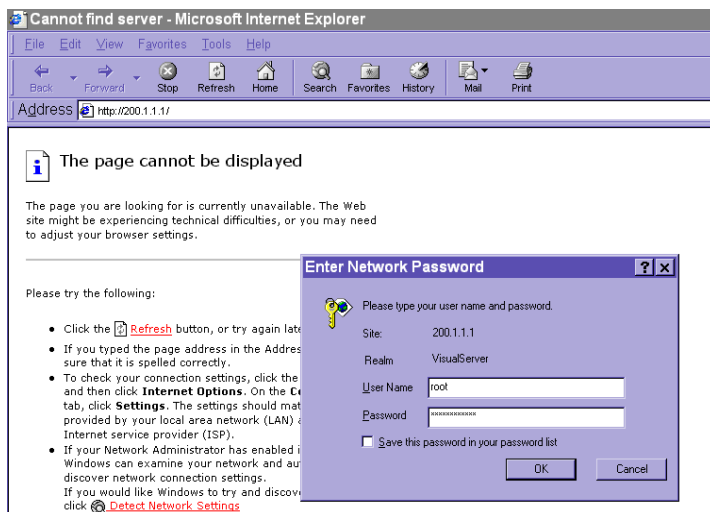

### In Modem Mode

To dial the VPort, you need to establish a dial-up connection with the PC, in which the dial-up phone number is the same as the phone line connected to the VPort. After the connection is successfully established, open the Web browser and link to <http://200.1.1.1>. In this case, the VPort runs as a dial-up server and assigns the IP address of 200.1.1.100 to the PC at the other end. When the authentication message window appears, type **root** for user name and use VPort's serial number for the default password. The point-to-point connection allows users to connect to the VPort for surveillance purpose at any time.

After the connection is successfully established, follow the instructions described in the next chapter, **Accessing VPort 2140 Video Server for the First Time**.

## Mounting VPort 2140

### Panel Mounting

Users can mount the VPort 2140 Video Server directly to the wall by using the 4 L-type Fixed Aluminum pieces. First, attach these 4 L-type Fixed Aluminum pieces to the VPort 2140 with the 8 screws. Then use the screws that have diameter larger than 7 mm to mount the VPort 2140 to the wall.

## Accessing VPort 2140 Video Server for the First Time

---

This chapter includes information about how to access VPort 2140 Video Server for the first time. The following topics are covered:

- ❑ **Accessing VPort 2140 Video Server**
  - Opening Your Browser
  - Authentication
  - Installing the Plug-in Application
- ❑ **Functions Featured on the Main Page**
  - Image Mode and Text Mode
  - Logo and Host Name
  - Video Quality Selection
  - Image Size Selection
  - Camera View Selection
  - System Configuration
  - Relay Output Control
  - Motorized (PTZ) Camera Control
  - Custom Camera Commands

---

# Accessing VPort 2140 Video Server

## Opening Your Browser

Open your browser, type the VPort's IP address in the **Address** box, and then press **Enter**.

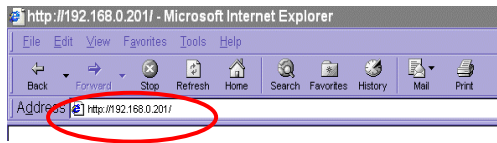

## Authentication

After opening your browser and typing the VPort's IP address, a dialogue window will appear, asking you to enter the username and the password. When accessing the VPort for the first time, administrators must enter root as the username, and the MAC address, in capital letters, as the password. You can find the MAC address on the VPort's label. Primary users will be allowed to access the VPort as soon as the administrator finishes adding user profiles. Upon successful authentication, the VPort's main page will be displayed.

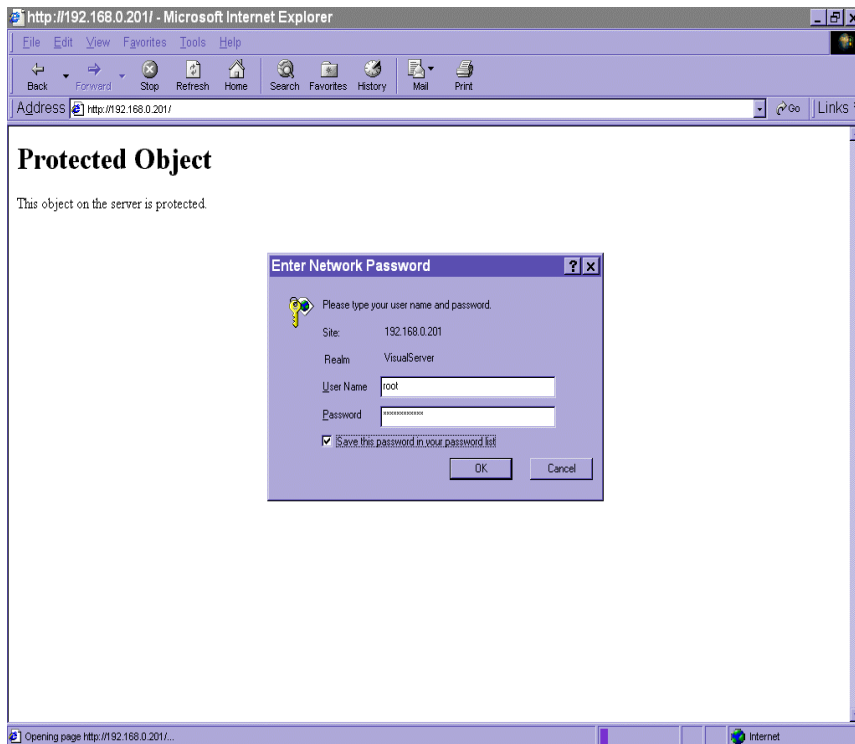

## Installing the Plug-in Application

If you access the VPort for the first time via a browser that supports server push (e.g., Netscape), the video images will be displayed directly. If you are using Windows' Internet Explorer as your browser, you will be asked to install a new plug-in application provided by the VPort. This plug-in application has been registered for certification, and is used to display video images via Internet Explorer. Click on **Yes** to install the plug-in application. If your browser does not allow the user to install the plug-in, change the security option to a lower level, or contact your network supervisor for assistance.

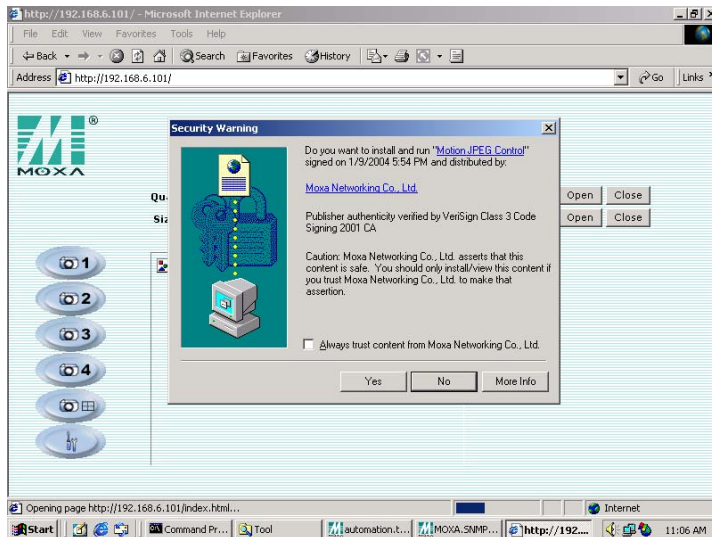

## Functions Featured on the Main Page

### Image Mode and Text Mode

Basic functions are displayed on the VPort's main page. The first figure below shows image mode, which has a better visual effect. The second figure shows text mode, which provides a shorter download time. The main page may look different depending on the PTZ driver or the authorization of the user.

#### Image Mode

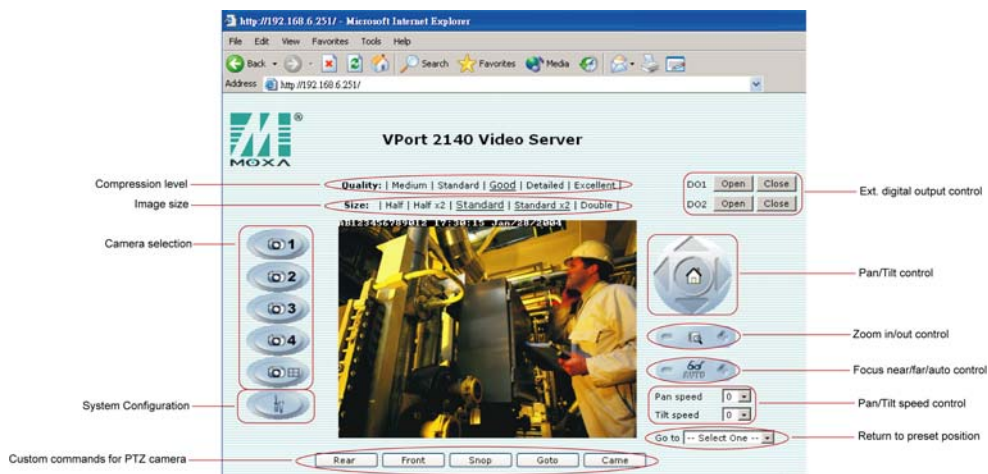

## Text Mode

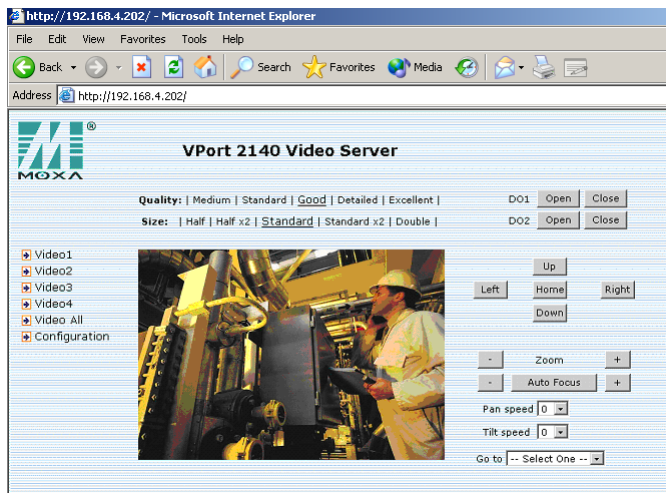

## Logo and Host Name

The default logo is Moxa's logo, and the host name is VPort 2140 Video Server. For customized usage, the administrator can change the layout of the homepage from the Homepage Layout page.

## Video Quality Selection

There are 5 options for video quality: Medium, Standard, Good, Detailed, and Excellent. Different video quality selections result in different sized JPEG files. The table below is an example.

Video Quality	JPEG File Size
Medium	9.3 KB
Standard	11.15 KB
Good	13.76 KB
Detailed	16.35 KB
Excellent	20.3 KB

## Image Size Selection

There are 5 options for selecting image sizes:

Video Size (unit: pixels)	NTSC	PAL
Half	176 × 112	176 × 112
Half × 2	352 × 240	352 × 288
Standard	352 × 240	352 × 288
Standard × 2	704 × 480	704 × 576
Double	704 × 480	704 × 576

### ATTENTION



**Half × 2** consumes the same file size and bandwidth as **Half**, but has the same resolution as **Standard**. For this reason, the visual effect of **Half × 2** is worse than **Standard**. Likewise, **Standard × 2** consumes the same file size and bandwidth as **Standard**, but has the same resolution as **Double**. For this reason, the visual effect of **Standard × 2** is worse than **Double**.



## Camera View selection

A maximum of 4 cameras can be connected to the VPort 2140 at the same time. Users can view the image of each camera by selecting “Video 1,” “Video 2,” “Video 3,” and “Video 4,” or selecting “Video All” to view all images in Quad screen.

---

**ATTENTION**

In Quad viewing mode, the maximum image size is only 352 x 240 (NTSC) or 352 x 288 (PAL) for each camera, in order to fit the monitor screen.

---

## System Configuration

There is a button or text link on the left side of the system configuration window that only appears on the administrators’ main page. For detailed system configuration instructions, refer to Chapter 4, **System Configuration**.

## Relay Output Control

VPort 2140 Video Server has 4 DI and 2 DO for external devices, such as sensors and alarms. If external devices are attached to the digital output, administrators or permitted users can click on **Open** to short the **Common** and **Normal Open** pins of the digital output, or click on **Close** to short the **Common** and **Normal Close** pins of the digital output.

## Motorized (PTZ) Camera Control

If a serial device, such as a motorized camera, is attached and correctly configured to the COM port, the control panel will appear on the permitted users’ main page. The effective buttons will change color when the cursor is passed over the button. Users can control the pan, tilt, zoom, and focus functions of motorized cameras. The home button is used to return the camera to the center position if the camera supports this command. Apart from near and far control for focus, an AUTO button is provided for setting auto focus mode. To move the motorized camera more precisely, the speed control for pan and tilt allows users to fine tune the aiming position. Users can also click directly on any point in the image to force the motorized camera to focus on that point, or select a preset location from the drop-down. The list of preset locations is pre-defined by administrators. The detailed configurations are described in the related section in Chapter 4, **System Configuration**.

## Custom Camera Commands

There are a maximum of five buttons that can be set to custom commands for users to control the attached motorized (PTZ) cameras, in addition to the default pan, tilt, zoom, and focus controls. Custom commands are set up by administrators, and are used for functions such as activating or deactivating the wiper of dome, according to the attached motorized device’s User’s Manual of.



## System Configuration

---

After installing the hardware, the next task required is to configure VPort 2140's settings. There are 3 configuration methods: via web access, via FTP, and via Telnet.

This chapter includes the following sections:

### □ System Configuration Via Web Access

- Using Setup Wizard
- Using the Application Wizard
- System
- Security
- Network
- Video
- COM 1 & COM 2
- Application
- Demo
- Homepage Layout
- View log file
- View parameters
- Factory default

### □ System Configuration Via FTP

- CONFIG ini

### □ System Configuration Via Telnet

- Telnet Commands
- System core debugging
- Monitor changed status of digital inputs
- Stop information dumping
- Query status of digital inputs
- Set digital outputs
- Erase snapshots stored in Flash memory
- Skip installation at next boot
- Reset network for new settings

- 
- Restore factory default settings
  - Reset system

## System Configuration Via Web Access

System configuration can be easily done remotely from Internet Explorer via the Web Server. There are two wizards, in addition to classified categories of system configurations, which provide user-friendly instructions to facilitate the setup task. Alternatively, administrators may type the system configuration URL, “http://<IP address of Video Server>/setup/config.html”, to enter the configuration page directly. Administrators who want to set certain options through the URL should refer to the relevant section in Chapter 6, URL Commands for advanced functions.

System configuration serves 5 purposes:

1. Since VPort 2140 Video Server is a networked video server, administrators should run the “**Setup wizard**,” or at least configure “**Security**,” “**Network**,” and “**Video**.”
2. To support external serial port devices, configure “**COM 1**,” “**COM 2**” and then “**Camera Setting**” under “**Video**.”
3. To utilize the built-in security and web attraction features, run the “**Application wizard**” or configure “**Application**” and “**Demo**.”
4. Administrators can adjust the system date and time under “**System**,” or configure different homepage layouts by configuring “**Homepage layout**.”
5. Video Server also provides other system maintenance options, including “**View log file**,” “**View parameters**,” and “**Factory default**.”

## Using Setup Wizard

The setup wizard will guide the administrator to enter the required information, including:

1. Host name
2. Current date and time
3. Administrator’s password
4. Video configuration and captions
5. Network settings

The administrator can exit the setup wizard at any time to preserve the current configuration. The setup wizard will give the administrator the option to reboot to validate the changes, or the administrators can decide to reboot later.

## Using the Application Wizard

VPort 2140 has two applications to choose from:

1. **Surveillance System**  
Create a security system by configuring the built-in motion detection and external sensors to integrate with an existing e-mail or FTP server, or external alarms. You may also use the weekly schedule feature for timed monitoring.
2. **Web Attraction**  
Customize the main page to your own style and set up accounts for your potential visitors.

To select one of these two applications, click on “Surveillance system” or “Web attraction” from the Applications wizard window shown below. After using Applications Wizard, Administrators can perform a more detailed configuration of the application parameters from the configuration’s **Application** page.

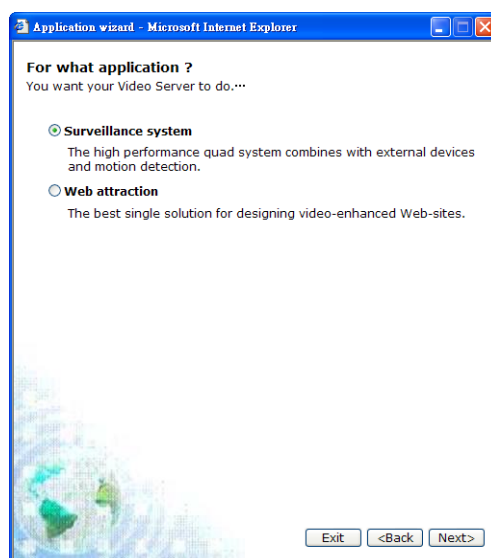

## System

### Host name

The host name will appear as the homepage title of the main page and over the video window on the main page. The maximum string length is 38 characters or 19 characters in double-byte-character systems, such as Chinese or Japanese systems.

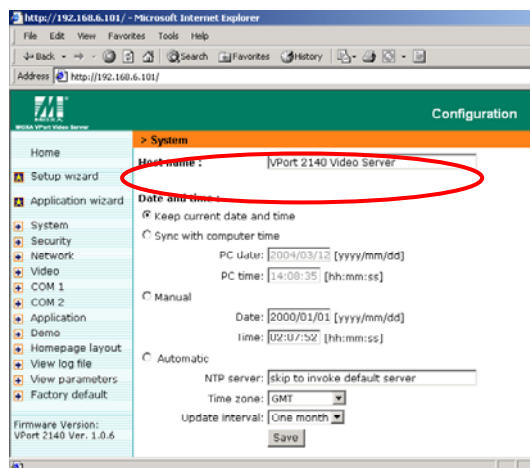

## Date and Time

The default setting for Date and Time is **Keep current date and time**. You may also choose from one of the following date and time configuration options:

1. The easiest way to adjust the date and time is to make the VPort **Sync with computer time**.
2. Select the **Manual** option if you wish to set the date and time manually by entering new settings.
3. Select the **Automatic** option to make the VPort synchronize automatically with timeservers over the Internet every month. However, synchronization may fail if the assigned **NTP server** cannot be reached, or the VPort is connected to a local network. Leaving the **NTP server** blank will force the VPort connect to default timeservers. Enter either the Domain name or IP address format of the timeserver as long as the DNS server is available. Do not forget to set the **Time zone** for local settings. Refer to Appendix G for your region's time zone.

Click on **Save** to validate changes.

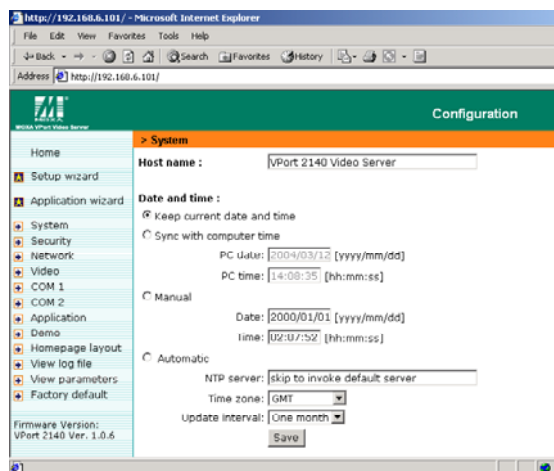

## Security

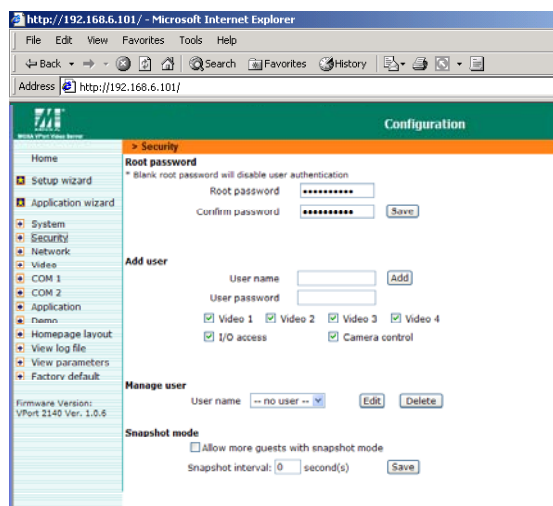

## Root password

To change the administrator's password, type the new password in both the **Root password** box and **Confirm password** box. The passwords you enter will be displayed in asterisks for security reasons. The maximum string length for a password is 14 characters. After clicking on **Save** to validate the new password, a window will open to ask the administrator for the new password to access the VPort.

## Add user

To add a new user, type the new user's name in the **Username** box, the password in the **User password** box, and select authorization level by checking **I/O access** or **Camera control**. Click on **Add** to insert the entry. The VPort 2140 Video Server has a total of 20 user accounts. Each user can be given independent access right of the external I/O access and camera control.

## Manage user

If the access rights of some users need to be changed, find the user name from the drop down list and click on **Edit**. A new window will appear for administrators to change the password and select a different authorization. Administrators can also delete the selected user by clicking on **Delete**. A message window will open next to confirm.

## Snapshot mode

A maximum of 20 users can view VPort's images at the same time. Administrators can select the **Allow more guests with snapshot mode** option to enable the snapshot mode for more users. In this case, when the number of users exceeds 20, users will see the main page in snapshot mode instead of seeing normal video images. Snapshot mode is very useful for web attraction. In this case, configure the **Snapshot interval** to achieve better performance. Increasing the time interval between snapshots allows more users to use snapshot mode.

Click on **Save** to validate changes.

## Network

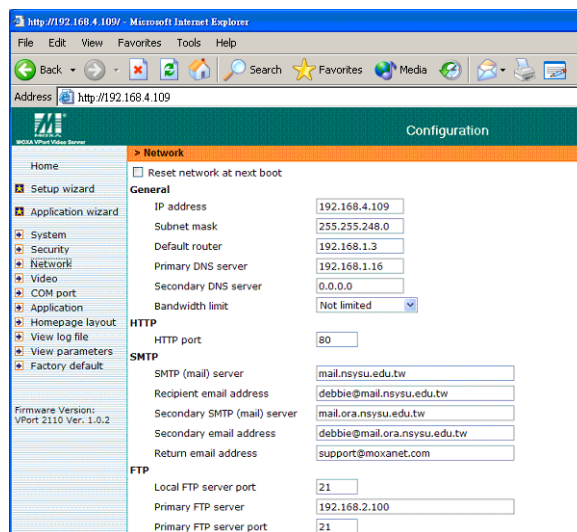

The screenshot shows the 'Configuration' page for the VPort 2140 Video Server, specifically the 'Network' section. The page is viewed in Microsoft Internet Explorer. The left sidebar contains a navigation menu with options like Home, Setup wizard, Application wizard, System, Security, Network (selected), Video, COM port, Application, Homepage layout, View log file, View parameters, and Factory default. The main content area is titled 'Configuration' and has a sub-section 'Network'. At the top of the Network section, there is a checkbox labeled 'Reset network at next boot'. Below this, the 'General' section includes fields for IP address (192.168.4.109), Subnet mask (255.255.248.0), Default router (192.168.1.3), Primary DNS server (192.168.1.16), Secondary DNS server (0.0.0.0), and Bandwidth limit (Not limited). The 'HTTP' section has a field for HTTP port (80). The 'SMTP' section includes fields for SMTP (mail) server (mail.nsysu.edu.tw), Recipient email address (debbie@mail.nsysu.edu.tw), Secondary SMTP (mail) server (mail.ora.nsysu.edu.tw), Secondary email address (debbie@mail.ora.nsysu.edu.tw), and Return email address (support@moxanet.com). The 'FTP' section includes fields for Local FTP server port (21), Primary FTP server (192.168.2.100), and Primary FTP server port (21).

## Reset network at next boot

To eliminate incautious mistakes during installation, VPort 2140 Video Server will be in installation mode whenever it starts up, unless **Reset network at next boot** is disabled. This option can also be disabled by selecting the IP Installer program's **Use this IP whenever system boots** option.

1.  **Use this IP whenever system boots** =  **Reset network at next boot**

VPort 2140 Video Server will skip the installation at the next boot, and the IP Installer program will not show this VPort 2140. In this case, the VPort cannot be accessed and reconfigured over the network using the IP Installer program if no one remembers the IP address, unless the VPort's reset button is used first to restore factory default settings. The advantage of enabling the "Use this IP whenever the system boots" option is that the VPort



will automatically operate normally after being restarted after a power loss.

2.  Use this IP whenever system boots =  Reset network at next boot

In this case, the installation process must be performed again when system reboots. This is the default setting.

---

**ATTENTION**

You can ignore this option if you are using the Modem Dial-up connection.

---

## General

Administrators may need to modify the network settings to connect to an existing network, since the subnet mask in some broadband service may differ from the default value of 255.255.255.0, and service providers may assign more specific network settings. Administrators should change the configuration to the settings given by the service provider. The configuration may include **IP address**, **Subnet mask**, **Default router**, **Primary DNS server**, and **Secondary DNS server**. After changing network settings, make sure to uncheck the “Reset network at next boot option” to avoid the installation starting up again the next time the system restarts. Otherwise, existing network settings will be erased at the next start.

In addition, administrators can limit the bandwidth used by a VPort 2140 Video Server according to priority and importance of location. Limiting bandwidth is useful for balancing network utilization when multiple VPorts are installed on the same network. This method is more effective than just changing image quality, and is able to achieve better performance with adequate image size and quality.

## HTTP

For security or network integration, administrators can hide the server from the general HTTP port by changing the default HTTP port of 80 to a different port number. Administrators should have enough network knowledge to change the default port.

## SMTP

VPort 2140 Video Server not only plays the role of server, but also actively connects to outside servers to send alarm messages or snapshots. If the administrator has set up some applications in either event mode or sequential mode, the VPort will send out snapshots once these conditions occur.

1. To activate the e-mail function, enter correct settings for **SMTP (mail) server’s domain name/IP address** and **Recipient email address**.
2. **Secondary SMTP (mail) server’s domain name/IP address** and **Secondary email address** are provided for a backup connection when the primary SMTP server fails.
3. **Return email address** is the address the email is returned to when the SMTP server rejects email due to failure. Some ISPs may reject the email if the address is invalid.

---

**ATTENTION**

If the settings are correct when the VPort starts up, it will send out a system log via e-mail instead of uploading the log via FTP. Note that if the **Return email address** is not set, the e-mail system will not work properly.

---

---

## FTP

FTP is the other means available for VPort 2140 Video Server to send out alarm messages and snapshots. To send the system log files described in the above paragraph via FTP, the SMTP server should be erased.

1. **Local FTP server port** can also be changed to a setting different from the default setting of 21. Administrators should have enough network knowledge to change the default port.
2. Administrators must enter correct **Primary FTP Server**, **Primary FTP user name**, and **Primary FTP password**.
3. **Primary FTP remote folder** is the sub-folder in the remote FTP server.
4. If the remote FTP server's port is changed to a setting different from 21, make sure to set the real port to **Primary FTP server port**.
5. If the local network is protected by a firewall to prevent it from initiating an FTP connection from the remote FTP server, you may be able to connect to the FTP server, but be unable to place a file on the server due to data channel connection failure. Check **Primary FTP passive mode** for a passive transfer solution.
6. Another set of **Secondary** server settings is also provided for a backup connection.

---

### ATTENTION



In either e-mail or FTP, the primary server information should be entered first. If the primary server is not set, the related FTP or email will be cancelled. Note that it may take time to connect to the secondary server after the first one fails, and it may affect some applications when conditions occur too often.

---

## Save the modification

After all necessary modifications are made, click on **Save** to store the modifications. A warning message will appear for confirmation. After clicking on **OK**, the VPort will automatically restart. If the **Reset network at next boot** option is checked, perform the software installation again. Otherwise, the VPort will boot up automatically using the new configuration settings.

---

### ATTENTION



If you make any changes to the settings in this web page, the system will restart to validate those changes. Make sure that every field is correctly typed before clicking on Save. If the VPort fails to respond due to incorrect settings, perform the restore procedures and run the software installation.

---

---

### ATTENTION



Administrators should take note that the basic network settings, including IP address, subnet mask, default router, and DNS servers, should be set to factory defaults before switching the network interface from "Ethernet" to "modem" or from "modem" to "Ethernet."

---

## Video

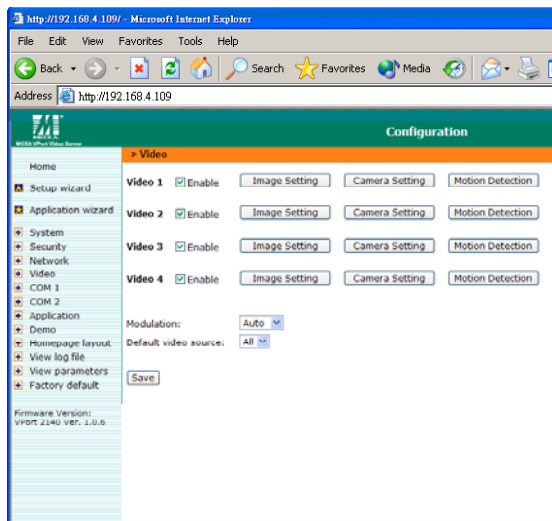

To allow the VPort 2140 to show cameras' video images, check the  Enable item for each camera. There are 3 kinds of settings for each camera's video in this page.

## Image setting

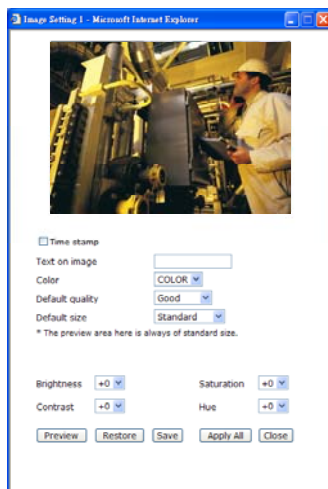

### 1. Show Time stamp in image and Text on image

When these options are enabled, Time stamp and Text on image will be shown on the image for reference. The time stamp is captured from the Video Server's date and time that are maintained by an on-board real-time clock.

### 2. Color, Default size, and Default quality

The **Color** setting depends on the connected camera. The "B/W" option can speed up the encoder. The **Default size** option is the default size of the video window when the user first connects to the VPort. The **Default quality** option is the default quality when users first connect to the VPort.

### 3. Brightness, Contrast, Saturation, and Hue

To adjust image settings for the best visual quality, click on Image Setting to open a motion picture window. Four fields need to be configured, including **Brightness**, **Contrast**, **Hue**, and **Saturation**. Each field has eleven levels, ranging from -5 to +5. While adjusting, administrators can click on **preview** to see if the settings are appropriate before clicking on **Save**. If the adjustment is not satisfactory, administrators can click on **Restore** to restore the original

settings. After the configuration is done, click on **Close** to close this window. If the configurations are changed without saving, they will only be used until the next time the system starts up.

## Camera Setting



### 1. Camera type

The default camera type of VPort 2140 is **Fixed camera**, which means it is a general camera without motorized function. If you wish to select a PTZ camera, you also need to select the COM port that this PTZ camera is connected to, and the PTZ camera's ID to activate it. Click on **Save** to validate the camera type.

### 2. Preset position setting of Motorized PTZ camera

Below the camera type setting is the image of this camera, the control buttons of PAN/ TILT/ ZOOM/ FOCUS and the preset position setting. The administrator can use the control buttons to operate the camera's image to set the preset position of this motorized PTZ camera.

## Motion Detection



Each camera has its own separate motion detection settings. The settings, which include **Object size** and **Sensitivity**, allow administrators to fine tune the VPort to fit the environment:

1. **Object size** sets the minimum size of objects whose motion will be detected. (E.g., if Object

size = 30%, then the system will only detect the motion of objects that occupy an area larger than 30% of the total monitored area; the motion of objects with size less than 30% of the monitored area will NOT be detected.)

2. **Sensitivity** sets the measurable difference between two sequential images to indicate motion.

A larger object size and lower sensitivity will cause the VPort to ignore small variations in images. When the motion amplitude of some objects in the monitored screen exceeds the settings, a white letter **M** with red background color will appear in the upper-right corner to the window.

## ATTENTION



Motion detection is provided as a reference because it is environment-dependent. When the settings are configured to be very sensitive to motion, some triggered events might be false alarms, since in fact there is only a tiny difference between sequential images. False alarms can be triggered by the flashing of florescent lights, shifting of shadows, etc.

Before completing the Video configuration, 3 items need to be confirmed.

## Modulation

There are 3 types of **Modulation**. Administrators can set the auto-detected condition during initialization by selecting **Auto**, but can still set it manually by selecting **NTSC** or **PAL**. When you change the camera modulation, a warning message will pop up to inform you that the system will restart to validate the new modulation.

## ATTENTION



Although the analog cameras have 2 different standards, NTSC or PAL, all of the cameras connected to VPort 2140 Video Server should use the same standard.

## Default Video Source

Administrators can set the default viewing mode for web home page in camera 1, 2, 3, 4, or all in quad.

## Save the modification

After all necessary modifications are made, click on **Save** to store the modifications. If you have changed the modulation type, the VPort will automatically restart. If the **Reset network at next boot** option is checked, perform the software installation again. Otherwise, the VPort will boot up automatically using the new configuration settings.

## COM 1 & COM 2

There are 2 COM ports, COM 1 and COM 2, in VPort 2140 Video Server for connecting the external devices, such as Motorized PTZ controller, Modem, or Multiplexer.

	RS-232	RS-485	Speed
COM 1	DB9 Male	Terminal block for Data+, Data-	Max. 115.2 Kbps
COM 2	DB9 Male	N/A	Max. 115.2 Kbps

---

## Interface mode

The COM 1 supports 2 serial interfaces, although only one interface can be used at a time. Depending on the interface used by the attached device, administrators must set the **Interface mode** to either RS-232 or RS-485.

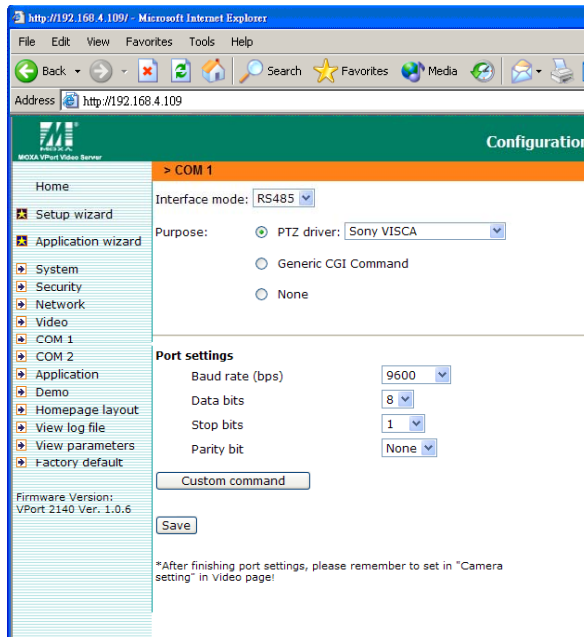

The COM 2 only supports RS-232 interface. For this reason, there is no interface mode selection for COM 2.

---

### ATTENTION



RS-232 interface is used via the DB9 COM port, and RS-485 interface is used via the GPIO. These 2 interfaces in COM 1 cannot be used at the same time.

---

## Purpose

The COM port connection has 3 purposes:

1. If the attached device is a PTZ camera, administrators must select the correct PTZ model under PTZ driver options, since each PTZ camera has its own protocols for the PTZ functions. Refer to Appendix B, **Settings for Supported PTZ Cameras**, to find out the PTZ cameras that MOXA VPort 2140 Video Server supports. If the attached PTZ camera is not supported by the VPort, administrators can select Custom Camera to enter the proprietary commands for pan, tilt, zoom, and focus control.
2. If the attached device is not a PTZ camera, but another serial device, such as a video multiplexer, etc., administrators can select the **Generic CGI command** to control the device via CGI commands. For external device control, refer to Chapter 5, **Advanced Applications**, under the **URL Commands for DI/DO and Camera's Actions settings** section for more details.
3. The default setting is **None**, which means that no other device is connected to the COM port.

## Port Settings

After selecting the correct PTZ driver or Generic CGI command option, the next thing administrators must do is configure Port settings, including Baud rate, Data bits, Stop bits, and Parity bit. If the attached device is a PTZ camera, refer to Appendix B, **Settings for Supported**

**PTZ Cameras**, for default settings of the supported PTZ cameras.

## Custom command

VPort 2140 Video Server provides 5 custom commands in addition to the general pan, tilt, zoom, and preset functions. Administrators can click on **Custom Command** to configure, and refer to the manual enclosed with the attached PTZ camera to set up frequently-used functions. The Command should be entered in ASCII format. The VPort will translate the commands into binary code and send them out through the serial port. For instance, a text string of **8101ABCDEF** will be translated into five bytes of hexadecimal **81**, **01**, **AB**, **CD**, and **EF**. The maximum length of a command string is 60, which is equivalent to 30 hexadecimal bytes. The **Display string** is for the text on the command buttons and should be less than 8 characters. If **Custom Camera** is selected, there will be more commands for PTZF that relate to custom camera.

## Application

VPort 2140 Video Server provides 4 major applications.

1. **Weekly schedule:** Administrators can set up the Application schedule by week.
2. **External script files:** For advanced applications, administrators can program command scripts, which can be uploaded to the VPort 2140 Video Server.
3. **Event operation:** Administrators can set trigger conditions by selecting **Motion Detected**, or **DI Condition**, etc., options, and trigger actions by selecting **Trigger output alarm while input condition matched**, etc., options.
4. **Sequential mode:** Administrators can set the sequential snapshot mode to send the snapshot

by time interval.

Administrators can use combinations of options on the application web page to perform various useful security applications. Although most settings will be done automatically by the **Application Wizard**, administrators can also make adjustments to the settings from this page.

To set up the 4 applications that VPort 2140 Video Server provides, administrators must have a certain level of knowledge about the setting items listed in the **Application** web page. Below is the table that separates the setting items into 4 levels. Higher-level settings will not be activated unless lower-level items are checked.

Level 1	Level 2	Level 3	Level 4	
<input type="checkbox"/> Weekly schedule  <input type="checkbox"/> All the time except for the above schedule		<input type="checkbox"/> Sun <input type="checkbox"/> Mon <input type="checkbox"/> Tue <input type="checkbox"/> Wed <input type="checkbox"/> Thu <input type="checkbox"/> Fri <input type="checkbox"/> Sat snapshots begin at [hh:mm:ss] snapshots stop at [hh:mm:ss]		
	<input type="checkbox"/> Enable the external script file to ignore the following settings			
	<input type="checkbox"/> Event operation	<input type="checkbox"/> Show alert in image		
		Trigger condition	Motion Detected on: <input type="checkbox"/> Video 1 <input type="checkbox"/> Video 2 <input type="checkbox"/> Video 3 <input type="checkbox"/> Video 4 DI condition: DI 1: Disable, High, Low, Rising, Falling DI 2: Disable, High, Low, Rising, Falling DI 3: Disable, High, Low, Rising, Falling DI 4: Disable, High, Low, Rising, Falling	
		Trigger action <input type="checkbox"/> Send snapshot while trigger condition(s) match	Delay <input type="checkbox"/> second(s) to trigger output alarm DO condition: DO 1: Disable, Open, Close DO 2: Disable, Open, Close Snapshot on: <input type="checkbox"/> Video 1 <input type="checkbox"/> Video 2 <input type="checkbox"/> Video 3 <input type="checkbox"/> Video 4 Take <input type="checkbox"/> snapshot(s) with <input type="checkbox"/> tenth seconds interval after the event	
		<input type="checkbox"/> Sequential mode		Snapshot every <input type="checkbox"/> tenth seconds
		<input type="checkbox"/> Send snapshot by email		
		<input type="checkbox"/> Send snapshot by FTP	<input type="checkbox"/> FTP put snapshots with date and time suffix	

### Weekly schedule

The Weekly schedule is provided for daily security applications. Administrators can select any weekday from Monday to Friday with the daily schedule set from 08:00 am to 20:00 pm when no one is available to perform event checking. If the security system is installed in an office for which no one is present on nights or weekends, administrators can still set the time period as above, from 08:00 am to 20:00 pm, but remember to select **All the time except for the above schedule** to let the program run during nights and weekends.

#### ATTENTION



Either “Weekly schedule” or “All the time except for the above schedule” must be selected, or the applications described in the following sections will not work properly.



## Enable the external script file to exclude the following settings

Administrators can write a script named **SCRIPT.TXT** to match the additional software according to the **Command Script for DI/DO and Camera's Actions Setting** section from Chapter 5. After uploading this script to the VPort via FTP, check the option **Enable the external script file to exclude the following settings**. Otherwise the VPort will operate according to the settings under **Enable the external script file to exclude the following settings** option.

## Event operation

Event operation is for setting security applications.

### 1. Show alert in image.

VPort 2140 Video Server can show the event trigger condition in the video image on the homepage. If motion is detected (based on the motion settings), an **M** will appear on the upper-right corner of the image. As long as **Show alert in image** is checked, the **M** will appear in the image to indicate that motions have been detected. If there are any sensors attached to the digital inputs, the administrator can set the state to fire alarm.

#### ATTENTION



The option **Show alert in image** may be set when running the application wizard or configuring motion detection. Administrators should manually uncheck this option if no indication of motion detection is needed in the image.

### 2. Trigger Condition

- a. **Motion Detected.** The administrator can check the boxes of Video 1, Video 2, Video 3 and Video 4 to enable Video Motion Detection (VMD), which is set in the Video configuration web page (or you can click on the **\*Click on each hyperlink of video to configure motion detection** link below to configure the appropriate parameters) as the trigger condition.
- b. **DI Condition.** There are 4 Digit Inputs in VPort 2140. The administrator can set the DI's conditions, including **Input is High**, **Input is Low**, **Input is Rising**, and **Input is Falling**. The edge trigger like Rising or Falling is generally used to detect the emerging signal from the external sensor.

### 3. Trigger Action

Once an event occurs, the administrator can set up 2 trigger actions: relay output alarms or snapshot image.

- a. **DO Action.** There are 2 DOs (Relay output) for connecting the alarms. Administrators can set the trigger output alarm when the DI or Video Motion Detection conditions are met. Once an event occurs, the administrator can select the **Delay  second(s) after event** option to drive a device attached to the digital outputs several seconds after the event happens and/or send snapshots that are taken right at the moment.
- b. **Snapshot.** The administrator can set up the snapshot action when the DI or Video Motion Detection conditions are met. There are 3 snapshots will be taken when an event occurs, which is in the tenth second interval by named as pre-event, the moment of event and post-event. If the administrator thinks the snapshots are not enough, more snapshots can be taken after the event by configuring **Take  snapshot(s) with  tenth seconds interval after the event**. Three snapshots of each channel can also be downloaded via FTP or HTTP URL. The time interval of these 3 snapshot images can be set on (refer to the **"Download Event-triggered Snapshots"** section from Chapter 5 for more details).
- c. **Send snapshot while trigger condition(s) match.** To activate the function of snapshot sent via E-mail or FTP server, this item should be checked.

---

## Sequential Mode

With this feature, VPort 2140 Video Server can upload snapshots periodically to an external E-mail or FTP server as a live video source. The interval can be set from a tenth of a second to several hours in Snapshot every  tenth seconds. The external E-mail or FTP server must be set up in the Network configuration page.

## Send Snapshot by Email or FTP

Snapshots taken by either event operation or sequential mode can be sent by **E-mail** or **FTP**, which are set in the **Network** configuration page. If email is chosen, the snapshots of the video channel will be attached to the emails. If FTP is chosen, administrators can choose to add date and time in the file name of the snapshots by checking **FTP file name with date and time suffix**. If the snapshots are used as the live video source, the date and time suffix can be eliminated to update the same source file.

---

**ATTENTION**

In Sequential mode, the VPort will send out snapshots according to interval and period settings. If snapshot files are intended for quick updates, it is better to skip the date and time suffix, in which case the file name will be video.jpg. If the snapshots are used for occasional monitoring, suffixing with date and time can help administrators easily classify the snapshots.

---

---

**ATTENTION**

Compared to the FTP method, email will induce more delay, although email can notify users more promptly.

---

## View Snapshot

The administrator can check the latest pre-event, the moment of event and post-event snapshots by clicking on the **View Snapshot** button.



## Save

Click on **Save** to activate the applications when you finish the settings.

## Demo

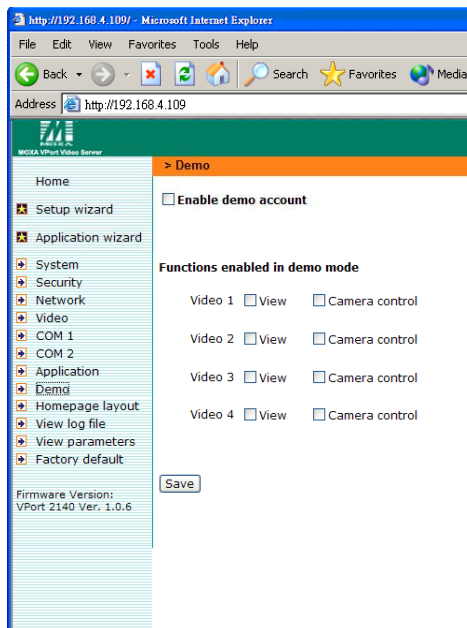

VPort 2140 Video Server provides a demonstration mode to allow general access for demonstration purposes. To set up the demonstration mode, administrators must choose the services to be permitted by each camera. If administrators select the view option, users may use demo as the username to access the VPort. In this case, leave the password field blank. Administrators also can select control camera for the demo account. Separating the demo account from the primary users can prevent interference with normal operations.

Click on **Save** to validate changes.

## Homepage layout

VPort 2140 Video Server allows administrators to customize the layout of the Video Server's homepage.

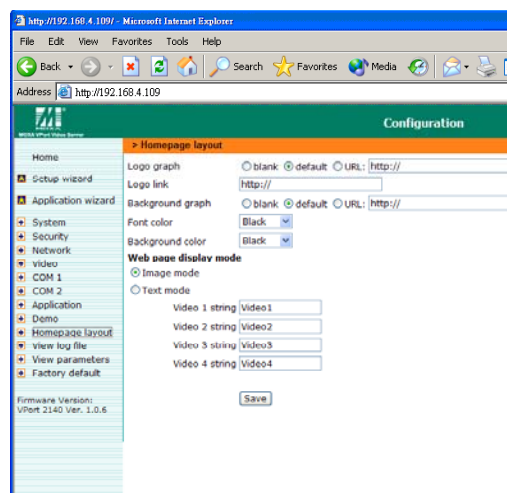

## Logo graph

1. Select the blank option to hide the logo figure, which appears in the upper-left corner of the homepage.

- 
2. The “default” logo is the MOXA logo.
  3. An external logo or image can be used by selecting the **URL** option, and typing the url for the image in the text input box.

## Logo link

Administrators set up the Logo with a **Logo link**, so that visitors are directed to another web address when they click on the logo.

## Background graph

As with **Logo graph**, **Background graph** gives administrators the ability to customize the background as **blank**, **default**, or an external image by selecting the **URL** option, and typing the url for the image in the text input box.

## Font and Background color

The **Font color** and **Background color** can be chosen from sixteen custom colors.

---

**ATTENTION**

The **Background color** option is active only when **Background graph** is set as **blank**.

---

## Web page display mode

There are two homepage display modes. One is **Image mode**, which uses icons to link to the various functions; the other is **Text mode**, which uses mostly text to link to the various functions. Administrator can change the string content manually.

---

**ATTENTION**

See the **Customize graphics in homepage** section from Chapter 5 to see how to replace the default images for the Video Server’s log, background, and buttons.

---

## View log file

The system log contains useful information, including current system configuration and activity history with timestamp for tracking.

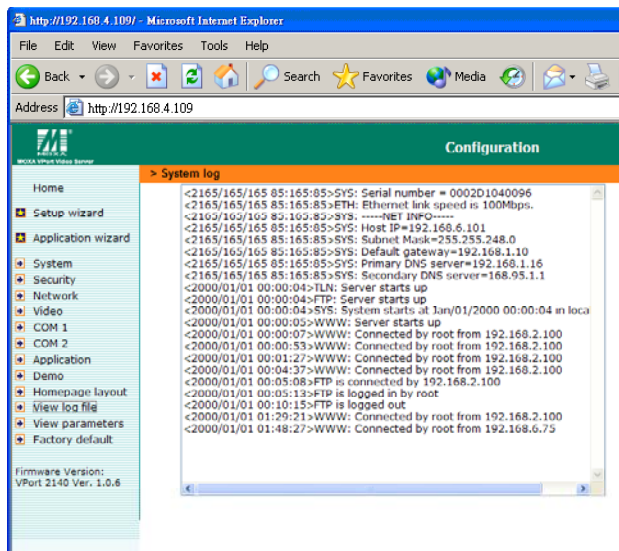

## View parameters

Clicking on **View parameters** allows you to view all system parameters, which are listed by category. The content is the same as CONFIG.INI of VPort 2140 Video Server.

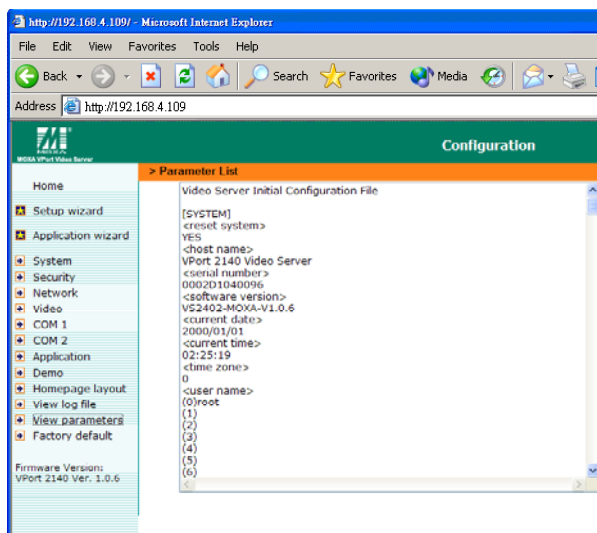

## Factory default

This function is used to restore the Video Server to its factory default settings, so that any changes that were made previously will be lost. After clicking **OK**, the system will restart. Note that it will take some time for the restore action to finish. You will need to run the software installation program to set up the network.

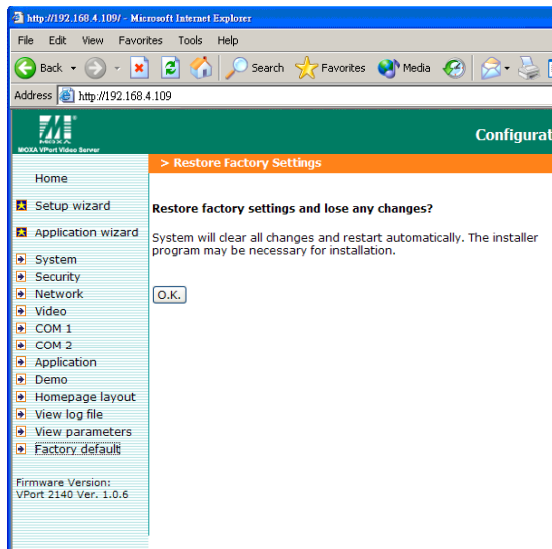

## System Configuration Via FTP

### CONFIG.INI

FTP can be used to configure VPort 2140 Video Server much more quickly than configuring from web browser, particularly when configuring multiple Video Servers. To configure a Video Server via FTP, first download the parameter file, CONFIG.INI, customize each field, and then upload the file to the Video Server to install the new settings. To log into the FTP daemon, enter “root” as the user name, and use the same password used when connecting to the Web server. The MAC address (no dash, all upper case) of Video Server is the password for initial access.

The CONFIG.INI file has eight categories: [SYSTEM], [LAYOUT], [NETWORK], [VIDEO], [SERIAL1], [SERIAL2], [ALERT], and [DEMO]. The category names in square brackets should be in upper case. The item names in angle braces should be in lower case. Some items related to disable/enable should use the keywords “YES”/“NO”. The number zero (0) entry in <user name> and <user password> is for administrators, i.e. “root”. Video Server will restart automatically as soon as the file is uploaded and accepted. If administrators want to cancel the reboot procedure after putting config.ini via FTP, then set the first item, <reset system>, to NO. But it will take effect only once, and show YES in the download config.ini file the next time.

A sample CONFIG.INI is shown in the table below. The text in *italics* describes the characteristics of the field, and the ***bold italic characters*** are the options for the field.

Video Server Initial Configuration file	
[SYSTEM]	
<reset system>	
YES	<i>or NO</i>
<host name>	
VPort 2140 Video Server	<i>string with maximum of 38 characters</i>
<serial number>	
0002D1040972	<i>read-only</i>
<software version>	
VS2402-MOXA-V1.0.6	<i>read-only</i>
<current date>	
2003/01/01	<i>read-only</i>
<current time>	
12:34:56	<i>read-only</i>

<time zone>	
0	<i>from 12 to -12</i>
<user name>	
(0)root	<i>read-only</i>
(1)	<i>string with maximum of 14 characters</i>
(2)	<i>the rest are the same as above</i>
(3)	
(4)	
(5)	
(6)	
(7)	
(8)	
(9)	
(10)	
(11)	
(12)	
(13)	
(14)	
(15)	
(16)	
(17)	
(18)	
(19)	
(20)	
<user password>	
(0)0002D1040972	<i>string with maximum of 14 characters</i>
(1)	<i>the rest are the same as above</i>
(2)	
(3)	
(4)	
(5)	
(6)	
(7)	
(8)	
(9)	
(10)	
(11)	
(12)	
(13)	
(14)	
(15)	
(16)	
(17)	
(18)	
(19)	
(20)	
<more guests enabled>	
NO	<i>or YES to enable snapshot mode</i>
<more guests interval>	
0	<i>snapshot interval in seconds</i>
<language>	
0	
[LAYOUT]	
<layout type>	
1	<i>image mode or 0 for text mode</i>
<font color>	<i>0-black, 1-white, 2-green, 3-maroon, 4-olive, 5-navy, 6-purple, 7-gray, 8-yellow,</i>
1	

<background color>	9-lime, 10-aqua, 11-fuchsia, 12-silver,
0	13-red, 14-blue, 15-teal,
<logo type>	
1	default image, or 0 for blank, or 2 from URL
<background type>	
1	default image, or 0 for blank, or 2 from URL
<logo source>	
http://	URL of logo type 2, maximum of 80 characters
<background source>	
http://	URL of logo type 2, maximum of 80 characters
<logo link>	
http://	reference link of logo, max. of 80 characters
<button name>	
(0)Video1	Used in text mode, max. 14 characters
(1)Video2	Used in text mode, max. 14 characters
(2)Video3	Used in text mode, max. 14 characters
(3)Video4	Used in text mode, max. 14 characters
<com1 speedlink name>	Name of custom PTZ commands
(0)	string with maximum of 8 characters
(1)	string with maximum of 8 characters
(2)	string with maximum of 8 characters
(3)	string with maximum of 8 characters
(4)	string with maximum of 8 characters
<com2 speedlink name>	Name of custom PTZ commands
(0)	string with maximum of 8 characters
(1)	string with maximum of 8 characters
(2)	string with maximum of 8 characters
(3)	string with maximum of 8 characters
(4)	string with maximum of 8 characters
[NETWORK]	
<install enabled>	
YES	reset IP whenever system boots or <b>NO</b>
<ppp enabled>	
YES	obsolete
<ethernet address>	
00-02-D1-04-09-72	read-only
<host ip>	
192.168.0.207	standard IP format
<subnet mask>	
255.255.255.0	standard IP format
<gateway ip>	
0.0.0.0	standard IP format
<primary name server>	
0.0.0.0	standard IP format
<secondary name server>	
0.0.0.0	standard IP format
<ntp enabled>	
NO	or <b>YES</b>
<network timing server>	
	IP address or domain name
<smtp mail server>	
	IP address or domain name
<mail recipient address>	
	string with maximum of 80 characters
<mail return address>	
VPort 2140 Video Server	string with maximum of 80 characters
<backup smtp mail server>	



	<i>IP address or domain name</i>
<backup mail recipient address>	
	<i>string with maximum of 80 characters</i>
<local ftp port>	
21	<i>or 1024 to 65535</i>
<ftp server>	
	<i>IP address or domain name</i>
<ftp port>	
21	<i>or 1024 to 65535</i>
<ftp username>	
	<i>string with maximum of 14 characters</i>
<ftp password>	
	<i>string with maximum of 14 characters</i>
<ftp init path>	
	<i>string with maximum of 40 characters</i>
<ftp passive>	
NO	<i>or YES</i>
<backup ftp server>	
	<i>IP address or domain name</i>
<backup ftp port>	
21	<i>or 1024 to 65535</i>
<backup ftp username>	
	<i>string with maximum of 14 characters</i>
<backup ftp password>	
	<i>string with maximum of 14 characters</i>
<backup ftp init path>	
	<i>string with maximum of 40 characters</i>
<backup ftp passive>	
NO	<i>or YES</i>
<http server port>	
80	<i>or 1024 to 65535</i>
<bandwidth limit>	
0	<i>or 64000, 128000, 256000, 512000, 768000, 1000000, 1500000, 2000000</i>
[VIDEO]	
<default video>	
1	<i>or 2, 3, 4, 5 (video all)</i>
<camera modulation>	
AUTO	<i>or MANUAL. NTSC or PAL will be ignored when set to AUTO</i>
NTSC	<i>or PAL, ignored when set to AUTO but can be notification</i>
<video is open>	
(0)YES	<i>or NO</i>
(1)YES	<i>or NO</i>
(2)YES	<i>or NO</i>
(3)YES	<i>or NO</i>
<video mapped to COM port>	
(0)0	<i>or 1, 2</i>
(1)0	<i>or 1, 2</i>
(2)0	<i>or 1, 2</i>
(3)0	<i>or 1, 2</i>
<video mapped to ID>	
(0)0	<i>depending on the camera</i>
(1)0	<i>depending on the camera</i>
(2)0	<i>depending on the camera</i>
(3)0	<i>depending on the camera</i>
<overlay timestamp>	

(0)NO	or <b>YES</b>
(1)NO	or <b>YES</b>
(2)NO	or <b>YES</b>
(3)NO	or <b>YES</b>
<caption text>	
(0)	<i>string of max. 14 characters</i>
(1)	<i>string of max. 14 characters</i>
(2)	<i>string of max. 14 characters</i>
(3)	<i>string of max. 14 characters</i>
<colored video>	
(0)YES	or <b>NO</b> for B/W
(1)YES	or <b>NO</b> for B/W
(2)YES	or <b>NO</b> for B/W
(3)YES	or <b>NO</b> for B/W
<video quality>	
(0)150	<i>For Medium, 75 for Standard, 37 for Good,</i>
(1)150	<i>18 for Detailed, 8 for Excellent for</i>
(2)150	
(3)150	
<default size>	
(0)1	<i>for Half, 2 for Standard, 3 for Double,</i>
(1)1	<i>4 for Halfx2, 5 for Standardx2</i>
(2)1	
(3)1	
<brightness>	
(0)0	<i>between 5 and -5</i>
(1)0	<i>between 5 and -5</i>
(2)0	<i>between 5 and -5</i>
(3)0	<i>between 5 and -5</i>
<contrast>	
(0)0	<i>between 5 and -5</i>
(1)0	<i>between 5 and -5</i>
(2)0	<i>between 5 and -5</i>
(3)0	<i>between 5 and -5</i>
<hue>	
(0)0	<i>between 5 and -5</i>
(1)0	<i>between 5 and -5</i>
(2)0	<i>between 5 and -5</i>
(3)0	<i>between 5 and -5</i>
<saturation>	
(0)0	<i>between 5 and -5</i>
(1)0	<i>between 5 and -5</i>
(2)0	<i>between 5 and -5</i>
(3)0	<i>between 5 and -5</i>
[SERIAL 1]	
<data bits>	
0	
<stop bits>	
0	
<parity bits>	
0	<i>None, 1 for Odd, 2 for Even</i>
<baud rate>	
0	
<ccd model>	
0	<i>None, 1 for Generic, 2 for Sony VISCA, 3 for Canon VC-C1, 4 for Canon VC-C3, 5 for Canon VC-C4, 6 for DynaDome,</i>

	<i>7 for Pelco D, 8 for LiLin, 9 for Ernitec, 10 for Custom Camera</i>
<uart mode>	
RS232	<i>or RS485</i>
<speedlink commands>	
(0)	<i>string of maximum 60 characters</i>
(1)	<i>string of maximum 60 characters</i>
(2)	<i>string of maximum 60 characters</i>
(3)	<i>string of maximum 60 characters</i>
(4)	<i>string of maximum 60characters</i>
<custom ccd commands>	
HOME	<i>string with maximum of 60 characters</i>
UP	<i>string with maximum of 60 characters</i>
DOWN	<i>string with maximum of 60 characters</i>
LEFT	<i>string with maximum of 60 characters</i>
RIGHT	<i>string with maximum of 60 characters</i>
TELESCOPE	<i>string with maximum of 60 characters</i>
WIDE	<i>string with maximum of 60 characters</i>
NEAR	<i>string with maximum of 60 characters</i>
FAR	<i>string with maximum of 60 characters</i>
[SERIAL 2]	
<data bits>	
0	
<stop bits>	
0	
<parity bits>	
0	<i>None, 1 for Odd, 2 for Even</i>
<baud rate>	
0	
<ccd model>	
0	<i>As same as [SERIAL1]</i>
<uart mode>	
RS232	
<speedlink commands>	
(0)	<i>string of maximum 60 characters</i>
(1)	<i>string of maximum 60 characters</i>
(2)	<i>string of maximum 60 characters</i>
(3)	<i>string of maximum 60 characters</i>
(4)	<i>string of maximum 60characters</i>
<custom ccd commands>	
HOME	<i>string with maximum of 60 characters</i>
UP	<i>string with maximum of 60 characters</i>
DOWN	<i>string with maximum of 60 characters</i>
LEFT	<i>string with maximum of 60 characters</i>
	<i>string with maximum of 60 characters</i>

RIGHT	
	<i>string with maximum of 60 characters</i>
TELESCOPE	
	<i>string with maximum of 60 characters</i>
WIDE	
	<i>string with maximum of 60 characters</i>
NEAR	
	<i>string with maximum of 60 characters</i>
FAR	
	<i>string with maximum of 60 characters</i>
[ALERT]	
<script file enabled>	
NO	<i>or YES to activate external script</i>
<motion detection channel enabled>	
(0)NO	<i>or YES</i>
(1)NO	<i>or YES</i>
(2)NO	<i>or YES</i>
(3)NO	<i>or YES</i>
<snapshot channel enabled>	
(0)NO	<i>or YES</i>
(1)NO	<i>or YES</i>
(2)NO	<i>or YES</i>
(3)NO	<i>or YES</i>
<series snapshot channel enabled>	
(0)NO	<i>or YES</i>
(1)NO	<i>or YES</i>
(2)NO	<i>or YES</i>
(3)NO	<i>or YES</i>
<application mode>	
0	<i>disabled, 1 for Sequential, 10 for motion detection event, 12 for DI event</i>
<visual alert>	
NO	<i>or YES</i>
<upload method>	
0	<i>FTP, 1 for email</i>
<file with time suffix>	
YES	<i>or NO</i>
<percentage of object size over screen>	
(0)10	<i>1 to 99</i>
(1)10	<i>1 to 99</i>
(2)10	<i>1 to 99</i>
(3)10	<i>1 to 99</i>
<percentage of sensitivity>	
(0)90	<i>1 to 99</i>
(1)90	<i>1 to 99</i>
(2)90	<i>1 to 99</i>
(3)90	<i>1 to 99</i>
<seconds to snapshot periodically>	
0	
<time to start snapshot>	
00:00:00	<i>24 hours format</i>
<time to stop snapshot>	
00:00:00	<i>24 hours format</i>
[DEMO]	
<demo enabled>	
NO	<i>or YES</i>

<PTZ enabled>	
(0)NO	or <b>YES</b>
(1)NO	or <b>YES</b>
(2)NO	or <b>YES</b>
(3)NO	or <b>YES</b>
<video is open>	
(0)NO	or <b>YES</b>
(1)NO	or <b>YES</b>
(2)NO	or <b>YES</b>
(3)NO	or <b>YES</b>
[SYSTEM ADDON]	
<NTP Update Interval>	
3	

## System Configuration Via Telnet

### Telnet Commands

Video Server has a Telnet daemon that allows administrators to access some seldom used functions. Using any general terminal program to connect to Video Server will prompt the user for a password. The Username is not requested since only administrators can access the Telnet daemon. The password is the same as that used for web access. After logging in, type “help” for the command list. If “debug” or “dinote” is not executed, Telnet will disconnect automatically after being idle for 1 minute.

### System core debugging

General activities are recorded into SYSTEM.LOG continuously, but information about abnormal status is not recorded. Administrators can type the “debug” command to examine in-depth core debugging information. This causes Video Server to start dumping the detailed debugging information while the system is running. This is useful for examining if any errors have occurred when the system operates abnormally. The stored information will be cleared automatically after the dump. Video Server will continue to dump new messages unless the connection is broken. If Telnet is not connected, messages will be stored until administrators re-login.

### Monitor changed status of digital inputs

Typing “dinote” will make Video Server send the current status of all digital inputs. After that, Video Server will continuously monitor DI status and send messages only when the state has changed. For example, after typing “dinote” the terminal will display

DI1=L

DI2=L

DI3=L

DI4=L

and after DI2 changes to H, the terminal will display

DI2=H

---

## Stop information dumping

Typing “stop” will halt the dumping of debug information and the digital input status.

## Query status of digital inputs

Typing “diquery” will display the status of all digital inputs once.

## Set digital outputs

To set digital output to connect NO with COMMON, type “DO1=L”.

To set digital output to connect NC with COMMON, type “DO1=H”.

## Erase snapshots stored in Flash memory

Typing “erase image” will clear all snapshots saved in Flash memory.

## Skip installation at next boot

Typing “lock” will inform Video Server to lock the current network settings. You won’t need to go through the installation procedure the next time the Video Server boots up.

## Reset network for new settings

Typing “unlock” will cause Video Server to wait for the installation procedure the next time it boots up.

## Restore factory default settings

Typing “clear” will make Video Server restore factory settings but not restart. To validate new settings, type “reset” to make the system restart.

## Reset system

Typing “reset” will make Video Server perform a software reset.

## Advanced Applications

---

This chapter will introduce more advanced applications.

The following topics are covered in this chapter:

- ❑ **Capturing Up-to-date Still Images**
  - Getting snapshot via URL
  - Getting snapshot via FTP
- ❑ **Video Embedded in Customers' Homepage**
- ❑ **Download Event-triggered Snapshots**
  - Getting triggered snapshots via URL
  - Getting triggered snapshots via FTP
- ❑ **Customizing Graphics in Homepage**
- ❑ **Command Script for DI/DO & Camera's Actions Setting**
  - Command Format
  - Parameter Explanations
  - Practical Examples
- ❑ **URL Commands for DI/DO & Camera's Actions Setting**
  - Query status of digital inputs
  - Drive digital outputs
  - Moving motorized camera in PTZ direction
  - Recalling camera position
  - Transparent Remote Serial Driver
  - Sending command to device attached to COM port
- ❑ **URL Commands for System Maintenance**
  - Download System Log via FTP
  - Restart System via URL
  - Restore Factory Default Settings via URL

---

## Capturing Up-to-date Still Images

### Getting snapshot via URL

Administrators and users can use a specific URL to capture the current still image.

Video Channel	URL
Video 1	http://<IP of Video Server>/cgi-bin/video1.jpg[?<param>=<value>]
Video 2	http://<IP of Video Server>/cgi-bin/video2.jpg[?<param>=<value>]
Video 3	http://<IP of Video Server>/cgi-bin/video3.jpg[?<param>=<value>]
Video 4	http://<IP of Video Server>/cgi-bin/video4.jpg[?<param>=<value>]
Quad of all	http://<IP of Video Server>/cgi-bin/videoall.jpg[?<param>=<value>]

#### Additional Parameters:

param	Value	Description
Quality	1	Medium
	2	Standard
	3	Good
	4	Detailed
	5	Excellent
Size	1	Half
	2	Standard
	3	Double

### Getting snapshot via FTP

Administrators and users can log in to the Video Server FTP daemon to download the refreshed JPEG image. The user name and password are the same as for web access. The zero file size in file directory means it is captured by request.

Video Channel	File Name
Video 1	Video1.jpg
Video 2	Video2.jpg
Video 3	Video3.jpg
Video 4	Video4.jpg
Quad of all	Videoall.jpg

## Video Embedded in Customers' Homepage

In addition to the URL, some scripts should be added to download a plug-in for video images. The following example simply displays title text and a real-time video window in Internet Explorer or Netscape. The user name and password should be configured in advance. Those who are familiar with HTML can easily add more components or rewrite the code to create a more vivid and useful homepage.

```
<html>
<head><title>Video Server Sample Page</title></head>
<body>
<h2>Video Server Sample Page</h2>
<script language="JavaScript">
<!--
if ((navigator.appName == "Microsoft Internet Explorer")&&(navigator.platform != "MacPPC"))
{
    document.write("<OBJECT ID=\"MjpegControl\" WIDTH=352 HEIGHT=240");
```



```

document.write(" CLASSID=\"CLSID:EAA105FE-7BBD-4196-8B96-D46743894195 \" ");
document.write("CODEBASE=\"http://username:password@192.168.0.201/plugin
/mjpegcontrol.cab#version=2,0,0,6\">");
document.write("<PARAM NAME=\"VSize\" VALUE=\"2\">");
document.write("<PARAM NAME=\"Url\" VALUE=\"http://username:password@
192.168.0.201/cgi-bin/video.jpg\"");
document.write("?cam=1&quality=3&size=2\">");
document.write("</OBJECT>");
} else {
document.write("<img width=352 height=240\"");
document.write("src=\"http://192.168.0.201/cgi-bin/video.jpg?cam=1&quality=3&size=2\">");
}
//-->
</script>
</body>
</html>

```

## Download Event-triggered Snapshots

There are 12 video image files for the video channel of three stages: pre-alarm, the moment when triggered, and post-alarm. Only the snapshots captured by the last event are preserved. Administrator and users can use FTP or URL to get the saved snapshots. They can also be browsed from the application page under system configuration.

### Getting triggered snapshots via URL

/cgi-bin/snapshot.jpg?file=<value>

Video channel \ Snapshot stage	Video 1	Video 2	Video 3	Video 4
snapshot before event	pre1	pre2	pre3	pre4
snapshot upon event	trg1	trg2	trg3	trg4
snapshot after event	pos1	pos3	pos3	pos4

### Getting triggered snapshots via FTP

File name	Pre-alarm	Upon alarm	Post-alarm
Video 1	v1pre.jpg	v1trg.jpg	v1pos.jpg
Video 2	v2pre.jpg	v2trg.jpg	v2pos.jpg
Video 3	v3pre.jpg	v3trg.jpg	v3pos.jpg
Video 4	v4pre.jpg	v4trg.jpg	v4pos.jpg

## Customizing Graphics in Homepage

While in text mode, there is a small icon named BTN\_TEXT.GIF preceding each link that can be changed by administrators. While in image mode, the default method will use the image stored in Flash memory. The table below shows the referenced file name and size limitation of each stored image. Administrators may customize preferred image under the size limit and put it to the specific name via FTP. Administrators can download the original images before uploading for backup.

Object	File name	Maximal size
Logo	logo.gif	Logo and background share 8K bytes
Background	back.gif	Logo and background share 8K bytes
Link icon	btn_text.gif	2K bytes
Camera 1 button	btn_cam1.gif	5K bytes
Camera 2 button	btn_cam2.gif	5K bytes
Camera 3 button	btn_cam3.gif	5K bytes
Camera 4 button	btn_cam4.gif	5K bytes
Camera All button	btn_cama.gif	5K bytes
Configuration	btn_conf1.gif	5K bytes

### ATTENTION



Please do not try to upload the image, which the size is larger than the list, or it may cause the unstable system operation.

Usage via FTP is illustrated below.

```
MS-DOS Prompt
C:\>ftp 192.168.0.254
Connected to 192.168.0.254.
220 UsgualServer FTP server ready.
User (192.168.0.254:(none)) root
331 Password required.
Password:
230 User name accepted.
ftp> put myphoto.gif logo.gif
200 PORT command OK.
150 ready to take file.
226 closing.
ftp: 3916 bytes sent in 0.00Seconds 3916000.00Kbytes/sec.
ftp> bye
221 Goodbye.

C:\>
```

## Command Script for DI/DO & Camera's Actions Setting

Besides the application wizard, Video Server provides a more professional command script for advanced applications. The command script will be executed exclusively with the settings in Application page of system configuration except for the weekly schedule. To build an advanced application, follow the steps below.

- Step 1:** Use any text editor to edit the appropriate command script according to the command format. The script size cannot exceed 500 bytes.
- Step 2:** Save the script as a file named **SCRIPT.TXT**.
- Step 3:** Use FTP with administrator's privilege to upload the script file.
- Step 4:** Enter the Application page in system configuration to define the time period in **Weekly Schedule**. If it is supposed to run any time, keep the original settings but check the option **All the**

**time except for the above schedule.**

**Step 5:** Check the option **Enable the external script file to exclude the following settings** to activate the command script.

## Command format

```
[Event][“Operator”Event].....=[Action][+Action].....;
```

### Event

```
[“Digital Input Number”“Digital Input State”]
[“M” “Channel Number...”]
[“Channel Number”“Video Input State”]
```

### Operator

```
“+”: (OR)
“*”: (AND)
```

### Action

```
[(“Delay Time”)“Digital Output Number”“Digital Output State”]
[“V”“Channel Number”“P”“Preset Location Number”]
[“W”{“IP”：“Port”}{“Message”}]
[“U”“Method”]
[“S”“Channel Number...”]
[“N”{“filename”}];
```

## Parameter Explanations

Items above in brackets show the options available for that item.

“Digital input number”:	1 to 4
“Digital input state”:	H (high), L (low), / (low to high), \ (high to low)
“M”:	motion detection event.
“Channel Number”:	A, B, C, D for channel 1, 2, 3, 4
“Video input state”:	/ (signal from loss to presence), \ (signal from presence to loss), X (as long as signal loss)
“Delay time”:	seconds of delay for the following actions after events happen
“Digital output number”:	1 or 2
“Digital output state”:	C (NC), O (NO)
“V”:	set video channel to go to preset location
“P”:	set preset location number to go to preset location
“W”:	send warning to server
“IP”:	server IP
“Port”:	server port
“Message”:	text to be sent to the server
“U”:	upload snapshots
“Method”:	‘F’ is by FTP, ‘M’ is by e-mail
“S”:	take snapshot on channels
“N”:	define the format of the filename
“,”:	end of line

The filename format is,

%a	image characterization (pre, trg, pos)
%c	video channel number
%y	year
%M	month
%d	day
%h	hour
%m	minute

%s                                      second  
 %t                                      tenth second

## Practical Examples

Command line	Description
MAB=1C;	When any motion is detected on channel 1 or 2, “Normal Close” of relay output 1 will short with “Common”.
1H*2\=(5)1O;	When DI1 high companied with DI2 transient from high to low, “Normal Open” of relay output 1 will short with COMMON in 5 seconds.
B\C\D\=W{192.168.0.1:6000}{no signal!};	If there is no signal on channel 2 or 3 or 4, a message “no signal!” will be sent to port 6000 of 192.168.0.1 once.
1H=VAP14;	When sensor input 1 is high, drive the camera mapped to video 1 to go to preset location 15.
MCD=UF+SABCD+N{video%c%a@%y%M%d%h%m%s};	If any motion is detected on channel 3 or 4, upload snapshots taken on channel 1, 2, 3 and 4. If an event triggered at 19:05:30 2002/10/15, the snapshot files will be named as, video1pre@20021015190530.jpg, video2pre@20021015190530.jpg, video3pre@20021015190530.jpg, video4pre@20021015190530.jpg, video1trg@20021015190530.jpg, video2trg@20021015190530.jpg, video3trg@20021015190530.jpg, video4trg@20021015190530.jpg, video1pos@20021015190531.jpg, video2pos@20021015190531.jpg, video3pos@20021015190531.jpg, video4pos@20021015190531.jpg

**ATTENTION**



The script file is limited to a maximum of 500 characters. The actual performance will depend on the complexity of the command script.

## URL Commands for DI/DO & Camera's Actions Setting

### Query status of digital inputs

`/cgi-bin/getdi.cgi`

Video Server will return status of four digital inputs in one line.

### Drive digital outputs

`/cgi-bin/setdo.cgi?do1=<state>`

<number>     **1, 2** for DO1 and DO2

<state>:       **C, O** denoting Normal Close or Normal Open respectively.

### Moving motorized camera in PTZ direction

`/cgi-bin/control.cgi?<param>=<value>&<param>=<value>.....`

Param	Value	Description
cam	1	Video 1
	2	Video 2
	3	Video 3
	4	Video 4
move	up	Tilt up
	down	Tilt down
	left	Pan left
	right	Pan right
zoom	home	Return to home position
	wide	Zoom in
	tele	Zoom out
focus	near	Focus near
	far	Focus far
	auto	Automatic focus
panspeed	-5 to 5	
tiltspeed	-5 to 5	

### Recalling camera position

`/cgi-bin/recall.cgi?recall=<position>`

<n>:           video channel from 1 to 4

<position>:   the text string of a location that is preset in system configuration.

Refer to **Camera preset configuration URL** for preset function.

### Transparent Remote Serial Driver

Video Server provides a highly customized control support for third-party serial interface devices (other than PTZ cameras). This means that in addition to setting up a custom camera with PAN/ TILT/ ZOOM/ FOCUS commands, users may utilize this mode and introduce a customized homepage to transmit arbitrary user-defined commands from user-side to Video Server. The third-party device connected to the serial port of Video Server will receive the same command sent by the originator. The user only needs to attach the command in ASCII format after the special URL. Video Server will parse the commands and translate into binary code to send out.

#### Send command to device attached to COM1

`/cgi-bin/senddata.cgi?com=1&data=123456,ABCDEF&flush=yes&wait=1000&read=6`

This hyperlink will inform Video Server to send out binary format commands to COM1 with "0x12, 0x34, 0x56" followed by "0xAB, 0xCD, 0xEF". Each comma separates the commands by 200 milliseconds. "flush=yes" means the receive data buffer of COM port must be cleared before

---

read. Then read 6 bytes after waiting for 1000 milliseconds. The read data can be up to 128 bytes and will return as ASCII coded hexadecimal value, e.g., 0x41, 0x42, 0x43 read from COM port will show in returned homepage as 414243 instead of ABC.

**Send command to device attached to COM2**

[/cgi-bin/senddata.cgi?com=2&data=123456,,ABCDEF](#)

This hyperlink will inform Video Server to send out binary format command to COM2 with “0x12, 0x34, 0x56” followed by “0xAB, 0xCD, 0xEF” after 600 milliseconds of three comma.

## URL Commands for System Maintenance

### Download System Log via FTP

Besides viewing the system log from the web page, administrators can download the system log file, SYSTEM.LOG, via FTP. To log into the FTP daemon, enter “root” as the user name and the same administrator’s password used in Web access.

### Restart System via URL

[/cgi-bin/reset.cgi](#)

Restart Video Server without warning.

### Restore Factory Default Settings via URL

[/cgi-bin/restore.cgi](#)

Video Server will automatically restart after restoring factory default configurations.

# 6

## Upgrading System Firmware

---

Customers can check the appropriate product page on Moxa's website to download the latest firmware. Only administrators can upgrade the system firmware of Video Server.

The following topics are covered in this chapter:

- ❑ **Using Upgrade Wizard to Upgrade Firmware Easily**
- ❑ **Using FTP to Upgrade Firmware**

---

# Using Upgrade Wizard to Upgrade Firmware Easily

**Step 1:** Run the Upgrade Wizard (.exe) included in the product CD

**Step 2:** Key in the web address of the Video Server whose firmware you want to upgrade, and type the administrators' password. Then click **Next**.

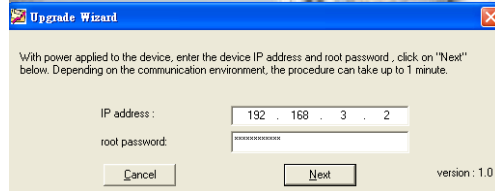

**Step 3:** The program will detect the Video Server.

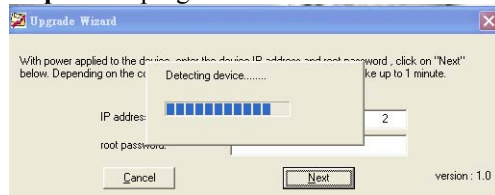

If the password is wrong, a message window will appear asking you to check the FTP port and password again.

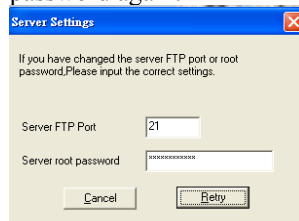

**Step 4:** After the Video Server has been detected, you can select the firmware (Flash.bin) to process the upgrade.

**Step 5:** Wait a few seconds for the upgrade process to finish.

**Step 6:** The following message appears once the firmware has been upgraded successfully.



---

## ATTENTION



Note that the power supply of VPort 2140 Video Server should not be turned off when the Upgrade Wizard is upgrading the firmware. Otherwise, the firmware upgrade will fail, and you will need to return the video server to Moxa for repair.

---



## Using FTP to Upgrade Firmware

**Step 1:** Use the FTP program and change the working directory to the local folder where FLASH.BIN resides.

**Step 2:** Connect to Video Server with user name as “root” and password.

**Step 3:** Use the **PUT** command to upload FLASH.BIN to Video Server. The file size is almost 1.8 MB. It will take approximately 3 seconds over a local network, 2 minutes by a null modem connection, or 6 minutes by modem, but the actual time will depend on the status of the user's network.

**Step 4:** After upload is complete, close the connection.

If the received FLASH.BIN is checked without error, Video Server will update the software in Flash memory and restart automatically. When Video Server starts writing firmware, both **CONNECT** and **SERIAL** LED indicators will stay on until the system restarts (this takes about 30 to 40 seconds). Users must keep the power stable during the update process. After the system restarts, Video Server may need installation depending on whether the **Reset network at next boot** option is enabled or not. After Video Server boots up, reload the web page in the browser.

---

**ATTENTION**

We strongly recommend that you use the upgrade wizard to upgrade the firmware for a Microsoft Operating System, since if the power fails during the software upgrade, the program in the memory of Video Server may be destroyed permanently. If Video Server cannot restart properly, ask the dealer for technical service.

---

---

**ATTENTION**

For customizing your VPort's settings, we strongly recommend that you download config.ini via FTP before you upgrade the firmware. The risk is that once the firmware has been upgraded, the settings in config.ini might be restored to the the initial settings. For this reason, after the firmware is upgraded, you need to upload the config.ini and overwrite the one existing in your VPort. In this way, you don't have to configure your VPort's settings again.

---



# 7

## Troubleshooting

---

This chapter describes some problems that might occur during installation or operation, and provides the basic solutions to those problems.

The following topics are covered in this chapter:

- ❑ **Power On Self Test (POST)**
- ❑ **Frequently Asked Questions**

---

## Power On Self Test (POST)

After the power has been turned on, Video Server will perform a self-diagnostic to detect any possible hardware defects. The **CONNECT** (LED 2) and **SERIAL** (LED 3) LEDs will blink during the POST, and will keep blinking until the POST completes successfully, or a fatal error is detected. If either status LED indicator is dim to start off with, the LED may be broken.

When certain fatal errors occur, LED2 and LED3 blink in a particular way to indicate the type of failure, as described in the following table.

LED pattern after POST	Failed function	Troubleshooting
LED2 and LED3 blink at same time	Video input	The video decoder is broken. Ask your reseller for technical service.
LED2 ON and LED3 OFF	Ethernet network	The PCI interface cannot work. Ask your reseller for technical service.
LED2 OFF and LED3 ON	Ethernet network	The Ethernet controller is broken. Ask your reseller for technical service.
LED2 ON and LED3 ON	Ethernet interface	Ethernet interface failure includes not only components on board but also Ethernet cable and the devices on the opposite end.
LED2 blink and LED3 ON	System date and time	The real-time clock is broken. Ask your reseller for technical service.
LED2 ON and LED3 blink	Camera control via COM or modem interface	The UART controller is broken. Ask your reseller for technical service.

---

### ATTENTION



To reduce system failure caused by operation error, always read the related sections in this user's manual to prevent unexpected errors caused by "wild-guess configuration."

---

## Frequently Asked Questions

Q: Why can't I see the Video Server in the installer after rebooting?

A: The installer is only used to install the IP address of the Video Server. If the IP address is fixed by checking the option in the installer, the Video Server will no longer appear in the installer.

Q: Why can't I connect the Video Server after rebooting?

A: If the IP address is not fixed, Video Server will always wait for the installing command to provide a valid IP address. This means that the previous IP address will not be used if the option in the installer is not checked; or the option in the network configuration is not cleared. The benefit of waiting for a valid IP address by default is that administrators can find the Video Server in the installer to prevent IP conflict. As long as the IP address is confirmed, we suggest fixing the IP address to make Video Server automatically start up whenever regaining power.

Q: What if I forget my password?

A: Every access to Video Server needs authentication. If you are not a permitted user, you may view the images or control the camera as long as the demo account is opened. The demo account user may use username as "demo" without any password to access limited features. If you are one of the managed users, you must ask the administrators for the password in the first time. If you are the administrator, there is no way to recover the root password. The only way to regain access to Video Server is to restore the factory settings and reinstall it.

Q: Why can't I watch video from Video Server after it is authenticated?

A: There are many possible scenarios regarding this problem,

1. If you have just installed Video Server and are unable to watch the video, check if the video input is enabled and check the video modulation on the Configuration page.
2. If Video Server is installed correctly and you are accessing Video Server for the first time using Internet Explorer, adjust the security level of Internet Explorer to allow installation of the plug-in.
3. If the problem still exists after making the adjustment, the current number of users may be greater than what the system allows.
4. If you are using a demo account, the administrator may hide the video from public view.

Q: How can I use a name instead of the IP address to connect Video Server?

A: To allow users to connect to Video Server through an easily memorized name, administrators must first configure the network's domain name server. Here is an example: the administrator installs the Video Server with a reserved IP address and assigns it a name on the domain name service, then users can connect to Video Server by typing a name instead of an IP address. If there is DHCP service on the network, the IP address must be excluded on the DHCP service to prevent an IP conflict.

Q: What is the plug-in for?

A: The plug-in provided by Video Server is used to display motion pictures on versions of Internet Explorer that do not support server push technology. If your system does not allow installation of any plug-in software, the security level of the web browser may need to be lowered. It is recommended that you consult the network supervisor in your office regarding adjusting the security level.

Q: Why is the timestamp different from the system time of my PC or notebook?

A: The timestamp is based on the system time of Video Server. It is maintained by an internal real-time clock, and automatically synchronizes with the time server if Video Server is connected to the Internet and the function is enabled. Differences of several hours may result from the time zone setting.

Q: Why does the image not refresh regularly?

A: In a modem environment, it is because the bandwidth of PPP connections is much lower than for Ethernet. If the difference of the timestamp is not stable, use the modem property on the control panel to adjust the UART FIFO to a lower level for both receiving and transmitting. In an Ethernet environment, it may be due to the time taken for storing snapshots into memory when events occur.

Q: How many users are allowed to watch Video Server at the same time?

A: To achieve the best effect, Video Server will allow a maximum of twenty users to connect at the same time. Excess users can get an auto-refreshed still image on homepage instead. It is recommended to build another web server to host a large quantity of users by retrieving images from Video Server periodically.

Q: How fast is the video rate of Video Server?

A: The JPEG codec can process 30 frames per second internally. However, the overall performance is subject to many different factors, such as:

1. network throughput,
2. bandwidth share,
3. number of users,
4. number of video inputs accessed at one time,
5. viewing complicated objects results in a larger image file,
6. the level of your PC or notebook that is responsible for displaying images.

In general, the transfer rate on a general local network environment can achieve over 200 Kbytes per second and approximately 10 to 20 pictures of normal environment per second. The general frame size is illustrated in the following table for your reference.

Quality setting	Size of each frame	Bandwidth demand for 30 fps
Medium	9.3 Kbyte	2246 Kbps
Standard	11.15 Kbyte	2676 Kbps
Good	13.76 Kbyte	3303 Kbps
Detailed	16.35 Kbyte	3925 Kbps
Excellent	20.3 Kbyte	4886 Kbps

Q: How can I keep Video Server as private as possible?

A: Video Server is designed for surveillance purposes and has many flexible interfaces. The user authentication and special confirmation during installation can keep Video Server from unauthorized access. You may also change the HTTP port to a non-public number. You can check system log to examine any abnormal activities and trace the origins.

Q: I have a PTZ camera that is not on the support list. How can I control it?

A: Video Server provides a custom camera command interface to control cameras that are not supported. The details are described in this manual. Be sure that the COM port settings are applied to the camera specifications. The camera control cable included is shown in the package contents. Prepare your own cable if necessary. The general PTZ command is composed of one start command and one stop command. When editing both commands in the edit box of the configuration page, use comma(s) to separate commands. Each comma represents 200 milliseconds. If the user has some serial control device other than the PTZ camera, the special URL is provided to send the desired commands. For quick access, integrate the URL to another homepage on your own web server.

Q: Why can I see image files when I use dir in FTP even if the alarm is not triggered?

A: Every time Video Server starts, it will capture the images as vpre.jpg. If there are previously saved image files that are not retrieved, Video Server will keep them until they are accessed.

Q: How will the stored images be processed if Video Server loses power?

A: If a user has defined the snapshot interval, Video Server will capture images periodically as pre-alarm stage. Once the pre-defined condition is match, the pre-alarm images will be kept and the current images will be saved. The subsequent images will be stored as post-alarm stage. Users may retrieve these files either by downloading via FTP, or direct Video Server to send them in e-mails. This means that after monitoring conditions are met, Video Server will keep these image files until user retrieval even if power is lost.

Q: If I set Video Server to send e-mails of images whenever the conditions are met, will my e-mail account overflow?

A: It is recommended to use transient state instead of steady state. For instance, use 'Input is Rising' and 'Input is Falling' rather than 'Input is High' and 'Input is Low' to let the condition be triggered only when state is changed.

Q: The image is not clear enough. Is anything broken?

A: The lens can be focused by rotating the outer ring. Rotate it clockwise or counter-clockwise to focus near or far.

# A

## URL Commands of Video Server

---

Video Server can be easily integrated with existing websites or web control applications using convenient URLs. This section lists the commands in URL format corresponding to the basic functions of Video Server. Some RFC standards related to HTML may be a good reference for implementation of the customized homepage.

### Page URL

The configuration page has a frame layout that includes an option list frame and an option page frame. Except for the configuration page, the Reference URLs shown below link just to the option page frame. Some pages, such as image quality settings and preset settings, open in a new browser window. These URLs can be accessed only by administrators.

Homepage name	Reference URL
configuration page	/setup/config.html
system option	/setup/system.html
security option	/setup/security.html
network option	/setup/network.html
video option	/setup/video.html
image quality option	/setup/image.html
camera control	/setup/serial.html
preset PTZ camera	/setup/preset.html
custom command setting	/setup/cuscom.html
custom camera setting	/setup/custom.html
application option	/setup/app.html
motion detection setting	/setup/motion.html
view snapshots	/setup/snap.html
demo option	/setup/demo.html
homepage layout option	/setup/layout.html
system log	/setup/logfile.html
system parameters	/setup/parafile.html
set factory default	/setup/factory.html

## System Resource URL

Some images are used on the homepage when the homepage layout is in image mode. Administrators may use the following links to show the images saved on Video Server on another page. To change the logo or the background images referenced by the URL, refer to the homepage layout section under configuration.

Resource name	Reference URL
system logo image	/logo.gif
background image	/back.gif
button image for camera 1	/btn_cam1.gif
button image for camera 2	/btn_cam2.gif
button image for camera 3	/btn_cam3.gif
button image for camera 4	/btn_cam4.gif
button image for quad screen	/btn_cama.gif
button image for configuration	/btn_conf.gif
icon image for link indicator	/btn_text.gif

## General Format of Command URL

<general format>  
 URL[?[name=value][&name=value]......]  
 <method>  
 POST  
 <authorized user>  
 root

## System Configuration URL

URL: /cgi-bin/system.cgi

Name	Value	Description
host	<text string shorter than 15 characters>	system name
method	keep	keep date and time unchanged
	auto	use NTP server to synchronize
	manu	directly adjust date and time
date	<yy/mm/dd>	year, month and date separated by slash
time	<hh:mm:ss>	hour, minute and second separated by colon
ntp	<domain name or IP address>	NTP server
zone	GMT±<n>:00	time zone, n ranged from 0 to 12

## Security Configuration URL

URL: /cgi-bin/system.cgi

Name	Value	Description
rootpass	<text string shorter than 14 characters>	change root password
username	<text string shorter than 14 characters>	add new user
userpass	<text string shorter than 14 characters>	new user's password
v1allowed	<not required>	allow user to view video 1



v2allowed	<not required>	allow user to view video 2
v3allowed	<not required>	allow user to view video 3
v4allowed	<not required>	allow user to view video 4
ioallowed	<not required>	allow user to control DO
ptzallowed	<not required>	allow user to view PTZ panel
deluser	<text string shorter than 14 characters>	Existing user name
slow	<not required>	snapshot mode
delay	<integer>	refresh time in snapshot mode

## Network Configuration URL

URL: /cgi-bin/network.cgi

Name	Value	Description
reset	yes	enable installation at next boot
	<other than yes>	disable installation at next boot
ip	<IP address>	Video Server's IP address
subnet	<IP address>	subnet mask
router	<IP address>	default gateway
domain	<text string shorter than 38 characters>	domain name of Video Server
dns1	<IP address>	primary DNS server
dns2	<IP address>	secondary DNS server
limit	Not limited	use full network bandwidth
	64Kbits/second	use only 64Kbps of bandwidth
	128Kbits/second	use only 128Kbps of bandwidth
	256Kbits/second	use only 256Kbps of bandwidth
	512Kbits/second	use only 512Kbps of bandwidth
	768Kbits/second	use only 768Kbps of bandwidth
	1Mbits/second	use only 1Mbps of bandwidth
	1.5Mbits/second	use only 1.5Mbps of bandwidth
2Mbits/second	use only 2Mbps of bandwidth	
http	<number less than 65535>	HTTP port
smtp1	<domain name or IP address>	primary SMTP server
mailto1	<text string shorter than 80 characters>	mail recipient address
smtp2	<domain name or IP address>	secondary SMTP server
mailto2	<text string shorter than 80 characters>	mail recipient address
return	<text string shorter than 80 characters>	return address
ftp1	<domain name or IP address>	primary FTP server
ftprp1	<number less than 65535>	FTP server port
ftpuer1	<text string shorter than 14 characters>	user name for primary FTP server
ftppass1	<text string shorter than 15 characters>	password for primary FTP server

ftpfolder1	<text string shorter than 40 characters>	upload folder in primary FTP server
ftp2	<domain name or IP address>	secondary FTP server
ftprp2	<number less than 65535>	secondary FTP server port
ftpuser2	<text string shorter than 15 characters>	user name for secondary FTP server
ftppass2	<text string shorter than 15 characters>	password for secondary FTP server
ftpfolder2	<text string shorter than 40 characters>	upload folder in secondary FTP server

## Video Configuration URL

URL: /cgi-bin/video.cgi

Name	Value	Description
enable1	<not required>	enable video channel 1
enable2	<not required>	enable video channel 2
enable3	<not required>	enable video channel 3
enable4	<not required>	enable video channel 4
mode	Auto	let Video Server detect video modulation
	NTSC	set directly to NTSC type
	<other than above>	set directly to PAL type
source	<1, 2, 3, 4 or All>	default video channel

## Image Quality Configuration URL

URL: /cgi-bin/image.cgi

Name	Value	Description
cam	<1 ~ 4>	Video channel number
time	<not required>	enclose timestamp
text	<text string shorter than 15 characters>	enclose caption
color	B/W	set encoder to monochrome
	<other than B/W>	set encoder to color
quality	Medium	lowest resolution
	Standard	lower resolution
	Good	normal setting
	Detailed	higher resolution
	Excellent	highest resolution
size	Half	set size to half
	Standard	set size to standard
	Double	set size to double
	Half x 2	set size to half x 2
	Standard x 2	set size to standard x 2
brightness	<-5 ~ 5>	adjust brightness of image
contrast	<-5 ~ 5>	adjust contrast of image
hue	<-5 ~ 5>	adjust hue of image

saturation	<-5 ~ 5>	adjust saturation of image
preview	<not required>	not save the parameters
restore	<not required>	recall the original settings
save	<not required>	save the parameters

## COM 1 Configuration URL

URL: /cgi-bin/serial1.cgi

Name	Value	Description
interface	RS232	switch COM to RS232
	RS485	switch COM to RS485
detect	generic	accept generic CGI commands
	none	no drivers
driver	Sony VISCA	
	Canon VCC1	
	Canon VCC3	
	Canon VCC4	
	DynaDome/SmartDOME	
	Pelco D protocol	
	Lilin PIH-7x00	
	Ernitec	
	Custom Camera	third party PTZ camera

## COM 2 configuration URL

URL: /cgi-bin/serial2.cgi

Name	Value	Description
detect	generic	accept generic CGI commands
	modem	use modem
	none	no drivers
driver	Sony VISCA	
	Canon VCC1	
	Canon VCC3	
	Canon VCC4	
	DynaDome/SmartDOME	
	Pelco D protocol	
	Lilin PIH-7x00	
	Ernitec	
	Custom Camera	third party PTZ camera
method	Tone (ATDT)	make modem dial in tone
	Pulse (ATDP)	make modem dial in pulse

reatt	<integer>	redial attempts
discon	<integer>	minutes delay before disconnection
init	<text string shorter than 40 characters>	command to initialize modem
phone1	<text string shorter than 40 characters>	phone number of primary ISP
user1	<text string shorter than 40 characters>	user name for primary ISP
pass1	<text string shorter than 40 characters>	password for primary ISP
phone2	<text string shorter than 40 characters>	phone number of secondary ISP
user2	<text string shorter than 40 characters>	user name for secondary ISP
pass2	<text string shorter than 40 characters>	password for secondary ISP

## Camera custom command configuration URL

URL: /cgi-bin/cuscom.cgi

Name	Value	Description
str11	<text string shorter than 8 characters>	button name of custom command 1 of COM1
str12	<text string shorter than 8 characters>	button name of custom command 2 of COM1
str13	<text string shorter than 8 characters>	button name of custom command 3 of COM1
str14	<text string shorter than 8 characters>	button name of custom command 4 of COM1
str15	<text string shorter than 8 characters>	button name of custom command 5 of COM1
com11	<text string shorter than 80 characters>	custom command 1 of COM1
com12	<text string shorter than 80 characters>	custom command 2 of COM1
com13	<text string shorter than 80 characters>	custom command 3 of COM1
com14	<text string shorter than 80 characters>	custom command 4 of COM1
com15	<text string shorter than 80 characters>	custom command 5 of COM1
str21	<text string shorter than 8 characters>	button name of custom command 1 of COM2
str22	<text string shorter than 8 characters>	button name of custom command 2 of COM2
str23	<text string shorter than 8 characters>	button name of custom command 3 of COM2
str24	<text string shorter than 8 characters>	button name of custom command 4 of COM2
str25	<text string shorter than 8 characters>	button name of custom command 5 of COM2
com21	<text string shorter than 80 characters>	custom command 1 of COM2
com22	<text string shorter than 80 characters>	custom command 2 of COM2
com23	<text string shorter than 80 characters>	custom command 3 of COM2
com24	<text string shorter than 80 characters>	custom command 4 of COM2
com25	<text string shorter than 80 characters>	custom command 5 of COM2

## Camera preset configuration URL

URL: /cgi-bin/preset.cgi

Name	Value	Description
com	1, 2	Com port number
cam	<1 ~ 4>	Video channel number
camtype	fixed	fixed camera
	cammap	PTZ camera
id	<integer>	camera id
addpos	<text string shorter than 40 characters>	add preset position
delpos	<existing position name>	delete preset position

## Custom camera configuration URL

URL: /cgi-bin/custom.cgi

Name	Value	Description
baud1	<integer>	set baud rate of COM1
data1	<integer>	set data bits of COM1
stop1	1	set 1 stop bit of COM1
	2 <other than 1>	set 2 stop bits of COM1
parity1	None	set parity check of COM1 to none
	Odd	set parity check of COM1 to odd
	Even	set parity check of COM1 to even
up1	<text string shorter than 80 characters>	tilt up command string of COM1
down1	<text string shorter than 80 characters>	tilt down command string of COM1
left1	<text string shorter than 80 characters>	pan left command string of COM1
right1	<text string shorter than 80 characters>	pan right command string of COM1
home1	<text string shorter than 80 characters>	home command string of COM1
tele1	<text string shorter than 80 characters>	zoom in command string of COM1
wide1	<text string shorter than 80 characters>	zoom out command string of COM1
baud2	<integer>	set baud rate of COM2
data2	<integer>	set data bits of COM2
stop2	1	set 1 stop bit of COM2
	2 <other than 1>	set 2 stop bits of COM2
parity2	None	set parity check of COM2 to none
	Odd	set parity check of COM2 to odd
	Even	set parity check of COM2 to even
up2	<text string shorter than 80 characters>	tilt up command string of COM2
down2	<text string shorter than 80 characters>	tilt down command string of COM2
left2	<text string shorter than 80 characters>	pan left command string of COM2
right2	<text string shorter than 80 characters>	pan right command string of COM2
home2	<text string shorter than 80 characters>	home command string of COM2
tele2	<text string shorter than 80 characters>	zoom in command string of COM2
wide2	<text string shorter than 80 characters>	zoom out command string of COM2

## Application configuration URL

URL: /cgi-bin/app.cgi

Name	Value	Description
sun	<not required>	set Sunday in weekly schedule
mon	<not required>	set Monday in weekly schedule
tue	<not required>	set Tuesday in weekly schedule
wed	<not required>	set Wednesday in weekly schedule
thu	<not required>	set Thursday in weekly schedule
fri	<not required>	set Friday in weekly schedule
sat	<not required>	set Saturday in weekly schedule
sbegin	<hh:mm:ss>	time to start in weekly schedule
send	<hh:mm:ss>	time to stop in weekly schedule
inv	<not required>	set inverse mode in weekly schedule
enfile	<not required>	enable script file
emode	<not required>	event operation
showalert	<not required>	show alert in image

mdch1	<not required>	enable motion detection on video 1
mdch2	<not required>	enable motion detection on video 2
mdch3	<not required>	enable motion detection on video 3
mdch4	<not required>	enable motion detection on video 4
di1	High, Low, Rising, Falling or Disable	DI1 condition
di2	High, Low, Rising, Falling or Disable	DI2 condition
di3	High, Low, Rising, Falling or Disable	DI3 condition
di4	High, Low, Rising, Falling or Disable	DI4 condition
delay	<integer>	delay time of DO after event
do1	High, Low or Disable	DO1 action
do2	High, Low or Disable	DO2 action
eventch1	<not required>	take snapshots on ch1 while event happen
eventch2	<not required>	take snapshots on ch2 while event happen
eventch3	<not required>	take snapshots on ch3 while event happen
eventch4	<not required>	take snapshots on ch4 while event happen
dura	<integer>	snapshots taken after event
inter	<integer>	tenth seconds interval after the event
mdmode	<not required>	enable motion detection(emode should set)
smode	<not required>	sequential mode application
sinter	<integer>	tenth seconds interval for sequential mode
smethod	mail	upload snapshots by email
	ftp	upload snapshots by FTP
suffix	<not required>	FTP file with date and time suffix

## Motion detection configuration URL

URL: [/cgi-bin/motion.cgi](#)

Name	Value	Description
cam	<1 ~ 4>	Video channel number
per	<integer>	object size percentage
sen	<integer>	sensitivity percentage

## Demo configuration URL

URL: [/cgi-bin/demo.cgi](#)

Name	Value	Description
open	<not required>	enable demo account
camctr1	<not required>	allow demo user to control PTZ camera on video 1
camctr2	<not required>	allow demo user to control PTZ camera on video 2
camctr3	<not required>	allow demo user to control PTZ camera on video 3
camctr4	<not required>	allow demo user to control PTZ camera on video 4
view1	<not required>	allow demo user to watch channel 1
view2	<not required>	allow demo user to watch channel 2
view3	<not required>	allow demo user to watch channel 3
view4	<not required>	allow demo user to watch channel 4

## Homepage layout configuration URL

URL: [/cgi-bin/layout.cgi](#)

Name	Value	Description
cuslogo	blank	hide logo

	def	use default logo
	url	use image from URL
logourl	<text string shorter than 60 characters>	URL of image for logo
linkurl	<text string shorter than 60 characters>	URL to link when clicking on logo
cusback	blank	hide background image
	def	use default background
	url	use image from URL
backurl	<text string shorter than 60 characters>	URL of image for background
fcolor	<0 ~ 15>	color index for font
bcolor	<0 ~ 15>	color index for background
dismode	image	display homepage in image mode
	text	display homepage in text mode
str1	<text string shorter than 38 characters>	text for channel 1 in text mode
str2	<text string shorter than 38 characters>	text for channel 2 in text mode
str3	<text string shorter than 38 characters>	text for channel 3 in text mode
str4	<text string shorter than 38 characters>	text for channel 4 in text mode





# B

## **Settings of Supported PTZ Cameras**

---

Since the COM port settings can be adjusted to other than the default settings, check the correct default settings for the attached camera.

<b>Camera model</b>	<b>Baud rate</b>	<b>Data bits</b>	<b>Stop bit</b>	<b>Parity bit</b>
Sony VISCA	9600	8	1	None
Canon VC-C1	9600	8	2	None
Canon VC-C3	9600	8	2	None
Canon VC-C4	9600	8	1	None
Pelco D protocol	2400	8	1	None
DynaDome/SmartDome	9600	8	1	None
Ernitec	9600	8	1	None
Lilin	9600	8	1	None



## Camera Control Cable

The included cable can be used to control motorized cameras of desktop types from Sony and Canon. The pin assignment is illustrated in the following chart. To control cameras of another brand, check the user's manual of the motorized camera to see if the pin assignment of the control cable is appropriate.

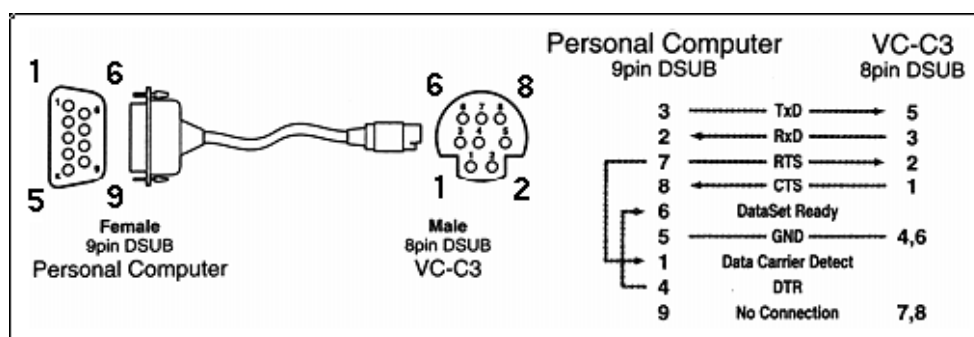



# D

## Time Zone Table

---

The hour offsets for different time zones are shown below. You will need this information when setting the time zone in automatic date/time synchronization. GMT stands for Greenwich Mean Time, which is the global time that all time zones are measured from.

(GMT-12:00)	International Date Line West
(GMT-11:00)	Midway Island, Samoa
(GMT-10:00)	Hawaii
(GMT-09:00)	Alaska
(GMT-08:00)	Pacific Time (US & Canada), Tijuana
(GMT-07:00)	Arizona
(GMT-07:00)	Chihuahua, La Paz, Mazatlan
(GMT-07:00)	Mountain Time (US & Canada)
(GMT-06:00)	Central America
(GMT-06:00)	Central Time (US & Canada)
(GMT-06:00)	Guadalajara, Mexico City, Monterrey
(GMT-06:00)	Saskatchewan
(GMT-05:00)	Bogota, Lima, Quito
(GMT-05:00)	Eastern Time (US & Canada)
(GMT-05:00)	Indiana (East)
(GMT-04:00)	Atlantic Time (Canada)
(GMT-04:00)	Caracas, La Paz
(GMT-04:00)	Santiago
(GMT-03:30)	Newfoundland
(GMT-03:00)	Brasilia
(GMT-03:00)	Buenos Aires, Georgetown
(GMT-03:00)	Greenland
(GMT-02:00)	Mid-Atlantic
(GMT-01:00)	Azores
(GMT-01:00)	Cape Verde Is.
(GMT)	Casablanca, Monrovia
(GMT)	Greenwich Mean Time: Dublin, Edinburgh, Lisbon, London
(GMT+01:00)	Amsterdam, Berlin, Bern, Stockholm, Vienna
(GMT+01:00)	Belgrade, Bratislava, Budapest, Ljubljana, Prague
(GMT+01:00)	Brussels, Copenhagen, Madrid, Paris
(GMT+01:00)	Sarajevo, Skopje, Warsaw, Zagreb
(GMT+01:00)	West Central Africa
(GMT+02:00)	Athens, Istanbul, Minsk
(GMT+02:00)	Bucharest
(GMT+02:00)	Cairo
(GMT+02:00)	Harare, Pretoria
(GMT+02:00)	Helsinki, Kyiv, Riga, Sofia, Tallinn, Vilnius
(GMT+02:00)	Jerusalem
(GMT+03:00)	Baghdad
(GMT+03:00)	Kuwait, Riyadh
(GMT+03:00)	Moscow, St. Petersburg, Volgograd
(GMT+03:00)	Nairobi

---

(GMT+03:30) Tehran  
(GMT+04:00) Abu Dhabi, Muscat  
(GMT+04:00) Baku, Tbilisi, Yerevan  
(GMT+04:30) Kabul  
(GMT+05:00) Ekaterinburg  
(GMT+05:00) Islamabad, Karachi, Tashkent  
(GMT+05:30) Chennai, Kolkata, Mumbai, New Delhi  
(GMT+05:45) Kathmandu  
(GMT+06:00) Almaty, Novosibirsk  
(GMT+06:00) Astana, Dhaka  
(GMT+06:00) Sri Jayawardenepura  
(GMT+06:30) Rangoon  
(GMT+07:00) Bangkok, Hanoi, Jakarta  
(GMT+07:00) Krasnoyarsk  
(GMT+08:00) Beijing, Chongqing, Hongkong, Urumqi  
(GMT+08:00) Taipei  
(GMT+08:00) Irkutsk, Ulaan Bataar  
(GMT+08:00) Kuala Lumpur, Singapore  
(GMT+08:00) Perth  
(GMT+09:00) Osaka, Sapporo, Tokyo  
(GMT+09:00) Seoul  
(GMT+09:00) Yakutsk  
(GMT+09:30) Adelaide  
(GMT+09:30) Darwin  
(GMT+10:00) Brisbane  
(GMT+10:00) Canberra, Melbourne, Sydney  
(GMT+10:00) Guam, Port Moresby  
(GMT+10:00) Hobart  
(GMT+10:00) Vladivostok  
(GMT+11:00) Magadan, Solomon Is., New Caledonia  
(GMT+12:00) Auckland, Wellington  
(GMT+12:00) Fiji, Kamchatka, Marshall Is..  
(GMT+13:00) Nuku'alofa



# Technical Specifications

<p><b>System</b> CPU: Trimedia PNX1300 RAM: 16MB SDRAM ROM: 2MB FLASH ROM</p> <p><b>Networking</b> Adjustable bandwidth limit</p> <p><b>Protocols</b> TCP/IP, HTTP, SMTP, FTP, Telnet, NTP, DNS and DHCP</p> <p><b>Modem</b> PPP (dial-up, direct cable connection)</p> <p><b>Ethernet</b> 10BaseT Ethernet or 100BaseT Fast Ethernet</p> <p><b>Video</b> <b>Algorithms Supported</b> JPEG, MJPEG</p> <p><b>Video Inputs and Outputs</b> 4 BNC video inputs with 75 ohm terminal switch, NTSC/PAL auto-sensing 4 BNC loop-through video outputs</p> <p><b>Features</b> Adjustable image size and quality B/W or color control Timestamp and text overlay</p> <p><b>Resolution</b> NTSC Up to 30 frames at 176x112 Up to 30 frames at 352x240 Up to 9 frames at 704x480 or quad PAL Up to 25 frames at 176x144 Up to 25 frames at 352x288 Up to 8 frames at 704x576 or quad</p> <p><b>Serial Port</b> <u>COM1</u> DB9 RS-232 or RS-485 Terminal block (PTZ camera control) max.115.2Kbps <u>COM2</u> DB9 RS-232 (PTZ camera control or modem), max.115.2Kbps</p>	<p><b>LED Indicators</b> <u>NETWORK:</u> ACTIVE, LINK, FDX (full duplex) <u>SYSTEM:</u> POWER, CONNECT, SERIAL</p> <p><b>Dimensions</b> 193.71 x 195 x 44.3 mm (W x D x H)</p> <p><b>Weight</b> Net. 890g</p> <p><b>Power</b> Consumption: near 7.8W Input: 100-240VAC, 50/60Hz, 0.4A Output: 12VDC, 1.5A (12 VDC, 1.25A for UK plug) External Power Supply</p> <p><b>Operating Environment</b> Operating Temperature: 0 to 65°C/ 32 to 149°F Storage Temperature: -40 to 70°C/ -14 to 158°F Humidity: 95%RH</p> <p><b>Alarm Features</b> Motion detection with percentage and sensitivity Daily repeat timing schedule 3 color images per camera for pre/post alarm Automatic transfer of stored images via email or FTP with event-triggered actions</p> <p><b>PAN/TILT/ZOOM</b> Multiple PTZ camera control through RS-232 or RS-485 Supported devices and protocols: Sony VISCA protocol, Canon VC-C1, VC-C3, VC-C4, Dynacolor SmartDOME, Pelco D-protocol, Lilin Speeddome, Ernitec Speeddome CGI command serial driver is supported</p> <p><b>Software Development Kit</b> Open ActiveX control</p> <p><b>Viewing System Requirement</b> Internet Explorer 4.x or above, Netscape Navigator 4.x or above</p>
---	--

---

<b>General I/O</b>	
4 Digital inputs (max. 12VDC 50 mA)	
2 Relay outputs (max. 24 VDC 1A, 125 VAC 0.5A)	



# F

## Service Information

---

This appendix shows you how to contact Moxa for information about this and other products, and how to report problems.

In this appendix, we cover the following topics.

- ❑ **MOXA Internet Services**
- ❑ **Problem Report Form**
- ❑ **Product Return Procedure**

---

## MOXA Internet Services

Customer satisfaction is our number one concern, and to ensure that customers receive the full benefit of our products, Moxa Internet Services has been set up to provide technical support, driver updates, product information, and user's manual updates.

The following services are provided

E-mail for technical support..... [support@moxanet.com](mailto:support@moxanet.com)

World Wide Web (WWW) Site for product information:

..... <http://www.moxa.com>



---

## Product Return Procedure

For product repair, exchange, or refund, the customer must:

- ◆ Provide evidence of original purchase.
- ◆ Obtain a Product Return Agreement (PRA) from the sales representative or dealer.
- ◆ Fill out the Problem Report Form (PRF). Include as much detail as possible for a shorter product repair time.
- ◆ Carefully pack the product in an anti-static package, and send it, pre-paid, to the dealer. The PRA should be visible on the outside of the package, and include a description of the problem, along with the return address and telephone number of a technical contact.

## Free Manuals Download Website

<http://myh66.com>

<http://usermanuals.us>

<http://www.somanuals.com>

<http://www.4manuals.cc>

<http://www.manual-lib.com>

<http://www.404manual.com>

<http://www.luxmanual.com>

<http://aubethermostatmanual.com>

Golf course search by state

<http://golfingnear.com>

Email search by domain

<http://emailbydomain.com>

Auto manuals search

<http://auto.somanuals.com>

TV manuals search

<http://tv.somanuals.com>