

Industrial Networking Solutions



- Industrial Ethernet
- Serial Connectivity and Networking
- Industrial Wireless
- Embedded Computing



MOXA[®]

www.moxa.com

Our Vision

To be a world-class leader in industrial-grade device networking solutions for automation

Our Values

Integrity
Mutual Respect
Customer Focus
Execution

Our Mission

To customers

Provide value-added service and quality products.

To business partners

Establish win-win business relationships based on trust and integrity.

To employees

Provide educational and career advancement opportunities, and share the company's success.

To society

Conduct regular educational programs and work to protect the environment.



Moxa at a Glance

The brand to ask for in industrial device networking

For over twenty years, industrial systems integrators have relied on Moxa products in major device networking installations all over the world. Moxa offers industrial-grade solutions backed by an excellent warranty and highly-specialized technical support for a diverse range of applications, including connecting PLCs to a wireless control network, transmitting temperature signals over long distances, and automating device control and monitoring at remote locations.

Trusted worldwide

Moxa was established in 1987 and has offices in Europe, the United States, China, and Taiwan. Working with a network of certified distributors, Moxa offers world-class industrial networking products to systems integrators and value-added resellers in over 60 countries. Clients place great trust in Moxa's business and environmental practices, which are backed by ISO 9001:2000 and ISO 140001 certification. All products obtain standard, internationally recognized certifications, as well as specialized certifications depending on client requirements.

Wide selection of products for connecting and controlling industrial devices

Moxa offers a comprehensive selection of products that are designed for device communication in industrial settings:

- Industrial Ethernet switches
- Device servers
 - (including the award-winning NPort® series)
- Serial, Ethernet, and fiber optic media converters
- Industrial I/O
- Industrial IEEE 802.11 Wireless AP/Bridge/Client
- Industrial Cellular Solutions
- Embedded computing platforms
- Modbus gateways
- Industrial video networking solutions
- Multiport serial boards

Designed to exact specifications

In addition to standard product offerings, Moxa's expert R&D team can also deliver customized solutions for projects that have highly specialized requirements, including the development of specific technical functions or simple changes in connector type.



Quality Assurance

An all-encompassing commitment to quality

At the core of Moxa's competitiveness is an all-encompassing commitment to quality. One aspect of this commitment is Moxa's acceptance into the ISO 9001:2000 family of certified organizations, with annual certification by some of the most demanding auditors. In addition, Moxa has also achieved ISO 14001:2004 certification for adopting an environmental management system.

ISO 9001:2000

Research & Development, Manufacturing & Service, Quality product design

ISO 14001:2004

Environmental Management System

5-year product warranty

Most Moxa products carry a solid 5-year warranty.



Moxa's Green Products

The European Union's Waste Electrical and Electronic Equipment (WEEE) directive took effect in August of 2005, and the Restriction on Hazardous Substances (RoHS) directive was enforced starting in July of 2006. The Chinese government has also released its own RoHS directive that requires manufacturers to declare and control the use of hazardous substances.

Moxa is dedicated to producing "green products" that satisfy the WEEE and RoHS directives. We are also proud to be among the first in the industry to eliminate the use of perfluorooctanesulfonic acid in most of our products. In addition, all Moxa products carry UL, FCC, and CE certifications.





International Recognition

Moxa products receive top honors from industry groups

Moxa takes great pride in developing well-designed products that meet the needs of industrial users. Many of Moxa's products have been recognized by prominent industry groups for outstanding performance, design, and innovation.

- **2008/2009 Trend 100 Products, SPS Magazine**
PT-7828 IEC 61850-3 Layer 3 Gigabit modular rackmount Ethernet switch
- **2008 Good Design Award**
EDS-728 Industrial Gigabit modular Ethernet switch
- **2008 Red Dot Product Design Award**
EDS-728 industrial Gigabit modular Ethernet switch
- **2007 Engineer's Choice Award, Control Engineering Magazine**
W345 RISC-based wireless computer
- **2007 Product of the Year Finalist, Plant Engineering Magazine**
EDS-P308 industrial PoE switch
- **2006 New Product Award, IEN Magazine**
NPort W2004 wireless device server
- **2006 iF Product Design Award**
EDS-726 industrial Gigabit modular Ethernet switch
- **2006 Engineer's Choice Award, Control Engineering Magazine**
ioLogik E2210 Active Ethernet I/O server
- **2006 Taiwan Symbol of Excellence**
AWK-1100 wireless access point
- **2004 Editor's Choice Award, Control Engineering Magazine**
EDS-508 industrial Ethernet switch

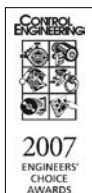

reddot design award
honourable mention 2008





Industrial Device Networking

Specializing in industrial communication interfaces and protocols

When working with industrial networks, one of the biggest challenges is finding a way to enable communication between devices that use different interfaces and protocols. Moxa products are designed to establish network connections for devices that use the following interfaces and protocols:

- RS-232, RS-422, RS-485
- PCI, PCIe
- 10/100/1000 Mbps Ethernet
- TCP, UDP
- DF1
- SNMP
- Single-mode and multi-mode optical fiber
- Modbus ASCII/RTU/TCP
- USB 2.0
- Analog and digital I/O
- IEEE 802.11a/b/g and IEEE 802.11n
- GSM, GPRS, EDGE, HSDPA, UMTS (cellular)
- CCTV video

Industrial-grade design

Moxa's industrial-grade products are tough enough to provide continuous, reliable, long-term operation in even the harshest industrial settings. Systems integrators will appreciate the fact that Moxa designs products with the following industry-friendly features:

- DIN-Rail, wall, and 19-inch rack mounting
- Low power consumption
- Redundant power inputs
- Optical isolation and ESD protection
- IP30/54/66/67/68 protection ratings
- Wide operating temperatures
- M12 connectors
- Easy to use software libraries
- Generous 5-year warranty on most products
- Industry certifications such as UL, CE, Class 1 Div 2, ATEX, DNV, GL
- Protection against shock and vibration
- Terminal block connectors

R&D

The world's best engineers and IT specialists

Moxa's products have the advantage of being engineered in Taiwan, one of the world's hottest spots for high-end electronics and information technology. Companies around the world rely on the high quality of components developed and made in Taiwan to maintain their own standards of quality and reliability. Industry specialists know that there is no better source for electronic components such as LCDs, touch screens, semiconductor wafers, ICs, PC motherboards, and more.

With direct access to Taiwan's talented labor pool, Moxa has assembled an expert R&D team that has developed innovative technologies and set new standards for the industry:

- Advanced Ethernet switch design for Turbo Ring™ redundant networking and a recovery time of under 20 ms
- Advanced serial communication via hardware-based ADDC® (Automatic Data Direction Control) in RS-485 communication
- Award-winning and intuitive Click&Go Logic for Active Ethernet I/O
- Flexible, reliable Windows/Linux Real COM driver and operation modes for serial-to-Ethernet applications
- The most up-to-date Windows drivers and WHQL compliance
- Wide selection of Linux and Unix drivers
- Turbo Roaming™: Industrial IEEE 802.11 solution for seamless connections and long-distance communication
- OnCell Central Manager: Centralized management solution for accessing private IPs from the Internet

In addition, we ensure in-depth support for your needs through our strong engineering capabilities:

- x86 and RISC-based embedded platform design
- In-house ASIC chip design



Sales and Service

Moxa maintains a global sales and service network that puts the customer first

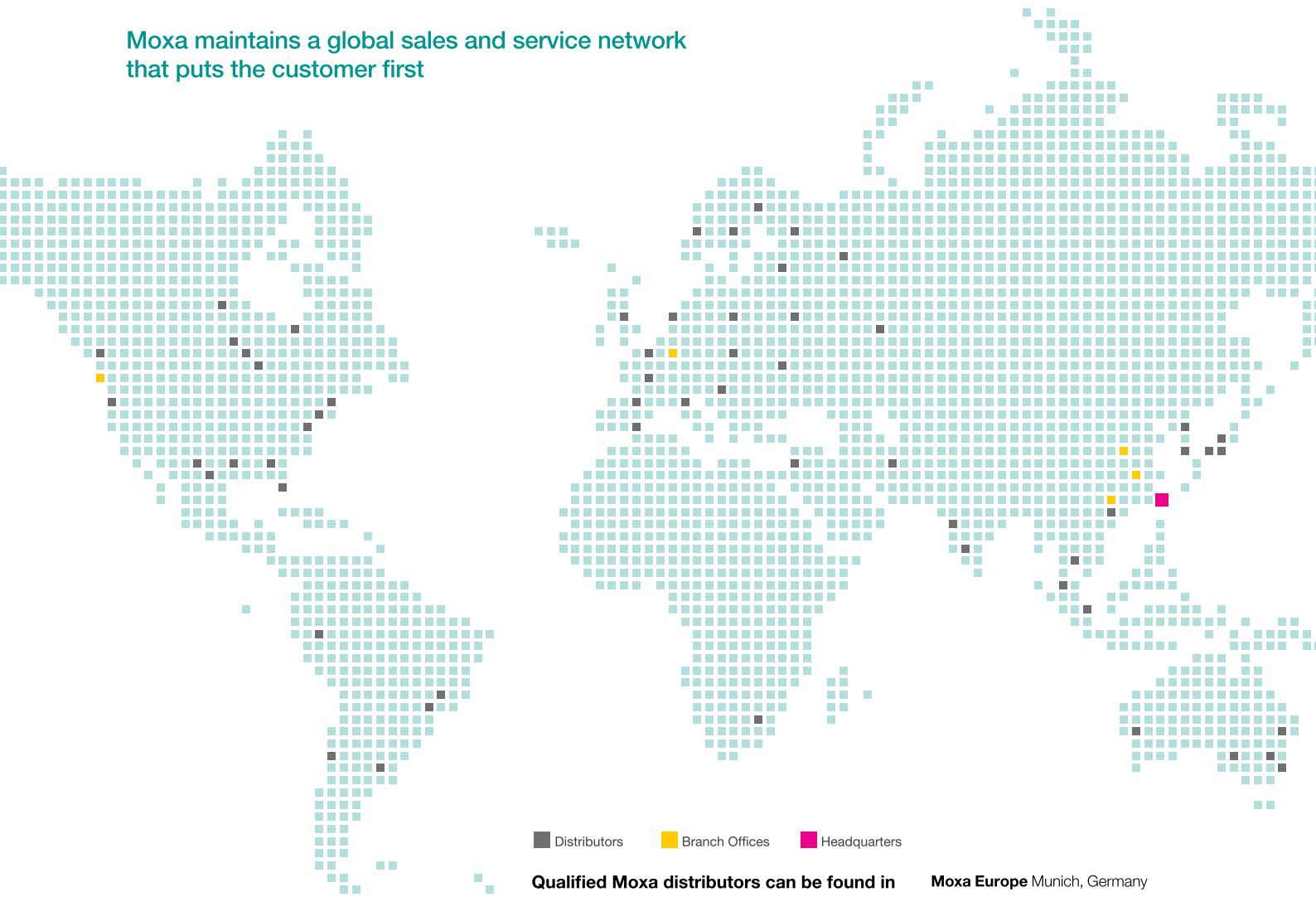

■ Distributors ■ Branch Offices ■ Headquarters

Qualified Moxa distributors can be found in more than 60 countries around the world. Moxa headquarters is in Taiwan, and we have branch offices on three continents.

Moxa Europe Munich, Germany
Moxa Asia-Pacific Taipei, Taiwan
Moxa Americas Brea, California
Moxa China Beijing, Shanghai, Shenzhen

Milestones

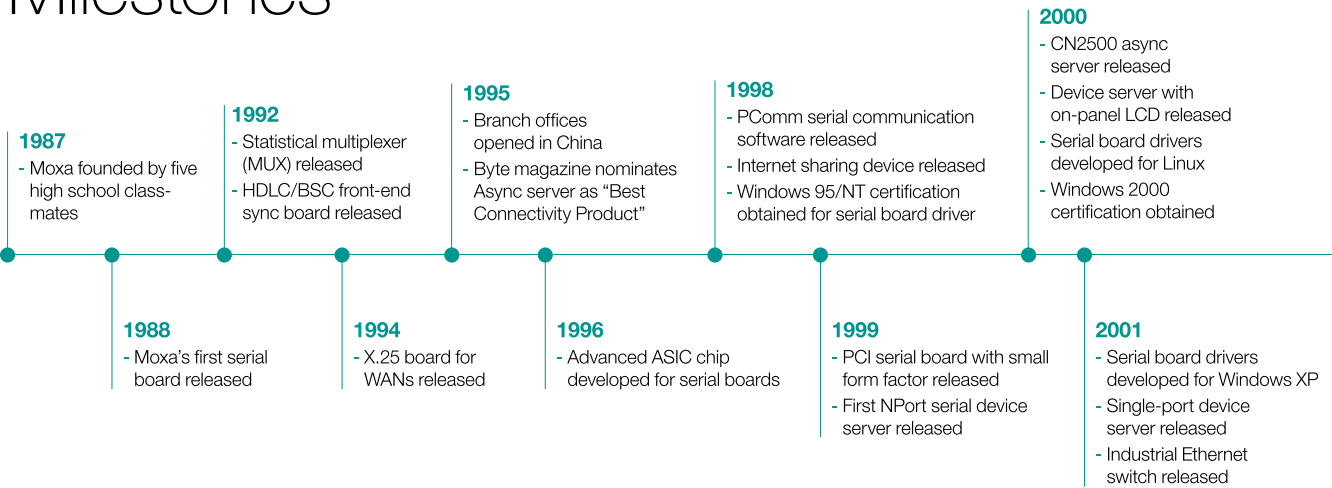



International coverage

With Moxa offices in the United States, Europe, China, and Taiwan, users around the world can benefit from the highest level of technical expertise and professionalism. In addition, the MTSC (Moxa Technical Support Certification) program ensures that certified distributors deliver the highest standard of service.

Highly experienced sales professionals

Moxa sales reps take great pride in their deep understanding of the market and available technology. Clients can speak directly with a Moxa sales rep about detailed project specifications, testing requirements, and network architecture. In addition, all Moxa distributors are required to meet rigorous standards for quality, integrity, and technical proficiency.

World-class support

In every region of the world, users of Moxa products receive the highest level of support from teams of specialists that are trained and certified by Moxa. Integrators also benefit from Moxa's extremely responsive engineering team, which can tailor products to fit a project's special needs. Most Moxa products are also backed by a 5-year warranty, which is one of the most generous warranties in the industry.

2002

- US branch office opens in California
- Managed Ethernet switch released
- Serial-to-fiber converter released
- Universal PCI serial boards released

2004

- Video servers released
- Embedded computer line introduced
- Dual-Ethernet terminal servers released

2006

- Europe branch office opens in Munich
- Control Engineering Engineer's Choice award for Active Ethernet I/O server
- Industrial Engineering News award for NPort W2004 wireless device server
- UPort USB-to-serial line introduced

2008

- PowerTrans IEC 61850-3 Ethernet switch introduced for substation automation
- Good Design Awards and Red Dot product design award for EDS-728 modular Ethernet switch, NPort 6450 terminal server, and Modbus Gateway MB3270i
- Red Dot product design award for EDS-728
- Ranked among top 20 best companies to work for in Taiwan

2003

- Moxa Technical Support Certification (MTSC) established
- Turbo Ring redundant network topology developed
- PC/104 serial boards released

2005

- Control Engineering Editor's Choice award for EDS-508 Ethernet switch
- iF Product Design award for EDS-726 Ethernet switch
- ioLogik Ethernet I/O server released
- AWK wireless access point released

2007

- OnCell industrial cellular modem released
- ioMirror peer-to-peer I/O server released
- Control Engineering Engineer's Choice award for W315 wireless embedded computer
- MGate Modbus gateways released

Table of Contents

About Moxa	i
Chapter 1: Industrial Networking Applications	1
Chapter 2: New Product Showcase	9
Chapter 3: Product Selection Guides	
Industrial Ethernet Switches	
Managed Ethernet Switches	20
Unmanaged Ethernet Switches	22
Industry-specific Ethernet Switches	
M12 Ethernet Switches	24
IEC 61850-3 Rackmount Ethernet Switches	25
Industrial I/O	
Stand-alone Type I/Os	26
Modular Type I/Os	26
Modular Remote I/O Selection Guide	27
Video Networking Solutions	
Video Networking Products	28
Terminal Servers	
NPort® 6000 Terminal Servers	29
CN2600 Terminal Servers	31
Serial Device Servers	
Combo Switch / Serial Device Server	33
General-purpose Device Servers	34
Industrial-grade Device Servers	38
Embedded Device Servers	39
Ethernet Fieldbus Gateways	
Ethernet Fieldbus Gateways	40
Multiport Serial Boards	
PCI Express Serial Boards	42
Universal PCI Serial Boards	43
Fiber Optic Serial Boards	45
ISA Serial Boards	46
PC/104 Modules	48
PC/104-Plus Modules	49
Industrial USB	
USB-to-Serial Converters	50
USB Hubs	52
Media Converters	
Chassis Media Converters	53
Serial-to-Fiber Media Converters	54
Serial Converters and Repeaters	55
Ethernet-to-Fiber Media Converters	56
WLAN & Cellular Solutions	
Industrial AP/Bridge/Client Solutions	57
Wireless Serial Device Servers	58
Cellular Routers and IP Gateways	59
Cellular IP and GSM/GPRS Modems	60
Embedded Computers for Communication	
Wallmount Computers	61
Rackmount Computers	64
Module/Board Computers	66
Embedded Computers for Automation	
DIN-Rail Computers	67
Wireless Embedded Computers	
RISC-based WLAN Computers	68
Cellular Computers	69

Industrial Networking Applications

Power Automation

The field of power automation is composed of the following fundamental systems: power generation, power transmission, and power distribution. For each of these systems, Moxa offers device networking products to facilitate different power automation applications.

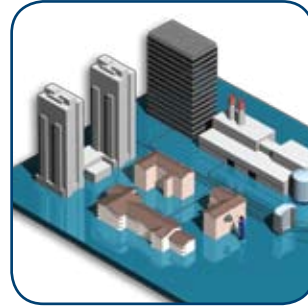

Power Substation Automation	2
Automatic Meter Reading	3
Renewable Energy	4

Transportation Automation

Many advanced and cost-effective options are available to improve the efficiency of transportation systems through automation. A wide selection of Moxa products can be used for intelligent transportation system (ITS) applications of almost any size and scope.



Fleet Management	5
IP-based Train Control	6

Factory Automation

Every manufacturing facility has two essential components: the production line and the facility itself. Moxa offers the right device networking products for automating both production line management and facility monitoring operations.



Production Line Management	7
--------------------------------------	---

Oil and Gas Automation

Oil and gas production can be divided into three stages: upstream, midstream, and downstream. From drilling to refining, Moxa products can be used to optimize efficiency, productivity, reliability, and safety at any stage of oil and gas production.



Oil Refinery Monitoring	8
-----------------------------------	---

1 Industrial Networking Applications



Power Substation Automation

Reliability, speed, and real-time response are critical for communication between devices at a power plant or power substation. Use Moxa products to build a truly industrial-grade network backbone that supports real-time monitoring and control.

Products



The **DA-681** embedded computer is a protocol gateway that handles multiple devices running different protocols for front-end data computing and protocol conversion.



The **DA-682** embedded computer serves as an embedded backbone host and central controller for data analysis, processing, and transmission back to the control center.



The **IKS-6726** Gigabit modular rackmount Ethernet switch uplinks with the network ring and connects with embedded computers; its industrial, rugged design is ideal for harsh environments.



The **PT-7728** Gigabit modular Ethernet switch forms a network ring for redundancy, ensuring superior reliability for complex, high voltage substation environments through IEC 61850-3 and IEEE 1613 compliance.



The **IMC-101** industrial media converters provide industrial grade media conversion between 10/100BaseT(X) and 100BaseFX (SC/ST connectors).



The **IMC-101G** industrial Gigabit media converters provide reliable and stable 10/100/1000BaseSX/LX/LHX/ZX media conversion in harsh industrial environments.

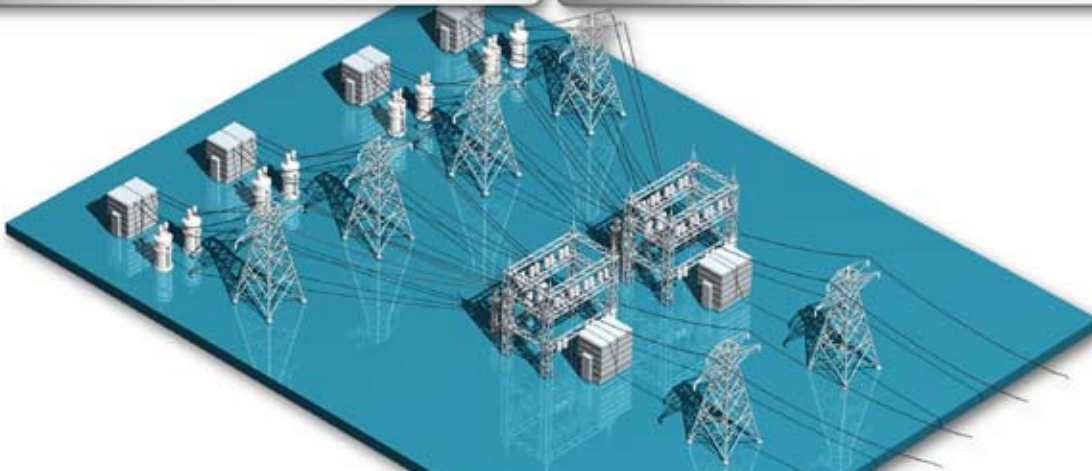
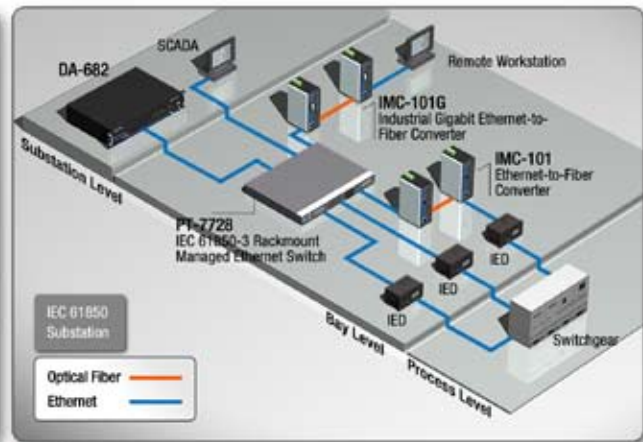
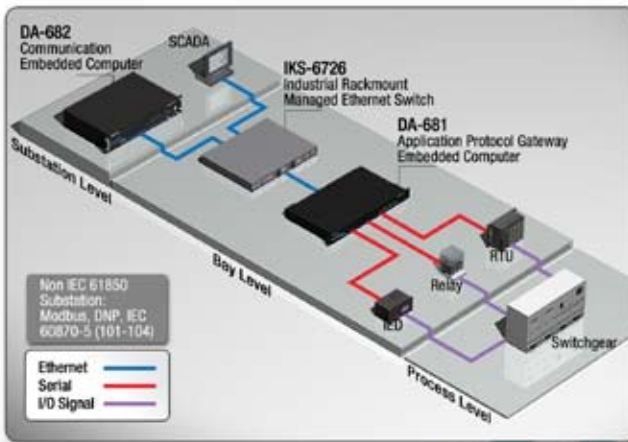

1

Industrial Networking Applications > Power Substation Automation

Automatic Meter Reading

A great deal of time and effort is wasted when technicians need to make regular in-person visits to take manual power meter readings. Automated meter reading systems have become an increasingly popular alternative and can be established by using Moxa products to connect power meters to central management workstations.

Products



The **W325** embedded computer stores metering data, converts it from proprietary protocols to the standard protocols used by the automation system, performs front-end computing, and then transmits the data to central servers via GSM/GPRS.



The **AWK-3121** provides wireless connection for Ethernet-enabled devices in addition to standard STP/RSTP support for looping protection and redundant communication links.



The **OnCell G3150** cellular IP gateway makes use of high speed wireless GSM/GPRS/EDGE technologies and provides secure TCP/IP connection to your remote power meters over cellular networks.



The **ioLogik E2210** Active Ethernet I/O collects readings from power meters through event-based messaging, allowing system administrators to actively retrieve data for better management.



The **NPort® W2150 Plus** collects data from the power meters over RS-232 or RS-485 connections, and then transmits the encrypted data to central servers over a WiFi network.

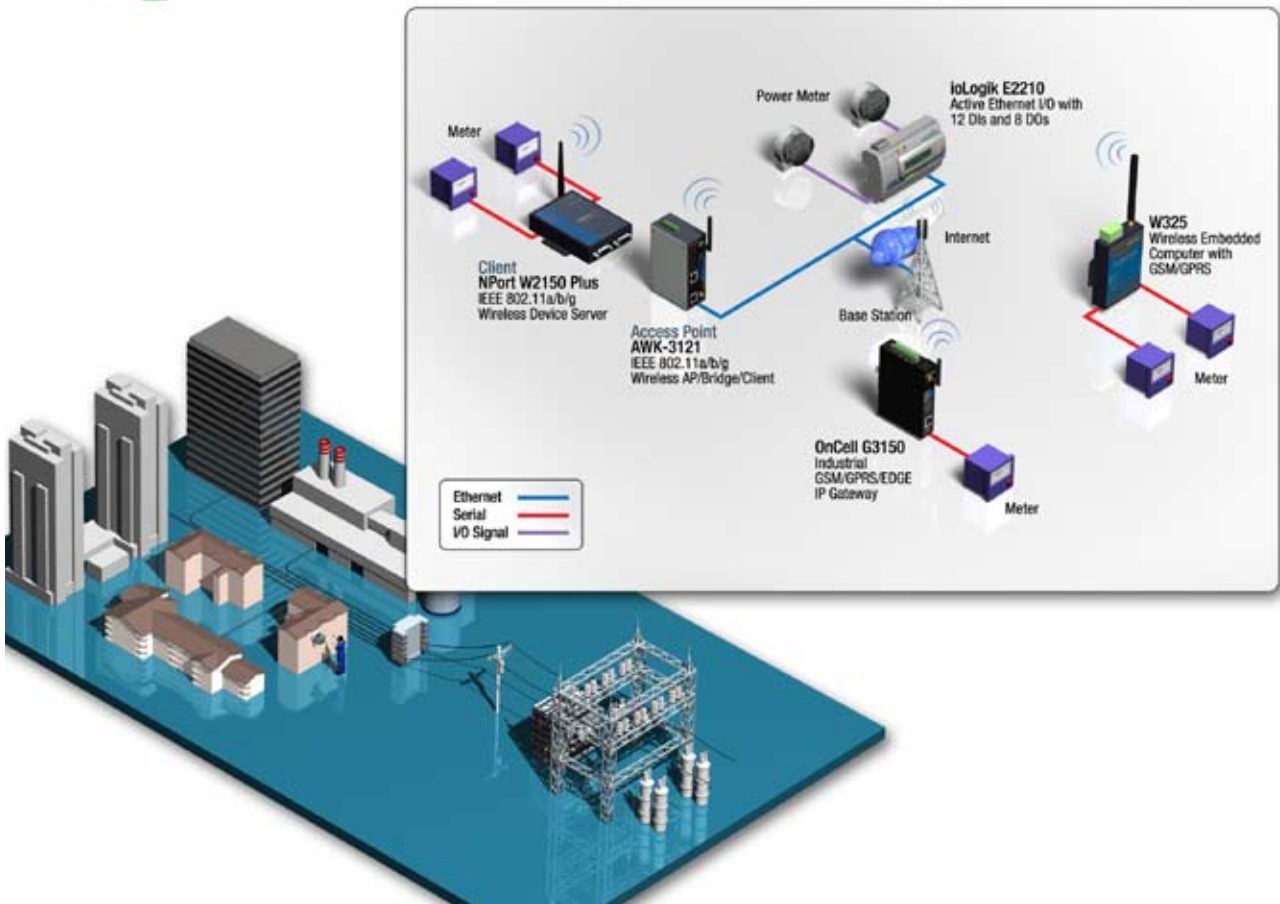

Renewable Energy

Rising fuel costs and global warming have led to rapid growth in worldwide demand for renewable energy. In response to the worldwide search for alternative sources of energy, solar power and wind power have emerged as two of the most viable options. Moxa provides a wide range of networking solutions to help harness the power of these invaluable resources.

Products



The **W321** and **UC-7112** embedded computers can be used as front-end controllers that connect to the PV inverter, AI and counter input module, and power meter. They can also be used for temperature monitoring, data acquisition, data logging, and protocol conversion.



The **UC-8410** embedded computer is used to control, manage, and remotely monitor the equipment making up a solar power system.



The **V468** and **IA260** embedded computers can serve as the central controller for mapping and tracking the Sun in solar power plants, and sending data back and forth between the tracker and control center.



The **EDS-408A** 3-fiber Series Ethernet switches provide network redundancy in the form of a fiber ring topology with super fast recovery time < 20 ms for reliable Ethernet network communication in wind farms.



With Active OPC server, the **ioLogik E2242** Active Ethernet I/O proactively updates event messages to the control center with real-time stamps over the network, effectively integrating it with a real-time SCADA/HMI system.



Moxa's **NPort® 5210** device server can convert industrial serial devices inside a wind turbine into Ethernet devices.



The **UPort™ 1610-16** converters can connect 16 RS-232 devices to your workstation/laptop by USB. With Moxa's own CPU, the **UPort™ 1610** offers USB 2.0 connectivity, 128 bytes FIFO, and HW/SW flow control.



Moxa's **CB-108** connects an industrial PC directly to multiple RS-232 devices. All Moxa's PC/104 and PC/104-Plus modules provide a reliable, high performance solution for serial communication

Solar Community

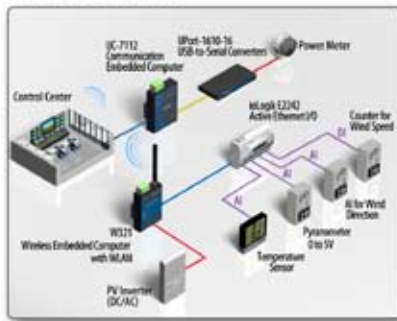

Solar Transportation

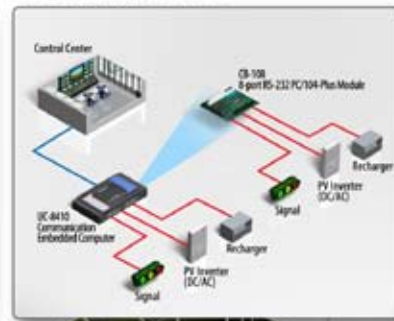

Solar Tracking System

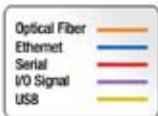
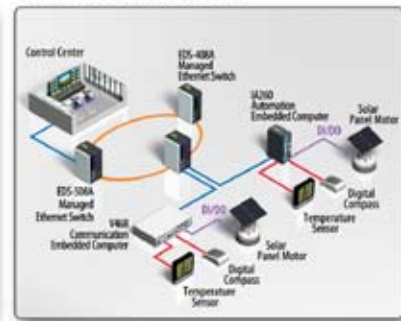

Wind Power

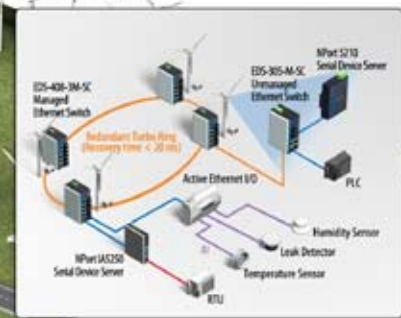

1

Industrial Networking Applications > Renewable Energy

Fleet Management

Managing large fleets of trucks or buses around the country requires a scalable system that is designed for maximum mobility and efficiency. By taking advantage of Moxa's wide selection of products, a management system can be established to fit nearly any requirement and size.

Products



The **W345** collects data from the onboard GSM/GPRS and transmits the data wirelessly over cellular networks to the control center.



The **NPort® W2150 Plus** allows collected data on the EM-1240 to be transferred wirelessly to the central server when the vehicle is at the station.



The **CP-118U** connects a PC to a large number of devices for station management, including a ticket printer, scanner, vehicle sensor, and modem.



The **UPort™ 1450** connects a laptop and multiple devices for SNG data collection, allowing command centers to gather intelligence and other data with greater mobility.



The **AWK-4121-T** allows information from the vehicle's data collection devices to be downloaded wirelessly when the vehicle arrives in the station.

Fleet Management System

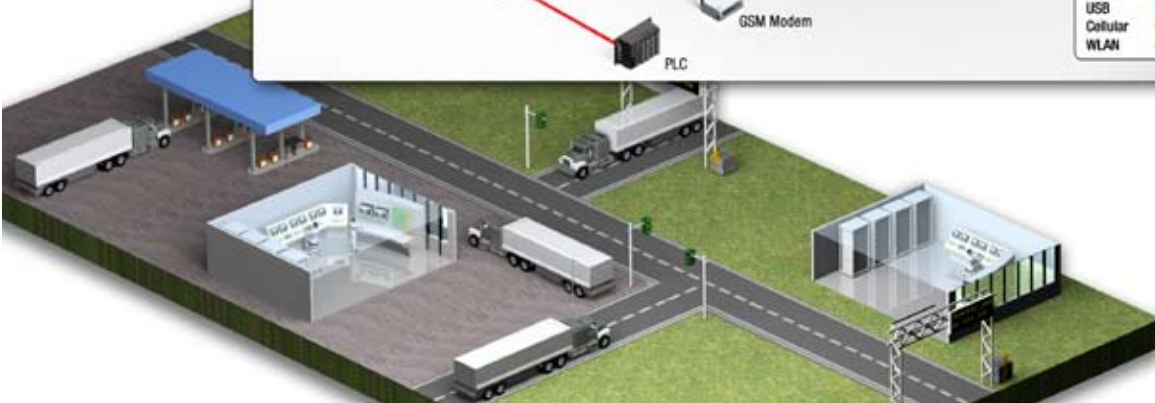
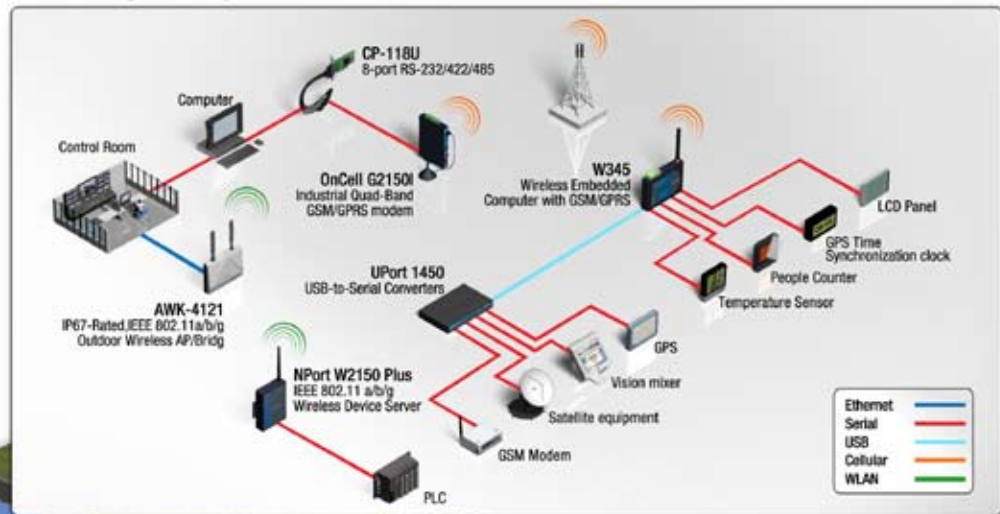

1

Industrial Networking Applications > Fleet Management

IP-based Train Control

Moxa's industrial Ethernet products, wireless solutions, serial-to-Ethernet device servers, and embedded computers are ideally suited for IP-based train control systems. High port density Ethernet switches and outdoor wireless access points can establish a robust network for rolling stock, along-track, and ground station applications.

Products



The **AWK-4121-T** industrial IEEE 802.11a/b/g outdoor wireless AP/Bridge/Client provides wireless communication capability at speeds up to 100 km/hr with Turbo Roaming under 500 ms.



The **DA-662-I** communication embedded computer can be used as an intelligent control platform to handle daily operation aboard trains and ensure reliable performance for rail transport systems.



The **AWK-3121** industrial IEEE 802.11a/b/g wireless Access Point/Bridge/Client can be installed in each car to provide seamless wireless connection to railway stations and control systems.



The **VPort 25** IP camera has a vandal-proof design, IP66 protection, -40 to 50°C operating temperature, and Power-over-Ethernet capability, which is ideal for constructing a secure surveillance system aboard trains.



The **IKS-6726** industrial rackmount Ethernet switch meets EN50155/EN50121-4 certifications, guaranteeing high adaptability and reliable Gigabit speeds for severe conditions including vibrations, shocks, and wide operating temperatures from -40 to 75°C.



The **NPort® 6650-S2** collects data from PLCs via RS-232 or RS-485 connections and then transmits the data to central servers.



The **TN-5500 series** M12 managed Ethernet switches with EN50155/50121-3-2/50121-4 certification are tough enough to withstand critical vibrations and shocks, ensuring robust communication between all Ethernet-enabled devices over a network.

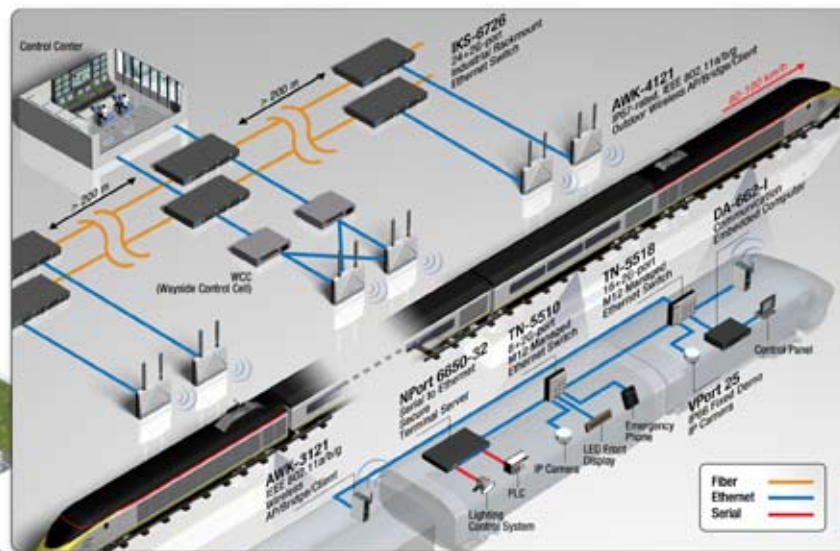

Production Line Management

By incorporating monitoring devices into a centralized control network, manufacturers can achieve significant gains in productivity. Moxa offers products that directly or wirelessly connect CNCs, robots, AGVs, sensors, PLCs, RTUs, and other devices to management networks.

Products



The **EDS-728** offers up to 4 Gigabit ports, advanced network control, and scalability for a high-performance network backbone.



The **EDS-508A** Ethernet switch forms a redundant Ethernet network with a recovery time under 20 ms, connecting Ethernet devices for non-stop daily operation.



The **VPort 351** video encoders feature wide operating temperature from -40 to 75°C, fiber support, and fanless design for distributed IP surveillance systems.



The **ioLogik E2214** I/O device provides event-driven alarm messaging with real-time stamps, Click&Go configuration, and SNMP support for real-time monitoring and local control of meters and sensors.



The **AWK-3121** and **NPort® W2150 Plus** can connect primary workstations and factory equipment to a wireless network.



The **IA262-I** features DIOs to control conveyer belts, VGA connectors to display and collect scanned data, and is also capable of computing and sending data to the control center.



The **NPort® 6650-32** collects serial data from meters and sensors transmitting the data to central servers.



The **CP-104EL** connects an industrial PC directly to multiple PLCs, meters, RTUs, and other monitoring devices.



The **IMC-101** converts 10/100BaseT(X) to 100BaseFX fiber optic connections.



The **NPort® S8455I-MM-SC** integrates 2 fiber ports, 3 Ethernet ports, and 4 RS-232/422/485 serial ports, connecting both Ethernet and serial devices to an Ethernet network for redundancy.



The **MGate MB3170** is designed to integrate Modbus, TCP, ASCII, and RTU devices in almost any master/slave combination.



The **UPort 1410** converters can connect 4 RS-232/422/485 devices to your workstation by USB.

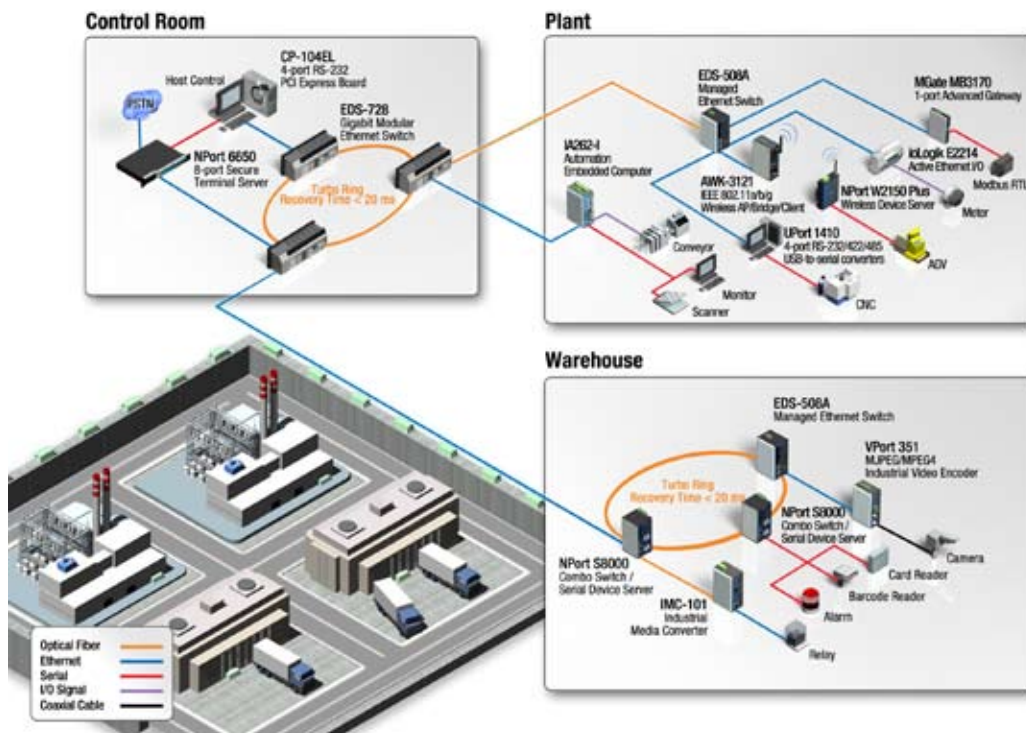

Oil Refinery Monitoring

Distributed Control Systems (DCS) are deployed in complex oil refining processes to connect the entire system of controllers for communication and monitoring. Moxa's industrial networking products, with Class I Division 2 and DNV/GL certifications, extended operating temperature, redundancy technology, and intelligent management features, can develop a hazard-free Ethernet network for non-stop system operation and monitoring in oil refineries.

Products



The **EDS-728** modular Gigabit managed Ethernet switch establishes dual redundant Ethernet networks for a DCS that offers media modules flexibility and supports Turbo Ring redundant technology with a recovery time less than 20 ms.



The **EDS-510A** Gigabit managed Ethernet switch is ideal for constructing a redundant fiber-optic Ethernet network with high bandwidth and reliability, thanks to its support for up to 3 Gigabit ports, -40 to 75°C operating temperature, and industrial ratings (Class I Division 2, DNV/GL).



The **VPort 254** industrial video encoder, with -40 to 75°C operating temperature, Class I Division 2 certification, and redundant power inputs, connects analog cameras over a Gigabit network for real-time video streaming and robust surveillance.



The **NPort® IA5000** series industrial serial-to-Ethernet device server connects PLCs, sensors, and other serial-based devices to an Ethernet network and ensures reliable communication due to its industrial rating and wide operating temperature design.



The **ioLogik E2214** Active Ethernet I/O product delivers event-driven reporting with time stamp for precise status updates and real-time alarm management.

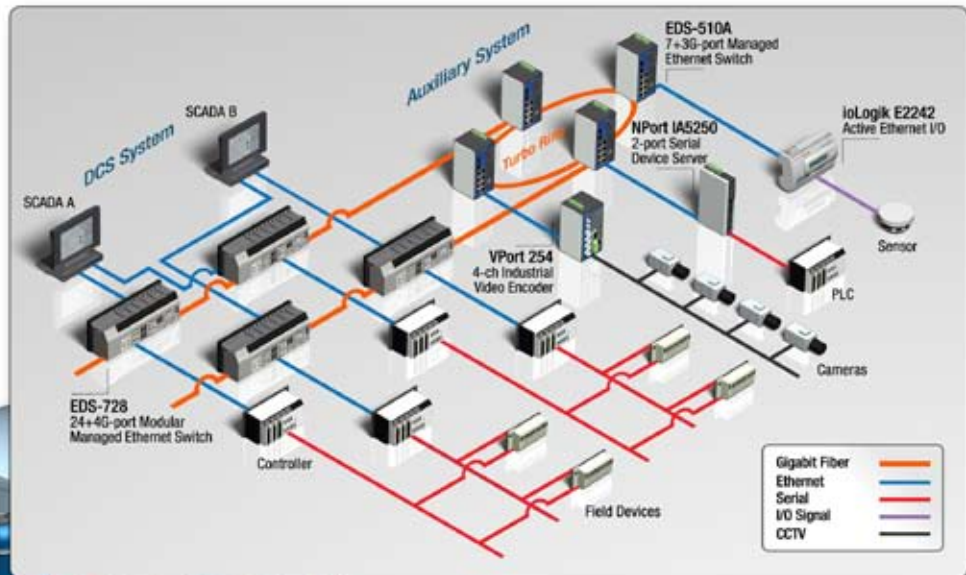

1

Industrial Networking Applications > Oil Refinery Monitoring



New Product Showcase

New Product Showcase

Industrial Ethernet Switches	10
Industry-specific Ethernet Switches	10
Industrial I/O	11
Video Networking Solutions	12
Terminal Servers	12
Serial Device Servers.	13
Ethernet Fieldbus Gateways.	13
Multiport Serial Boards	14
USB Connectivity	14
Media Converters	15
WLAN & Cellular Solutions	16
Embedded Computers for Communication	17
Embedded Computers for Automation	18

2

New Product Showcase



New Product Showcase

Industrial Ethernet Switches

EDS-608 (page 3-24)

Coming Soon

8-port compact modular managed Ethernet switch



Features

- > Modular design lets you choose from a variety of media combinations
- > Turbo Ring and RSTP/STP (IEEE 802.1w/D) for Ethernet redundancy
- > QoS, IGMP snooping/GMRP, VLAN, LACP, SNMPv1/v2c/v3, RMON supported
- > IEEE 802.1X, HTTPS, and SSH to enhance network security
- > -40 to 75°C operating temperature (T models)

EDS-G509 Series (page 3-29)

9G-port full Gigabit managed Ethernet switches



Features

- > 4 10/100/1000BaseT(X) ports plus 5 combo (10/100/1000BaseT(X) or 100/1000BaseSFP slot) Gigabit ports
- > Fiber optic options for extending distance and improving electrical noise immunity
- > Turbo Ring, RSTP/STP (IEEE 802.1w/D) for Ethernet redundancy
- > QoS, IGMP snooping/GMRP, VLAN, LACP, SNMPv1/v2c/v3, RMON supported
- > IEEE 802.1X, HTTPS, and SSH enhance network security

EDS-P510 Series (page 3-40)

7+3G-port Gigabit PoE managed Ethernet switches



Features

- > 4 IEEE 802.3af-compliant PoE and Ethernet combo ports
- > Provides up to 15.4 watts at 48 VDC per PoE port
- > Intelligent power consumption detection, classification, and PoE scheduling function
- > 3 combo (10/100/1000BaseT(X) or 100/1000BaseSFP slot) Gigabit ports; 2 ports for redundant ring and 1 port for uplink
- > Turbo Ring (recovery time < 20 ms), RSTP/STP (IEEE 802.1w/D) for Ethernet redundancy

IKS-6726 Series (page 3-14)

24+2G-port Gigabit modular managed Ethernet switches



Features

- > Meets UL 60950-1, NEMA TS2, EN50155/EN50121-4, and DNV/GL certifications
- > Turbo Ring and RSTP/STP for Ethernet redundancy
- > Isolated redundant power inputs with universal 24/48 VDC or 110/220 VDC/VAC power supply
- > Modular design lets you choose from a variety of media combinations
- > -40 to 75°C operating temperature range

EDS-G205/G308 Series (page 3-57)

5G and 8G-port full Gigabit unmanaged Ethernet switches



Features

- > Fiber optic options for extending distance and electrical noise immunity (EDS-G308)
- > Redundant dual 12/24/48 VDC power inputs
- > Relay output warning for power failure and port break alarm
- > Broadcast storm protection
- > -40 to 75°C operating temperature range (T models)

EDS-205A/208A Series (page 3-62)

5 and 8-port unmanaged Ethernet switches



Features

- > 10/100BaseT(X) (RJ45 connector), 100BaseFX (multi/single-mode, SC or ST connector)
- > Redundant dual 12/24/48 VDC, 18 to 30 VAC power inputs
- > IP30 aluminum housing
- > Rugged hardware design well-suited for hazardous locations (Class I Div. 2 / Zone 2) and marine environments (DNV/GL/ABS/LR/NKK)
- > -40 to 75°C operating temperature range (T models)

Industry-specific Ethernet Switches

TN-5508/5510/5516/5518 Series (page 4-7)

Coming Soon

8, 8+2G, 16, 16+2G-port M12 managed Ethernet switches



Features

- > M12 connectors for robust links
- > Wide power input range from 12 to 110 VDC (LV-MV model)
- > Isolated redundant power inputs with universal 12/24/36/48 VDC, 72/96/110 VDC, or 110/220 VDC/VAC power supply range
- > 2-port flexibility of Gigabit Ethernet ports with relay bypass function
- > EN50155/50121-3-2/50121-4, NEMA TS2, and e1 compliant
- > -40 to 75°C operating temperature range (T models)

TN-5308 Series (page 4-10)

Coming Soon

8-port M12 unmanaged Ethernet switches



Features

- > Universal 12/24/36/48 or 72/96/110 VDC power supply range
- > M12 connectors and IP40 metal housing
- > Supports IEEE 802.3/802.3u/802.3x
- > EN50155/50121-3-2/50121-4, NEMA TS2, and e1 compliant
- > -40 to 75°C operating temperature range (T models)

PT-7828 Series (page 4-20)

IEC 61850-3 24+4G-port Layer 3 Gigabit modular managed rackmount Ethernet switches



Features

- > Layer 3 routing to interconnect multiple LAN segments
- > IEC 61850-3, IEEE 1613 (power substations), NEMA TS2 (traffic control systems), and EN50121-4 (railway applications) compliant
- > Turbo Ring and RSTP/STP for Ethernet redundancy
- > Isolated redundant power inputs with universal 24/48 VDC or 110/220 VDC/VAC power supply range
- > Modular design for various media options: RJ45, fiber optic, M12, and SFP ports
- > -40 to 85°C operating temperature range

PT-7710 Series (page 4-26)

IEC 61850-3 8+2G-port Gigabit modular managed rackmount Ethernet switches



Features

- > IEC 61850-3, IEEE 1613 (power substations), NEMA TS2 (traffic control systems), and EN50121-4 (railway applications) compliant
- > Turbo Ring and RSTP/STP for Ethernet redundancy
- > Universal power supply range, 12/24/48 VDC or 110/220 VDC/VAC
- > Modular design lets you choose from a variety of media combinations
- > -40 to 85°C operating temperature range

Industrial I/O

Active OPC Server Lite (page 5-11)

Seamlessly connect ioLogik to your SCADA system



Features

- > OPC DA 3.0 supported
- > Event-driven tag update:
 - Save 80% on network bandwidth
 - I/O response that's 7 times faster
- > Patented automatic tag generation
- > Firewall-friendly connection from remote ioLogik devices
 - Allows remote I/O to use dynamic IP
 - Allows remote I/O to use private IP
- > Download free from Moxa's website

Click&Go (page 5-13)

Easy and intuitive I/O control configuration for ioLogik Active Ethernet I/O



Features

- > PC-free solution with local intelligence
- > Programming-free IF-THEN-ELSE logic reduces setup time
- > Time stamped active alarm reports with TCP, UDP, SNMP Trap, email, SMS, or CGI commands
- > Time-based scheduler and timer control
- > Input-to-output control over IP with peer-to-peer and remote action

ioLogik E2242 (page 5-19)

Active Ethernet I/O with 4 analog inputs and 12 configurable DI/Os



Features

- > 4 fixed differential analog input channels
- > 12 configurable digital input/output channels
- > DI counter saved automatically when power shuts off
- > Instant event messaging by TCP/UDP/email/SNMP-Trap
- > PC-based configuration utility and web console
- > Easy-to-use Click&Go™ Logic for local output control
- > Windows/WinCE VB/VC.NET and Linux C APIs
- > I/O control over Modbus/TCP and SNMP protocol
- > NIST traceable calibration

ioMirror E3210 (page 5-22)

Ethernet Peer-to-Peer I/O with 8 digital inputs and 8 digital outputs



Features

- > Direct input-to-output signal communication over IP
- > High speed Peer-to-Peer I/O within 20 ms
- > One physical alarm port for connectivity status
- > Quick and easy utility and web-based settings
- > Local alarm channel and remote alarm messaging
- > Supports Modbus/TCP for remote monitoring
- > Optional LCD module for convenient configuration

ioLogik E4200 (page 5-24)

Modular Active Ethernet I/O adaptor



Features

- > Supports up to 16 I/O modules
- > Dual Ethernet LANs and one RS-232 port
- > Front-end intelligence that supports 80 Click&Go rules
- > Unicode Active Messaging with real-time stamp, including SMS, SNMP Trap with I/O status, TCP, email
- > Built-in web console
- > PC utility: Auto detection of installed modules
- > Windows/WinCE VB/VC.NET and Linux C APIs

ioLogik W5340 (page 5-27)

Active GPRS I/O with 4 AIs, 8 DI/Os, and 2 relay outputs



Features

- > GPRS, Ethernet LAN, RS-232/422/485 supported
- > Smart Active GPRS connection
- > Low power consumption
- > Secure wake on call ID
- > Active messaging with real-time stamp
- > SNMP Trap with I/O status
- > Data logging with SD card
- > Unicode Active Messaging with real-time stamp, including SMS, SNMP Trap with I/O status, TCP, email
- > ioAdmin and Active OPC Server supported
- > Windows/WinCE VB/VC.NET and Linux C APIs

Video Networking Products

VPort 354 Series (page 6-7)

Coming Soon

Full motion, 4-channel MJPEG/MPEG4 industrial video encoders



Features

- > Industrial design with -40 to 75°C operating temperature and fiber optic Ethernet port
- > 2 Ethernet ports for cascade and port redundancy
- > SD card slot for local storage capability
- > Modbus/TCP supported for easy communication with SCADA software
- > Video stream up to 120 frames/sec at 4CIF (704 x 480) resolution

VPort 351 Series (page 6-13)

Full motion, 1-channel MJPEG/MPEG4 industrial video encoder



Features

- > Industrial design with -40 to 75°C operating temperature and fiber optic Ethernet port
- > Video stream up to 30 frames/sec at full D1 (720 x 480) resolution
- > Pre/post-alarm video recording function for advanced surveillance
- > 2-way (1-in/1-out) audio supported
- > Free VPort SDK PLUS and 4-channel video surveillance software

VPort 251 (page 6-20)

Full motion, 1-channel MJPEG/MPEG4 video encoder



Features

- > Compress analog video/audio signals into MJPEG/MPEG4 video streams
- > Video stream up to 30 frames/sec at full D1 (720 x 480) resolution
- > 2-way (1-in/1-out) audio supported
- > Transparent PTZ control for using legacy PTZ control panel or keyboard
- > Loop-through power output for powering an analog camera

VPort D351 (page 6-22)

1-channel MJPEG/MPEG4 industrial video decoder



Features

- > Decode MJPEG and MPEG4 video streams to an analog video signal automatically
- > Manual selection or automatic scan with maximum of 64 video sources
- > 2-way (1-in/1-out) audio supported
- > Transparent PTZ control with legacy PTZ controller
- > SNMP for network management

VPort 25 Series (page 6-24)

IP66, day-and-night vandal-proof fixed dome IP camera for outdoors



Features

- > -40 to 50°C operating temperature; heater or fan not required
- > IP66-rated for protection from rain and dust
- > Direct-wired power input and PoE for power redundancy
- > Up to 30 frames/sec at 720 x 480 resolution
- > One camera lens for both day and night use

SoftNVR (page 6-27)

Expandable IP surveillance software for managing up to 64 video channels



Features

- > Multi-screen viewing format (maximum of 64 channels)
- > Dual monitor capability
- > Video analytics and instant response
- > Video quality enhancement tools
- > Intelligent and convenient video search

Terminal Servers

CN2600 Series (page 7-24)

8 and 16-port RS-232/422/485 terminal servers with LAN redundancy



Features

- > LCD panel for easy IP address configuration
- > Dual-LAN cards with two independent MAC addresses and IP addresses
- > Redundant COM function available when both LANs are active
- > Dual-host redundancy can be used to add a backup PC to your system
- > Dual AC power inputs
- > Real COM/TTY drivers for Windows and UNIX

2

New Product Showcase

Serial Device Servers

NPort S8000 Series (page 8-16)

Combo switch / serial device server



Features

- > Configurable serial data transmission priority
- > 5-port managed Ethernet switch built in
- > Ethernet redundancy with Turbo Ring® (recovery time < 20 ms) or RSTP/STP (IEEE 802.1w/D)
- > QoS, IGMP-snooping/GMRP, VLAN, LACP, SNMPv1/v2c/v3, RMON supported
- > 4-port RS-232/422/RS-485 serial device server
- > 2 KV (DC) isolation protection for each serial port
- > Surge protection for serial, power, and Ethernet
- > 15 KV ESD surge protection for all serial signals
- > Adjustable pull high/low resistor and terminator for RS-485 ports

NPort 5600 Desktop Series (page 8-35)

8-port RS-232/422/485 serial device servers



Features

- > 8 serial ports supporting RS-232/422/485
- > Compact desktop design
- > 10/100M auto-detecting Ethernet
- > Built-in 15 KV ESD protection for all serial signals
- > Easy IP address configuration with LCD panel
- > Choice of configuration methods: Web console, Telnet console, and Windows utility
- > Versatile socket operation modes, including TCP Server, TCP Client, UDP, and Real COM
- > SNMP MIB-II for network management
- > Built-in recorder: Use your own voice as the alert when exceptions occur

MiiNePort E1 Series (page 8-42)

Coming Soon

10/100 Mbps embedded serial device servers



Features

- > Same size as an RJ45 connector—only 33.9 x 16.25 x 13.5 mm
- > Extremely low power consumption—only 600 mW @ 3.3 VDC input
- > Uses the MiiNe, Moxa's second generation SoC
- > NetEz technology makes integration incredibly easy
- > Versatile choice of operation modes: Real COM, RFC2217, TCP Server, TCP Client, UDP, and Modem

WE-2100T Series (page 8-49)

Wireless LAN embedded serial device servers



Features

- > Connects serial devices to IEEE 802.11a/b/g networks
- > Choice of operation modes: Real COM, TCP Server, TCP Client, UDP, and RFC2217
- > Windows (including Vista) Real COM and Linux fixed TTY drivers provided
- > Wireless security with WEP, WPA, and WPA2
- > Select any baudrate between 50 bps and 921.6 Kbps
- > 9 programmable digital I/O channels
- > SSL/SSH encryption for configuration
- > Compact size and easy to mount housing

Ethernet Fieldbus Gateways

MGate™ MB3170/3270 (page 9-8)

1 and 2-port advanced serial-to-Ethernet Modbus gateways



Features

- > Configuration is exceptionally easy
- > Slave mode supports 16 TCP masters and up to 62 serial slaves at the same time
- > Master mode supports 32 TCP slaves at the same time
- > Emergency request tunnels ensure QoS control
- > Serial redirector function provided
- > Embedded Modbus protocol analyzer
- > Redundant dual DC power inputs
- > Built-in Ethernet cascading for easy wiring

MGate EIP3000 (page 9-13)

1 and 2-port DF1 to Ethernet/IP gateways



Features

- > Supports PCCC objects for Rockwell Automation networks
- > Supports 8 simultaneous Ethernet/IP clients with up to 16 simultaneous requests per client
- > Serial redirector function provided
- > Remote serial port for multiple DF1 device communication
- > Embedded Ethernet/IP and DF1 protocol analyzer
- > Redundant dual DC power inputs
- > Built-in Ethernet cascading for easy wiring

: Multiport Serial Boards

CP-102E/EL (page 10-26)

2-port RS-232 PCI Express boards



Features

- > PCI Express x1 compliant
- > 921.6 Kbps maximum baudrate for super fast data transmission
- > 128-byte FIFO and on-chip H/W, S/W flow control
- > Low profile form factor fits small-sized PCs
- > Drivers provided for Windows (2000, XP/2003/Vista/2008 x86/x64), Linux 2.4/2.6, QNX 6, Windows XP Embedded, SCO OpenServer 5/6, UnixWare 7
- > 15 KV ESD protection on the board

CP-132EL/EL-I (page 10-28)

2-port RS-422/485 PCI Express boards with optional 2 KV isolation



Features

- > PCI Express x1 compliant
- > 921.6 Kbps maximum baudrate for super fast data transmission
- > 128-byte FIFO and on-chip H/W, S/W flow control
- > Low profile form factor fits small-sized PCs
- > Drivers provided for Windows (2000, XP/2003/Vista/2008 x86/x64), Linux 2.4/2.6, QNX 6, Windows XP Embedded, SCO OpenServer 5/6, UnixWare 7
- > 15 KV ESD protection on the board

CP-112UL/112UL-I Series (page 10-52)

2-port RS-232/422/485 Universal PCI serial boards with optional 2 KV isolation



Features

- > Over 700 Kbps data throughput for top performance
- > 128-byte FIFO and on-chip H/W, S/W flow control
- > Universal PCI compatible with 3.3/5 V PCI and PCI-X
- > Serial communication speed up to 921.6 Kbps
- > Drivers provided for Windows (2000, XP/2003/Vista/2008 x86/x64), Windows CE 5.0/6.0, Windows XP Embedded, Linux 2.4/2.6, SCO OpenServer 5/6, UnixWare 7
- > Easy maintenance with on-board LED display
- > On-board 15 KV ESD and 2 KV optical isolation protection
- > Wide temperature model available for -40 to 85°C environments

CP-114EL/EL-I (page 10-22)

4-port RS-232/422/485 PCI Express boards with optional 2 KV isolation



Features

- > PCI Express x1 compliant
- > 921.6 Kbps maximum baudrate for super fast data transmission
- > 128-byte FIFO and on-chip H/W, S/W flow control
- > Low profile form factor fits small-sized PCs
- > Drivers provided for Windows (2000, XP/2003/Vista/2008 x86/x64), Linux 2.4/2.6, QNX 6, Windows XP Embedded, SCO OpenServer 5/6, UnixWare 7
- > 15 KV ESD protection on the board

CP-114UL/114UL-I (page 10-46)

4-port RS-232/422/485 Universal PCI serial board with optional 2 KV isolation



Features

- > Over 700 Kbps data throughput for top performance
- > 128-byte FIFO and on-chip H/W, S/W flow control
- > Universal PCI compatible with 3.3/5 V PCI and PCI-X
- > Serial communication speed up to 921.6 Kbps
- > Drivers provided for Windows (2000, XP/2003/Vista/2008 x86/x64, 9X/ME/NT), Windows CE 5.0/6.0, Windows XP Embedded, DOS, Linux 2.4/2.6, FreeBSD 4/5, QNX 6, SCO Open Server 5/6, UnixWare 7
- > Easy maintenance with on-board LED display
- > On-board 15 KV ESD and 2 KV optical isolation protection
- > Wide temperature model available for -40 to 85°C environments

CP-102UF Series (page 10-60)

2-port Universal PCI serial over fiber boards



Features

- > Extend serial transmission distance up to:
 - 40 km with single mode—CP-102UF-S-ST
 - 5 km with multi-mode—CP-102UF-M-ST
- > Supports "Ring" and "Point-to-Point" transmission modes
- > 921.6 Kbps maximum baudrate for super fast data transmission
- > 128-byte FIFO and on-chip H/W, S/W flow control
- > Compatible with 3.3/5 V PCI and PCI-X
- > Drivers provided for Windows (2000, XP/2003/Vista/2008 x86/x64), Windows XP Embedded, Windows CE 5.0/6.0, DOS, Linux 2.4, Linux 2.6 (x86/x64), QNX 6, SCO OpenServer 5/6, UnixWare 7
- > Easy maintenance with on-board LED display and management software
- > Immune from signal interference
- > Guards against electronic degradation and chemical corrosion
- > Wide temperature model available for -40 to 85°C environments

: USB Connectivity

UPort™ 2210/2410 (page 11-23)

2 and 4-port RS-232 USB-to-serial converters



Features

- > Hi-Speed USB 2.0 for up to 480 Mbps USB transmission
- > 921.6 Kbps maximum baudrate for super fast data transmission
- > Additional I/O and IRQ not needed
- > Built-in 15 KV ESD protection for all serial ports
- > Certified drivers provided for Windows (including Vista) and Linux
- > Supports Fixed-Base COM Utility for setting the initial COM port number
- > LEDs for easy monitoring

UPort™ 2230/2430 (pages 11-25)

2 and 4-port RS-422/485 USB-to-serial converters



Features

- > Hi-Speed USB 2.0 for up to 480 Mbps USB transmission
- > 921.6 Kbps maximum baudrate for super fast data transmission
- > Additional I/O and IRQ not needed
- > Built-in 15 KV ESD protection for all serial ports
- > Certified drivers provided for Windows (including Vista) and Linux
- > Supports Fixed-Base COM Utility for setting the initial COM number
- > LEDs for easy monitoring

UPort™ 404/407 (page 11-27)

4 and 7-port industrial-grade USB hubs



Features

- > Hi-Speed USB 2.0 for up to 480 Mbps USB transmission
- > USB-IF certification
- > Dual power supply (power jack and terminal block)
- > 15 KV ESD Level 4 protection for all USB ports
- > Rugged metal housing
- > DIN-Rail and wall mountable
- > Comprehensive diagnostic LEDs
- > Choose bus power or external power (UPort™ 404)

UPort™ 204/207 (page 11-29)

4 and 7-port entry-level USB hubs



Features

- > Hi-Speed USB 2.0 for up to 480 Mbps USB transmission
- > USB-IF Certification
- > Compatible with USB 1.1 devices
- > 15 KV ESD Level 4 protection for all USB ports
- > Wall mountable
- > Comprehensive diagnostic LEDs
- > Full 500 mA of power per port
- > Choose bus power or external power (UPort™ 204 only)

Media Converters

TRC-190 Series (page 12-7)

Rackmount chassis for the N Rack System



Features

- > 19-inch chassis for rackmount use
- > 19 slots for high density applications
- > Supports hot-swap and dual power input with redundancy
- > Fan-less chassis design reduces repair time

TCF-142-RM Series (page 12-9)

RS-232/422/485 to fiber slide-in modules for the N Rack System



Features

- > Extend RS-232/422/485 transmission up to:
 - 40 km with single mode
 - 5 km with multi-mode
- > 1K or 150K ohm adjustable pull high/low resistor
- > "Ring" and "Point-to-Point" transmission supported

ICF-1150 Series (page 12-11)

Industrial serial-to-fiber converters



Features

- > RS-232, fiber, and RS-422/485 3-way communication
- > Rotary switch to change the pull high/low resistor value
- > Extend RS-232/422/485 transmission up to:
 - 40 km with single-mode
 - 5 km with multi-mode
- > 3-way Galvanic Isolation (for "I" model only)
- > -40 to 85°C wide temperature models available
- > Class I, Div. II certification (Pending)

TCF-142 Series (page 12-14)

RS-232/422/485 to optical fiber media converters



Features

- > "Ring" and "Point-to-Point" transmission
- > Extends RS-232/422/485 transmission up to:
 - 40 km with single-mode—TCF-142-S
 - 5 km with multi-mode—TCF-142-M
- > Compact size
- > Decreases signal interference
- > Protects against electrical interference and chemical corrosion
- > Supports baudrates of 50 bps to 921.6 Kbps
- > Wide temperature models available (-40 to 75°C)

TCF-90 Series (page 12-17)

Port-powered RS-232 to optical fiber media converters



Features

- > Use either external power or power over serial
- > Extends RS-232 transmission up to:
 - 40 km with single-mode—TCF-90-S
 - 5 km with multi-mode—TCF-90-M
- > Reduces signal interference
- > Protects against electrical interference or chemical corrosion
- > 15 KV ESD protection for serial signals
- > Baudrates up to 115.2 Kbps
- > Compact size

TCF-100/100I Series (page 12-19)

Industrial RS-232 to RS-422/485 converters with optional 2 KV isolation



Features

- > RS-232 to RS-422 conversion with RTS/CTS support
- > RS-232 to 2-wire or 4-wire RS-485 conversion
- > 2 KV isolation protection (TCC-100I)
- > Wall and DIN-rail mounting
- > Plug-in terminal block for easy RS-422/485 wiring
- > LED indicators for power, Tx, Rx
- > -20 to 60°C operating temperature
- > Wide temperature model available (-40 to 85°C)

: WLAN & Cellular Solutions

| AWK-4222 Series (page 13-16)

Coming Soon

Industrial IEEE 802.11a/b/g outdoor dual-RF AP/Bridge/Client



Features

- > IEEE 802.11a/b/g compliant
- > Redundant power inputs and PoE
- > Higher security with WEP/WPA/WPA2/802.11X and powerful filters
- > Turbo Roaming™ for seamless wireless connections
- > Dual-RF design for redundant wireless communication
- > Wide operating temperature range and IP67-rated metal housing for hazardous environments

| AWK-4121 Series (page 13-18)

Industrial IEEE 802.11a/b/g outdoor wireless AP/Bridge/Client



Features

- > IEEE 802.11a/b/g compliant
- > Redundant power inputs and PoE
- > Higher security with WEP/WPA/WPA2/802.11X and powerful filters
- > Turbo Roaming™ for seamless wireless connections
- > Long-distance communication support
- > Wide operating temperature range and IP67-rated metal housing for hazardous environments

| AWK-3222 Series (page 13-20)

Coming Soon

Industrial IEEE 802.11a/b/g dual-RF AP/Bridge/Client



Features

- > IEEE 802.11a/b/g compliant
- > Redundant power inputs and PoE
- > Higher security with WEP/WPA/WPA2/802.11X and powerful filters
- > Turbo Roaming™ for seamless wireless connections
- > Dual-RF design for redundant wireless communication

| AWK-3121 Series (page 13-22)

Industrial IEEE 802.11a/b/g wireless AP/Bridge/Client



Features

- > IEEE 802.11a/b/g compliant
- > Power input by redundant 24 VDC power inputs or Power-over-Ethernet
- > Powerful security with WPA/WPA2/802.11X filters
- > Turbo Roaming™ for seamless wireless connection
- > Long-distance communication support
- > STP/RSTP support to increase reliability
- > DIN-Rail or wall mounting ability
- > IP30 protected high-strength metal housing
- > -40 to 75°C operating temperature range (T models)

| OnCell 5004/5104-HSDPA (page 13-34)

Coming Soon

Industrial tri-band UMTS/HSDPA high speed cellular routers



Features

- > Universal tri-band UMTS/HSDPA 850/900/2100 MHz
- > Industrial primary and backup wireless WAN connectivity
- > Connect up to 4 10/100BaseT(X) devices
- > Redundant DC power inputs
- > 2 digital inputs and 1 relay output (OnCell 5104-HSDPA only)

| OnCell 5004/5104 (page 13-36)

Coming Soon

Industrial quad-band GSM/GPRS cellular routers



Features

- > Universal quad-band GSM/GPRS 850/900/1800/1900 MHz
- > Industrial primary and backup wireless WAN connectivity
- > Connect up to 4 10/100BaseT(X) devices
- > Redundant DC power inputs
- > 2 digital inputs and 1 relay output (OnCell 5104 only)

| OnCell G3110/3150-HSDPA (page 13-38)

Industrial tri-band UMTS/HSDPA IP gateways



Features

- > Universal tri-band UMTS/HSDPA 850/900/2100 MHz
- > Bring 10/100Base-T and serial devices together
- > Choice of operation modes, including TCP Server, TCP Client, UDP, Real COM, Reverse Real COM, and RFC2217
- > Secure modes for TCP Server, TCP Client, Real COM, and Reverse Real COM
- > Redundant DC power inputs
- > Two digital inputs and 1 relay output
- > Centralize private IP management software
- > DIN-Rail mounting

| OnCell G3110/3150 (page 13-40)

Industrial quad-band GSM/GPRS/EDGE IP gateways



Features

- > Connect both Ethernet and serial devices to cellular networks
- > Universal quad-band GSM/GPRS/EDGE-850/900/1800/1900 MHz
- > Choice of operation modes, including TCP Server, TCP Client, UDP, Real COM, and RFC2217
- > Secure modes for TCP Server, TCP Client, and Real COM
- > Redundant DC power input
- > 2 digital inputs and 1 relay output
- > Centralize private IP management software
- > DIN-Rail mounting

2

New Product Showcase

OnCell G3111/3151/3211/3251 (page 13-42) Coming Soon

1 and 2-port RS-232 or RS-232/422/485 cellular IP modems



Features

- > Universal quad-band GSM/GPRS 850/900/1800/1900 MHz
- > Choice of operation modes, including TCP Server, TCP Client, UDP, Real COM, and Reverse Real COM
- > Management software: private IP management with OnCell Central
- > Choice of configuration methods, including web console, serial console, and Telnet
- > Desktop or DIN-Rail installation

NPort® W2150/2250 Plus (page 13-26)

1 and 2-port RS-232/422/485 IEEE 802.11a/b/g wireless device servers



Features

- > Link any serial device to an IEEE 802.11a/b/g network
- > 921.6 Kbps baudrate for RS-232/422/485 transmissions
- > Web-based configuration using built-in Ethernet or WLAN
- > Enhanced remote configuration with HTTPS, SSH
- > Secure data access with WEP, WPA, WPA2
- > Built-in WLAN site survey tool
- > Wireless roaming with user-defined signal strength threshold
- > Off-line port buffering and serial data log
- > Dual power inputs (1 power jack, 1 terminal block)

Embedded Computers for Communication

V462 Series (page 15-8)

x86-based computers with 4 serial ports, dual LANs, VGA, CompactFlash, PCMCIA, USB



Features

- > AMD Geode LX 800@0.9W CPU, 500 MHz
- > Built-in 256 MB (CE) or 512 MB (XPe) DDR SDRAM
- > Built-in 256 MB (CE) or 1 GB (XPe) industrial DOM to store the operating system
- > 256 KB of SRAM with battery backup
- > Dual 10/100 Mbps Ethernet ports for network redundancy
- > 4 USB 2.0 hosts supporting system boot up
- > LED indicators for power, battery, storage
- > Ready-to-run WinCE 6.0 or Windows XP Embedded platform
- > -40 to 75°C wide temperature model available

V464 Series (page 15-11)

x86-based computers with 4 serial ports, quad LANs, VGA, CompactFlash, USB



Features

- > AMD Geode LX 800@0.9W CPU, 500 MHz
- > Built-in 256 MB (CE) or 512 MB (XPe) DDR SDRAM
- > Built-in 256 MB (CE) or 1 GB (XPe) industrial DOM to store the operating system
- > 256 KB of SRAM with battery backup
- > Quad 10/100 Mbps Ethernet ports for network redundancy
- > LED indicators for power, battery, storage
- > Ready-to-run WinCE 6.0 or Windows XP Embedded platform
- > -40 to 75°C wide temperature model available

V466 Series (page 15-14)

x86-based computers with 4 serial ports, quad LANs, VGA, CompactFlash, built-in 8-port Ethernet switch, USB



Features

- > AMD Geode LX 800@0.9W CPU, 500 MHz
- > Built-in 256 MB (CE) or 512 MB (XPe) DDR SDRAM
- > Built-in 256 MB (CE) or 1 GB (XPe) industrial DOM to store the operating system
- > 256 KB battery backup SRAM
- > Quad 10/100 Mbps Ethernet ports for network redundancy
- > Built-in 8-port Ethernet switch for connecting network devices
- > 4 USB 2.0 hosts supporting system boot up
- > LED indicators for power, battery, storage
- > Ready-to-run WinCE 6.0 or Windows XP Embedded platform
- > Robust, fan-less design
- > -40 to 75°C wide temperature model available

V468 Series (page 15-17)

x86-based computers with 4 serial ports, quad LANs, VGA, 8 Dis, 8 DOs, CompactFlash, USB



Features

- > AMD Geode LX 800@0.9W CPU, 500 MHz
- > Built-in 256 MB (CE) or 512 MB (XPe) DDR SDRAM
- > Built-in 256 MB (CE) or 1 GB (XPe) industrial DOM to store the operating system
- > 256 KB battery backup SRAM
- > Quad 10/100 Mbps Ethernet ports for network redundancy
- > 8 DI and 8 DO interfaces for digital input/output connections, with 3 KV isolation protection
- > 4 USB 2.0 hosts supporting system boot up
- > LED indicators for power, battery, storage
- > Ready-to-run WinCE 6.0 or Windows XP Embedded platform
- > -40 to 75°C wide temperature model available

UC-8410 Series (page 15-23)

RISC-based industrial embedded computers with 8 serial ports, 3 LANs, DIO, 2 CAN ports, CompactFlash, USB



Features

- > Intel XScale IXP435 533 MHz processor
- > 256 MB DDR2 SDRAM and 16 MB Flash ROM onboard
- > 32 MB NAND Flash for data storage
- > 8 RS-232/422/485 serial ports
- > 4 digital input and 4 digital output channels
- > 3 10/100 Mbps Ethernet ports
- > 2 USB 2.0 hosts for mass storage devices
- > Ready-to-run Linux platform
- > Robust, fanless design
- > Wide temperature model available

UC-8416 Series (page 15-26)

RISC-based industrial embedded computers with 8 serial ports, 3 LANs, DIO, 8 built-in Ethernet switch ports, CompactFlash, USB



Features

- > Intel XScale IXP435 533 MHz processor
- > 256 MB DDR2 SDRAM and 16 MB Flash ROM onboard
- > 32 MB NAND Flash for data storage
- > 8 RS-232/422/485 serial ports
- > 8 Ethernet switch ports
- > 4 digital input and 4 digital output channels
- > 3 10/100 Mbps Ethernet ports
- > 2 USB 2.0 hosts for mass storage devices
- > Ready-to-run Linux platform
- > -40 to 75°C wide temperature model available

UC-8418 Series (page 15-29)

RISC-based industrial embedded computers with 8 serial ports, 3 LANs, DIO, 2 CAN ports, CompactFlash, USB



Features

- > Intel XScale IXP435 533 MHz processor
- > 256 MB DDR2 SDRAM and 16 MB Flash ROM onboard
- > 32 MB NAND Flash for data storage
- > 8 RS-232/422/485 serial ports
- > 2 CANbus ports
- > 12 digital input and 12 digital output channels
- > 3 10/100 Mbps Ethernet ports
- > 2 USB 2.0 hosts for mass storage devices
- > Ready-to-run Linux platform
- > Robust, fanless design
- > -40 to 75°C wide temperature model available

DA-681 Series (page 15-49)

x86-based rackmount embedded computer with 4 isolated RS-232 and 8 isolated RS-485 ports, 6 LANs, VGA, CompactFlash, USB



Features

- > Intel Celeron M 1 GHz processor with 400 MHz FSB
- > 1 x 200-pin DDR2 SODIMM socket, supporting DDR2 400 up to 1 GB
- > 6 10/100 Mbps Ethernet ports
- > 1 CompactFlash socket, 1 IDE and serial ATA-150 connectors for storage expansion
- > USB 2.0 ports for high speed peripherals
- > Serial port speed from 50 to 921.6 Kbps, supporting nonstandard baudrates
- > Embedded Linux, WinCE 6.0, or WinXPe platform
- > 19-inch rackmount model, 1U high
- > Dual 100/240 VAC/VDC power input (DP/PP version)
- > Fanless Design

DA-682 Series (page 15-52)

x86-based rackmount computers with VGA, 4 Gigabit Ethernet ports, 2 peripheral expansion slots, CompactFlash, USB



Features

- > Intel Celeron M 1 GHz processor with 400 MHz FSB
- > Built-in DDR2 SDRAM and industrial flash disk module
- > Quad Gigabit Ethernet ports for network redundancy
- > Software selectable RS-232/422/485 with 2 KV isolation protection
- > PCI expansion slots for inserting expansion modules
- > 1 CompactFlash socket for storage expansion
- > USB 2.0 ports for high speed peripherals, supporting system bootup
- > 19-inch rackmount, 2U high form factor
- > 100/240 VAC/VDC power inputs
- > Ready-to-Run Linux, WinCE 6.0, or Windows XP Embedded platform
- > Fanless design

Embedded Computers for Automation

IA260 Series (page 16-3)

RISC-based computers with 4 serial ports, dual LANs, VGA, DIO, CompactFlash, USB



Features

- > Cirrus Logic EP9315 ARM9 CPU, 200 MHz
- > 128 MB RAM on-board, 32 MB flash disk
- > 4 software-selectable RS-232/422/485 serial ports
- > VGA interface for field site monitoring
- > Dual 10/100 Mbps Ethernet for network redundancy
- > 8+8 DI/DO channels, up to 30 VDC12 to 48 VDC power input design
- > Supports CompactFlash and USB 2.0 hosts
- > Ready-to-run Linux or WinCE 6.0 platform
- > H-type heat dissipation design for system reliability
- > -40 to 75°C wide operating temperature model available

IA-261-I/262-I Series (page 16-6)

RISC-based computers with 2 or 4 digitally isolated serial ports, dual LANs, VGA, CAN, DIO, CompactFlash, USB



Features

- > Cirrus Logic EP9315 ARM9 CPU, 200 MHz
- > 128 MB RAM on-board, 32 MB flash disk
- > VGA interface for field site monitoring
- > 2 KV digitally isolated RS-232/422/485 serial ports
- > Dual 10/100 Mbps Ethernet for network redundancy
- > Dual 2 KV digitally isolated CAN ports with CANopen protocol support
- > 8+8 DI/DO with 3 KV optical isolation protection
- > 12 to 48 VDC redundant power input design
- > Supports CompactFlash and USB 2.0 hosts
- > Ready-to-run Linux or WinCE 6.0 platform
- > -40 to 75°C wide temperature models available

Product Selection Guides

Industrial Ethernet Switches	
Managed Ethernet Switches	20
Unmanaged Ethernet Switches	22
Industry-specific Ethernet Switches	
M12 Ethernet Switches	24
IEC 61850-3 Rackmount Ethernet Switches	25
Industrial I/O	
Stand-alone Type I/Os	26
Modular Type I/Os	26
Modular Remote I/O Selection Guide	27
Video Networking Solutions	
Video Networking Products	28
Terminal Servers	
NPort® 6000 Terminal Servers	29
CN2600 Terminal Servers	31
Serial Device Servers	
Combo Switch / Serial Device Server	33
General-purpose Device Servers	34
Industrial-grade Device Servers	38
Embedded Device Servers	39
Ethernet Fieldbus Gateways	
Ethernet Fieldbus Gateways	40
Multiport Serial Boards	
PCI Express Serial Boards	42
Universal PCI Serial Boards	43
Fiber Optic Serial Boards	45
ISA Serial Boards	46
PC/104 Modules	48
PC/104-Plus Modules	49
Industrial USB	
USB-to-Serial Converters	50
USB Hubs	52
Media Converters	
Chassis Media Converters	53
Serial-to-Fiber Media Converters	54
Serial Converters and Repeaters	55
Ethernet-to-Fiber Media Converters	56
WLAN & Cellular Solutions	
Industrial AP/Bridge/Client Solutions	57
Wireless Serial Device Servers	58
Cellular Routers and IP Gateways	59
Cellular IP and GSM/GPRS Modems	60
Embedded Computers for Communication	
Wallmount Computers	61
Rackmount Computers	64
Module/Board Computers	66
Embedded Computers for Automation	
DIN-Rail Computers	67
Wireless Embedded Computers	
RISC-based WLAN Computers	68
Cellular Computers	69

3

Product Selection Guides



Managed Ethernet Switches

	Managed Rackmount Switches				Managed DIN-Rail Switches			
--	----------------------------	--	--	--	---------------------------	--	--	--



	IKS-6726	IKS-6726-PoE	EDS-828	EDS-728	EDS-608	EDS-G509	EDS-518A	EDS-510A
Supported Modules								
Gigabit Ethernet Modules	√	√	√	√	---	---	---	---
Fast Ethernet Modules	√	√	√	√	√	---	---	---
SFP Gigabit Ethernet Modules	√	√	√	√	---	√	√	√
SFP Fast Ethernet Modules	√	√	---	---	---	√	---	---
Number of Ports								
Max. Number of Ports	26	26	28	28	8	9	18	10
Gigabit Ethernet, 10/100/1000 Mbps	up to 2	up to 2	up to 4	up to 4	---	9	2	3
Fast Ethernet, 10/100 Mbps	up to 24	up to 24	up to 24	up to 24	8	---	16	7
Available Power Supplies								
3.3 VDC	---	---	---	---	---	---	---	---
24 VDC	√	√	√	√	---	---	√	√
24 VAC	---	---	---	---	---	---	---	---
48 VDC	√	√	---	---	---	---	---	---
12/24/48 VDC	---	---	---	---	√	√	---	---
88-300 VDC or 85-264 VAC, isolated	√	√	---	---	---	---	---	---
Installation Options								
DIN-Rail Mounting	---	---	√	√	√	√	√	√
Panel Mounting	---	---	w/ optional kit	w/ optional kit	w/ optional kit	w/ optional kit	w/ optional kit	w/ optional kit
Rack Mounting	√	√	w/ optional kit	w/ optional kit	w/ optional kit	w/ optional kit	w/ optional kit	w/ optional kit
Supported Operating Temperatures								
0 to 60°C	---	---	√	√	√	√	√	√
-10 to 60°C	---	---	---	---	---	---	---	---
-40 to 75°C	√	√	---	---	√	√	√	√
Redundancy and Backup Options								
Turbo Ring (Recovery Time < 20 ms)	√	√	√	√	√	√	√	√
STP/RSTP	√	√	√	√	√	√	√	√
Automatic Backup Configurator (ABC-01)	√	√	√	√	√	√	√	√
Network Management and Control								
Layer 3 Switching	---	---	√	---	---	---	---	---
IPv6	√	√	---	√	√	√	√	√
DHCP Option 66/67/82	√	√	√	√	√	√	√	√
IEEE 1588 PTP	√	√	√	√	√	√	√	√
LLDP	√	√	√	√	√	√	√	√
Modbus/TCP	√	√	√	√	√	√	√	√
IGMP/GMRP	√	√	√	√	√	√	√	√
Port Trunking	√	√	√	√	√	√	√	√
IEEE 802.1X	√	√	√	√	√	√	√	√
Port Lock	√	√	√	√	√	√	√	√
SNMP/RMON	√	√	√	√	√	√	√	√
VLAN	√	√	√	√	√	√	√	√
QoS	√	√	√	√	√	√	√	√
Relay Warning	√	√	√	√	√	√	√	√
Regulatory Approvals								
CE/FCC	√	√	√	√	√	√	√	√
UL/cUL 60950-1	Pending	Pending	Pending	Pending	---	---	√	√
UL508	---	---	Pending	Pending	Pending	Pending	√	√
UL/cUL Class 1, Div. 2; ATEX Class I, Zone 2	---	---	Pending	Pending	Pending	Pending	Pending	√
DNV/GL	Pending	Pending	Pending	Pending	Pending	Pending	√	√
NEMA TS2	√	√	---	---	---	---	---	---
EN50155/EN50121-4	√	√	---	---	---	---	---	---

3

Industrial Ethernet Switches > Managed Ethernet Switches

Managed Ethernet Switches

Managed DIN-Rail Switches



	EDS-505A	EDS-508A	EDS-516A	EDS-405A	EDS-408A	EDS-P510	EOM-104
Supported Modules							
Gigabit Ethernet Modules	---	---	---	---	---	---	---
Fast Ethernet Modules	---	---	---	---	---	---	---
SFP Gigabit Ethernet Modules	---	---	---	---	---	√	---
SFP Fast Ethernet Modules	---	---	---	---	---	√	---
Number of Ports							
Max. Number of Ports	5	8	16	5	8	10	4
Gigabit Ethernet, 10/100/1000 Mbps	---	---	---	---	---	3	---
Fast Ethernet, 10/100 Mbps	5	8	16	5	8	7 (4 PoE)	4
Available Power Supplies							
3.3 VDC	---	---	---	---	---	---	√
24 VDC	√	√	√	√	√	---	---
24 VAC	---	---	---	---	---	---	---
48 VDC	---	---	---	---	---	√	---
12/24/48 VDC	---	---	---	---	---	---	---
88-300 VDC or 85-264 VAC, isolated	---	---	---	---	---	---	---
Installation Options							
DIN-Rail Mounting	√	√	√	√	√	√	---
Panel Mounting	w/ optional kit	w/ optional kit	w/ optional kit	w/ optional kit	w/ optional kit	w/ optional kit	---
Rack Mounting	w/ optional kit	w/ optional kit	w/ optional kit	w/ optional kit	w/ optional kit	w/ optional kit	---
Supported Operating Temperatures							
0 to 60°C	√	√	√	√	√	√	---
-10 to 60°C	---	---	---	---	---	---	---
-40 to 75°C	√	√	√	√	√	√	√
Redundancy and Backup Options							
Turbo Ring (Recovery Time < 20 ms)	√	√	√	√	√	√	√
STP/RSTP	√	√	√	√	√	√	√
Automatic Backup Configurator (ABC-01)	√	√	√	√	√	√	---
Network Management and Control							
Layer 3 Switching	---	---	---	---	---	---	---
IPv6	√	√	√	√	√	√	---
DHCP Option 66/67/82	√	√	√	√	√	√	---
IEEE 1588 PTP	√	√	√	---	---	√	---
LLDP	√	√	√	√	√	√	---
Modbus/TCP	√	√	√	√	√	√	---
IGMP/GMRP	√	√	√	---	---	√	---
Port Trunking	√	√	√	---	---	√	---
IEEE 802.1X	√	√	√	---	---	√	---
Port Lock	√	√	√	---	---	√	---
SNMP/RMON	√	√	√	√	√	√	√
VLAN	√	√	√	√	√	√	---
QoS	√	√	√	√	√	√	---
Relay Warning	√	√	√	√	√	√	---
Regulatory Approvals							
CE/FCC	√	√	√	√	√	√	√
UL/cUL 60950-1	√	√	√	√	√	---	---
UL508	√	√	√	√	√	Pending	---
UL/cUL Class I, Div. 2; ATEX Class I, Zone 2	√	√	Pending	√	√	Pending	---
DNV/GL	√	√	√	√	√	Pending	---
NEMA TS2	---	---	---	---	---	---	---
EN50155/EN50121-4	---	---	---	---	---	---	---

Unmanaged Ethernet Switches

	Unmanaged Rackmount Switches	Unmanaged DIN-Rail Switches					
--	------------------------------	-----------------------------	--	--	--	--	--



	IKS-6324	EDS-G205	EDS-G308	EDS-305	EDS-308	EDS-309	EDS-316
Supported Modules							
Gigabit Ethernet Modules	√	---	---	---	---	---	---
Fast Ethernet Modules	√	---	---	---	---	---	---
SFP Gigabit Ethernet Modules	√	---	√	---	---	---	---
SFP Fast Ethernet Modules	---	---	√	---	---	---	---
Number of Ports							
Max. Number of Ports	24	5	8	5	8	9	16
Gigabit Ethernet, 10/100/1000 Mbps	Up to 2	5	8	---	---	---	---
Fast Ethernet, 10/100 Mbps	Up to 24	---	---	5	8	9	16
Available Power Supplies							
24 VDC	---	---	---	√	√	√	√
24 VAC	---	---	---	---	---	---	---
48 VDC	---	---	---	---	---	---	---
12/24/48 VDC	√	√	√	---	---	---	---
88-300 VDC or 85-264 VAC, isolated	√	---	---	---	---	---	---
Installation Options							
DIN-Rail Mounting	---	√	√	√	√	√	√
Panel Mounting	---	w/ optional kit	w/ optional kit	w/ optional kit	w/ optional kit	w/ optional kit	w/ optional kit
Rack Mounting	√	w/ optional kit	w/ optional kit	w/ optional kit	w/ optional kit	w/ optional kit	w/ optional kit
Supported Operating Temperatures							
0 to 60°C	---	√	√	√	√	√	√
-10 to 60°C	---	---	---	---	---	---	---
-40 to 75°C	√	√	√	√	√	√	√
Regulatory Approvals							
CE/FCC	√	√	√	√	√	√	√
UL/cUL 60950-1	Pending	---	---	√	√	√	√
UL508	---	Pending	Pending	√	√	√	√
UL/cUL Class 1, Div. 2; ATEX Class 1, Zone 2	---	Pending	Pending	√	√	√	Pending
DNV/GL	Pending	Pending	Pending	√	√	√	√
NEMA TS2	√	---	---	---	---	---	---
EN50155/EN50121-4	√	---	---	---	---	---	---

3

Industrial Ethernet Switches > Unmanaged Ethernet Switches

Unmanaged Ethernet Switches

Unmanaged DIN-Rail Switches



	EDS-205A	EDS-208A	EDS-205	EDS-208	EDS-P308
Supported Modules					
Gigabit Ethernet Modules	---	---	---	---	---
Fast Ethernet Modules	---	---	---	---	---
SFP Gigabit Ethernet Modules	---	---	---	---	---
SFP Fast Ethernet Modules	---	---	---	---	---
Number of Ports					
Max. Number of Ports	5	8	5	8	8
Gigabit Ethernet, 10/100/1000 Mbps	---	---	---	---	---
Fast Ethernet, 10/100 Mbps	5	8	5	8	8 (4 PoE)
Available Power Supplies					
24 VDC	---	---	√	√	---
24 VAC	√	√	√	√	---
48 VDC	---	---	---	---	√
12/24/48 VDC	√	√	---	---	---
88-300 VDC or 85-264 VAC, isolated	---	---	---	---	---
Installation Options					
DIN-Rail Mounting	√	√	√	√	√
Panel Mounting	w/ optional kit	w/ optional kit	---	---	w/ optional kit
Rack Mounting	w/ optional kit	w/ optional kit	w/ optional kit	w/ optional kit	w/ optional kit
Supported Operating Temperatures					
0 to 60°C	---	---	---	---	√
-10 to 60°C	√	√	√	√	---
-40 to 75°C	√	√	---	---	√
Regulatory Approvals					
CE/FCC	√	√	√	√	√
UL/cUL 60950-1	---	---	---	√	---
UL508	√	√	√	√	√
UL/cUL Class I, Div. 2; ATEX Class I, Zone 2	Pending	Pending	---	---	Pending
DNV/GL	Pending	Pending	---	---	Pending
NEMA TS2	---	---	---	---	---
EN50155/EN50121-4	---	---	---	---	---

M12 Ethernet Switches



	TN-5508 Series	TN-5510 Series	TN-5516 Series	TN-5518 Series	TN-5308 Series	TN-5308-PoE Series	EDS-305-M12 Series
Number of Ports							
Max. Number of Ports	8	10	16	18	8	8	5
Gigabit Ethernet, 10/100/1000 Mbps	---	2	---	2	---	---	---
Fast Ethernet, 10/100 Mbps	8	8	16	16	8	8 (4 PoE)	5
Power Supply							
12/24/36/48 VDC	√	√	√	√	√ (LV Model)	---	---
72/96/110 VDC	√	√	√	√	√ (MV Model)	---	---
80-300 VDC, 85-264 VAC	√	√	√	√	---	---	---
24 VDC	---	---	---	---	---	---	√
48 VDC	---	---	---	---	---	√	---
24 VAC	---	---	---	---	---	---	√
Installation Options							
DIN-Rail Mounting	w/ optional kit	w/ optional kit	w/ optional kit	w/ optional kit	w/ optional kit	w/ optional kit	w/ optional kit
Panel Mounting	√	√	√	√	√	√	√
Operating Temperature							
0 to 60°C	√	√	√	√	√	√	√
-40 to 75°C	√	√	√	√	√	√	√
Redundancy and Backup Options							
Turbo Ring (Recovery Time < 20 ms)	√	√	√	√	---	---	---
STP/RSTP	√	√	√	√	---	---	---
Network Management and Control							
IPv6	√	√	√	√	---	---	---
DHCP Option 66/67/82	√	√	√	√	---	---	---
IEEE 1588 PTP	√	√	√	√	---	---	---
LLDP	√	√	√	√	---	---	---
Modbus/TCP	√	√	√	√	---	---	---
IGMP/GMRP	√	√	√	√	---	---	---
Port Trunking	√	√	√	√	---	---	---
IEEE 802.1X	√	√	√	√	---	---	---
Port Lock	√	√	√	√	---	---	---
SNMP/RMON	√	√	√	√	---	---	---
VLAN	√	√	√	√	---	---	---
QoS	√	√	√	√	---	---	---
Relay Warning	√	√	√	√	---	---	---
Regulatory Approvals							
CE/FCC	√	√	√	√	√	√	√
UL508	Pending	Pending	Pending	Pending	Pending	Pending	√
Traffic Control Systems: NEMA TS2 e1	Pending Pending	Pending Pending	Pending Pending	Pending Pending	Pending Pending	Pending Pending	---
Railway Applications: EN50155 EN50121-3-2 EN50121-4	Pending Pending Pending	Pending Pending Pending	Pending Pending Pending	Pending Pending Pending	Pending Pending Pending	Pending Pending Pending	√ Pending Pending
DNV/GL	---	---	---	---	---	---	Pending

3

Industry-specific Ethernet Switches > M12 Ethernet Switches

IEC 61850-3 Rackmount Ethernet Switches



	PT-7828	PT-7728	PT-7710	PT-7324
Supported Modules				
Gigabit Ethernet Modules	√	√	√	√
Fast Ethernet Modules	√	√	√	√
SFP Gigabit Ethernet Modules	√	√	√	√
SFP Fast Ethernet Modules	√	√	√	---
Number of Ports				
Max. Number of Ports	28	28	10	24
Gigabit Ethernet, 10/100/1000 Mbps	Up to 4	Up to 4	Up to 2	Up to 2
Fast Ethernet, 10/100 Mbps	Up to 24	Up to 24	Up to 10	Up to 24
Power Supply				
24 VDC, isolated	√	√	---	---
48 VDC, isolated	√	√	---	---
12/24/48 VDC	---	---	√	√
88-300 VDC or 85-264 VAC, isolated	√	√	√	√
Installation Options				
Rack Mounting	√	√	√	√
Panel Mounting	---	---	√	---
Operating Temperature				
-40 to 85°C	√	√	√	√
Redundancy and Backup Options				
Turbo Ring (Recovery Time < 20 ms)	√	√	√	---
STP/RSTP	√	√	√	---
Automatic Backup Configurator (ABC-01)	√	√	√	---
Network Management and Control				
Layer 3 Switching	√	---	---	---
IPv6	---	√	√	---
DHCP Option 66/67/82	√	√	√	---
IEEE 1588 PTP	√	√	√	---
LLDP	√	√	√	---
Modbus/TCP	√	√	√	---
IGMP/GMRP	√	√	√	---
Port Trunking	√	√	√	---
IEEE 802.1X	√	√	√	---
Port Lock	√	√	√	---
SNMP/RMON	√	√	√	---
VLAN	√	√	√	√
QoS	√	√	√	√
Relay Warning	√	√	√	√
Regulatory Approvals				
CE/FCC	√	√	√	√
UL/cUL 60950-1	Pending	Pending	Pending	Pending
IEC 61850-3 (Power Substation)	√	√	√	√
IEEE 1613 (Power Substation)	√	√	√	√
NEMA TS2 (Traffic Control System)	√	√	√	√
EN50155/EN50121-4 (Railway Applications)	√	√	√	√
DNV/GL	Pending	Pending	Pending	Pending

3

Industry-specific Ethernet Switches > IEC 61850-3 Rackmount Ethernet Switches

Stand-alone Type I/Os



Model	ioLogik W5340	ioLogik E2210	ioLogik E2212	ioLogik E2214	ioLogik E2240	ioLogik E2242
Category	Cellular GPRS I/O	Active Ethernet I/O	Active Ethernet I/O	Active Ethernet I/O	Active Ethernet I/O	Active Ethernet I/O
Comm. Interface	GPRS, 10/100M Ethernet	10/100M Ethernet	10/100M Ethernet	10/100M Ethernet	10/100M Ethernet	10/100M Ethernet
I/O Combination	4 AIs, 8 DIos, 2 Relays	12 DIs, 8 DOs	8 DIs, 8 DOs, 4 DIOs	6 DIs, 6 Relays	8 AIs, 2 AOs	4 AIs, 12 DIOs
Control Protocol	Modbus/TCP, SNMP, OPC	Modbus/TCP, SNMP, OPC, Http-CGI	Modbus/TCP, SNMP, OPC, Http-CGI	Modbus/TCP, SNMP, OPC, Http-CGI	Modbus/TCP, SNMP, OPC, Http-CGI	Modbus/TCP, SNMP, OPC, Http-CGI
Local Intelligence	Click&Go	Click&Go	Click&Go	Click&Go	Click&Go	Click&Go
Alarm Function	SMS, E-mail, SNMP Traps, TCP/UDP Messaging	E-mail, SNMP Traps, TCP/UDP Messaging	E-mail, SNMP Traps, TCP/UDP Messaging	E-mail, SNMP Traps, TCP/UDP Messaging	E-mail, SNMP Traps, TCP/UDP Messaging	E-mail, SNMP Traps, TCP/UDP Messaging



Model	ioLogik E2260	ioLogik E2262	ioLogik R2110	ioLogik R2140	ioMirror E3210
Category	Active Ethernet I/O	Active Ethernet I/O	RS-485 I/O	RS-485 I/O	Peer-to-Peer I/O
Comm. Interface	10/100M Ethernet	10/100M Ethernet	RS-485	RS-485	10/100M Ethernet
I/O Combination	4 DOs, 6 RTDs	4 DOs, 8 TCs	12 DIs, 8 DOs	8 AIs, 2 AOs	8 DIs, 8 DOs
Control Protocol	Modbus/TCP, SNMP, OPC, Http-CGI	Modbus/TCP, SNMP, OPC, Http-CGI	Modbus/RTU	Modbus/RTU	---
Local Intelligence	Click&Go	Click&Go	---	---	---
Alarm Function	E-mail, SNMP Traps, TCP/UDP Messaging	E-mail, SNMP Traps, TCP/UDP Messaging	---	---	Alarm Channel with LED for Conn. Status

Modular Type I/Os



Model	ioLogik E4200	NA-4010	NA-4020	NA-4021
Category	Modular Active Ethernet I/O	Modular Ethernet I/O	Modular Serial I/O	Modular Serial I/O
Comm. Interface	Dual 10/100M Ethernet	10/100M Ethernet	RS-485	RS-232
Max. Expansion Capacity	16 slices	31 slices	31 slices	31 slices
Control Protocol	Modbus/TCP, SNMP, OPC	Modbus/TCP	Modbus/RTU	Modbus/RTU
Local Intelligence	Click&Go	---	---	---
Alarm Function	SMS, E-mail, SNMP Traps, TCP/UDP Messaging	---	---	---
SMS/GPRS Connectivity	Yes, with an ext. modem	---	---	---

3

Industrial I/O > Stand-alone Type I/Os & Modular Type I/Os

Modular Remote I/O Selection Guide



		DC-Digital Inputs				AC-Digital Inputs	
Specs	Model	M-1800	M-1801	M-1600	M-1601	M-1450	M-1451
	Channels	8	8	16	16	4	4
	Sink/Source	Sink	Source	Sink	Source	---	---
	Connector	RTB	RTB	20-pin	20-pin	RTB	RTB
	Voltage	24 VDC	24 VDC	24 VDC	24 VDC	110 VAC	220 VAC
	Isolation	Optical isolation					



		Digital Outputs				
Specs	Model	M-2800	M-2801	M-2600	M-2601	M-2450
	Channels	8	8	16	16	4
	Sink/Source	Sink	Source	Sink	Source	Relay
	Connector	RTB	RTB	20-pin	20-pin	RTB
	Voltage	24 VDC	24 VDC	24 VDC	24 VDC	24 VDC
	Current	0.5 A	0.5 A	0.3 A	0.3A	0.5 A
	Isolation	Optical isolation				



		Analog Inputs			
Specs	Model	M-3802	M-3810	M-6200	M-6201
	Channels	8	8	2	2
	Current	4 to 20 mA	---	---	---
	Voltage	---	0 to 10V	---	---
	Connector	RTB	RTB	RTB	RTB
	Resolution	12-bit	12-bit	---	---
	Isolation	Optical isolation			
	Sensor Input	---	---	RTD(ohm)	Thermo-couple (mV)



		Analog Outputs	
Specs	Model	M-4402	M-4410
	Channels	4	4
	Current	4 to 20 mA	---
	Voltage	---	0 to 10 V
	Connector	RTB	RTB
	Resolution	12-bit	12-bit
	Isolation	Optical isolation	

		Power Modules			
Specs	Model	M-7001	M-7002	M-7804	M-7805
	Channels	0	0	8	8
	Voltage	24 VDC	DC: 5, 24, 48 VDC AC: 110/220 VAC	0 VDC	24 VDC
	Purpose	System Power	Field Power	Field Power	Field Power

Video Networking Products

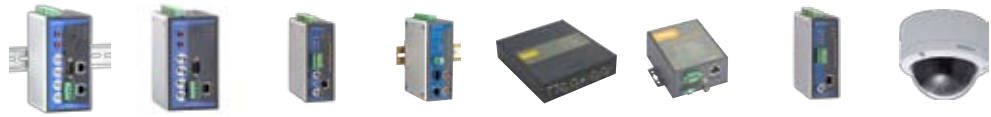

	VPort 354	VPort 254	VPort 351	VPort 3310	VPort 2141	VPort 251	VPort D351	VPort 25
Type of Product	Encoder	Encoder	Encoder	Encoder	Encoder	Encoder	Decoder	IP Camera
Form Factor								
Protection Rating	IP30	IP30	IP30	IP30	---	---	IP30	IP66
DIN-Rail Mounting	√	√	√	√	w/ optional Kit	w/ optional Kit	√	---
Panel Mounting	w/ optional Kit	w/ optional Kit	w/ optional Kit	w/ optional Kit	√	√	w/ optional Kit	---
Surface/Ceiling Mounting	---	---	---	---	---	---	---	√
Audio/Video Channels								
Video Inputs	4	4	1	1	4	1	0	0
Video Outputs	0	0	1	1	0	0	1	1
Audio Inputs	1	1	1	1	0	1	1	1
Audio Outputs	1	1	1	0	0	1	1	1
Compression Algorithm								
MJPEG	√	√	√	---	√	√	√	√
MPEG4	√	√	√	√	---	√	√	√
Video Performance								
QCIF (NTSC: 176 x 120)	30 FPS (max.)	---	---	30 FPS (max.)	30 FPS (max.)	---	---	---
QVGA (NTSC: 320 x 240)	---	30 FPS (max.)	30 FPS (max.)	---	---	30 FPS (max.)	---	30 FPS (max.)
CIF (NTSC: 352 x 240)	30 FPS (max.)	30 FPS (max.)	30 FPS (max.)	30 FPS (max.)	30 FPS (max.)	30 FPS (max.)	---	30 FPS (max.)
VGA (NTSC: 640 x 480)	---	7 FPS (max.)	30 FPS (max.)	10 FPS (max.)	---	30 FPS (max.)	---	30 FPS (max.)
2CIF (NTSC: 704 x 240)	30 FPS (max.)	---	---	---	---	---	---	---
4CIF (NTSC: 704 x 480)	30 FPS (max.)	7 FPS (max.)	30 FPS (max.)	10 FPS (max.)	30 FPS (max.)	30 FPS (max.)	---	30 FPS (max.)
Full D1 (NTSC: 720 x 480)	---	7 FPS (max.)	30 FPS (max.)	---	---	30 FPS (max.)	---	30 FPS (max.)
QCIF (PAL: 176 x 144)	25 FPS (max.)	---	---	25 FPS (max.)	25 FPS (max.)	---	---	---
QVGA (PAL: 320 x 288)	---	25 FPS (max.)	25 FPS (max.)	---	---	25 FPS (max.)	---	25 FPS (max.)
CIF (PAL: 352 x 288)	25 FPS (max.)	25 FPS (max.)	25 FPS (max.)	25 FPS (max.)	25 FPS (max.)	25 FPS (max.)	---	25 FPS (max.)
VGA (PAL: 640 x 576)	---	7 FPS (max.)	25 FPS (max.)	8 FPS (max.)	---	25 FPS (max.)	---	25 FPS (max.)
2CIF (PAL: 704 x 288)	25 FPS (max.)	---	---	---	---	---	---	---
4CIF (PAL: 704 x 576)	25 FPS (max.)	7 FPS (max.)	25 FPS (max.)	8 FPS (max.)	8 FPS (max.)	25 FPS (max.)	---	25 FPS (max.)
Full D1 (PAL: 720 x 576)	---	7 FPS (max.)	25 FPS (max.)	---	---	25 FPS (max.)	---	25 FPS (max.)
Quad View	---	---	---	---	15 FPS (max.)	---	---	---
Network Connections								
10/100BaseT(X) Ports	2	1	1	1	1	1	1	1
100BaseFX Ports	2	1	1	---	---	---	---	---
Number of COM Ports								
PTZ Ports	1	1	1	1	2	1	1	---
RS-232 Console Ports	1	1	1	---	---	1	1	---
Network Management and Control								
Web Browser	√	√	√	√	√	√	√	√
SNMP Protocols	v1/v2c/v3	v1/v2c/v3	v1/v2c/v3	v1/v2c/v3	---	v1/v2c/v3	v1/v2c/v3	v1/v2c/v3
RTSP (Real Time Streaming Protocol)	√	√	√	√	---	√	---	√
Multicast (IGMP)	v3	v3	v3	v3	---	v3	---	v3
QoS	√	√	√	---	---	√	---	√
UPnP	√	√	√	√	√	√	√	√
DDNS	√	√	√	√	√	√	√	√
PPPoE	---	---	---	√	√	---	---	---
IP Filtering	√	√	√	√	√	√	√	√
Power Requirements								
Power Redundancy	√	√	√	√	---	---	√	√
Power Inputs	2	2	2	2	1	1	2	1
Power Outputs	0	0	0	0	1	1	0	0
Power-over-Ethernet (PoE)	---	---	---	---	---	---	---	√
Alarms								
VMD (Video Motion Detection)	√	√	√	√	√	√	---	√
Digital Inputs	4	4	2	2	4	1	2	1
Relay (Digital) Outputs	2	2	2	2	4	1	2	1
Alarm Video Recording	√	---	√	---	---	---	---	---
Alarm Snapshot Image	√	√	√	√	√	√	---	√
Supported Operating Temperature Ranges								
0 to 60°C	√	√	√	√	√	√	√	---
-40 to 50°C	---	---	---	---	---	---	---	√
-40 to 75°C	√	√	√	√	---	---	---	---
Regulatory Approvals								
CE/FCC	√	√	√	√	√	√	√	√
UL508	Pending	√	√	---	---	---	√	Pending
Class 1, Div 2; ATEX Class 1, Zone 2	Pending	Pending	√	---	---	---	---	---

3

Video Networking Solutions > Video Networking Products

NPort® 6000 Terminal Servers



	NPort® 6150	NPort® 6250	NPort® 6250-M-SC	NPort® 6250-S-SC	NPort® 6450	NPort® 6610-8	NPort® 6610-8-48V	NPort® 6610-16	NPort® 6610-16-48V
LAN Interface									
10/100BaseT(X) Ports	1 port (8-pin RJ45 connector)								
Magnetic Isolation Protection	1.5 KV	1.5 KV	1.5 KV	1.5 KV	1.5 KV	1.5 KV	1.5 KV	1.5 KV	1.5 KV
100BaseFX Ports	---	---	1 (multi-mode)	1 (single-mode)	---	---	---	---	---
Expansion Modules									
10/100BaseT(X) (RJ45)	---	---	---	---	√	√	√	√	√
Multi-mode Fiber (SC)	---	---	---	---	√	√	√	√	√
Single-mode Fiber (SC)	---	---	---	---	√	√	√	√	√
GSM/GPRS	---	---	---	---	√	√	√	√	√
Modem	---	---	---	---	√	√	√	√	√
Serial Interface									
RS-232 Ports	---	---	---	---	---	8	8	16	16
RS-232/422/485 Ports	1	2	2	2	4	---	---	---	---
Connectors	DB9 male	DB9 male	DB9 male	DB9 male	DB9 male	8-pin RJ45	8-pin RJ45	8-pin RJ45	8-pin RJ45
Communication Parameters	Data Bits: 5, 6, 7, 8; Stop Bits: 1, 1.5, 2; Parity: None, Even, Odd, Space, Mark								
Flow Control	RTS/CTS, DTR/DSR, XON/XOFF								
Baudrate	50 bps to 921.6 Kbps (supports non-standard baudrates)								
15 KV ESD Protection	√	√	√	√	√	√	√	√	√
2 KV isolation protection	---	---	---	---	---	---	---	---	---
RS-485 Data Direction Control	ADDC®	ADDC®	ADDC®	ADDC®	ADDC®	ADDC®	ADDC®	ADDC®	ADDC®
RS-232 Console Port	√	√	√	√	√	√	√	√	√
Advanced Features									
LCD Panel with 4 push buttons	---	---	---	---	√	√	√	√	√
Serial Data Log	64 KB	64 KB	64 KB	64 KB	64 KB	64 KB	64 KB	64 KB	64 KB
Offline Port Buffering	64 KB	64 KB	64 KB	64 KB	64 KB	64 KB	64 KB	64 KB	64 KB
SD Slot	---	√	√	√	√	√	√	√	√
Software									
Network Protocols	ICMP, IP, TCP, UDP, DHCP, BOOTP, Telnet, DNS, SNMP V1/V2c/V3, DDNS, HTTP, SMTP, HTTPS, SSL, SSH, PPPoE, RFC2217, IPv6, IPv4, Turbo Ring, Turbo Ring 2								
Security Protocols	DES, 3DES, AES, SSH, SSL, HTTPS, RADIUS, PAP, CHAP, TACACS+								
Configuration Options	Web Console, Telnet Console, Serial Console, Windows Search Utility								
Driver Support	Windows Driver Manager (for Windows 95, 98, ME, NT, 2000, XP x86/x64, 2003 x86/x64, Vista x86/x64, 2008 x86/x64, Embedded CE 5.0/6.0, XP Embedded), Linux Real TTY driver (for 2.4.x, 2.6.x), Fixed TTY driver (for SCO Unix, SCO OpenServer, UnixWare 7, UnixWare 2.1, SVR 4.2, QNX 4.25, QNX 6, Solaris 10, FreeBSD, AIX 5.x, HP-UX 11i)								
Management	SNMP MIB-II								
IP Routing	Static, RIP-I, RIP-II								
Standard Operation Modes	Real COM, TCP Server, TCP Client, UDP, Pair Connection, RFC2217, Terminal, Reverse Telnet, Ethernet Modem, Printer, PPP, Disabled								
Secure Operation Modes	Secure Real COM, Secure TCP Server, Secure TCP Client, Secure Pair Connection, SSH, Reverse SSH								
Terminal Sessions	8 sessions per port								
Physical Characteristics									
Housing	Metal	Metal	Metal	Metal	Metal (IP30)	Metal (IP30)	Metal (IP30)	Metal (IP30)	Metal (IP30)
Weight	700 g	730 g	730 g	730 g	1020 g	3460 g	3460 g	3580 g	3580 g
Dimensions (mm)	67 x 100.4 x 28	77 x 111 x 28	77 x 111 x 28	77 x 111 x 28	158 x 103 x 35	440 x 195 x 44	440 x 195 x 44	440 x 195 x 44	440 x 195 x 44
Environmental Limits									
Operating Temperature	0 to 55°C	0 to 55°C	0 to 55°C	0 to 55°C	0 to 55°C	0 to 55°C	0 to 55°C	0 to 55°C	0 to 55°C
Operating Humidity	5 to 95% RH	5 to 95% RH	5 to 95% RH	5 to 95% RH	5 to 95% RH	5 to 95% RH	5 to 95% RH	5 to 95% RH	5 to 95% RH
Storage Temperature	-20 to 85°C	-20 to 85°C	-20 to 85°C	-20 to 85°C	-20 to 70°C	-20 to 70°C	-20 to 70°C	-20 to 70°C	-20 to 70°C
Power Requirements									
Input Voltage	12 to 48 VDC	12 to 48 VDC	12 to 48 VDC	12 to 48 VDC	12 to 48 VDC	100 to 240 VAC	±48 VDC	100 to 240 VAC	±48 VDC
Power Consumption	285 mA @ 12 V 150 mA @ 24 V	333 mA @ 12 V 173 mA @ 24 V	428 mA @ 12 V 219 mA @ 24 V	376 mA @ 12 V 193 mA @ 24 V	730 mA @ 12 V 330 mA @ 24 V	285 mA @ 100 V 190 mA @ 240 V	293 mA @ 48 V	285 mA @ 100 V 190 mA @ 240 V	293 mA @ 48 V
Regulatory Approvals									
EMC	CE (EN55022 Class A, EN55024), FCC Part 15 Subpart B Class A								
Safety	UL (UL60950-1), TÜV (EN60950-1)								
EMS	EN61000-4-2 (ESD), Level 3 EN61000-4-4 (EFT), Level 2 EN61000-4-5 (Surge), Level 2					EN61000-4-2 (ESD), Level 3 EN61000-4-4 (EFT), Level 2 EN61000-4-5 (Surge), Level 3			
Reliability									
Buzzer, RTC, WDT	√	√	√	√	√	√	√	√	√
MTBF	231709 hrs	226128 hrs	225762 hrs	225762 hrs	120354 hrs	135891 hrs	135891 hrs	102373 hrs	102373 hrs
Warranty	5 years (see www.moxa.com/warranty)								

3

Terminal Servers > NPort® 6000 Terminal Servers

NPort® 6000 Terminal Servers



	NPort® 6610-32	NPort® 6610-32-48V	NPort® 6650-8	NPort® 6650-8-48V	NPort® 6650-16	NPort® 6650-16-48V	NPort® 6650-32	NPort® 6650-32-48V
LAN Interface								
10/100BaseT(X) Ports	1 port (8-pin RJ45 connector)							
Magnetic Isolation Protection	1.5 KV	1.5 KV	1.5 KV	1.5 KV	1.5 KV	1.5 KV	1.5 KV	1.5 KV
100BaseFX Ports	---	---	---	---	---	---	---	---
Expansion Modules								
10/100BaseT(X) (RJ45)	√	√	√	√	√	√	√	√
Multi-mode Fiber (SC)	√	√	√	√	√	√	√	√
Single-mode Fiber (SC)	√	√	√	√	√	√	√	√
GSM/GPRS	√	√	√	√	√	√	√	√
Modem	√	√	√	√	√	√	√	√
Serial Interface								
RS-232 Ports	32	32	---	---	---	---	---	---
RS-232/422/485 Ports	---	---	8	8	16	16	32	32
Connectors	8-pin RJ45	8-pin RJ45	8-pin RJ45	8-pin RJ45	8-pin RJ45	8-pin RJ45	8-pin RJ45	8-pin RJ45
Communication Parameters	Data Bits: 5, 6, 7, 8; Stop Bits: 1, 1.5, 2; Parity: None, Even, Odd, Space, Mark							
Flow Control	RTS/CTS, DTR/DSR, XON/XOFF							
Baudrate	50 bps to 921.6 Kbps (supports non-standard baudrates)							
15 KV ESD Protection	√	√	√	√	√	√	√	√
2 KV isolation protection	---	---	---	---	---	---	---	---
RS-485 Data Direction Control	ADDC®	ADDC®	ADDC®	ADDC®	ADDC®	ADDC®	ADDC®	ADDC®
RS-232 Console Port	√	√	√	√	√	√	√	√
Advanced Features								
LCD Panel with 4 push buttons	√	√	√	√	√	√	√	√
Serial Data Log	64 KB	64 KB	64 KB	64 KB	64 KB	64 KB	64 KB	64 KB
Offline Port Buffering	64 KB	64 KB	64 KB	64 KB	64 KB	64 KB	64 KB	64 KB
SD Slot	√	√	√	√	√	√	√	√
Software								
Network Protocols	ICMP, IP, TCP, UDP, DHCP, BOOTP, Telnet, DNS, SNMP V1/V2c/v3, DDNS, HTTP, SMTP, HTTPS, SSL, SSH, PPPoE, RFC2217, IPv6, IPv4, Turbo Ring, Turbo Ring 2							
Security Protocols	DES, 3DES, AES, SSH, SSL, HTTPS, RADIUS, PAP, CHAP, TACACS+							
Configuration Options	Web Console, Telnet Console, Serial Console, Windows Search Utility							
Driver Support	Windows Driver Manager (for Windows 95, 98, ME, NT, 2000, XP x86/x64, 2003 x86/x64, Vista x86/x64, 2008 x86/x64, Embedded CE 5.0/6.0, XP Embedded), Linux Real TTY driver (for 2.4.x, 2.6.x), Fixed TTY driver (for SCO Unix, SCO OpenServer, UnixWare 7, UnixWare 2.1, SVR 4.2, QNX 4.25, QNX 6, Solaris 10, FreeBSD, VAI 5.x, HP-UX 11i)							
Management	SNMP MIB-II							
IP Routing	Static, RIP-I, RIP-II							
Standard Operation Modes	Real COM, TCP Server, TCP Client, UDP, Pair Connection, RFC2217, Terminal, Reverse Telnet, Ethernet Modem, Printer, PPP, Disabled							
Secure Operation Modes	Secure Real COM, Secure TCP Server, Secure TCP Client, Secure Pair Connection, SSH, Reverse SSH							
Terminal Sessions	8 sessions per port							
Physical Characteristics								
Housing	Metal (IP30)	Metal (IP30)	Metal (IP30)	Metal (IP30)	Metal (IP30)	Metal (IP30)	Metal (IP30)	Metal (IP30)
Weight	3600 g	3600 g	3460 g	3460 g	3580 g	3580 g	3600 g	3600 g
Dimensions (mm)	440 x 195 x 44	440 x 195 x 44	440 x 195 x 44	440 x 195 x 44	440 x 195 x 44	440 x 195 x 44	440 x 195 x 44	440 x 195 x 44
Environmental Limits								
Operating Temperature	0 to 55°C	0 to 55°C	0 to 55°C	0 to 55°C	0 to 55°C	0 to 55°C	0 to 55°C	0 to 55°C
Operating Humidity	5 to 95% RH	5 to 95% RH	5 to 95% RH	5 to 95% RH	5 to 95% RH	5 to 95% RH	5 to 95% RH	5 to 95% RH
Storage Temperature	-20 to 70°C	-20 to 70°C	-20 to 70°C	-20 to 70°C	-20 to 70°C	-20 to 70°C	-20 to 70°C	-20 to 70°C
Power Requirements								
Input Voltage	100 to 240 VAC	±48 VDC	100 to 240 VAC	±48 VDC	100 to 240 VAC	±48 VDC	100 to 240 VAC	±48 VDC
Power Consumption	285 mA @ 100 V 190 mA @ 240 V	293 mA @ 48 V	285 mA @ 100 V 190 mA @ 240 V	293 mA @ 48 V	285 mA @ 100 V 190 mA @ 240 V	293 mA @ 48 V	285 mA @ 100 V 190 mA @ 240 V	293 mA @ 48 V
Regulatory Approvals								
EMC	CE (EN55022 Class A, EN55024), FCC Part 15 Subpart B Class A							
Safety	UL (UL60950-1), TÜV (EN60950-1)							
EMS	EN61000-4-2 (ESD), Level 3 EN61000-4-4 (EFT), Level 2 EN61000-4-5 (Surge), Level 2							
Reliability								
Buzzer, RTC, WDT	√	√	√	√	√	√	√	√
MTBF	68707 hrs	68707 hrs	135370 hrs	135370 hrs	101783 hrs	101783 hrs	68177 hrs	68177 hrs
Warranty	5 years (see www.moxa.com/warranty)							

3

Terminal Servers > NPort® 6000 Terminal Servers

CN2600 Terminal Servers

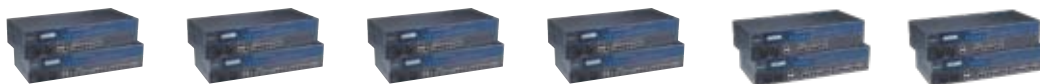

	CN2610-8	CN2610-16	CN2610-8-2AC	CN2610-16-2AC	CN2650-8	CN2650-16
LAN Interface						
10/100BaseT(X) Ports	2 ports (8-pin RJ45 connector)					
Magnetic Isolation Protection	1.5 KV	1.5 KV	1.5 KV	1.5 KV	1.5 KV	1.5 KV
Serial Interface						
RS-232 Ports	8	16	8	16	---	---
RS-232/422/485 Ports	---	---	---	---	8	16
Connectors	8-pin RJ45	8-pin RJ45	8-pin RJ45	8-pin RJ45	8-pin RJ45	8-pin RJ45
Communication Parameters	Data Bits: 5, 6, 7, 8; Stop Bits: 1, 1.5, 2; Parity: None, Even, Odd, Space, Mark					
Flow Control	RTS/CTS, DTR/DSR, XON/XOFF					
Baudrate	50 bps to 921.6 Kbps					
15 KV ESD Protection	√	√	√	√	√	√
2 KV isolation protection	---	---	---	---	---	---
RS-485 Data Direction Control	ADDC®	ADDC®	ADDC®	ADDC®	ADDC®	ADDC®
RS-232 Console Port	√	√	√	√	√	√
Advanced Features						
LCD Panel with 4 push buttons	√	√	√	√	√	√
Serial Data Log	128 KB	128 KB	128 KB	128 KB	128 KB	128 KB
Offline Port Buffering	128 KB	128 KB	128 KB	128 KB	128 KB	128 KB
Software						
Network Protocols	ICMP, IP, TCP, UDP, DHCP, BOOTP, Telnet, DNS, SNMP V1/V2c/V3, HTTP, SMTP, ARP, PPPoE, DDNS					
Security Protocols	RADIUS, https, SSH, PAP, CHAP					
Configuration Options	Web Console, Telnet Console, Serial Console, Windows Search Utility					
Driver Support	Windows Driver Manager (for Windows 95, 98, ME, NT, 2000, XP x86/x64, 2003 x86/x64, Vista x86/x64, 2008 x86/x64, Embedded CE 5.0/6.0, XP Embedded), Linux Real TTY driver (for 2.4.x, 2.6.x), Fixed TTY driver (for SCO Unix, SCO OpenServer, UnixWare 7, UnixWare 2.1, SVR 4.2, QNX 4.25, QNX 6, Solaris 10, FreeBSD, AIX 5.x, HP-UX 11i)					
Management	SNMP MIB-II					
IP Routing	Static, RIP-I, RIP-II					
Standard Operation Modes	Real COM, TCP Server, TCP Client, UDP, RFC2217, Terminal, Reverse Telnet, PPP, DRDAS, Redundant COM, Disabled					
Terminal Sessions	8 sessions per port					
Physical Characteristics						
Housing	Metal (IP30)	Metal (IP30)	Metal (IP30)	Metal (IP30)	Metal (IP30)	Metal (IP30)
Weight	3525 g	3560 g	3760 g	3980 g	3740 g	3790 g
Dimensions (mm)	440 x 198 x 45	440 x 198 x 45	440 x 198 x 45	440 x 198 x 45	440 x 198 x 45	440 x 198 x 45
Environmental Limits						
Operating Temperature	0 to 55°C					
Operating Humidity	5 to 95% RH					
Storage Temperature	-20 to 70°C					
Power Requirements						
Number of Inputs	1	1	2	2	1	1
Input Voltage	100 to 240 VAC, 47 to 63 Hz					
Power Consumption	235 mA @ 100 VAC, 145 mA @ 240 V					
Regulatory Approvals						
EMC	CE (EN55022 Class A, EN55024), FCC Part 15 Subpart B Class A					
Safety	UL (UL60950), TÜV (EN60950)					
EMS	EN61000-4-2 (ESD), Level 3 EN61000-4-4 (EFT), Level 4 EN61000-4-5 (Surge), Level 2					
Reliability						
Buzzer, RTC, WDT	√	√	√	√	√	√
MTBF	99302 hrs					
Warranty	5 years (see www.moxa.com/warranty)					

CN2600 Terminal Servers



	CN2650-8-2AC	CN2650-16-2AC	CN2650I-8	CN2650I-16	CN2650I-8-2AC	CN2650I-16-2AC
LAN Interface						
10/100BaseT(X) Ports	2 ports (8-pin RJ45 connector)					
Magnetic Isolation Protection	1.5 KV	1.5 KV	1.5 KV	1.5 KV	1.5 KV	1.5 KV
Serial Interface						
RS-232 Ports	---	---	---	---	---	---
RS-232/422/485 Ports	8	16	8	16	8	16
Connectors	8-pin RJ45	8-pin RJ45	DB9 male	DB9 male	DB9 male	DB9 male
Communication Parameters	Data Bits: 5, 6, 7, 8; Stop Bits: 1, 1.5, 2; Parity: None, Even, Odd, Space, Mark					
Flow Control	RTS/CTS, DTR/DSR, XON/XOFF					
Baudrate	50 bps to 921.6 Kbps					
15 KV ESD Protection	√	√	√	√	√	√
2 KV isolation protection	---	---	√	√	√	√
RS-485 Data Direction Control	ADDC®	ADDC®	ADDC®	ADDC®	ADDC®	ADDC®
RS-232 Console Port	√	√	√	√	√	√
Advanced Features						
LCD Panel with 4 push buttons	√	√	√	√	√	√
Serial Data Log	128 KB	128 KB	128 KB	128 KB	128 KB	128 KB
Offline Port Buffering	128 KB	128 KB	128 KB	128 KB	128 KB	128 KB
Software						
Network Protocols	ICMP, IP, TCP, UDP, DHCP, BOOTP, Telnet, DNS, SNMP V1/V2c/V3, HTTP, SMTP, ARP, PPPoE, DDNS					
Security Protocols	RADIUS, https, SSH, PAP, CHAP					
Configuration Options	Web Console, Telnet Console, Serial Console, Windows Search Utility					
Driver Support	Windows Driver Manager (for Windows 95, 98, ME, NT, 2000, XP x86/x64, 2003 x86/x64, Vista x86/x64, 2008 x86/x64, Embedded CE 5.0/6.0, XP Embedded), Linux Real TTY driver (for 2.4.x, 2.6.x), Fixed TTY driver (for SCO Unix, SCO OpenServer, UnixWare 7, UnixWare 2.1, SVR 4.2, QNX 4.25, QNX 6, Solaris 10, FreeBSD, AIX 5.x, HP-UX 11i)					
Management	SNMP MIB-II					
IP Routing	Static, RIP-I, RIP-II					
Standard Operation Modes	Real COM, TCP Server, TCP Client, UDP, RFC2217, Terminal, Reverse Telnet, PPP, DRDAS, Redundant COM, Disabled					
Terminal Sessions	8 sessions per port					
Physical Characteristics						
Housing	Metal (IP30)	Metal (IP30)	Metal (IP30)	Metal (IP30)	Metal (IP30)	Metal (IP30)
Weight	3900 g	3980 g	3666 g	3776 g	3932 g	4022 g
Dimensions (mm)	440 x 198 x 45	440 x 198 x 45	440 x 198 x 45	440 x 198 x 45	440 x 198 x 45	440 x 198 x 45
Environmental Limits						
Operating Temperature	0 to 55°C	0 to 55°C	0 to 55°C	0 to 55°C	0 to 55°C	0 to 55°C
Operating Humidity	5 to 95% RH	5 to 95% RH	5 to 95% RH	5 to 95% RH	5 to 95% RH	5 to 95% RH
Storage Temperature	-20 to 70°C	-20 to 70°C	-20 to 70°C	-20 to 70°C	-20 to 70°C	-20 to 70°C
Power Requirements						
Number of Inputs	2	2	1	1	2	2
Input Voltage	100 to 240 VAC, 47 to 63 Hz					
Power Consumption	235 mA @ 100 VAC, 145 mA @ 240 VAC					
Regulatory Approvals						
EMC	CE (EN55022 Class A, EN55024), FCC Part 15 Subpart B Class A					
Safety	UL (UL60950), TÜV (EN60950)					
EMS	EN61000-4-2 (ESD), Level 3 EN61000-4-4 (EFT), Level 4 EN61000-4-5 (Surge), Level 2					
Reliability						
Buzzer, RTC, WDT	√	√	√	√	√	√
MTBF	99302 hrs					
Warranty	5 years (see www.moxa.com/warranty)					

Combo Switch / Serial Device Server



NPort S8000: Ethernet Switch Specifications	
Ethernet Interface	
Standards	IEEE 802.3 for 10BaseT IEEE 802.3u for 100BaseT(X) and 100Base FX IEEE 802.3x for Flow Control IEEE 802.1D for Spanning Tree Protocol IEEE 802.1w for Rapid STP IEEE 802.1Q for VLAN Tagging IEEE 802.1p for Class of Service IEEE 802.1X for Authentication IEEE 802.3ad for Port Trunk with LACP
Network Protocols	ICMP, IP, TCP, UDP, ARP, Telnet, DNS, HTTP, SMTP, SNTP, IGMPv1/v2 device, GVRP, SNMPv1/v2c/v3, DHCP Server/Client, DHCP Option 82, BootP, TFTP, SNTP, SMTP, RARP, GMRP, LACP, RMON
MIB	MIB-II, Ethernet-Like MIB, P-BRIDGE MIB, Q-BRIDGE MIB, Bridge MIB, RSTP MIB, RMON MIB Group 1, 2, 3, 9
Flow Control	IEEE 802.3x flow control, back pressure flow control interface
Optical Fiber Interface	
Type	Multi-mode
Distance	0 to 2 km, 1310 nm (62.5/125 μm, 500 MHz*km)
Min. TX Output	-20 dBm
Max. TX Output	-14 dBm
Sensitivity	-34 to -30 dBm
Switch Properties	
Priority Queues	4
Max. Number of Available VLANs	64
VLAN ID Range	VID 1 to 4094
IGMP Groups	256
Switch Interface	
RJ45 Ports	10/100BaseT(X) auto negotiation speed, F/H duplex mode, and auto MDI/MDI-X connection
DIP Switches	Turbo Ring, Master, Coupler, Reserve
Alarm Contact	2 relay outputs with current carrying capacity of 1A @ 24 VDC

NPort S8000: General Specifications	
Port Summary	
Serial Ports	4 RS-232/422/485 ports
Ethernet Switch Ports	3 RJ45 copper ports, 2 multi-mode fiber ports
Console Ports	1 (8-pin RJ45 connector)
LED Indicators	PWR1, PWR2, READY, MASTER, COUPLER, LINK4, LINK5
Physical Characteristics	
Housing	Metal
Weight	995 g
Dimensions	73.1 x 134 x 105 mm
Environmental Limits	
Operating Temperature	0 to 60°C
Operating Humidity	5 to 95% RH
Storage Temperature	-40 to 85°C
Power Requirements	
Input Voltage	12 to 48 VDC
Power Consumption	935mA @ 12 V, 470 mA @ 24 V
Regulatory Approvals	
EMC	CE (EN55022 Class A, EN55024), FCC Part 15 Subpart B Class A
Safety	UL-508, UL (UL60950-1), LVD (EN60950-1)
EMS	IEC 61000-4-2, Level 4 (ESD) IEC 61000-4-4, Level 4 (EFT) IEC 61000-4-5 for serial port, Level 1 (Surge) IEC 61000-4-5 for Power Line, Level 3 (Surge) IEC 61000-4-5 for LAN port, Level 2 (Surge)
Reliability	
Buzzer, RTC, WDT	√
Warranty	5 years (see www.moxa.com/warranty)

NPort S8000: Device Server Specifications	
Serial Interface	
Number of Ports	4
Serial Standards	RS-232/422/485
Connectors	DB9 male
Serial Line Protection	15 KV ESD protection for all signals 2 KV isolation protection
RS-485 Data Direction Control	ADDC® (automatic data direction control)
Pull High/Low Resistor for RS-485	1 KΩ, 150 KΩ
Terminator for RS-485	55 Ω, 120 Ω
Console Port	Dedicated RS-232 console port (8-pin RJ45)
Serial Communication Parameters	
Data Bits	5, 6, 7, 8
Stop Bits	1, 1.5, 2
Parity	None, Even, Odd, Space, Mark
Flow Control	RTS/CTS and XON/XOFF
Baudrate	50 bps to 921.6 Kbps
Serial Signals	
RS-232	TxD, RxD, RTS, CTS, DTR, DSR, DCD, GND
RS-422	Tx+, Tx-, Rx+, Rx-, GND
RS-485-4w	Tx+, Tx-, Rx+, Rx-, GND
RS-485-2w	Data+, Data-, GND
Software	
Configuration Options	Web Console, Telnet Console, Serial Console, Windows Search Utility
Windows Real COM Drivers	Windows 95, 98, ME, NT, 2000, XP x86/x64, 2003 x86/x64, Vista x86/x64, 2008 x86/x64, Embedded CE 5.0/6.0, XP Embedded
Fixed TTY Drivers	SCO Unix, SCO OpenServer, UnixWare 7, UnixWare 2.1, SVR 4.2, QNX 4.25, QNX 6, Solaris 10, FreeBSD, AIX 5.x, HP-UX 11i 2.4.x, 2.6.x
Linux Real TTY Drivers	2.4.x, 2.6.x
Operation Modes	Real COM, TCP Server, TCP Client, UDP, RFC2217
Management	SNMP MIB-II
IP Routing	Static, RIP-I, RIP-II
Reliability	
Alert Tools	Built-in buzzer and RTC (real-time clock)
Automatic Reboot Trigger	Built-in WDT (watchdog timer)

3

Serial Device Servers > Combo Switch / Serial Device Server

General-purpose Device Servers



	NPort® 5110 NPort® 5110-T	NPort® 5130	NPort® 5150	NPort® DE-211	NPort® DE-311	NPort® 5210 NPort® 5210-T	NPort® 5230 NPort® 5230-T
Ethernet Interface							
10BaseT Ports	---	---	---	1	---	---	---
10/100BaseT(X) Ports	1	1	1	---	1	1	1
100BaseFX	---	---	---	---	---	---	---
Connector	RJ45	RJ45	RJ45	RJ45	RJ45	RJ45	RJ45
Magnetic Isolation Protection	1.5 KV	1.5 KV	1.5 KV	1.5 KV	1.5 KV	1.5 KV	1.5 KV
Serial Interface							
RS-232 Ports	1	---	---	---	---	2	1
RS-232/422 Ports	---	1	---	---	---	---	1
RS-232/422/485 Ports	---	---	1	1	1	---	---
Connector	DB9-M	DB9-M	DB9-M	DB25-F	DB9-F	RJ45	TB
15 KV ESD Protection	√	√	√	√	√	√	√
2 KV Isolation Protection	---	---	---	---	---	---	---
Serial Communication Parameters	Data Bits: 5, 6, 7, 8; Stop Bits: 1, 1.5, 2; Parity: None, Even, Odd, Space, Mark						
Flow Control	RTS/CTS, XON/XOFF						
Baudrate	110 bps to 230.4 Kbps	50 bps to 921.6 Kbps		50 bps to 230.4 Kbps		110 bps to 230.4 Kbps	
Software							
Network Protocols	ICMP, IP, TCP, UDP, DHCP, BOOTP, Telnet, DNS, SNMP V1/V2c, HTTP, SMTP			DHCP, BOOTP, Telnet, TCP, UDP, IP, ICMP, ARP		ICMP, IP, TCP, UDP, DHCP, BOOTP, Telnet, DNS, SNMP V1/V2c, HTTP, SMTP, SNMP	
Web Console	√	√	√	---	---	√	√
Serial Console	√	---	√	√	√	√	√
Telnet Console	√	√	√	√	√	√	√
Windows Utility	√	√	√	√	√	√	√
Windows Real COM Drivers	Windows 95, 98, ME, NT, 2000, XP x86/x64, 2003 x86/x64, Vista x86/x64, 2008 x86/x64, Embedded CE 5.0/6.0, XP Embedded						
Fixed TTY Drivers	SCO Unix, SCO OpenServer, UnixWare 7, UnixWare 2.1, SVR 4.2, QNX 4.25, QNX 6, Solaris 10, FreeBSD, AIX 5.x, HP-UX 11i						
Linux Real TTY Drivers	Linux 2.4.x, 2.6.x						
Onsite Configuration							
Mini Screen with Push Buttons	---	---	---	---	---	---	---
Physical Characteristics							
Housing	Metal	Metal	Metal	Metal (IP30)	Metal (IP30)	Metal (IP30)	Metal (IP30)
Weight	340 g	340 g	340 g	480 g	480 g	340 g	360 g
Dimensions	52 x 80 x 22 mm			67 x 100.4 x 22 mm			
Environmental Limits							
Operating Temperature	0 to 55°C or -40 to 75°C		0 to 55°C		0 to 55°C		0 to 55°C or -40 to 75°C
Operating Humidity	5 to 95% RH		5 to 95% RH		5 to 95% RH		5 to 95% RH
Storage Temperature	-20 to 85°C		-20 to 85°C		-20 to 85°C		-40 to 85°C
Power Requirements							
Input Voltage	12 to 48 VDC		12 to 48 VDC		9 to 30 VDC		12 to 48 VDC
Power Consumption @ 12/24/48 VDC	128.7/72/--- mA		200/106/--- mA		180/100/--- mA		---/150/--- mA
Power Consumption @ 100/240 VAC	---		---		---		---
Regulatory Approvals							
EMC	CE (EN55022 Class A, EN55024), FCC Part 15 Subpart B Class A			CE (EN55022 Class B, EN55024 Class B), FCC Part 15 Subpart B		CE (EN55022 and EN55024 Class A), FCC Part 15 Subpart B Class A	
Safety	UL (UL60950-1), TÜV (EN60950-1)						
Marine	---	---	---	---	---	DNV	
Medical	---	---	---	---	EN60601-1-2 Class B, EN55011		---
Reliability							
Buzzer, RTC, WDT	WDT only		WDT only		---		√
MTBF	279122 hrs		246505 hrs		246034 hrs		347822 hrs
Warranty	5 years (see www.moxa.com/warranty)						

General-purpose Device Servers



	NPort® 5232 NPort® 5232-T	NPort® 52321 NPort® 52321-T	NPort® 5410	NPort® 5430	NPort® 5430I	NPort® 5450	NPort® 5450I
Ethernet Interface							
10BaseT Ports	---	---	---	---	---	---	---
10/100BaseT(X) Ports	1	1	1	1	1	1	1
100BaseFX	---	---	---	---	---	---	---
Connector	RJ45	RJ45	RJ45	RJ45	RJ45	RJ45	RJ45
Magnetic Isolation Protection	1.5 KV	1.5 KV	1.5 KV	1.5 KV	1.5 KV	1.5 KV	1.5 KV
Serial Interface							
RS-232 Ports	---	---	4	---	---	---	---
RS-232/422 Ports	2	2	---	4	4	---	---
RS-232/422/485 Ports	---	---	---	---	---	4	4
Connector	TB	TB	DB9-M	TB	TB	DB9-M	DB9-M
15 KV ESD Protection	√	√	√	√	√	√	√
2 KV Isolation Protection	---	√	---	---	√	---	√
Serial Communication Parameters	Data Bits: 5, 6, 7, 8; Stop Bits: 1, 1.5, 2; Parity: None, Even, Odd, Space, Mark						
Flow Control	RTS/CTS, XON/XOFF	RTS/CTS, XON/XOFF	RTS/CTS, XON/XOFF	RTS/CTS, XON/XOFF	RTS/CTS, XON/XOFF	RTS/CTS, XON/XOFF	RTS/CTS, XON/XOFF
Baudrate	110 bps to 230.4 Kbps		50 bps to 921.6 Kbps				
Software							
Network Protocols	ICMP, IP, TCP, UDP, DHCP, BOOTP, Telnet, DNS, SNMP V1/V2c, HTTP, SMTP, SNMP		ICMP, IP, TCP, UDP, DHCP, BOOTP, Telnet, DNS, SNMP V1/V2c, HTTP, SMTP, SNMP, Rtelnet, ARP				
Web Console	√	√	√	√	√	√	√
Serial Console	---	---	---	---	---	---	---
Telnet Console	√	√	√	√	√	√	√
Windows Utility	√	√	√	√	√	√	√
Windows Real COM Drivers	Windows 95, 98, ME, NT, 2000, XP x86/x64, 2003 x86/x64, Vista x86/x64, 2008 x86/x64, Embedded CE 5.0/6.0, XP Embedded						
Fixed TTY Drivers	SCO Unix, SCO OpenServer, UnixWare 7, UnixWare 2.1, SVR 4.2, QNX 4.25, QNX 6, Solaris 10, FreeBSD, AIX 5.x, HP-UX 11i						
Linux Real TTY Drivers	Linux 2.4.x, 2.6.x						
Onsite Configuration							
Mini Screen with Push Buttons	---	---	√	√	√	√	√
Physical Characteristics							
Housing	Metal (IP30)	Metal (IP30)	Metal (IP30)	Metal (IP30)	Metal (IP30)	Metal (IP30)	Metal (IP30)
Weight	360 g	380 g	740 g				
Dimensions	67 x 100.4 x 22 mm	67 x 100.4 x 35 mm	158 x 103 x 33 mm				
Environmental Limits							
Operating Temperature	0 to 55°C or -40 to 75°C		0 to 55°C (32 to 131°F)				
Operating Humidity	5 to 95% RH		5 to 95% RH				
Storage Temperature	-40 to 85°C		-20 to 70°C				
Power Requirements							
Input Voltage	12 to 48 VDC	12 to 48 VDC	12 to 48 VDC	12 to 48 VDC	12 to 48 VDC	12 to 48 VDC	12 to 48 VDC
Power Consumption @ 12/24/48 VDC	280/150/--- mA	509.4/200/--- mA	350/190/--- mA	320/175/--- mA	530/280/--- mA	350/190/--- mA	554/294/--- mA
Power Consumption @ 100/240 VAC	---	---	---	---	---	---	---
Regulatory Approvals							
EMC	CE (EN55022 and EN55024 Class A), FCC Part 15 Subpart B Class A						
Safety	UL (UL60950-1), TÜV (EN60950-1)						
Marine	DNV						
Medical	---	---	EN60601-1-2 Class B, EN55011				
Reliability							
Buzzer, RTC, WDT	√	√	√	√	√	√	√
MTBF	102344 hrs	87083 hrs	206903 hrs	206903 hrs	206903 hrs	206903 hrs	206903 hrs
Warranty	5 years (see www.moxa.com/warranty)						

General-purpose Device Servers



	NPort® 5610-8	NPort® 5610-8-48V	NPort® 5630-8	NPort® 5650-8	NPort® 5650-8-M-SC	NPort® 5650-8-S-SC	NPort® 5610-16	NPort® 5610-16-48V
Ethernet Interface								
10BaseT Ports	---	---	---	---	---	---	---	---
10/100BaseT(X) Ports	1	1	1	1	---	---	1	1
100BaseFX Ports	---	---	---	---	1 (multi-mode)	1 (single-mode)	---	---
Connector	RJ45	RJ45	RJ45	RJ45	SC	SC	RJ45	RJ45
Magnetic Isolation Protection	1.5 KV	1.5 KV	1.5 KV	1.5 KV	---	---	1.5 KV	1.5 KV
Serial Interface								
RS-232 Ports	8	8	---	---	---	---	16	16
RS-232/422 Ports	---	---	8	---	---	---	---	---
RS-232/422/485 Ports	---	---	---	8	8	8	---	---
Connector	RJ45	RJ45	RJ45	RJ45	RJ45	RJ45	RJ45	RJ45
15 KV ESD Protection	√	√	√	√	√	√	√	√
2 KV Isolation Protection	---	---	---	---	---	---	---	---
Serial Communication Parameters	Data Bits: 5, 6, 7, 8; Stop Bits: 1, 1.5, 2; Parity: None, Even, Odd, Space, Mark							
Flow Control	RTS/CTS, XON/XOFF							
Baudrate	50 bps to 921.6 Kbps							
Software								
Network Protocols	ICMP, IP, TCP, UDP, DHCP, BOOTP, Telnet, DNS, SNMP V1/V2c, HTTP, SMTP, SNTp, ARP, PPP, SLIP, RTelnet, RFC2217							
Web Console	√	√	√	√	√	√	√	√
Serial Console	---	---	---	---	---	---	---	---
Telnet Console	√	√	√	√	√	√	√	√
Windows Utility	√	√	√	√	√	√	√	√
Windows Real COM Drivers	Windows 95, 98, ME, NT, 2000, XP x86/x64, 2003 x86/x64, Vista x86/x64, 2008 x86/x64, Embedded CE 5.0/6.0, XP Embedded							
Fixed TTY Drivers	SCO Unix, SCO OpenServer, UnixWare 7, UnixWare 2.1, SVR 4.2, QNX 4.25, QNX 6, Solaris 10, FreeBSD, AIX 5.x, HP-UX 11i							
Linux Real TTY Drivers	Linux 2.4.x, 2.6.x							
Onsite Configuration								
Mini Screen with Push Buttons	√	√	√	√	√	√	√	√
Physical Characteristics								
Housing	Metal (IP30)	Metal (IP30)	Metal (IP30)	Metal (IP30)	Metal (IP30)	Metal (IP30)	Metal (IP30)	Metal (IP30)
Weight	3340 g	3160 g	3380 g	3360 g	3380 g	3380 g	3420 g	3260 g
Dimensions	440 x 45 x 198 mm							
Environmental Limits								
Operating Temperature	0 to 55°C	0 to 55°C	0 to 55°C	0 to 55°C	0 to 55°C	0 to 55°C	0 to 55°C	0 to 55°C
Operating Humidity	5 to 95% RH	5 to 95% RH	5 to 95% RH	5 to 95% RH	5 to 95% RH	5 to 95% RH	5 to 95% RH	5 to 95% RH
Storage Temperature	-20 to 75°C	-20 to 75°C	-20 to 75°C	-20 to 75°C	-20 to 75°C	-20 to 75°C	-20 to 75°C	-20 to 75°C
Power Requirements								
Input Voltage	100 to 240 VAC, 47 to 63 Hz	±48 VDC	100 to 240 VAC, 47 to 63 Hz	100 to 240 VAC, 47 to 63 Hz	100 to 240 VAC, 47 to 63 Hz	100 to 240 VAC, 47 to 63 Hz	100 to 240 VAC, 47 to 63 Hz	±48 VDC
Power Consumption @ 12/24/48 VDC	---	---/---/135 mA	---	---	---	---	---	---/---/135 mA
Power Consumption @ 100/240 VAC	141/93 mA	---	152/98 mA	158/102 mA	174/113 mA	164/110 mA	141/93 mA	---
Regulatory Approvals								
EMC	CE (EN55022 Class A, EN55024), FCC Part 15 Subpart B Class A, IEC61000-4-12		CE (EN55022 Class A, EN55024), FCC Part 15 Subpart B Class A				CE (EN55022 Class A, EN55024), FCC Part 15 Subpart B Class A, IEC61000-4-12	
Safety	UL (UL60950-1), TÜV (EN60950-1)							
Marine	---	---	---	---	---	---	---	---
Medical	EN60601-1-2 Class B, EN55011							
Reliability								
Buzzer, RTC, WDT	√	√	√	√	√	√	√	√
MTBF	97294 hrs	96758 hrs	118405 hrs	117584 hrs	116914 hrs	116914 hrs	94928 hrs	94417 hrs
Warranty	5 years (see www.moxa.com/warranty)							

General-purpose Device Servers



	NPort® 5630-16	NPort® 5650-16	NPort® 5650-16-M-SC	NPort® 5650-16-S-SC	NPort® 5610-8-DT	NPort® 5610-8-DT-J	NPort® 5650-8-DT	NPort® 5650I-8-DT	NPort® 5650S-8-DT-J
Ethernet Interface									
10BaseT Ports	---	---	---	---	---	---	---	---	---
10/100BaseT(X) Ports	1	1	---	---	2	2	2	2	2
100BaseFX Ports	---	---	1 (multi-mode)	1 (single-mode)	---	---	---	---	---
Connector	RJ45	RJ45	SC	SC	RJ45	RJ45	RJ45	RJ45	RJ45
Magnetic Isolation Protection	1.5 KV	1.5 KV	---	---	1.5 KV	1.5 KV	1.5 KV	1.5 KV	1.5 KV
Serial Interface									
RS-232 Ports	---	---	---	---	8	8	---	---	---
RS-232/422 Ports	16	---	---	---	---	---	---	---	---
RS-232/422/485 Ports	---	16	16	16	---	---	8	8	8
Connector	RJ45	RJ45	RJ45	RJ45	DB9-M	RJ45	DB9-M	DB9-M	RJ45
15 KV ESD Protection	√	√	√	√	√	√	√	√	√
2 KV Isolation Protection	---	---	---	---	---	---	---	√	---
Serial Communication Parameters	Data Bits: 5, 6, 7, 8; Stop Bits: 1, 1.5, 2; Parity: None, Even, Odd, Space, Mark								
Flow Control	RTS/CTS, XON/XOFF								
Baudrate	50 bps to 921.6 Kbps								
Software									
Network Protocols	ICMP, IP, TCP, UDP, DHCP, BOOTP, Telnet, DNS, SNMP V1/V2c, HTTP, SMTP, SNTp, ARP, PPP, SLIP, RTelnet, RFC2217				ICMP, IP, TCP, UDP, DHCP, BOOTP, Telnet, DNS, SNMP V1/V2c, HTTP, SMTP, SNTp, RTelnet, ARP, RFC2217				
Web Console	√	√	√	√	√	√	√	√	√
Serial Console	---	---	---	---	√	√	√	√	√
Telnet Console	√	√	√	√	√	√	√	√	√
Windows Utility	√	√	√	√	√	√	√	√	√
Windows Real COM Drivers	Windows 95, 98, ME, NT, 2000, XP x86/x64, 2003 x86/x64, Vista x86/x64, 2008 x86/x64, Embedded CE 5.0/6.0, XP Embedded								
Fixed TTY Drivers	SCO Unix, SCO OpenServer, UnixWare 7, UnixWare 2.1, SVR 4.2, QNX 4.25, QNX 6, Solaris 10, FreeBSD, AIX 5.x, HP-UX 11i								
Linux Real TTY Drivers	Linux 2.4.x, 2.6.x								
Onsite Configuration									
Mini Screen with Push Buttons	√	√	√	√	√	√	√	√	√
Physical Characteristics									
Housing	Metal (IP30)	Metal (IP30)	Metal (IP30)	Metal (IP30)	Metal (IP30)	Metal (IP30)	Metal (IP30)	Metal (IP30)	Metal (IP30)
Weight	3400 g	3460 g	3440 g	3440 g	1760 g	1170 g	1770 g	1850 g	1710 g
Dimensions	440 x 45 x 198 mm				197 x 44 x 135.5 mm				
Environmental Limits									
Operating Temperature	0 to 55°C	0 to 55°C	0 to 55°C	0 to 55°C	0 to 55°C	0 to 55°C	0 to 55°C	0 to 55°C	0 to 55°C
Operating Humidity	5 to 95% RH	5 to 95% RH	5 to 95% RH	5 to 95% RH	5 to 95% RH	5 to 95% RH	5 to 95% RH	5 to 95% RH	5 to 95% RH
Storage Temperature	-20 to 75°C	-20 to 75°C	-20 to 75°C	-20 to 75°C	-20 to 70°C	-20 to 70°C	-20 to 70°C	-20 to 70°C	-20 to 70°C
Power Requirements									
Input Voltage	100 to 240 VAC, 47 to 63 hz	100 to 240 VAC, 47 to 63 hz	100 to 240 VAC, 47 to 63 hz	100 to 240 VAC, 47 to 63 hz	12 to 48 VDC	12 to 48 VDC	12 to 48 VDC	12 to 48 VDC	12 to 48 VDC
Power Consumption @ 12/24/48 VDC	---	---	---	---	611/300/140 mA	611/300/140 mA	615/300/156 mA	1066/510/200 mA	615/300/156 mA
Power Consumption @ 100/240 VAC	152/98 mA	158/102 mA	174/113 mA	164/110 mA	---	---	---	---	---
Regulatory Approvals									
EMC	CE (EN55022 Class A, EN55024), FCC Part 15 Subpart B Class A				CE (EN55022 Class A, EN55024), FCC Part 15 Subpart B Class A				
Safety	UL (UL60950-1), TÜV (EN60950-1)								
Marine	---	---	---	---	---	---	---	---	---
Medical	EN60601-1-2 Class B, EN55011	EN60601-1-2 Class B, EN55011	EN60601-1-2 Class B, EN55011	EN60601-1-2 Class B, EN55011	---	---	---	---	---
Reliability									
Buzzer, RTC, WDT	√	√	√	√	√	√	√	√	√
MTBF	91483 hrs	104767 hrs	87528 hrs	87528 hrs	163356 hrs	163356 hrs	163356 hrs	163356 hrs	163356 hrs
Warranty	5 years (see www.moxa.com/warranty)								

Industrial-grade Device Servers



	NPort® IA5150 NPort® IA5150-T	NPort® IA5150I NPort® IA5150I-T	NPort® IA5150-M-SC NPort® IA5150-M-SC-T	NPort® IA5150I-M-SC NPort® IA5150I-M-SC-T	NPort® IA5150-S-SC NPort® IA5150-S-SC-T	NPort® IA5150I-S-SC NPort® IA5150I-S-SC-T	NPort® IA5250 NPort® IA5250-T
Ethernet Interface							
10/100BaseT(X) Ports	2	2	---	---	---	---	2
100BaseFX Ports	---	---	1 (multi-mode)	1 (multi-mode)	1 (single-mode)	1 (single-mode)	---
Connector	RJ45	RJ45	SC	SC	SC	SC	RJ45
Magnetic Isolation Protection	1.5 KV	1.5 KV	---	---	---	---	1.5 KV
Serial Interface							
RS-232/422/485 Ports	1	1	1	1	1	1	2
Connector	DB9-M/TB	DB9-M/TB	DB9-M/TB	DB9-M/TB	DB9-M/TB	DB9-M/TB	DB9-M
15 KV ESD Protection	√	√	√	√	√	√	√
2 KV Isolation Protection	---	√	---	√	---	√	---
Serial Communication Parameters	Data Bits: 5, 6, 7, 8; Stop Bits: 1, 1.5, 2; Parity: None, Even, Odd, Space, Mark						
Flow Control	RTS/CTS, XON/XOFF						
Baudrate	110 bps to 230.4 Kbps						
Software							
Network Protocols	ICMP, IP, TCP, UDP, DHCP, BOOTP, Telnet, Rtelnet, DNS, SNMP V1/V2c, HTTP, SMTP, SNTP						
Configuration Options	Web Console, Serial Console, Telnet Console, Windows Utility						
Windows Real COM Drivers	Windows 95, 98, ME, NT, 2000, XP x86/x64, 2003 x86/x64, Vista x86/x64, 2008 x86/x64, Embedded CE 5.0/6.0, XP Embedded						
Fixed TTY Drivers	SCO Unix, SCO OpenServer, UnixWare 7, UnixWare 2.1, SVR 4.2, QNX 4.25, QNX 6, Solaris 10, FreeBSD, AIX 5.x, HP-UX 11i						
Linux Real TTY Drivers	Linux 2.4.x, 2.6.x						
Physical Characteristics							
Housing	Plastic (IP30)						
Weight	360 g						
Dimensions	29 x 89.2 x 118.5 mm						
Environmental Limits							
Operating Temperature	0 to 55°C or -40 to 75°C						
Operating Humidity	5 to 95% RH						
Storage Temperature	-40 to 85°C						
Power Requirements							
Input Voltage	12 to 48 VDC	12 to 48 VDC	12 to 48 VDC	12 to 48 VDC	12 to 48 VDC	12 to 48 VDC	12 to 48 VDC
Power Consumption	360 mA @ 12 V, 195 mA @ 24 V	420 mA @ 12 V, 215 mA @ 24 V	500 mA @ 12 V, 250 mA @ 24 V	510 mA @ 12 V, 260 mA @ 24 V	470 mA @ 12 V, 210 mA @ 24 V	490 mA @ 12 V, 250 mA @ 24 V	440 mA @ 12 V, 200 mA @ 24 V
Regulatory Approvals							
EMC	CE (EN55022 Class A, EN55024), FCC Part 15 Subpart B Class A						
Safety	UL (UL60950-1), UL508, TÜV (EN60950-1)						
Hazardous Location	UL/cUL Class 1 Division 2 Groups A, B, C and D						
ATEX	Class I, Zone 2						
Marine	DNV						
EMS	EN61000-4-2 (ESD), Level 3; EN61000-4-3 (RS), Level 3; EN61000-4-4 (EFT), Level 4; EN61000-4-5 (Surge), Level 3; EN61000-4-6 (CS), Level 3; EN61000-4-8; EN61000-4-11; EN61000-4-12						
IEC	IEC60068-2-27 (Shock); IEC60068-2-32 (Freefall); IEC60068-2-6 (Vibration)						
Dust-proof	IP30	IP30	IP30	IP30	IP30	IP30	IP30
Reliability							
Buzzer, RTC, WDT	√	√	√	√	√	√	√
MTBF	183747 hrs	195614 hrs	183747 hrs	195614 hrs	183747 hrs	195614 hrs	194765 hrs
Warranty	5 years (see www.moxa.com/warranty)						

Embedded Device Servers



	MiiNePort E1 MiiNePort E1-T	NE-4110S	NE-4110A	NE-4120S	NE-4120A	NE-4100T	WE-2100T	
Form Factor								
Type	Drop-in module	Ready-to-go stand-alone modules				26-pin dual-in-line package	Small metal housing	
Dimensions	33.9 x 16.25 x 13.5 mm	57 x 40 mm	57 x 40 mm	57 x 40 mm	57 x 40 mm	45 x 36 mm	54 x 40 x 13.3 mm	
Ethernet Interface								
10/100BaseT(X) Ports	1	1	1	1	1	1	1	
Connector	RJ45	RJ45	RJ45	5-pin pin header		26-pin dual-in-line	44-pin dual-in-line	
Magnetic Isolation Protection	1.5 KV	1.5 KV	1.5 KV	1.5 KV	1.5 KV	1.5 KV	1.5 KV	
WLAN Interface								
Standard Compliance	---	---	---	---	---	---	IEEE 802.11a/b/g	
Radio Frequency Type	---	---	---	---	---	---	DSSS, CCK, DFDM	
Wireless Security	---	---	---	---	---	---	SEP, SPA, SPA2, 802.11i	
Network Modes	---	---	---	---	---	---	Infrastructure (a/b/g), Ad Hoc (b/g)	
Serial Interface								
TTL Ports	1 (data port)	1 (console port)				2 (1 data port, 1 console port)		
RS-232 Ports	---	1 (data port)	---	1 (data port)	---	---	---	
RS-232/422 Ports	---	---	1 (data port)	---	1 (data port)	---	---	
Serial Communication Parameters	Data Bits: 5, 6, 7, 8; Stop Bits: 1, 1.5, 2; Parity: None, Even, Odd, Space, Mark							
Flow Control	RTS/CTS, XON/XOFF							
Baudrate	50 bps to 230.4 Kbps* (supports non-standard baudrates)	110 bps to 230.4 Kbps					50 bps to 921.6 Kbps	
Programmable GPIO Pins	3	4	4	4	4	4	---	
Software								
Network Protocols	ICMP, IP, TCP, UDP, DHCP, Telnet, HTTP, SNMP V1/V2c, SMTP, ARP, TFTP, Auto IP, BOOTP						DNS, SNMP, SSH, HTTPS	
Configuration Options	Web/Serial/Telnet Console, Windows Utility							
Serial Command Mode	√	---	---	---	---	---	√	
Windows Real COM Drivers	Windows 95, 98, ME, NT, 2000, XP x86/x64, 2003 x86/x64, Vista x86/x64, 2008 x86/x64, Embedded CE 5.0/6.0, XP Embedded							
Fixed TTY Drivers	SCO Unix, SCO OpenServer, UnixWare 7, UnixWare 2.1, SVR 4.2, QNX 4.25, QNX 6, Solaris 10, FreeBSD, AIX 5.x, HP-UX 11i							
Linux Real TTY Drivers	Linux 2.4.x, 2.6.x							
Operation Modes	TCP Server, TCP Client, UDP, Real COM mode, Modem Mode, RFC2217	Real COM, TCP Server, TCP Client, UDP					Real COM, TCP Server, TCP Client, UDP, RFC2217	
Environmental Limits								
Operating Temperature	0 to 55°C or -40 to 85°C	0 to 55°C or -40 to 75°C				0 to 55°C		
Operating Humidity	5 to 95% RH					5 to 95% RH		
Storage Temperature	-40 to 85°C	-20 to 70°C				-20 to 70°C		
Power Requirements								
Input Voltage	3.3 VDC (±5%)	5 VDC (±5%)	5 VDC (±5%)	5 VDC (±5%)	5 VDC (±5%)	5 VDC (±5%)	3.3 VDC (±5%)	
Power Consumption	160 mA @ 3.3 VDC max.	290 mA @ 5 VDC max.				540 mA (at full speed)		
Regulatory Approvals								
EMC	EN55022:1998, Class B (radiated & conducted emissions); EN55024:1998 (direct & indirect ESD, electrical fast-transient/burst immunity, power frequency magnetic field immunity)	CE (EN55022 Class A), FCC Part 15 Subpart B Class A					CE (EN55022 and EN55024 Class A, ETSI EN 301 489-17, ETSI EN 301 489-1)	
Reliability								
Watchdog Timer	√	√	√	√	√	√	√	
MTBF	---	290276 hrs	289573 hrs	289573 hrs	289573 hrs	288173 hrs	505288 hrs	
Warranty	5 years (see www.moxa.com/warranty)							

* Baudrates up to 921.6 Kbps available by request

3
Serial Device Servers > Embedded Device Servers

Ethernet Fieldbus Gateways



	MGate™ MB3170 MGate™ MB3170-T	MGate™ MB3170I MGate™ MB3170I-T	MGate™ MB3270 MGate™ MB3270-T	MGate™ MB3270I MGate™ MB3270I-T	MGate™ MB3180	MGate™ MB3280	MGate™ MB3480
Ethernet Interface							
Number of Ports	2 (1 IP)	2 (1 IP)	2 (1 IP)	2 (1 IP)	1	1	1
Speed	10/100 Mbps	10/100 Mbps	10/100 Mbps	10/100 Mbps	10/100 Mbps	10/100 Mbps	10/100 Mbps
Connector	RJ45	RJ45	RJ45	RJ45	RJ45	RJ45	RJ45
Magnetic Isolation Protection	1.5 KV	1.5 KV	1.5 KV	1.5 KV	1.5 KV	1.5 KV	1.5 KV
Serial Interface							
Number of Ports	1	1	2	2	1	2	4
Serial Standards	RS-232/422/485	RS-232/422/485	RS-232/422/485	RS-232/422/485	RS-232/422/485	RS-232/422/485	RS-232/422/485
Connectors	RS-232: DB9-M; RS-422/485: Terminal Block	RS-232: DB9-M; RS-422/485: Terminal Block	DB9-M	DB9-M	DB9-M	DB9-M	DB9-M
ESD Protection	15 KV	15 KV	15 KV	15 KV	15 KV	15 KV	15 KV
RS-485 Data Direction Control	ADDC®	ADDC®	ADDC®	ADDC®	ADDC®	ADDC®	ADDC®
Serial Communication Parameters	Data Bits: 7, 8; Stop Bits: 1, 2; Parity: None, Even, Odd, Space, Mark						
Parity	None, Even, Odd, Space, Mark						
Flow Control	RTS/CTS, DTR/DSR (RS-232 only)						
Baudrate	50 bps to 921.6 Kbps						
Software							
Operation Modes	RTU Slave, RTU Master, ASCII Slave, ASCII Master						
Utilities	MGate™ Manager Suite for Windows 98, ME, NT, 2000, XP, 2003, Vista						
Smart Routing	√	√	√	√	√	√	√
Serial Redirection	√	√	√	√	---	---	---
Priority Control	√	√	√	√	---	---	---
Ethernet Protocol	---	---	---	---	---	---	---
Serial Protocol	---	---	---	---	---	---	---
Physical Characteristics							
Housing	Plastic	Plastic	Plastic	Plastic	Metal	Metal	Metal (IP30)
Dimensions	29 x 89.2 x 118.5 mm				22 x 52 x 80 mm	22 x 77 x 111 mm	35.5 x 103 x 158 mm
Environmental Limits							
Operating Temperature	0 to 55°C or -40 to 75°C				0 to 55°C	0 to 55°C	0 to 55°C
Operating Humidity	5 to 95% RH		5 to 95% RH		5 to 95% RH	5 to 95% RH	5 to 95% RH
Storage Temperature	-40 to 85°C		-40 to 85°C		-20 to 85°C	-20 to 85°C	-20 to 85°C
Power Requirements							
Input Voltage	12 to 48 VDC		12 to 48 VDC		12 to 48 VDC	12 to 48 VDC	12 to 48 VDC
Power Connector	Terminal block		Terminal block		Power jack	Power jack and terminal block	
Regulatory Approvals							
EMC	CE (EN55022 Class A and EN55024), FCC Part 15 Subpart B Class A						
Safety	UL (UL60950-1), TÜV (EN60950-1)						
Hazardous Location	UL/cUL Class 1 Division 2 Groups A, B, C, D; ATEX Class 1 Zone 2				---	---	---
Shock	IEC 60068-2-27				---	---	---
Freefall	IEC 60068-2-23				---	---	---
Vibration	IEC 60068-2-6				---	---	---
Marine	DNV				---	---	---
EMS	EN61000-4-2 (ESD): Level 3 EN61000-4-3 (RS): Level 3 EN61000-4-4 (EFT): Level 4 EN61000-4-5 (Surge): Level 3 EN61000-4-6 (CS): Level 3 EN61000-4-8: Passed EN61000-4-11: Passed EN61000-4-12: Passed				EN61000-4-2 (ESD): Level 2 EN61000-4-3 (RS): Level 2 EN61000-4-4 (EFT): Level 2 EN61000-4-5 (Surge): Level 2 EN61000-4-6 (CS): Level 2 EN61000-4-8: Passed EN61000-4-11: Passed EN61000-4-12: Passed		
Reliability							
Warranty	5 years (see www.moxa.com/warranty)						

3

Ethernet Fieldbus Gateways > Ethernet Fieldbus Gateways

Ethernet Fieldbus Gateways



	MGate™ EIP3170 MGate™ EIP3170-T	MGate™ EIP3170I MGate™ EIP3170I-T	MGate™ EIP3270 MGate™ EIP3270-T	MGate™ EIP3270I MGate™ EIP3270I-T
Ethernet Interface				
Number of Ports	2 (1 IP)	2 (1 IP)	2 (1 IP)	2 (1 IP)
Speed	10/100 Mbps	10/100 Mbps	10/100 Mbps	10/100 Mbps
Connector	RJ45	RJ45	RJ45	RJ45
Magnetic Isolation Protection	1.5 KV	1.5 KV	1.5 KV	1.5 KV
Serial Interface				
Number of Ports	1	1	2	2
Serial Standards	RS-232/422	RS-232/422	RS-232/422	RS-232/422
Connectors	DB9-M (RS-232), TB (RS-422)	DB9-M (RS-232), TB (RS-422)	DB9-M	DB9-M
ESD Protection	15 KV	15 KV	15 KV	15 KV
RS-485 Data Direction Control	ADDC®	ADDC®	ADDC®	ADDC®
Serial Communication Parameters	Data Bits: 7, 8; Stop Bits: 1, 2; Parity: None, Even, Odd, Space, Mark			
Parity	None, Even, Odd, Space, Mark			
Flow Control	RTS/CTS, DTR/DSR			
Baudrate	50 bps to 921.6 Kbps			
Software				
Operation Modes	---	---	---	---
Utilities	MGate™ Manager Suite for Windows 98, ME, NT, 2000, XP, 2003, Vista			
Smart Routing	√	√	√	√
Serial Redirection	---	---	√	√
Priority Control	---	---	---	---
Ethernet Protocol	CIP (PCCC) on Ethernet/IP			
Serial Protocol	DF1 Full-duplex	DF1 Full-duplex	DF1 Full-duplex	DF1 Full-duplex
Physical Characteristics				
Housing	Plastic	Plastic	Plastic	Plastic
Dimensions	29 x 89.2 x 118.5 mm	29 x 89.2 x 118.5 mm	29 x 89.2 x 118.5 mm	29 x 89.2 x 118.5 mm
Environmental Limits				
Operating Temperature	0 to 55°C or -40 to 75°C	0 to 55°C or -40 to 75°C	0 to 55°C or -40 to 75°C	0 to 55°C or -40 to 75°C
Operating Humidity	5 to 95% RH	5 to 95% RH	5 to 95% RH	5 to 95% RH
Storage Temperature	-20 to 85°C	-20 to 85°C	-20 to 85°C	-20 to 85°C
Power Requirements				
Input Voltage	12 to 48 VDC	12 to 48 VDC	12 to 48 VDC	12 to 48 VDC
Power Connector	Terminal block	Terminal block	Terminal block	Terminal block
Regulatory Approvals				
EMC	CE (EN55022 Class A and EN55024), FCC Part 15 Subpart B Class A			
Safety	UL (UL60950-1), LVD (EN60950-1)			
Hazardous Location	UL/cUL Class 1 Division 2 Groups A, B, C, D; ATEX Class 1 Zone 2			
Shock	IEC60068-2-27			
Freefall	IEC60068-2-23			
Vibration	IEC60068-2-6			
Marine	---	---	---	---
EMS	EN61000-4-2 (ESD): Level 3 EN61000-4-3 (RS): Level 3 EN61000-4-4 (EFT): Level 4 EN61000-4-5 (Surge): Level 3 EN61000-4-6 (CS): Level 3 EN61000-4-8: Passed EN61000-4-11: Passed EN61000-4-12: Passed			
Reliability				
Warranty	5 years (see www.moxa.com/warranty)			

PCI Express Serial Boards



	CP-118EL	CP-168EL	CP-114EL	CP-114EL-I	CP-104EL	CP-102E	CP-102EL	CP-132EL	CP-132EL-I	
Hardware										
Comm. Controller	MU860		16C550C compatible		MU860	16C550C compatible				
Bus	PCI Express x1									
Connector	VHDCI 68		DB44 female			DB9 male	DB25 female			
Serial Interface										
RS-232 Ports	---	8	---	---	4	2	2	---	---	
RS-422 Ports	---	---	---	---	---	---	---	---	---	
RS-422/485 Ports	---	---	---	---	---	---	---	2	2	
RS-232/422/485 Ports	8	---	4	4	---	---	---	---	---	
Communication Parameters	Data Bits: 5, 6, 7, 8; Stop Bits: 1, 1.5, 2; Parity: None, Even, Odd, Space, Mark									
Flow Control	RTS/CTS, XON/XOFF							XON/XOFF		
Baudrate	50 bps to 921.6 Kbps									
ESD Protection	15 KV	15 KV	15 KV	15 KV	15 KV	15 KV	15 KV	15 KV	15 KV	
Optical Isolation	---	---	---	2 KV	---	---	---	---	2 KV	
Driver Support										
Windows 9X/ME/NT	---	---	---	---	---	---	---	---	---	
Windows 2000	√	√	√	√	√	√	√	√	√	
Windows XP/2003/Vista x86/x64	√	√	√	√	√	√	√	√	√	
Windows 2008 x86/x64	√	√	√	√	√	√	√	√	√	
Windows CE 5.0	√	√	---	---	√	---	---	---	---	
Windows CE 6.0	---	---	---	---	---	---	---	---	---	
Windows XP Embedded	√	√	√	√	√	√	√	√	√	
DOS	√	√	---	---	√	---	---	---	---	
Linux 2.4/2.6	√	√	√	√	√	√	√	√	√	
FreeBSD 4/5	√	√	---	---	√	---	---	---	---	
QNX 4	---	---	---	---	---	---	---	---	---	
QNX 6	√	√	√	√	√	√	√	√	√	
SCO Open Server 5/6	√	√	√	√	√	√	√	√	√	
UnixWare 7	√	√	√	√	√	√	√	√	√	
Environmental Factors										
Dimensions (mm)	64.4 x 132	62.7 x 102	67.2 x 136.9	67.2 x 136.9	62.7 x 100	85.0 x 100	67.2 x 102.0	67.2 x 102.0	67.2 x 104.0	
Operating Temperature	0 to 55°C	0 to 55°C	0 to 55°C	0 to 55°C	0 to 55°C	0 to 55°C	0 to 55°C	0 to 55°C	0 to 55°C	
Operating Humidity	5 to 95% RH	5 to 95% RH	5 to 95% RH	5 to 95% RH	5 to 95% RH	5 to 95% RH	5 to 95% RH	5 to 95% RH	5 to 95% RH	
Storage Temperature	-20 to 85°C	-20 to 85°C	-20 to 85°C	-20 to 85°C	-20 to 85°C	-20 to 85°C	-20 to 85°C	-20 to 85°C	-20 to 85°C	
Regulatory Approvals										
FCC, Part 15 Class	B	B	B	B	B	B	B	B	B	
EN55022 Class B	---	---	---	---	---	---	---	---	---	
EN55022	---	---	---	---	---	---	---	---	---	
EN55024	√	√	√	√	√	√	√	√	√	
EN61000-3-2	√	√	√	√	√	√	√	√	√	
EN61000-3-3	√	√	√	√	√	√	√	√	√	
EN61000-6-2	√	√	√	√	√	√	√	√	√	
EN61000-6-4	---	---	---	---	---	---	---	---	---	
IEC 61000-4-2	√	√	√	√	√	√	√	√	√	
IEC 61000-4-3	√	√	√	√	√	√	√	√	√	
IEC 61000-4-4	√	√	√	√	√	√	√	√	√	
IEC 61000-4-5	√	√	√	√	√	√	√	√	√	
IEC 61000-4-6	√	√	√	√	√	√	√	√	√	
IEC 61000-4-8	√	√	√	√	√	√	√	√	√	
IEC 61000-4-11	√	√	√	√	√	√	√	√	√	
IEC 61000-4-11 (DIPS)	---	---	---	---	---	---	---	---	---	
ENV5204	---	---	---	---	---	---	---	---	---	
Reliability										
Warranty	5 years (see www.moxa.com/warranty)									

3

Multiport Serial Boards > PCI Express Serial Boards

Universal PCI Serial Boards



	C320Turbo/PCI	C218Turbo/PCI	CP-118U CP-118U-T	CP-138U CP-138U-T	CP-118U-I CP-118U-I-T	CP-138U-I CP-138U-I-T	CP-168U CP-168U-T	CP-114UL CP-114UL-T	CP-114UL-I CP-114UL-I-T	CP-104UL CP-104UL-T
Hardware										
Comm. Controller	16C550C or compatible		MU860							
Bus	32-bit Universal PCI									
Connector	DB25 female	DB62 female				DB78 female	DB62 female	DB44 female		
Serial Interface										
RS-232 Ports	32	8	---	---	---	---	8	---	---	4
RS-422 Ports	---	---	---	---	---	---	---	---	---	---
RS-422/485 Ports	---	---	---	8	---	8	---	---	---	---
RS-232/422/485 Ports	---	---	8	---	8	---	---	4	4	---
Communication Parameters	Data Bits: 5, 6, 7, 8; Stop Bits: 1, 1.5, 2; Parity: None, Even, Odd, Space, Mark									
Flow Control	---	---	RTS/CTS, XON/XOFF				RTS/CTS, XON/XOFF			
Baudrate	50 bps to 460.8 Kbps	50 bps to 921.6 Kbps								
ESD Protection	---	Optional	15 KV	15 KV	15 KV	15 KV	15 KV	15 KV	15 KV	15 KV
Optical Isolation	---	Optional	---	---	2 KV	2 KV	Optional	---	2 KV	---
Driver Support										
Windows 9X/ME/NT	√	√	√	√	√	√	√	√	√	√
Windows 2000	√	√	√	√	√	√	√	√	√	√
Windows XP/2003/Vista x86/x64	√	√	√	√	√	√	√	√	√	√
Windows 2008 x86/x64	√	√	√	√	√	√	√	√	√	√
Windows CE 5.0	---	---	√	√	√	√	√	√	√	√
Windows CE 6.0	---	---	√	√	√	√	√	√	√	√
Windows XP Embedded	---	---	√	√	√	√	√	√	√	√
DOS	√	√	√	√	√	√	√	√	√	√
Linux 2.4/2.6	√	√	√	√	√	√	√	√	√	√
FreeBSD 4/5	---	---	√	√	√	√	√	√	√	√
QNX 4	√	√	---	---	---	---	---	---	---	---
QNX 6	√	√	√	√	√	√	√	√	√	√
SCO Open Server 5/6	√	√	√	√	√	√	√	√	√	√
UnixWare 7	√	√	√	√	√	√	√	√	√	√
Environmental Factors										
Dimensions (mm)	90 x 120	105 x 180	82 x 135	82 x 135	105 x 133	105 x 133	82 x 120	64.4 x 120	64.4 x 120	64.4 x 120
Operating Temperature	0 to 55°C	0 to 55°C	0 to 55°C, or -40 to 85°C	0 to 55°C, or -40 to 85°C	0 to 55°C, or -40 to 85°C	0 to 55°C, or -40 to 85°C	0 to 55°C, or -40 to 85°C	0 to 55°C, or -40 to 85°C	0 to 55°C, or -40 to 85°C	0 to 55°C, or -40 to 85°C
Operating Humidity	5 to 95% RH	5 to 95% RH	5 to 95% RH	5 to 95% RH	5 to 95% RH	5 to 95% RH	5 to 95% RH	5 to 95% RH	5 to 95% RH	5 to 95% RH
Storage Temperature	-20 to 85°C	-20 to 85°C	-20 to 85°C	-20 to 85°C	-20 to 85°C	-20 to 85°C	-20 to 85°C	-20 to 85°C	-20 to 85°C	-20 to 85°C
Regulatory Approvals										
FCC, Part 15 Class	A	A	B	B	B	B	B	B	B	B
EN55022 Class B	---	---	---	---	---	---	---	---	---	---
EN55022	---	---	---	---	√	√	√	√	√	√
EN55024	---	---	√	√	√	√	√	√	√	√
EN61000-3-2	---	---	√	√	√	√	√	√	√	√
EN61000-3-3	---	---	√	√	√	√	√	√	√	√
EN61000-6-2	---	---	√	√	---	---	---	---	---	---
EN61000-6-4	---	---	---	---	---	---	---	---	---	---
IEC 61000-4-2	√	√	√	√	√	√	√	√	√	√
IEC 61000-4-3	√	√	√	√	√	√	√	√	√	√
IEC 61000-4-4	√	√	√	√	√	√	√	√	√	√
IEC 61000-4-5	---	√	√	√	√	√	√	√	√	√
IEC 61000-4-6	---	√	√	√	√	√	√	√	√	√
IEC 61000-4-8	---	---	√	√	√	√	√	√	√	√
IEC 61000-4-11	---	---	---	---	---	---	---	---	---	---
IEC 61000-4-11 (DIPS)	---	√	√	√	√	√	√	√	√	√
ENV5204	√	√	---	---	---	---	---	---	---	---
Reliability										
Warranty	5 years (see www.moxa.com/warranty)									

Universal PCI Serial Boards



	CP-104JU CP-104JU-T	CP-134U CP-134U-T	CP-134U-I CP-134U-I-T	CP-112UL CP-112UL-T	CP-112UL-I CP-112UL-I-T	CP-102U CP-102U-T	CP-102UL CP-102UL-T	CP-132UL CP-132UL-T	CP-132UL-I CP-132UL-I-T	POS-104UL POS-104UL-T
Hardware										
Comm. Controller	MU860									
Bus	32-bit Universal PCI									
Connector	RJ45 x 4	DB44 female		DB25 female		DB9 male x 2	DB25 female			DB44 female
Serial Interface										
RS-232 Ports	4	---	---	---	---	2	2	---	---	4
RS-422 Ports	---	---	---	---	---	---	---	---	---	---
RS-422/485 Ports	---	4	4	---	---	---	---	2	2	---
RS-232/422/485 Ports	---	---	---	2	2	---	---	---	---	---
Communication Parameters	Data Bits: 5, 6, 7, 8; Stop Bits: 1, 1.5, 2; Parity: None, Even, Odd, Space, Mark									
Flow Control	RTS/CTS, XON/XOFF									
Baudrate	50 bps to 921.6 Kbps									
ESD Protection	15 KV	15 KV	15 KV	15 KV	15 KV	15 KV	15 KV	15 KV	15 KV	15 KV
Optical Isolation	---	---	2 KV	---	2 KV	---	---	---	2 KV	---
Driver Support										
Windows 9X/ME/NT	√	√	√	---	---	√	√	√	√	√
Windows 2000	√	√	√	√	√	√	√	√	√	√
Windows XP/2003/Vista x86/x64	√	√	√	√	√	√	√	√	√	√
Windows 2008 x86/x64	√	√	√	√	√	√	√	√	√	√
Windows CE 5.0	√	√	√	√	√	√	√	√	√	√
Windows CE 6.0	√	√	√	√	√	√	√	√	√	√
Windows XP Embedded	√	√	√	√	√	√	√	√	√	√
DOS	√	√	√	---	---	√	√	√	√	√
Linux 2.4/2.6	√	√	√	√	√	√	√	√	√	√
FreeBSD 4/5	√	√	√	---	---	√	√	√	√	√
QNX 4	---	---	---	---	---	---	---	---	---	---
QNX 6	√	√	√	---	---	√	√	√	√	√
SCO Open Server 5/6	√	√	√	√	√	√	√	√	√	√
UnixWare 7	√	√	√	√	√	√	√	√	√	√
Environmental Factors										
Dimensions (mm)	83 x 120	82.5 x 120	115 x 120	---	---	120 x 120	64.5 x 120	64.5 x 120	64.5 x 120	64.4 x 120
Operating Temperature	0 to 55°C, or -40 to 85°C	0 to 55°C, or -40 to 85°C	0 to 55°C, or -40 to 85°C	0 to 55°C, or -40 to 85°C	0 to 55°C, or -40 to 85°C	0 to 55°C, or -40 to 85°C	0 to 55°C	0 to 55°C, or -40 to 85°C	0 to 55°C, or -40 to 85°C	0 to 55°C, or -40 to 85°C
Operating Humidity	5 to 95% RH	5 to 95% RH	5 to 95% RH	5 to 95% RH	5 to 95% RH	5 to 95% RH	5 to 95% RH	5 to 95% RH	5 to 95% RH	5 to 95% RH
Storage Temperature	-20 to 85°C	-20 to 85°C	-20 to 85°C	-20 to 85°C	-20 to 85°C	-20 to 85°C	-20 to 85°C	-20 to 85°C	-20 to 85°C	-20 to 85°C
Regulatory Approvals										
FCC, Part 15 Class	B	B	B	B	B	B	B	B	B	B
EN55022 Class B	---	---	---	---	---	---	---	---	---	---
EN55022	√	√	√	√	√	√	√	√	√	√
EN55024	√	√	√	√	√	√	√	√	√	---
EN61000-3-2	√	√	√	√	√	√	√	√	√	√
EN61000-3-3	√	√	√	√	√	√	√	√	√	√
EN61000-6-2	---	---	---	---	---	---	---	---	---	√
EN61000-6-4	---	---	---	---	---	---	---	---	---	√
IEC 61000-4-2	√	√	√	√	√	√	√	√	√	√
IEC 61000-4-3	√	√	√	√	√	√	√	√	√	√
IEC 61000-4-4	√	√	√	√	√	√	√	√	√	√
IEC 61000-4-5	√	√	√	√	√	√	√	√	√	√
IEC 61000-4-6	√	√	√	√	√	√	√	√	√	√
IEC 61000-4-8	√	√	√	√	√	√	√	√	√	√
IEC 61000-4-11	---	---	---	---	---	---	---	---	---	---
IEC 61000-4-11 (DIPS)	√	√	√	√	√	√	√	√	√	√
ENV5204	---	---	---	---	---	---	---	---	---	---
Reliability										
Warranty	5 years (see www.moxa.com/warranty)									

3

Multiport Serial Boards > Universal PCI Serial Boards

Fiber Optic Serial Boards

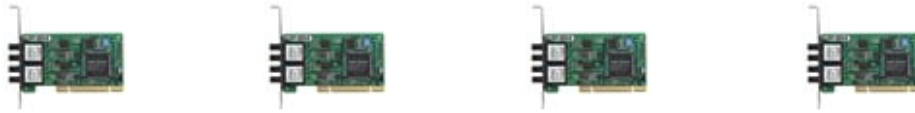

	CP-102UF-M-ST	CP-102UF-M-ST-T	CP-102UF-S-ST	CP-102UF-S-ST-T
Hardware				
Bus	32-bit Universal PCI			
Optical Fiber Interface				
Mode	Multi-mode		Single-mode	
Fiber Connectors	ST type			
Cable Requirements	50/125, 62.5/125, or 100/140 μm		8.3/125, 8.75/125, 9/125 or 10/140 μm	
Transmission Distance	Max. 5 km		Max. 40 km	
Wavelength	820 nm		1310 nm	
Tx Output	-5 dBm			
Rx Sensitivity	-20 dBm		-24 dBm	
Point-to-Point Transmission	Half or full duplex			
Ring Transmission	Half duplex			
Serial Interface				
Number of Ports	2	2	2	2
Communication Parameters	Data Bits: 5, 6, 7, 8; Stop Bits: 1, 1.5, 2; Parity: None, Even, Odd, Space, Mark			
Flow Control	XON/XOFF			
Baudrate	50 bps to 921.6 Kbps			
Driver Support				
Windows 9X/ME/NT	---	---	---	---
Windows 2000	√	√	√	√
Windows XP/2003/Vista x86/x64	√	√	√	√
Windows 2008 x86/x64	√	√	√	√
Windows CE 5.0	√	√	√	√
Windows CE 6.0	√	√	√	√
Windows XP Embedded	√	√	√	√
DOS	√	√	√	√
Linux 2.4/2.6	√	√	√	√
FreeBSD 4/5	---	---	---	---
QNX 4	---	---	---	---
QNX 6	√	√	√	√
SCO Open Server 5/6	√	√	√	√
UnixWare 7	√	√	√	√
Environmental Factors				
Dimensions (mm)	64.4 x 120	64.4 x 120	64.4 x 120	64.4 x 120
Operating Temperature	0 to 55°C	-40 to 85°C	0 to 55°C	-40 to 85°C
Operating Humidity	5 to 95% RH	5 to 95% RH	5 to 95% RH	5 to 95% RH
Storage Temperature	-20 to 85°C	-20 to 85°C	-20 to 85°C	-20 to 85°C
Regulatory Approvals				
FCC, Part 15 Class	B	B	B	B
EN55022 Class B	√	√	√	√
EN55022	---	---	---	---
EN55024	√	√	√	√
EN61000-3-2	√	√	√	√
EN61000-3-3	√	√	√	√
EN61000-6-2	---	---	---	---
EN61000-6-4	---	---	---	---
IEC 61000-4-2	√	√	√	√
IEC 61000-4-3	√	√	√	√
IEC 61000-4-4	√	√	√	√
IEC 61000-4-5	√	√	√	√
IEC 61000-4-6	√	√	√	√
IEC 61000-4-8	√	√	√	√
IEC 61000-4-11	---	---	---	---
IEC 61000-4-11 (DIPS)	√	√	√	√
ENV5204	---	---	---	---
Reliability				
Warranty	5 years (see www.moxa.com/warranty)			

ISA Serial Boards



	C320Turbo	C218Turbo	C168H	C168HS	C104H	C104HS
Hardware						
Comm. Controller	16C550C or compatible					
Bus	16-bit ISA					
Connector	DB25 female	DB62 female			DB37 female	
Serial Interface						
RS-232 Ports	32	8	8	8	4	4
RS-422 Ports	---	---	---	---	---	---
RS-422/485 Ports	---	---	---	---	---	---
RS-232/422/485 Ports	---	---	---	---	---	---
Communication Parameters	Data Bits: 5, 6, 7, 8; Stop Bits: 1, 1.5, 2; Parity: None, Even, Odd, Space, Mark					
Flow Control	---	---	---	---	---	---
Baudrate	50 bps to 460.8 Kbps	50 bps to 921.6 Kbps				
ESD Protection	---	Optional	---	25 KV	---	25 KV
Optical Isolation	---	Optional	Optional	Optional	---	---
Driver Support						
Windows 9X/ME/NT	√	√	√	√	√	√
Windows 2000	√	√	√	√	√	√
Windows XP/2003/Vista x86/x64	√	√	√	√	√	√
Windows 2008 x86/x64	√	√	√	√	√	√
Windows CE 5.0	---	---	---	---	---	---
Windows CE 6.0	---	---	---	---	---	---
Windows XP Embedded	---	---	√	√	√	√
DOS	√	√	√	√	√	√
Linux 2.4/2.6	√	√	√	√	√	√
FreeBSD 4/5	---	---	√	√	√	√
QNX 4	√	√	√	√	√	√
QNX 6	√	√	√	√	√	√
SCO Open Server 5/6	√	√	√	√	√	√
UnixWare 7	√	√	√	√	√	√
Environmental Factors						
Dimensions (mm)	107 x 158	105 x 180	93 x 157	93 x 157	83 x 157	83 x 157
Operating Temperature	0 to 55°C	0 to 55°C	0 to 55°C	0 to 55°C	0 to 55°C	0 to 55°C
Operating Humidity	5 to 95% RH	5 to 95% RH	5 to 95% RH	5 to 95% RH	5 to 95% RH	5 to 95% RH
Storage Temperature	-20 to 85°C	-20 to 85°C	-20 to 85°C	-20 to 85°C	-20 to 85°C	-20 to 85°C
Regulatory Approvals						
FCC, Part 15 Class	A	A	A	A	A	A
EN55022 Class B	---	---	---	---	---	---
EN55022	---	---	√	√	√	√
EN55024	---	---	---	---	---	---
EN61000-3-2	---	---	---	---	---	---
EN61000-3-3	---	---	---	---	---	---
EN61000-6-2	---	---	---	---	---	---
EN61000-6-4	---	---	---	---	---	---
IEC 61000-4-2	√	√	√	√	√	√
IEC 61000-4-3	√	√	√	√	√	√
IEC 61000-4-4	√	√	√	√	√	√
IEC 61000-4-5	---	√	---	---	---	---
IEC 61000-4-6	---	√	---	---	---	---
IEC 61000-4-8	---	---	---	---	---	---
IEC 61000-4-11	---	---	---	---	---	---
IEC 61000-4-11 (DIPS)	---	√	---	---	---	---
ENV5204	√	√	√	√	√	√
Reliability						
Warranty	5 years (see www.moxa.com/warranty)					

3

Multiport Serial Boards > ISA Serial Boards

ISA Serial Boards



	CI-134	CI-134I	CI-134IS	CI-132	CI-132I	CI-132IS
Hardware						
Comm. Controller	16C550C or compatible					
Bus	16-bit ISA					
Connector	DB37 female			DB9 male x 2		
Serial Interface						
RS-232 Ports	---	---	---	---	---	---
RS-422 Ports	---	---	---	---	---	---
RS-422/485 Ports	4	4	4	2	2	2
RS-232/422/485 Ports	---	---	---	---	---	---
Communication Parameters	Data Bits: 5, 6, 7, 8; Stop Bits: 1, 1.5, 2; Parity: None, Even, Odd, Space, Mark					
Flow Control	---	---	---	---	---	---
Baudrate	50 bps to 921.6 Kbps					
ESD Protection	---	---	25 KV	---	---	25 KV
Optical Isolation	---	2 KV	2 KV	---	2 KV	2 KV
Driver Support						
Windows 9X/ME/NT	√	√	√	√	√	√
Windows 2000	√	√	√	√	√	√
Windows XP/2003/Vista x86/x64	√	√	√	√	√	√
Windows 2008 x86/x64	√	√	√	√	√	√
Windows CE 5.0	---	---	---	---	---	---
Windows CE 6.0	---	---	---	---	---	---
Windows XP Embedded	√	√	√	√	√	√
DOS	√	√	√	√	√	√
Linux 2.4/2.6	√	√	√	√	√	√
FreeBSD 4/5	√	√	√	√	√	√
QNX 4	√	√	√	√	√	√
QNX 6	√	√	√	√	√	√
SCO Open Server 5/6	√	√	√	√	√	√
UnixWare 7	√	√	√	√	√	√
Environmental Factors						
Dimensions (mm)	85 x 160	110 x 180	110 x 180	75 x 157	105 x 157	105 x 157
Operating Temperature	0 to 55°C	0 to 55°C	0 to 55°C	0 to 55°C	0 to 55°C	0 to 55°C
Operating Humidity	5 to 95% RH	5 to 95% RH	5 to 95% RH	5 to 95% RH	5 to 95% RH	5 to 95% RH
Storage Temperature	-20 to 85°C	-20 to 85°C	-20 to 85°C	-20 to 85°C	-20 to 85°C	-20 to 85°C
Regulatory Approvals						
FCC, Part 15 Class	B	B	B	---	---	---
EN55022 Class B	---	---	---	---	---	---
EN55022	√	√	√	√	√	√
EN55024	---	---	---	---	---	---
EN61000-3-2	---	---	---	---	---	---
EN61000-3-3	---	---	---	---	---	---
EN61000-6-2	---	---	---	---	---	---
EN61000-6-4	---	---	---	---	---	---
IEC 61000-4-2	√	√	√	√	√	√
IEC 61000-4-3	√	√	√	√	√	√
IEC 61000-4-4	√	√	√	√	√	√
IEC 61000-4-5	---	---	---	---	---	---
IEC 61000-4-6	---	---	---	---	---	---
IEC 61000-4-8	---	---	---	---	---	---
IEC 61000-4-11	---	---	---	---	---	---
IEC 61000-4-11 (DIPS)	---	---	---	---	---	---
ENV5204	√	√	√	√	√	√
Reliability						
Warranty	5 years (see www.moxa.com/warranty)					

3

Multiport Serial Boards > ISA Serial Boards

PC/104 Modules



	CA-108 CA-108-T	CA-114 CA-114-T	CA-134I CA-134I-T	CA-104 CA-104-T	CA-132 CA-132-T	CA-132I CA-132I-T
Hardware						
Comm. Controller	16C550C or compatible					
Bus	PC/104 bus					
Box Header Connector	40-pin	40-pin	40-pin	40-pin	20-pin	20-pin
Serial Interface						
RS-232 Ports	8	---	---	4	---	---
RS-422 Ports	---	---	---	---	---	---
RS-422/485 Ports	---	---	4	---	2	2
RS-232/422/485 Ports	---	4	---	---	---	---
Communication Parameters	Data Bits: 5, 6, 7, 8; Stop Bits: 1, 1.5, 2; Parity: None, Even, Odd, Space, Mark					
Flow Control	---	---	---	---	---	---
Baudrate	50 bps to 921.6 Kbps					
ESD Protection	15 KV	15 KV	15 KV	15 KV	15 KV	15 KV
Optical Isolation	---	---	2 KV	---	---	2 KV
Driver Support						
Windows 9X/ME/NT	√	√	√	√	√	√
Windows 2000	√	√	√	√	√	√
Windows XP/2003/Vista x86/x64	√	√	√	√	√	√
Windows 2008 x86/x64	---	---	---	---	---	---
Windows CE 5.0	√	√	√	√	√	√
Windows CE 6.0	√	√	√	√	√	√
Windows XP Embedded	√	√	√	√	√	√
DOS	√	√	√	√	√	√
Linux 2.4/2.6	√	√	√	√	√	√
FreeBSD 4/5	---	---	---	---	---	---
QNX 4	√	√	√	√	√	√
QNX 6	√	√	√	√	√	√
SCO Open Server 5/6	---	---	---	---	---	---
UnixWare 7	---	---	---	---	---	---
Environmental Factors						
Dimensions (mm)	90 x 96	90 x 96	90 x 96	90 x 96	90 x 96	90 x 96
Operating Temperature	0 to 55°C, or -40 to 85°C	0 to 55°C, or -40 to 85°C	0 to 55°C, or -40 to 85°C	0 to 55°C, or -40 to 85°C	0 to 55°C, or -40 to 85°C	0 to 55°C, or -40 to 85°C
Operating Humidity	5 to 95% RH	5 to 95% RH	5 to 95% RH	5 to 95% RH	5 to 95% RH	5 to 95% RH
Storage Temperature	-40 to 55°C	-40 to 55°C	-40 to 55°C	-40 to 55°C	-40 to 55°C	-40 to 55°C
Regulatory Approvals						
FCC, Part 15 Class	A	A	A	A	A	A
EN55022 Class B	---	---	---	---	---	---
EN55022	√	√	√	√	√	√
EN55024	√	√	√	√	√	√
EN61000-3-2	√	√	√	√	√	√
EN61000-3-3	√	√	√	√	√	√
EN61000-6-2	√	√	√	√	√	√
EN61000-6-4	√	√	√	√	√	√
IEC 61000-4-2	√	√	√	√	√	√
IEC 61000-4-3	√	√	√	√	√	√
IEC 61000-4-4	√	√	√	√	√	√
IEC 61000-4-5	√	√	√	√	√	√
IEC 61000-4-6	√	√	√	√	√	√
IEC 61000-4-8	√	√	√	√	√	√
IEC 61000-4-11	---	---	---	---	---	---
IEC 61000-4-11 (DIPS)	√	√	√	√	√	√
ENV5204	---	---	---	---	---	---
Reliability						
Warranty	5 years (see www.moxa.com/warranty)					

3

Multiport Serial Boards > PC/104 Modules

PC/104-Plus Modules



	CB-108 CB-108-T	CB-114 CB-114-T	CB-134I CB-134I-T
Hardware			
Comm. Controller	MU860 (16C550C compatible)		
Bus	PC/104-Plus bus		
Box Header Connector	40-pin	40-pin	40-pin
Serial Interface			
RS-232 Ports	8	---	---
RS-422 Ports	---	---	---
RS-422/485 Ports	---	---	4
RS-232/422/485 Ports	---	4	---
Communication Parameters	Data Bits: 5, 6, 7, 8; Stop Bits: 1, 1.5, 2; Parity: None, Even, Odd, Space, Mark		
Flow Control	---	---	---
Baudrate	50 bps to 921.6 Kbps		
ESD Protection	15 KV	15 KV	15 KV
Optical Isolation	---	---	2 KV
Driver Support			
Windows 9X/ME/NT	---	---	---
Windows 2000	√	√	√
Windows XP/2003/Vista x86/x64	√	√	√
Windows 2008 x86/x64	√	√	√
Windows CE 5.0	√	√	√
Windows CE 6.0	√	√	√
Windows XP Embedded	√	√	√
DOS	√	√	√
Linux 2.4/2.6	√	√	√
FreeBSD 4/5	---	---	---
QNX 4	---	---	---
QNX 6	√	√	√
SCO Open Server 5/6	---	---	---
UnixWare 7	---	---	---
Environmental Factors			
Dimensions (mm)	90 x 96	90 x 96	90 x 96
Operating Temperature	0 to 55°C, or -40 to 85°C	0 to 55°C, or -40 to 85°C	0 to 55°C, or -40 to 85°C
Operating Humidity	5 to 95% RH	5 to 95% RH	5 to 95% RH
Storage Temperature	-40 to 55°C	-40 to 55°C	-40 to 55°C
Regulatory Approvals			
FCC, Part 15 Class	A	A	A
EN55022 Class B	---	---	---
EN55022	√	√	√
EN55024	√	√	√
EN61000-3-2	√	√	√
EN61000-3-3	√	√	√
EN61000-6-2	√	√	√
EN61000-6-4	√	√	√
IEC 61000-4-2	√	√	√
IEC 61000-4-3	√	√	√
IEC 61000-4-4	√	√	√
IEC 61000-4-5	√	√	√
IEC 61000-4-6	√	√	√
IEC 61000-4-8	√	√	√
IEC 61000-4-11	---	---	---
IEC 61000-4-11 (DIPS)	√	√	√
ENV5204	---	---	---
Reliability			
Warranty	5 years (see www.moxa.com/warranty)		

USB-to-Serial Converters



	UPort™ 1110	UPort™ 1130	UPort™ 1150	UPort™ 1150I	UPort™ 1250	UPort™ 1250I	UPort™ 1410	UPort™ 1450	UPort™ 1450I
USB Interface									
Compliance	USB 1.0/1.1 compliant, USB 2.0 compatible				USB 1.1/2.0 compliant				
Connector	USB type A			USB type B					
Speed	12 Mbps (Full-Speed USB)				480 Mbps (Hi-Speed USB) and 12 Mbps (Full-Speed USB)				
Serial Interface									
Number of Ports	1 x RS-232	1 x RS-422/485	1 x RS-232/422/485	1 x RS-232/422/485	2 x RS-232/422/485	2 x RS-232/422/485	4 x RS-232	4 x RS-232/422/485	4 x RS-232/422/485
Connector	DB9 male	DB9 male	DB9 male	DB9 male	DB9 male	DB9 male	DB9 male	DB9 male	DB9 male
Communication Parameters	Data Bits: 5, 6, 7, 8; Stop Bits: 1, 1.5, 2; Parity: None, Even, Odd, Space, Mark								
Flow Control	Flow Control: RTS/CTS, XON/XOFF								
FIFO	64 bytes	64 bytes	64 bytes	64 bytes	128 bytes	128 bytes	128 bytes	128 bytes	128 bytes
Baudrate	50 bps to 921.6 Kbps								
Embedded ESD Protection	15 KV								
Optical Isolation	---	---	---	2 KV	---	2 KV	---	---	2 KV
Driver Support									
Windows 98/ME	√	√	√	√	---	---	---	---	---
Windows 2000	√	√	√	√	√	√	√	√	√
Windows XP/2003 x86/x64	√	√	√	√	√	√	√	√	√
Windows Vista x86/x64	√	√	√	√	√	√	√	√	√
Windows 2008 x86/x64	---	---	---	---	---	---	---	---	---
WinCE 5.0/6.0	√	√	√	√	√	√	√	√	√
Linux 2.4	√	√	√	√	√	√	√	√	√
Linux 2.6 x86/x64	√	√	√	√	√	√	√	√	√
Physical Characteristics									
Housing	ABS + PC			SECC sheet metal (1 mm), IP30 protection					
Product Weight	65 g			75 g	180 g		720 g		
Packaged Weight	200 g			370 g	370 g	680 g	1320 g		
Dimensions (mm)	38.4 x 60 x 20			52 x 80 x 22	77 x 26 x 111		204 x 30 x 125		
Environmental Limits									
Operating Temperature	0 to 55°C	0 to 55°C	0 to 55°C	0 to 55°C	0 to 55°C	0 to 55°C	0 to 55°C	0 to 55°C	0 to 55°C
Operating Humidity	5 to 95% RH	5 to 95% RH	5 to 95% RH	5 to 95% RH	5 to 95% RH	5 to 95% RH	5 to 95% RH	5 to 95% RH	5 to 95% RH
Storage Temperature	-20 to 70°C	-20 to 70°C	-20 to 70°C	-20 to 70°C	-20 to 70°C	-20 to 70°C	-20 to 70°C	-20 to 70°C	-20 to 70°C
Regulatory Approvals									
EMI	FCC Part 15 Class B, EN61000-6-4				FCC, Part 15 Class A, EN61000-6-4				
Safety	---	---	---	---	UL, CUL, TÜV				
EMS	EN55022 Class B, EN55024, EN61000-3-2, EN61000-3-3, EN61000-4-2, EN61000-4-3, EN61000-4-4, EN61000-4-5, EN61000-4-6, EN61000-4-8, EN61000-4-11, EN61000-6-2				EN55022 Class A, EN55024, EN61000-3-2, EN61000-3-3, EN61000-4-2, EN61000-4-3, EN61000-4-4, EN61000-4-5, EN61000-4-6, EN61000-4-8, EN61000-4-11, EN61000-6-2				
Power Requirements									
Power Consumption	30 mA @ 5 VDC	90 mA @ 5 VDC	77 mA @ 5 VDC	260 mA @ 5 VDC	360 mA @ 5 VDC	200 mA @ 12 VDC	290 mA @ 5 VDC	260 mA @ 12 VDC	360 mA @ 12 VDC
Reliability									
Warranty	5 years (see www.moxa.com/warranty)								

3

Industrial USB > USB-to-Serial Converters

USB-to-Serial Converters



	UPort™ 1610-8	UPort™ 1650-8	UPort™ 1610-16	UPort™ 1650-16	UPort™ 2210	UPort™ 2410	UPort™ 2230	UPort™ 2430
USB Interface								
Compliance	USB 1.0/1.1/2.0 compliant				USB 1.1/2.0 compliant			
Connector	USB type B							
Speed	480 Mbps (Hi-Speed USB) and 12 Mbps (Full-Speed USB)							
Serial Interface								
Number of Ports	8 x RS-232	8 x RS-232/422/485	16 x RS-232	16 x RS-232/422/485	2 x RS-232	4 x RS-232	2 x RS-422/485	4 x RS-422/485
Connector	DB9 male	DB9 male	DB9 male	DB9 male	DB9 male	DB9 male	DB9 male	DB9 male
Communication Parameters	Data Bits: 5, 6, 7, 8; Stop Bits: 1, 1.5, 2; Parity: None, Even, Odd, Space, Mark							
Flow Control	RTS/CTS, XON/XOFF							
FIFO	128 bytes	128 bytes	128 bytes	128 bytes	16 bytes	16 bytes	16 bytes	16 bytes
Baudrate	50 bps to 921.6 Kbps							
Embedded ESD Protection	15 KV	15 KV	15 KV	15 KV	15 KV	15 KV	15 KV	15 KV
Optical Isolation	---	---	---	---	---	---	---	---
Driver Support								
Windows 98/ME	---	---	---	---	---	---	---	---
Windows 2000	√	√	√	√	√	√	√	√
Windows XP/2003 x86/x64	√	√	√	√	√	√	√	√
Windows Vista x86/x64	√	√	√	√	√	√	√	√
Windows 2008 x86/x64	---	---	---	---	√	√	√	√
WinCE 5.0/6.0	√	√	√	√	---	---	---	---
Linux 2.4	√	√	√	√	√	√	---	---
Linux 2.6 x86/x64	√	√	√	√	√	√	√	√
Physical Characteristics								
Housing	SECC sheet metal (1 mm), IP30 protection				Polycarbonate (PC)			
Product Weight	835 g	835 g	2475 g	2475 g	120 g	210 g	---	---
Packaged Weight	1440 g	1440 g	3440 g	3440 g	325 g	455 g	---	---
Dimensions (mm)	204 x 44 x 125	204 x 44 x 125	440 x 45.5 x 198.1	440 x 45.5 x 198.1	70 x 35 x 120	80 x 35 x 185	70 x 35 x 120	80 x 35 x 185
Environmental Limits								
Operating Temperature	0 to 55°C	0 to 55°C	0 to 55°C	0 to 55°C	0 to 55°C	0 to 55°C	0 to 55°C	0 to 55°C
Operating Humidity	5 to 95% RH	5 to 95% RH	5 to 95% RH	5 to 95% RH	5 to 95% RH	5 to 95% RH	5 to 95% RH	5 to 95% RH
Storage Temperature	-20 to 70°C	-20 to 70°C	-20 to 70°C	-20 to 70°C	-20 to 70°C	-20 to 70°C	-20 to 70°C	-20 to 70°C
Regulatory Approvals								
EMI	FCC Part 15 Class A, EN61000-6-4				FCC Part 15 Class B, EN61000-6-4			
Safety	UL, CUL, TÜV				---			
EMS	EN55022 Class A, EN55024, EN61000-3-2, EN61000-3-3, EN61000-4-2, EN61000-4-3, EN61000-4-4, EN61000-4-5, EN61000-4-6, EN61000-4-8, EN61000-4-11, EN61000-6-2				EN55022 Class B, EN55024, EN61000-3-2, EN61000-3-3, EN61000-4-2, EN61000-4-3, EN61000-4-4, EN61000-4-5, EN61000-4-6, EN61000-4-8, EN61000-4-11, EN61000-6-2			
Power Requirements								
Power Consumption	230 mA @ 12 VDC	340 mA @ 12 VDC	130 mA @ 100 VAC	150 mA @ 100 VAC	140 mA @ 5 VDC	240 mA @ 5 VDC	---	---
Reliability								
Warranty	5 years (see www.moxa.com/warranty)							

USB Hubs



	UPort™ 404	UPort™ 407	UPort™ 404-T	UPort™ 407-T	UPort™ 204	UPort™ 207
USB Interface						
Compliance	USB 1.1/2.0 compliant					
Upstream USB Ports	1 (Type B)					
Downstream USB Ports	4 (Type A)	7 (Type A)	4 (Type A)	7 (Type A)	4 (Type A)	7 (Type A)
Speed	480 Mbps (Hi-Speed USB) and 12 Mbps (Full-Speed USB)					
Supply Current	500 mA max. per channel					
Physical Characteristics						
Housing	Aluminum				Polycarbonate (PC)	
Dimensions (mm)	80 x 35 x 130	100 x 35 x 192	80 x 35 x 130	100 x 35 x 192	80 x 35 x 130	100 x 35 x 195
Environmental Limits						
Operating Temperature	0 to 60°C	0 to 60°C	-40 to 85°C	-40 to 85°C	0 to 60°C	0 to 60°C
Operating Humidity	5 to 95% RH	5 to 95% RH	5 to 95% RH	5 to 95% RH	5 to 95% RH	5 to 95% RH
Storage Temperature	-20 to 75°C	-20 to 75°C	-40 to 85°C	-40 to 85°C	-20 to 75°C	-20 to 75°C
Regulatory Approvals						
EMI	FCC, Part 15 Class A, EN61000-6-4					
Safety	UL508, LVD					
EMS	EN61000-3-2, EN61000-3-3, EN61000-4-2, EN61000-4-3, EN61000-4-4, EN61000-4-5, EN61000-4-6, EN61000-4-8, EN61000-4-11, EN61000-6-2					
Power Requirements						
Power Consumption	1300 mA @ 12 VDC	2300 mA @ 12 VDC	1300 mA @ 12 VDC	2300 mA @ 12 VDC	1210 mA @ 12 VDC	2170 mA @ 12 VDC
Reliability						
Warranty	5 years (see www.moxa.com/warranty)					

3

Industrial USB > USB Hubs

Chassis Media Converters



	TRC-190-AC TRC-190-DC	TCF-142-M-SC-RM TCF-142-M-ST-RM	TCF-142-S-SC-RM TCF-142-S-ST-RM
Optical Fiber Side			
Fiber Connector	---	SC or ST	SC or ST
Cables Requirements	---	50/125, 62.5/125, or 100/140 μm	8.3/125, 8.7/125, 9/125, or 10/125 μm
Transmission Distance	---	5 km	40 km
Wavelength	---	850 nm	1310 nm
Tx Output	---	> -5 dBm	> -5 dBm
Rx Sensitivity	---	-20 dBm	-25 dBm
Point-to-Point Transmission	---	Point-to-Point Transmission: Half-duplex or full-duplex	Point-to-Point Transmission: Half-duplex or full-duplex
RS-232/422/485 Side			
Connector	---	Terminal Block	
RS-232 Signals	---	TxD, RxD, SGND	
RS-422 Signals	---	TxD+, TxD-, RxD+, RxD-, SGND	
RS-485-4w Signals	---	TxD+, TxD-, RxD+, RxD-, SGND	
RS-485-2w Signals	---	Data+, Data-, SGND	
Baudrate	---	50 bps to 921.6 Kbps	
ESD Protection	---	15 KV	15 KV
Physical Characteristics			
Housing	SECC (1.2 mm)	SPCC	SPCC
Dimensions (mm)	440 x 260 x 77 mm	86.8 x 136.5 x 21 mm	86.8 x 136.5 x 21 mm
Weight	5.2 kg (11.4 lbs), with one power module installed	---	---
Installation	---	---	---
Number of Slots	19 slots in the front for slide-in modules, 2 slots in the back for power supply modules	---	---
Environmental Limits			
Operating Temperature	0 to 60°C	0 to 60°C	0 to 60°C
Operating Humidity	5 to 95% RH	5 to 95% RH	5 to 95% RH
Storage Temperature	-20 to 75°C	-20 to 75°C	-20 to 75°C
Power Requirements			
Input Voltage	Universal 100 to 240 VAC (47 to 63 Hz)	12 VDC	12 VDC
Power Consumption	5.4 A @ 12 V (max. output) or 12 to 48 VDC	150 mA @ 12 V	150 mA @ 12 V
Regulatory Approvals			
CE	Class B	Class B	
FCC	Part 15 sub part B Class A	Part 15 sub part B Class A	
EMI	EN55022 1998, Class B	---	---
EMS	EN61000-4-2 (ESD), Criteria A, Level 4 EN61000-4-3 (RS), Criteria A, Level 2 EN61000-4-4 (EFT), Criteria A, Level 3 EN61000-4-5 (Surge), Criteria A, Level 3 EN61000-4-6 (CS), Criteria A, Level 2 EN61000-4-8 (PFMF), Criteria A, Level 3 EN61000-4-11 (DIPS), Criteria A	EN61000-4-2 (ESD), Criteria A, Level 4 EN61000-4-3 (RS), Criteria A, Level 2 EN61000-4-4 (EFT), Criteria A, Level 3 EN61000-4-5 (Surge), Criteria A, Level 3 EN61000-4-6 (CS), Criteria A, Level 2 EN61000-4-8 (PFMF), Criteria A, Level 3	
Freefall	---	IEC 60068-2-32	
Reliability			
Warranty	5 years (see www.moxa.com/warranty)		

Serial-to-Fiber Media Converters



	ICF-1150-M-SC/ST ICF-1150-M-SC/ST-T	ICF-1150I-M-SC/ST ICF-1150I-M-SC/ST-T	ICF-1150-S-SC/ST ICF-1150-S-SC/ST-T	ICF-1150I-S-SC/ST ICF-1150I-S-SC/ST-T	TCF-142-M-SC/ST TCF-142-M-SC/ST-T	TCF-142-S-SC/ST TCF-142-S-SC/ST-T	TCF-90-M/S
Optical Fiber Side							
Fiber Connector	SC or ST		SC or ST		SC or ST		ST
Cables Requirements	Single-mode: 8.3/125, 8.7/125, 9/125, or 10/125 μ m Multi-mode: 50/125, 62.5/125, or 100/140 μ m						
Transmission Distance	Single-mode: 40 km Multi-mode: 5 km						
Wavelength	Single-mode: 1310 nm Multi-mode: 850 nm						
Tx Output	Single-mode: > -5 dBm Multi-mode: > -5 dBm						
Rx Sensitivity	Single-mode: -25 dBm Multi-mode: -20 dBm						
Point-to-Point Transmission	Half-duplex or full-duplex						---
Multi-drop Transmission	Half-duplex, fiber ring						---
Ring Transmission	---	---	---	---	Half-duplex		---
RS-232 Side							
Connector	---	---	---	---	---	---	DB9 female
Signals	---	---	---	---	---	---	Tx, Rx, GND (Loop-back wiring: RTS to CTS, DTR to DSR and DCD)
Baudrate	---	---	---	---	---	---	300 bps to 115.2 Kbps
RS-232/422/485 Side							
Connector	---	---	---	---	Terminal Block		---
RS-232 Signals	TxD, RxD, SGND						
RS-422 Signals	TxD+, TxD-, RxD+, RxD-, SGND						
RS-485-4w Signals	TxD+, TxD-, RxD+, RxD-, SGND						
RS-485-2w Signals	Data+, Data-, SGND						
Baudrate	50 bps to 921.6 Kbps						
ESD Protection	15 KV for all signals						
Isolation	2 KV RMS isolation per I/O port for 1 minute				---	---	---
Physical Characteristics							
Housing	Aluminum (1 mm)						ABS + PC
Dimensions (mm)	30.3 x 70 x 115				67 x 100 x 22 mm		42 x 80 x 22 mm
Environmental Limits							
Operating Temperature	0 to 60°C or -40 to 85°C						0 to 60°C
Operating Humidity	5 to 95% RH						5 to 95% RH
Storage Temperature	-40 to 85°C						-20 to 75°C
Power Requirements							
Source of Input Power	---	---	---	---	---	---	RS-232 port (TxD signal) or power input jack
Input Voltage	12 to 48 VDC				12 to 48 VDC		12 to 48 VDC
Power Consumption	127 mA @ 12 V	163 mA @ 12 V			140 mA @ 12 V		20 mA @ 5 V (with termination disabled)
Burst Protection (EFT)	4 KV				2 KV		---
Surge Protection	2 KV				2 KV		---
Voltage Reversal Protection	Protects against V+/V- reversal				Protects against V+/V- reversal		---
Over Current Protection	1.1 A				1.1 A		---
Regulatory Approvals							
CE	Class B				---	---	Class B
FCC	Part 15 sub Class B				Part 15 Subclass B		Class B
Safety	UL 508				---	---	---
UL/CUL	---				UL60950-1		---
EMI	EN55022 1998, Class B				EN55022 1998, Class B		---
EMS	EN61000-4-2 (ESD), Criteria A, Level 4				EN61000-4-2 (ESD), Criteria A, Level 3		---
	EN61000-4-3 (RS), Criteria A, Level 3				EN61000-4-3 (RS), Criteria A, Level 2		
	EN61000-4-4 (EFT), Criteria A, Level 4				EN61000-4-4 (EFT), Criteria A, Level 2		
	EN61000-4-5 (Surge), Criteria A, Level 3				EN61000-4-5 (Surge), Criteria A, Level 3		
	EN61000-4-6 (CS), Criteria A, Level 3				EN61000-4-6 (CS), Criteria A, Level 2		
ATEX	Class 1, Zone 2, EEx nC IIC (pending)				---	---	---
Hazardous Location	UL/cUL Class 1, Div. 2, Group A, B, C and D (Pending)				---	---	---
TÜV	EN 60950-1				EN60950-1		---
Freefall	IEC 60068-2-32				---	---	---
Water and Dust Proof	IP30				---	---	---
Reliability							
Warranty	5 years (see www.moxa.com/warranty)						

3

Media Converters > Serial-to-Fiber Media Converters

Serial Converters and Repeaters



	TCC-100 TCC-100-T	TCC-100I TCC-100I-T	TCC-80	TCC-80I	TCC-120	TCC-120I	TCC-82
RS-232 Side							
Connector	DB9 female		DB9 female		---	---	---
Signals	TxD, RxD, RTS, CTS, DTR, DSR, DCD, GND		TxD, RxD, RTS, CTS, DTR, DSR, DCD, GND (Loop-back wiring: RTS to CTS, DTR to DSR and DCD)		---	---	---
RS-422/485 Side							
Connector	Terminal Block		Terminal Block or DB9 male		---	---	---
Signals	(interface selected by DIP switch) RS-422: TxD+, TxD-, RxD+, RxD-, GND RS-485-4w: TxD+, TxD-, RxD+, RxD-, GND RS-485-2w Signals: Data+, Data-, GND		(interface selected by DIP switch) RS-422: TxD+, TxD-, RxD+, RxD-, GND RS-485-4w: TxD+, TxD-, RxD+, RxD-, GND RS-485-2w Signals: Data+, Data-, GND		---	---	---
RS-485 Data Direction Control	---	---	ADDC®		---	---	---
Serial Communication							
Connectors	---	---	---	---	Terminal Block on both ends		DB9 male/female
Baudrate	50 bps to 921.6 Kbps		50 bps to 921.6 Kbps		50 bps to 921.6 Kbps		50 bps to 921.6 Kbps
Signals	---	---	---	---	RS-422/485-4w: TxD+, TxD-, RxD+, RxD- RS-485-2w: Data+, Data-		RS-232: TxD, RxD, RTS, CTS (Loop-back wiring: DTR to DSR and DCD)
RS-485 Data Direction Control	---	---	---	---	ADDC®		---
Pull High Resistance	150K ohm or 1K ohm (default)						
Pull Low Resistance	150K ohm or 1K ohm (default)						
ESD Protection	15 KV		15 KV		15 KV for all signals		15 KV for all signals
Optical Isolation	---	2 KV	---	2.5 KV rms for 1 minute	---	2 KV for power and signal	4 KV for 1 minute
Physical Characteristics							
Housing	Aluminum		ABS + PC		Aluminum		ABS
Dimensions (mm)	67 x 100.4 x 22 mm		42 x 80 x 22 mm		67 x 100.4 x 22 mm		42 x 80 x 23.6 mm
Weight	148 ± 5 g		50 ± 5 g		148 ± 5 g		60 ± 5 g
Environmental Limits							
Operating Temperature	-20 to 60°C, or -40 to 85°C		0 to 60°C		-20 to 60°C		0 to 60°C
Operating Humidity	5 to 95% RH		5 to 95% RH		5 to 95% RH		5 to 95% RH
Storage Temperature	-20 to 85°C		-20 to 75°C		-20 to 85°C		-20 to 75°C
Power Requirements							
Source of Input Power	Power input jack		RS-232 port (TxD, RTS, DTR) or power input jack		RS-232 port (TxD signal) or power input jack		RS-232 port (TxD signal) or power input jack
Input Voltage	12 to 48 VDC		5 to 12 VDC		12 to 48 VDC		5 to 12 VDC
Power Consumption	300 mA @ 12 V	400 mA @ 12 V	10 mA @ 5 V (with termination disabled)	20 mA @ 5 V (with termination disabled)	98 mA @ 12 V, 1.18 W	234 mA @ 12 V, 2.81 W	20 mA @ 5 V
Connection	---	---	---	---	---	---	---
Overload Current Protection	---	---	---	---	---	---	---
Reverse Polarity Protection	---	---	---	---	---	---	---
Burst Protection (EFT)	---	---	---	---	---	---	---
Surge Protection	---	---	---	---	---	---	---
Voltage Reversal Protection	Protects against V+/V- reversal		---	---	Protects against V+/V- reversal		---
Over Current Protection	√	√	---	---	√	√	---
Regulatory Approvals							
CE	Class B		Class B		Class B		Class B
FCC	Class B		Class B		Class B		Class B
Reliability							
Warranty	5 years (see www.moxa.com/warranty)						

3
 Media Converters > Serial Converters and Repeaters

Ethernet-to-Fiber Media Converters

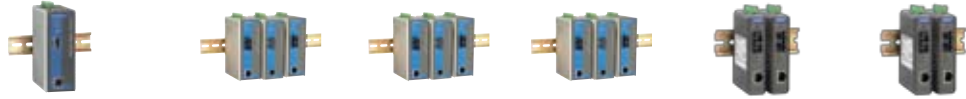

	IMC-101G INC-101G-T	IMC-101-M-SC/ST IMC-101-M-SC/ST-T	IMC-101-S-SC IMC-101-S-SC-T	IMC-101-S-SC-80 IMC-101-S-SC-80-T	IMC-21-M-SC/ST	IMC-21-S-SC
IEEE Standards						
IEEE 802.3	√	√	√	√	√	√
IEEE 802.3u	√	√	√	√	√	√
IEEE 802.3ab	√	---	---	---	---	---
IEEE 802.3z	√	---	---	---	---	---
IEEE 802.3x	---	---	---	---	√	√
Interface						
RJ45 Ports	10/100/1000BaseT(X)		10/100BaseT(X)		10/100BaseT(X)	
Fiber Ports	Optional 1000BaseSX/LX/LHX/ZX (LC connector)		100BaseFX (SC or ST connectors)		100BaseFX (SC or ST)	
LED Indicators	PWR1, PWR2, FAULT, 10/100M (TP port), 1000M (TP and Fiber port)		PWR1, PWR2, FAULT, 10/100M (TP port), 100M (Fiber port), FDX/COL (Fiber port)		Power, 10/100M (TP port), 100M (fiber port), FDX/COL (fiber port)	
DIP Switches	Port break alarm mask Fault Pass-Through Fiber AN/Force		100BaseFX Full/Half duplex selection, port break alarm mask		TP port's 10/100M, Half/Full modes, and Force/Auto modes, fiber connection's Full/Half mode, Link Fault Pass-Through (LFP)	
Alarm Contact	One relay output with current carrying capacity of 1 A @ 24 VDC		One relay output with current carrying capacity of 1A @ 24 VDC		---	
Multi-mode Transmission Distance						
1000BaseSX	• 0 to 500 m, 850 nm (50/125 μm, 400 MHz*km) • 0 to 275 m, 850 nm (62.5/125 μm, 200 MHz*km)		---	---	---	---
1000BaseLX	• 0 to 1100 m, 1310 nm (50/125 μm, 800 MHz*km) • 0 to 550 m, 1310 nm (62.5/125 μm, 500 MHz*km)		---	---	---	---
Single-mode Transmission Distance						
1000BaseLX	0 to 10 km, 1310 nm (9/125 μm, 3.5 PS/(nm*km))				---	---
1000BaseLHX	0 to 40 km, 1310 nm (9/125 μm, 3.5 PS/(nm*km))				---	---
1000BaseZX	0 to 80 km, 1550 nm (9/125 μm, 19 PS/(nm*km))				---	---
Physical Characteristics						
Housing	Metal (IP30)		Metal (IP30)		Plastic (IP30)	
Dimensions (mm)	53.6 x 135 x 105 mm		53.6 x 135 x 105 mm		25 x 109 x 97 mm	
Weight	630 g		630 g		125 g	
Installation	DIN-Rail mounting, wall mounting (with optional kit)				DIN-Rail mounting	
Environmental Limits						
Operating Temperature	0 to 60°C or -40 to 75°C				0 to 60°C	
Operating Humidity	5 to 95% RH				5 to 95% RH	
Storage Temperature	-40 to 85°C				-40 to 70°C	
Power Requirements						
Input Voltage	24 VDC (12 to 45 VDC), redundant inputs				12 to 45 VDC, 18 to 30 VAC (47-63 Hz)	
Input Current	0.11A (@ 24 V)		0.16A (@ 24 V)		0.15 A (@ 24 V)	
Connection	Removable terminal block				Removable 3-contact terminal block	
Overload Current Protection	1.1 A				1.1 A	
Reverse Polarity Protection	√	√	√	√	√	√
Regulatory Approvals						
Safety	UL508		UL508 UL60950-1 CSA C22.2 No. 60950-1 EN60950-1		UL508 UL60950-1 CSA C22.2 No. 60950-1 EN60950-1	
EMI	FCC Part 15, CISPR (EN55022) class A				FCC Part 15, CISPR (EN55022) class A	
EMS	EN61000-4-2 (ESD), level 3 EN61000-4-3 (RS), level 3 EN61000-4-4 (EFT), level 3 EN61000-4-5 (Surge), level 3 EN61000-4-6 (CS), level 3 EN61000-4-8 EN61000-4-11				EN61000-4-2 (ESD) EN61000-4-3 (RS) EN61000-4-4 (EFT) EN61000-4-5 (Surge) EN61000-4-6 (CS)	
Hazardous Location	---		UL/cUL Class1, Division 2, Groups A, B, C, and D, ATEX Class1, Zone 2, Ex nC IIC (IMC-101-M-ST, IMC-101-S-SC-80 pending)		---	
Freefall	IEC60068-2-32				IEC60068-2-32	
Shock	IEC60068-2-27				IEC60068-2-27	
Vibration	IEC60068-2-6				IEC60068-2-6	
Maritime	---		DNV, GL		---	
MTBF	500,000 hrs		401,000 hrs		353,000 hrs	
Reliability						
Warranty	5 years (see www.moxa.com/warranty)					

Industrial AP/Bridge/Client Solutions



	AWK-4222-T	AWK-4121-T	AWK-3222 AWK-3222-T	AWK-3121 AWK-3121-T
WLAN				
IEEE Standards	IEEE 802.11a/b/g/i, IEEE 802.3a/u, IEEE 802.3af			
Spread Spectrum and Modulation (typical)	<ul style="list-style-type: none"> • DSSS with DBPSK, DQPSK, CCK • OFDM with BPSK, QPSK, 16QAM, 64QAM 64QAM @ 54Mbps, 16QAM @ 24/36Mbps, QPSK @ 12/18Mbps CCK @ 11/5.5Mbps, DQPSK @ 2Mbps, DBSK@ 1Mbps 			
Operating Channels (central frequency)	US: 2.412 to 2.462 GHz (11 channels); 5.18 to 5.24 GHz (4 channels) EU: 2.412 to 2.472 GHz (13 channels); 5.18 to 5.24 GHz (4 channels) JP: 2.412 to 2.472 GHz (13 channels, OFDM); 2.412 to 2.484 GHz (14 channels, DSSS); 5.18 to 5.24 GHz (4 channels for W52)			
Number of RF modules	2	1	2	1
Interfaces				
Number of Antenna Connectors	4	2	4	2
Antenna Connector Type	N-type (female)	N-type (female)	RP-SMA (female)	RP-SMA (female)
10/100BaseT(X) LAN Port	2	1	2	1
RS-232 Console Port	1, waterproof RJ-45	1, waterproof RJ-45	1, RJ-45	1, RJ-45
LED Indicators	PWR, FAULT, STATE, WLAN1, WLAN2, LAN1, LAN2	PWR, FAULT, STATE, WLAN, LAN	PWR1, PWR2, PoE, FAULT, STATE, WLAN1, WLAN2, 10M, 100M	PWR1, PWR2, PoE, FAULT, STATE, signal strength, CLIENT MODE, BRIDGE MODE, WLAN, 10M, 100M
Alarm Contact (Digital Output)	1	1	1	1
Digital Inputs	2	2	2	2
DI/DO Connector Type	8-pin M12 (A-coding)		10-pin terminal block	
Physical Characteristics				
Housing	Metal (IP67)	Metal (IP67)	Metal (IP30)	Metal (IP30)
Weight	1.22 kg	1.2 kg	880 g	850 g
Dimensions	224 x 147.7 x 66.5 mm		62.05 x 135 x 105 mm	53.6 x 135 x 105 mm
Installation	Wall mounting (standard), DIN-Rail mounting (optional), pole mounting (optional)	Wall mounting (standard), DIN-Rail mounting (optional), pole mounting (optional)	DIN-Rail mounting (standard), Wall mounting (optional)	DIN-Rail mounting (standard), Wall mounting (optional)
Environmental Limits				
Operating Temperature	-40 to 75°C	-40 to 75°C	0 to 60°C or -40 to 75°C	0 to 60°C or -40 to 75°C
Operating Humidity	5% to 95%	5% to 95%	5% to 95%	5% to 95%
Storage Temperature	-40 to 85°C	-40 to 85°C	-40 to 85°C	-40 to 85°C
Power Requirements				
Input Voltage	Redundant dual power inputs (12 to 48 VDC)			
Connector	5-pin M12 (A-coding)		10-pin terminal block	
IEEE 802.3af 48 VDC PoE	√	√	√	√
Reverse Polarity Protection	√	√	√	√
Regulatory Approvals				
Radio	EN300 328, EN301 893, ARIB STD-33/T66/T71 (Japan)			
EMC	EN301 489-1/-17, FCC Part 15, EN55022, EN55024	EN301 489-1/-17, FCC Part 15, EN55022, EN55024, IEC61000-6-2/-4	EN301 489-1/-17, FCC Part 15, EN55022, EN55024	EN301 489-1/-17, FCC Part 15, EN55022, EN55024, IEC61000-6-2/-4
Safety	---	EN60950-1, UL60950-1	---	EN60950-1, UL60950-1
Environment/EMC compliance	---	EN50155, EN50121-4	---	EN50155, EN50121-4
Reliability				
Warranty	5 years (see www.moxa.com/warranty)			

Wireless Serial Device Servers



	NPort® W2004	NPort® W2150 Plus NPort® W2150 Plus-T	NPort® 2250 Plus NPort® 2250 Plus-T
WLAN Interface			
IEEE 802.11b/g	√	---	---
IEEE 802.11a/g/b	---	√	√
Radio Frequency Type	DSSS/OFDM	DSSS/OFDM	DSSS/OFDM
WEP	64/128-bit data encryption		
WPA, WPA2, 802.11i	Enterprise mode and Pre-Share Key (PSK) mode		
Encryption	---	128-bit TKIP/AES-CCMP EAP-TLS, PEAP/GTC, PEAP/MD5, PEAP/MSCHAPV2, EAP-TTLS/PAP, EAP-TTLS/CHAP, EAP-TTLS/MSCHAP, EAP-TTLS/MSCHAPV2, EAP-TTLS/EAP-MSCHAPV2, EAP-TTLS/EAP-GTC, EAP-TTLS/EAP-MD5, LEAP	
Max. Transmission Rate	54 Mbps	54 Mbps	54 Mbps
Max. Transmission Distance	300 m	100 m	100 m
LAN Interface			
Ethernet Ports	1 x 10/100 Mbps (RJ45)	1 x 10/100 Mbps (RJ45)	1 x 10/100 Mbps (RJ45)
1.5 KV Magnetic Isolation Protection	√	√	√
Serial Interface			
Number of Ports	4	1	2
Serial Standards	RS-232/422/485	RS-232/422/485	RS-232/422/485
Connector	RJ45	DB9-M	DB9-M
Console Port	√	---	---
Serial Communication Parameters	Data Bits: 5, 6, 7, 8; Stop Bits: 1, 1.5, 2; Parity: None, Even, Odd, Space, Mark	Data Bits: 5, 6, 7, 8; Stop Bits: 1, 1.5, 2; Parity: None, Even, Odd, Space, Mark	Data Bits: 5, 6, 7, 8; Stop Bits: 1, 1.5, 2; Parity: None, Even, Odd, Space, Mark
Flow Control	RTS/CTS, XON/XOFF, DTR/DSR	RTS/CTS, XON/XOFF	RTS/CTS, XON/XOFF
Baudrate	50 bps to 460.8 Kbps	50 bps to 921.6 Kbps	50 bps to 921.6 Kbps
Serial Data Log	64 KB	64 KB	64 KB
Software			
Network Protocols	ICMP, IP, TCP, UDP, DHCP, Telnet, DNS, SNMP V1/V2c, HTTP, SMTP, SNTp, SSH, HTTPS		
Configuration Options	Web Console, Serial Console, Telnet Console, Windows Utility		
Management	---	SNMP MIB-II	SNMP MIB-II
Secure Configuration Options	HTTPS, SSH	HTTPS, SSH	HTTPS, SSH
Utilities	NPort® Search Utility and NPort® Windows Driver manager		
Windows Real COM Drivers	Windows 95, 98, ME, NT, 2000, XP x86/x64, 2003 x86/x64, Vista x86/x64, 2008 x86/x64, Embedded CE 5.0/6.0, XP Embedded		
Fixed TTY Drivers	SCO Unix, SCO OpenServer, UnixWare 7, UnixWare 2.1, SVR 4.2, QNX 4.25, QNX 6, Solaris 10, FreeBSD, AIX 5.x, HP-UX 11i		
Linux Real TTY Drivers	Linux 2.4.x/2.6.x		
Physical Characteristics			
Housing	Metal (IP30)	Aluminum	
Weight	1730 g	780 g	
Dimensions	45.8 x 135 x 105 mm	77 x 111 x 26 mm	
Environmental Limits			
Operating Temperature	0 to 60°C	0 to 55°C or -40 to 75°C	
Operating Humidity	5% to 95%	5% to 95%	
Storage Temperature	-20 to 85°C	-40 to 85°C	
Power Requirements			
Input Voltage	12 to 48 VDC	12 to 48 VDC	
Power Consumption	685 mA @ 12 V, 340 mA @ 24 V, 185 mA @ 48 V	560 mA @ 12 V, 294 mA @ 24 V, 162 mA @ 48 V	
Regulatory Approvals			
Safety	UL (UL60950-1), TÜV (EN60950-1)	UL (UL60950-1), TÜV (EN60950-1)	
Radio	CE (ETSI EN 300 328)	CE (ETSI EN 301 893, ETSI EN 300 328), ARIB RCR STD-33, ARIB STD-66	
EMC	CE (EN55022 and EN55024 Class A, ETSI EN 301 489-17, ETSI EN 301 489-1)	CE (EN55022 and EN55024 Class A, ETSI EN 301 489-17, ETSI EN 301 489-1)	
EMI	FCC (Part 15 Subpart B Class A, Subpart C)	FCC Part 15 (Subpart B Class A, Subpart C, Subpart E), VCCI	
Reliability			
MTBF	81,501 hrs	352,547 hrs	352,034 hrs
Warranty	5 years (see www.moxa.com/warranty)		

3

WLAN & Cellular Solutions > Wireless Serial Device Servers

Cellular Routers and IP Gateways



	OnCell 5004-HSDPA	OnCell 5104-HSDPA	OnCell 5004	OnCell 5104	OnCell G3110-HSDPA	OnCell G3150-HSDPA	OnCell G3110	OnCell G3150
Cellular Interface								
Standards	UMTS/HSDPA		GSM/GPRS		UMTS/HSDPA		GSM/GPRS/EDGE	
Tri-band Options	850/1900/2100 MHz		---		850/1900/2100 MHz		---	
Quad-band Options	850/900/1800/1900 MHz		850/900/1800/1900 Mhz		850/900/1800/1900 MHz			
EDGE Multi-slot	Class 10	Class 10	---		Class 10	Class 10	Class 12	Class 12
EDGE Terminal Device	Class B	Class B	---		Class B	Class B	Class B	Class B
GPRS Multi-slot	Class 10	Class 10	Class 10	Class 10	Class 10	Class 10	Class 12	Class 12
GPRS Terminal Device	Class B	Class B	Class B	Class B	Class B	Class B	Class B	Class B
GPRS Coding Schemes	CS1 to CS4	CS1 to CS4	CS1 to CS4	CS1 to CS4	CS1 to CS4	CS1 to CS4	CS1 to CS4	CS1 to CS4
WAN Interface								
Number of Ports	1	1	1	1	---	---	---	---
Ethernet	10/100M (RJ45)	10/100M (RJ45)	10/100M (RJ45)	10/100M (RJ45)	---	---	---	---
Isolation	1.5 KV Magnetic Isolation Protection				---	---	---	---
LAN Interface								
Number of Ports	4	4	4	4	1	1	1	1
Ethernet	10/100M (RJ45)	10/100M (RJ45)	10/100M (RJ45)	10/100M (RJ45)	10/100M (RJ45)	10/100M (RJ45)	10/100M (RJ45)	10/100M (RJ45)
Isolation	1.5 KV Magnetic Isolation Protection				---	---	---	---
SIM Interface								
Number of SIMs	2	2	2	2	1	1	1	1
SIM Control	3 V	3 V	3 V	3 V	3 V	3 V	3 V	3 V
Serial Interface								
Number of Ports	---	---	---	---	1	1	1	1
Serial Standards	---	---	---	---	RS-232	RS-232/422/485	RS-232	RS-232/422/485
Connector	---	---	---	---	DB9-M	DB9-M and TB	DB9-M	DB9-M and TB
15 KV ESD Protection	---	---	---	---	√	√	√	√
2 KV Power EFT/Surge	---	---	---	---	√	√	√	√
Serial Parameters	---	---	---	---	Data Bits: 5, 6, 7, 8; Stop Bits: 1, 1.5, 2; Parity: None, Even, Odd, Space, Mark			
Flow Control	---	---	---	---	RTS/CTS, XON/XOFF			
Baudrate	---	---	---	---	50 bps to 921.6 Kbps			
I/O Interface								
Alarm Contacts	---	1	---	1	1	1	1	1
Digital Inputs	---	2	---	2	2	2	2	2
Software								
Network Protocols	UDP/TCP, SNMP, ICMP, DDNS, DHCP/BOOTP, PPPoE, PPP, DNS Relay, HTTPS, Telnet				ICMP, TCP/IP, UDP, DHCP, Telnet, DNS, SNMP, HTTP, SMTP, HTTPS, SNMP, ARP, SSL			
Router/Firewall	NAT, port forwarding, routing				NAT, port forwarding			
Authentication	Local user-name and password				Local user-name and password			
Security	IP filtering				Accessible IP list			
Operation Modes	---	---	---	---	Real COM, Secure Real COM, TCP Server, Secure TCP Server, TCP Client, Secure TCP Client, UDP, RFC2217, Ethernet Modem, Virtual Modem, SMS Tunnel			
Configuration and Management Options	---	---	---	---	SNMP MIB-II, SNMP Private MIB, SNMPv1/v2c/v3, DDNS, IP Report, Web/Telnet/Serial-Console/SSH			
Utilities	---	---	---	---	Provided for Windows 95/98/ME, Windows NT, Windows 2000/XP/2003/Vista/Server-2008, Windows XP/2003/Vista/Server-2008 x64 Edition			
Windows Real COM Drivers	---	---	---	---	Windows 95/98/ME, Windows NT, Windows 2000/XP/2003/Vista/Server 2008, Windows XP/2003/Vista/Server 2008 x64 Edition			
Fixed TTY Drivers	---	---	---	---	SCO Unix, SCO OpenServer 5, SCO OpenServer 6, UnixWare 7, SVR4.2, QNX 4.25, QNX 6, Solaris 10, FreeBSD 5, FreeBSD 6			
Linux Real TTY Drivers	---	---	---	---	Linux kernels 2.2.x, 2.4.x, 2.6.x			
OnCell Central	---	---	---	---	Centralized management solution for accessing private IPs from the Internet			
Physical Characteristics								
Housing	Aluminum (IP30)	Aluminum (IP30)	Aluminum (IP30)	Aluminum (IP30)	Aluminum (IP30)			
Weight	505±5 g	645±5 g	505±5 g	645±5 g	440±5 g			
Dimensions (mm)	158 x 103 x 34	160 x 103 x 50	158 x 103 x 34	160 x 103 x 50	28 x 126 x 93			
Environmental Limits								
Operating Temperature	-30 to 55°C	-30 to 55°C	-30 to 55°C	-30 to 55°C	-30 to 55°C	-30 to 55°C	-30 to 55°C	-30 to 55°C
Operating Humidity	5% to 95%	5% to 95%	5% to 95%	5% to 95%	5% to 95%	5% to 95%	5% to 95%	5% to 95%
Storage Temperature	-40 to 75°C	-40 to 75°C	-40 to 75°C	-40 to 75°C	-40 to 75°C	-40 to 75°C	-40 to 75°C	-40 to 75°C
Power Requirements								
Input Voltage	12 to 48 VDC	12 to 48 VDC	12 to 48 VDC	12 to 48 VDC	12 to 48 VDC	12 to 48 VDC	12 to 48 VDC	12 to 48 VDC
Connector	1 TB, 1 power jack	2 TBs	1 TB, 1 power jack	2 TBs	2 TBs	2 TBs	2 TBs	2 TBs
Regulatory Approvals								
Safety	UL (UL60950-1)							
RF	FCC part22H, FCC PART24F, EN301 489-1, EN301 489-7, EN301 511							
PTCRB	---	---	---	---	---	V	---	V
EMC	CE: EN55022 Class A / EN55024. FCC: FCC part 15 subpart B. Class A, EN61000-4-2 (ESD) Level 4, EN61000-4-3 (RS) Level 3, EN61000-4-4 (EFT) Level 4, EN61000-4-5 (Surge) Level 3, EN61000-4-8 Level 3, EN61000-4-12 Level 3							
Reliability								
Warranty	5 years (see www.moxa.com/warranty)							

Cellular IP and GSM/GPRS Modems



	OnCell G3111	OnCell 3151	OnCell 3211	OnCell 3251	OnCell G2100 OnCell G2100-T	OnCell G2150I
Cellular Interface						
Standards	GSM/GPRS	GSM/GPRS	GSM/GPRS	GSM/GPRS	GSM/GPRS	GSM/GPRS
Quad-band Options	850/900/1800/1900 MHz					
GPRS Multi-slot Class	Class 10	Class 10	Class 10	Class 10	Class 10	Class 10
GPRS Terminal Device Class	Class B	Class B	Class B	Class B	Class B	Class B
GPRS Coding Schemes	CS1 to CS4	CS1 to CS4	CS1 to CS4	CS1 to CS4	CS1 to CS4	CS1 to CS4
LAN Interface						
Number of Ports	1	1	1	1	---	---
Ethernet	10/100 Mbps (RJ45)	10/100 Mbps (RJ45)	10/100 Mbps (RJ45)	10/100 Mbps (RJ45)	---	---
1.5 KV Magnetic Isolation Protection	√	√	√	√	---	---
SIM Interface						
Number of SIMs	1	1	1	1	1	1
SIM Control	3 V	3 V	3 V	3 V	3 V	3 V
Serial Interface						
Number of Ports	1	1	2	2	1	1
Serial Standards	RS-232	RS-232/422/485	RS-232	RS-232/422/485	RS-232	RS-232/422/485
Connector	DB9-M	DB9-M	DB9-M	DB9-M	DB9-F	DB9-F and 5-pin TB
15 KV ESD Protection	√	√	√	√	√	√
2.5 KV Optical Isolation	---	---	---	---	---	√
2 KV Power EFT/Surge	√	√	√	√	---	---
Serial Communication Parameters	Data Bits: 5, 6, 7, 8; Stop Bits: 1, 1.5, 2; Parity: None, Even, Odd, Space, Mark				Data Bits: 7, 8; Stop Bits: 1, 2; Parity: None, Even, Odd, Space, Mark	
Flow Control	RTS/CTS, XON/XOFF				RTS/CTS	
Baudrate	50 bps to 921.6 Kbps				300 bps to 115.2 Kbps	
Software						
Network Protocols	ICMP, TCP/IP, UDP, DHCP, Telnet, DNS, SNMP, HTTP, HTTPS, SMTP, Sntp, ARP				---	---
Authentication	Local user-name and password				---	---
Security	Accessible IP list				---	---
Operation Modes	Real COM, TCP Server, TCP Client, UDP, SMS Tunnel, Reverse Real COM				---	---
Configuration and Management Options	SNMP MIB-II, v3, DDNS, IP Report, Web/Telnet/Serial Console, Serial Logging				---	---
Utilities	Provided for Windows 95/98/ME, Windows NT, Windows 2000/XP/2003/Vista/Server-2008, Windows XP/2003/Vista/Server-2008 x64				---	---
Windows Real COM Drivers	Windows 95/98/ME, Windows NT, Windows 2000/XP/2003/Vista/Server-2008, Windows XP/2003/Vista/Server-2008 x64				---	---
Management Software						
OnCell Central	Centralized management solution for accessing private IPs from the Internet				---	---
Physical Characteristics						
Housing	Aluminum (IP30)				ABS + PC (IP30)	
Weight	165±5 g		185±5 g		150 ± 5 g	
Dimensions	111 x 77 x 26 mm				27 x 123 x 79 mm	
Environmental Limits						
Operating Temperature	-30 to 55°C	-30 to 55°C	-30 to 55°C	-30 to 55°C	0 to 55°C or -30 to 75°C	0 to 55°C
Operating Humidity	5% to 95%	5% to 95%	5% to 95%	5% to 95%	5% to 95%	5% to 95%
Storage Temperature	-40 to 75°C	-40 to 75°C	-40 to 75°C	-40 to 75°C	-40 to 75°C	-40 to 75°C
Power Requirements						
Input Voltage	12 to 48 VDC	12 to 48 VDC	12 to 48 VDC	12 to 48 VDC	12 to 48 VDC	12 to 48 VDC
Connector	1 power jack	1 power jack	1 power jack	1 power jack	1 power jack	1 power jack
Regulatory Approvals						
Safety	UL (UL60950-1)					
RF	FCC part22H, FCC PART24F, EN301 489-1, EN301 489-7, EN301 511					
EMC	CE: EN55022 Class A / EN55024 FCC: FCC part 15 subpart B, Class A EN61000-4-2 (ESD) EN61000-4-3 (RS) EN61000-4-4 (EFT) EN61000-4-5 (Surge) EN61000-4-8 EN61000-4-12				CE (EN55022 Class A, EN55024) FCC part 15 subpart B Class A	
Reliability						
Warranty	5 years (see www.moxa.com/warranty)					

3

WLAN & Cellular Solutions > Cellular IP and GSM/GPRS Modems

Wallmount Computers



	V462-CE V462-T-CE	V462-XPE V462-T-XPE	V464-CE V464-T-CE	V464-XPE V464-T-XPE	V466-CE V466-T-CE	V466-XPE V466-T-XPE	V468-CE V468-T-CE	V468-XPE V468-T-XPE	V481-CE V481-T-CE	V481-XPE V481-T-XPE
Computer										
CPU Speed	500 MHz	500 MHz	500 MHz	500 MHz	500 MHz	500 MHz	500 MHz	500 MHz	1 GHz	1 GHz
OS (pre-installed)	WinCE 6.0	WinXP Emb.	WinCE 6.0	WinXP Emb.	WinCE 6.0	WinXP Emb.	WinCE 6.0	WinXP Emb.	WinCE 5.0	WinXP Emb.
DRAM	---	---	---	---	---	---	---	---	---	---
SRAM	256 KB	256 KB	256 KB	256 KB	256 KB	256 KB	256 KB	256 KB	---	---
FSB	400 MHz	400 MHz	400 MHz	400 MHz	400 MHz	400 MHz	400 MHz	400 MHz	400 MHz	400 MHz
Flash	---	---	---	---	---	---	---	---	---	---
System Memory	256 MB (1 GB max.)	512 MB (1 GB max.)	256 MB (1 GB max.)	512 MB (1 GB max.)	256 MB (1 GB max.)	512 MB (1 GB max.)	256 MB (1 GB max.)	512 MB (1 GB max.)	256 MB (1 GB max.)	512 MB (1 GB max.)
PCMCIA	√	√	---	---	---	---	---	---	---	---
Expansion Bus	PC/104-Plus onboard									
USB Ports	4 (USB 2.0)	4 (USB 2.0)	4 (USB 2.0)	4 (USB 2.0)	4 (USB 2.0)	4 (USB 2.0)	4 (USB 2.0)	4 (USB 2.0)	2 (USB 2.0)	2 (USB 2.0)
Digital I/O	---	---	---	---	---	---	8 DIs, 8 DOs	8 DIs, 8 DOs	---	---
Storage										
Built-in	256 MB	1 GB	256 MB	1 GB	256 MB	1 GB	256 MB	1 GB	256 MB	1 GB
CompactFlash Socket	√	√	√	√	√	√	√	√	√	√
SD Slot	---	---	---	---	---	---	---	---	---	---
Other Peripherals										
KB/MS	1 PS/2 interface supporting standard PS/2 keyboard and mouse through Y-type cable									
Audio	AC97 audio, with speaker-out interface									
Display										
Graphics Controller	√	√	√	√	√	√	√	√	√	√
Mini Screen with Push Buttons	---	---	---	---	---	---	---	---	---	---
LAN Interface										
10/100 Mbps Ethernet Ports	2	2	4	4	4	4	4	4	1	1
10/100/1000 Mbps Ethernet Ports	---	---	---	---	---	---	---	---	1	1
Switch Ports	---	---	---	---	8	8	---	---	---	---
Controller	Realtek RTL8100CL									
Magnetic Isolation Protection	1.5 KV	1.5 KV	1.5 KV	1.5 KV	1.5 KV	1.5 KV	1.5 KV	1.5 KV	1.5 KV	1.5 KV
Serial Interface										
RS-232 Ports	2 (DB9 male)	2 (DB9 male)	2 (DB9 male)	2 (DB9 male)	2 (DB9 male)	2 (DB9 male)	2 (DB9 male)	2 (DB9 male)	---	---
RS-485	---	---	---	---	---	---	---	---	---	---
RS-232/422/485 Ports	2 (DB9-M)	2 (DB9-M)	2 (DB9-M)	2 (DB9-M)	2 (DB9-M)	2 (DB9-M)	2 (DB9-M)	2 (DB9-M)	8 (DB9-M)	8 (DB9-M)
ESD Protection	15 KV	15 KV	15 KV	15 KV	15 KV	15 KV	15 KV	15 KV	15 KV	15 KV
Digital Isolation	---	---	---	---	---	---	---	---	---	---
Console Port	---	---	---	---	---	---	---	---	---	---
Serial Communication Parameters	Data Bits: 5, 6, 7, 8; Stop Bits: 1, 1.5, 2; Parity: None, Even, Odd, Space, Mark									
Flow Control	RTS/CTS, XON/XOFF, ADDC®									
Baudrate	50 bps to 921.6 Kbps (non-standard baudrates supported)									
CANbus	---	---	---	---	---	---	---	---	---	---
LEDs										
System	Power, Battery, Storage								Power, Storage	
LAN	10M, 100M	10M, 100M	10M, 100M	10M, 100M	10M, 100M, Switch	---	10M, 100M	10M, 100M	10M, 100M	10M, 100M
Serial	---	---	---	---	---	---	---	---	---	---
Physical Characteristics										
Housing	Aluminum	Aluminum	Aluminum	Aluminum	Aluminum	Aluminum	Aluminum	Aluminum	Aluminum	Aluminum
Weight	1.32 kg	1.32 kg	1.32 kg	1.32 kg	1.32 kg	1.32 kg	1.32 kg	1.32 kg	2.2 kg	2.2 kg
Dimensions	223 x 120.5 x 57 mm								225 x 140 x 70 mm	
Mounting	DIN-Rail, wall	DIN-Rail, wall	DIN-Rail, wall	DIN-Rail, wall	DIN-Rail, wall	DIN-Rail, wall	DIN-Rail, wall	DIN-Rail, wall	DIN-Rail, wall	DIN-Rail, wall
Environmental Limits										
Operating Temperature	-10 to 60°C or -40 to 75°C								-10 to 60°C or -35 to 75°C	
Operating Humidity	5 to 95% RH									
Storage Temperature	-20 to 80°C or -40 to 85°C									
Anti Vibration/Shock	---	---	---	---	---	---	---	---	---	---
Regulatory Approvals										
EMC	CE (EN55022 Class A, EN61000-3-2 Class A, EN61000-3-3, EN55024), FCC (Part 15 Subpart B, CISPR 22 Class A), CCC (GB9254, GB 17625.1)									
Safety	UL/cUL (UL60950-1, CSA C22.2 No. 60950-1-03), LVD, CCC (GB4943)								UL/cUL (UL60950-1, CSA C22.2 No. 60950-1-03), LVD (EN60950-1), CCC (GB4943)	
Green Product	---	---	RoHS, WEEE							
Reliability										
Buzzer, RTC, WDT	√	√	√	√	√	√	√	√	√	√
Warranty	5 years (see www.moxa.com/warranty)									

3 Embedded Computers for Communication > Wallmount Computers

Wallmount Computers



	UC-8410-LX UC-8410-T-LX	UC-8416-LX UC-8416-T-LX	UC-8418-LX UC-8418-T-LX	UC-7402-LX	UC-7402-LX Plus	UC-7408-LX UC-7408-T-LX	UC-7408-LX Plus UC-7408-T-LX Plus	UC-7408-CE UC-7408-T-CE	UC-7410-LX	UC-7410- LX Plus
Computer										
CPU Speed	533 MHz	533 MHz	533 MHz	266 MHz	533 MHz	266 MHz	533 MHz	266 MHz	266 MHz	533 MHz
OS (pre-installed)	Linux			Embedded Linux				WinCE 5.0	Embedded Linux	
DRAM	256 MB	256 MB	256 MB	256 MB	256 MB	256 MB	256 MB	256 MB	256 MB	256 MB
SRAM	---	---	---	---	---	---	---	---	---	---
FSB	---	---	---	---	---	---	---	---	---	---
Flash	16 MB (OS); 32 MB (data)	16 MB (OS); 32 MB (data)	16 MB (OS); 32 MB (data)	32 MB	32 MB	32 MB	32 MB	32 MB	32 MB	32 MB
System Memory	---	---	---	---	---	---	---	---	---	---
PCMCIA	---	---	---	√	√	√	√	√	---	---
Expansion Bus	---	---	---	---	---	---	---	---	---	---
USB Ports	---	---	---	---	---	---	---	---	---	---
Digital I/O	4 DIs, 4 DOs	4 DIs, 4 DOs	12 DIs, 12 DOs	---	---	8 DIs, 8 DOs	8 DIs, 8 DOs	8 DIs, 8 DOs	---	---
Storage										
Built-in	---	---	---	---	---	---	---	---	---	---
CompactFlash Socket	√	√	√	√	√	√	√	√	---	---
SD Slot	---	---	---	---	---	---	---	---	---	---
Other Peripherals										
KB/MS	---	---	---	---	---	---	---	---	---	---
Audio	---	---	---	---	---	---	---	---	---	---
Display										
Graphics Controller	---	---	---	---	---	---	---	---	---	---
Mini Screen with Push Buttons	---	---	---	---	---	---	---	---	√	√
LAN Interface										
10/100 Mbps Ethernet Ports	3	3	3	2	2	2	2	2	2	2
10/100/1000 Mbps Ethernet Ports	---	---	---	---	---	---	---	---	---	---
Switch Ports	---	8	---	---	---	---	---	---	---	---
Controller	---	---	---	---	---	---	---	---	---	---
Magnetic Isolation Protection	1.5 KV	1.5 KV	1.5 KV	1.5 KV	1.5 KV	1.5 KV	1.5 KV	1.5 KV	1.5 KV	1.5 KV
Serial Interface										
RS-232 Ports	---	---	---	---	---	---	---	---	---	---
RS-485	---	---	---	---	---	---	---	---	---	---
RS-232/422/485 Ports	8 (RJ45)	8 (RJ45)	8 (RJ45)	---	---	8 (RJ45)	8 (RJ45)	8 (RJ45)	8 (RJ45)	8 (RJ45)
ESD Protection	15 KV	15 KV	15 KV	15 KV	15 KV	15 KV	15 KV	15 KV	15 KV	15 KV
Digital Isolation	---	---	---	---	---	---	---	---	---	---
Console Port	√	√	√	√	√	√	√	√	√	√
Serial Communication Parameters	Data Bits: 5, 6, 7, 8; Stop Bits: 1, 1.5, 2; Parity: None, Even, Odd, Space, Mark			---		Data Bits: 5, 6, 7, 8; Stop Bits: 1, 1.5, 2; Parity: None, Even, Odd, Space, Mark				
Flow Control	RTS/CTS, XON/XOFF, ADDC@			---		RTS/CTS, XON/XOFF, ADDC@				
Baudrate	50 bps to 921.6 Kbps (non-standard baudrates supported)			---		50 bps to 921.6 Kbps (non-standard baudrates supported)				
CANbus	---	---	2 (DB9-M)	---	---	---	---	---	---	---
LEDs										
System	Power, Ready, Storage, Battery			OS Ready						
LAN	10M, 100M			10M, 100M						
Serial	TxD, RxD			TxD, RxD						
Physical Characteristics										
Housing	SECC sheet metal (1 mm)									
Weight	850 g	930 g	1 kg	830 g	830 g	870 g	870 g	870 g	810 g	810 g
Dimensions	200 x 36.5 x 120 mm		200 x 56 x 120 mm		197 x 44 x 125 mm					
Mounting	DIN-Rail, wall			DIN-Rail, wall						
Environmental Limits										
Operating Temperature	-10 to 60°C or -40 to 75°C			-10 to 60°C		-10 to 60°C or -40 to 75°C			-10 to 60°C	
Operating Humidity	5 to 95% RH			5 to 95% RH		5 to 95% RH			5 to 95% RH	
Storage Temperature	-20 to 80°C or -40 to 85°C			-20 to 80°C		-20 to 80°C			-20 to 80°C	
Anti Vibration/Shock	1g/5g	1g/5g	1g/5g	1g/5g	1g/5g	1g/5g	1g/5g	1g/5g	1g/5g	1g/5g
Regulatory Approvals										
EMC	CE (EN55022 Class B, EN55024-4-2, EN55024-4-3, EN55024-4-4), FCC (Part 15 Subpart B, Class B)			CE (EN55022 Class A, EN61000-3-2 Class A, EN61000-3-3, EN55024), FCC (Part 15 Subpart B, CISPR 22 Class A)						
Safety	UL/cUL (UL60950-1), CCC, LVD			UL/cUL (UL60950-1, CSA C22.2 No. 60950-1-03), TÜV (EN60950-1)						
Green Product	RoHS, CRoHS, WEEE									
Reliability										
Buzzer, RTC, WDT	√	√	√	√	√	√	√	√	√	√
Warranty	5 years (see www.moxa.com/warranty)									

3

Embedded Computers for Communication > Wallmount Computers

Wallmount Computers



	UC-7420-LX	UC-7420-LX Plus	UC-7410-CE	UC-7420-CE	UC-7122-CE UC-7122-T-CE	UC-7124-CE UC-7124-T-CE	UC-7110-LX UC-7110-T-LX	UC-7112-LX	UC-7112-LX Plus	UC-7101-LX UC-7101-T-LX	
Computer											
CPU Speed	266 MHz	533 MHz	266 MHz	533 MHz	200 MHz	200 MHz	192 MHz	192 MHz	192 MHz	192 MHz	
OS (pre-installed)	Embedded Linux			WinCE 5.0			µClinux	Linux	Linux	µClinux	
DRAM	128 MB	128 MB	128 MB	128 MB	32 MB	32 MB	16 MB	16 MB	32 MB	16 MB	
SRAM	---	---	---	---	---	---	---	---	---	---	
FSB	---	---	---	---	---	---	---	---	---	---	
Flash	32 MB	32 MB	32 MB	32 MB	16 MB	16 MB	8 MB	8 MB	16 MB	8 MB	
System Memory	---	---	---	---	---	---	---	---	---	---	
PCMCIA	√	√	---	√	---	---	---	---	---	---	
Expansion Bus	---	---	---	---	---	---	---	---	---	---	
USB Ports	---	---	---	---	---	---	---	---	---	---	
Digital I/O	---	---	---	---	---	---	---	---	---	---	
Storage											
Built-in	---	---	---	---	---	---	---	---	---	---	
CompactFlash Socket	√	√	---	√	---	---	---	---	---	---	
SD Slot	---	---	---	---	√	√	---	√	√	√	
Other Peripherals											
KB/MS	---	---	---	---	---	---	---	---	---	---	
Audio	---	---	---	---	---	---	---	---	---	---	
Display											
Graphics Controller	---	---	---	---	---	---	---	---	---	---	
Mini Screen with Push Buttons	√	√	√	√	---	---	---	---	---	---	
LAN Interface											
10/100 Mbps Ethernet Ports	2	2	2	2	2	2	2	2	2	1	
10/100/1000 Mbps Ethernet Ports	---	---	---	---	---	---	---	---	---	---	
Switch Ports	---	---	---	---	---	---	---	---	---	---	
Controller	---	---	---	---	---	---	---	---	---	---	
Magnetic Isolation Protection	1.5 KV	1.5 KV	1.5 KV	1.5 KV	1.5 KV	1.5 KV	1.5 KV	1.5 KV	1.5 KV	1.5 KV	
Serial Interface											
RS-232 Ports	---	---	---	---	---	---	---	---	---	---	
RS-485	---	---	---	---	---	---	---	---	---	---	
RS-232/422/485 Ports	8 (RJ45)	8 (RJ45)	8 (RJ45)	8 (RJ45)	2 (RJ45)	4 (RJ45)	2 (DB9-M)	2 (DB9-M)	2 (DB9-M)	2 (DB9-M)	
ESD Protection	15 KV	15 KV	15 KV	15 KV	15 KV	15 KV	15 KV	15 KV	15 KV	15 KV	
Optical Isolation	---	---	---	---	---	---	---	---	---	---	
Console Port	√	√	√	√	√	√	√	√	√	√	
Serial Communication Parameters	Data Bits: 5, 6, 7, 8; Stop Bits: 1, 1.5, 2; Parity: None, Even, Odd, Space, Mark										
Flow Control	RTS/CTS, XON/XOFF, ADDC®										
Baudrate	50 bps to 921.6 Kbps (non-standard baudrates supported; see user's manual for details)										
CANbus	---	---	---	---	---	---	---	---	---	---	
LEDs											
System	OS Ready				Ready, SD		OS Ready			Ready	
LAN	10M, 100M	10M, 100M	10M, 100M	10M, 100M	10M, 100M	10M, 100M	10M, 100M	10M, 100M	10M, 100M	10M, 100M	
Serial	TxD, RxD	TxD, RxD	TxD, RxD	TxD, RxD	TxD, RxD	TxD, RxD	TxD, RxD	TxD, RxD	TxD, RxD	TxD, RxD	
Physical Characteristics											
Housing	SECC sheet metal (1 mm)				Aluminum (1 mm)						
Weight	875 g	875 g	875 g	875 g	190 g	200 g	190 g	190 g	190 g	130 g	
Dimensions	197 x 44 x 125 mm				77 x 111 x 26 mm						
Mounting	DIN-Rail, wall				DIN-Rail, wall						
Environmental Limits											
Operating Temperature	-10 to 60°C	-10 to 60°C	-10 to 60°C	-10 to 60°C	-10 to 60°C or -40 to 75°C						
Operating Humidity	5 to 95% RH	5 to 95% RH	5 to 95% RH	5 to 95% RH	5 to 95% RH	5 to 95% RH	5 to 95% RH	5 to 95% RH	5 to 95% RH	5 to 95% RH	
Storage Temperature	-20 to 80°C	-20 to 80°C	-20 to 80°C	-20 to 80°C	-20 to 80°C		-20 to 80°C or -40 to 85°C				
Anti Vibration/Shock	1g/5g	1g/5g	1g/5g	1g/5g	---		---				
Regulatory Approvals											
EMC	CE (EN55022 Class A, EN61000-3-2 Class A, EN61000-3-3, EN55024), FCC (Part 15 Subpart B, CISPR 22 Class A)										
Safety	UL/cUL (UL60950-1, CSA C22.2 No. 60950-1-03), TÜV (EN60950-1)				LVD (EN60950-1), UL/cUL (UL60950-1, CSA C22.2 No. 60950-1-03)		UL/cUL (UL60950-1, CSA C22.2 No. 60950-1-03), TÜV (EN60950-1)			LVD (EN60950-1), UL/cUL (UL60950, CAN/CSA-C22.2 No. 60950-00)	
Green Product	RoHS, CRoHS, WEEE										
Reliability											
Buzzer, RTC, WDT	√	√	√	√	√	√	√	√	√	√	
Warranty	5 years (see www.moxa.com/warranty)										

Rackmount Computers



	DA-681-I-SP-CE	DA-681-I-SP-XPE	DA-681-I-SP-LX	DA-681-I-DP-CE	DA-681-I-DP-XPE	DA-681-I-DP-LX	DA-682-CE	DA-682-XPE	DA-682-LX
Computer									
CPU Speed	1 GHz	1 GHz	1 GHz	1 GHz	1 GHz	1 GHz	1 GHz	1 GHz	1 GHz
OS (pre-installed)	WinCE 6.0	WinXP Emb. SP2	Linux	WinCE 6.0	WinXP Emb. SP2	Linux	WinCE 6.0	WinXP Emb. SP2	Linux
DRAM	---	---	---	---	---	---	---	---	---
FSB	400 MHz	400 MHz	400 MHz	400 MHz	400 MHz	400 MHz	400 MHz	400 MHz	400 MHz
Flash	---	---	---	---	---	---	---	---	---
System Memory	512 MB (1 GB max.)	512 MB (1 GB max.)	512 MB (1 GB max.)	512 MB (1 GB max.)	512 MB (1 GB max.)	512 MB (1 GB max.)	256 MB (1 GB max.)	512 MB (1 GB max.)	512 MB (1 GB max.)
PCMCIA	---	---	---	---	---	---	---	---	---
Expansion Bus	PC/104-Plus onboard								
USB Ports	2 (USB 2.0)	2 (USB 2.0)	2 (USB 2.0)	2 (USB 2.0)	2 (USB 2.0)	2 (USB 2.0)	4 (USB 2.0)	4 (USB 2.0)	4 (USB 2.0)
Storage									
Built-in	1 GB	1 GB	1 GB	1 GB	1 GB	1 GB	256 MB	1 GB	1 GB
CompactFlash Socket	√	√	√	√	√	√	√	√	√
HDD Support	√	√	√	√	√	√	√	√	√
Other Peripherals									
KB/MS	1 PS/2 interface, supports standard PS/2 keyboard and PS/2 mouse via Y-type cable (Optional)								
Display									
Graphics Controller	√	√	√	√	√	√	√	√	√
Mini Screen with Push Buttons	---	---	---	---	---	---	---	---	---
LAN Interface									
10/100 Mbps Ethernet Ports	6	6	6	6	6	6			
10/100/1000 Mbps Ethernet Ports	---	---	---	---	---	---	4	4	4
Magnetic Isolation Protection	1.5 KV	1.5 KV	1.5 KV	1.5 KV	1.5 KV	1.5 KV	1.5 KV	1.5 KV	1.5 KV
100BaseFX Fiber Ports (multi-mode)	---	---	---	---	---	---	---	---	---
Serial Interface									
RS-232 Ports	4 (DB9-M)	4 (DB9-M)	4 (DB9-M)	4 (DB9-M)	4 (DB9-M)	4 (DB9-M)	---	---	---
RS-485	8 (TB)	8 (TB)	8 (TB)	8 (TB)	8 (TB)	8 (TB)	---	---	---
RS-232/422/485 Ports	---	---	---	---	---	---	---	---	---
ESD Protection	15 KV	15 KV	15 KV	15 KV	15 KV	15 KV	---	---	---
Digital Isolation	2 KV	2 KV	2 KV	2 KV	2 KV	2 KV	---	---	---
Console Port	---	---	---	---	---	---	---	---	---
Serial Communication Parameters	Data Bits: 5, 6, 7, 8; Stop Bits: 1, 1.5, 2; Parity: None, Even, Odd, Space, Mark						---	---	---
Flow Control	RTS/CTS, XON/XOFF, ADDC@						---	---	---
Baudrate	50 bps to 921.6 Kbps (non-standard baudrates supported; see user's manual for details)						---	---	---
LEDs									
System	Ready, Storage, Power Failure (for dual power models only)						Ready, Power, Storage		
LAN	10M, 100M	10M, 100M	10M, 100M	10M, 100M	10M, 100M	10M, 100M	100M, 1000M	100M, 1000M	100M, 1000M
Serial	TX, RX	TX, RX	TX, RX	TX, RX	TX, RX	TX, RX	TX, RX	TX, RX	TX, RX
Physical Characteristics									
Housing	SECC sheet metal (1 mm)								
Weight	4.5 kg	4.5 kg	4.5 kg	4.5 kg	4.5 kg	4.5 kg	7 kg	7 kg	7 kg
Dimensions	440 x 253 x 45 mm						440 x 253 x 90 mm		
Mounting	Standard 19-inch rackmount								
Environmental Limits									
Operating Temperature	0 to 60°C	0 to 60°C	0 to 60°C	0 to 60°C	0 to 60°C	0 to 60°C	-10 to 60°C	-10 to 60°C	-10 to 60°C
Operating Humidity	5 to 95% RH	5 to 95% RH	5 to 95% RH	5 to 95% RH	5 to 95% RH	5 to 95% RH	5 to 95% RH	5 to 95% RH	5 to 95% RH
Storage Temperature	-20 to 75°C	-20 to 75°C	-20 to 75°C	-20 to 75°C	-20 to 75°C	-20 to 75°C	-20 to 80°C	-20 to 80°C	-20 to 80°C
Regulatory Approvals									
EMC	CE (EN61000-3-2, EN61000-3-3, EN55024), FCC (Part 15 Subpart B, CISPR 22 Class A), CCC (GB9254, GB 17625.1)						CE (EN61000-6-4)		
Safety	UL/cUL (UL60950-1, CSA C22.2 No. 60950-1-03), LVD (EN60950-1), CCC (GB4943)								
Green Product	RoHS, CRoHS, WEEE								
Reliability									
Buzzer, RTC, WDT	√	√	√	√	√	√	√	√	√
Warranty	5 years (see www.moxa.com/warranty)								

3

Embedded Computers for Communication > Rackmount Computers

Rackmount Computers



	DA-660-8-LX	DA-660-8-CE	DA-660-16-LX	DA-660-16-CE	DA-661-16-LX	DA-661-16-CE	DA-662-16-LX	DA-662-16-CE	DA-662-1-16-LX	DA-662-1-16-CE
Computer										
CPU Speed	266 MHz	266 MHz	266 MHz	266 MHz	533 MHz	533 MHz	533 MHz	533 MHz	533 MHz	533 MHz
OS (pre-installed)	Emb. Linux	WinCE 5.0	Emb. Linux	WinCE 5.0	Emb. Linux	WinCE 5.0	Emb. Linux	WinCE 5.0	Emb. Linux	WinCE 5.0
DRAM	128 MB	128 MB	128 MB	128 MB	128 MB	128 MB	128 MB	128 MB	128 MB	128 MB
FSB	---	---	---	---	---	---	---	---	---	---
Flash	32 MB	32 MB	32 MB	32 MB	32 MB	32 MB	32 MB	32 MB	32 MB	32 MB
System Memory	---	---	---	---	---	---	---	---	---	---
PCMCIA	---	---	---	---	√	√	√	√	√	√
Expansion Bus	---	---	---	---	---	---	---	---	---	---
USB Ports	---	---	---	---	2	2	2	2	2	2
Storage										
Built-in	---	---	---	---	---	---	---	---	---	---
CompactFlash Socket	---	---	---	---	√	√	√	√	√	√
HDD Support	---	---	---	---	---	---	---	---	---	---
Other Peripherals										
KB/MS	---	---	---	---	---	---	---	---	---	---
Display										
Graphics Controller	---	---	---	---	---	---	---	---	---	---
Mini Screen with Push Buttons	√	√	√	√	√	√	√	√	√	√
LAN Interface										
10/100 Mbps Ethernet Ports	2	2	2	2	2	2	4	4	4	4
10/100/1000 Mbps Ethernet Ports	---	---	---	---	---	---	---	---	---	---
Magnetic Isolation Protection	1.5 KV	1.5 KV	1.5 KV	1.5 KV	1.5 KV	1.5 KV	1.5 KV	1.5 KV	1.5 KV	1.5 KV
100BaseFX Fiber Ports (multi-mode)	---	---	---	---	---	---	---	---	---	---
Serial Interface										
RS-232 Ports	---	---	---	---	---	---	---	---	---	---
RS-485	---	---	---	---	---	---	---	---	---	---
RS-232/422/485 Ports	8 (RJ45)	8 (RJ45)	16 (RJ45)	16 (RJ45)	16 (RJ45)	16 (RJ45)	16 (RJ45)	16 (RJ45)	16 (RJ45)	16 (RJ45)
ESD Protection	15 KV	15 KV	15 KV	15 KV	15 KV	15 KV	15 KV	15 KV	15 KV	15 KV
Digital Isolation	---	---	---	---	---	---	---	---	2 KV	2 KV
Console Port	√	√	√	√	√	√	√	√	√	√
Serial Communication Parameters	Data Bits: 5, 6, 7, 8; Stop Bits: 1, 1.5, 2; Parity: None, Even, Odd, Space, Mark									
Flow Control	RTS/CTS, XON/XOFF, ADDC@									
Baudrate	50 bps to 921.6 Kbps (non-standard baudrates supported; see user's manual for details)									
LEDs										
System	OS Ready	OS Ready	OS Ready	OS Ready	OS Ready	OS Ready	OS Ready	OS Ready	OS Ready	OS Ready
LAN	10M, 100M	10M, 100M	10M, 100M	10M, 100M	10M, 100M	10M, 100M	10M, 100M	10M, 100M	10M, 100M	10M, 100M
Serial	TxD, RxD	TxD, RxD	TxD, RxD	TxD, RxD	TxD, RxD	TxD, RxD	TxD, RxD	TxD, RxD	TxD, RxD	TxD, RxD
Physical Characteristics										
Housing	SECC sheet metal (1 mm)									
Weight	2600 g	2600 g	2600 g	2600 g	2600 g	2600 g	2600 g	2600 g	2940 g	2940 g
Dimensions	440 x 45 x 198 mm								440 x 45 x 228 mm	
Mounting	Standard 19-inch rackmount									
Environmental Limits										
Operating Temperature	-10 to 60°C	-10 to 60°C	-10 to 60°C	-10 to 60°C	-10 to 60°C	-10 to 60°C	-10 to 60°C	-10 to 60°C	-10 to 60°C	-10 to 60°C
Operating Humidity	5 to 95% RH	5 to 95% RH	5 to 95% RH	5 to 95% RH	5 to 95% RH	5 to 95% RH	5 to 95% RH	5 to 95% RH	5 to 95% RH	5 to 95% RH
Storage Temperature	-20 to 80°C	-20 to 80°C	-20 to 80°C	-20 to 80°C	-20 to 80°C	-20 to 80°C	-20 to 80°C	-20 to 80°C	-20 to 80°C	-20 to 80°C
Regulatory Approvals										
EMC	CE (EN55022 Class A, EN61000-3-2 Class A, EN61000-3-3, EN55024), FCC (Part 15 Subpart B, CISPR 22 Class A)									
Safety	UL/cUL (UL60950-1, CSA C22.2 No. 60950-1-03), TÜV (EN60950-1)									
Green Product	RoHS, CrRoHS, WEEE									
Reliability										
Buzzer, RTC, WDT	√	√	√	√	√	√	√	√	√	√
Warranty	5 years (see www.moxa.com/warranty)									

Module/Board Computers



	EM-2260-CE	EM-2260-LX	EM-1240-LX EM-1240-T-LX	EM-1220-LX EM-1220-T-LX
Computer				
CPU Speed	200 MHz	200 MHz	192 MHz	192 MHz
OS (pre-installed)	WinCE 6.0	Linux	Embedded µClinux	
DRAM	128 MB	128 MB	16 MB	16 MB
Flash	32 MB	32 MB	8 MB	8 MB
Digital I/O	8 Dis, 8 DOs	8 Dis, 8 DOs	---	---
Storage				
SD Slot	---	---	√	√
EIDE Interface	√	√	---	---
Display				
Graphics Controller	√	√	---	---
LAN Interface				
10/100 Mbps Ethernet Ports	2	2	2	2
Magnetic Isolation Protection	1.5 KV	1.5 KV	1.5 KV	1.5 KV
Serial Interface				
RS-232/422/485 Ports	4	4	4	2
ESD Protection	15 KV	15 KV	15 KV	15 KV
Console Port	√	√	√	√
Serial Communication Parameters	Data Bits: 5, 6, 7, 8; Stop Bits: 1, 1.5, 2; Parity: None, Even, Odd, Space, Mark			
Flow Control	RTS/CTS, XON/XOFF, ADDC®			
Baudrate	50 bps to 921.6 Kbps (non-standard baudrates supported; see user's manual for details)			
Physical Characteristics				
Weight	70 g	70 g	50 g	40 g
Dimensions	106 x 87 mm	106 x 87 mm	90 x 80 mm	80 x 50 mm
Module Interface	---	---	Two 2 x 28 pin-headers (1.27 x 1.27 mm pitch)	
Environmental Limits				
Operating Temperature	-10 to 60°C	-10 to 60°C	-10 to 60°C or -40 to 75°C	
Operating Humidity	5 to 95% RH	5 to 95% RH	5 to 95% RH	5 to 95% RH
Storage Temperature	-20 to 80°C	-20 to 80°C	-20 to 80°C or -40 to 85°C	
Regulatory Approvals				
EMC	CE (Class A), FCC		CE (EN55022 Class A, EN61000-3-2 Class A, EN61000-3-3, EN55024), FCC (Part 15 Subpart B, CISPR 22 Class A)	
Green Product	RoHS, CRoHS, WEEE			
Reliability				
Buzzer, RTC, WDT	√	√	√	√
Warranty	5 years (see www.moxa.com/warranty)			

3

Embedded Computers for Communication > Module/Board Computers

DIN-Rail Computers



	IA260-CE IA260-T-CE	IA240-LX IA260-T-LX	IA261-I-LX IA261-I-T-LX	IA261-I-CE IA261-I-T-CE	IA262-I-LX IA262-I-T-LX	IA262-I-CE IA262-I-T-CE	IA240-LX IA240-T-LX	IA241-LX IA241-T-LX	
Computer									
CPU Speed	200 MHz	200 MHz	200 MHz	200 MHz	200 MHz	200 MHz	192 MHz	192 MHz	
OS (pre-installed)	WinCE 6.0	Linux	Linux	WinCE 6.0	Linux	WinCE 6.0	Embedded Linux		
DRAM	128 MB (256 MB max.)						64 MB	64 MB	
Flash	32 MB (64 MB max.)		32 MB	32 MB	32 MB	32 MB	32 MB	32 MB	
PCMCIA	---	---	---	---	---	---	---	√	
USB Ports	2 (USB 2.0)	2 (USB 2.0)	2 (USB 2.0)	2 (USB 2.0)	2 (USB 2.0)	2 (USB 2.0)	1 (USB 2.0)	1 (USB 2.0)	
Digital I/O	8 Dis, 8 DOs	8 Dis, 8 DOs	8 Dis, 8 DOs	8 Dis, 8 DOs	8 Dis, 8 DOs	8 Dis, 8 DOs	4 Dis, 4 DOs	4 Dis, 4 DOs	
Storage									
CompactFlash Socket	√	√	√	√	√	√	---	---	
SD Slot	---	---	---	---	---	---	√	√	
Display									
Graphics Controller	√	√	√	√	√	√	---	---	
LAN Interface									
10/100 Mbps Ethernet Ports	2	2	2	2	2	2	2	2	
Magnetic Isolation Protection	1.5 KV	1.5 KV	1.5 KV	1.5 KV	1.5 KV	1.5 KV	1.5 KV	1.5 KV	
Serial Interface									
RS-232/422/485 Ports	4 (DB9-M)	4 (DB9-M)	4 (DB9-M)	4 (DB9-M)	2 (DB9-M)	2 (DB9-M)	4 (RJ45)	4 (RJ45)	
ESD Protection	---	---	15 KV	15 KV	15 KV	15 KV	15 KV	15 KV	
Digital Isolation	---	---	2 KV	2 KV	2 KV	2 KV	---	---	
Console Port	√	√	√	√	√	√	√	√	
Serial Communication Parameters	Data Bits: 5, 6, 7, 8; Stop Bits: 1, 1.5, 2; Parity: None, Even, Odd, Space, Mark								
Flow Control	RTS/CTS, XON/XOFF, ADDC®								
Baudrate	50 bps to 921.6 Kbps (non-standard baudrates supported)								
CANbus	---	---	---	---	2 (DB9-M)	2 (DB9-M)	---	---	
LEDs									
System	Power, Ready, Storage								
LAN	10M, 100M	10M, 100M	10M, 100M	10M, 100M	10M, 100M	10M, 100M	10M, 100M	10M, 100M	
Serial	TxD, RxD	TxD, RxD	TxD, RxD	TxD, RxD	TxD, RxD	TxD, RxD	TxD, RxD	TxD, RxD	
Physical Characteristics									
Housing	Aluminum, industrial vertical form factor						Aluminum (1 mm)		
Weight	1 kg	1 kg	950 g	950 g	950 g	950 g	430 g	500 g	
Dimensions	52 x 112.6 x 162 mm	52 x 112.6 x 162 mm	60 x 115 x 152 mm	60 x 115 x 152 mm	60 x 115 x 152 mm	60 x 115 x 152 mm	60 x 137 x 100 mm	60 x 137 x 100 mm	
Mounting	DIN-Rail, wall	DIN-Rail, wall	DIN-Rail, wall	DIN-Rail, wall	DIN-Rail, wall	DIN-Rail, wall	DIN-Rail, wall	DIN-Rail, wall	
Environmental Limits									
Operating Temperature	-10 to 60°C or -40 to 75°C								
Operating Humidity	5 to 95% RH	5 to 95% RH	5 to 95% RH	5 to 95% RH	5 to 95% RH	5 to 95% RH	5 to 95% RH	5 to 95% RH	
Storage Temperature	-20 to 80°C or -40 to 85°C								
Regulatory Approvals									
EMC	CE (EN55022 Class A, EN61000-3-2 Class A, EN61000-3-3, EN55024), FCC (Part 15 Subpart B, CISPR 22 Class A), CCC (GB9254, GB 17625.1)						CE (EN55022 Class A, EN61000-3-2 Class A, EN61000-3-3, EN55024), FCC (Part 15 Subpart B, CISPR 22 Class A)		
Safety	UL/cUL (UL60950-1, CSA C22.2 No. 60950-1-03), LVD (EN60950-1), CCC (GB4943)						UL/cUL (UL60950-1, CSA C22.2 No. 60950-1-03), TUV (EN60950-1)		
Green Product	RoHS, CRoHS, WEEE								
Reliability									
Buzzer, RTC, WDT	√	√	√	√	√	√	√	√	
Warranty	5 years (see www.moxa.com/warranty)								

3 Embedded Computers for Automation > DIN-Rail Computers

RISC-based WLAN Computers



	W311-LX	W321-LX	W341-LX
Computer			
CPU Speed	192 MHz	192 MHz	192 MHz
OS (pre-installed)	Embedded Linux with MMU support		
DRAM	32 MB	32 MB	64 MB
Flash	16 MB	16 MB	16 MB
USB Ports	---	---	2 (USB 2.0)
Relay Output	---	---	√
Storage			
SD Slot	√	√	√
LAN Interface			
10/100 Mbps Ethernet Ports	1	1	1
Magnetic Isolation Protection	1.5 KV	1.5 KV	1.5 KV
100BaseFX Fiber Ports (multi-mode)	---	---	---
WLAN Interface			
Standard Compliance	802.11a/b/g		
Radio Frequency Type	DSSS, CCK, OFDM		
Transmission Rate	54 Mbps (max.) with auto fallback (54, 48, 36, 24, 18, 12, 11, 9, 6, 5.5, 2, 1 Mbps) • 802.11a/g: 6, 9, 12, 18, 24, 36, 48, 54 Mbps • 802.11b: 1, 2, 5.5, 11 Mbps		
Transmission Distance	Up to 100 meters (@ 11 Mbps in open areas)		
Wireless Security	WEP: 64-bit/128-bit, WPA, WPA2 data encryption		
WLAN Modes	Ad-hoc (802.11b/g), Infrastructure		
Serial Interface			
RS-232/422/485 Ports	1 (DB9-M)	2 (DB9-M)	4 (DB9-M)
ESD Protection	15 KV	15 KV	15 KV
Console Port	√	√	√
Serial Communication Parameters	Data Bits: 5, 6, 7, 8; Stop Bits: 1, 1.5, 2; Parity: None, Even, Odd, Space, Mark		
Flow Control	RTS/CTS, XON/XOFF, ADDC™		
Baudrate	50 bps to 921.6 Kbps (non-standard baudrates supported)		
LEDs			
System	Ready, SD	Ready, SD	Ready, SD
LAN	10M, 100M	10M, 100M	10M, 100M
WLAN	Enable, Signal Strength		
Serial	TxD, RxD	TxD, RxD	TxD, RxD
Physical Characteristics			
Housing	Aluminum (1 mm)		
Weight	170 g	185 g	390 g
Dimensions	77 x 111 x 26 mm	77 x 111 x 26 mm	150 x 100 x 38 mm
Mounting	DIN-Rail, wall		
Environmental Limits			
Operating Temperature	-10 to 60°C	-10 to 60°C	-10 to 60°C
Operating Humidity	5 to 95% RH	5 to 95% RH	5 to 95% RH
Storage Temperature	-20 to 80°C	-20 to 80°C	-20 to 80°C
Anti Vibration/Shock	5g/50g	5g/50g	5g/50g
Regulatory Approvals			
EMC	CE (ETSI EN 301 489-1/-17, ETSI EN 301 893, ETSI EN 300 328, EN50392), FCC Part 15C & Part 15E		
Safety	UL/cUL (UL60950-1), TÜV (EN60950-1)		
Green Product	RoHS, CrRoHS, WEEE		
Reliability			
Buzzer, RTC, WDT	√	√	√
Warranty	5 years (see www.moxa.com/warranty)		

Cellular Computers



	W315-LX	W325-LX	W345-LX
Computer			
CPU Speed	192 MHz	192 MHz	192 MHz
OS (pre-installed)	Embedded Linux with MMU support		
DRAM	32 MB	32 MB	64 MB
Flash	16 MB	16 MB	16 MB
USB Ports	---	---	2 (USB 2.0)
Relay Output	---	---	√
Storage			
SD Slot	√	√	√
LAN Interface			
10/100 Mbps Ethernet Ports	1	1	1
Magnetic Isolation Protection	1.5 KV	1.5 KV	1.5 KV
100BaseFX Fiber Ports (multi-mode)	---	---	---
Cellular Interface			
Cellular Modes	GSM, GPRS		
Radio Frequency Bands	850/900/1800/1900 MHz		
GPRS Class	10		
Coding Schemes	CS1 to CS4		
Serial Interface			
RS-232/422/485 Ports	1 (DB9-M)	2 (DB9-M)	4 (DB9-M)
ESD Protection	15 KV	15 KV	15 KV
Console Port	√	√	√
Serial Communication Parameters	Data Bits: 5, 6, 7, 8; Stop Bits: 1, 1.5, 2; Parity: None, Even, Odd, Space, Mark		
Flow Control	RTS/CTS, XON/XOFF, ADDC™		
Baudrate	50 bps to 921.6 Kbps (non-standard baudrates supported)		
LEDs			
System	Ready, SD	Ready, SD	Ready, SD
LAN	10M, 100M	10M, 100M	10M, 100M
Cellular	GPRS Enabled, GSM Signal Strength		
Serial	TxD, RxD	TxD, RxD	TxD, RxD
Physical Characteristics			
Housing	Aluminum (1 mm)		
Weight	195 g	195 g	400 g
Dimensions	77 x 111 x 26 mm	77 x 111 x 26 mm	150 x 100 x 38 mm
Mounting	DIN-Rail, wall		
Antenna Length	110 mm		
Environmental Limits			
Operating Temperature	-10 to 60°C	-10 to 60°C	-10 to 60°C
Operating Humidity	5 to 95% RH	5 to 95% RH	5 to 95% RH
Storage Temperature	-20 to 80°C	-20 to 80°C	-20 to 80°C
Anti Vibration/Shock	5g/50g	5g/50g	5g/50g
Regulatory Approvals			
EMC	FCC: Part 15, Part 24/24		
CE	EN55022, EN61000		
R&TTE	EN301 489-1, EN301 489-7, EN301 511		
Safety	LVD: EN60950-1 UL/cUL: UL60950-1, CSA C22.2 No. 60950-1-03		
Green Product	GCF-CC, RoHS, CRoHS, WEEE		
Reliability			
Buzzer, RTC, WDT	√	√	√
Warranty	5 years (see www.moxa.com/warranty)		

Every effort is made to ensure that the information provided in this catalog is accurate. However, please note that no guarantee or legal contract is implied with the presentation of this information. This catalog is intended for informational purposes only, and Moxa reserves the right to update or modify this information at any time.

- > **The latest product information can be found here: www.moxa.com/product**
- > **Send comments or corrections to: twc@moxa.com**



Moxa Inc.

www.moxa.com
info@moxa.com

Moxa Americas

Toll Free: 1-888-MOXA-USA
(1-888-669-2872)
Tel: +1-714-528-6777
Fax: +1-714-528-6778
www.moxa.com
usa@moxa.com

Moxa Europe

Tel: +49-89-3 70 03 99-0
Fax: +49-89-3 70 03 99-99
www.moxa.com
europe@moxa.com

Moxa Asia-Pacific

Tel: +886-2-8919-1230
Fax: +886-2-8919-1231
www.moxa.com
www.moxa.com.tw
japan.moxa.com
asia@moxa.com

Moxa China

Shanghai Office

Tel: +86-21-5258-9955
Fax: +86-21-5258-5505
www.moxa.com.cn
china@moxa.com

Beijing Office

Tel: +86-10-6872-3959/60/61
Fax: +86-10-6872-3958
www.moxa.com.cn
china@moxa.com

Shenzhen Office

Tel: +86-755-8368-4084/94
Fax: +86-755-8368-4148
www.moxa.com.cn
china@moxa.com



Free Manuals Download Website

<http://myh66.com>

<http://usermanuals.us>

<http://www.somanuals.com>

<http://www.4manuals.cc>

<http://www.manual-lib.com>

<http://www.404manual.com>

<http://www.luxmanual.com>

<http://aubethermostatmanual.com>

Golf course search by state

<http://golfingnear.com>

Email search by domain

<http://emailbydomain.com>

Auto manuals search

<http://auto.somanuals.com>

TV manuals search

<http://tv.somanuals.com>