

MOXA EtherDevice™ Switch

EDS-518A Series User's Manual

www.moxa.com/product

First Edition, April 2006



MOXA Networking Co., Ltd.

Tel: +886-2-2910-1230

Fax: +886-2-2910-1231

Web: www.moxa.com

MOXA Technical Support

Worldwide: support@moxanet.tw

The Americas: support@moxa.com

MOXA EtherDevice™ Switch EDS-518A Series User's Manual

The software described in this manual is furnished under a license agreement and may be used only in accordance with the terms of that agreement.

Copyright Notice

Copyright © 2006 MOXA Networking Co., Ltd.
All rights reserved.
Reproduction without permission is prohibited.

Trademarks

MOXA is a registered trademark of the MOXA Group.
All other trademarks or registered marks in this manual belong to their respective manufacturers.

Disclaimer

Information in this document is subject to change without notice and does not represent a commitment on the part of MOXA.

MOXA provides this document "as is," without warranty of any kind, either expressed or implied, including, but not limited to, its particular purpose. MOXA reserves the right to make improvements and/or changes to this manual, or to the products and/or the programs described in this manual, at any time.

Information provided in this manual is intended to be accurate and reliable. However, MOXA assumes no responsibility for its use, or for any infringements on the rights of third parties that may result from its use.

This product might include unintentional technical or typographical errors. Changes are periodically made to the information herein to correct such errors, and these changes are incorporated into new editions of the publication.

Table of Contents

Chapter 1	Introduction	1-1
	Overview	1-2
	Package Checklist.....	1-2
	Features	1-2
	Industrial Networking Capability	1-2
	Designed for Industrial Applications.....	1-2
	Useful Utility and Remote Configuration	1-3
	Recommended Software and Accessories.....	1-3
Chapter 2	Getting Started	2-1
	RS-232 Console Configuration (115200, None, 8, 1, VT100)	2-2
	Configuration using a Telnet Console	2-5
	Configuration using a Web Browser.....	2-6
	Disabling Telnet and Browser Access	2-8
Chapter 3	Featured Functions	3-1
	Configuring Basic Settings.....	3-2
	System Identification.....	3-2
	Password	3-3
	Accessible IP	3-4
	Port.....	3-5
	Network.....	3-6
	Time	3-8
	System File Update—By Remote TFTP	3-9
	System File Update—By Local Import/Export	3-10
	Factory Default.....	3-11
	Using Port Trunking	3-11
	The Port Trunking Concept.....	3-11
	Configuring Port Trunking.....	3-12
	Configuring SNMP.....	3-14
	SNMP Read/Write Settings.....	3-14
	Trap Settings	3-16
	Private MIB information	3-16
	Using Communication Redundancy	3-16
	Gigabit Ethernet Redundant Ring Capability (< 300 ms)	3-17
	The Turbo Ring Concept.....	3-17
	Configuring Turbo Ring.....	3-20
	The STP/RSTP Concept.....	3-21
	Configuring STP/RSTP	3-26
	Using Traffic Prioritization.....	3-29
	The Traffic Prioritization Concept	3-29
	Configuring Traffic Prioritization	3-31
	Using Virtual LAN	3-34
	The Virtual LAN (VLAN) Concept	3-34
	Sample Applications of VLANs using MOXA EDS-518A	3-36
	Configuring Virtual LAN.....	3-37
	Using Multicast Filtering.....	3-40

	The Concept of Multicast Filtering	3-40
	Configuring IGMP Snooping	3-43
	Add Static Multicast MAC	3-44
	Configuring GMRP	3-45
	GMRP Table	3-45
Using	Bandwidth Management	3-46
	Configuring Bandwidth Management	3-46
	Broadcast Storm Protection	3-46
	Traffic Rate Limiting Settings	3-46
Using	Port Access Control	3-47
	Configuring Static Port Lock	3-49
	Configuring IEEE 802.1X	3-49
Using	Auto Warning	3-52
	Configuring Email Warning	3-53
	Event Type	3-53
	Email Setup	3-55
	Configuring Relay Warning	3-56
	Event Setup	3-56
	Warning List	3-57
Using	Line-Swap-Fast-Recovery	3-57
	Configuring Line-Swap Fast Recovery	3-58
Using	Set Device IP	3-58
	Configuring Set Device IP	3-59
Using	Diagnosis	3-59
	Mirror Port	3-59
	Ping	3-60
Using	Monitor	3-60
	Monitor by Switch	3-60
	Monitor by Port	3-61
Using	the MAC Address Table	3-62
Using	Event Log	3-62
Using	HTTPS/SSL	3-63
Chapter 4	EDS Configurator GUI	4-1
	Starting EDS Configurator	4-2
	Broadcast Search	4-2
	Search by IP address	4-3
	Upgrade Firmware	4-3
	Modify IP Address	4-4
	Export Configuration	4-5
	Import Configuration	4-6
	Unlock Server	4-7
Appendix A	MIB Groups	A-1
Appendix B	Specifications	B-1
Appendix C	Service Information	C-1
	MOXA Internet Services	C-2
	Problem Report Form	C-3
	Product Return Procedure	C-4

1

Introduction

Welcome to MOXA EtherDevice Switch EDS-518A Series, the Gigabit Managed Redundant Ethernet Switch designed specially for connecting Ethernet-enabled devices in industrial field applications.

The following topics are covered in this chapter:

- Overview**
- Package Checklist**
- Features**

Overview

As the world's network and information technology becomes more mature, the trend is to use Ethernet as the major communications interface in many industrial communications and automation applications. In fact, a whole new industry has sprung up to provide Ethernet products that comply with the requirements of demanding industrial applications. EDS-518A is designed for Gigabit-speed, high port density, ultra-reliable operation in rugged industrial environments, and is therefore the best choice for each industrial application.

Package Checklist

MOXA EtherDevice Switch EDS-518A Series is shipped with the following items. If any of these items are missing or damaged, please contact your customer service representative for assistance.

- 1 MOXA EtherDevice Switch EDS-518A
- Hardware Installation Guide
- CD-ROM with User's Manual and Windows Utility
- MOXA Product Warranty booklet
- RJ45 to DB9 Console port cable
- Protective caps for unused ports
- Panel mounting kit (optional—must order separately)

Features

Industrial Networking Capability

- Redundant Gigabit Ethernet Ring Capability (recovery time < 300 ms at full load)
- IGMP Snooping and GMRP for filtering multicast traffic from industrial Ethernet Protocols
- Supports IEEE 802.1Q, Tag-based VLAN, GVRP, and Port-based VLAN to ease network planning
- Supports QoS—IEEE 802.1p/1Q and TOS/DiffServ to increase determinism
- Supports 802.3ad, LACP for optimum bandwidth utilization
- Supports IEEE 802.1X and SSL to enhance network security
- SNMP V1/V2c/V3 for different levels of network management security
- RMON for efficient network monitoring and proactive capability

Designed for Industrial Applications

- Bandwidth management prevents unpredictable network status
- Support ABC-01 (Automatic Backup Configurator) for system configuration back up
- Long-haul transmission distance of 40 km or 80 km
- Redundant, dual 12-45 VDC power inputs
- IP 30, rugged high-strength metal case
- DIN-Rail or panel mounting ability
- Bandwidth management to prevent unpredictable network status
- Lock port for authorized MAC address access only
- Port mirroring for online debugging
- Automatic warning by exception through email, relay output
- Digital inputs to integrate a sensor and alarm with an IP network
- Automatic recovery of connected device IP addresses
- Line-swap fast recovery

Useful Utility and Remote Configuration

- Configurable using a Web browser, Telnet/Serial console, and Windows utility
- Send ping commands to identify network segment integrity

Recommended Software and Accessories

- EDS-SNMP OPC Server Pro
- DR-4524, DR-75-24, DR-120-24 DIN-Rail 24 VDC Power Supply Series

2

Getting Started

This chapter explains how to access EDS-518A for the first time. There are three ways to access the switch: serial console, Telnet console, and web browser. The serial console connection method, which requires using a short serial cable to connect EDS-518A to a PC's COM port, can be used if you do not know EDS-518A's IP address. The Telnet console and web browser connection methods can be used to access EDS-518A over an Ethernet LAN, or over the Internet.

The following topics are covered:

- RS-232 Console Configuration (115200, None, 8, 1, VT100)**
- Configuration using a Telnet Console**
- Configuration using a Web Browser**
- Disabling Telnet and Browser Access**

RS-232 Console Configuration (115200, None, 8, 1, VT100)

NOTE

Connection Caution!

1. You **cannot** connect to EDS-518A simultaneously by serial console and Telnet.
2. You **can** connect to EDS-518A simultaneously by web browser and serial console, or by web browser and Telnet.
However, we strongly suggest that you do NOT use more than one connection method at the same time. Following this advice will allow you to maintain better control over the configuration of your EDS-518A.

NOTE

We recommend using MOXA PComm Terminal Emulator, which can be downloaded free of charge from MOXA's website.

Before running PComm Terminal Emulator, use an RJ45 to DB9-F (or RJ45 to DB25-F) cable to connect EDS-518A's RS-232 Console port to your PC's COM port (generally COM1 or COM2, depending on how your system is set up).

After installing PComm Terminal Emulator, perform the following steps to access the RS-232 Console utility.

1. From the Windows desktop, click **Start** → **Programs** → **PCommLite2.5** → **Terminal Emulator**.

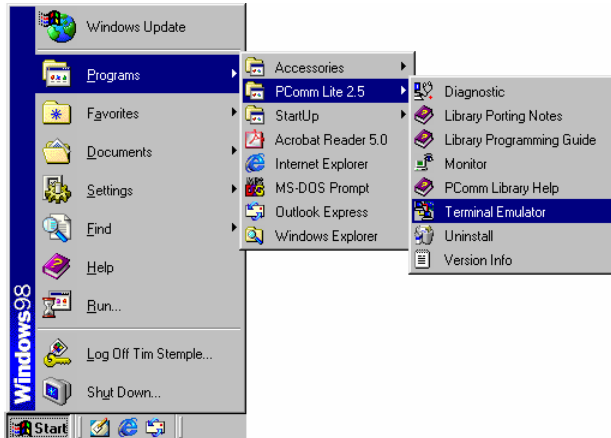

2. Select **Open** under **Port Manager** to open a new connection.

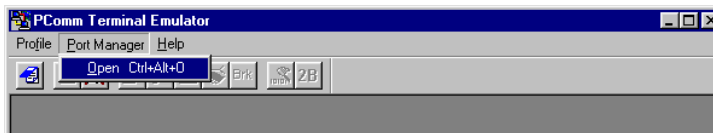

- The **Communication Parameter** page of the **Property** window opens. Select the appropriate COM port for **Console Connection**, **115200** for **Baud Rate**, **8** for **Data Bits**, **None** for **Parity**, and **1** for **Stop Bits**.

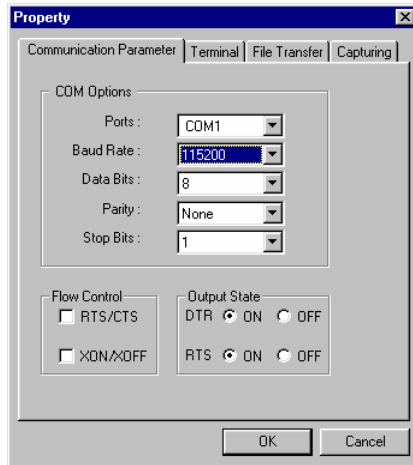

- Click the **Terminal** tab, and select **VT100** for **Terminal Type**. Click **OK** to continue.

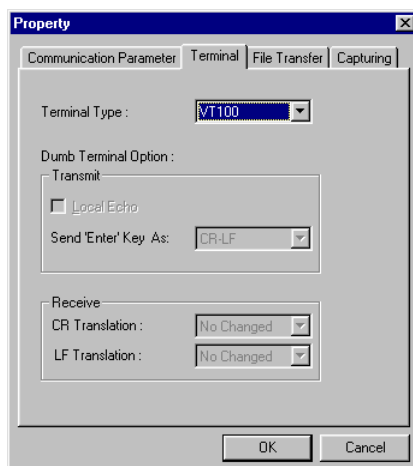

- Type **1** to select **ansi/VT100** terminal type, and then press **Enter**.

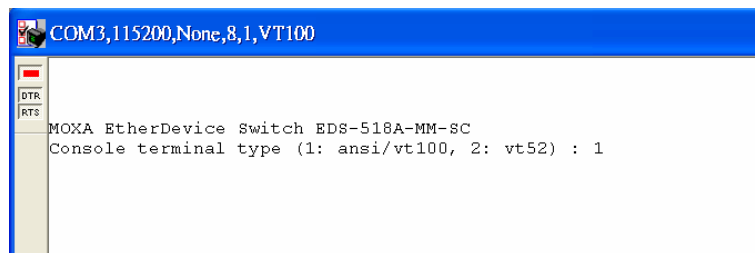

- The Console login screen will appear. Press **Enter** to open the Account pop-up selector and then select either **admin** or **user**. Use the keyboard's down arrow to move the cursor to the Password field, enter the **Console Password** (this is the same as the Web Browser password; leave the **Password** field blank if a console password has not been set), and then press **Enter**.

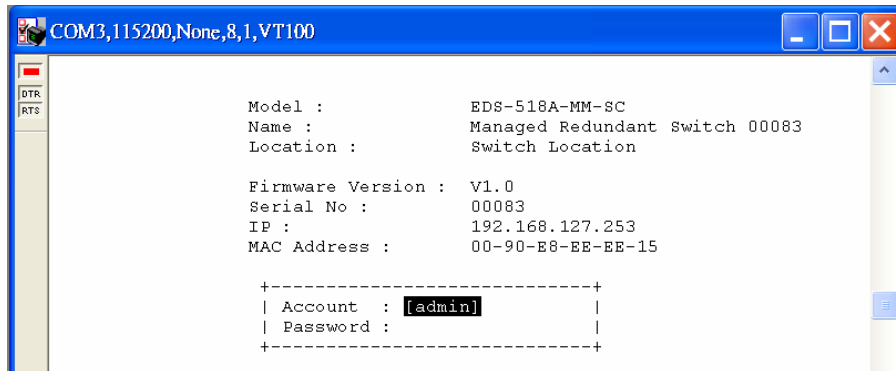

- EDS-518A's **Main Menu** will be displayed. (NOTE: To modify the appearance of the PComm Terminal Emulator window, select **Font...** under the **Edit** menu, and then choose the desired formatting options.)

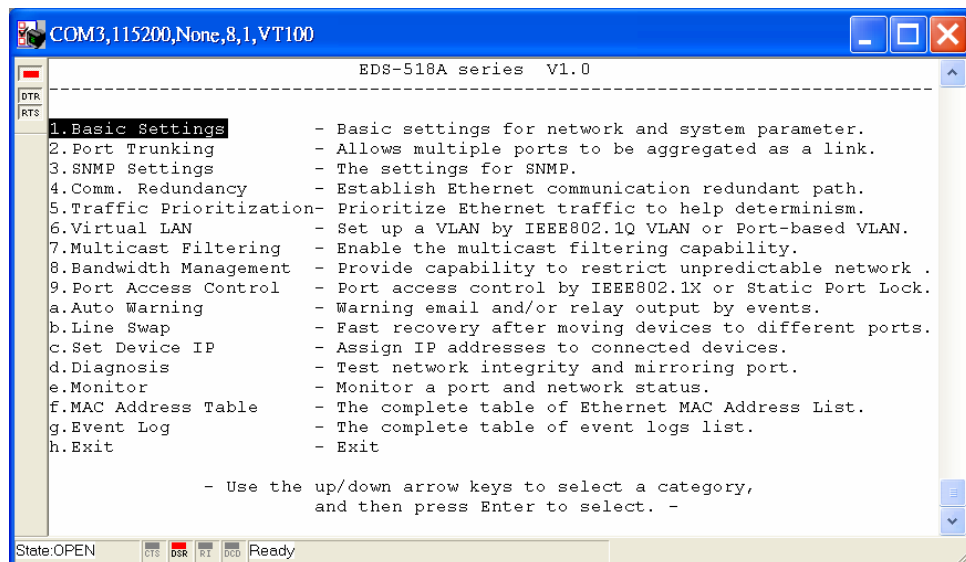

- After entering the **Main Menu**, use the following keys to move the cursor, and to select options.

Key	Function
Up/Down/Left/Right arrows, or Tab	Move the onscreen cursor
Enter	Display & select options
Space	Toggle options
Esc	Previous Menu

Configuration using a Telnet Console

You may use Telnet to access EDS-518A's console utility over a network. To be able to access EDS's functions over the network (by Telnet or Web Browser) from a PC host that is connected to the same LAN as EDS-518A, you need to make sure that the PC host and EDS-518A are on the same logical subnet. To do this, check your PC host's IP address and subnet mask. By default, EDS-518A's IP address is 192.168.127.253 and EDS-518A's subnet mask is 255.255.0.0 (for a Class B network). If you do not change these values, and your PC host's subnet mask is 255.255.0.0, then its IP address must have the form 192.168.xxx.xxx. On the other hand, if your PC host's subnet mask is 255.255.255.0, then its IP address must have the form 192.168.127.xxx.

NOTE To use EDS-518A's management and monitoring functions from a PC host connected to the same LAN as EDS-518A, you must make sure that the PC host and EDS-518A are on the same logical subnet.

NOTE Before accessing the console utility via Telnet, first connect one of EDS-518A's RJ45 Ethernet ports to your Ethernet LAN, or directly to your PC's Ethernet NIC. You can establish a connection with either a straight-through or cross-over Ethernet cable.

NOTE EDS-518A's default IP is **192.168.127.253**.

Perform the following steps to access the console utility via Telnet.

1. Click **Start** → **Run**, and then telnet to EDS-518A's IP address from the Windows **Run** window. (You may also issue the telnet command from the MS-DOS prompt.)

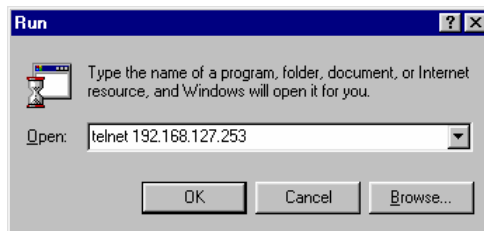

2. Type **1** to choose **ansi/vt100**, and then press **Enter**.

```
MOXA EtherDevice Switch EDS-518A-MM-SC
Console terminal type <1: ansi/vt100, 2: vt52> : 1
```

- The Console login screen will appear. Press **Enter** to open the Account pop-up selector and then select either **admin** or **user**. Use the keyboard's down arrow to move the cursor to the Password field, enter the **Console Password** (this is the same as the Web Browser password; leave the **Password** field blank if a console password has not been set), and then press **Enter**.

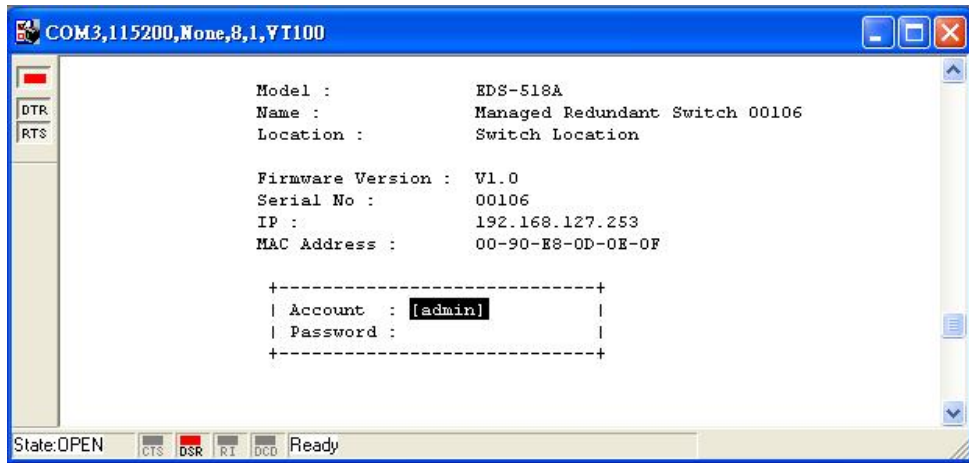

- When the **Main Menu** of EDS-518A's console utility opens, click **Terminal** → **preferences...** from the menu at the top of the window.
- When the **Terminal Preferences** window opens, make sure that the **VT100 Arrows** option is selected.

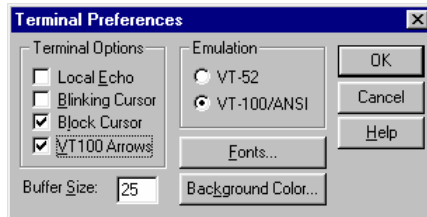

NOTE The Telnet Console looks and operates in precisely the same manner as the RS-232 Console.

Configuration using a Web Browser

MOXA EDS-518A's web browser interface provides a convenient way to modify the switch's configuration and access the built-in monitoring and network administration functions. You may use either Internet Explorer or Netscape to access EDS-518A.

NOTE To use EDS-518A's management and monitoring functions from a PC host connected to the same LAN as EDS-518A, you must make sure that the PC host and EDS-518A are on the same logical subnet.

NOTE If EDS-518A is configured for other VLAN settings, you must make sure your PC host is on the management VLAN.

NOTE Before accessing EDS-518A's web browser interface, first connect one of its RJ45 Ethernet ports to your Ethernet LAN, or directly to your PC's Ethernet NIC. You can establish a connection with either a straight-through or cross-over Ethernet cable.

NOTE MOXA EDS-518A's default IP is **192.168.127.253**.

Perform the following steps to access EDS-518A's web browser interface.

1. Open Internet Explorer and type EDS-518A's IP address in the **Address** field. Press **Enter** to establish the connection.

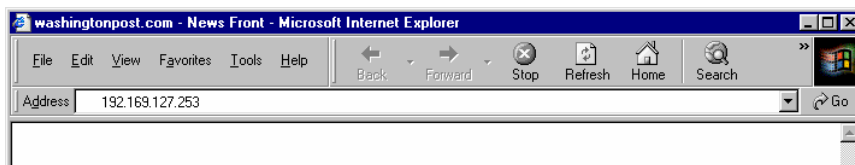

2. The web login page will open. Select the login account (Admin or User) and enter the **Password** (this is the same as the Console password), and then click **Login** to continue. Leave the **Password** field blank if a password has not been set.

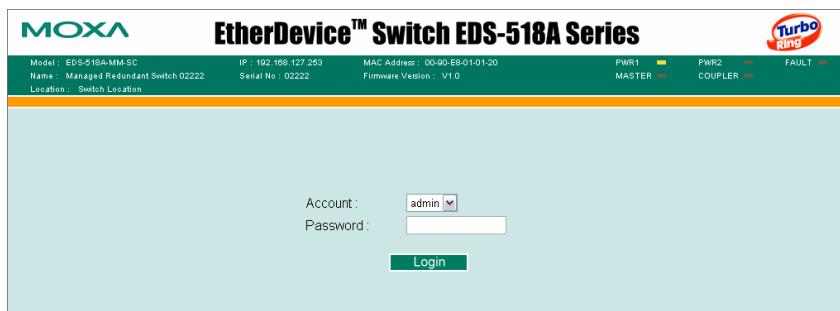

NOTE By default, EDS-518A's password is not set (i.e., is blank).

You may need to wait a few moments for the web page to be downloaded to your computer. Use the menu tree on the left side of the window to open the function pages to access each of MOXA EtherDevice Switch's functions.

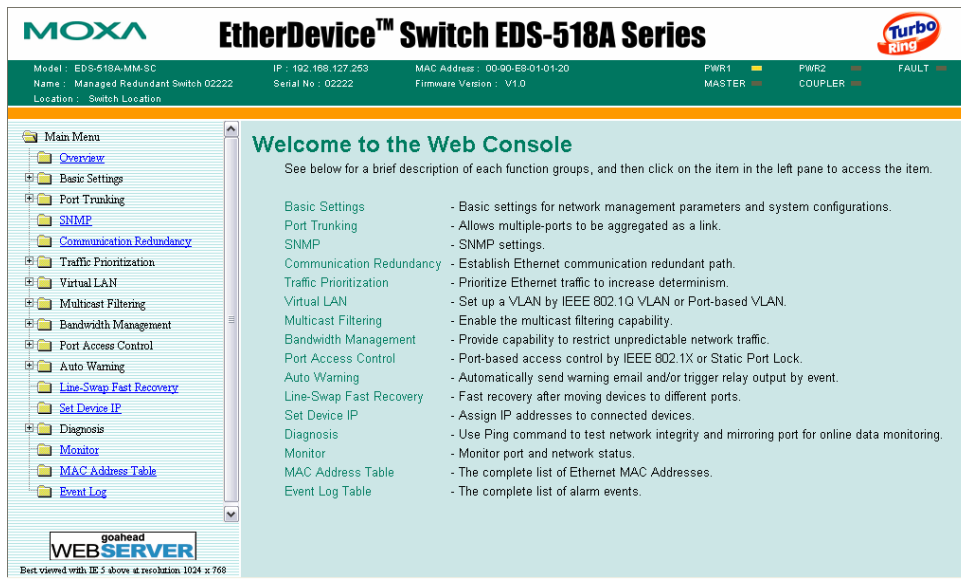

Disabling Telnet and Browser Access

If you are connecting EDS-518A to a public network, but do not intend to use its management functions over the network, we suggest disabling both **Telnet Console** and **Web Configuration** from the RS-232 Console's **Basic Settings** → **System Identification** page, as shown in the following figure.

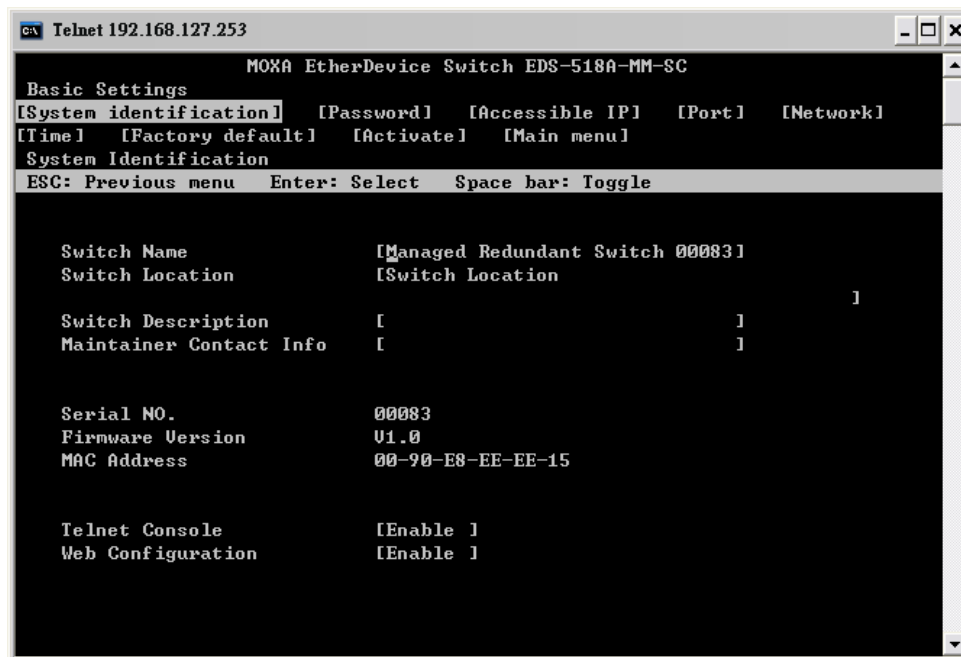

Featured Functions

This chapter explains how to access EDS-518A's various configuration, monitoring, and administration functions. There are three ways to access these functions: RS-232 console, Telnet console, and web browser. The serial console connection method, which requires using a short serial cable to connect EDS-518A to a PC's COM port, can be used if you do not know EDS-518A's IP address. The Telnet console and web browser connection methods can be used to access EDS-518A over an Ethernet LAN, or over the Internet.

The Web Console is the most user-friendly way to configure EDS-518A. In this chapter, we use the Web Console interface to introduce the functions. There are only a few differences between the Web Console, Serial Console, and Telnet Console.

The following topics are covered in this chapter:

- Configuring Basic Settings**
- Using Port Trunking**
- Configuring SNMP**
- Using Communication Redundancy**
- Using Traffic Prioritization**
- Using Virtual LAN**
- Using Multicast Filtering**
- Using Bandwidth Management**
- Using Port Access Control**
- Using Auto Warning**
- Using Line-Swap-Fast-Recovery**
- Using Set Device IP**
- Using Diagnosis**
- Using Monitor**
- Using the MAC Address Table**
- Using Event Log**
- Using HTTPS/SSL**

Configuring Basic Settings

The Basic Settings group includes the most commonly used settings required by administrators to maintain and control EDS-518A.

System Identification

The system identification items are displayed at the top of the web page, and will be included in alarm emails. Entering the system identification information makes it easier to identify the different switches connected to your network.

Switch Name

Setting	Description	Factory Default
Max. 30 Characters	This option is useful for specifying the role or application of different EDS-518A units. E.g., Factory Switch 1.	Managed Redundant Switch [Serial No. of this switch]

Switch Location

Setting	Description	Factory Default
Max. 80 Characters	To specify the location of different EDS-518A units. E.g., production line 1.	Switch Location

Switch Description

Setting	Description	Factory Default
Max. 30 Characters	Use this to enter a more detailed description of the EDS-518A unit.	None

Maintainer Contact Info

Setting	Description	Factory Default
Max. 30 Characters	To provide information about whom to contact in order to resolve problems. Use this to enter contact information of the person responsible for maintaining this EDS-518A.	None

Password

EDS-518A provides two levels of access privileges: **admin** privilege gives read/write access to all EDS-518A configuration parameters, and **user** privilege provides read access only. You will be able to view the configuration, but will not be able to make modifications.



ATTENTION

EDS-518A's default Password is not set (i.e., is blank). If a Password is already set, then you will be required to type the Password when logging into the RS-232 Console, Telnet Console, or Web Browser interface.

Account

Setting	Description	Factory Default
admin	"admin" privilege allows the user to <i>modify</i> all EDS-518A configurations.	admin
user	"user" privilege only allows <i>viewing</i> EDS-518A configurations.	

Password

Setting	Description	Factory Default
Old Password (Max. 16 Characters)	Type current password when changing the password	None
New Password (Max. 16 Characters)	Type new password when changing the password	None
Retype Password (Max. 16 Characters)	If you type a new password in the Password field, you will be required to retype the password in the Retype new password field before updating the new password.	None

Accessible IP

MOXA EDS-518A uses an IP address-based filtering method to control access to EDS-518A units.

Accessible IP List

Enable the accessible IP list ("Disable" will allow all IP's connection)

Index	IP	NetMask
1	<input type="text"/>	<input type="text"/>
2	<input type="text"/>	<input type="text"/>
3	<input type="text"/>	<input type="text"/>
4	<input type="text"/>	<input type="text"/>
5	<input type="text"/>	<input type="text"/>
6	<input type="text"/>	<input type="text"/>
7	<input type="text"/>	<input type="text"/>
8	<input type="text"/>	<input type="text"/>
9	<input type="text"/>	<input type="text"/>
10	<input type="text"/>	<input type="text"/>

Activate

Accessible IP Settings allows you to add or remove “Legal” remote host IP addresses to prevent unauthorized access. Access to EDS-518A is controlled by IP address. If a host’s IP address is in the accessible IP table, then the host will be allowed access to the EDS-518A. You can allow one of the following cases by setting this parameter:

- **Only one host with the specified IP address can access the EDS-518A**
E.g., enter “192.168.1.1/255.255.255.255” to allow access to *just* the IP address 192.168.1.1.
- **Any host on a specific subnetwork can access the EDS-518A**
E.g., enter “192.168.1.0/255.255.255.0” to allow access to all IPs on the subnet defined by this IP address/subnet mask combination.
- **Any host can access the EDS-518A**
Disable this function by deselecting the *Enable the accessible IP list* option.

The following table shows additional configuration examples:

Allowable Hosts	Input format
Any host	Disable
192.168.1.120	192.168.1.120 / 255.255.255.255
192.168.1.1 to 192.168.1.254	192.168.1.0 / 255.255.255.0
192.168.0.1 to 192.168.255.254	192.168.0.0 / 255.255.0.0
192.168.1.1 to 192.168.1.126	192.168.1.0 / 255.255.255.128
192.168.1.129 to 192.168.1.254	192.168.1.128 / 255.255.255.128

Port

Port settings are included to give the user control over Port Access, Port Transmission Speed, Flow Control, and Port Type (MDI or MDIX). An explanation of each configuration item follows:

Port Settings

Port	Enable	Description	Name	Speed	FDX Flow Ctrl	MDI/MDIX
1	<input checked="" type="checkbox"/>	100TX,RJ45.	<input type="text"/>	Auto	Disable	Auto
2	<input checked="" type="checkbox"/>	100TX,RJ45.	<input type="text"/>	Auto	Disable	Auto
3	<input checked="" type="checkbox"/>	100TX,RJ45.	<input type="text"/>	Auto	Disable	Auto
4	<input checked="" type="checkbox"/>	100TX,RJ45.	<input type="text"/>	Auto	Disable	Auto
5	<input checked="" type="checkbox"/>	100TX,RJ45.	<input type="text"/>	Auto	Disable	Auto
6	<input checked="" type="checkbox"/>	100TX,RJ45.	<input type="text"/>	Auto	Disable	Auto
7	<input checked="" type="checkbox"/>	100TX,RJ45.	<input type="text"/>	Auto	Disable	Auto
8	<input checked="" type="checkbox"/>	100TX,RJ45.	<input type="text"/>	Auto	Disable	Auto
9	<input checked="" type="checkbox"/>	100TX,RJ45.	<input type="text"/>	Auto	Disable	Auto
10	<input checked="" type="checkbox"/>	100TX,RJ45.	<input type="text"/>	Auto	Disable	Auto
11	<input checked="" type="checkbox"/>	100TX,RJ45.	<input type="text"/>	Auto	Disable	Auto
12	<input checked="" type="checkbox"/>	100TX,RJ45.	<input type="text"/>	Auto	Disable	Auto

Activate

Enable

Setting	Description	Factory Default
checked	Allows data transmission through the port.	enabled
unchecked	Immediately shuts off port access.	



ATTENTION

If a connected device or sub-network is wreaking havoc on the rest of the network, the **Disable** option under **Advanced Settings/Port** gives the administrator a quick way to shut off access through this port immediately.

Description

Setting	Description	Factory Default
Media type	Displays the media type for each module's port	N/A

Name

Setting	Description	Factory Default
Max. 63 Characters	Specify an alias for each port, and assist the administrator in remembering important information about the port. E.g., PLC 1	None

Speed

Setting	Description	Factory Default
Auto	Allows the port to use the IEEE 802.3u protocol to negotiate with connected devices. The port and connected devices will determine the best speed for that connection.	Auto
100M-Full	Choose one of these fixed speed options if the opposing Ethernet device has trouble auto-negotiating line speed.	
100M-Half		
10M-Full		
10M-Half		

FDX Flow Ctrl

This setting enables or disables the flow control capability of this port when the “port transmission speed” setting is in “auto” mode. The final result will be determined by the “auto” process between EDS-518A and connected devices.

Setting	Description	Factory Default
Enable	Enables flow control for this port when in auto-negotiate mode.	Disable
Disable	Disables flow control for this port when in auto-negotiate mode.	

MDI/MDIX

Setting	Description	Factory Default
Auto	Allows the port to auto detect the port type of the opposing Ethernet device and change the port type accordingly.	Auto
MDI	Choose the MDI or MDIX option if the opposing Ethernet device has trouble auto-negotiating port type.	
MDIX		

Network

The **Network** configuration allows users to modify the usual TCP/IP network parameters. An explanation of each configuration item follows.

Network Parameters

General Settings

Auto IP Configuration	Disable ▾
Switch IP Address	192.168.127.253
Switch Subnet Mask	255.255.255.0
Default Gateway	<input type="text"/>
1st DNS Server IP Address	<input type="text"/>
2nd DNS Server IP Address	<input type="text"/>

Auto IP Configuration

Setting	Description	Factory Default
Disable	Set up EDS-518A's IP address manually.	Disable
By DHCP	EDS-518A's IP address will be assigned automatically by the network's DHCP server.	
By BOOTP	EDS-518A's IP address will be assigned automatically by the network's BOOTP server.	

Switch IP Address

Setting	Description	Factory Default
IP Address of the EDS-518A	Identifies the EDS-518A on a TCP/IP network.	192.168.127.253

Switch Subnet Mask

Setting	Description	Factory Default
Subnet mask of the EDS-518A	Identifies the type of network to which the EDS-518A is connected (e.g., 255.255.0.0 for a Class B network, or 255.255.255.0 for a Class C network).	255.255.255.0

Default Gateway

Setting	Description	Factory Default
Default Gateway of the EDS-518A	The IP address of the router that connects the LAN to an outside network.	<i>None</i>

DNS IP Address

Setting	Description	Factory Default
1st DNS Server's IP Address	The IP address of the DNS Server used by your network. After entering the DNS Server's IP address, you can input EDS-518A's URL (e.g., www.eds.company.com) in your browser's address field, instead of entering the IP address.	<i>None</i>
2nd DNS Server's IP Address	The IP address of the DNS Server used by your network. EDS-518A will try to locate the 2nd DNS Server if the 1st DNS Server fails to connect.	<i>None</i>

Time

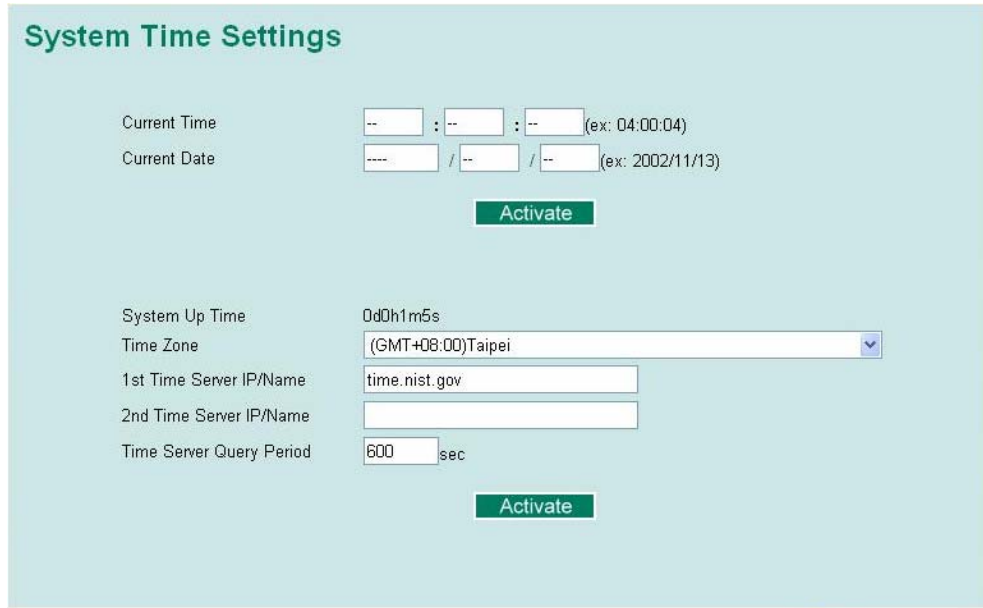

EDS-518A has a time calibration function based on information from an NTP server or user specified Time and Date information. Functions such as Auto warning “Email” can add real-time information to the message.

NOTE EDS-518A does not have a real time clock. The user must update the **Current Time** and **Current Date** to set the initial time for EDS-518A after each reboot, especially when the network does not have an Internet connection for an NTP server or there is no NTP server on the LAN.

Current Time

Setting	Description	Factory Default
User adjustable time.	The time parameter allows configuration of the local time in local 24-hour format.	None (hh:mm:ss)

Current Date

Setting	Description	Factory Default
User adjustable date.	The date parameter allows configuration of the local date in yyyy/mm/dd format.	None (yyyy/mm/dd)

System Up Time

Indicates EDS-518A’s up time from the last cold start. The unit is seconds.

Time Zone

Setting	Description	Factory Default
User selectable time zone	The time zone setting allows conversion from GMT (Greenwich Mean Time) to local time.	GMT (Greenwich Mean Time)

NOTE Changing the time zone will automatically correct the current time. You should **configure the time zone before setting the time.**

Time Server IP/Name

Setting	Description	Factory Default
1st Time Server IP/Name	IP or Domain address (e.g., 192.168.1.1 or time.stdtime.gov.tw or time.nist.gov).	None
2nd Time Server IP/Name	EDS-518A will try to locate the 2nd NTP Server if the 1st NTP Server fails to connect.	

Time Server Query Period

Setting	Description	Factory Default
Query Period	This parameter determines how frequently the time is updated from the NTP server.	600 seconds

System File Update—By Remote TFTP

MOXA EDS-518A supports saving your configuration file to a remote TFTP server or local host to allow other EDS-518A switches to use the same configuration at a later time, or saving the Log file for future reference. Loading pre-saved firmware or a configuration file from the TFTP server or local host is also supported for easy upgrading or configuration of EDS-518A.

Update System Files by TFTP

TFTP Server IP/Name

Configuration Files Path and Name Download Upload

Firmware Files Path and Name Download

Log Files Path and Name Upload

Activate

TFTP Server IP/Name

Setting	Description	Factory Default
IP Address of TFTP Server	The IP or name of the remote TFTP server. Must be set up before downloading or uploading files.	None

Configuration Files Path and Name

Setting	Description	Factory Default
Max. 40 Characters	The path and file name of EDS-518A's configuration file in the TFTP server.	None

Firmware Files Path and Name

Setting	Description	Factory Default
Max. 40 Characters	The path and file name of EDS-518A's firmware file.	None

Log Files Path and Name

Setting	Description	Factory Default
Max. 40 Characters	The path and file name of EDS-518A's log file	None

After setting up the desired path and file name, click **Activate** to save the setting, and then click **Download** to download the prepared file from the remote TFTP server, or click **Upload** to upload the desired file to the remote TFTP server.

System File Update—By Local Import/Export

Update System Files from Local PC

Configuration File

Log File

Upgrade Firmware

Upload Configure Data

Configuration File

To export the configuration file of this EDS-518A, click **Export** to save it to the local host.

Log File

To export the Log file of this EDS-518A, click **Export** and save it to the local host.

NOTE Some operating systems will open the configuration file and log file directly in the web page. In such cases, right click **Export** to save as a file.

Upgrade Firmware

To import the firmware file of this EDS-518A, click **Browse** to select the firmware file already saved on your computer. The upgrade procedure will proceed automatically after clicking **Import**.

Upload Configuration Data

To import the configuration file of this EDS-518A, click **Browse** to select the configuration file already saved on your computer. The upgrade procedure will proceed automatically after clicking **Import**.

Factory Default

Reset to Factory Default

This function will reset all settings to their factory default values.
Be aware that previous settings will be lost.

Activate

The Factory Default function is included to give users a quick way of restoring EDS-518A's configuration settings to their factory default values. This function is available in the Console utility (serial or Telnet), and Web Browser interface.

NOTE After activating the Factory Default function, you will need to use the default network settings to re-establish a web-browser or Telnet connection with your EDS-518A.

Using Port Trunking

Link Aggregation allows one or more links to be aggregated together to form a Link Aggregation Group. A MAC client can treat Link Aggregation Groups as if they were a single link.

EDS-518A's Port Trunking feature allows devices to communicate by aggregating up to 3 trunk groups, with a maximum of 8 ports for each group. If one of the 8 ports fails, the other seven ports will provide back up and share the traffic automatically.

Port trunking can be used to combine up to 8 ports between two EDS-518A switches. If all ports on both switch units are configured as 100BaseTX and they are operating in full duplex, the potential bandwidth of the connection will be 1600 Mbps.

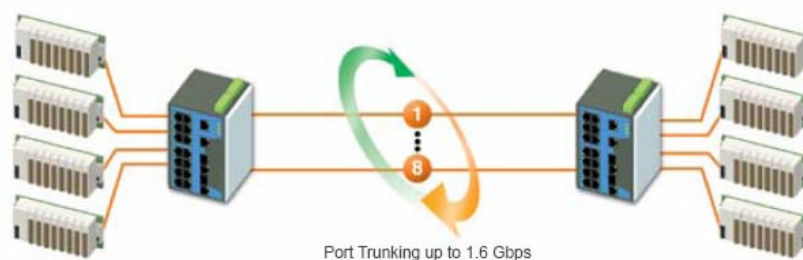

The Port Trunking Concept

MOXA has developed a proprietary Port Trunking protocol that provides the following benefits:

- Gives you more flexibility in setting up your network connections, since the bandwidth of a link can be doubled, tripled, or quadrupled.
- Provides redundancy—if one link is broken, the remaining trunked ports share the traffic within this trunk group.
- Load sharing—MAC Client traffic may be distributed across multiple links.
- To avoid broadcast storms or loops in your network while configuring a trunk, first disable or disconnect all ports that you want to add to the trunk or remove from the trunk. After you finish configuring the trunk, enable or re-connect the ports.

If all ports on both switch units are configured as 100BaseTX and they are operating in full duplex, the potential bandwidth of the connection will be up to 1.6 Gbps on the EDS-518A. This means that users can connect one EDS to another EDS by Port Trunking to double, triple, or quadruple the bandwidth of the connection.

When configuring Port Trunking, note that:

Each EDS-518A can set a maximum of 3 Port Trunking groups (Trk1/Trk2, 2 trunk groups for 10/100M ports and Trk3 for Gigabit ports)

When you activate Port Trunking settings, some advanced functions that you setup with the original ports will either be set to factory default values, or disabled:

- Communication Redundancy will be set to the factory default
- Traffic Prioritization will be set to the factory default
- Port-based VLAN or 802.1Q VLAN will be set to the factory default
- Multicast Filtering will be set to the factory default
- Rate Limiting will be set to the factory default
- Port Access Control will be set to the factory default
- Email and Relay Warning will be set to the factory default
- Set Device IP will be set to the factory default
- Mirror Port will be set to the factory default

You can setup these features again on your Trunking Port.

Configuring Port Trunking

The **Port Trunking Settings** page is used to assign ports to a Trunk Group.

Port Trunking Settings

Trunk Group: Trunk Type:

Member Ports

Port	Enable	Description	Name	Speed	FDX Flow Ctrl

Available Ports

Port	Enable	Description	Name	Speed	FDX Flow Ctrl
<input type="checkbox"/>	Yes	100TX,RJ45.		Auto	Enable
<input type="checkbox"/>	Yes	100TX,RJ45.		Auto	Enable
<input type="checkbox"/>	Yes	100TX,RJ45.		Auto	Enable
<input type="checkbox"/>	Yes	100TX,RJ45.		Auto	Enable

Step 1: Select Trk1, Trk2, or Trk3 from the **Trunk Group** drop-down box.

Step 2: Select Static, or LACP from the **Trunk Type** drop-down box.

Step 3: Under **Member Ports** and **Available Ports**, select the specific ports.

Step 4: Use the **Up / Down** buttons to add/remove designated ports to/from a trunk group.

Trunk Group (Maximum of 3 trunk groups)

Setting	Description	Factory Default
Trk1, Trk2, Trk3	Display or designate the Trunk Type and Member Ports for Trunk Group 1, 2, 3.	Trk1

Trunk Type

Setting	Description	Factory Default
Static	Designated MOXA proprietary trunking protocol	Static
LACP	Designated LACP (IEEE 802.3ad, Link Aggregation Control Protocol)	Static

Available Ports/Member Port

Setting	Description	Factory Default
Member/Available Ports	Use Up/Down buttons to add/remove specific ports from available ports to/from trunk group.	N/A
Check box	Check to designate which ports to add or remove.	Unchecked
Port	Port number	N/A
Port description	Displays the media type for each module's port	N/A
Name	Max. 63 Characters	N/A
Speed	Indicates the transmission speed (100M-Full, 100M-Half, 10M-Full, or 10M-Half)	N/A
FDX Flow Control	Indicates if the FDX flow control of this port is "Enabled" or "Disabled."	N/A
Up	Add designated ports into trunk group from available ports.	N/A
Down	Remove designated ports from trunk group to available port.	N/A

Trunk Table

Trunk Group	Member Port	Status
Trk1 (Static)	1	Success
	2	Fail
	3	Fail

Trunk Table

Setting	Description
Trunk Group	Displays the Trunk Type and Trunk Group.
Member Port	Display which member ports belong to the trunk group.
Status	Success means port trunking is working properly. Fail means port trunking is not working properly. Standby means port trunking is working as a standby port. When there are more than eight ports trunked as a trunking group, the 9 th port will be the standby port.

Configuring SNMP

EDS-518A supports SNMP V1/V2c/V3. SNMP V1, and SNMP V2c use a community string match for authentication, which means that SNMP servers access all objects with read-only or read/write permissions using the community string *public/private* (default value). SNMP V3, which requires you to select an authentication level of MD5 or SHA, is the most secure protocol. You can also enable data encryption to enhance data security.

SNMP security modes and security levels supported by EDS-518A are shown in the following table. Select the security mode and level that will be used to communicate between the SNMP agent and manager.

Protocol Version	UI Setting	Authentication Type	Data Encryption	Method
SNMP V1, V2c	V1, V2c Read Community	Community string	No	Use a community string match for authentication
	V1, V2c Write/Read Community	Community string	No	Use a community string match for authentication
SNMP V3	No-Auth	No	No	Use account with admin or user to access objects
	MD5 or SHA	Authentication based on MD5 or SHA	No	Provides authentication based on HMAC-MD5, or HMAC-SHA algorithms. 8-character passwords are the minimum requirement for authentication.
	MD5 or SHA	Authentication based on MD5 or SHA	Data encryption key	Provides authentication based on HMAC-MD5 or HMAC-SHA algorithms, and data encryption key. 8-character passwords and a data encryption key are the minimum requirements for authentication and encryption.

These parameters are configured on the SNMP page. A more detailed explanation of each parameter follows.

SNMP Read/Write Settings

SNMP Versions

Setting	Description	Factory Default
V1, V2c, V3, or V1, V2c, or V3 only	Select the SNMP protocol version used to manage the switch.	V1, V2c

V1, V2c Read Community

Setting	Description	Factory Default
V1, V2c Read Community	Use a community string match with a maximum of 30 characters for authentication. The SNMP agent accesses all objects with read-only permissions using the community string <i>public</i> .	public

V1, V2c Write/Read Community

Setting	Description	Factory Default
V1, V2c Read/Write Community	Uses a community string match with a maximum of 30 characters for authentication. The SNMP servers access all objects with read/write permissions using the community string <i>private</i> .	private

For SNMP V3, there are two levels of privileges for different accounts to access the EDS-518A. **Admin** privilege allows access, and authorization to read and write the MIB file. **User** privilege only allows reading the MIB file, but does not have authorization to write.

Admin Auth. Type (for SNMP V1, V2c, V3, and V3 only)

Setting	Description	Factory Default
No-Auth	Use admin. account to access objects. No authentication	No
MD5-Auth	Provide authentication based on the HMAC-MD5 algorithms. 8-character passwords are the minimum requirement for authentication.	No
SHA-Auth	Provide authentication based on the HMAC-SHA algorithms. 8-character passwords are the minimum requirement for authentication.	No

Admin Data Encryption Key (for SNMP V1, V2c, V3, and V3 only)

Setting	Description	Factory Default
Enable	8-character data encryption key is the minimum requirement for data encryption (maximum of 30 characters)	No
Disable	No data encryption	No

User Auth. Type (for SNMP V1, V2c, V3 and V3 only)

Setting	Description	Factory Default
No-Auth	Use admin account or user account to access objects. No authentication.	No
MD5-Auth	Provides authentication based on the HMAC-MD5 algorithms. 8-character passwords are the minimum requirement for authentication.	No
SHA-Auth	Provides authentication based on the HMAC-SHA algorithms. 8-character passwords are the minimum requirement for authentication.	No

User Data Encryption Key (for SNMP V1, V2c, V3 and V3 only)

Setting	Description	Factory Default
Enable	8-character data encryption key is the minimum requirement for data encryption (maximum of 30 characters)	No
Disable	No data encryption	No

Trap Settings

1st Trap Server IP/Name

Setting	Description	Factory Default
IP or Name	Enter the IP address or name of the 1 st Trap Server used by your network.	<i>None</i>

1st Trap Community

Setting	Description	Factory Default
character string	Use a community string match for authentication (maximum of 30 characters).	public

2nd Trap Server IP/Name

Setting	Description	Factory Default
IP or Name	Enter the IP address or name of the 2 nd Trap Server used by your network.	<i>None</i>

2nd Trap Community

Setting	Description	Factory Default
character string	Use a community string match for authentication (maximum of 30 characters).	public

Private MIB information

Switch Object ID

Setting	Description	Factory Default
8691.7.5	EDS-518A's enterprise value	Fixed

NOTE: *The Switch Object ID cannot be changed.*

Using Communication Redundancy

Setting up Communication Redundancy on your network helps protect critical links against failure, protects against network loops, and keeps network downtime at a minimum.

The Communication Redundancy function allows the user to set up *redundant loops* in the network to provide a backup data transmission route in the event that a cable is inadvertently disconnected or damaged. This is a particularly important feature for industrial applications, since it could take several minutes to locate the disconnected or severed cable. For example, if MOXA EDS-518A is used as a key communications component of a production line, several minutes of downtime could cause a big loss in production and revenue. MOXA EDS-518A supports two different protocols for this communication redundancy function—**Rapid Spanning Tree Protocol (IEEE-802.1w)** and **Turbo Ring**.

Turbo Ring and STP/RSTP cannot both be used on the network at the same time. The following table lists the key differences between each feature. Use this information to evaluate the benefits of each, and then determine which features are most suitable for your network.

	Turbo Ring	STP	RSTP
Topology	Ring	Ring, Mesh	Ring, Mesh
Recovery Time	< 300 ms	Up to 30 sec.	Up to 5 sec

Gigabit Ethernet Redundant Ring Capability (< 300 ms)

Ethernet has become the default data communications medium for industrial automation applications. In fact, Ethernet is often used to integrate video, voice, and high-rate industrial application data transfers into one network. MOXA EDS-518A, which comes equipped with a redundant Gigabit Ethernet protocol called Gigabit Turbo Ring, gives system maintainers a convenient means of setting up a versatile yet stable Gigabit Ethernet network. With Gigabit Turbo Ring, if any segment of the network gets disconnected, your automation system will be back to normal in less than 300 ms.



NOTE Port trunking and Turbo Ring can be enabled simultaneously to form a backbone. Doing so will increase the bandwidth of the backbone, and also provide redundancy. For example, suppose that two physical ports, 1 and 2, are trunked to form trunk group Trk1, and then Trk1 is set as one Turbo Ring path, if port 1 gets disconnected, the remaining trunked port, port 2, will share the traffic. If port 1 and port 2 are both disconnected, Turbo Ring will create the back up path within 300 ms.

The Turbo Ring Concept

The proprietary Turbo Ring protocol was developed by MOXA to optimize communication redundancy and achieve a faster recovery time on the network.

Turbo Ring protocol identifies one switch as the “master” of the network, and then automatically blocks packets from traveling through any of the network’s redundant loops. In the event that one branch of this ring gets disconnected from the rest of the network, the Turbo Ring protocol automatically readjusts the ring (if possible) so that the part of the network that was disconnected reestablishes contact with the rest of the network.

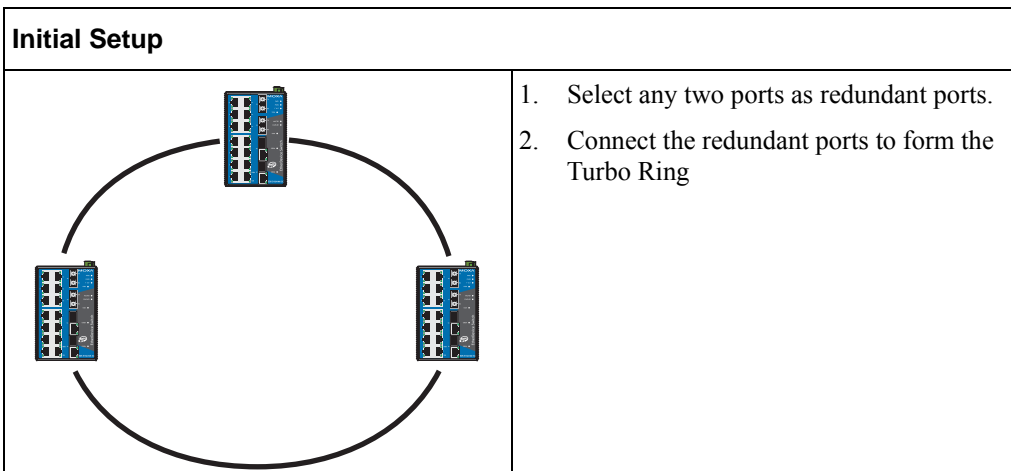

You do not need to set the Master to use Turbo Ring. Master is only needed to identify which segment acts as the backup path. The actual topology of the redundant ring, i.e., which segment will be blocked, is determined by the number of EDS-518A switches that make up the ring, and where the “Ring Master” is located.

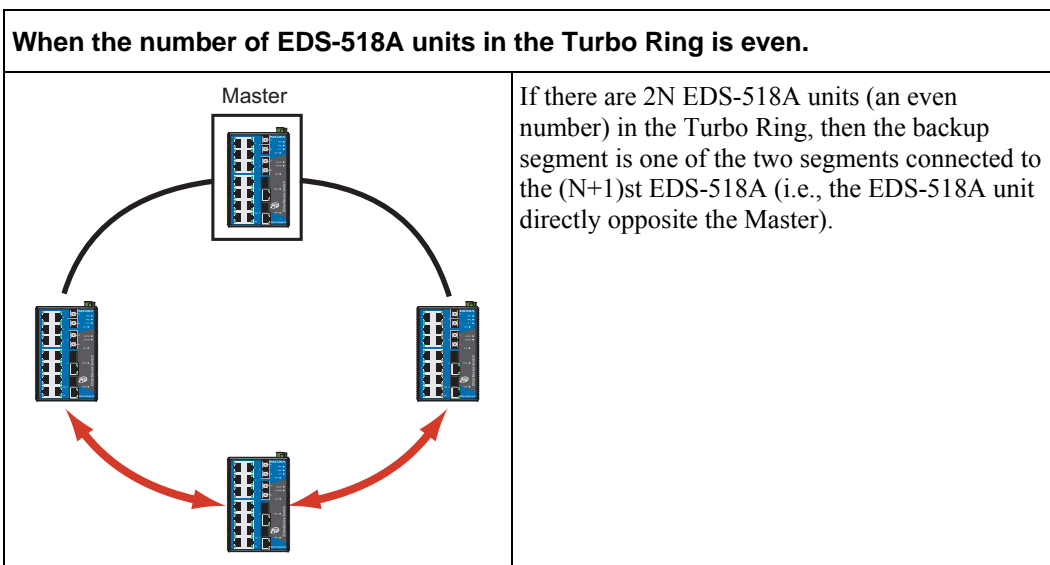

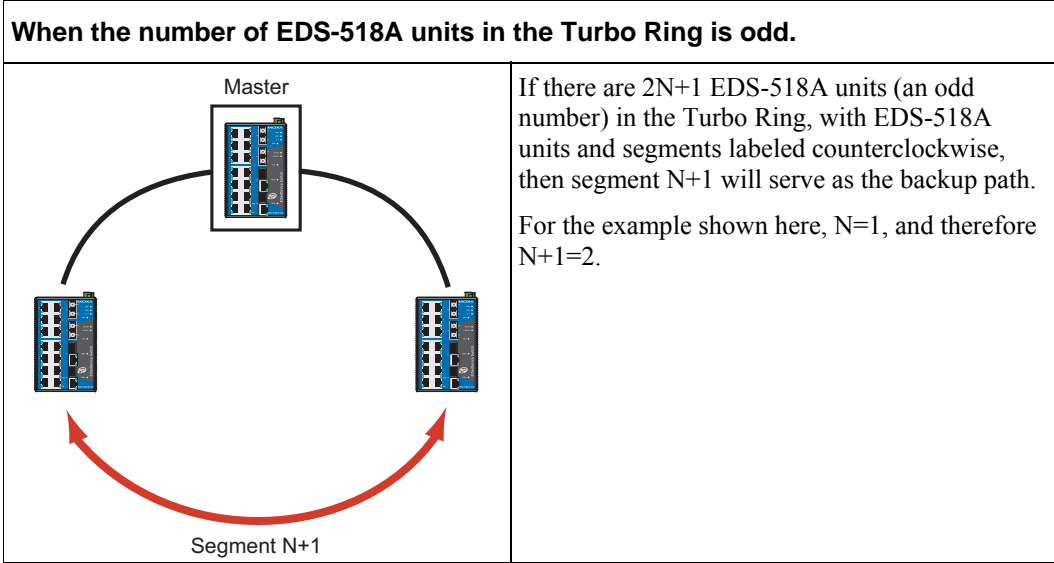

For some systems, it may not be convenient to connect all devices in the system to make one BIG redundant ring, since some devices could be located in a remote area. The “Ring Coupling” function of Turbo Ring can help you separate those distributed devices into different smaller redundant rings, but in such a way that they can still communicate with each other. The following figure illustrates how to couple two Turbo Rings.



ATTENTION

In a VLAN environment, you must set “Redundant Port,” “Coupling Port,” and “Coupling Control Port” as “Trunk Port,” since these ports act as the “backbone” to transmit all packets of different VLANs to different EDS-518A units.

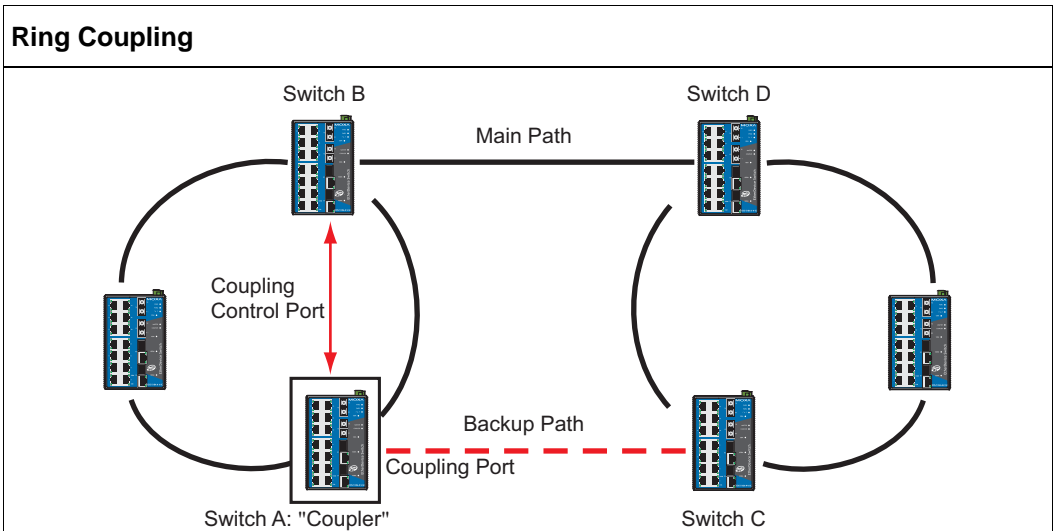

To support the Ring Coupling function, select two EDS-518A (e.g., Switch A and B in the above figure) in the Turbo Ring and another two EDS-518A in the adjacent Turbo Ring (e.g., Switch C and D).

Decide appropriate coupling ports in each switch and link them together. Next, assign one switch (e.g., Switch A) as coupler and set the proper coupling control port with another switch (e.g., Switch B) in the same Turbo Ring, and then connect them. The Coupler switch (e.g., Switch A) will monitor switch B through the coupling control port to decide if the coupling port's backup path should be recovered or not.



ATTENTION

The user only needs to enable the "Ring Coupling" function on one EDS-518A (not on the opposing EDS-518A or an adjacent EDS-518A). The Redundant Port, Coupling Port, and Coupling Control Port must all be assigned to different ports.

NOTE Ring Coupling and Ring Master do not need to be set up on the same EDS-518A.

Configuring Turbo Ring

Use the **Communication Redundancy** page to configure Turbo Ring.

Communication Redundancy

Current Status

Now Active	Turbo Ring	
Master/Slave	Master	
Redundant Ports Status	1st Port	Link down
	2nd Port	Link down
Ring Coupling Ports Status	Disabled	
Coupling Port	---	
Coupling Control Port	---	

Settings

Redundancy Protocol	Turbo Ring	
<input type="checkbox"/> Set as Master		
Redundant Ports 1st Port	G1	
2nd Port	G2	
<input type="checkbox"/> Enable Ring Coupling		
Coupling Port	2	
Coupling Control Port	1	

Activate

Now Active

This field shows which communication protocol is in use: Turbo Ring, RSTP, or neither.

Master/Slave

This field appears only when Turbo Ring mode is selected for Redundancy Protocol. It indicates if this EDS-518A is or is not the Master of the Turbo Ring.

NOTE The user does not need to set the master to use Turbo Ring, only to assign which segment serves as the backup path.

The master will be determined automatically if the user does not set a dedicated master for the Turbo Ring.

Redundant Port Status

This field indicates the current status of redundant ports. The state is "Forwarding" for normal transmission, "Blocked" for transmission that is stopped if this port is the backup path, and "Link down" for non-connection.

Ring Coupling

Indicates if the Ring Coupling function is "Enabled" or "Disabled."

Coupling Port Status

This indicates the current status of coupling ports. The state is "Forwarding" for normal transmission, "Blocked" for transmission that is stopped if this port is the backup path, and "Link down" for non-connection.

At the bottom of the page, the user can configure this function's "Settings." For Turbo Ring, the user can configure:

Redundancy Protocol

Setting	Description	Factory Default
Turbo Ring	Select this item to change to the Turbo Ring configuration page.	None
RSTP (IEEE 802.1W/1D)	Select this item to change to the RSTP configuration page.	None

Set as Master

Setting	Description	Factory Default
Enable/Disable	Select this EDS-518A as Master	None

Redundant Ports

Setting	Description	Factory Default
1st Port	Select any port of EDS-518A to be one of the redundant ports.	Port G1 if enabled for Turbo Ring
2nd Port	Select any port of EDS-518A to be one of the redundant ports.	Port G2 if enabled for Turbo Ring

Enable Ring Coupling

Setting	Description	Factory Default
Enable/Disable	Select this EDS-518A as Coupler	None

Coupling Ports

Setting	Description	Factory Default
Coupling Port	Select any port of EDS-518A to be the coupling port	Port 2 if enabled for Ring Coupling
Coupling Control Port	Select any port of EDS-518A to be the coupling control port	Port 1 if enabled for Ring Coupling

The STP/RSTP Concept

Spanning Tree Protocol (STP) was designed to help reduce link failures in a network, and provide protection from loops. Networks that have a complicated architecture are prone to broadcast storms caused by unintended loops in the network. MOXA EDS-518A's STP feature is disabled by default. To be completely effective, you must enable RSTP/STP on every EDS-518A connected to your network.

Rapid Spanning Tree Protocol (RSTP) implements the Spanning Tree Algorithm and Protocol defined by IEEE Std 802.1w-2001. RSTP provides the following benefits:

- The topology of a bridged network will be determined much more quickly compared to STP.
- RSTP is backward compatible with STP, making it relatively easy to deploy. For example:
 - Defaults to sending 802.1D style BPDUs if packets with this format are received.
 - STP (802.1D) and RSTP (802.1w) can operate on different ports of the same EDS-518A. This feature is particularly helpful when EDS-518A ports connect to older equipment, such as legacy switches.

You get essentially the same functionality with RSTP and STP. To see how the two systems differ, see the *Differences between RSTP and STP* section in this chapter.

NOTE The STP protocol is part of the IEEE Std 802.1D, 1998 Edition bridge specification. The following explanation uses bridge instead of switch.

What is STP?

STP (802.1D) is a bridge-based system that is used to implement parallel paths for network traffic. STP uses a loop-detection process to:

- Locate and then disable less efficient paths (i.e., paths that have a lower bandwidth).
- Enable one of the less efficient paths if the most efficient path fails.

The figure below shows a network made up of three LANs separated by three bridges. Each segment uses at most two paths to communicate with the other segments. Since this configuration can give rise to loops, the network will overload if STP is NOT enabled.

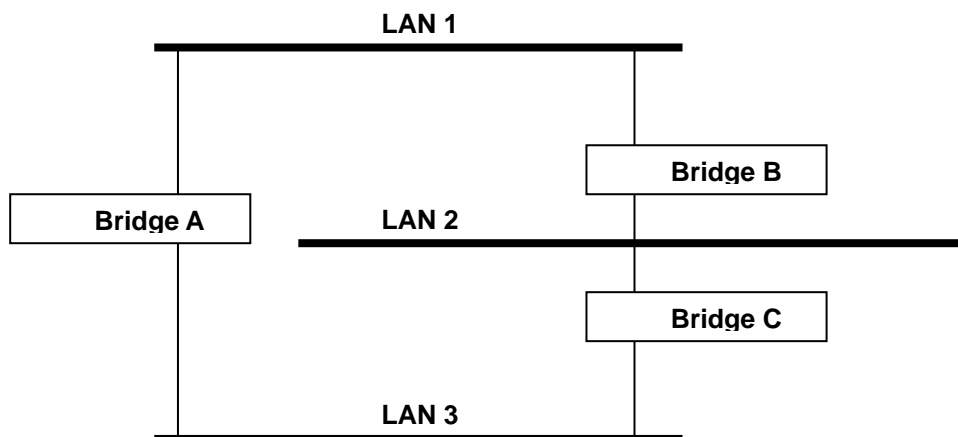

If STP is enabled, it will detect duplicate paths and prevent, or *block*, one of them from forwarding traffic. In the following example, STP determined that traffic from LAN segment 2 to LAN segment 1 should flow through Bridges C and A because this path has a greater bandwidth and is therefore more efficient.

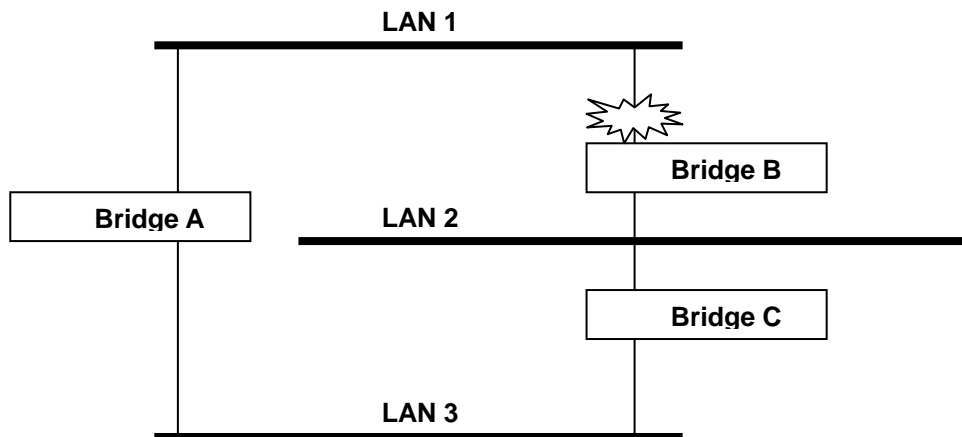

What happens if a link failure is detected? As shown in next figure, the STP process reconfigures the network so that traffic from LAN segment 2 flows through Bridge B.

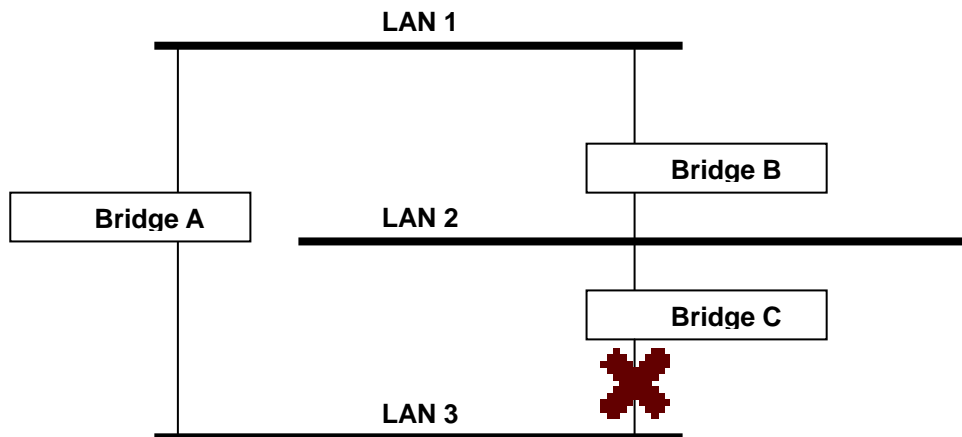

STP will determine which path between each bridged segment is most efficient, and then assigns a specific reference point on the network. When the most efficient path has been identified, the other paths are blocked. In the previous 3 figures, STP first determined that the path through Bridge C was the most efficient, and as a result, blocked the path through Bridge B. After the failure of Bridge C, STP re-evaluated the situation and opened the path through Bridge B.

How STP Works

When enabled, STP determines the most appropriate path for traffic through a network. The way it does this is outlined in the sections below.

STP Requirements

Before STP can configure the network, the system must satisfy the following requirements:

- Communication between all the bridges. This communication is carried out using Bridge Protocol Data Units (BPDUs), which are transmitted in packets with a known multicast address.
- Each bridge must have a Bridge Identifier that specifies which bridge acts as the central reference point, or Root Bridge, for the STP system—bridges with a lower Bridge Identifier are more likely to be designated as the Root Bridge. The Bridge Identifier is calculated using the MAC address of the bridge and a priority defined for the bridge. The default priority of EDS-518A is 32768.

- Each port has a cost that specifies the efficiency of each link. The efficiency cost is usually determined by the bandwidth of the link, with less efficient links assigned a higher cost. The following table shows the default port costs for a switch:

Port Speed	Path Cost 802.1D, 1998 Edition	Path Cost 802.1w-2001
10 Mbps	100	2,000,000
100 Mbps	19	200,000
1000 Mbps	4	20,000

STP Calculation

The first step of the STP process is to perform calculations. During this stage, each bridge on the network transmits BPDUs. The following items will be calculated:

- Which bridge should be the Root Bridge. The Root Bridge is the central reference point from which the network is configured.
- The Root Path Costs for each bridge. This is the cost of the paths from each bridge to the Root Bridge.
- The identity of each bridge's Root Port. The Root Port is the port on the bridge that connects to the Root Bridge via the most efficient path. In other words, the port connected to the Root Bridge via the path with the lowest Root Path Cost. The Root Bridge, however, does not have a Root Port.
- The identity of the Designated Bridge for each LAN segment. The Designated Bridge is the bridge with the lowest Root Path Cost from that segment. If several bridges have the same Root Path Cost, the one with the lowest Bridge Identifier becomes the Designated Bridge. Traffic transmitted in the direction of the Root Bridge will flow through the Designated Bridge. The port on this bridge that connects to the segment is called the Designated Bridge Port.

STP Configuration

After all the bridges on the network agree on the identity of the Root Bridge, and all other relevant parameters have been established, each bridge is configured to forward traffic only between its Root Port and the Designated Bridge Ports for the respective network segments. All other ports are blocked, which means that they will not be allowed to receive or forward traffic.

STP Reconfiguration

Once the network topology has stabilized, each bridge listens for Hello BPDUs transmitted from the Root Bridge at regular intervals. If a bridge does not receive a Hello BPDU after a certain interval (the Max Age time), the bridge assumes that the Root Bridge, or a link between itself and the Root Bridge, has gone down. This will trigger the bridge to reconfigure the network to account for the change. If you have configured an SNMP trap destination, when the topology of your network changes, the first bridge to detect the change sends out an SNMP trap.

Differences between RSTP and STP

RSTP is similar to STP, but includes additional information in the BPDUs that allow each bridge to confirm that it has taken action to prevent loops from forming when it decides to enable a link to a neighboring bridge. Adjacent bridges connected via point-to-point links will be able to enable a link without waiting to ensure that all other bridges in the network have had time to react to the change. The main benefit of RSTP is that the configuration decision is made locally rather than network-wide, allowing RSTP to carry out automatic configuration and restore a link faster than STP.

STP Example

The LAN shown in the following figure has three segments, with adjacent segments connected using two possible links. The various STP factors, such as Cost, Root Port, Designated Bridge Port, and Blocked Port are shown in the figure.

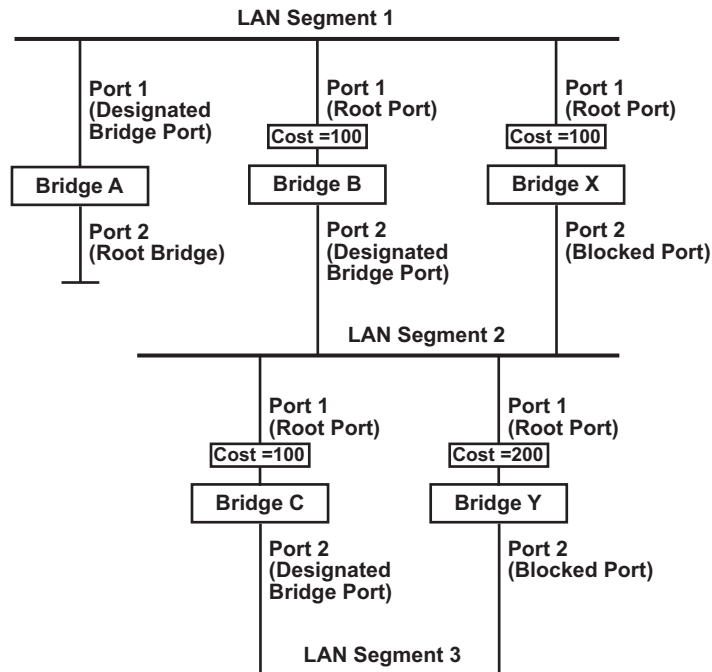

- Bridge A has been selected as the Root Bridge, since it was determined to have the lowest Bridge Identifier on the network.
- Since Bridge A is the Root Bridge, it is also the Designated Bridge for LAN segment 1. Port 1 on Bridge A is selected as the Designated Bridge Port for LAN Segment 1.
- Ports 1 of Bridges B, C, X, and Y are all Root Ports since they are nearest to the Root Bridge, and therefore have the most efficient path.
- Bridges B and X offer the same Root Path Cost for LAN segment 2. However, Bridge B was selected as the Designated Bridge for that segment since it has a lower Bridge Identifier. Port 2 on Bridge B is selected as the Designated Bridge Port for LAN Segment 2.
- Bridge C is the Designated Bridge for LAN segment 3, because it has the lowest Root Path Cost for LAN Segment 3:
 - The route through Bridges C and B costs 200 (C to B=100, B to A=100)
 - The route through Bridges Y and B costs 300 (Y to B=200, B to A=100)
- The Designated Bridge Port for LAN Segment 3 is Port 2 on Bridge C.

Using STP on a Network with Multiple VLANs

IEEE Std 802.1D, 1998 Edition, does not take into account VLANs when calculating STP information—the calculations only depend on the physical connections. Consequently, some network configurations will result in VLANs being subdivided into a number of isolated sections by the STP system. You must ensure that every VLAN configuration on your network takes into account the expected STP topology and alternative topologies that may result from link failures.

The following figure shows an example of a network that contains VLANs 1 and 2. The VLANs are connected using the 802.1Q-tagged link between Switch B and Switch C. By default, this link has a port cost of 100 and is automatically blocked because the other Switch-to-Switch connections have a port cost of 36 (18+18). This means that both VLANs are now subdivided—VLAN 1 on Switch units A and B cannot communicate with VLAN 1 on Switch C, and VLAN 2 on Switch units A and C cannot communicate with VLAN 2 on Switch B.

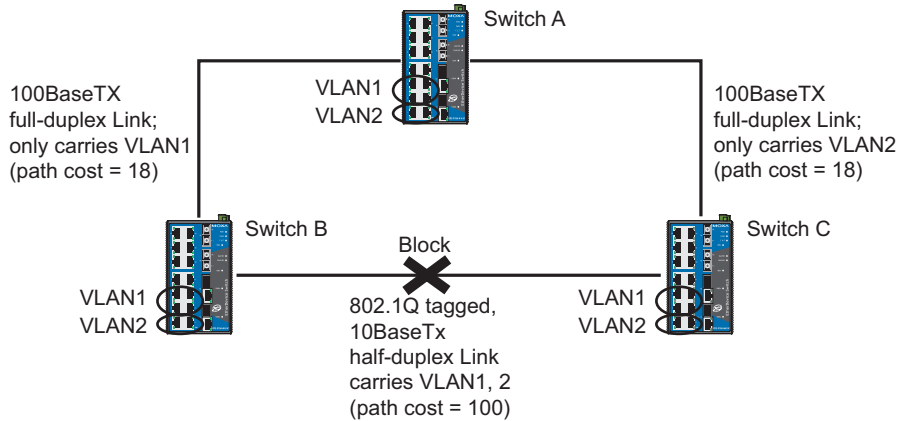

To avoid subdividing VLANs, all inter-switch connections should be made members of all available 802.1Q VLANs. This will ensure connectivity at all times. For example, the connections between Switches A and B, and between Switches A and C should be 802.1Q tagged and carrying VLANs 1 and 2 to ensure connectivity.

See the “Configuring Virtual LANs” section for more information about VLAN Tagging.

Configuring STP/RSTP

The following figures indicate which Spanning Tree Protocol parameters can be configured. A more detailed explanation of each parameter follows.

Communication Redundancy

Current Status

Now Active: **None**
 Root/Not root: ---

Settings

Redundancy Protocol: RSTP (IEEE 802.1W/1D) [v]
 Bridge Priority: 32768 [v] Hello Time: 2 [v]
 Forwarding Delay: 15 [v] Max Age: 20 [v]

Port	Enable RSTP	Port Priority	Port Cost	Status
1	<input type="checkbox"/>	128 [v]	200000 [v]	---
2	<input type="checkbox"/>	128 [v]	200000 [v]	---
3	<input type="checkbox"/>	128 [v]	200000 [v]	---
4	<input type="checkbox"/>	128 [v]	200000 [v]	---
5	<input type="checkbox"/>	128 [v]	200000 [v]	---
6	<input type="checkbox"/>	128 [v]	200000 [v]	---

Activate

At the top of this page, the user can check the “Current Status” of this function. For RSTP, you will see:

Now Active:

This will show which communication protocol is being used—Turbo Ring, RSTP, or neither.

Root/Not Root

This field will appear only when selected to operate in RSTP mode. It indicates whether or not this EDS-518A is the Root of the Spanning Tree (the root is determined automatically).

At the bottom of this page, the user can configure the “Settings” of this function. For RSTP, you can configure:

Protocol of Redundancy

Setting	Description	Factory Default
Turbo Ring	Select this item to change to the Turbo Ring configuration page.	<i>None</i>
RSTP (IEEE 802.1W/1D)	Select this item to change to the RSTP configuration page.	<i>None</i>

Bridge priority

Setting	Description	Factory Default
Numerical value selected by user	Increase this device's bridge priority by selecting a lower number. A device with a higher bridge priority has a greater chance of being established as the root of the Spanning Tree topology.	32768

Forwarding Delay

Setting	Description	Factory Default
Numerical value input by user	The amount of time this device waits before checking to see if it should change to a different state.	15 (sec.)

Hello time (sec.)

Setting	Description	Factory Default
Numerical value input by user	The root of the Spanning Tree topology periodically sends out a “hello” message to other devices on the network to check if the topology is healthy. The “hello time” is the amount of time the root waits between sending hello messages.	2

Max. Age (sec.)

Setting	Description	Factory Default
Numerical value input by user	If this device is not the root, and it has not received a hello message from the root in an amount of time equal to “Max. Age,” then this device will reconfigure itself as a root. Once two or more devices on the network are recognized as a root, the devices will renegotiate to set up a new Spanning Tree topology.	20

Enable STP per Port

Setting	Description	Factory Default
Enable/Disable	Select to enable the port as a node on the Spanning Tree topology.	Disabled

NOTE We suggest not enabling the Spanning Tree Protocol once the port is connected to a device (PLC, RTU, etc.) as opposed to network equipment. The reason is that it will cause unnecessary negotiation.

Port Priority

Setting	Description	Factory Default
Numerical value selected by user	Increase this port's priority as a node on the Spanning Tree topology by entering a lower number.	128

Port Cost

Setting	Description	Factory Default
Numerical value input by user	Input a higher cost to indicate that this port is less suitable as a node for the Spanning Tree topology.	200000

Port Status

Indicates the current Spanning Tree status of this port. "Forwarding" for normal transmission, or "Blocking" to block transmission.

Configuration Limits of RSTP/STP

The Spanning Tree Algorithm places limits on three of the configuration items described previously:

$$[\text{Eq. 1}]: 1 \text{ sec} \leq \text{Hello Time} \leq 10 \text{ sec}$$

$$[\text{Eq. 2}]: 6 \text{ sec} \leq \text{Max. Age} \leq 40 \text{ sec}$$

$$[\text{Eq. 3}]: 4 \text{ sec} \leq \text{Forwarding Delay} \leq 30 \text{ sec}$$

These three variables are further restricted by the following two inequalities:

$$[\text{Eq. 4}]: 2 * (\text{Hello Time} + 1 \text{ sec}) \leq \text{Max. Age} \leq 2 * (\text{Forwarding Delay} - 1 \text{ sec})$$

MOXA EDS-518A's firmware will alert you immediately if any of these restrictions are violated. For example, setting

Hello Time = 5 sec, Max. Age = 20 sec, and Forwarding Delay = 4 sec does not violate Eqs. 1 through 3, but does violate Eq. 4, since in this case,

$$2 * (\text{Hello Time} + 1 \text{ sec}) = 12 \text{ sec}, \text{ and } 2 * (\text{Forwarding Delay} - 1 \text{ sec}) = 6 \text{ sec}.$$

You can remedy the situation in many ways. One solution is simply to increase the Forwarding Delay value to at least 11 sec.

HINT: Perform the following steps to avoid guessing:

Step 1: Assign a value to "Hello Time" and then calculate the left most part of Eq. 4 to get the lower limit of "Max. Age."

Step 2: Assign a value to "Forwarding Delay" and then calculate the right most part of Eq. 4 to get the upper limit for "Max. Age."

Step 3: Assign a value to "Forwarding Delay" that satisfies the conditions in Eq. 3 and Eq. 4.

Using Traffic Prioritization

EDS-518A's traffic prioritization capability provides Quality of Service (QoS) to your network by making data delivery more reliable. You can prioritize traffic on your network to ensure that high priority data is transmitted with minimum delay. Traffic can be controlled by a set of rules to obtain the required Quality of Service for your network. The rules define different types of traffic and specify how each type should be treated as it passes through the switch. MOXA EDS-518A can inspect both IEEE 802.1p/1Q layer 2 CoS tags, and even layer 3 TOS information to provide consistent classification of the entire network. EDS-518A's QoS capability improves the performance and determinism of industrial networks for mission critical applications.

The Traffic Prioritization Concept

What is Traffic Prioritization?

Traffic prioritization allows you to prioritize data so that time-sensitive and system-critical data can be transferred smoothly and with minimal delay over a network. The benefits of using traffic prioritization are:

- Improve network performance by controlling a wide variety of traffic and managing congestion.
- Assign priorities to different categories of traffic. For example, set higher priorities for time-critical or business-critical applications.
- Provide predictable throughput for multimedia applications, such as video conferencing or voice over IP, and minimize traffic delay and jitter.
- Improve network performance as the amount of traffic grows. This will save cost by reducing the need to keep adding bandwidth to the network.

How Traffic Prioritization Works

Traffic prioritization uses the four traffic queues that are present in your EDS-518A to ensure that high priority traffic is forwarded on a different queue from lower priority traffic. This is what provides Quality of Service (QoS) to your network.

EDS-518A traffic prioritization depends on two industry-standard methods:

- **IEEE 802.1D**—a layer 2 marking scheme.
- **Differentiated Services (DiffServ)**—a layer 3 marking scheme.

IEEE 802.1D Traffic Marking

The IEEE Std 802.1D, 1998 Edition marking scheme, which is an enhancement to IEEE Std 802.1D, enables Quality of Service on the LAN. Traffic service levels are defined in the IEEE 802.1Q 4-byte tag, which is used to carry VLAN identification as well as IEEE 802.1p priority information. The 4-byte tag immediately follows the destination MAC address and Source MAC address.

The IEEE Std 802.1D, 1998 Edition priority marking scheme assigns an IEEE 802.1p priority level between 0 and 7 to each frame. This determines the level of service that that type of traffic should receive. Refer to the table below for an example of how different traffic types can be mapped to the eight IEEE 802.1p priority levels.

IEEE 802.1p Priority Level	IEEE 802.1D Traffic Type
0	Best Effort (default)
1	Background
2	Standard (spare)
3	Excellent Effort (business critical)
4	Controlled Load (streaming multimedia)
5	Video (interactive media); less than 100 milliseconds of latency and jitter
6	Voice (interactive voice); less than 10 milliseconds of latency and jitter
7	Network Control Reserved traffic

Even though the IEEE 802.1D standard is the most widely used prioritization scheme in the LAN environment, it still has some restrictions:

- It requires an additional 4-byte tag in the frame, which is normally optional in Ethernet networks. Without this tag, the scheme cannot work.
- The tag is part of the IEEE 802.1Q header, so to implement QoS at layer 2, the entire network must implement IEEE 802.1Q VLAN tagging.

It is only supported on a LAN and not routed across WAN links, since the IEEE 802.1Q tags are removed when the packets pass through a router.

Differentiated Services (DiffServ) Traffic Marking

DiffServ is a Layer 3 marking scheme that uses the DiffServ Code Point (DSCP) field in the IP header to store the packet priority information. DSCP is an advanced intelligent method of traffic marking as you can choose how your network prioritizes different types of traffic. DSCP uses 64 values that map to user-defined service levels, allowing you to establish more control over network traffic.

Advantages of DiffServ over IEEE 802.1D are:

- Configure how you want your switch to treat selected applications and types of traffic by assigning various grades of network service to them.
- No extra tags are required in the packet.
- DSCP uses the IP header of a packet and therefore priority is preserved across the Internet.
- DSCP is backward compatible with IPV4 TOS, which allows operation with existing devices that use a layer 3 TOS enabled prioritization scheme.

Traffic Prioritization

EDS-518A classifies traffic based on layer 2 of the OSI 7 layer model, and the switch prioritizes received traffic according to the priority information defined in the received packet. Incoming traffic is classified based upon the IEEE 802.1D frame and is assigned to the appropriate priority queue based on the IEEE 802.1p service level value defined in that packet. Service level markings (values) are defined in the IEEE 802.1Q 4-byte tag, and consequently traffic will only contain 802.1p priority markings if the network is configured with VLANs and VLAN tagging. The traffic flow through the switch is as follows:

1. A packet received by the EDS-518A may or may not have an 802.1p tag associated with it. If it does not, then it is given a default 802.1p tag (which is usually 0). Alternatively, the packet may be marked with a new 802.1p value, which will result in all knowledge of the old 802.1p tag being lost.

- As the 802.1p priority levels are fixed to the traffic queues, the packet will be placed in the appropriate priority queue, ready for transmission through the appropriate egress port. When the packet reaches the head of its queue and is about to be transmitted, the device determines whether or not the egress port is tagged for that VLAN. If it is, then the new 802.1p tag is used in the extended 802.1D header.

The EDS-518A will check a packet received at the ingress port for IEEE 802.1D traffic classification, and then prioritize it based upon the IEEE 802.1p value (service levels) in that tag. It is this 802.1p value that determines to which traffic queue the packet is mapped.

Traffic Queues

The EDS-518A hardware has multiple traffic queues that allow packet prioritization to occur. Higher priority traffic can pass through the EDS-518A without being delayed by lower priority traffic. As each packet arrives in the EDS-518A, it passes through any ingress processing (which includes classification, marking/re-marking), and is then sorted into the appropriate queue. The switch then forwards packets from each queue.

EDS-518A supports two different queuing mechanisms:

- **Weight Fair:** This method services all the traffic queues, giving priority to the higher priority queues. Under most circumstances, this method gives high priority precedence over low-priority, but in the event that high-priority traffic exceeds the link capacity, lower priority traffic is not blocked.
- **Strict:** This method services high traffic queues first; low priority queues are delayed until no more high priority data needs to be sent. This method always gives precedence to high priority over low-priority.

Configuring Traffic Prioritization

Quality of Service (QoS) provides a traffic prioritization capability to ensure that important data is delivered consistently and predictably. EDS-518A Series can inspect IEEE 802.1p/1Q layer 2 CoS tags, and even layer 3 TOS information, to provide a consistent classification of the entire network. EDS-518A Series' QoS capability improves your industrial network's performance and determinism for mission critical applications.

QoS Classification

QoS Classification

Queuing Mechanism: Weight Fair(8:4:2:1)

Port	Port Highest Priority	Inspect ToS	Inspect CoS
1	<input type="checkbox"/>	<input checked="" type="checkbox"/>	<input checked="" type="checkbox"/>
2	<input type="checkbox"/>	<input checked="" type="checkbox"/>	<input checked="" type="checkbox"/>
3	<input type="checkbox"/>	<input checked="" type="checkbox"/>	<input checked="" type="checkbox"/>
4	<input type="checkbox"/>	<input checked="" type="checkbox"/>	<input checked="" type="checkbox"/>
5	<input type="checkbox"/>	<input checked="" type="checkbox"/>	<input checked="" type="checkbox"/>
6	<input type="checkbox"/>	<input checked="" type="checkbox"/>	<input checked="" type="checkbox"/>
7	<input type="checkbox"/>	<input checked="" type="checkbox"/>	<input checked="" type="checkbox"/>
8	<input type="checkbox"/>	<input checked="" type="checkbox"/>	<input checked="" type="checkbox"/>
9	<input type="checkbox"/>	<input checked="" type="checkbox"/>	<input checked="" type="checkbox"/>
10	<input type="checkbox"/>	<input checked="" type="checkbox"/>	<input checked="" type="checkbox"/>
11	<input type="checkbox"/>	<input checked="" type="checkbox"/>	<input checked="" type="checkbox"/>
12	<input type="checkbox"/>	<input checked="" type="checkbox"/>	<input checked="" type="checkbox"/>
13	<input type="checkbox"/>	<input checked="" type="checkbox"/>	<input checked="" type="checkbox"/>

Activate

MOXA EDS-518A supports inspection of layer 3 TOS and/or layer 2 CoS tag information to determine how to classify traffic packets.

Queuing Mechanism

Setting	Description	Factory Default
Weighted Fair	EDS-518A has 4 priority queues. In the weighted fair scheme, an 8, 4, 2, 1 weighting is applied to the four priorities. This approach prevents the lower priority frames from being starved of opportunity for transmission with only a slight delay to the higher priority frames.	Weight Fair
Strict	In the Strict-priority scheme, all top-priority frames egress a port until that priority's queue is empty, and then the next lower priority queue's frames egress. This approach can cause the lower priorities to be starved of opportunity for transmitting any frames but ensures all high priority frames to egress the switch as soon as possible.	

Port Highest Priority

Setting	Description	Factory Default
Enable/Disable	Set the Port Priority of the ingress frames to "High" queues.	Disable

Inspect TOS

Setting	Description	Factory Default
Enable/Disable	Select the option to enable EDS-518A to inspect the Type of Service (TOS) bits in IPV4 frame to determine the priority of each frame.	Enable

Inspect COS

Setting	Description	Factory Default
Enable/Disable	Select the option to enable EDS-518A to inspect the 802.1p COS tag in the MAC frame to determine the priority of each frame.	Enable

NOTE The priority of an ingress frame is determined in order by:

1. Port Highest Priority
2. Inspect TOS
3. Inspect CoS

NOTE The designer can enable these classifications individually or in combination. For instance, if a 'hot,' higher priority port is required for a network design, "Inspect TOS" and "Inspect CoS" can be disabled. This setting leaves only port default priority active, which results in all ingress frames being assigned the same priority on that port.

CoS Mapping

Mapping Table of CoS Value and Priority Queues

CoS	Priority Queue
0	Low
1	Low
2	Normal
3	Normal
4	Medium
5	Medium
6	High
7	High

Activate

Setting	Description	Factory
Low/Normal/ Medium/High	Set the mapping table of different CoS values to 4 different egress queues.	0: Low 1: Low 2: Normal 3: Normal 4: Medium 5: Medium 6: High 7: High

TOS/DiffServ Mapping

Mapping Table of ToS (DSCP) Value and Priority Queues

ToS	Level	ToS	Level	ToS	Level	ToS	Level
0x00(1)	Low	0x04(2)	Low	0x08(3)	Low	0x0C(4)	Low
0x10(5)	Low	0x14(6)	Low	0x18(7)	Low	0x1C(8)	Low
0x20(9)	Low	0x24(10)	Low	0x28(11)	Low	0x2C(12)	Low
0x30(13)	Low	0x34(14)	Low	0x38(15)	Low	0x3C(16)	Low
0x40(17)	Normal	0x44(18)	Normal	0x48(19)	Normal	0x4C(20)	Normal
0x50(21)	Normal	0x54(22)	Normal	0x58(23)	Normal	0x5C(24)	Normal
0x60(25)	Normal	0x64(26)	Normal	0x68(27)	Normal	0x6C(28)	Normal
0x70(29)	Normal	0x74(30)	Normal	0x78(31)	Normal	0x7C(32)	Normal
0x80(33)	Medium	0x84(34)	Medium	0x88(35)	Medium	0x8C(36)	Medium
0x90(37)	Medium	0x94(38)	Medium	0x98(39)	Medium	0x9C(40)	Medium
0xA0(41)	Medium	0xA4(42)	Medium	0xA8(43)	Medium	0xAC(44)	Medium
0xB0(45)	Medium	0xB4(46)	Medium	0xB8(47)	Medium	0xBC(48)	Medium

Activate

Setting	Description	Factory Default
Low/Normal/ Medium/High	Set the mapping table of different TOS values to 4 different egress queues.	1 to 16: Low 17 to 32: Normal 33 to 48: Medium 49 to 64: High

Using Virtual LAN

Setting up Virtual LANs (VLANs) on your EDS-518A increases the efficiency of your network by dividing the LAN into logical segments, as opposed to physical segments. In general, VLANs are easier to manage.

The Virtual LAN (VLAN) Concept

What is a VLAN?

A VLAN is a group of devices that can be located anywhere on a network, but which communicate as if they are on the same physical segment. With VLANs, you can segment your network without being restricted by physical connections—a limitation of traditional network design. As an example, with VLANs you can segment your network according to:

- **Departmental groups**—You could have one VLAN for the Marketing department, another for the Finance department, and another for the Development department.
- **Hierarchical groups**—You could have one VLAN for directors, another for managers, and another for general staff.
- **Usage groups**—You could have one VLAN for e-mail users, and another for multimedia users.

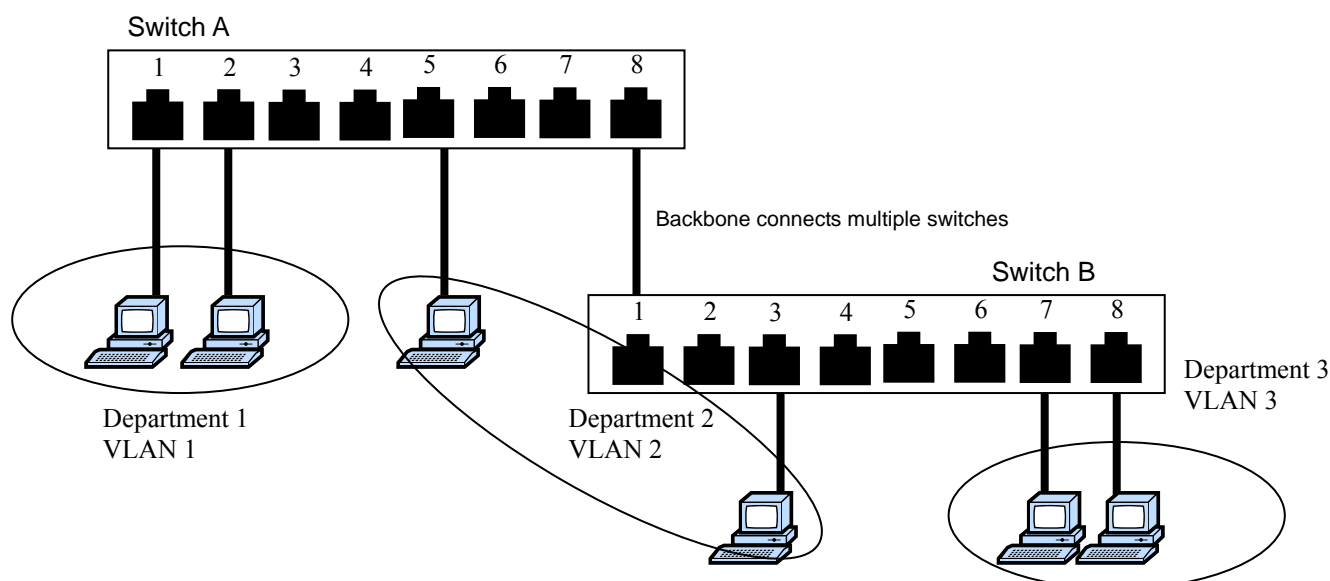

Benefits of VLANs

The main benefit of VLANs is that they provide a network segmentation system that is far more flexible than traditional networks. Using VLANs also provides you with three other benefits:

- **VLANs ease the relocation of devices on networks:** With traditional networks, network administrators spend most of their time dealing with moves and changes. If users move to a different subnetwork, the addresses of each host must be updated manually. With a VLAN setup, if a host on VLAN *Marketing*, for example, is moved to a port in another part of the network, and retains its original subnet membership, you only need to specify that the new port is on VLAN *Marketing*. You do not need to carry out any re-cabling.

- **VLANs provide extra security:** Devices within each VLAN can only communicate with other devices on the same VLAN. If a device on VLAN *Marketing* needs to communicate with devices on VLAN *Finance*, the traffic must pass through a routing device or Layer 3 switch.
- **VLANs help control traffic:** With traditional networks, congestion can be caused by broadcast traffic that is directed to all network devices, regardless of whether or not they need it. VLANs increase the efficiency of your network because each VLAN can be set up to contain only those devices that need to communicate with each other.

VLANs and MOXA EtherDevice Switch

Your EDS-518A provides support for VLANs using IEEE Std 802.1Q-1998. This standard allows traffic from multiple VLANs to be carried across one physical link. The IEEE Std 802.1Q-1998 standard allows each port on your EDS-518A to be placed in:

- Any one VLAN defined on the EDS-518A.
- Several VLANs at the same time using 802.1Q tagging.

The standard requires that you define the *802.1Q VLAN ID* for each VLAN on your EDS-518A before the switch can use it to forward traffic:

Managing a VLAN

A new or initialized EDS-518A contains a single VLAN—the Default VLAN. This VLAN has the following definition:

- *VLAN Name*—Management VLAN
- *802.1Q VLAN ID*—1 (if tagging is required)

All the ports are initially placed on this VLAN, and it is the only VLAN that allows you to access the management software of the EDS-518A over the network.

Communication Between VLANs

If devices connected to a VLAN need to communicate to devices on a different VLAN, a router or Layer 3 switching device with connections to both VLANs needs to be installed. Communication between VLANs can only take place if they are all connected to a routing or Layer 3 switching device.

VLANs: Tagged and Untagged Membership

EDS-518A supports 802.1Q VLAN tagging, a system that allows traffic for multiple VLANs to be carried on a single physical (backbone, trunk) link. When setting up VLANs you need to understand when to use untagged and tagged membership of VLANs. Simply put, if a port is on a single VLAN it can be an untagged member, but if the port needs to be a member of multiple VLANs, tagged membership must be defined.

A typical host (e.g., clients) will be untagged members of one VLAN, defined as “Access Port” in EDS-518A, while inter-switch connections will be tagged members of all VLANs, defined as “Trunk Port” in EDS-518A.

The IEEE Std 802.1Q-1998 defines how VLANs operate within an open packet-switched network. An 802.1Q compliant packet carries additional information that allows a switch to determine which VLAN the port belongs. If a frame is carrying the additional information, it is known as a *tagged* frame.

To carry multiple VLANs across a single physical (backbone, trunk) link, each packet must be tagged with a VLAN identifier so that the switches can identify which packets belong to which VLAN. To communicate between VLANs, a router must be used.

MOXA EDS-518A supports two types of VLAN port settings:

- **Access Port:** The port connects to a single device that is not tagged. The user must define the default port PVID that determines to which VLAN the device belongs. Once the ingress packet of this Access Port egresses to another Trunk Port (the port needs all packets to carry tag information), EDS-518A will insert this PVID into this packet to help the next 802.1Q VLAN switch recognize it.
- **Trunk Port:** The port connects to a LAN that consists of untagged devices/tagged devices and/or switches and hubs. In general, the traffic of the Trunk Port must have a Tag. Users can also assign PVID to a Trunk Port. The untagged packet on the Trunk Port will be assigned the port default PVID as its VID.

The following section illustrates how to use these ports to set up different applications.

Sample Applications of VLANs using MOXA EDS-518A

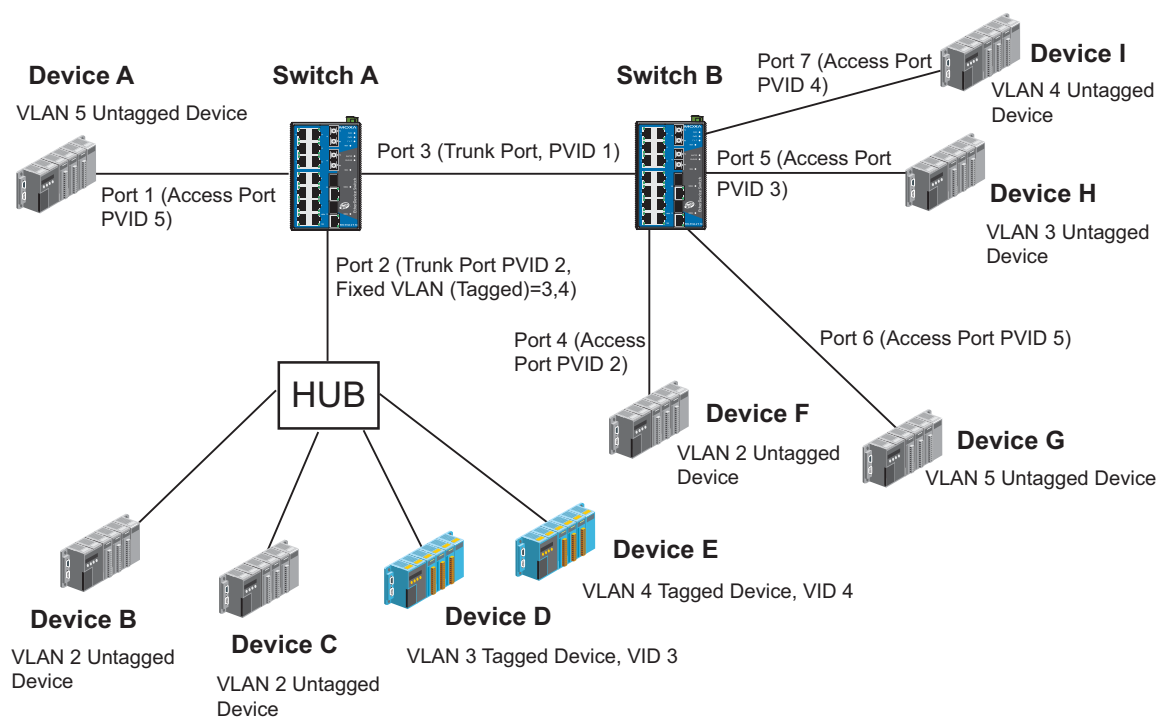

In this application,

- Port 1 connects a single untagged device and assigns it to VLAN 5; it should be configured as “Access Port” with PVID 5.
- Port 2 connects a LAN with two untagged devices belonging to VLAN 2. One tagged device with VID 3 and one tagged device with VID 4. It should be configured as “Trunk Port” with PVID 2 for untagged device and Fixed VLAN (Tagged) with 3 and 4 for tagged device. Since each port can only have one unique PVID, all untagged devices on the same port can only belong to the same VLAN.
- Port 3 connects with another switch. It should be configured as “Trunk Port.” GVRP protocol will be used through the Trunk Port.
- Port 4 connects a single untagged device and assigns it to VLAN 2; it should be configured as “Access Port” with PVID 2.
- Port 5 connects a single untagged device and assigns it to VLAN 3; it should be configured as “Access Port” with PVID 3.

- Port 6 connect a single untagged device and assigns it to VLAN 5; it should be configured as “Access Port” with PVID 5.
- Port 7 connects a single untagged device and assigns it to VLAN 4; it should be configured as “Access Port” with PVID 4.

After proper configuration:

- Packets from device A will travel through “Trunk Port 3” with tagged VID 5. Switch B will recognize its VLAN, pass it to port 6, and then remove tags received successfully by device G, and vice versa.
- Packets from device B and C will travel through “Trunk Port 3” with tagged VID 2. Switch B recognizes its VLAN, passes it to port 4, and then removes tags received successfully by device F, and vice versa.
- Packets from device D will travel through “Trunk Port 3” with tagged VID 3. Switch B will recognize its VLAN, pass to port 5, and then remove tags received successfully by device H. Packets from device H will travel through “Trunk Port 3” with PVID 3. Switch A will recognize its VLAN and pass it to port 2, but will not remove tags received successfully by device D.
- Packets from device E will travel through “Trunk Port 3” with tagged VID 4. Switch B will recognize its VLAN, pass it to port 7, and then remove tags received successfully by device I. Packets from device I will travel through “Trunk Port 3” with tagged VID 4. Switch A will recognize its VLAN and pass it to port 2, but will not remove tags received successfully by device E.

Configuring Virtual LAN

VLAN Settings

To configure EDS-518A's **802.1Q VLAN**, use the VLAN Setting page to configure the ports.

802.1Q VLAN Settings

VLAN Mode: 802.1Q VLAN

Management VLAN ID: 1

Port	Type	PVID	Fixed VLAN (Tagged)	Forbidden VLAN
1	Access	1		
2	Access	1		
3	Access	1		
4	Access	1		
5	Access	1		
6	Access	1		
7	Access	1		
8	Access	1		
9	Access	1		
10	Access	1		
11	Access	1		

Activate

VLAN Mode

Setting	Description	Factory Default
802.1Q VLAN	Set VLAN mode to 802.1Q VLAN	802.1Q VLAN
Port-based VLAN	Set VLAN mode to Port-based VLAN	

Management VLAN ID

Setting	Description	Factory Default
VLAN ID ranges from 1 to 4094	Set the management VLAN of this EDS-518A.	1

Port Type

Setting	Description	Factory Default
Access	This port type is used to connect single devices without tags.	Access
Trunk	Select "Trunk" port type to connect another 802.1Q VLAN aware switch or another LAN that combines tagged and/or untagged devices and/or other switches/hubs.	

**ATTENTION**

For communication redundancy in the VLAN environment, set "Redundant Port," "Coupling Port," and "Coupling Control Port" as "Trunk Port," since these ports act as the "backbone" to transmit all packets of different VLANs to different EDS-518A units.

Port PVID

Setting	Description	Factory Default
VID range from 1 to 4094	Set the port default VLAN ID for untagged devices that connect to the port.	1

Fixed VLAN List (Tagged)

Setting	Description	Factory Default
VID range from 1 to 4094	This field will be active only when selecting the "Trunk" port type. Set the other VLAN ID for tagged devices that connect to the "Trunk" port. Use commas to separate different VIDs.	None

Forbidden VLAN List

Setting	Description	Factory Default
VID range from 1 to 4094	This field will be active only when selecting the "Trunk" port type. Set the VLAN IDs that will not be supported by this trunk port. Use commas to separate different VIDs.	None

To configure EDS-518A's **Port-based VLAN**, use the VLAN Setting page to configure the ports.

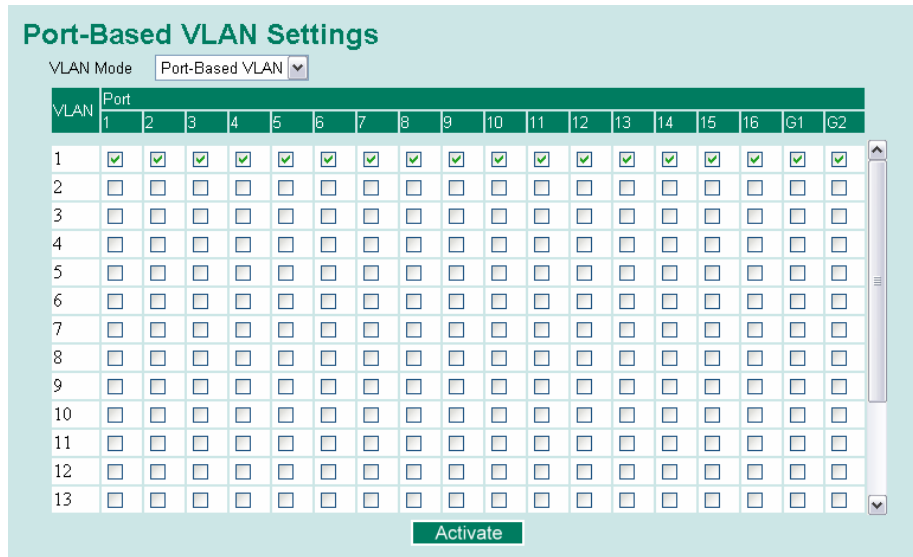

VLAN Mode

Setting	Description	Factory Default
802.1Q VLAN	Set VLAN mode to 802.1Q VLAN	802.1Q VLAN
Port-based VLAN	Set VLAN mode to Port-based VLAN	

Port

Setting	Description	Factory Default
Enable/Disable	Set port to specific VLAN Group.	Enable (all ports belong to VLAN1)

VLAN Table

VLAN Mode
VLAN Mode 802.1Q VLAN

Management VLAN
Management VLAN 1

Current 802.1Q VLAN List

Index	VLAN	Joined Access Port	Joined Trunk Port
1	1	1, 2, 3, 4, 5, 6, 7, 8, 9, 10, 11, 12, 13, 14, 15, 16, G1, G2,	

VLAN Mode
VLAN Mode Port-based VLAN

Current Port-based VLAN List

Index	VLAN	Joined Port
1	1	1, 2, 3, 4, 5, 6, 7, 8, 9, 10, 11, 12, 13, 14, 15, 16, G1, G2,

In 802.1Q VLAN table, you can review the VLAN groups that were created, Joined Access Ports, and Trunk Ports, and in Port-based VLAN table, you can review the VLAN group and Joined port.

NOTE The physical network can have a maximum of 64 VLAN settings.

Using Multicast Filtering

Multicast filtering improves the performance of networks that carry multicast traffic. This section explains multicasts, multicast filtering, and how multicast filtering can be implemented on your EDS-518A.

The Concept of Multicast Filtering

What is an IP Multicast?

A *multicast* is a packet sent by one host to multiple hosts. Only those hosts that belong to a specific multicast group will receive the multicast. If the network is set up correctly, a multicast can only be sent to an end-station or a subset of end-stations on a LAN or VLAN that belong to the multicast group. Multicast group members can be distributed across multiple subnets, so that multicast transmissions can occur within a campus LAN or over a WAN. In addition, networks that support IP multicast send only *one* copy of the desired information across the network until the delivery path that reaches group members diverges. To make more efficient use of network bandwidth, it is only at these points that multicast packets are duplicated and forwarded. A multicast packet has a multicast group address in the destination address field of the packet's IP header.

Benefits of Multicast

The benefits of using IP multicast are that it:

- Uses the most efficient, sensible method to deliver the same information to many receivers with only one transmission.
- Reduces the load on the source (for example, a server) since it will not need to produce several copies of the same data.
- Makes efficient use of network bandwidth and scales well as the number of multicast group members increases.
- Works with other IP protocols and services, such as Quality of Service (QoS).

Multicast transmission makes more sense and is more efficient than unicast transmission for some applications. For example, multicasts are often used for video-conferencing, since high volumes of traffic must be sent to several end-stations at the same time, but where broadcasting the traffic to all end-stations would cause a substantial reduction in network performance. Furthermore, several industrial automation protocols, such as Allen-Bradley, EtherNet/IP, Siemens Profibus, and Foundation Fieldbus HSE (High Speed Ethernet), use multicast. These industrial Ethernet protocols use publisher/subscriber communications models by multicasting packets that could flood a network with heavy traffic. IGMP Snooping is used to prune multicast traffic so that it travels only to those end destinations that require the traffic, reducing the amount of traffic on the Ethernet LAN.

Multicast Filtering

Multicast filtering ensures that only end-stations that have joined certain groups receive multicast traffic. With multicast filtering, network devices only forward multicast traffic to the ports that are connected to registered end-stations. The following two figures illustrate how a network behaves without multicast filtering, and with multicast filtering.

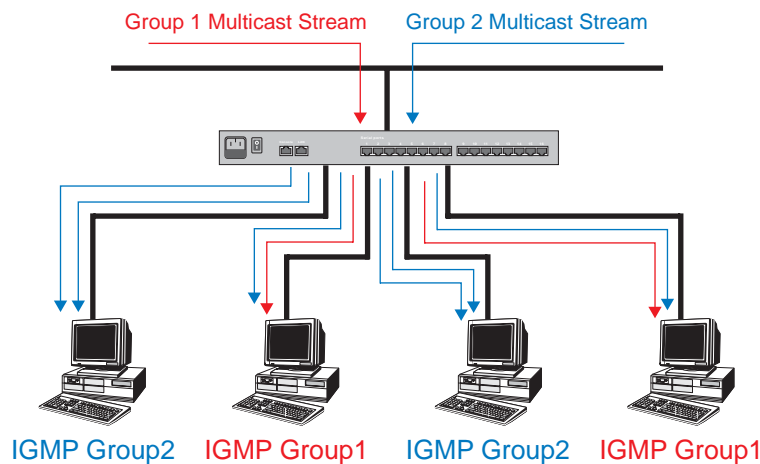
Network without multicast filtering

All hosts receive the multicast traffic, even if they don't need it.

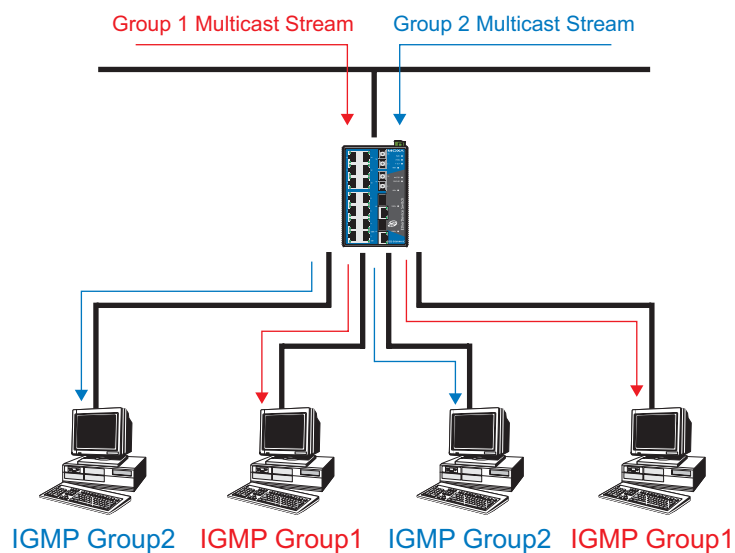
Network with multicast filtering

Hosts only receive dedicated traffic from other hosts belonging to the same group.

Multicast Filtering and MOXA EtherDevice Switch

EDS-518A has three ways to achieve multicast filtering: IGMP (Internet Group Management Protocol) Snooping, GMRP (GARP Multicast Registration Protocol), and adding a static multicast MAC manually to filter multicast traffic automatically.

IGMP (Internet Group Management Protocol)

Snooping Mode

Snooping Mode allows your switch to forward multicast packets only to the appropriate ports. The switch "snoops" on exchanges between hosts and an IGMP device, such as a router, to find those ports that want to join a multicast group, and then configures its filters accordingly.

Query Mode

Query mode allows the EDS-518A to work as the Querier if it has the lowest IP address on the subnetwork to which it belongs. IGMP querying is enabled by default on the EDS-518A to help prevent interoperability issues with some multicast routers that may not follow the lowest IP address election method. Enable query mode to run multicast sessions on a network that does not contain IGMP routers (or queriers).

NOTE	EDS-518A is compatible with any device that conforms to the IGMP v2 and IGMP v3 device protocol.
------	--

IGMP Multicast Filtering

IGMP is used by IP-supporting network devices to register hosts with multicast groups. It can be used on all LANs and VLANs that contain a multicast capable IP router, and on other network devices that support multicast filtering. IGMP works as follows:

1. The IP router (or querier) periodically sends *query* packets to all end-stations on the LANs or VLANs that are connected to it. For networks with more than one IP router, the router with the lowest IP address is the querier. A switch with IP address lower than the IP address of any other IGMP queriers connected to the LAN or VLAN can become the IGMP querier.
2. When an IP host receives a query packet, it sends a *report* packet back that identifies the multicast group that the end-station would like to join.
3. When the report packet arrives at a port on a switch with *IGMP Snooping* enabled, the switch knows that the port should forward traffic for the multicast group, and then proceeds to forward the packet to the router.
4. When the router receives the report packet, it registers that the LAN or VLAN requires traffic for the multicast groups.
5. When the router forwards traffic for the multicast group to the LAN or VLAN, the switches only forward the traffic to ports that received a report packet.

GMRP (GARP Multicast Registration Protocol)

EDS-518A supports IEEE 802.1D-1998 GMRP (GARP Multicast Registration Protocol), which differs from IGMP (Internet Group Management Protocol). GMRP is a MAC-based multicast management protocol, whereas IGMP is IP-based. GMRP provides a mechanism that allows bridges and end stations to register or de-register Group membership information dynamically. GMRP functions similarly to GVRP, except that GMRP registers multicast addresses on ports. When a port receives a *GMRP-join* message, it will register the multicast address to its database if the multicast address is not registered, and all the multicast packets with that multicast address are able to be forwarded from this port. When a port receives a *GMRP-leave* message, it will de-register the multicast address from its database, and all the multicast packets with this multicast address are not able to be forwarded from this port.

Static Multicast MAC

Some devices may only support multicast packets, but not support either IGMP Snooping or GMRP. MOXA EDS-518A supports adding multicast groups manually to enable multicast filtering.

Enabling Multicast Filtering

Use the serial console or Web interface to enable or disable IGMP Snooping and IGMP querying. If IGMP Snooping is not enabled, then IP multicast traffic is always forwarded, flooding the network.

Configuring IGMP Snooping

IGMP Snooping provides the ability to prune multicast traffic so that it travels only to those end destinations that require that traffic, thereby reducing the amount of traffic on the Ethernet LAN.

IGMP Snooping Settings

IGMP Snooping Enable

Setting	Description	Factory Default
Enable/Disable	Select the option to enable the IGMP Snooping function globally .	Disabled

Query Interval

Setting	Description	Factory Default
Numerical value input by user	Set the query interval of the Querier function globally. Valid settings are from 20 to 600 seconds.	125 seconds

IGMP Snooping

Setting	Description	Factory Default
Enable/Disable	Select the option to enable the IGMP Snooping function per VLAN .	Enabled if IGMP Snooping Enabled Globally

Querier

Setting	Description	Factory Default
Enable/Disable	Select the option to enable EDS-518A's querier function.	Enabled if IGMP Snooping is Enabled Globally

Static Multicast Router Port

Setting	Description	Factory Default
Select/Deselect	Select the option to select which ports will connect to the multicast routers. It's active only when IGMP Snooping is enabled.	Disabled

NOTE At least one switch must be designated the Querier or enable IGMP snooping and GMRP when enabling Turbo Ring and IGMP snooping simultaneously.

IGMP Table

EDS-518A displays the current active IGMP groups that were detected.

Current Active IGMP Groups							
VID	Auto Learned Multicast Router Port	Static Multicast Router Port	Querier Connected Port	Act as Querier	Active IGMP Groups		
					IP	MAC	Members Port
1		1,2		Yes	239.255.255.250	01-00-5E-7F-FF-FA	4

The information includes **VID**, **Auto-learned Multicast Router Port**, **Static Multicast Router Port**, **Querier Connected Port**, and the **IP** and **MAC** addresses of active IGMP groups.

Add Static Multicast MAC

If required, MOXA EDS-518A also supports adding multicast groups manually.

Static Multicast MAC Address			
Current Static Multicast MAC Address List			
<input type="checkbox"/> All	Index	MAC Address	Join Port
<input type="checkbox"/>	1	01-00-5e-00-00-01	1,2,

Remove Select

Add New Static Multicast MAC Address to the List

MAC Address: - - - - -

Join Port: 1 2 3 4 5 6 7 8 9 10 11 12 13
 14 15 16 G1 G2

Activate

Add New Static Multicast Address to the List

Setting	Description	Factory Default
MAC Address	Input the multicast MAC address of this host.	None

MAC Address

Setting	Description	Factory Default
integer	Input the number of the VLAN to which the host with this MAC Address belongs.	None

Join Port

Setting	Description	Factory Default
Select/Deselect	Select the appropriate options to select the join ports for this multicast group.	None

Configuring GMRP

GMRP is a MAC-based multicast management protocol, whereas IGMP is IP-based. GMRP provides a mechanism that allows bridges and end stations to register or un-register Group membership information dynamically.

Port	GMRP
1	<input type="checkbox"/> Enable
2	<input type="checkbox"/> Enable
3	<input type="checkbox"/> Enable
4	<input type="checkbox"/> Enable
5	<input type="checkbox"/> Enable
6	<input type="checkbox"/> Enable
7	<input type="checkbox"/> Enable
8	<input type="checkbox"/> Enable
9	<input type="checkbox"/> Enable
10	<input type="checkbox"/> Enable
11	<input type="checkbox"/> Enable
12	<input type="checkbox"/> Enable

Activate

GMRP enable

Setting	Description	Factory Default
Enable/Disable	Select the option to enable the GMRP function for the port listed in the Port column	Disable

GMRP Table

EDS-518A displays the current active GMRP groups that were detected.

	Multicast Address	Fixed Ports	Learned Ports
1	01-00-5E-00-00-01	1,2,	

Setting	Description
Fixed Ports	This multicast address is defined by static multicast.
Learned Ports	This multicast address is learned by GMRP.

Using Bandwidth Management

In general, one host should not be allowed to occupy unlimited bandwidth, particularly when the device malfunctions. For example, so-called “broadcast storms” could be caused by an incorrectly configured topology, or a malfunctioning device. The EDS-518A series not only prevents broadcast storms, but can also be configured to a different ingress rate for all packets, giving administrators full control of their limited bandwidth to prevent undesirable effects caused by unpredictable faults.

Configuring Bandwidth Management

Broadcast Storm Protection

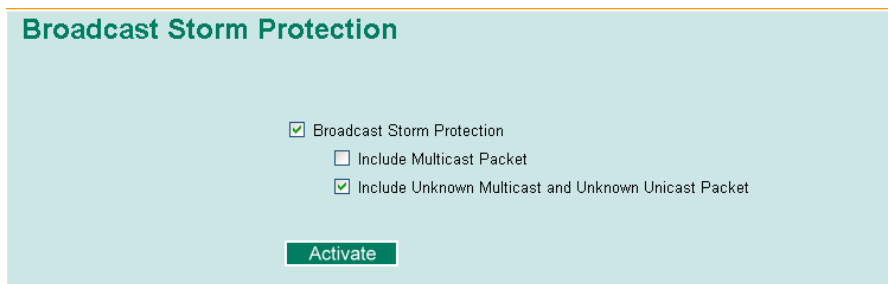

Setting	Description	Factory Default
Enable/Disable	Enable or disable the Broadcast Storm Protection for multicast packet globally.	Enable (for unknown multicast and unknown unicast packet)
	Enable or disable the Broadcast Storm Protection for unknown multicast and unknown unicast packets globally.	

Traffic Rate Limiting Settings

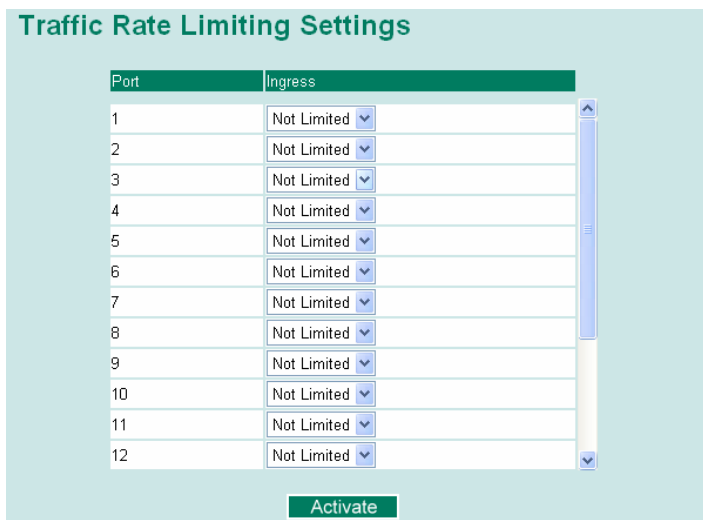

Ingress

Setting	Description	Factory Default
Ingress rate	Select the ingress rate for all packets from the following options: not limited, 3%, 5%, 10%, 15%, 25%, 35%, 50%, 65%, 85%	N/A

Using Port Access Control

EDS-518A provides two kinds of Port-Based Access Controls. One is Static Port Lock and the other is IEEE 802.1X.

Static Port Lock

EDS-518A can also be configured to protect static MAC addresses for a specific port. With the Port Lock function, these locked ports will not learn any additional addresses, but only allow traffic from preset static MAC addresses, helping to block crackers and careless usage.

IEEE 802.1X

The IEEE 802.1X standard defines a protocol for client/server-based access control and authentication. The protocol restricts unauthorized clients from connecting to a LAN through ports that are open to the Internet, and which otherwise would be readily accessible. The purpose of the authentication server is to check each client that requests access to the port. The client is only allowed access to the port if the client's permission is authenticated.

The IEEE 802.1X Concept

Three components are used to create an authentication mechanism based on 802.1X standards: Client/Supplicant, Authentication Server, and Authenticator.

Supplicant: The end station that requests access to the LAN and switch services and responds to the requests from the switch.

Authentication server: The server that performs the actual authentication of the supplicant.

Authenticator: Edge switch or wireless access point that acts as a proxy between the supplicant and the authentication server, requesting identity information from the supplicant, verifying the information with the authentication server, and relaying a response to the supplicant.

EDS-518A acts as an authenticator in the 802.1X environment. A supplicant and an authenticator exchange EAPOL (Extensible Authentication Protocol over LAN) frames with each other. We can either use an external RADIUS server as the authentication server, or implement the authentication server in EDS-518A by using a Local User Database as the authentication look-up table. When we use an external RADIUS server as the authentication server, the authenticator and the authentication server exchange EAP frames between each other.

Authentication can be initiated either by the supplicant or the authenticator. When the supplicant initiates the authentication process, it sends an "EAPOL-Start" frame to the authenticator. When the authenticator initiates the authentication process or when it receives an "EAPOL Start" frame, it sends an "EAP Request/Identity" frame to ask for the username of the supplicant. The following actions are described below:

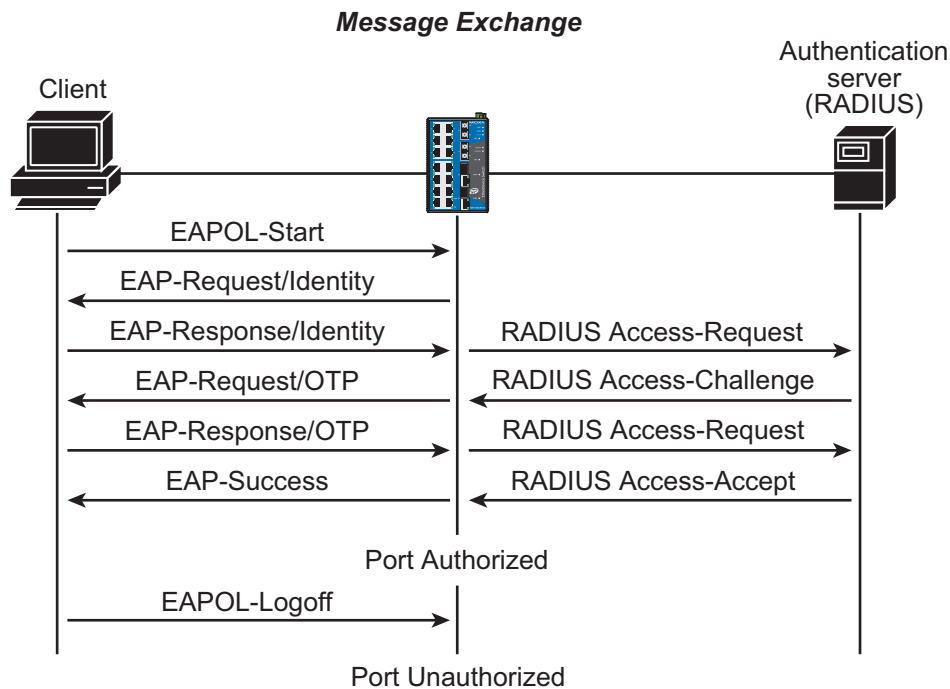

1. When the supplicant receives an “EAP Request/Identity” frame, it sends an “EAP Response/Identity” frame with its username back to the authenticator.
2. If the RADIUS server is used as the authentication server, the authenticator relays the “EAP Response/Identity” frame from the supplicant by encapsulating it into a “RADIUS Access-Request” frame and sends to the RADIUS server. When the authentication server receives the frame, it looks up its database to check if the username exists. If the username is not present, the authentication server replies with a “RADIUS Access-Reject” frame to the authenticator if the server is a RADIUS server or just indicates failure to the authenticator if the Local User Database is used. The authenticator sends an “EAP-Failure” frame to the supplicant.
3. The RADIUS server sends a “RADIUS Access-Challenge,” which contains an “EAP Request” with an authentication type to the authenticator to ask for the password from the client. RFC 2284 defines several EAP authentication types, such as “MD5-Challenge,” “One-Time Password,” and “Generic Token Card.” Currently, only “MD5-Challenge” is supported. If the Local User Database is used, this step is skipped.
4. The authenticator sends an “EAP Request/MD5-Challenge” frame to the supplicant. If the RADIUS server is used, the “EAP Request/MD5-Challenge” frame is retrieved directly from the “RADIUS Access-Challenge” frame.
5. The supplicant responds to the “EAP Request/MD5-Challenge” by sending an “EAP Response/MD5-Challenge” frame that encapsulates the user’s password using the MD5 hash algorithm.
6. If the RADIUS server is used as the authentication server, the authenticator relays the “EAP Response/MD5-Challenge” frame from the supplicant by encapsulating it into a “RADIUS Access-Request” frame along with a “Shared Secret,” which must be the same within the authenticator and the RADIUS server, and sends the frame to the RADIUS server. The RADIUS server checks against the password with its database, and replies with “RADIUS Access-Accept” or “RADIUS Access-Reject” to the authenticator. If the Local User Database is used, the password is checked against its database and indicates success or failure to the authenticator.

- 7. The authenticator sends “EAP Success” or “EAP Failure” based on the reply from the authentication server.

Configuring Static Port Lock

MOXA EDS-518A supports adding unicast groups manually if required.

Setting	Description	Factory Default
MAC Address	Add the static unicast MAC address into the address table.	None
Port	Fix the static address with a dedicated port.	1

Configuring IEEE 802.1X

Database Option

Setting	Description	Factory Default
Local (Max. 32 users)	Select this option when setting the Local User Database as the authentication database.	Local
Radius	Select this option to set an external RADIUS server as the authentication database. The authentication mechanism is “EAP-MD5.”	Local
Radius, Local	Select this option to make an external RADIUS server as the authentication database with first priority. The authentication mechanism is “EAP-MD5.” The first priority is to set the Local User Database as the authentication database.	Local

Radius Server

Setting	Description	Factory Default
IP address or domain name	The IP address or domain name of the RADIUS server	localhost

Server Port

Setting	Description	Factory Default
Numerical	The UDP port of the RADIUS Server	1812

Shared Key

Setting	Description	Factory Default
alphanumeric (Max. 40 characters)	A key to be shared between the external RADIUS server and EDS-518A. Both ends must be configured to use the same key.	<i>None</i>

Re-Auth

Setting	Description	Factory Default
Enable/Disable	Select to require re-authentication of the client after a preset time period of no activity has elapsed.	Disable

Re-Auth Period

Setting	Description	Factory Default
Numerical (60-65535 sec.)	Specify how frequently the end stations need to reenter usernames and passwords in order to stay connected.	3600

802.1X

Setting	Description	Factory Default
Enable/Disable	Select the option under the 802.1X column to enable IEEE 802.1X for one or more ports. All end stations must enter usernames and passwords before access to these ports is allowed.	Disable

802.1X Re-Authentication

EDS-518A can force connected devices to be re-authorized manually.

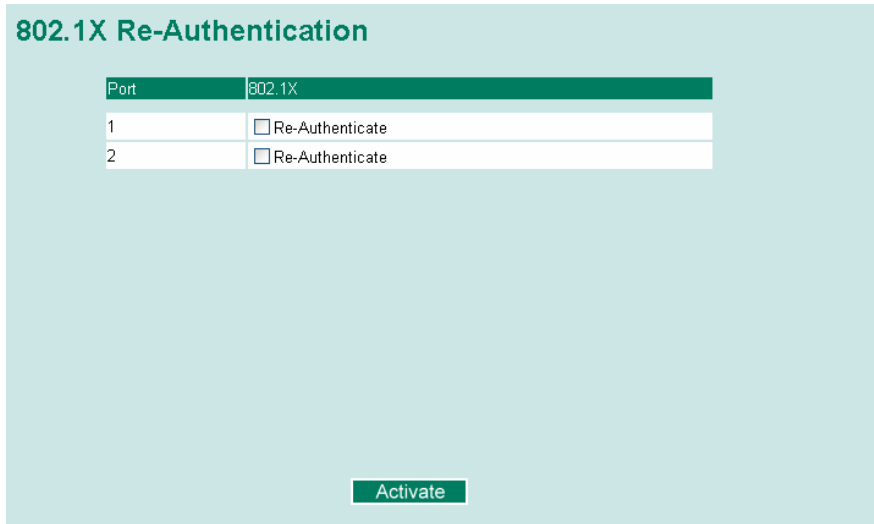

802.1X Re-Authentication

Setting	Description	Factory Default
Enable/Disable	Select the option to enable 802.1X Re-Authentication	Disable

Local User Database Setup

When setting the Local User Database as the authentication database, set the database first.

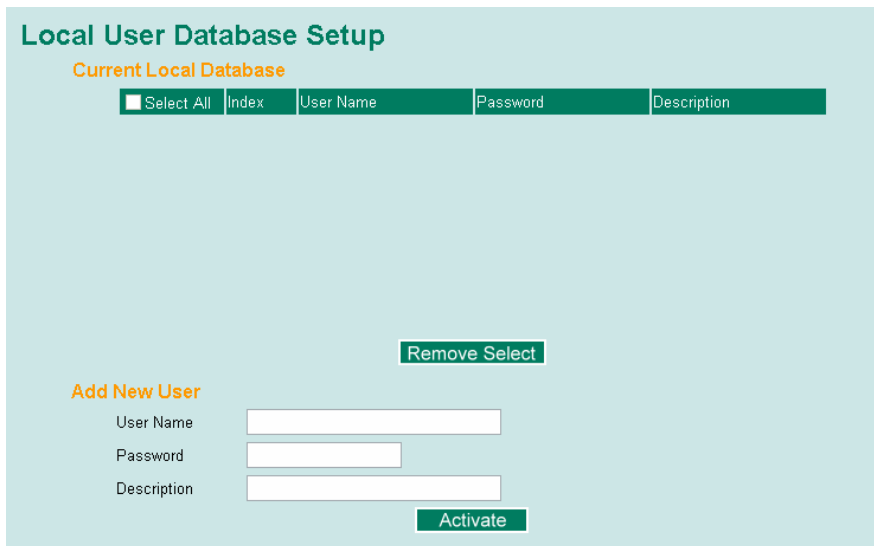

Local User Database Setup

Setting	Description	Factory Default
User Name (Max. 30 characters)	User Name for Local User Database	<i>None</i>
Password (Max. 16 characters)	Password for Local User Database	<i>None</i>
Description (Max. 30 characters)	Description for Local User Database	<i>None</i>

NOTE The user name for the Local User Database is case-insensitive.

Port Access Control Table

Port

<input checked="" type="checkbox"/> Select All	index	Mac Address	Status
<input type="checkbox"/>	1	00-0D-60-CC-40-F8	Authorized

The port status will indicate whether the access is authorized or unauthorized.

Using Auto Warning

Since industrial Ethernet devices are often located at the endpoints of a system, these devices will not always know what is happening elsewhere on the network. This means that an industrial Ethernet switch that connects to these devices must provide system maintainers with real-time alarm messages. Even when control engineers are out of the control room for an extended period of time, they can still be informed of the status of devices almost instantaneously when exceptions occur. MOXA EDS-518A supports different approaches to warn engineers automatically, such as by using email and relay output. It also supports two digital inputs to integrate sensors into your system to automate alarms using email and relay output.

Configuring Email Warning

The Auto Email Warning function uses e-mail to alert the user when certain user-configured events take place.

Three basic steps are required to set up the Auto Warning function:

1. **Configuring Email Event Types**
 Select the desired **Event types** from the Console or Web Browser Event type page (a description of each event type is given later in the *Email Alarm Events setting* subsection).
2. **Configuring Email Settings**
 To configure EDS-518A's email setup from the Console interface or browser interface, enter your Mail Server IP/Name (IP address or name), Account Name, Account Password, Retype New Password, and the email address to which warning messages will be sent.
3. **Activate your settings and if necessary, test the email**
 After configuring and activating your EDS-518A's Event Types and Email Setup, you can use the **Test Email** function to see if your e-mail addresses and mail server address have been properly configured.

Event Type

Email Alarm Events Settings

System Events

Switch Cold Start
 Switch Warm Start
 Power Transition(On->Off)
 Power Transition(Off->On)
 DI 1(Off)
 DI 1(On)
 DI 2(Off)
 DI 2(On)
 Config. Change
 Auth. Failure
 Comm. Redundancy Topology Changed

Port Events

Port	Link-ON	Link-OFF	Traffic-Overload	Traffic-Threshold(%)	Traffic-Duration(s)
1	<input type="checkbox"/>	<input type="checkbox"/>	<input type="checkbox"/>	<input type="text"/>	<input type="text"/>
2	<input type="checkbox"/>	<input type="checkbox"/>	<input type="checkbox"/>	<input type="text"/>	<input type="text"/>
3	<input type="checkbox"/>	<input type="checkbox"/>	<input type="checkbox"/>	<input type="text"/>	<input type="text"/>
4	<input type="checkbox"/>	<input type="checkbox"/>	<input type="checkbox"/>	<input type="text"/>	<input type="text"/>
5	<input type="checkbox"/>	<input type="checkbox"/>	<input type="checkbox"/>	<input type="text"/>	<input type="text"/>
6	<input type="checkbox"/>	<input type="checkbox"/>	<input type="checkbox"/>	<input type="text"/>	<input type="text"/>
7	<input type="checkbox"/>	<input type="checkbox"/>	<input type="checkbox"/>	<input type="text"/>	<input type="text"/>
8	<input type="checkbox"/>	<input type="checkbox"/>	<input type="checkbox"/>	<input type="text"/>	<input type="text"/>

Activate

Event Types can be divided into two basic groups: **System Events** and **Port Events**. System Events are related to the overall function of the switch, whereas Port Events are related to the activity of a specific port.

System Events	Warning e-mail is sent when...
Switch Cold Start	Power is cut off and then reconnected.
Switch Warm Start	EDS-518A is rebooted, such as when network parameters are changed (IP address, subnet mask, etc.).
Power Transition (On→Off)	EDS-518A is powered down.
Power Transition (Off→On)	EDS-518A is powered up.
DI1 (On→Off)	Digital Input 1 is triggered by on to off transition
DI1 (Off→On)	Digital Input 1 is triggered by off to on transition
DI2 (On→Off)	Digital Input 2 is triggered by on to off transition
DI2 (Off→On)	Digital Input 2 is triggered by off to on transition
Configuration Change Activated	A configuration item has been changed.
Authentication Failure	An incorrect password is entered.
Comm. Redundancy Topology Changed	Spanning Tree Protocol switches have changed their position (applies only to the root of the tree). The Master of the Turbo Ring has changed or the backup path is activated.

Port Events	Warning e-mail is sent when...
Link-ON	The port is connected to another device.
Link-OFF	The port is disconnected (e.g., the cable is pulled out, or the opposing device shuts down).
Traffic-Overload	The port's traffic surpasses the Traffic-Threshold for that port (provided this item is Enabled).
Traffic-Threshold (%)	Enter a non-zero number if the port's Traffic-Overload item is Enabled.
Traffic-Duration (sec.)	A Traffic-Overload warning is sent every <i>Traffic-Duration</i> seconds if the average Traffic-Threshold is surpassed during that time period.

NOTE The **Traffic-Overload**, **Traffic-Threshold (%)**, and **Traffic-Duration (sec.)** Port Event items are related. If you Enable the Traffic-Overload event, then be sure to enter a non-zero Traffic-Threshold percentage, as well as a Traffic-Duration between 1 and 300 seconds.

NOTE Warning e-mail messages will have the **sender** field formatted in the form:
MOXA_EtherDevice_Switch_0001@Switch_Location
 where **MOXA_EtherDevice_Switch** is the default Switch Name, **0001** is EDS-518A's serial number, and **Switch_Location** is the default Server Location.
 Refer to the Basic **Settings** section to see how to modify Switch Name and Switch Location.

Email Setup

Email Alarm Events Settings

Mail Server IP/Name:

Account Name :

Account Password :

Change Account Password

Old Password :

New Password :

Retype Password :

1st email address :

2nd email address :

3rd email address :

4th email address :

Mail Server IP/Name

Setting	Description	Factory Default
IP address	The IP Address of your email server.	None

Account Name

Setting	Description	Factory Default
Max. 45 Characters	Your email account name (typically your user name)	None

Password Setting

Setting	Description	Factory Default
Disable/Enable to change Password	To reset the Password from the Web Browser interface, click the Change password check-box, type the Old Password, type the New Password, retype the New password, and then click Activate; Max. 45 Characters.	Disable
Old Password	Type the current password when changing the password	None
New Password	Type new password when enabled to change password; Max. 45 Characters.	None
Retype Password	If you type a new password in the Password field, you will be required to retype the password in the Retype new password field before updating the new password.	None

Email Address

Setting	Description	Factory Default
Max. 30 characters	You can set up to 4 email addresses to receive alarm emails from EDS-518A.	None

Send Test Email

After configuring the email settings, you should first click **Activate** to activate those settings, and then click **Send Test Email** to verify that the settings are correct.

NOTE Auto warning e-mail messages will be sent through an authentication protected SMTP server that supports the CRAM-MD5, LOGIN, and PLAIN methods of SASL (Simple Authentication and Security Layer) authentication mechanism.

We strongly recommend not entering your Account Name and Account Password if auto warning e-mail messages can be delivered without using an authentication mechanism.

Configuring Relay Warning

The Auto Relay Warning function uses relay output to alert the user when certain user-configured events take place. There are two basic steps required to set up the Relay Warning function:

1. **Configuring Relay Event Types**
Select the desired **Event types** from the Console or Web Browser Event type page (a description of each event type is given later in the *Relay Alarm Events setting* subsection).
2. **Activate your settings**
After completing the configuration procedure, you will need to activate your EDS-518A's Relay Event Types.

Event Setup

Relay Alarm Events Settings

System Events

Override Relay 1 Warning Settings Override Relay 2 Warning Settings

Power Input 1 failure(On->Off) Power Input 2 failure(On->Off)

DI 1 (Off) DI 1 (On) DI 2 (Off) DI 2 (On)

Port Events

Port	Link	Traffic-Overload	Traffic-Threshold(%)	Traffic-Duration(s)
1	<input type="text" value="Ignore"/>	<input type="text" value="Disable"/>	<input type="text" value=""/>	<input type="text" value="1"/>
2	<input type="text" value="Ignore"/>	<input type="text" value="Disable"/>	<input type="text" value=""/>	<input type="text" value="1"/>
3	<input type="text" value="Ignore"/>	<input type="text" value="Disable"/>	<input type="text" value=""/>	<input type="text" value="1"/>
4	<input type="text" value="Ignore"/>	<input type="text" value="Disable"/>	<input type="text" value=""/>	<input type="text" value="1"/>
5	<input type="text" value="Ignore"/>	<input type="text" value="Disable"/>	<input type="text" value=""/>	<input type="text" value="1"/>
6	<input type="text" value="Ignore"/>	<input type="text" value="Disable"/>	<input type="text" value=""/>	<input type="text" value="1"/>
7	<input type="text" value="Ignore"/>	<input type="text" value="Disable"/>	<input type="text" value=""/>	<input type="text" value="1"/>
8	<input type="text" value="Ignore"/>	<input type="text" value="Disable"/>	<input type="text" value=""/>	<input type="text" value="1"/>

Event Types can be divided into two basic groups: **System Events** and **Port Events**. System Events are related to the overall function of the switch, whereas Port Events are related to the activity of a specific port.

MOXA EDS-518A supports two relay outputs. You can configure which relay output is related to which events. This helps administrators identify the importance of the different events.

System Events	Warning Relay output is triggered when...
Power Transition (On→Off)	EDS-518A is powered on.
Power Transition (Off→On)	EDS-518A is powered down.
DI1 (On→Off)	Digital Input 1 is triggered by on to off transition
DI1 (Off→On)	Digital Input 1 is triggered by off to on transition
DI2 (On→Off)	Digital Input 2 is triggered by on to off transition
DI2 (Off→On)	Digital Input 2 is triggered by off to on transition

Port Events	Warning e-mail is sent when...
Link-ON	The port is connected to another device.
Link-OFF	The port is disconnected (e.g., the cable is pulled out, or the opposing device shuts down).
Traffic-Overload	The port's traffic surpasses the Traffic-Threshold for that port (provided this item is Enabled).
Traffic-Threshold (%)	Enter a non-zero number if the port's Traffic-Overload item is Enabled.
Traffic-Duration (sec.)	A Traffic-Overload warning is sent every <i>Traffic-Duration</i> seconds if the average Traffic-Threshold is surpassed during that time period.

NOTE The **Traffic-Overload**, **Traffic-Threshold (%)**, and **Traffic-Duration (sec)** Port Event items are related. If you Enable the Traffic-Overload event, then be sure to enter a non-zero Traffic-Threshold percentage, as well as a Traffic-Duration between 1 and 300 seconds.

Override relay alarm settings

Select this option to override the relay warning setting temporarily. Releasing the relay output will allow administrators to fix any problems with the warning condition.

Warning List

Use this table to see if any relay alarms have been issued.

Current Alarm List		
Index	Event	Relay
1	DI 1 failure (Off) !	1
2	DI 2 failure (Off) !	2

Using Line-Swap-Fast-Recovery

The Line-Swap Fast Recovery function, which is enabled by default, allows EDS-518A to return to normal operation extremely quickly after devices are unplugged and then re-plugged into different ports. The recovery time is on the order of a few milliseconds (compare this with standard commercial switches for which the recovery time could be on the order of several minutes). To disable the Line-Swap Fast Recovery function, or to re-enable the function after it has already been disabled, access either the Console utility's **Line-Swap recovery** page, or the Web Browser interface's **Line-Swap fast recovery** page, as the following figure shows:

Configuring Line-Swap Fast Recovery

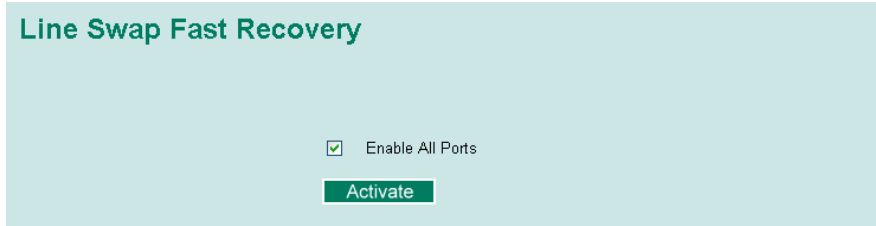

Enable Line-Swap-Fast-Recovery

Setting	Description	Factory Default
Enable/Disable	Select this option to enable the Line-Swap-Fast-Recovery function	Enable

Using Set Device IP

To reduce the effort required to set up IP addresses, the EDS-518A series comes equipped with DHCP/BOOTP server and RARP protocol to set up IP addresses of Ethernet-enabled devices automatically.

When enabled, the **Set device IP** function allows EDS-518A to assign specific IP addresses automatically to connected devices that are equipped with *DHCP Client* or *RARP* protocol. In effect, EDS-518A acts as a DHCP server by assigning a connected device with a specific IP address stored in its internal memory. Each time the connected device is switched on or rebooted, EDS-518A sends the device the desired IP address.

Perform the following steps to use the **Set device IP** function:

STEP 1—set up the connected devices

Set up those Ethernet-enabled devices connected to EDS-518A for which you would like IP addresses to be assigned automatically. The devices must be configured to *obtain* their IP address automatically.

The devices' configuration utility should include a setup page that allows you to choose an option similar to **Obtain an IP address automatically**.

For example, Windows' **TCP/IP Properties** window is shown at the right. Although your device's configuration utility may look quite a bit different, this figure should give you some idea of what to look for.

You also need to decide to which of EDS-518A's ports your Ethernet-enabled devices will be connected. You will need to set up each of these ports separately, as described in the following step.

STEP 2

Configure EDS-518A's **Set device IP** function, either from the Console utility or from the Web Browser interface. In either case, you simply need to enter the **Desired IP** for each port that needs to be configured.

STEP 3

Be sure to activate your settings before exiting.

- When using the Web Browser interface, activate by clicking **Activate**.

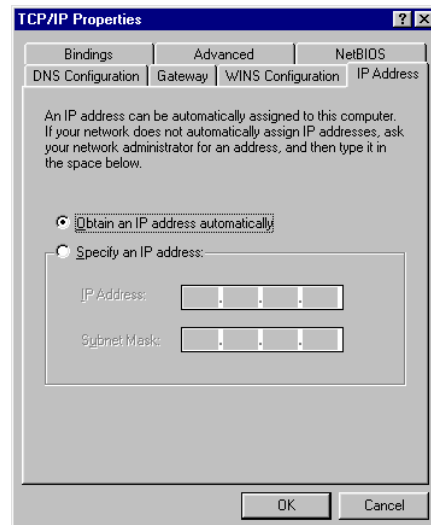

- When using the Console utility, activate by first highlighting the **Activate** menu option, and then press **Enter**. You should receive the **Set device IP settings are now active! (Press any key to continue)** message.

Configuring Set Device IP

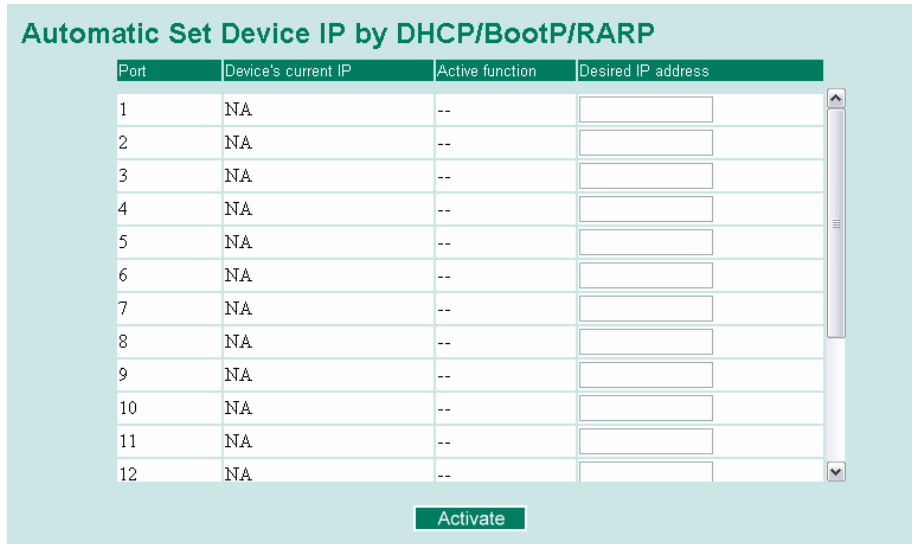

Desired IP Address

Setting	Description	Factory Default
IP Address	Set the desired IP of connected devices.	None

Using Diagnosis

MOXA EDS-518A provides two important tools for administrators to diagnose network systems.

Mirror Port

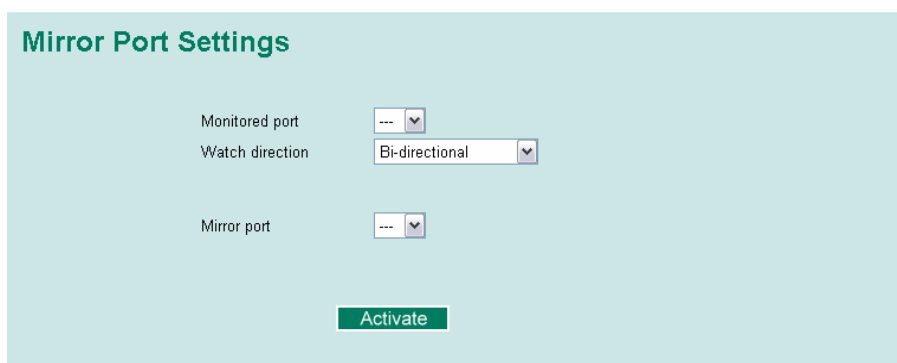

The **Mirror port** function can be used to monitor data being transmitted through a specific port. This is done by setting up another port (the *mirror port*) to receive the same data being transmitted from, or both to and from, the port under observation. This allows the network administrator to “sniff” the observed port and thus keep tabs on network activity.

Perform the following steps to set up the **Mirror Port** function:

STEP 1

Configure EDS-518A's **Mirror Port** function from either the Console utility or Web Browser interface. You will need to configure three settings:

- Monitored Port** Select the port number of the port whose network activity will be monitored.
- Mirror Port** Select the port number of the port that will be used to monitor the activity of the monitored port.
- Watch Direction** Select one of the following two watch direction options:
- **Output data stream**
Select this option to monitor only those data packets being sent *out through* EDS-518A's port.
 - **Bi-directional**
Select this option to monitor data packets both coming *into*, and being sent *out through*, EDS-518A's port.

STEP 2

Be sure to activate your settings before exiting.

- When using the Web Browser interface, activate by clicking **Activate**.
- When using the Console utility, activate by first highlighting the Activate menu option, and then press **Enter**. You should receive the **Mirror port settings are now active! (Press any key to continue)** message.

Ping

Use Ping Command to test Network Integrity

IP address/Name

Ping

The **Ping** function uses the *ping* command to give users a simple but powerful tool for troubleshooting network problems. The function's most unique feature is that even though the ping command is entered from the user's PC keyboard, the actual ping command originates from EDS-518A itself. In this way, the user can essentially control EDS-518A and send ping commands out through its ports.

To use the Ping function, type in the desired IP address, and then press **Enter** from the Console utility, or click **Ping** when using the Web Browser interface.

Using Monitor

You can monitor statistics in real time from EDS-518A's web console and serial console.

Monitor by Switch

Access the Monitor by selecting "System" from the left selection bar. Monitor by System allows the user to view a graph that shows the combined data transmission activity of all EDS-518A's 18 ports. Click one of the four options—**Total Packets**, **TX Packets**, **RX Packets**, or **Error Packets**—to view transmission activity of specific types of packets. Recall that TX Packets are packets sent out from EDS-518A, RX Packets are packets received from connected devices, and Error Packets are packets that did not pass TCP/IP's error checking algorithm. The Total Packets option displays a graph that combines TX, RX, and TX Error, RX Error Packets activity. The

graph displays data transmission activity by showing **Packets/s** (i.e., packets per second, or pps) versus **sec.** (seconds). In fact, three curves are displayed on the same graph: **Unicast** packets (in red color), **Multicast** packets (in green color), and **Broadcast** packets (in blue color). The graph is updated every few seconds, allowing the user to analyze data transmission activity in real-time.

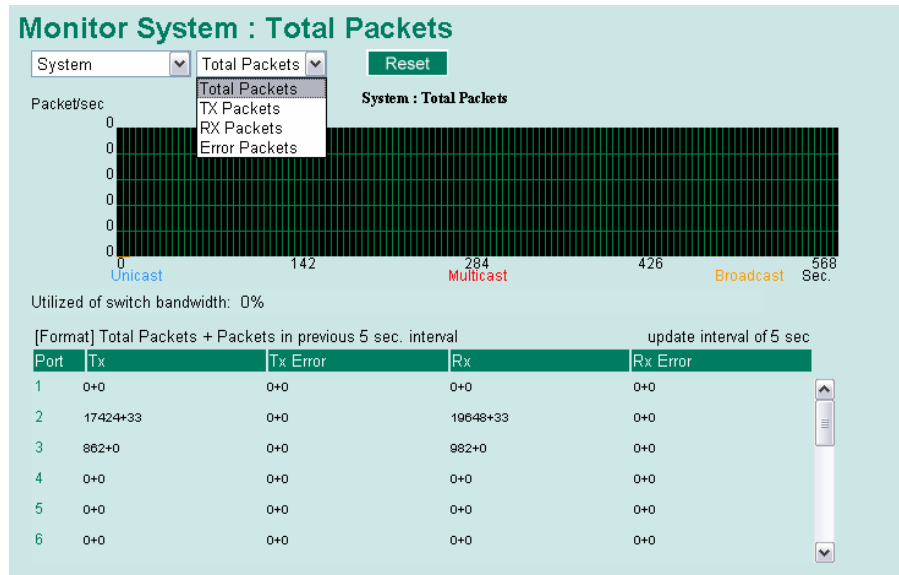

Monitor by Port

Access the Monitor by Port function by selecting **ALL 10/100M or 1G Ports** or **Port *i***, in which ***i* = 1, 2, ..., G2**, from the left pull-down list. The **Port *i*** options are identical to the Monitor by System function discussed above, in that users can view graphs that show All Packets, TX Packets, RX Packets, or Error Packets activity, but in this case, only for an individual port. The **All Ports** option is essentially a graphical display of the individual port activity that can be viewed with the Console Monitor function discussed above. The All Ports option shows three vertical bars for each port. The height of the bar represents **Packets/s** for the type of packet, at the instant the bar is being viewed. That is, as time progresses, the height of the bar moves up or down so that the user can view the change in the rate of packet transmission. The blue colored bar shows **Unicast** packets, the red colored bar shows **Multicast** packets, and the orange colored bar shows **Broadcast** packets. The graph is updated every few seconds, allowing the user to analyze data transmission activity in real-time.

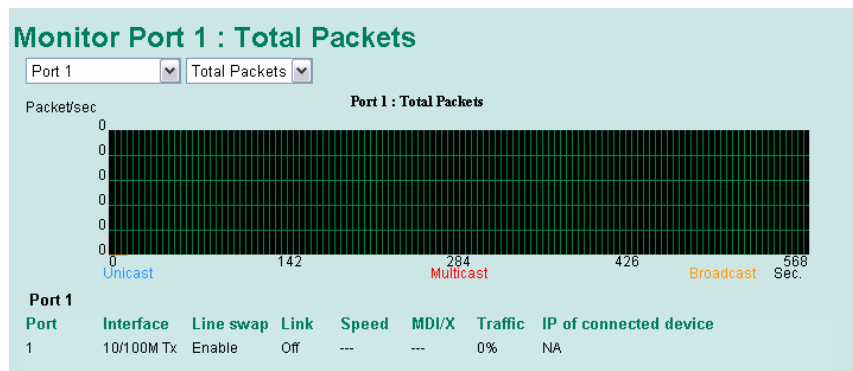

Using the MAC Address Table

This section explains the information provided by EDS-518A's MAC address table.

All MAC Address List

All Page 1/1

Index	MAC	Type	Port
1	00-0d-60-cc-40-f8	ucast(l)	4
2	01-00-5e-7f-ff-fa	mcast(l)	4,

The MAC Address table can be configured to display the following EDS-518A MAC address groups.

ALL	Select this item to show all EDS-518A MAC addresses
ALL Learned	Select this item to show all EDS-518A Learned MAC addresses
ALL Static Lock	Select this item to show all EDS-518A Static Lock MAC addresses
ALL Static	Select this item to show all EDS-518A Static/Static Lock /Static Multicast MAC addresses
ALL Static Multicast	Select this item to show all EDS-518A Static Multicast MAC addresses
Port x	Select this item to show all MAC addresses of dedicated ports

The table will display the following information:

MAC	This field shows the MAC address
Type	This field shows the type of this MAC address
Port	This field shows the port that this MAC address belongs to

Using Event Log

Event Log Table

Page 1/54

Index	Bootup	Date	Time	System Startup Time	Event
1	1	--	--	0d0h0m1s	Cold start
2	2	--	--	0d0h0m0s	Cold start
3	3	--	--	0d0h0m0s	Cold start
4	4	--	--	0d0h0m0s	Cold start
5	5	--	--	0d0h0m0s	Cold start
6	6	--	--	0d0h0m0s	Cold start
7	7	--	--	0d0h0m0s	Cold start
8	7	--	--	0d0h0m4s	Port G2 link on
9	7	--	--	0d0h0m35s	Port G2 link off
10	7	--	--	0d0h0m35s	Port G2 link on
11	8	--	--	0d0h0m1s	Cold start
12	8	--	--	0d0h0m1s	Port G2 link on
13	9	--	--	0d0h0m1s	Cold start
14	9	--	--	0d0h0m1s	Port G2 link on
15	10	--	--	0d0h0m1s	Cold start

Clear

Bootup	This field shows how many times the EDS-518A has been rebooted or cold started.
Date	The date is updated based on how the current date is set in the "Basic Setting" page.
Time	The time is updated based on how the current time is set in the "Basic Setting" page.
System Startup Time	The system startup time related to this event.
Events	Events that have occurred.

NOTE The following events will be record into EDS-518A's Event Log table:

1. Cold start
2. Warm start
3. Configuration change activated
4. Power 1/2 transition (Off → On), Power 1/2 transition (On → Off)
5. Authentication fail
6. Topology changed
7. Master setting is mismatched
8. DI 1/2 transition (Off → On), DI 1/2 transition (On → Off)
9. Port traffic overload
10. dot1x Auth Fail
11. Port link off / on

Using HTTPS/SSL

To secure your HTTP access, EDS-518A supports HTTPS/SSL to encrypt all HTTP traffic. Perform the following steps to access EDS-518A's web browser interface via HTTPS/SSL.

1. Open Internet Explorer and type **https://EDS-518A's IP address** in the address field. Press Enter to establish the connection.

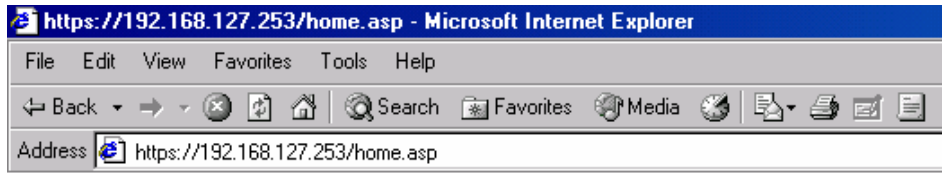

2. Warning messages will pop out to warn the user that the security certificate was issued by a company they have not chosen to trust.

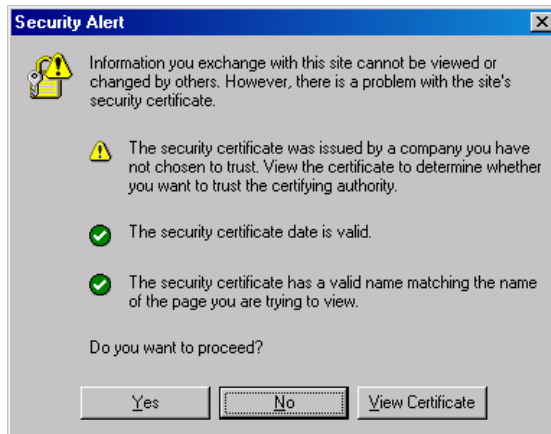

3. Select **Yes** to enter the EDS-518A's web browser interface and access the web browser interface secured via HTTPS/SSL.

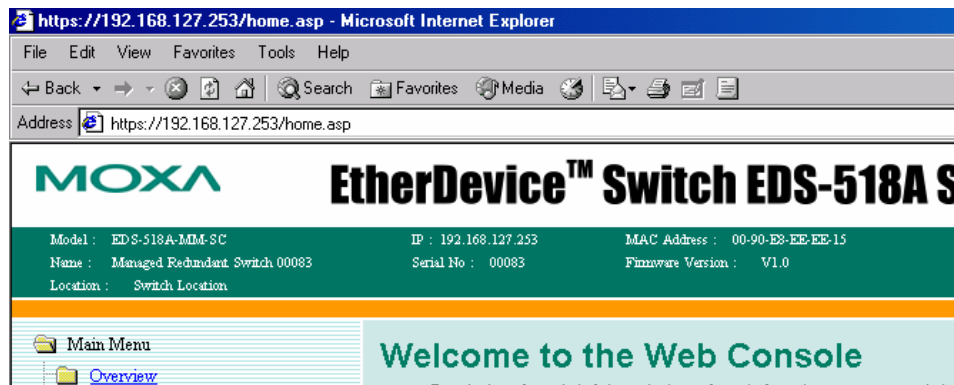

NOTE MOXA provides a Root CA certificate. After installing this certificate into your PC or notebook, you can access the web browser interface directly and will not see any warning messages again. You may download the certificate from EDS-518A's CD-ROM.

EDS Configurator GUI

EDS Configurator is a comprehensive Windows-based GUI that is used to configure and maintain multiple EDS-518A switches. A suite of useful utilities is available to help you locate EDS-518A switches attached to the same LAN as the PC host (regardless of whether or not you know the IP addresses of the switches), connect to an EDS-518A whose IP address is known, modify the network configurations of one or multiple EDS-518A switches, and update the firmware of one or more EDS-518A switches. EDS Configurator is designed to provide you with instantaneous control of *all* of your EDS-518A switches, regardless of location. You may download the EDS Configurator software from MOXA's website free of charge.

This chapter includes the following sections:

- Starting EDS Configurator**
- Broadcast Search**
- Search by IP address**
- Upgrade Firmware**
- Modify IP Address**
- Export Configuration**
- Import Configuration**
- Unlock Server**

Starting EDS Configurator

To start EDS Configurator, locate and then run the executable file **edscfgui.exe**.

NOTE You may download the EDS Configurator software from MOXA's website at www.moxa.com.

For example, if the file was placed on the Windows desktop, it should appear as follows. Simply double click on the icon to run the program.



The MOXA EtherDevice Server Configurator window will open, as shown below.

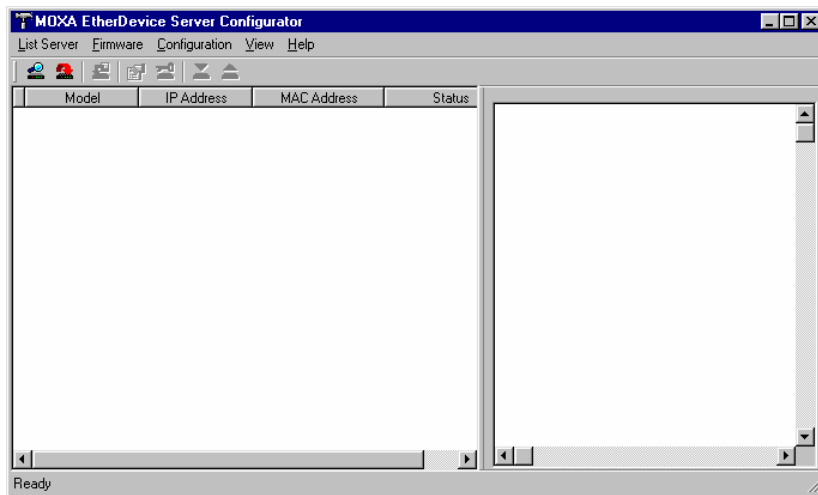

Broadcast Search

Use the Broadcast Search utility to search the LAN for all EDS-518A switches that are connected to the LAN. Note that since the search is done by MAC address, Broadcast Search will not be able to locate MOXA EtherDevice Servers connected outside the PC host's LAN. Start by clicking the Broadcast Search icon , or by selecting **Broadcast Search** under the **List Server** menu.

The Broadcast Search window will open, displaying a list of all switches located on the network, as well as the progress of the search.

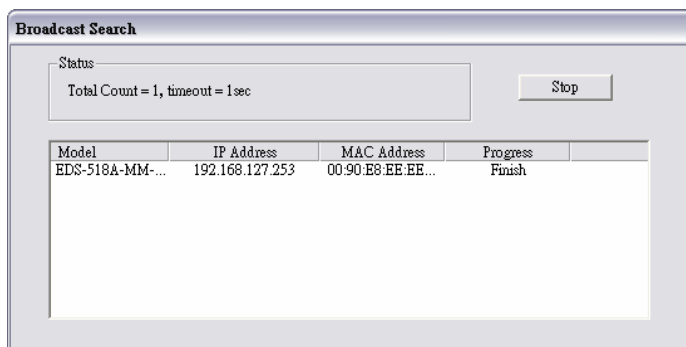

Once the search is complete, the Configurator window will display a list of all switches that were located.

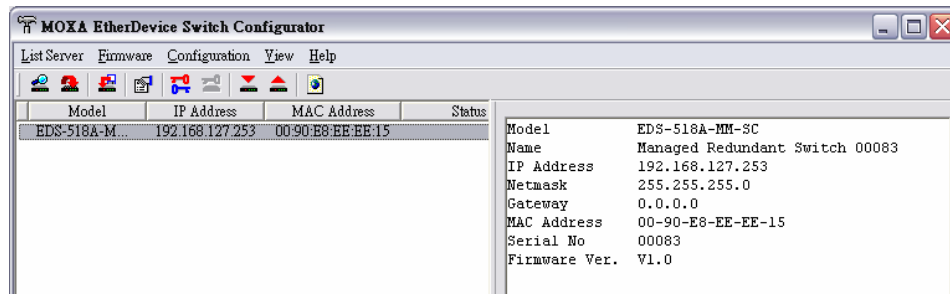

Search by IP address

This utility is used to search for EDS-518A switches one at a time. Note that the search is conducted by IP address, so you should be able to locate any EDS-518A that is properly connected to your LAN, WAN, or even the Internet. Start by clicking the Specify by IP address icon , or by selecting **Specify IP address** under the **List Server** menu.

The **Search Server with IP Address** window will open. Enter the IP address of the switch you wish to search for, and then click **OK**.

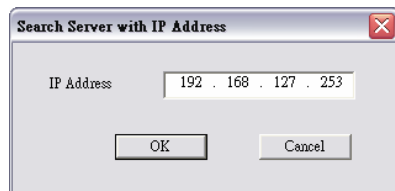

Once the search is complete, the Configurator window will add the switch to the list of switches.

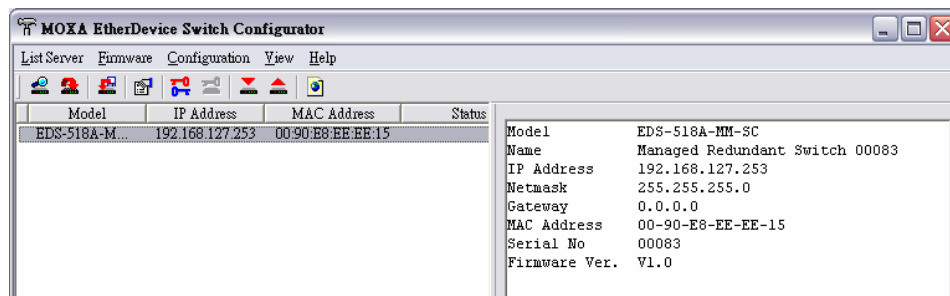

Upgrade Firmware

Keep your EDS-518A up to date with the latest firmware from MOXA. Perform the following steps to upgrade the firmware:

1. Download the updated firmware (*.rom) file from the MOXA website (www.moxa.com).
2. Click the switch (from the **MOXA EtherDevice Server Configurator** window) whose firmware you wish to upgrade to highlight it.

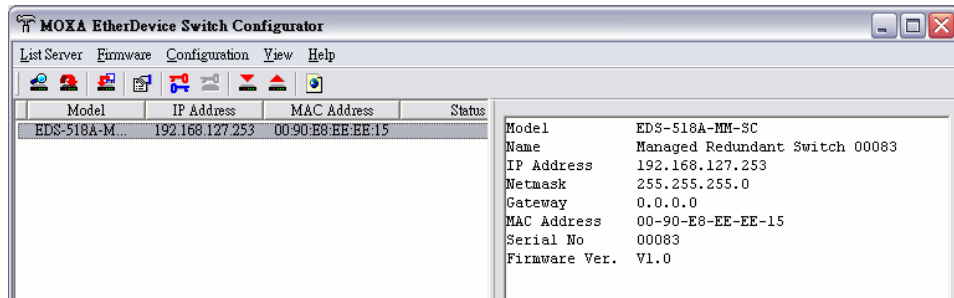

3. Click the **Upgrade Firmware** toolbar icon , or select **Upgrade** under the **Firmware** menu. If the switch is Locked, you will be prompted to input the switch's User Name and Password.
4. Use the **Open** window to navigate to the folder that contains the firmware upgrade file, and then click the correct "*.rom" file (**eds.rom** in the example shown below) to select the file. Click **Open** to activate the upgrade process.

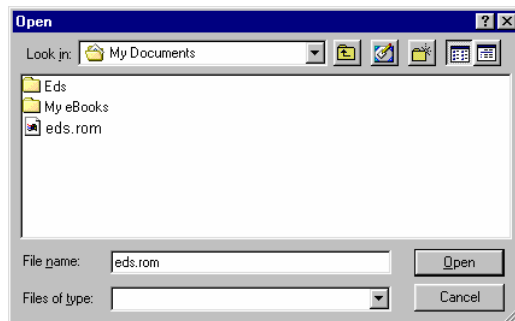

Modify IP Address

You may use the Modify IP Address function to reconfigure EDS-518A's network settings. Start by clicking the Modify IP address icon , or by selecting **Modify IP address** under the **Configuration** menu.

The **Setup Configuration** window will open. Checkmark the box to the left of those items that you wish to modify, and then Disable or Enable DHCP, and enter IP Address, Subnet mask, Gateway, and DNS IP. Click **OK** to accept the changes to the configuration.

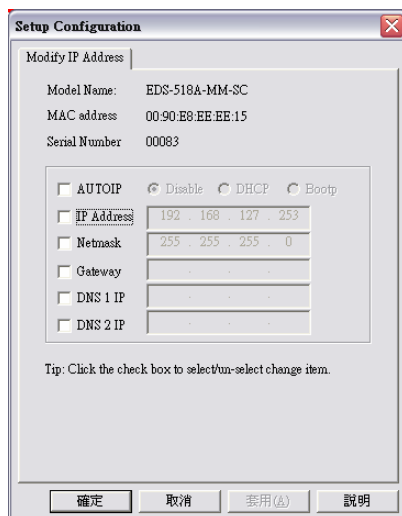

Export Configuration

The **Export Configuration** utility is used to save the entire configuration of a particular EDS-518A to a text file. Take the following steps to export a configuration:

1. Highlight the switch (from the Server list in the Configurator window's left pane), and then click the **Export** toolbar icon  or select **Export Configuration** from the **Configuration** menu. Use the **Open** window to navigate to the folder in which you want to store the configuration, and then type the name of the file in the File name input box. Click **Open**.

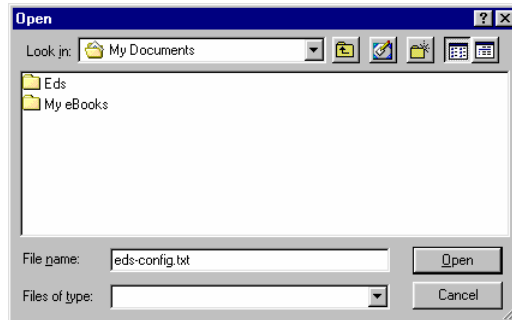

2. Click **OK** when the **Export configuration to file OK** message appears.

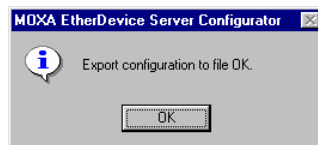

3. You may use a standard text editor, such as Notepad under Windows, to view and modify the newly created configuration file.

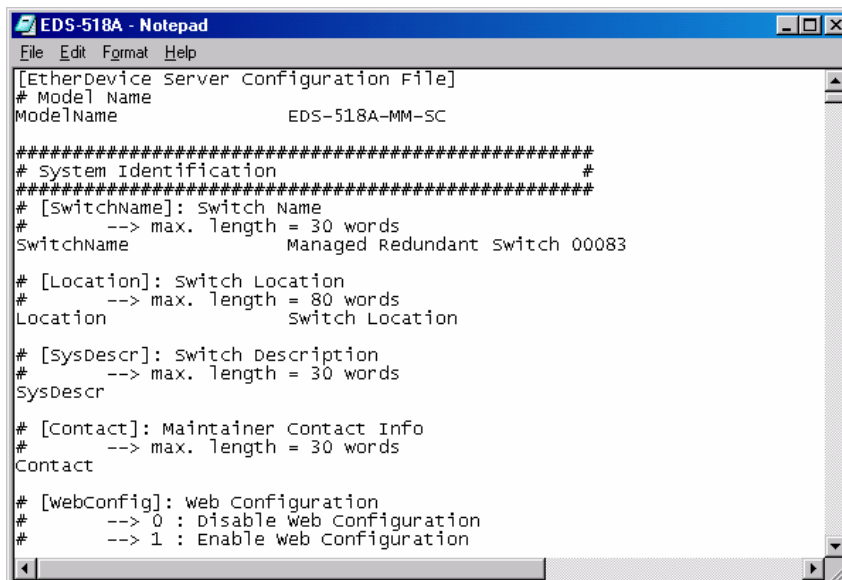

Import Configuration

The **Import Configuration** function is used to import an entire configuration from a text file to EDS-518A. This utility can be used to transfer the configuration from one EDS-518A to another, by first using the Export Configuration function (described in the previous section) to save a switch configuration to a file, and then using the Import Configuration function. Perform the following steps to import a configuration:

1. Highlight the server (from the MOXA EtherDevice Switch list in the Configurator window's left pane), and then click the **Import** toolbar icon , or select **Import Configuration** from the **Configuration** menu.
2. Use the **Open** window to navigate to the text file that contains the desired configuration. Once the file is selected, click **Open** to initiate the import procedure.

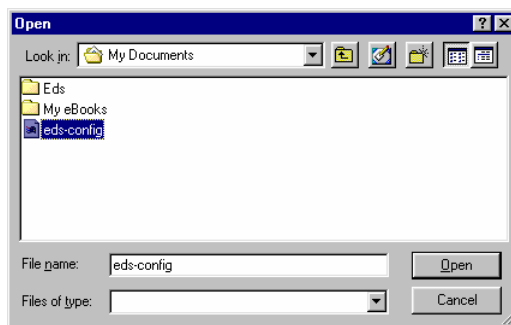

3. The **Setup Configuration** window will be displayed, with a special note attached at the bottom. Parameters that have been changed will be activated with a checkmark. You may make more changes if necessary, and then click **OK** to accept the changes.

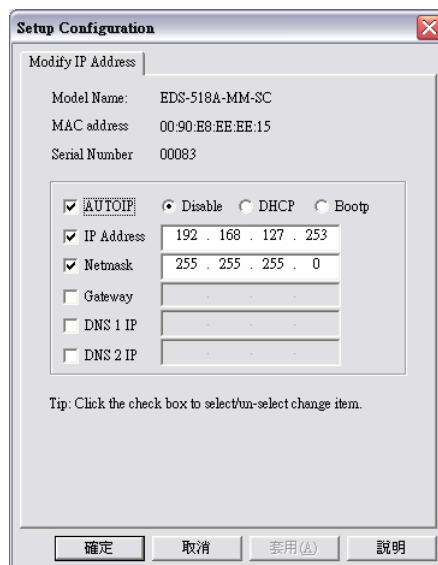

- Click **Yes** in response to the following warning message to accept the new settings.

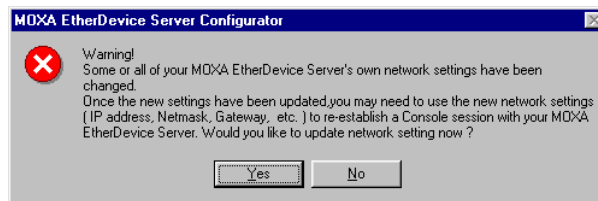

Unlock Server

The Unlock Server function is used to open a password protected switch so that the user can modify its configuration, import/export a configuration, etc. There are six possible responses under the **Status** column. The **Status** of an EDS-518A indicates how the switch was located (by MOXA EtherDevice Switch Configurator), and what type of password protection it has.

The six options are as follows (note that the term **Fixed** is borrowed from the standard *fixed IP address* networking terminology):

- Locked**
 The switch is password protected, “Broadcast Search” was used to locate it, and the password has not yet been entered from within the current Configurator session.
- Unlocked**
 The switch is password protected, “Broadcast Search” was used to locate it, and the password has been entered from within the current Configurator session. Henceforth during this Configurator session, activating various utilities for this switch will not require re-entering the server password.
- Blank**
 EDS-518A is not password protected, and “Broadcast Search” was used to locate it.
- Fixed**
 EDS-518A is not password protected, and “Search by IP address” was used to locate it manually.
- Locked Fixed**
 EDS-518A is password protected, “Search by IP address” was used to locate it manually, and the password has not yet been entered from within the current Configurator session.
- Unlocked Fixed**
 EDS-518A is password protected, “Search by IP address” was used to locate it manually, and the password has been entered from within the current Configurator session. Henceforth during this Configurator session, activating various utilities for this EDS-518A will not require re-entering the server password.

Follow the steps given below to unlock a locked EDS-518A (i.e., an EDS-518A with Status “Locked” or “Locked Fixed”). Highlight the server (from the MOXA EtherDevice Switch list in the Configurator window’s left pane), and then click the **Unlock** toolbar icon , or select **Unlock** from the **Configuration** menu.

- Enter the switch’s **User Name** and **Password** when prompted, and then click **OK**.

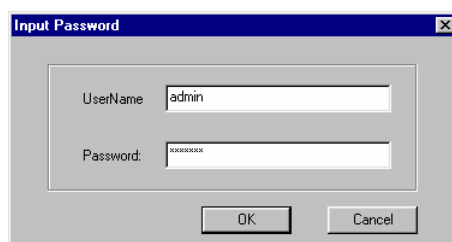

- When the **Unlock status** window reports Progress as **OK**, click the **Close** button in the upper right corner of the window.

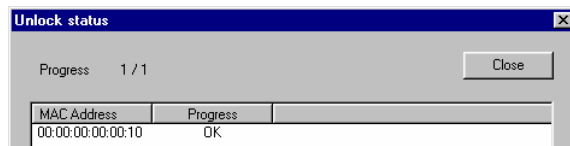

- The status of the switch will now read either **Unlocked** or **Unlocked Fixed**.

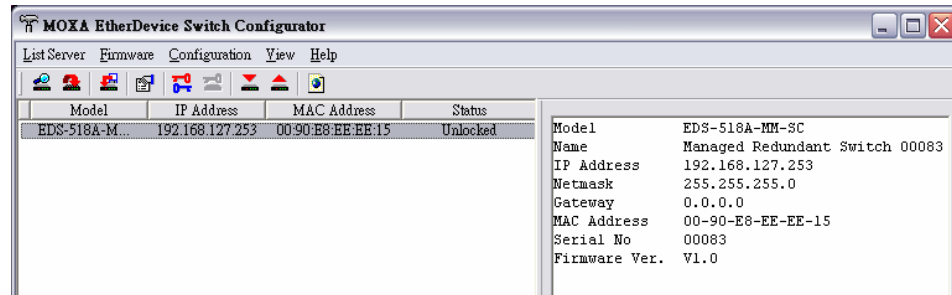

A

MIB Groups

MOXA EDS-518A comes with built-in SNMP (Simple Network Management Protocol) agent software that supports cold/warm start trap, line up/down trap, and RFC 1213 MIB-II.

The standard MIB groups that MOXA EDS-518A series support are:

MIB II.1 – System Group

sysORTable

MIB II.2 – Interfaces Group

ifTable

MIB II.4 – IP Group

ipAddrTable

ipNetToMediaTable

IpGroup

IpBasicStatsGroup

IpStatsGroup

MIB II.5 – ICMP Group

IcmpGroup

IcmpInputStatus

IcmpOutputStats

MIB II.6 – TCP Group

tcpConnTable

TcpGroup

TcpStats

MIB II.7 – UDP Group

udpTable

UdpStats

MIB II.10 – Transmission Group

dot3
dot3StatsTable

MIB II.11 – SNMP Group

SnmpBasicGroup
SnmpInputStats
SnmpOutputStats

MIB II.17 – dot1dBridge Group

dot1dBase
 dot1dBasePortTable
dot1dStp
 dot1dStpPortTable
dot1dTp
 dot1dTpFdbTable
 dot1dTpPortTable
 dot1dTpHCPortTable
 dot1dTpPortOverflowTable
pBridgeMIB
 dot1dExtBase
 dot1dPriority
 dot1dGarp
qBridgeMIB
 dot1qBase
 dot1qTp
 dot1qFdbTable
 dot1qTpPortTable
 dot1qTpGroupTable
 dot1qForwardUnregisteredTable
dot1qStatic
 dot1qStaticUnicastTable
 dot1qStaticMulticastTable
dot1qVlan
 dot1qVlanCurrentTable
 dot1qVlanStaticTable
 dot1qPortVlanTable

EDS-518A also provides a private MIB file, located in the file "MOXA-EDS518A-MIB.my" on the EDS-518A Series utility CD-ROM.

Public Traps:

1. Cold Start
2. Link Up
3. Link Down
4. Authentication Failure
5. dot1dBridge New Root
6. dot1dBridge Topology Changed

Private Traps:

1. Configuration Changed
2. Power On
3. Power Off
4. Traffic Overloaded
5. Turbo Ring Topology Changed
6. Turbo Ring Coupling Port Changed
7. Turbo Ring Master Mismatch

B

Specifications

Technology

Standards	IEEE802.3, 802.3u, 802.3x, 802.1D, 802.1w, 802.1Q, 802.1p
Protocols	IGMP V1/V2/V3 device, GVRP, SNMP V1/V2c/V3, DHCP Server/Client, BOOTP, TFTP, SNTP, SMTP, RARP and EDS-SNMP OPC server Pro (Optional)
MIB	MIB-II, Ethernet-Like MIB, P-BRIDGE MIB, Q-BRIDGE MIB, Bridge MIB, RSTP MIB, RMON MIB Group 1,2,3,9

Interface

RJ45 Ports	10/100/1000BaseT(X) auto negotiation speed, F/H duplex mode, and auto MDI/MDI-X connection
Fiber Ports	100BaseFX (SC/ST connector) and optional 1000BaseSX/LX/LHX/ZX (LC connector)
Console	RS-232 (RJ45)
LED Indicators	PWR1, PWR2, FAULT, 10/100M (TP port), 100M (Fiber port), 1000M, Ring Master and Ring Coupler
Alarm Contact	Two relay outputs with current carrying capacity of 1A @ 24 VDC
Digital Input	Two inputs with the same ground, but electrically isolated from the electronics <ul style="list-style-type: none">• For state "1": +13 to +30V• For state "0": -30 to +3V• Max. input current: 8 mA

Optical Fiber

100BaseFX

Distance:

Multi mode:	0 to 5 km, 1300 nm (50/125 μ m, 800 MHz*km) 0 to 4 km, 1300 nm (62.5/125 μ m, 500 MHz*km)
Single mode:	0 to 40 km, 1310 nm (9/125 μ m, 3.5 PS/(nm*km)) 0 to 80 km, 1550 nm (9/125 μ m, 19 PS/(nm*km))

Min. TX Output:

Multi mode :	-20 dBm
Single mode:	0 to 40 km, -5 dBm 0 to 80 km, -5 dBm

Max. TX Output:

Multi mode :	-14 dBm
Single mode:	0 to 40 km, 0 dBm 0 to 80 km, 0 dBm

Sensitivity:

Multi mode :	-34 to -30 dBm
Single mode:	-36 to -32 dBm

1000BaseSX/LX/LHX/ZX**Distance:**

Multi mode:	
• 1000BaseSX	0 to 500m, 850 nm (50/125 μ m, 400 MHz*km) 0 to 275m, 850 nm (62.5/125 μ m, 200 MHz*km)
• 1000BaseLX	0 to 1100m, 1310 nm (50/125 μ m, 800 MHz*km) 0 to 550m, 1310 nm (62.5.125 μ m, 500 MHz*km)
Single mode:	
• 1000BaseLX	0 to 10 km, 1310 nm (9/125 μ m, 3.5 PS/(nm*km))
• 1000BaseLHX	0 to 40 km, 1310 nm ((9/125 μ m, 3.5 PS/(nm*km)))
• 1000BaseZX	0 to 80 km, 1550 nm ((9/125 μ m, 19 PS/(nm*km))

Power

Input Voltage	24 VDC(12 to 45 VDC), redundant inputs
Input Current (@24V)	0.67A: (EDS-518A) 0.78A: (EDS-518A-MM-SC/ST, EDS-518A-SS-SC)

Connection Two removable 6-pin terminal blocks

Overload Current Protection	Present
Reverse Polarity Protection	Present

Mechanical

Casing	IP30 protection, metal case
Dimensions	95 x 135 x 140 mm (W x H x D)
Weight	1.63 kg
Installation	DIN-Rail, Wall Mounting (optional kit)

Environmental

Operating Temperature	0 to 60°C (32 to 140°F)
Storage Temperature	-40 to 85°C (-40 to 185°F)
Ambient Relative Humidity	5% to 95% (non-condensing)

Regulatory Approvals

Safety	UL60950, UL 508(Pending), CSA C22.2 No. 60950, EN60950
Hazardous Location	UL/cUL Class I, Division 2, Groups A, B, C, and D, ATEX Class I, Zone 2, EEx nC IIC (Pending)
EMI	FCC Part 15, CISPR (EN55022) class A
EMS	EN61000-4-2 (ESD), Level 3 EN61000-4-3 (RS), Level 3 EN61000-4-4 (EFT), Level 3 EN61000-4-5 (Surge), Level 3 EN61000-4-6 (CS), Level 3 EN61000-4-8 EN61000-4-11 EN61000-4-12
Shock	IEC60068-2-27
Freefall	IEC60068-2-32
Vibration	IEC60068-2-6
WARRANTY	5 years

C

Service Information

This appendix shows you how to contact MOXA for information about this and other products, and how to report problems.

In this appendix, we cover the following topics.

- MOXA Internet Services**
- Problem Report Form**
- Product Return Procedure**

MOXA Internet Services

Customer satisfaction is our primary concern. To ensure that customers receive the full benefit of our products, MOXA Internet Services has been set up to provide technical support, driver updates, product information, and user's manual updates.

The following services are provided

E-mail for technical support.....support@moxanet.com (Worldwide)
.....support@moxa.com (The Americas)

World Wide Web (WWW) Site for product information:

.....<http://www.moxa.com>

Problem Report Form

MOXA EDS-518A Series

Customer name:	
Company:	
Tel:	Fax:
Email:	Date:

Serial Number: _____

Problem Description: Please describe the symptoms of the problem as clearly as possible, including any error messages you see. A clearly written description of the problem will allow us to reproduce the symptoms, and expedite the repair of your product.

Product Return Procedure

For product repair, exchange, or refund, the customer must:

- ◆ Provide evidence of original purchase.
- ◆ Obtain a Product Return Agreement (PRA) from the sales representative or dealer.
- ◆ Fill out the Problem Report Form (PRF). Include as much detail as possible for a shorter product repair time.
- ◆ Carefully pack the product in an anti-static package, and send it, pre-paid, to the dealer. The PRA should be visible on the outside of the package, and include a description of the problem, along with the return address and telephone number of a technical contact.

Free Manuals Download Website

<http://myh66.com>

<http://usermanuals.us>

<http://www.somanuals.com>

<http://www.4manuals.cc>

<http://www.manual-lib.com>

<http://www.404manual.com>

<http://www.luxmanual.com>

<http://aubethermostatmanual.com>

Golf course search by state

<http://golfingnear.com>

Email search by domain

<http://emailbydomain.com>

Auto manuals search

<http://auto.somanuals.com>

TV manuals search

<http://tv.somanuals.com>