

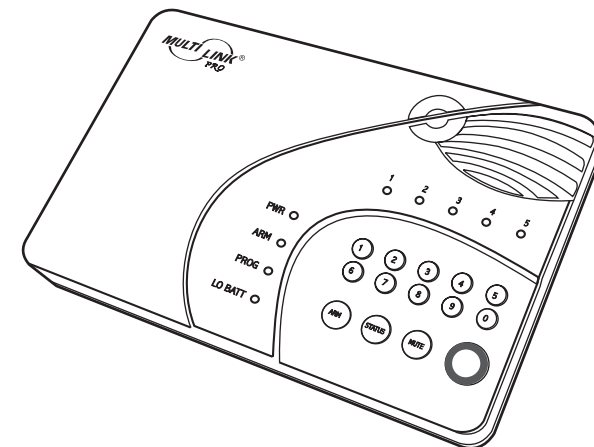

www.skylinkhome.com

Home Smart Center

MODEL: ML-001 / ML-100



P/N. 101Z379-001

FEB, 2011

CUSTOMER SERVICE

17 Sheard Avenue, Brampton, Ontario, Canada L6Y 1J3

Tel : (905) 456-8883

Fax : (905) 456-7819

Email : support@skylinkhome.com

PATENTED
©2011 SKYLINK GROUP

Home Smart Center

USER'S INSTRUCTIONS

IMPORTANT SAFETY INSTRUCTIONS

When using your telephone equipment, basic safety precautions should always be followed to reduce the risk of fire, electric shock and injury to persons, including the following:

1. Do not use this product near water, for example, near a bath tub, wash bowl, kitchen sink or laundry tub, in a wet basement or near a swimming pool.
2. Avoid using a telephone (other than a cordless type) during an electrical storm. There may be a remote risk of electric shock from lightning.
3. Do not use the telephone to report a gas leak in the vicinity of the leak.
4. Use only the power cord and batteries indicated in this manual. Do not dispose of batteries in a fire. They may explode. Check with local codes for possible special disposal instructions.
5. Plug the adaptor to the socket-outlet that near the equipment and shall be easily accessible.

SAVE THESE INSTRUCTIONS

Attention

This product is not an alarm system providing facilities to summon assistance, for use by persons who can be considered to be living at risk. This product is not intended to for use in health care signaling equipment or directly connect to central-station (Police, Medical, Fire).

IC Statement

“This product meets the applicable Industry Canada technical specifications.”

Before installing this equipment, users should ensure that it is permissible to be connected to the facilities of the local telecommunications company. The equipment must also be installed using an acceptable method of connection. In some cases, the company’s inside wiring associated with a single line individual service may be extended by means of a certified connector assembly (telephone extension cord). The customer should be aware that compliance with the above conditions may not prevent degradation of service in some situations.

Repairs to certified equipment should be made by an authorized Canadian maintenance facility designated by the supplier. Any repairs or alterations made by the user to this equipment, or equipment malfunctions, may give the telecommunications company cause to request the user to disconnect the equipment.

Users should ensure for their own protection that the electrical ground connections of the power utility, telephone lines and internal metallic water pipe system, if present, are connected together. This precaution may be particularly important in rural areas.

Caution: Users should not attempt to make such connections themselves, but should contact the appropriate electric inspection authority, or electrician, as appropriate.

“The Ringer Equivalence Number is an indication of the maximum number of terminals allowed to be connected to a telephone interface. The termination on an interface may consist of any combination of devices subject only to the requirement that the sum of the Ringer Equivalence Numbers of all the devices does not exceed five.”

Declaration of Conformity

Application of Council Directive(s) :
Radio Equipment and Telecommunication Terminal Equipment
Directive (1999/5/EC) - R&TTE

Standard(s) to which Conformity is Declared:

EMC:

EN 55022:1998+A1: 2000, EN 61000-3-2: 2000,
EN 61000-3-3: 1995 +A1:2001, EN 55024: 1998+A1: 2001,
EN 50130-4: 1995/A1: 1998, EN 300220-3: 2000,
EN 301489-3: 2002

Safety:

EN 60950-1: 2001, EN 50371: 2002

Telephony:

TBR 21: 1998

Manufacturer's Name: Capital Prospect Limited

Manufacturer's Address: Room 3, 13/F, Block B, Veristrong Industrial Centre,
36 Au Pui Wan Street, Fo Tan, N.T., Hong Kong

Type of Equipment: Home Smart Center

Model No.: AM-002

Serial No.: Not Labelled

Year of Manufacture: 2005

I, the undersigned, hereby declare that the equipment specified above conforms to the above Directive (s) and Standard(s).

Place: Hong Kong

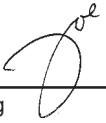

Joe Ng
Project Manager

Date: 21st July 2005

- g) Should you experience trouble with this equipment, please contact Skylink Customer Support at 1-800-304-1187 for repair or warranty information. If the equipment is causing harm to the telephone network, the telephone company may request that you disconnect the equipment until the problem is resolved.
- h) Please follow instructions for repairing if any (e.g. battery replacement section); otherwise do not alternate or repair any parts of device except specified.
- i) Connection to party line service is subject to state tariffs. Contact the state public utility commission, public service commission or corporation commission for information.
- j) **NOTICE:** If your home has specially wired alarm equipment connected to the telephone line, ensure the installation of this model AM-002 does not disable your alarm equipment. If you have questions about what will disable alarm equipment, consult your telephone company or a qualified installer.

NOTICE: According to telephone company reports, AC electrical surges, typically resulting from lightning strikes, are very destructive to telephone equipment connected to AC power sources. To minimize damage from these types of surges, a surge arrester is recommended.

| CONTENT | |
|---|----|
| Introduction..... | 4 |
| Overview..... | 4 |
| Installation..... | 7 |
| Installing the Console..... | 7 |
| Programming Passwords..... | 9 |
| Phone Number Programming..... | 10 |
| Contact ID Phone number..... | 12 |
| Phone Number Programming (Calling to Central Monitoring Station)..... | 12 |
| Account Number Programming..... | 13 |
| Deactivating the Digital Dialer..... | 14 |
| Installing Door/Window Sensors..... | 15 |
| Installing Motion Sensor..... | 16 |
| Operation..... | 18 |
| Alert mode..... | 18 |
| Mute..... | 19 |
| System Status..... | 20 |
| Arming The System..... | 20 |
| Disarming the system..... | 21 |
| Disarming a triggered control panel..... | 22 |
| Disarming under Duress..... | 22 |
| Panic..... | 23 |
| System Failure..... | 23 |
| Phone Line Failure..... | 23 |
| Sensor Failure..... | 24 |
| Low Battery..... | 24 |
| Communication..... | 26 |
| Receiving an emergency call..... | 26 |
| Remote Operation by Telephone..... | 27 |
| To access the control panel away from home..... | 27 |
| Advanced Programming..... | 29 |
| Zone Dependent Setting – Beep / Alarm..... | 29 |
| Zone Dependent Setting – Auto Mute..... | 32 |
| Zone Dependent Setting – Alert Zone (Bypass zone)..... | 33 |
| Learn Keychain / Keypad Remotes..... | 35 |
| Erase Keychain / Keypad Remotes..... | 36 |
| Learn Sensors..... | 37 |
| Sensor Location Selection Guide..... | 37 |
| Erase Sensors..... | 39 |
| Home Automation..... | 40 |
| Learn Control Modules..... | 40 |
| Erase Control Modules..... | 43 |
| Event Trigger..... | 45 |
| Trouble Shooting..... | 47 |
| Accessories..... | 49 |
| System Configuration..... | 53 |
| FCC Information..... | 53 |
| CE..... | 55 |

INTRODUCTION

Overview

Congratulations on your purchase of a Home Smart Center. This is a security control panel which not only functions as a security system, but also monitors your premises by giving you alert notification when the system is not armed. It is also a home automation center, which allows you to remotely control household appliances and lights, even when you are away from home. It can be controlled by dialing in from any touch tone phone, which makes it even more convenient and powerful. Additional accessories such as different kinds of sensors and controllers can be added to suit your specific needs. This user instructions will guide you through the whole setup procedure as well as all the programming instructions. Please follow the instructions closely, you should find it very easy to set up the system.

Alert

When Home (System Not Armed)

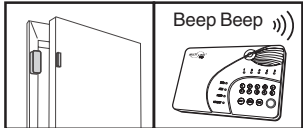

Automation

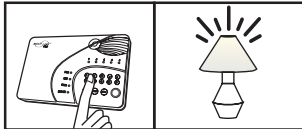

Alarm

Not Home (System Armed)

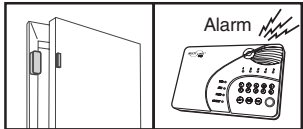

Communicator

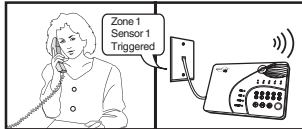

In the package, you should find the following items:

- One Control Panel
- One Motion Sensor (For ML-100A Only)
- Two Door / Window Sensors (For ML-100A Only)
- One Keychain Remote (For ML-100A Only)



FCC Information

Consumer Information:

- This equipment complies with Part 68 of the FCC rules and the requirements adopted by the ACTA. On the bottom of this equipment is a label that contains, among other information, a product identifier in the format **US:AAAEQ##TXXXX**. If requested, this number must be provided to the telephone company.
- An applicable certification jacks Universal Service Order Codes (USOC) for the equipment is provided (i.e., **RJ11C**) in the packaging with each piece of approved terminal equipment.
- A plug and jack used to connect this equipment to the premises wiring and telephone network must comply with the applicable FCC Part 68 rules and requirements adopted by the ACTA. A compliant telephone cord and modular plug is provided with this product. It is designed to be connected to a compatible modular jack that is also compliant. See installation instructions for details.
- The REN is used to determine the number of devices that may be connected to a telephone line. Excessive RENs on a telephone line may result in the devices not ringing in response to an incoming call. In most but not all areas, the sum of RENs should not exceed five (5.0). To be certain of the number of devices that may be connected to a line, as determined by the total RENs, contact the local telephone company. [For products approved after July 23, 2001, the REN for this product is part of the product identifier that has the format **US:AAAEQ##TXXXX**. The digits represented by ## are the REN without a decimal point (e.g., 03 is a REN of 0.3). For earlier products, the REN is separately shown on the label.]
- If this equipment **AM-002** causes harm to the telephone network, the telephone company will notify you in advance that temporary discontinuance of service may be required. But if advance notice isn't practical, the telephone company will notify the customer as soon as possible. Also, you will be advised of your right to file a complaint with the FCC if you believe it is necessary.
- The telephone company may make changes in its facilities, equipment, operations or procedures that could affect the operation of the equipment. If this happens the telephone company will provide advance notice in order for you to make necessary modifications to maintain uninterrupted service.

SYSTEM CONFIGURATION

Master Password _____

Secondary Password _____

Duress Password _____

Sensor locations and settings

| ZONE | SENSOR 1 | SENSOR 2 | BEEP / ALARM | AUTO MUTE | EVENT TRIGGER | ALERT |
|---------|------------|--------------|--------------|-----------|-----------------|-------|
| Example | Front Door | Front Window | Beep Alarm | Y/N | Disabled On/Off | Y/N |
| 1 | | | | | | |
| 2 | | | | | | |
| 3 | | | | | | |
| 4 | | | | | | |
| 5 | | | | | | |

Phone number settings

| PHONE MEMORY | PHONE NUMBER | REDIAL COUNT | REPEAT COUNT |
|--------------|--------------|--------------|--------------|
| Example | 321-123-4567 | 5 | 5 |
| 1 | | | |
| 2 | | | |
| 3 | | | |
| 4 | | | |
| 5 | | | |

Keychain / Keypad Remotes settings

| KEYCHAIN / KEYPAD LOCATIONS | OWNER (KEYCHAIN) / LOCATION (KEYPAD) |
|-----------------------------|--------------------------------------|
| Example | Keychain Owner - John |
| 6 | |
| 7 | |
| 8 | |
| 9 | |
| 0 | |

Control Modules settings

| CONTROL MODULES | LOCATIONS / APPLIANCES |
|-----------------|------------------------|
| Example | Family room lighting |
| 6 | |
| 7 | |
| 8 | |
| 9 | |
| 0 | |

INTRODUCTION

- One AC adapter
- One telephone cord
- Batteries for all sensors (For ML-100A Only)
 - 1 PC 9V Alkaline Battery (PS-101)
 - 1 PC 12V Alkaline Battery Type 23A (4B-101 -installed)
 - 2 PCS 3V Lithium Battery CR-2032 (WD-101 -installed)

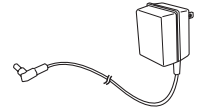

- Rechargeable battery of the Control Panel:

North American version

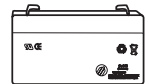

European Version



- Mounting hardware



Ball-head joint
(For ML-100A Only)



Mounting Plate
(For ML-100A Only)



Screws
Pack

Basic installation involves the following procedures:

1. Install Control Panel ML-001A
2. Program Passwords
3. Program Phone Numbers
4. Install Door / Window Sensors WD-101 (For ML-100A Only)
5. Install Motion Sensor PS-101 (For ML-100A Only)

INTRODUCTION

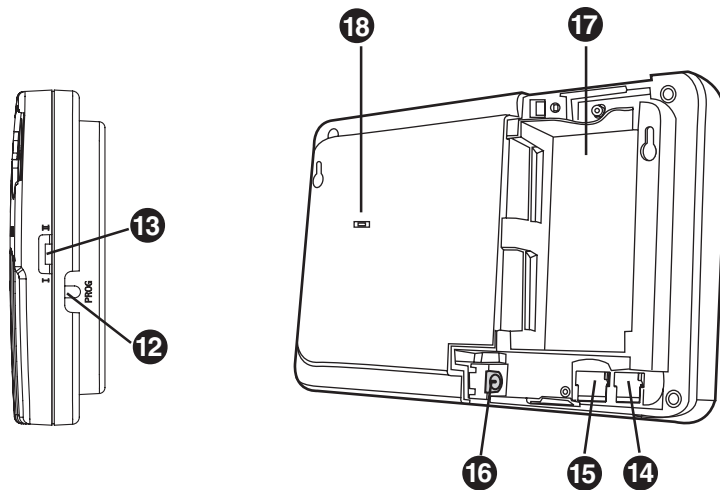
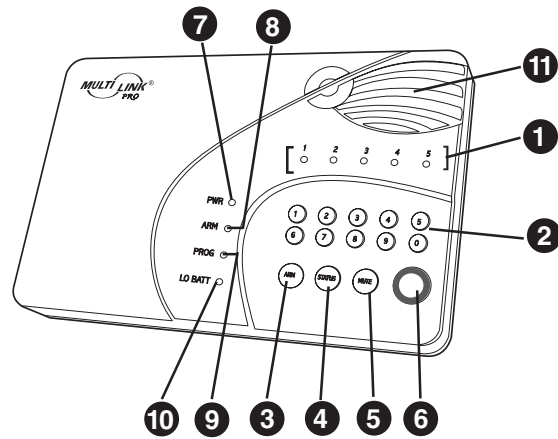

- | | |
|----------------------------|--|
| 1. Zone LEDs | 11. Built-in Siren and Speaker |
| 2. Numeric Keypad | 12. Programming button |
| 3. Arm button | 13. Buzzer Mode Selector |
| 4. Status button | 14. Phone Jack for external phone |
| 5. Mute button | 15. Line Jack for telephone line |
| 6. Panic button | 16. Adapter socket |
| 7. Power LED | 17. Battery Compartment |
| 8. Arm LED | 18. Language Selector (only available for models support multiple languages) |
| 9. Program LED | |
| 10. System Low Battery LED | |

ACCESSORIES

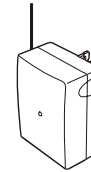

Control Module SW-100 (US and Canada)

- To turn home appliances / lights on / off
- Max rating: 960W (Resistive)

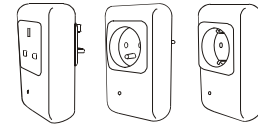

Control Module SW-101U (UK), SW-101F (French), SW-101G (German) (3 models for 3 countries)

- To turn home appliances / lights on / off

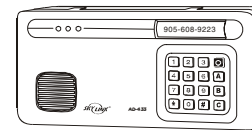

Emergency Dialer (AD-433S)

- External dialer with user programmable voice message
- Calls up to 9 phone numbers
- One personal voice recording up to 40 seconds
- Can be installed anywhere within 100 feet from the control panel, with a phone socket

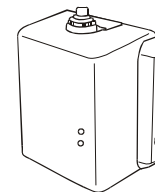

Swing door opener (DM-100)

- Remotely open / close a swing door
- Fits most interior doors

ACCESSORIES

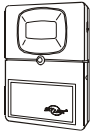

Audio Sensor (AS-101)

- When audio level exceeds preset limit, it will trigger the alarm
- Place beside smoke detector, CO detector, so when these detectors are triggered, the control panel will be triggered



Remote Control (4B-101)

- Additional keychain remotes for other family members
- To arm, disarm or trigger the panic alarm with this remote



Keypad Control (KP-434)

- External keypad control
- To arm, disarm or trigger the the panic alarm with this remote
- Ideal mounting locations include upper floor, backdoor, or garage

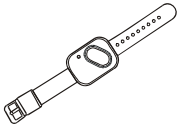

Wrist Watch Style Panic Remote (HW-101)

- Activate the panic alarm instantly with this remote
- Wear it as a watch
- Splashproof design, can be worn during showering



Panic Transmitter (PT-101)

- Activate the panic alarm instantly with this remote
- Wear it as a pendant
- Splashproof design, can be worn during showering

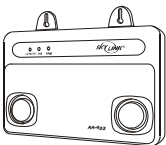

Audio Alarm (AA-433)

- External Siren
- Powered by AC adapter with backup battery

INSTALLATION

Installing the Console

It is important determine where the control panel will be located. Please follow the criteria below to select the ideal location for the control panel.

- Place it where electrical outlet and phone line can be accessed
- Place it where it is easily accessible by the users
- Place it away from any doors or windows which could be accessed by non-intended users
- Place is away from extreme temperature sources such as oven, stove and away from large metal objects which could affect the wireless performance

After a location has been selected, you may begin the installation and connect all the necessary wires and power up the unit.

1. Undo the 2 screws on the battery cover.

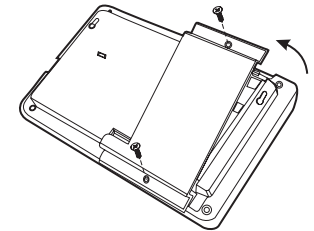

2. For models support multiple languages, select the desired language based on the setting below:

1. German
2. Spanish
3. French
4. English

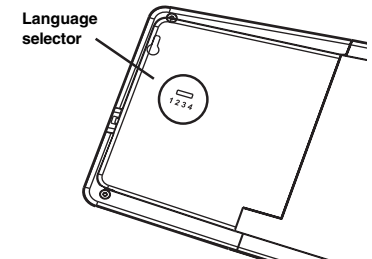

3. Connect the power adapter to the socket inside the battery compartment. The power adapter should be connected to an AC electrical outlet. You should see all LEDs turn on, LO BATT LED should be off.

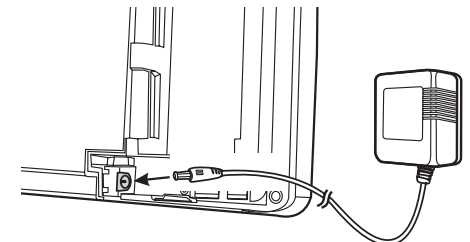

INSTALLATION

4. Insert the rechargeable battery to the battery compartment. There are 2 different types of rechargeable battery for 2 markets:

a. North American Version: Lead Acid

Connect the 2 wires to the battery. Red wire connects to the "+" terminal on the battery. Black wire connects to the "-" terminal on the battery. Markings on the battery should face up.

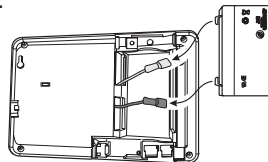

b. European Version: Ni-MH

Plug in the wire from the battery to the battery socket inside the battery compartment.

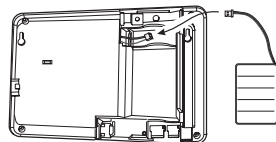

5. After inserting the rechargeable battery, the LO BATT LED will be off if the battery is fully charged, otherwise it will be on.
6. Connect the phone line from the wall socket to the "LINE" socket inside the battery compartment.
7. [OPTIONAL] If another telephone that will be using the same telephone jack, you may connect this telephone to "PHONE" outlet of the control panel by a phone cord (not provided).
8. The phone line(s), cord of the power adapter should all come out from the lower right corner of the control panel in order to close the battery cover properly.
9. The battery cover can now be closed, and tighten the 2 screws to secure the battery cover. PWR, ARM, PROG LEDs should be flashing, zone LEDs should be off.
10. The control panel is intended to be mounted on a flat wall. 2 screws are required to mount the control panel securely on the wall. It should not be mounted too high or too low. In most situations, just below eye level is ideal.
11. Once you have selected the mounting location, tighten 2 screws on the wall. They should be 7-1/8" apart from each other, on the same horizontal level. Do not tighten the screws all the way in, leave about 1/8" from the wall in order for the control panel to be hung onto the wall.

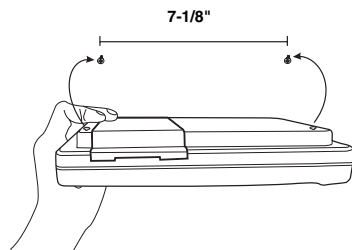
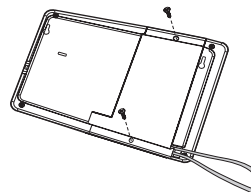
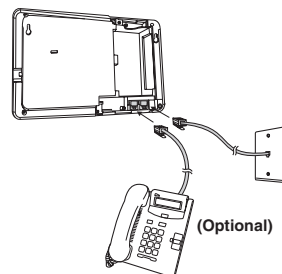

ACCESSORIES

Additional sensors and transmitters as well as add on accessories are available to work with your system.

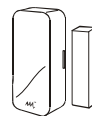

Door/Window Sensor (WD-101)

- Magnetic Contact Sensor
- For all doors or windows
- Batteries included

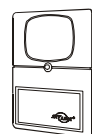

Repeater (RP-434)

- Extend the operation range between 2 wireless devices, such as any sensors and control panel
- Doubles the operation range automatically between sensors and control panel



Water Sensor (FS-101)

- Alerts you when water is detected
- Ideal for water detection in basement, under the sink, even bathroom

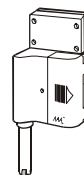

Garage Door Monitor™ Sensor (GS-101) (Available in US and Canada)

- Monitors your garage door
- Alerts you when the garage door is left open



Garage Door Monitor™ Sensor (GS-102) (Available outside US and Canada)

- Monitors your garage door
- Alerts you when the garage door is left open

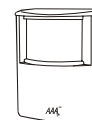

Indoor/Outdoor Motion Sensor (PS-101)

- Monitors area in a 110 degree ARC and up to 40 feet away from the sensor

TROUBLE SHOOTING

Sensors

| | |
|---|--|
| When a sensor is triggered, the control panel doesn't respond at all, what is the problem? | <ul style="list-style-type: none"> - Make sure the battery in the sensor is installed properly, pay attention to the polarity. - Make sure the sensor is learned to the control panel. Follow instructions on page 37 on how to learn a sensor. - You may try to bring the sensor closer to the control panel, ensure it is not out of the operation range. |
| My motion sensor sometimes gets triggered by itself, how can I prevent that? | Ensure the motion sensor is not facing direct sunlight, nor any A/C or furnace vents. You may also reduce the sensitivity to low. If your motion sensor is located outdoors, you may want to relocate it. |
| After mounting the door sensor, it doesn't work anymore. | <ul style="list-style-type: none"> - Please ensure the magnet is aligned with the red marking on the transmitter. - If you are mounting the sensor on to a metal door or window, a spacer may be required to avoid magnetic interference caused by the metal door / window. - Make sure the sensor is within the operation range of the control panel by bringing it closer to the control panel. |
| My motion sensor is not very responsive, sometimes when I walk by it, the control panel doesn't respond, but sometimes it does. | The motion sensor is designed to detect the "First Motion". First Motion means no motion is detected within the past 20 seconds, and if a motion is then detected, that is the "First Motion". So if you continue to walk in front of the motion sensor, it will only pick up the first motion. Unless you wait for 20 seconds, then walk again, the control panel will respond. Otherwise, the control will only respond to the first motion. |

INSTALLATION

Programming Passwords

Master Password can be used for programming, arming, disarming the system, and telephone access. The default Master Password is [1234].







Secondary Password can be used for arming, disarming the system, and telephone access. Secondary Password cannot be used for programming. The default Secondary Password is [0000].

Duress Password is used when you are forcibly compelled to disarm the control panel. Entering the duress password will stop the siren from sounding but the control panel will silently call the emergency phone numbers for help. The default Duress Password is [3838]. You should definitely change this password and let all the users know this password.

Changing Passwords

It is strongly recommended to change all 3 passwords when you first set up the system.

In order to change the password, follow the procedures below.

| Step | Keys | Function | Description | Note |
|------|---|---------------------------------|--|---|
| 1 |  [PROG]  [MPIN] | Enter Programming mode | Enter master password to programming mode | 3 beeps for valid password. 1 long beep for invalid password. |
| 2 |  [2] | Select password programming | | |
| 3 |  [1] or [2] or [3] | Select which password to change | [1] - Master password [2] - Secondary password [3] - Duress password | |
| 4 |  [new 4-digit password] | Enter new password | Select any 4-digit password, each digit can be from 0 to 9 | |
| 5 |  [new 4-digit password] | Enter new password to confirm | Enter the new password again for confirmation | 3 beeps if new password is accepted. You will hear [Password Accepted] |

INSTALLATION

Phone Number Programming







You can program up to 6 Emergency Phone Numbers. When the system is in panic, the control panel will call these phone numbers and announce its status.

The 6 emergency phone numbers include:

- 5 voice message phone numbers
- 1 Contact ID message phone number

Program the following for Voice Message Phone Numbers

- Phone memory (from 1 to 5), this is where the phone numbers will be stored
- Phone number, up to 29 digits.
- Redial count, this is how many times that phone number will be called, from 1 to 9 times.
- Repeat count, this is how many times the emergency message will be repeated, from 1 to 9 times.

| Step | Keys | Function | Description | Note |
|------|---|---------------------------------|---|---|
| 1 |  [PROG] [MPIN] | Enter Programming mode | Enter master password to programming mode | 3 beeps for valid password. 1 long beep for invalid password. |
| 2 |  [1] | Select phone number programming | | You will hear [Enter phone memory] . |
| 3 |  [1] to [5] | Enter phone memory | During emergency, phone memory 1 will be called first, then phone memory 2, 3, 4, and 5. So phone memory 1 has higher priority. | |
| 4 |  [Phone number] + [Arm] | Enter phone number | Phone number can be up to 29 digits.** | You will hear [Enter Redial] . |
| 5 |  [1] to [9] + [Arm] | Enter Redial count | Redial is the number of times that phone number will be called. Each phone number can have a different redial count, from 1 to 9 times. | You will hear [Enter Repeat] . |
| 6 |  [1] to [9] + [Arm] | Enter Repeat count | Repeat is the number of times that voice emergency message will be played, from 1 to 9 times. It is recommended to set up the repeat time to 5 or more. | You will hear [Phone Accepted] indicating the phone number and its settings have been programmed successfully. |

****Note:**

You may enter a 3-second pause between digits by pressing [Mute] if needed. You may also enter consecutive multiple pause periods. For example, you may enter a phone number: (123)-456-7890 [Mute] 1234. After the phone number (123)-456-7890 is dialed, it will wait for 3 seconds, then dial 1234, which can be a password to a paging system, or an access code for a phone dialing system.

TROUBLE SHOOTING

Control Panel

| Questions | Solutions |
|---|--|
| Why I can't arm my system? | Make sure none of the sensors are triggered. You can check this by the zone LEDs, none of them should blink. |
| I cannot arm the system even when no sensor is triggered, and the ARM LED is off. | You need to disarm the system again by either entering the password or disarm by keychain remote. Although the ARM LED is off, but the system is not completely disarmed after an alarm was triggered. Refer to page 22 on how to completely disarm a control panel after an alarm has been triggered. |
| Why the ARM LED keeps flashing? | That means you have not programmed any emergency phone numbers. For instructions on how to program emergency phone numbers, please see page 10. |
| How do I exit programming mode when I'm in the middle of it? | You can press the programming button on the side of the unit to quit programming anytime. |
| When a sensor is triggered, the alarm sounds instantly even it is not armed, why is that? | You have programmed that sensor in alarm mode, instead of beep mode. Please refer to page 29 for instructions of how to program it back to beep mode. |
| When the alarm is triggered, why the control panel won't call all the programmed phone numbers? It always stops before calling the last number. | The control panel will stop calling when it is disarmed by any one of the recipients. Disarm can also be done locally thru the keypad on the control panel by entering a valid password. |
| Why the control panel doesn't beep when a sensor is triggered, while only the zone LED flashes? | You have placed the buzzer mode selector on the side of the control panel to "I", this will disable the beeping. Placing it to "1" will enable the beeping. |
| The control panel is in armed mode, why activating a sensor will not cause an alarm, or call any emergency phone number? | If the triggered sensor is programmed in the Alert Zone (Bypass Zone), alarm will not sound, and emergency call will not be made if this sensor is triggered. The control panel will only respond when it is disarmed, in alert mode. |

HOME AUTOMATION

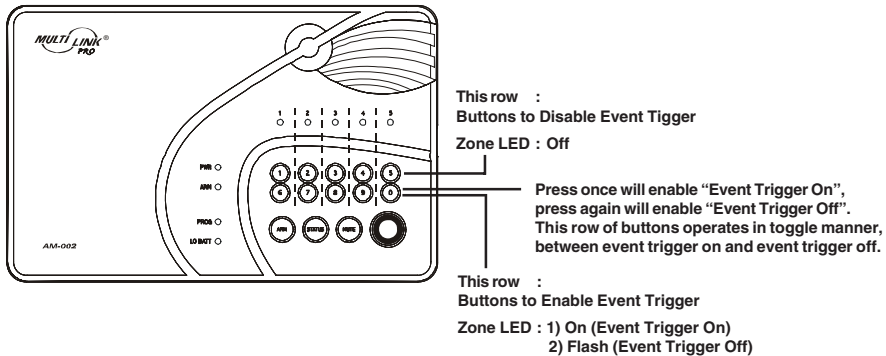

| | DISABLE EVENT TRIGGER | ENABLE EVENT TRIGGER |
|--------|-----------------------|----------------------|
| Zone 1 | Button [1] | Button [6] |
| Zone 2 | Button [2] | Button [7] |
| Zone 3 | Button [3] | Button [8] |
| Zone 4 | Button [4] | Button [9] |
| Zone 5 | Button [5] | Button [0] |

INSTALLATION

Note:

- It's not recommended to program 911, fire station or any emergency services phone numbers into any of the phone memories without their approvals.
- Ensure to program a valid phone number and write down the programmed phone number on the System Setting Information provide on the back of this user's instructions.
- You may quit programming by pressing [PROG] button at any time.
- If no phone number is programmed, the ARM LED will continue to flash.

Testing Phone Numbers:

After you have programmed all the phone numbers, you should verify you have programmed the phone numbers correctly. This can be done by triggering the alarm silently by entering the duress password, so it dials to the programmed phone numbers without sounding the alarm.

Note:

You must inform the recipients of the programmed phone numbers, so they know what to expect when they receive the phone call from the control panel during an emergency. These recipients should know the password to your control panel if you expect them to have remote access of your control panel. For more information regarding receiving the emergency call, please refer to page 26.

1. Press [Arm], you should hear beeping from the control panel.
2. Press [3838]. Beeping will stop, and the control panel will start to dial the first number.
3. The called party should receive the call. Pick up the call and say "Hello", an emergency message "System Panic" will be played. If the programmed phone doesn't ring, ensure the phone number is programmed correctly, or reprogram this phone number again.
4. After the emergency message has been played for several times (depending on how many times it was programmed), the called party will hear "Enter Password".
5. Enter either the master password or secondary password. If the correct password is accepted, you will hear "Password Accepted", otherwise, you will hear "Password Failure".
6. Press [0][#] on the telephone to hang up.
7. The control panel will start to dial the next programmed phone number.

Note:

- Refer to page 26 [Receiving the Emergency Call] for more info on how to react to an emergency call.
- The password is treated as a confirmation of the emergency message. Once a valid password is entered, the control panel will not call that number again, it will proceed to the next number.
- If any one of the called parties disarms the control panel, the control panel will not continue to dial the remaining phone numbers.
- After calling all the programmed phone numbers, the control panel will be back to the previous operation mode.

INSTALLATION

Contact ID Phone number

You can program a telephone number for calling to the central monitoring station. When the system is in panic, the control panel will call this phone number and will send out a Contact ID message with event code 140, which represents "General Alarm".

Follow the instructions below to program the necessary info in order to call a monitoring station:

- Phone number of central monitoring station (up to 29 digits)
- Account number given by the Central Monitoring Station

Phone Number Programming (Calling to Central Monitoring Station)

| Step | Keys | Function | Description | Note |
|------|------------------------------------|---------------------------------------|--|--|
| 1 | Press [PROG] Press [MPIN] | Enter Program- ing mode | Enter master password to programming mode | 3 beeps for valid password. 1 long beep for invalid password. |
| 2 | Press [1] | Select phone number programming | | You will hear [Enter Phone Memory] |
| 3 | Press [0] | Enter phone memory | During emergency, the Contact ID phone number has the highest priority, it will be the first number to call. | You will hear [Phone Zero] |
| 4 | Enter [Phone number] + [Arm] | Enter phone number | Phone number can be up to 29 digits. | You will hear [Phone Accepted] indicating the phone number has been programmed successfully. |

HOME AUTOMATION

Event Trigger

You can control up to 5 different devices not only manually, but also automatically. It is called Event Trigger. That means when a sensor is triggered, the control panel will transmit a signal to activate the designated control module. Applications include:

- Lights on when you open the front door (walking into a room, lights on automatically), this is called "Event Trigger on".
- Lights off when you open a door. (walk away from a room, turns lights off), this is called "Event Triggered off".

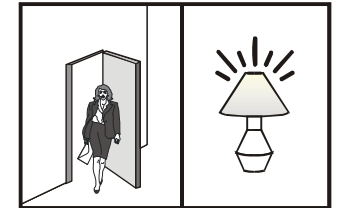

Event Trigger On

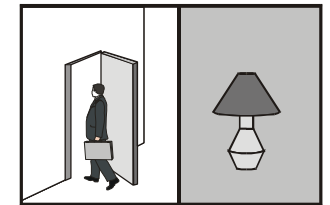

Event Trigger Off

Event trigger is only applicable to the sensor(s) and control module in the same zone. For example, you can program control module 1 to be on or off when zone 1 sensor(s) is triggered. You can also program control module 2 to be on / off when zone 2 sensor(s) is triggered.

Factory Default: This feature is disabled for all zones at the factory.

To change the event trigger setting follow the instructions below.



| Step | Keys | Function | Description | Note |
|------|--|---|---|---|
| 1 | [PROG] [MPIN] | Enter Program- ing mode | Enter master password to programming mode | 3 beeps for valid password. 1 long beep for invalid password. |
| 2 | [7] | Select Event Trigger | | After [7] is entered, some zone LEDs will be off, on or flash. This indicates the setting of event trigger. |
| 3 | Disable Event Trigger: [1] to [5] Enable Event Trigger: [6] to [0]. | Select which zone you would like to enable / disable event trigger. | Refer to the diagram below to select the appropriate setting. | If event trigger "ON" is enabled, that zone LED will be on. If event trigger "OFF" is enabled, that zone LED will flash. If it is disabled, the zone LED will be off. You are allowed to make multiple changes before terminating programming mode. |
| 4 | [PROG] when finished. | Terminate programming mode. | | PROGLED will be off. |

HOME AUTOMATION

| ZONE LED | DESCRIPTION |
|--------------------------|--|
| Off | Zone is not occupied by any control module |
| Flashes twice | That means a remote has occupied that zone. THIS IS NOT A CONTROL MODULE, THEREFORE, SHOULD NOT BE ERASED. |
| Flashes once | That zone is occupied by a control module. You may select this zone to erase this control module. |
| Flashes once, then twice | That means this zone is occupied by a remote AND a control module. You may select this zone to erase the control module. |

** Table F: Zone LED status for erasing control module.

Part 2 Erase communication from Control Panel to Control Module







| Step | Keys | Function | Description | Note |
|------|--|---|--|------|
| 1 |  Remove the control module from the electrical outlet | | | |
| 2 |  Press and hold the learn button on the control module while plugging in the control module to an electrical outlet. | To erase the memory of the control module | Control module LED will flash rapidly indicating all the memory is erased. You may now release the learn button. | |

Once the memory of the control module is erased, all of its memory is cleared. If you have other remotes / control panels controlling this control module, you need to re-program those remotes / control panels.

INSTALLATION

Account Number Programming





In order to program the account number, follow the procedures follow:

| Step | Keys | Function | Description | Note |
|------|--|---|---|---|
| 1 |  Press [PROG]  Press [MPIN] | Enter Programming mode | Enter master password to programming mode | 3 beeps for valid password. 1 long beep for invalid password. |
| 2 |  Press [2] | Select password programming | | |
| 3 |  Press [0] | Select to add / change account number | [0] = Add/change account number | |
| 4 |  Enter [New 4-digit Account Number] | Enter new account number | Enter the 4-digit account number given by the central monitoring station. | This number can be a combination of 0-9, B,C,D,E & F. To enter 0-9 : Enter by the keypad 0-9 directly. To enter B,C,D,E,F : Press [STATUS] and the ARM light will stay on. Then press the following keys for the corresponding letters (1=B, 2=C, 3=D, 4=E, 5=F). Press [STATUS] to return back to number-mode when you want to input numbers. The ARM light will turn off. You can toggle between the number or letter mode by pressing [STATUS] when entering the account number. |
| 5 |  Enter [New 4-digit Account Number] | Enter the new account number again for confirmation | | 3 beeps if new account number is accepted. You will hear [Password Accepted] |

INSTALLATION

Deactivating the Digital Dialer

You can deactivate the digital dialer by erase the phone number memory for central monitoring station.

| Step | Keys | Function | Description | Note |
|------|--|--|---|---|
| 1 |  Press [PROG] Press [MPIN] | Enter Program- ming mode | Enter master password to programming mode | 3 beeps for valid password. 1 long beep for invalid password. |
| 2 |  Press [1] | Select phone number programming | | You will hear: [Enter Phone Memory] |
| 3 |  Press [0] | Enter phone memory | | |
| 4 |  Press [ARM] | Confirm delete the phone number. | | You will hear [Phone Zero Empty Memory] indicating the phone number have been deleted, the digital dialer is deactivated. |

Note: If no phone number is programmed to call the central monitoring station, the digital dialer is automatically disabled.

HOME AUTOMATION

Operation

To turn off a light with the control panel:

1. Press the device number button on the control panel, i.e. pressing 1 will turn off device 1, pressing 2 will turn off device 2.
2. You will hear **[Device X Off]**, where X is the device number.
3. You will also see the PROG LED flashing, indicating the control panel is sending out the wireless signal to control the specific device.
4. If the receiver receives the signal, the control panel will announce **[Device Off Accepted]**.

To turn on a light with the control panel:



1. Press the number below the device number that you would like to turn on, i.e. pressing 6 will turn on device 1, pressing 7 will turn on device 2.
2. You will hear **[Device X On]**, where X is the device number.
3. You will also see the PROG LED flashing, indicating the control panel is sending out the wireless signal to control the specific device.
4. If the receiver receives the signal, the control panel will announce **[Device On Accepted]**.

Erase Control Modules

To erase a control module from the control panel, it is similar to learning a control module, which involves 2 parts.

1. Erase the memory of the control panel
2. Erase the memory of the control module

Part 1 Erase the memory of the Control Panel

| Step | Keys | Function | Description | Note |
|------|---|--|--|--|
| 1 |  [PROG] [MPIN] | Enter Programming mode | Enter master password to programming mode | 3 beeps for valid password. 1 long beep for invalid password. |
| 2 |  [0] | Select erase control module programming | | After [0] is entered, some zone LEDs will flash or stay off. The zone LEDs represent whether that zone is occupied by any control module. **See Table F |
| 3 |  To erase an occupied control module, press [1] to [5]. | Select the control module location you would like to erase | Refer to the table below to select the control module location. | After you have selected the remote location, you will hear 3 beeps and verbal confirmation [Device X Empty Memory] , where X is the control module location you have selected. |

HOME AUTOMATION

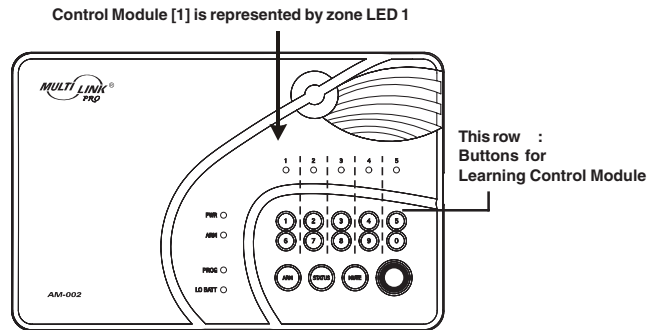

Part 2 Learn signal from Control Panel to Control Module

| Step | Keys | Function | Description | Note |
|------|--|---|---|--|
| 1 | Press and hold the learn button on the Control Module until its LED starts to flash. | Enter Programming mode | | LED on the Control Module will flash indicating it is in learn mode. |
| 2 | [6] to [0] | Transmit an ON signal for the selected device from the Control Panel to the Control Module. | Refer to the chart below to determine which button [6] to [0] to press. You should transmit the "ON" command for the selected device. | After [X] is entered, you will hear [Device X On] indicating you have transmitted an ON signal for device X, where X is the Control Module Location. The LED on the Control Module should be off, indicating it has learned the signal, you may now release the learn button and the LED will stay on again. |

| CONTROL MODULE LOCATION | TRANSMIT BUTTON [X] |
|-------------------------|---------------------|
| 1 | 6 |
| 2 | 7 |
| 3 | 8 |
| 4 | 9 |
| 5 | 0 |

INSTALLATION (ML-100A Only)

Installing Door / Window Sensors

Window / Door Sensor is used to monitor doors or windows that open and close. When these doors / windows are open or closed, the sensors will transmit a signal to the control panel to notify the user. These sensors consist of 2 parts, one is the transmitter, the other is the magnet.

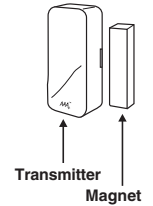

Before installing the sensor, remove the battery isolator by pulling out the yellow tab. Once the isolator is removed, the corresponding zone LED on the control panel will flash and buzzer will beep. If the magnetic contact is closed, the beeping will stop.

Note:

- Both Window/Door Sensors have been programmed at the factory. They are Zone 1 Sensor 1 and Zone 2 Sensor 1. Trigger the sensor and listen to the beeping and zone LED to determine which one is zone 1 and which is zone 2.

Mounting the Sensor

The transmitters should be mounted on the door frame or window frame by double sided tape. The magnet should be mounted on the door or window by either double sided tape or screws. Make sure the magnet is aligned with the red marking on the transmitter. If the surface of the frame is flat enough, double-sided foam tape is sufficient, otherwise, it is recommended to screw the mounting plate to the frame, then apply double sided tape. After mounting the sensor, if the AAA+ logo is inverted, remove the front cover and rotate it so the AAA+ logo is in the upright position.

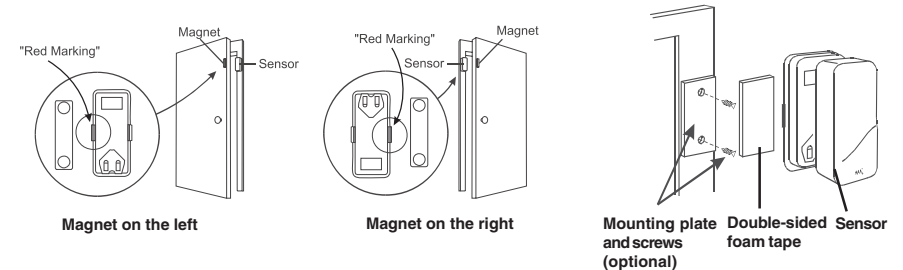

Testing:

After mounting the sensor, test the sensor by opening and closing the door or window. Open the door or window will result in the following:

1. Beeping - The number of beep represents the zone number.
2. Zone LED flashing - Number of flash represents the sensor number.

INSTALLATION (ML-100A Only)

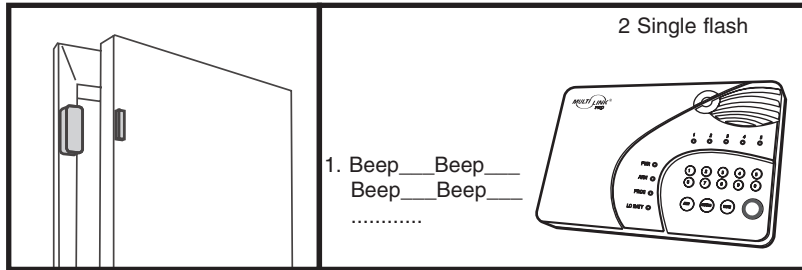

Note:

- Try to mount the sensors as far away from the floor as possible to avoid damaging them. Mounting the sensors at a higher position will also result in better operating range.

- Do not mount the sensor to the exterior of the door / window, always mount the sensor to the interior side of the door / window to avoid being damaged or stolen by non-intended users.

Installing Motion Sensor

The motion sensor is most suitable for guarding a large area such as living room, family room, or bedroom. It can also be used to monitor a hallway or stairway.

Insert Battery

Undo the screw on the back of the motion sensor and remove the battery cover. Connect a 9V alkaline battery to the battery connector. Please note the polarity.

If you are planning to install the motion sensor outdoor, you should reduce the sensitivity by placing the jumper at location "2".

For indoor application, if you want to reduce the sensitivity, you can change the jumper setting to "2" as well.

| | |
|-------------------|------------------|
| Jumper Location 1 | High Sensitivity |
| Jumper Location 2 | Low Sensitivity |

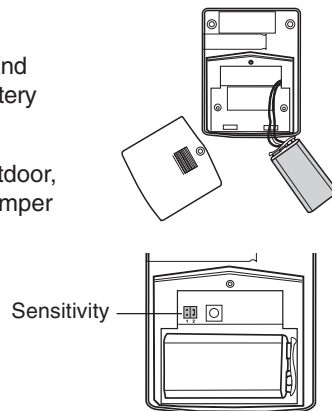

Caution:

Depending on the environment, if you experience a false trigger when the motion sensor is placed outdoors, you should relocate it or even place it indoors. Wind blowing at a tree, or direct sunshine could cause a false trigger. Therefore, if the location at where the motion sensor is mounted could cause a false trigger, you should change the mounting location for such sensor.

HOME AUTOMATION

Part 1 Learn signal from Control Module to Control Panel

| Step | Keys | Function | Description | Note |
|------|--|---|--|---|
| 1 | [PROG] [MPIN] | Enter Programming mode | Enter master password to programming mode | 3 beeps for valid password. 1 long beep for invalid password. |
| 2 | [4] | Select learn control module programming | | After [4] is entered, some zone LEDs will flash or stay off. The zone LEDs represent whether that zone is already occupied by another control module.**See Table E. |
| 3 | [1] to [5] | Select control module location (Max. 5 control modules) | Select the location [1], [2], [3], [4], or [5]. | After you have selected the control module location, that zone LED will be on. |
| 4 | Activate the control module by pressing its learn button once quickly. | Send signal from control module to control panel. | Once the signal is transmitted to the Control Panel, that signal will be stored. | You will hear [Device X Accepted] , where "X" is the control module location. |

| ZONE LED | DESCRIPTION |
|--------------------------|--|
| Off | Zone is not occupied by any control module |
| Flashes once | This zone is occupied by another control module. Programming another remote to this zone will overwrite the previous control module. |
| Flashes twice | This zone is occupied by a remote. You can still program a control module to this zone, and it will not overwrite the remote you have in this zone. |
| Flashes once, then twice | This zone is occupied by a remote AND a control module. If you program another control module to this zone, it will overwrite the previous control module, but not the remote. |

** Table E: Zone LED status for learning control module.

HOME AUTOMATION

The Control Panel can be used to control lights and home appliances with a Control Module, (Control Module is sold separately). Garage door opener can be controlled with a Garage Door Receiver (sold separately). The Control Panel can control up to 5 Control Modules / Garage Door Receivers.

There are 3 ways to control these modules / receivers:

1. Using the keypad on the control panel to operate these modules / receivers manually

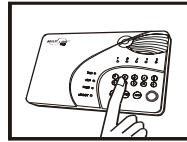

2. Calling in away from home using a touch tone phone (Refer to "Remote Operation by Telephone")



3. Setting up Event Trigger (Refer to Advanced Programming)

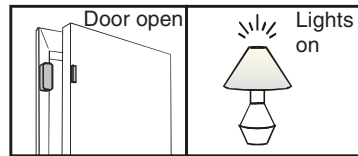

These control modules should be programmed to the control panel as device 1 to 5. Please follow the programming instructions below to program these control modules.

Learn Control Modules

Both control panel and control module are transceivers, meaning they can transmit and receive signals from each other. For home automation, the user will initiate an action from the control panel, such as sending a signal to turn on the light, then the control module will receive such signal and respond. The control module will then send back a confirmation to the control panel to indicate the light has been turned on.

Therefore, during programming, it is required to program 2 things:

1. Signal from control module to control panel (confirmation signal)
2. Signal from control panel to control module (command signal)

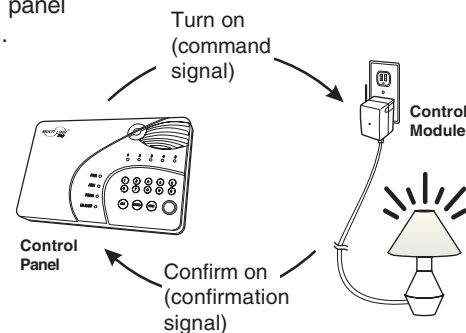

INSTALLATION (ML-100A Only)

For outdoor monitoring, please refer to page 33 to program the motion sensor to Alert Zone.

You may now close the battery cover and re-insert the screw.

Mount the ball-head joint on the wall with screws provided. Slide the back of the sensor into the ball-head joint. The mounting angle can be adjusted.

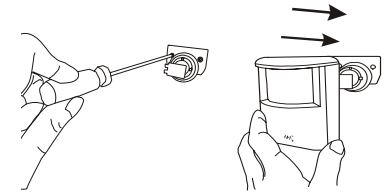

Testing

Walk test should be performed after the motion sensor is mounted. Walk in the detected area, if motion is detected, a red light inside the sensor will glow. If the red light does not glow, motion has not been detected and you may need to re-position the sensor. Ensure you walk test all the locations that you would like the motion sensor to cover.

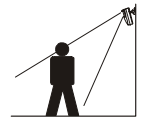

Note:

- Perform the walk test after you have inserted the battery for more than 1 minute.
- Before performing the walk test, the sensor should not detect any motion.
- After motion is detected once, the sensor will not be triggered unless no motion is detected for 20 seconds. Therefore, wait for at least 20 seconds during walk testing between 2 activations.

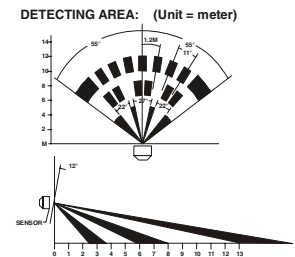

Caution:

When installing the motion sensor, avoid placing it near heat or cold producing devices (i.e. A/C or furnace vents, fans, ovens, space heaters, etc). Air movement, especially caused by changes in temperature may trigger the Motion Sensor and cause false alarms. Please carefully test your Motion Sensor so that it will only be triggered by wanted movement.

You have now successfully installed and programmed the Control Panel and its sensors. Please follow the rest of the instructions for operations and advanced programming.

OPERATION

The Control Panel is always in one of the 2 operating modes:

1. Alert Mode - When the system is not armed (ARM LED off), it is in alert mode.
2. Alarm Mode - When the system is armed (ARM LED on), it is in alarm mode.

Alert Mode

The Control Panel will be in alert mode automatically if the system is not armed. Alert mode allows users inside the premises to know what sensor is triggered. It is intended to be used when someone stays inside the premises.

In alert mode, the control panel will give you notification of the triggered sensor(s) by voice announcement, unique beeping and LED flashing.

| | | |
|---|-------------------------------|---------------------------------------|
| 1 | Number of beeps | Zone of the triggered sensor |
| 2 | Number of flashes of zone LED | Sensor number of the triggered sensor |

Note:

- Each zone can program up to 2 sensors. There are 5 zones, so up to 10 sensors can be programmed to the control panel. Please refer to page 37, "Sensor Location Selection Guide" for detail information.

Alert Mode Examples (Door/Window sensor sold separately)

| | |
|------------------------------------|--|
| <p>Zone 1 Sensor</p> | <p>1. Beep ___ Beep ___ Beep ___ Beep</p> <p>2. Single flash</p> |
| <p>Zone 3 Sensor 2 window open</p> | <p>1. Beep Beep Beep ___ Beep Beep Beep ___</p> <p>2. Double flash</p> |

Note:

-For Door / Window sensor, alert notification (beeping and LED flashing) will continue until the sensor is in closed position, i.e. closing the window or door.

-For motion sensor, the alert notification was disabled at the factory default. To perform the walk test, it requires to enable the Alert Zone (Bypass Zone) feature in the Control Panel. After the walk test, it needs to disable this alert zone feature otherwise it will bypass the signal in the alarm mode. Please refer to the page 33, "Alert Zone" for detail. Please refer to information.

ADVANCED PROGRAMMING

| | SENSOR 1 | SENSOR 2 |
|--------|------------|------------|
| Zone 1 | Button [1] | Button [6] |
| Zone 2 | Button [2] | Button [7] |
| Zone 3 | Button [3] | Button [8] |
| Zone 4 | Button [4] | Button [9] |
| Zone 5 | Button [5] | Button [0] |

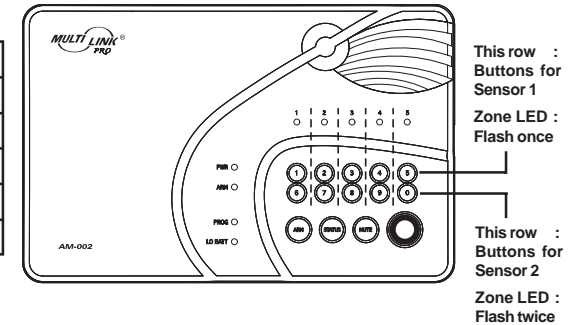

Erase Sensors

Proceed to the following to erase a sensor.

| Step | Keys | Function | Description | Note |
|------|--|---|---|--|
| 1 | [PROG] [MPIN] | Enter Programming mode | Enter master password to programming mode | 3 beeps for valid password. 1 long beep for invalid password. |
| 2 | [9] | Select erase remote programming | | After [9] is entered, some zone LEDs will flash or stay off. The zone LEDs represent whether that zone is occupied by any sensor. **See Table D below. |
| 3 | To erase an occupied sensor, press [1] to [0]. | Select the sensor you would like to erase | Refer to the table below to select the remote location. | After you have selected the sensor, you will hear 3 beeps and verbal confirmation [Zone X Sensor Y Empty Memory], where X and Y are the zone and sensor numbers you have selected. |

| ZONE LED | DESCRIPTION |
|--------------------------|---|
| Off | Zone is not occupied by any sensor |
| Flashes once | This zone is occupied by sensor 1. |
| Flashes twice | This zone is occupied by sensor 2. |
| Flashes once, then twice | This zone is occupied by sensors 1 and 2. |

** Table D: Zone LED status for erasing sensors.

ADVANCED PROGRAMMING

| | SENSOR 1 | SENSOR 2 | ZONE DEPENDENT FEATURES | | | |
|--------|----------|----------|-------------------------|-----------|---------------------|-------|
| | Location | Location | Beep / Alarm | Auto Mute | Event Trigger | Alert |
| zone 1 | | | Beep / Alarm | Y / N | Disabled / On / Off | Y / N |
| zone 2 | | | Beep / Alarm | Y / N | Disabled / On / Off | Y / N |
| zone 3 | | | Beep / Alarm | Y / N | Disabled / On / Off | Y / N |
| zone 4 | | | Beep / Alarm | Y / N | Disabled / On / Off | Y / N |
| zone 5 | | | Beep / Alarm | Y / N | Disabled / On / Off | Y / N |

Table C

4. Once you have filled out the table, it should look something like this.

| | SENSOR 1 | SENSOR 2 | ZONE DEPENDENT FEATURES | | | |
|--------|-----------------|-----------------|-------------------------|-----------|---------------------|-------|
| | Location | Location | Beep / Alarm | Auto Mute | Event Trigger | Alert |
| zone 1 | Front Door | Front Window | Beep / Alarm | Y (N) | Disabled (On) / Off | Y (N) |
| zone 2 | Kitchen Motion | | Beep / Alarm | Y (N) | Disabled / On / Off | Y (N) |
| zone 3 | Back Door | | Beep / Alarm | Y (N) | Disabled / On / Off | Y (N) |
| zone 4 | Backyard Motion | | Beep / Alarm | Y (N) | Disabled / On / Off | Y (N) |
| zone 5 | Basement Water | Basement Motion | Beep / Alarm | Y (N) | Disabled / On / Off | Y (N) |

You may refer to each column representing the zone dependent feature, to program each zone with the selected feature. For example, Auto Mute feature is only enabled for zone 3, when you are in the auto mute programming, you should enable this feature for zone 3 only, the rest of the zones should have this feature disabled. Repeat this step for all 4 zone dependent features during programming.

5. You may now follow the procedure below "Learn Sensor Continue" to program the sensor(s) to the desired zone(s).

Learn Sensors - Continue

| Step | Keys | Function | Description | Note |
|------|---|---------------------------------|---|--|
| 1 | [PROG] [MPIN] | Enter Programming mode | Enter master password to programming mode | 3 beeps for valid password. 1 long beep for invalid password. |
| 2 | [3] | Select learn sensor programming | | After [3] is entered, some zone LEDs will flash once, or twice, some will be off. The zone LEDs represent whether that zone is already occupied by another sensor. **See Table D next page. |
| 3 | [0] to [9] | Select sensor location | Refer to the diagram below to select the sensor location, which includes the zone and sensor number. | After you have selected the zone, that zone LED will be on. |
| 4 | Activate the sensor you would like to program to this zone. | Trigger sensor | Once the sensor is activated, the signal will be transmitted to the Control Panel which will be stored. | You will hear [Zone X Sensor Y Accepted], where X and Y are the zone and sensor numbers you have selected. |

OPERATION

Mute

When the alert beeping becomes undesired, you can terminate the beeping in 3 different ways:

1. Mute button - Manual mute by pressing the mute button

Pressing the mute button will temporary disable the beeping for all the activated sensors. For example, if a window with a window sensor will be open for a long period of time, the continuous beeping may become undesired. Pressing the mute button will temporary disable the beeping for this sensor only, it will still beep if other sensors are triggered. This sensor will beep again if this window is closed, and then opened.

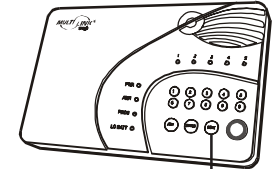

Mute Button

2. Change the buzzer mode - Disable Beeping

The beeping can be disabled for all zones by changing the buzzer mode selector.

Buzzer Mode Selector

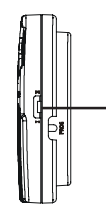

- If the buzzer mode selector is at "I", beeping is enabled.
- If the buzzer mode selector is at "II", beeping is disabled.

If beeping is disabled, all sensor alert beeping will be disabled, however, the voice announcement and LED flashing will still function.

3. Enable Auto-Mute in Advanced Programming

If this feature is enabled for that zone, beeping will be terminated automatically after 15 seconds. Refer to "Advanced Programming" - Auto Mute" on page 32 for more information on how to enable this feature.

OPERATION

System Status

The control panel continuously monitors the system status as well as all the sensors status. It will monitor occurrences such as triggered sensors, low battery sensors, malfunction sensors, or phone line failure etc.

In order to check the system status, user can press the "Status" button on the control panel, voice announcement will be made regarding the system and sensor status. When the "Status" button is pressed, you will be notified if any of the following events is occurring:

- System armed or disarmed
- Any triggered sensors
- Any sensors with low battery warning
- Any sensors with failure warning
- Phone line failure

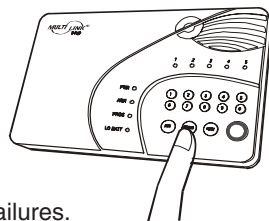

Refer to page 23 for more details regarding system failures.

Arming the System

You should arm the system when you are the last person to leave the house. By arming the system, the control panel will call the preprogrammed emergency phone numbers and the siren will sound when break-in occurs.

Caution: Only arm the system when nobody is expected to be inside the premises. When someone is expected to be within the premises, the system should not be armed.

To arm the system, follow the procedures below:

1. Press [Arm] on the control panel or keychain remote. 2. Leave the premises within 45 seconds. 3. After 45 seconds. System will be armed.

1. Press [Arm] button on the control panel when no sensors are triggered. You can also use the keychain remote to arm the system by pressing arm button on the remote.

ADVANCED PROGRAMMING

Learn Sensors

You can program up to 10 sensors to the control panel. There are 5 zones on the control panel, each zone can program up to 2 sensors. Before programming a sensor, you must decide which sensor location (zone number and sensor number) you would like to program the sensor to. It is strongly recommended that you refer to "Sensor Location Selection Guide" before deciding which sensor location you would like to program the new sensors to. Some features you may need to consider are: 1) Beep/Alarm setting, 2) auto mute, 3) alert zone, 4) event trigger. Explanation for each feature can be found in the following pages in Advanced Programming:

1. Beep/Alarm Setting - Page 29
2. Auto Mute - Page 32
3. Alert Zone - Page 33
4. Event Trigger - Page 45

Sensor Location Selection Guide

You can program up to 10 sensors to the control panel. There are 5 zones and maximum 2 sensors per zone. The 4 features mentioned above are Zone dependent features meaning both sensors in that zone will operate based on the setting for that zone. So if you program 2 sensors into one zone, those 2 sensors will react in the same manner for those zone dependent features. For example, if you enable the Auto-Mute feature for zone 1, both zone 1 sensor 1, and zone 1 sensor 2 will have this feature enabled. It is not possible to enable a zone dependent feature for sensor 1 only, but not sensor 2.

Therefore, the followings are some suggestions of how you should select the sensor location.

1. Check all the zone dependent features, and determine if you would like to enable any one of them.
2. If you decide not to enable any zone dependent features and keep the factory default setting, you can simply program the sensor to any sensor location based on your own preference. Omit the following steps and proceed to "Learn Sensor - Continue".
3. If you decide to enable some of the zone dependent features, check Table C below. Circle the zone dependent feature selections. If there are features that you would like to enable for more than 2 sensors, you need to select more than one zone for those features.

ADVANCED PROGRAMMING

Remote [6] is represented by zone LED 1

| ZONE LED | REMOTE LOCATION |
|----------|-----------------|
| 1 | 6 |
| 2 | 7 |
| 3 | 8 |
| 4 | 9 |
| 5 | 0 |

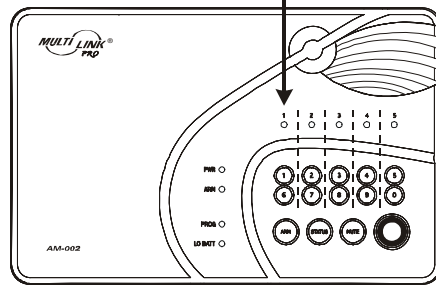

Erase Keychain / Keypad Remotes

Follow the instructions below to erase keychain or keypad remotes / receivers.

| Step | Keys | Function | Description | Note |
|------|--|--|---|---|
| 1 | [PROG] [MPIN] | Enter Programming mode | Enter master password to programming mode | 3 beeps for valid password. 1 long beep for invalid password. |
| 2 | [0] | Select erase remote programming | | After [0] is entered, some zone LEDs will flash or stay off. The zone LEDs represent whether that zone is occupied by any remote. ** See Table B below. |
| 3 | To erase an occupied remote, press [6] to [0]. | Select remote location you would like to erase | Select a remote location [6], [7], [8], [9] or [0]. | After you have selected the remote location, you will hear 3 beeps and verbal confirmation [Device X Empty Memory], where X is the remote location you have selected. |

| ZONE LED | DESCRIPTION |
|--------------------------|---|
| Off | Zone is not occupied by any remote |
| Flashes twice | This zone is occupied by a remote. You may select this zone to erase this remote. |
| Flashes once | This zone is occupied by a control module (Optional). THIS IS NOT A REMOTE CONTROL, THEREFORE, SHOULD NOT BE ERASED. (Refer to page 43 Erase Control Module for more information) |
| Flashes once, then twice | This zone is occupied by a remote AND a control module. You may select this zone to erase the remote. |

** **Table B:** Zone LED status for erasing keychain/keypad remote(s).

* Please refer to erase control module on page 43.

OPERATION

Note:

- The control panel cannot be armed if there are triggered sensors. Make sure all sensors are in closed position, i.e. (close all doors, windows, no movement should be detected etc).
- The control panel can be armed if there are sensors with low battery or failure warning.

2. After pressing the "ARM" button, the "ARM" LED will flash and you will have 45 seconds to leave the premises, this is called the exit delay. You will hear beeping during the exit delay interval. The beeping rate will change from slow to fast, the faster the beep rate, the less time you have left to leave the premises before the siren sounds.

3. When the exit delay expires, the control panel will announce "System Armed", beeping will stop and the ARM LED will be on steadily. This indicates the system is now armed.

Note:

The control panel can also be armed remotely when nobody is home, with a touch tone phone. Please refer to "Remote Operation by Telephone" on page 27.

Disarming the system

If a sensor is triggered while the control panel is armed, such as entering a house with an armed control panel, an entry delay will be triggered. User is allowed to disarm the control panel during the 30-second entry delay. If the control panel is not disarmed within 30 seconds, siren will sound immediately and emergency calls will be made. To disarm the control panel, follow the instructions below.

Entry delay 30 seconds

Beep Beep

1. Entering the premises will trigger the entry delay.

Arm LED flashes

Beep Beep

OR

2. Enter password within 30 seconds or press the disarm button on the keychain remote.

Arm LED off

System Disarmed

3. Once the system is disarmed, the Arm LED will be off.

1. During the entry delay, the system will beep for 30 seconds, the ARM LED will flash during this entry delay interval. The faster the beep, the less time you have left to disarm the control panel before the siren sounds.

OPERATION

- You must enter a valid password, either the Master Password, or Secondary Password to disarm the system before entry delay expires.
- When a valid password is entered, you will hear "System Disarmed" and the entry delay beeping will stop, the ARM LED will be off.

Note:

- The control panel can also be disarmed remotely when nobody is home, with a touch tone phone. Please refer to "Remote Operation by Telephone" on page 27.
- If 3 consecutive incorrect passwords are entered, alarm will sound immediately, the control panel will be in panic mode, and start calling the emergency phone numbers.

Disarming a triggered control panel

If "System Panic" is announced from the control panel after it has been disarmed, that means the alarm was triggered when it was in armed mode. Follow the procedures below to set the control panel back to standby mode.

- If the alarm was caused by sensor(s), there will be flashing LEDs and beeping indicating which sensor(s) triggered the alarm. You may want to check the condition of the triggered sensor(s), the sensor(s) may be damaged if there were break-ins.
- You need to reset the sensor manually by triggering it twice, i.e. open and then close a door / window sensor, or walk in front of the motion sensor. The LED representing that sensor will stop flashing after it receives the signal from the sensor.
- You must now enter the password again on the control panel or press the disarm button on the keychain remote, as an acknowledgement of the alarm event. This will set the control panel back to standby mode.

Disarming under Duress

If you are forcibly compelled to disarm the control panel, you may enter the Duress Password. Entering the duress password will terminate the entry delay, i.e. no more entry delay beeping. But the control panel will silently call the emergency phone numbers for help. The called party will hear the voice announcement "System Panic".

Note:

- The default duress password is [3838].





ADVANCED PROGRAMMING

Learn Keychain / Keypad Remotes

Additional keychain or keypad remotes can be programmed to the control panel. Maximum of 5 keychain/keypad remotes can be programmed to the control panel.

- Keychain or keypad remotes should be programmed to Device 6 to Device 0.

Follow the instructions below to program remote(s) to remote location(s) 6, 7, 8, 9, or 0, which is the bottom row of the numeric keypad of the control panel.

| Step | Keys | Function | Description | Note |
|------|---|---|--|---|
| 1 |  [PROG] [MPIN] | Enter Program- ing mode | Enter master password to programming mode | 3 beeps for valid password. 1 long beep for invalid password. |
| 2 |  [4] | Select learn remote programming | | After [4] is entered, some zone LEDs will flash or stay off. The zone LEDs represent whether that zone is already occupied by another remote. ** See Table A below. |
| 3 |  [6] to [0] | Select remote location (Max. 5 remotes) | Select a remote location [6], [7], [8], [9] or [0]. | After you have selected the remote location, that zone LED will be on. |
| 4 |  Activate the remote by pressing any one of the buttons. | Trigger remote | Once the signal is transmitted to the Control Panel, that signal which will be stored. | You will hear [Device X Accepted], where "X" is the remote location. |

| ZONE LED | DESCRIPTION |
|-----------------------------|--|
| Off | Zone is not occupied by any remote |
| Flashes twice | This zone is occupied by another remote. Programming another remote to this zone will overwrite the previous remote. |
| Flashes once | This zone is occupied by a control module* (Optional). You can still program a remote to this zone, and it will not overwrite the control module* you have in this zone. (Refer to page 40 Home Automation for more information) |
| Flashes once, then twice | This zone is occupied by a remote AND a control module*. If you program another remote to this zone, it will overwrite the previous remote, but not the control module*. |

** Table A: Zone LED status for learning keychain/keypad remote(s).

* Please refer to learn control module on page 40.

ADVANCED PROGRAMMING

To enable alert zone feature, follow the instructions below.

| Step | Keys | Function | Description | Note |
|------|--|---|---|---|
| 1 | [PROG] [MPIN] | Enter Program- ming mode | Enter master password to programming mode | 3 beeps for valid password. 1 long beep for invalid password. |
| 2 | [8] | Select Alert Zone. | | After [8] is entered, some zone LEDs will flash or stay on. This indicates whether alert zone is selected. |
| 3 | Disable Alert Zone: [1] to [5] Enable Alert Zone: [6] to [0]. | Select which zone you would like to select as Alert Zone. | Refer to the diagram below to select the appropriate setting. | If alert zone is selected, that zone LED will be on. If it is not selected, the LED will flash. You are allow to make multiple changes before terminat- ing programming mode. |
| 4 | [PROG] when finished. | Terminate programming mode. | | PROG LED will be off. |

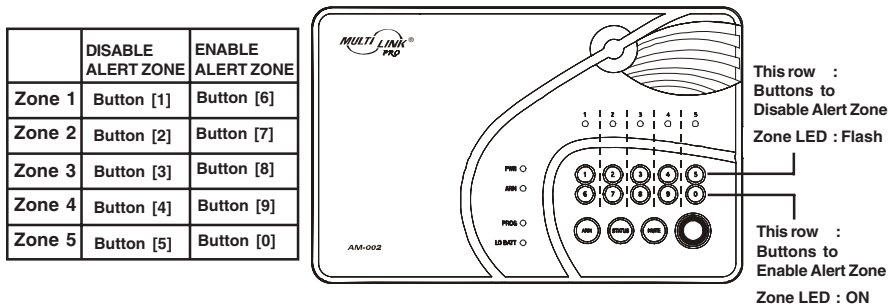

OPERATION

Panic

Pressing the panic button on the control panel or keychain remote will cause the siren to sound and outgoing calls will be made to the preprogrammed phone numbers, "System Panic" will also be announced. This can be used in any emergency situation.

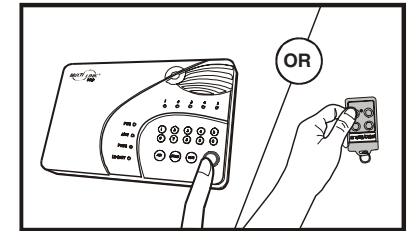

To stop the siren and disarm the system, user can enter a valid password, or press the disarm button on the keychain remote. This will terminate the siren and the control panel from calling the rest of the emergency phone numbers.

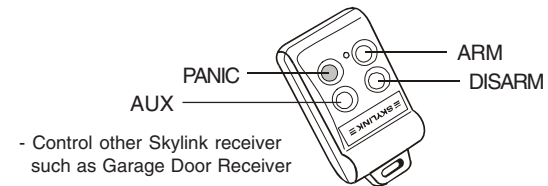

System Failure

Control Panel constantly monitors itself and its sensors. If there are any trouble conditions, the control panel will advise the user. These trouble conditions include:

- Phone Line Failure
- Sensor Failure (loss of supervisory signal)
- Low Battery – Control Panel
- Low Battery – Sensors

Phone Line Failure

When the phone line is disconnected or malfunctions, the control panel will instantly notify the user by:

1. Both Power [PWR] and Program [PROG] LEDs will flash together;
2. Voice announcement "Phone Line Failure" will be played.

When phone line failure occurs, please check the phone line connection, ensure the phone line is plugged into both the control panel and the wall socket securely. You should also check the phone line with a normal telephone to determine if it can dial out to a phone number. If it cannot dial out, that indicates the phone line is not in service, you should contact your local phone company.

OPERATION

Sensor Failure

The control panel constantly monitors its sensors, if the control panel fails to communicate with any sensors, it will notify the user by:

1. The zone LED of the failed sensor will be on steadily;
2. Voice announcement "zone X sensor Y failure" will be played.

When sensor failure occurs, try the following:

1. Check if the sensor is located at where it should be, and whether there is any physical damage to the sensor.
2. If the failed sensor is not physically damaged, try to activate the sensor and see if the control panel reacts to such activation.
3. If not, try to remove the sensor from its location, and bring it closer to control panel and activate the sensor. It is possible that the sensor is installed too far from the control panel and it cannot establish a steady communication with the control panel. If this is the case, please install the sensor closer to the control panel.

Low Battery

Control Panel

The control panel is powered mainly by the adapter. However, during power outage, it will be powered by the rechargeable backup battery. Under standby conditions, these batteries can last for 48 hours.

When the backup battery is running low, the "LO BATT" LED on the control panel will be on, indicating the backup battery should be recharged. To recharge the backup battery, plug in the power adapter. It takes approx. 20 hours to fully charge the backup battery.

Sensors (For ML-100A Only)

All of the sensors are battery powered. Depending on the operating condition and environment, the battery life varies from 9 months to 2 years. 9V alkaline battery is used for the motion sensor, the battery life is approximately 9 months. Door / Window Sensor operates on a Lithium CR-2032 battery, with battery life of approximately 2 years. For other sensors, please refer to the user's instructions regarding the battery life.

ADVANCED PROGRAMMING

| | DISABLE AUTO MUTE | ENABLE AUTO MUTE |
|--------|-------------------|------------------|
| Zone 1 | Button [1] | Button [6] |
| Zone 2 | Button [2] | Button [7] |
| Zone 3 | Button [3] | Button [8] |
| Zone 4 | Button [4] | Button [9] |
| Zone 5 | Button [5] | Button [0] |

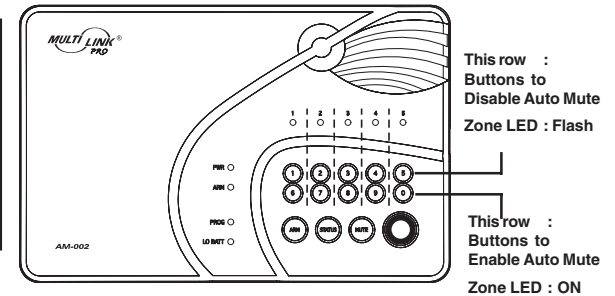

Alert Zone (Bypass Zone)

As explained earlier, the control panel can operate in 2 different modes, 1) Alert Mode, 2) Alarm Mode. In alarm mode, when a sensor is triggered, the control panel will either give a 30 seconds entry delay, or siren will sound immediately (with instant alarm). However, there are sensors that you do not want to trigger the alarm when the system is armed. Such as an outdoor sensor, or any other sensors that you only want to give you alert notification. Under such circumstances, zone(s) can be programmed to react only when the control panel is in alert mode, these zones will be automatically bypassed when the control panel is in alarm mode. These zones can also be considered as "Bypass zones".

It is recommend to enable alert zone if:

- You do not consider the sensors in that zone an emergency
- Sensors in that zone are located outdoors
- When nobody is at home, you do not want to know the status of the sensor(s) in that zone

Factory Default: This feature was disabled for all zones at the factory.

ADVANCED PROGRAMMING





Auto Mute

When a sensor is triggered in alert mode, audio warning will be emitted, either beep or alarm. For example, if a door is opened, the beep will not stop until the door is closed. If the door is open for 2 hours, the beep will go on for 2 hours. There are times that this is not desired. With the auto mute feature enabled, the beep will go on for only 20 seconds. After that, even if the sensor remains open, the beep will stop only the zone LED will flash to indicate the sensor is triggered. Beep will go on again if the sensor is closed and opened again.

Note: Auto Mute only functions when the control panel is in alert mode (disarmed). If the control panel is in alarm mode (armed), a triggered sensor will result in entry delay or instant alarm.

Factory Default: This feature was disabled for all zones at the factory.

To enable auto mute feature, follow the instructions below.

| Step | Keys | Function | Description | Note |
|------|--|--|---|---|
| 1 |  [PROG] [MPIN] | Enter Program- ming mode | Enter master password to programming mode | 3 beeps for valid password. 1 long beep for invalid password. |
| 2 |  [6] | Select Auto Mute Enable / Disable | | After [6] is entered, some zone LEDs will flash or stay on. This indicates whether Auto Mute is enabled or disabled. |
| 3 |  Disable Auto Mute: [1] to [5]  Enable Auto Mute: [6] to [0]. | Select which zone you would like to enable / disable auto mute. | Refer to the diagram below to select the appropriate setting. | If auto mute is enabled, that zone LED will be on. If it is disabled, the LED will flash. You are allow to make multiple changes before terminating programming mode. |
| 4 |  [PROG] when finished. | Terminate programming mode. | | PROG LED will be off, and you will hear 3 beeps. |

OPERATION

When the sensor is running low in battery, the sensor will send a wireless low battery signal to the control panel. The zone LED representing that sensor will be on steadily, indicating sensor(s) in that zone is in trouble condition. Control Panel will also have an announcement to advise the user the trouble condition is low battery, such as “zone X sensor Y low battery”, where X and Y represent the zone and sensor number. Please replace the battery of that sensor.

Keychain Remote (For ML-100A Only)

The battery of the keychain remote (Alkaline, Type 23A, 12V) needs to be replaced when either one of the followings occurs:

1. The LED on the keychain doesn't flash or on when a key is pressed; or
2. The operating range starts to decrease.

To replace the battery:

1. Undo the two screws on the back of the transmitter. The bottom case will then come off.
2. Using a small screwdriver or pen, pry out the old battery from one end.
3. Place the new battery in position. A diagram in the battery compartment indicates which end is positive and which is negative.
4. Close the battery cover and reinsert two screws.

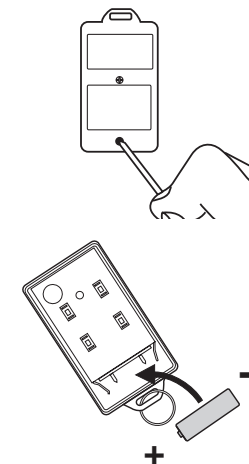

COMMUNICATION

Receiving the Emergency Call

If you are on the list as one of the recipients of the emergency call, you should read the following instructions carefully. You should also notify all the persons you will be calling so they know how to react when they receive the emergency call.

The control panel will call you when there are emergencies such as break-ins, smoke, fire events, or someone at home needs assistance.

1. When the phone rings at the calling location, the person who answers the phone will hear a message related to the emergency events, such as "System Panic", or "Zone 1 Sensor 1 Triggered" etc. This message may be repeated several times depending on how it was programmed.

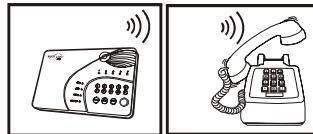

2. After the message has been repeated for a certain number of times, the control panel will ask for a valid password, you will hear "Enter Password".

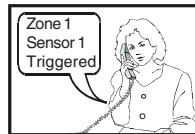

3. Enter the 4-digit password to have access to the control panel. If a valid password is accepted, you will hear "Password Accepted", otherwise, you will hear "Password Failure".



4. After entering the correct password, you can follow the "Phone Command" instructions to perform the required tasks, such as disarm, turn on / off devices or check the system status etc. For further information of how to control the system remotely, please refer to the next section, "Remote Operation by Telephone".

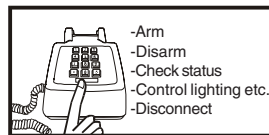

ADVANCED PROGRAMMING

Follow the procedures below to program the beep / alarm setting.

| Step | Keys | Function | Description | Note |
|------|--|--|---|--|
| 1 | [PROG] [MPIN] | Enter Programming mode | Enter master password to programming mode | 3 beeps for valid password. 1 long beep for invalid password. |
| 2 | [5] | Select Beep / Alarm Setting | | After [5] is entered, some zone LEDs will flash or stay on. This indicates whether that zone is set to beep or alarm. |
| 3 | Set to Beep: [1] to [5] Set to Alarm: [6] to [0]. | Select which zone you would like to Beep or Alarm. | Refer to the diagram below to select the appropriate setting. | If Alarm is set for that zone, that zone LED will be on. If Beep is set, the LED will flash. You are allowed to make multiple changes before terminating programming mode. |
| 4 | [PROG] when finished. | Terminate programming mode. | | PROG LED will be off, and you will hear 3 beeps. |

| | BEEP | ALARM |
|--------|------------|------------|
| Zone 1 | Button [1] | Button [6] |
| Zone 2 | Button [2] | Button [7] |
| Zone 3 | Button [3] | Button [8] |
| Zone 4 | Button [4] | Button [9] |
| Zone 5 | Button [5] | Button [0] |

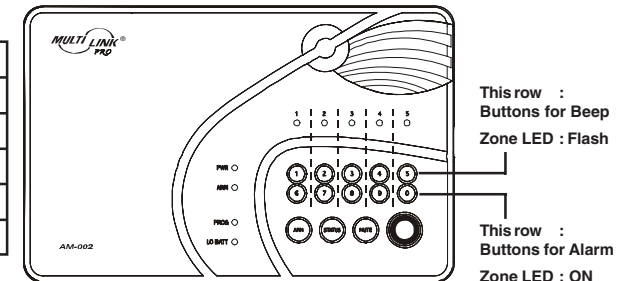

Example:

If you would like to change the setting for zone 5 from "Beep" to "Alarm", simply press [0] at step 3. This will change the zone 5 setting to "Alarm".

ADVANCED PROGRAMMING

System Armed (Alarm Mode)

If a zone is set to "Beep", the control panel will give entry / exit delay.

If a zone is set to "Alarm", the siren will sound immediately without entry delay

- Alarm Mode (System Armed): If a sensor is triggered (i.e. opening a door) with the alarm setting on, the siren will sound immediately without entry delay, it is called "Instant Alarm". The siren will not stop until the siren timeout or a valid password is entered. Control panel will call the emergency phone numbers to notify the users of the alarm situation.

When a sensor is triggered, there are 4 options:

| | ZONE SETTING | |
|------------------|-----------------------|---|
| OPERATING MODE | BEEP | ALARM |
| Disarmed (Alert) | 1) Beep | 2) Alarm sounds immediately |
| Armed (Alarm) | 3) Entry / Exit Delay | 4) Alarm sounds and calls preprogrammed phone numbers immediately |

Factory Default: All zones were programmed to Beep at the factory.

You may consider to programming the zone(s) into Alarm mode if:

- You need immediate attention if that sensor is triggered, such as flood sensor, smoke sensor etc.
- The sensor will not be triggered on a daily basis, such as a door that you normally will not open, and if it opens, you would like to know immediately.

Caution:

It is not recommended to program an outdoor sensor to Alarm mode, which may cause false alarm. For outdoor sensors, they should be programmed into an Alert Zone, please refer to page 33 for details.

COMMUNICATION

Remote Operation by Telephone

The control panel can be operated while you are away from home. You can have access to the control panel with any touch tone phone to perform a variety of operations, listed below.

- Arm
- Disarm
- Lights, Home Appliances on / off (Requires additional Control Module)
- Garage door open / close (Requires additional Garage Door Receiver)
- System status
- Disconnect

There are 2 ways you can have access to the remote phone operation:

1. You can call the control panel when you are away from home; or
2. When the control panel calls you during emergency.

To access the control panel away from home

Calling in when you are away from home

1. Call your home phone number, or the number that the phone line of the control panel is connected to.
2. Hang up after the second ring.
3. Wait at least 10 seconds, but not more than 40 seconds, then call the phone number again.
4. The control panel will pick up the phone call and request for a valid user password, you will hear "Enter Password". You can enter either the Master Password or Secondary Password. If the password is correct, you will hear "Password Accepted", otherwise, you will hear "Password Failure".
5. Once the password is accepted, you can have access to all the operations listed below.

COMMUNICATION

Table 1: Remote Phone Operations

| SYSTEM OPERATION | PHONE COMMAND | DESCRIPTION |
|-----------------------------------|---------------|---|
| Turn on device x [x] = 1 to 5 | X+[*] | Turn devices on will hear [Device X On] . When the control module receives the on signal, it will turn on the plugged in device, and send a confirmation back to the control panel. You will then hear [Device On Accepted] . |
| Turn off device x x = [1 to 5] | X+[#] | Turn devices off will hear [Device X Off] . When the control module receives the off signal, it will turn off the plugged in device, and send a confirmation back to the control panel. You will then hear [Device Off Accepted] . |
| Check system status | [8]+[#] | You will hear system status announcement |
| Arm | [7]+[#] | You will hear [System Armed] |
| Disarm | [9]+[#] | You will hear [System Disarmed] |
| Disconnect | [0]+[#] | Phone line disconnect |

ADVANCED PROGRAMMING

Advanced Programming allows users to customize the control panel to react differently under different conditions. Features such as:

- When a sensor is triggered, the control panel can beep or alarm
- Beeping can be terminated automatically after a fixed period of time for some sensors
- Some sensors can be programmed to beep only, never alarm
- When a door is open, turn lights on
- Program additional sensors and remotes

Programming Summary

| COMMAND | DESCRIPTION |
|--------------|---|
| [PROG] + [1] | Program Phone Numbers |
| [PROG] + [2] | Program Password |
| [PROG] + [3] | Learn Sensors |
| [PROG] + [4] | Learn Keychain or Keypad Transmitters / Control Modules |
| [PROG] + [5] | Beep / Alarm Setting |
| [PROG] + [6] | Auto Mute Setting |
| [PROG] + [7] | Event Trigger Setting |
| [PROG] + [8] | Alert Zone (Bypass) Setting |
| [PROG] + [9] | Erase Sensors |
| [PROG] + [0] | Erase Keychain or Keypad Transmitters / Control Modules |

Follow the instructions below to have access to Advanced Programming.

Beep / Alarm

User can customize the audio warning so that when a sensor is triggered, the control panel may beep or alarm may sound instantly. Depending on whether the control panel is armed or disarmed, the audio warning is different.

System Disarmed (Alert Mode)

If a zone is set to "Beep", the control panel will beep when a sensor is triggered, until the sensor is deactivated. Motion Sensor activation will not cause any beeping unless the zone for the motion sensor is programmed as a "Bypass Zone" (see page 33).

If a zone is set to "Alarm", alarm will sound instantly when a sensor is triggered. Alarm will stop when the sensor is deactivated, or reaches a 3-minute time out period.

Free Manuals Download Website

<http://myh66.com>

<http://usermanuals.us>

<http://www.somanuals.com>

<http://www.4manuals.cc>

<http://www.manual-lib.com>

<http://www.404manual.com>

<http://www.luxmanual.com>

<http://aubethermostatmanual.com>

Golf course search by state

<http://golfingnear.com>

Email search by domain

<http://emailbydomain.com>

Auto manuals search

<http://auto.somanuals.com>

TV manuals search

<http://tv.somanuals.com>