

MultiModem[®] EDGE USB Wireless Modem

MTCBA-E-U

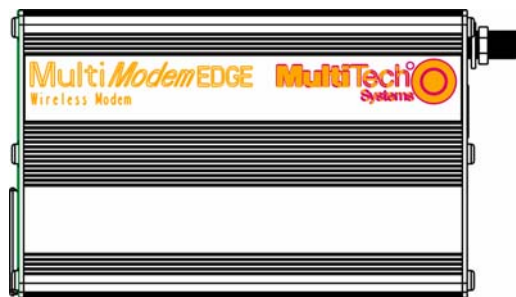

User Guide



MultiModem® EDGE USB
External Wireless Modem User Guide
Model MTCBA-E-U
S000382F, Revision F

Copyright

This publication may not be reproduced, in whole or in part, without prior expressed written permission from Multi-Tech Systems, Inc. All rights reserved.

Copyright © 2007 by Multi-Tech Systems, Inc.

Multi-Tech Systems, Inc. makes no representation or warranties with respect to the contents hereof and specifically disclaims any implied warranties of merchantability or fitness for any particular purpose. Furthermore, Multi-Tech Systems, Inc. reserves the right to revise this publication and to make changes from time to time in the content hereof without obligation of Multi-Tech Systems, Inc., to notify any person or organization of such revisions or changes.

Check Multi-Tech's Web site for current versions of our product documentation.

Revision History

Revision	Date	Description
A	08/11/05	Initial Release
B	10/12/05	Changed temperature range, added humidity rating, changed modem maintenance, and warranty chapter.
C	05/04/06	Updated USB Plug & Play software installation
D	06/14/06	Added AT command examples.
	06/16/06	Changed the operating temperature. Added storage temperature. Changed text for the LS LED. Changed circuit-switched data rate to 14.4K bps.
	06/22/06	Changed the location of the Activation Notices. Added note about current documentation on Web site.
E	09/05/06	Removed caution about not connecting USB cable to pc.
F	01/19/07	Add caution to splash screen.

Trademarks and Logos

Multi-Tech and the Multi-Tech logo are trademarks of Multi-Tech Systems, Inc. MultiModem is a registered trademark of Multi-Tech Systems, Inc. Windows is a registered trademark of Microsoft in the U.S. and other countries. Other trademarks and trade names mentioned in this publication belong to their respective owners.

World Headquarters

Multi-Tech Systems, Inc.
 2205 Woodale Drive
 Mounds View, Minnesota 55112
 (763) 785-3500 or (800) 328-9717
 Fax: (763) 785-9874
 Internet Address: <http://www.multitech.com>

Technical Support

Country	By Email	By Phone
France:	support@multitech.fr	+(33) 1-64 61 09 81
India:	support@multitechindia.com	+91 (124) 2340780
Europe, Asia, Africa:	support@multitech.co.uk	+(44) 118 959 7774
U.S., Canada, all others:	support@multitech.com	(800) 972-2439 or +(763) 717-5863

Contents

Chapter 1 – Product Description and Specifications	4
Product Description.....	4
Features.....	4
Application Overview.....	5
Application Types.....	5
Benefits/Features in Applications.....	5
Safety.....	6
General Safety.....	6
RF Interference Issues.....	6
Vehicle Safety.....	6
Maintenance of Your Modem.....	6
Your Responsibility.....	6
Package Contents.....	7
Specifications.....	8
Antenna/RF Specifications.....	8
Interfaces.....	9
LEDs.....	9
AT Command Reference Guides.....	9
Chapter 2 – Activation and Installation	10
Step 1 – Activate Your Wireless Account.....	10
Step 2 – Insert the SIM Card into the Holder.....	10
Step 3 – Connect the Antenna and USB Cable.....	11
Step 4 – Handset Connection (Optional).....	11
Step 5 – Attach the Modem to a Flat Surface (Optional).....	12
Step 6 – Install the Modem Driver.....	13
Introduction.....	13
Installing the Modem Driver in Windows XP/2003.....	13
Installing the Modem Driver in Windows 2000.....	17
Chapter 3 – Using Your Wireless Modem	21
Phone Number for the Wireless Modem.....	21
Examples of Useful AT Commands.....	21
Verify Signal Strength.....	21
Checking Network Registration and Roaming Status.....	21
Checking the Modem’s Identity.....	21
Establishing a Voice Call.....	22
Establishing a Circuit-Switched Data Call for a Point-to-Point Connection.....	22
Answering a Circuit-Switched Data (CSD) Connection.....	22
Using Short Message Service (SMS).....	23
Short Messages Examples.....	24
Internet Access.....	25
Connecting to the GPRS/EDGE Network for Internet Access.....	25
Mobile PhoneTools.....	27
Chapter 4 – Troubleshooting and Frequently Asked Questions	28
Troubleshooting Examples.....	28
Frequently Asked Questions.....	29
Chapter 5 – Reference Information	30
Wireless Modem Reference Information.....	30
Appendix A – Warranty and Repairs	31
Appendix B - Waste Electrical and Electronic Equipment (WEEE) Statement	33

Chapter 1 – Product Description and Specifications

Product Description

The Multi-Tech MultiModem® EDGE wireless modem delivers some of the fastest cellular wireless data speeds by utilizing EDGE technology with an USB interface. It allows users to connect to the Internet and send and receive data up to three times faster than possible with an ordinary GSM/GPRS network making it ideal for highly data-intensive multimedia applications. Based on industry-standard open interfaces, the MultiModem EDGE wireless modem is equipped with quad-band GSM, which means it can be used worldwide on all existing GSM networks. It also supports mobile originated short message service (SMS) and mobile-terminated SMS. This ready-to-deploy, standalone modem allows developers to add wireless communication to products with a minimum of development time and expense.

A Note About Documentation: Multi-Tech Systems, Inc. reserves the right to revise this publication and to make changes from time to time in the content hereof without obligation of Multi-Tech Systems, Inc., to notify any person or organization of such revisions or changes. Check Multi-Tech's Web site for current versions of our product documentation.

Features

• EDGE (GPRS) Class 10 operation
• Quad-band 850/1900 or 900/1800 GSM/GPRS
• Packet data rates for EGPRS up to 240K bps, coding scheme MCS 1-9, mobile station class B, LLC layer, 4 time slots
• Packet data rates for GRPS are full PBCCH support, coding scheme 1-4, mobile station class B
• Desktop or panel mounting
• Short Message Services (SMS) text and PDU, point-to-point MO & MT, cell broadcast
• Circuit-switched data up to 14.4K bps; non-transparent, asynchronous
• 50 ohm SMA female antenna connector
• Standard 3V SIM receptacle
• AT command compatible
• Class 1 Group 3 Fax
• Numerous LEDs provide operational status
• ME + SIM phone book management
• Fixed dialing number
• SIM Toolkit Class 2
• SIM, network and service provider locks
• Real time clock
• Alarm management
• UCS2 character set management
• Voice features include Half rate (HR), Full rate (FR), Enhanced full rate (EFR), and Adaptive multi rate (AMR) as well as hands-free echo cancellation and noise reduction.
• Two year warranty
• Certification: CE Mark, R&TTE, EMC: FCC Part 2, 15 Class A, 22, 24; EN 55022, EN 55024 Safety: cUL, UL 60950; EN 60950 Network: PTCRB

Application Overview

Application Types

With circuit switched data rates up to 14.4K bps, the MultiModem® GPRS is targeted at applications that periodically need to send or receive data over a wireless network. It is an ideal solution for:

Appliances
ATM Terminals
Automotive
Data Collection
Gas Pumps
Industrial and Medical Remote Monitoring Systems
Remote Diagnostics
Remote Metering
Security Systems
Vending/Gaming Machines
Other devices requiring wireless connectivity.
Note: The Wireless MultiModem must be mounted with at least 8 inches (20 cm) of clearance from the human body.

Benefits/Features in Applications

Short Development Time. The MultiModem® EDGE can make your existing and next generation device, machine, or system, communication-ready without requiring any hardware changes to its design. It actually provides faster time-to-market because it relieves the burden and expense of obtaining network and RF approvals. This complete, ready-to-deploy wireless modem allows you to enhance your product while you focus on developing its core features.

Voice Features. The MultiModem® EDGE provides telephony and Dual Tone Multi Frequency (DTMF) functionality. It also allows for emergency calls as well as echo cancellation and noise reduction (option), and full rate, enhanced Full Rate and Half Rate (FR/EFR/HR).

Short Message Services. The MultiModem® EDGE offers SMS features such as text and PDU, point-to-point (MT/MO) and cell broadcast.

Compatible Supplementary Services. The MultiModem® EDGE is compatible with supplementary services such as call forwarding, call barring, multiparty, call waiting and call hold, calling line identification, advice of charge, USSD, closed user group and explicit call transfer.

Management Features. The MultiModem® EDGE provides advanced management features including phone book management, fixed dialing number, and real time clock and alarm management.

Industry-standard Modem Commands. The MultiModem® EDGE provides industry-standard AT-style commands for ease of integration into your existing software application.

Industrial Chassis. The MultiModem® EDGE is packaged in a rugged, water resistant, industrial chassis. The chassis has a USB connector for power and data. It has an SMA antenna connector. It also has modular phone handset receptacle. The chassis can be side-mounted on a panel or top-mounted on a desktop or other surface. A set of LEDs indicates the modem's operational status.

Packet-Switched Data. The MultiModem® EDGE supports EDGE Class 10 packet-switched cellular data. This enables mobile Internet functionality by allowing interworking between the existing Internet and the cellular network at speeds up to 240K bps. Any service that is used over the fixed Internet today – File Transfer Protocol (FTP), web browsing, chat, e-mail, telnet -- is available over the cellular network, as well. The MultiModem EDGE supports PBCCH and coding schemes CS1 to CS4, and is compliant with SMG31bis.

Circuit-Switched Data (CSD). The MultiModem® EDGE also supports GSM circuit-switched cellular data connections. Circuit-switched data connections support speeds up to 14.4K bps, Class 1 and Class 2 Group 3 fax, as well as MNP2 V.42bis compression. CSD cellular wireless connections are ideal for applications that require a quick wireless replacement of an existing point-to-point analog dial-up connection. They integrate seamlessly with your current application requiring little infrastructure change.

Internet-Enabled. The MultiModem® EDGE includes an embedded TCP/IP protocol stack to bring Internet connectivity to any device. Using the embedded Internet protocols and the wireless connection to an IP network, it sends and receives data over the Internet. It can also serve a single web page in response to a web browser request.

Safety

General Safety

The modem is designed for and intended to be used in fixed and mobile applications. “Fixed” means that the device is physically secured at one location and is not able to be easily moved to another location. “Mobile” means that the device is designed to be used in other than fixed locations.

Caution: Maintain a separation distance of at least 20 cm (8 inches) is normally maintained between the transmitter’s antenna and the body of the user or nearby persons. The Modem is not designed for or intended to be used in portable applications within 20 cm. (8 inches) of the body of the user.

RF Interference Issues

It is important to follow any special regulations regarding the use of radio equipment due in particular to the possibility of radio frequency, RF, interference. Please follow the safety advice given below carefully.

- Switch OFF your Wireless MultiModem when in an aircraft. The use of cellular telephones in an aircraft may endanger the operation of the aircraft, disrupt the cellular network and is illegal. Failure to observe this instruction may lead to suspension or denial of cellular telephone services to the offender, or legal action or both.
- Switch OFF your Wireless MultiModem when around gasoline or diesel-fuel pumps and before filling your vehicle with fuel.
- Switch OFF your Wireless MultiModem in hospitals and any other place where medical equipment may be in use.
- Respect restrictions on the use of radio equipment in fuel depots, chemical plants or where blasting operations are in progress.
- There may be a hazard associated with the operation of your Wireless MultiModem close to inadequately protected personal medical devices such as hearing aids and pacemakers. Consult the manufacturers of the medical device to determine if it is adequately protected.
- Operation of your Wireless MultiModem close to other electronic equipment may also cause interference if the equipment is inadequately protected. Observe any warning signs and manufacturers’ recommendations.

Vehicle Safety

- Do not use your MultiModem while driving.
- Respect national regulations on the use of cellular telephones in vehicles. Road safety always comes first.
- If incorrectly installed in a vehicle, the operation of Wireless MultiModem telephone could interfere with the correct functioning of vehicle electronics. To avoid such problems, be sure that qualified personnel have performed the installation. Verification of the protection of vehicle electronics should be part of the installation.
- The use of an alert device to operate a vehicle’s lights or horn on public roads is not permitted.

Maintenance of Your Modem

Your Wireless MultiModem is the product of advanced engineering, design and craftsmanship and should be treated with care. The suggestions below will help you to enjoy this product for many years.

- Do not expose the Wireless MultiModem to any extreme environment where the temperature is above 50°C or humidity is above 90% noncondensing.
- Do not attempt to disassemble the Wireless MultiModem. There are no user serviceable parts inside.
- Do not expose the Wireless MultiModem to water, rain, or spilled beverages. It is not waterproof.
- Do not place the Wireless MultiModem alongside computer discs, credit or travel cards, or other magnetic media. The phone may affect the information contained on discs or cards.
- The use of accessories not authorized by Multi-Tech or not compliant with Multi-Tech’s accessory specifications may invalidate the warranty of the Wireless MultiModem.
- In the unlikely event of a fault in the Wireless MultiModem, contact Multi-Tech Tech Support.

Your Responsibility

This Wireless MultiModem is your responsibility. Please treat it with care respecting all local regulations. It is not a toy. Therefore, keep it in a safe place at all times and out of the reach of children.

Try to remember your Unlock and PIN codes. Become familiar with and use the security features to block unauthorized use and theft.

Package Contents

Single Package (one unit)	Bundled Package (multiple units)
1 modem 1 mounting bracket 1 Quick Start Guide 1 MultiModem CD Note: You must supply: Screws for the bracket An antenna	<i>Each individual package in the bundle includes the following:</i> 1 modem 1 mounting bracket 1 USB cable 2 antennas 4 rubber feet 1 Quick Start Guide 1 MultiModem CD Note: You must supply screws for the bracket.

Parts to be Supplied by Your Wireless Service Provider

Subscriber Identity Module (SIM) configuration chip.

The SIM contains information specific to your wireless account and its features.

Specifications

General Specifications	
Mechanical Dimensions & Weight	4.3" L x 2.4" W x 0.94" H; 4.2 oz. (11 cm x 6.1 cm x 2.4 cm; 119 g)
Connectors & Fasteners	Antenna Connection type: SMA jack Interface Connector: USB Type B Phone Handset: Modular Handset Jack SIM receptacle: Standard 3V SIM receptacle
Operating Temperatures	-30° to +65°C
Storage Temperatures	-40° to +85°C
Humidity	Humidity relative 20% to 90% noncondensing
Certifications	CE Mark EMC: FCC Part 2, 15, 22, 24, EN 55022 & EN 55024 Safety: UL 60950, EN 60950

Electrical Characteristics	
Switching the GSM modem on/off	The device is permanently powered when connected to the USB port.
Voltage	Voltage: 5 V DC GND : 0V

Current Requirements			
Parameters	GSM/GPRS 850/900	GSM/GPRS 1800/1900	Unit
	Typ.	Typ.	
Input average supply current in comm. mode at P_{max}	360	300	mA
Input average supply current in idle mode	30	30	mA

Antenna/RF Specifications

	GSM 850	EGSM 900
Frequency RX	869 to 894 MHz	925 to 960 MHz
Frequency TX	824 to 849 MHz	880 to 915 MHz
RF Power Stand	2W at 12.5% duty cycle	2W at 12.5% duty cycle
Impedance	50 ohms	
VSWR	<2	
Typical Radiated Gain	0 dBi on azimuth plane	

	GSM 1800	GSM 1900
Frequency RX	1805 to 1880 MHz	1930 to 1990 MHz
Frequency TX	1710 to 1785 MHz	1850 to 1910 MHz
RF Power Stand	1W at 12.5% duty cycle	1W at 12.5% duty cycle
Impedance	50 ohms	
VSWR	<2	
Typical Radiated Gain	0 dBi on azimuth plane	

Interfaces

The Wireless MultiModem has several interfaces:

- LED function indicating operating status
- External antenna (via SMA connector)
- Serial and control link (via USB connector)
- Microphone and speaker (via handset jack)
- SIM card holder

LEDs

TD. Transmit Data.	Lit when modem is transmitting data.
RD. Receive Data.	Lit when modem is receiving data.
CD. Carrier Detect.	Lit when data connection has been established.
LS. Line Status.	Continuous "on" state indicates that the wireless modem is not registered on the network. Flashing state indicates registration on network. Off state indicates the modem is off (not ready) or in download mode.
TR. Terminal Ready.	Commonly called "Data Terminal Ready." This is a readiness signal from the PC.
PWR. Power.	Indicates presence of DC power when lit.

AT Command Reference Guides

AT commands for the EDGE wireless modem are published in a separate Reference Guide included on the MultiModem CD and posted on the Multi-Tech web site.

Chapter 2 – Activation and Installation

Step 1 – Activate Your Wireless Account

Multi-Tech – A Certified National Activation Agent

Multi-Tech Systems, Inc. is a certified national activation agent for Cingular and Sprint wireless. For more information about available data plans and to purchase and activate a wireless data account, contact Multi-Tech at 888-288-5470.

Pre-Configuration and Activation

Pre-Configured Multi-Tech Products

Each Multi-Tech wireless product has been pre-configured to operate on a wireless network.

Activate Your Wireless Account

Please see the wireless account Activation Notices located on the MultiModem CD. Choose the one for your wireless network provider and follow the directions to activate your account.

Phone Numbers for the Wireless Modem

Every wireless modem will have its own unique phone number. The phone number may simply be given to you by your wireless service provider or it may be on the SIM card or both. Wireless provider implementations may vary.

Step 2 – Insert the SIM Card into the Holder

The wireless MultiModem requires a SIM card (Subscriber Identity Module) to operate on a GSM network. To install the card, do the following:

1. Using your fingernail or a small wedging tool (e.g., a small screwdriver), pry off the SIM cover.

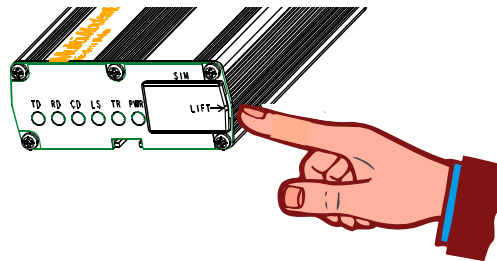

2. Insert the SIM card into the holder.

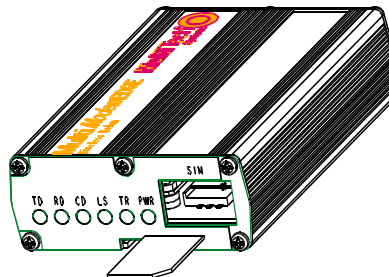

3. Verify that the SIM card fits into the holder properly and then replace the cover.

Step 3 – Connect the Antenna and USB Cable

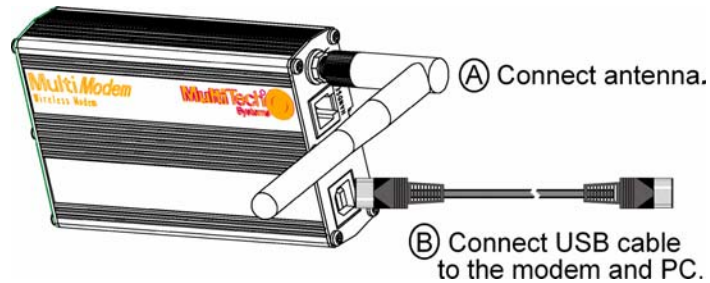

- **Antenna.** Connect a suitable antenna to the SMA connector (see antenna specifications in Chapter 1).
- **USB Cable.** Connect one end of the USB cable to the modem and the other end to the PC.

Step 4 – Handset Connection (Optional)

If you intend to use a phone handset, connect it to the MultiModem now.

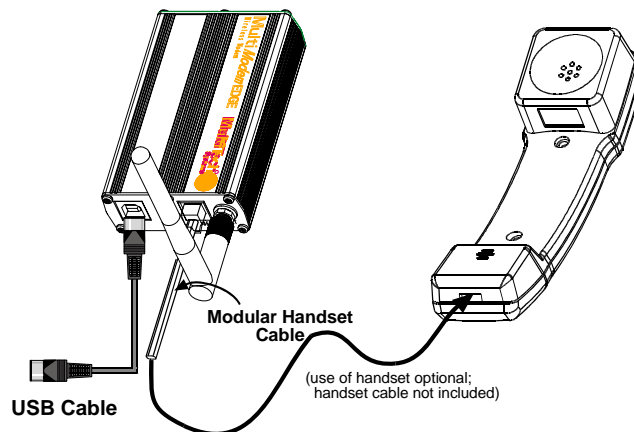

Step 5 – Attach the Modem to a Flat Surface (Optional)

To mount the Wireless MultiModem, do the following:

1. Obtain mounting screws (two are needed) that are appropriate for the surface on which you will mount the MultiModem. For example, one might use two 6-32 self-tapping screws 5/8" in length to mount the unit in a truck to the wall of the cab behind the passenger's seat.
2. Typically, the unit is mounted against a flat surface into which holes can be drilled. The mounting holes (center-to-center) must be separated by 125mm or 4 -15/16 inches.

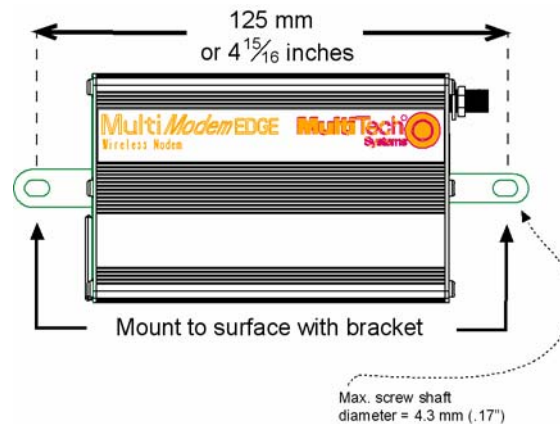

Drill the mounting holes at the desired mounting location (if applicable).

3. Slide the mounting brackets into the corresponding slots on the backside of the MultiModem chassis.

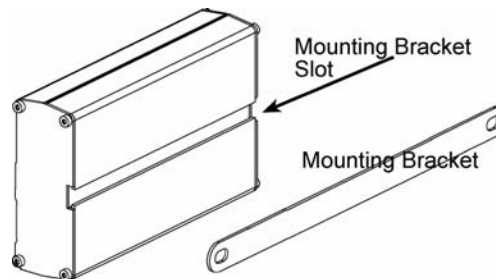

4. Attach the MultiModem with two screws to the mounting surface at the desired location on the equipment.

Step 6 – Install the Modem Driver

Introduction

Compatibility: This wireless MultiModem is compatible with Windows Operating Systems 2000/2003/XP and Linux.

Windows Drivers: The wireless MultiModem USB driver must be installed in your computer's program directory. The procedure differs depending on the operating system and how it is set up. The drivers are located on the MultiModem CD.

Linux Drivers: Linux Operating System drivers are also located on the CD in the Linux directory. Refer to the Readme file (also in the Linux directory) for the correct driver file and installation guide for your distribution/version of Linux.

Overview of Windows Driver Installation: Three install wizards guide you through the software Installation in this order:

- **Part A** installs the USB Driver.
- **Part B** associates the PC port with the USB Driver, and finally
- **Part C** installs the modem .inf file.

Installing the Modem Driver in Windows XP/2003

This installation assumes a Windows XP or Windows 2003 operating system. Windows XP/2003 are identical in the methods they use for installing modem drivers.

Part A for Windows XP/2003: Installing the USB Driver

1. Connect the USB cable between the MultiModem and the PC.
2. Insert the MultiModem CD into your CD-ROM drive. The CD uses the Autorun feature, and after a brief delay, the *MultiModem Setup – Welcome* screen appears. Close the *Welcome* screen.

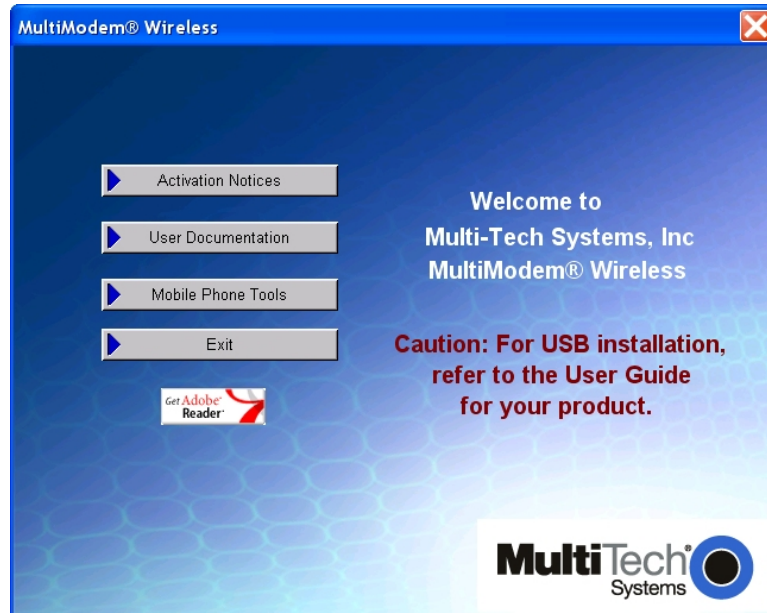

In some situations the operating system will display a *Found New Hardware Wizard* screen and asks you: *Can Windows connect to Windows Update to search for software?* Select **No, not this time**. Then click **Next**.

3. The *Found New Hardware Wizard* screen now displays the TUSB3410 Serial Port device. This is the first of three New Hardware Wizards that will appear.

4. Click on *Install from a list or specific location (Advanced)*.
5. Click **Next**.

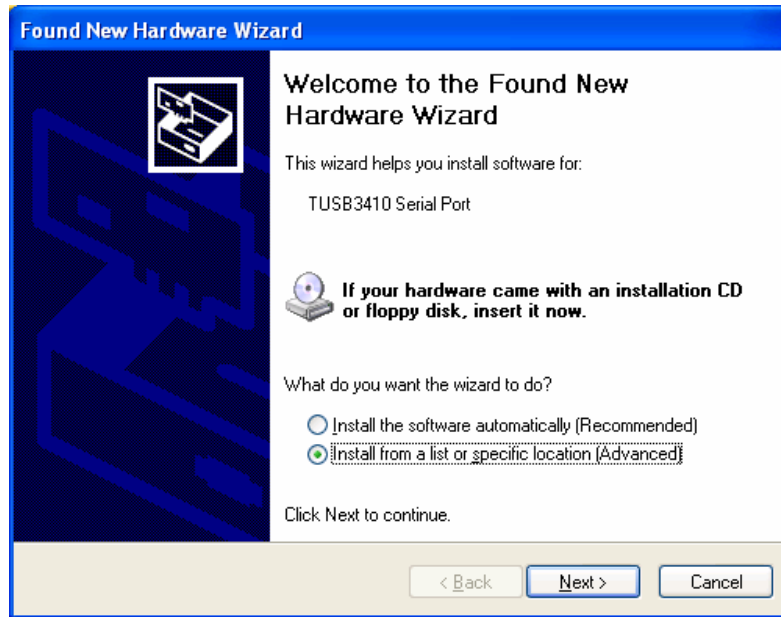

6. The next screen is the *Please choose your search and installation options*. Ensure that **Search for the best driver in these locations with Search removable media (floppy, CD-ROM...)** is selected. Click **Next**.
7. A Windows Logo Testing screen may appear. Some operating systems may not give you this screen. Click **Continue Anyway**.
8. At the *Completing the Found New Hardware Wizard* screen, click **Finish**. Installation of the USB driver is now complete.

The second *Found New Hardware* wizard will start automatically to associate the PC port with the USB driver.

Part B for Windows XP/2003: Associating PC Port with USB Driver

1. If the *Welcome to the Found New Hardware Wizard* screen – *Can Windows connect to Windows update to search for software?* appeared when you were installing the driver, it will come up here also.
Select **No, not this time**. Then click **Next**.
2. The *Welcome to the Found New Hardware Wizard* screen will appear with the **Texas Instruments UMP Serial Port** as the device to be installed. This is the beginning of the *Found New Hardware* sequence for the port.
3. Click **Install from a list or specific location (Advanced)**.
Click **Next**.
4. *Please choose your search and installation options* screen appears.
5. Ensure that **Search for the best driver in these locations** is set and click on **Search removable media (floppy, CR-ROM...)**.
Click **Next**.
6. A second *Windows Logo Testing* screen may appear depending on operating system settings. This screen pertains to the **MTS EDGE USB – Serial Port**.
Click **Continue Anyway**.
7. The *Completing the Found New Hardware Wizard* screen appears.
8. The association between the serial port and the USB driver has been made.
Click **Finish**.

The third *Found New Hardware* wizard will start automatically to install the modem inf file.

Part C for Windows XP/2003: Installing the Modem INF File

1. If the *Welcome to the Found New Hardware Wizard* screen asking – *Can Windows connect to Windows update to search for software?* appears again, select **No, not this time**. Then click **Next**.
2. The *Found New Hardware Wizard* screen appears for the **Multi-Tech – EDGE Modem**.
3. Click on **Install from a list or specific location (Advanced)**. Then click **Next**.
4. The *Please choose your search and installation options* screen appears.
5. Ensure that **Search for the best driver in these locations** is set and click on **Search removable media (floppy, CD-ROM)**. Click **Next**.
6. In the *Please select the best match for your hardware from the list below*, select the Multi-Tech Systems USB EDGE Wireless Modem Version 6.3.30.6 that is listed in the root of the CD-ROM directory. Then click **Next**.

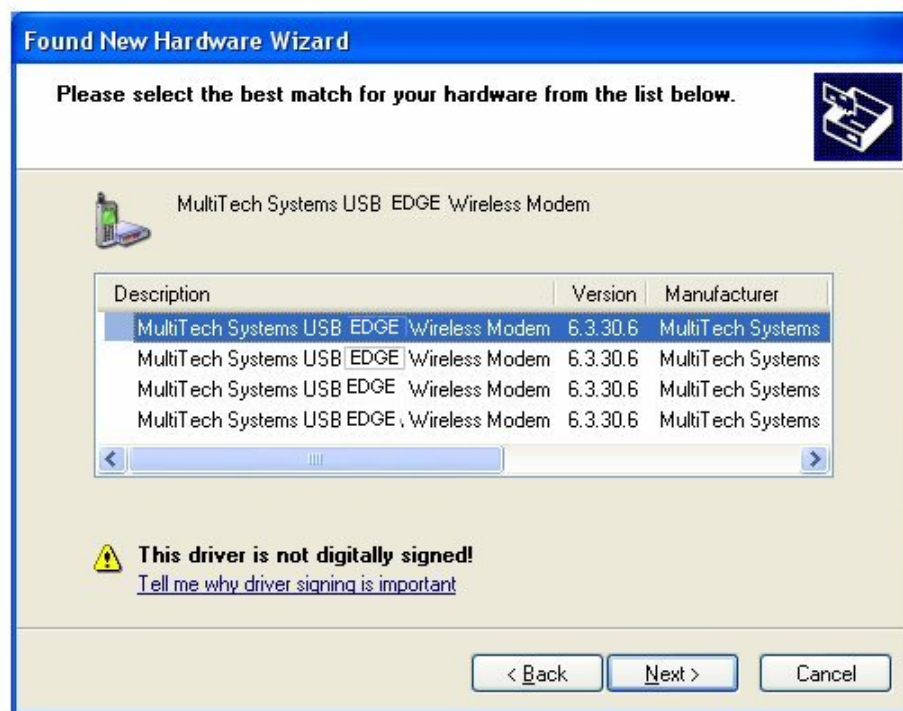

7. The final *Windows Logo Testing* screen may appear depending on operating system settings. This screen pertains to the creation of a modem entity in the operating system that accommodates the wireless USB MultiModem. Click **Continue Anyway**.
8. The *Completing the Found New Hardware Wizard* screen appears. Click **Finish**.

With the modem .inf file successfully installed, the entire software installation procedure for the Wireless USB MultiModem is complete.

Installing the Modem Driver in Windows 2000

Part A for Windows 2000: Installing the USB Driver

1. Connect the USB cable between the MultiModem and the PC.
2. Insert the MultiModem CD into your CD-ROM drive. The CD uses the Autorun feature, and after a brief delay, the *MultiModem Setup – Welcome* screen appears. Close the *Welcome* screen.

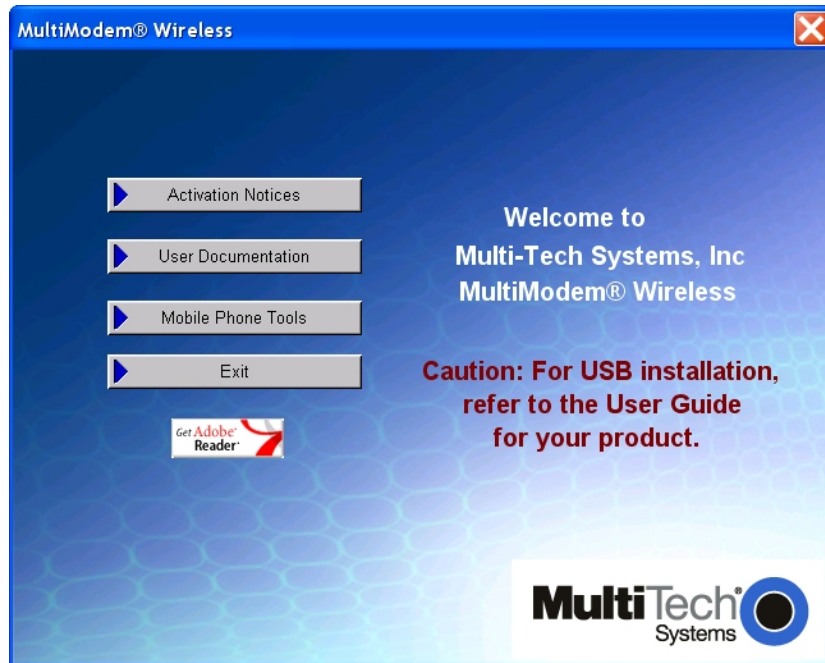

3. After a brief delay, the *Welcome to the Found New Hardware Wizard* screen appears. This is the first of three New Hardware Wizards that will appear. Click **Next**.
4. The *Install Hardware Device Drivers* screen appears referring to the **TUSB3410 Serial Port** device.
5. Click on **Search for a suitable driver for my device (recommended)**. Click **Next**.
6. The *Locate Driver Files* screen appears. Click in the Optional search locations: on **CD-ROM drive** option. Click **Next**.

7. The *Driver Files Search Results* screen appears. The wizard has found the wrong driver. Click on **Install one of the other drivers**. Click **Next**.

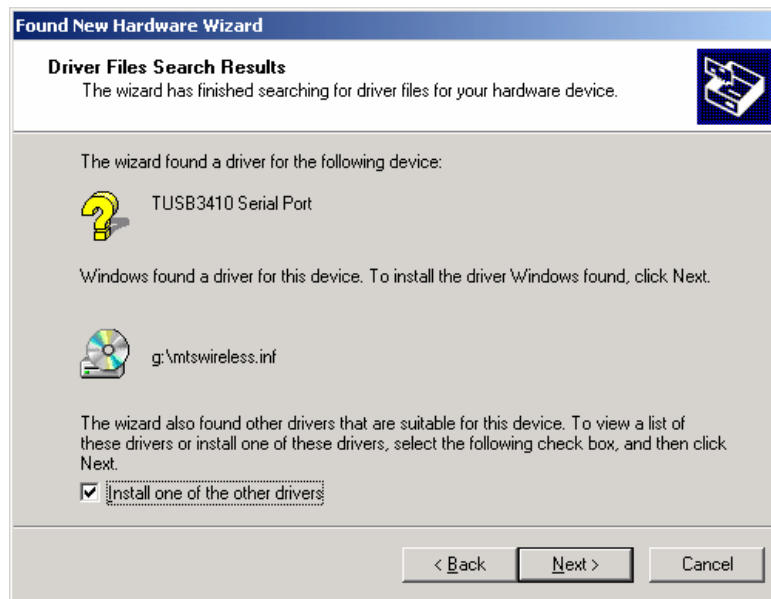

8. At the *Driver Files Found* screen, choose the **EDGE Device** from the listing. Click **Next**.

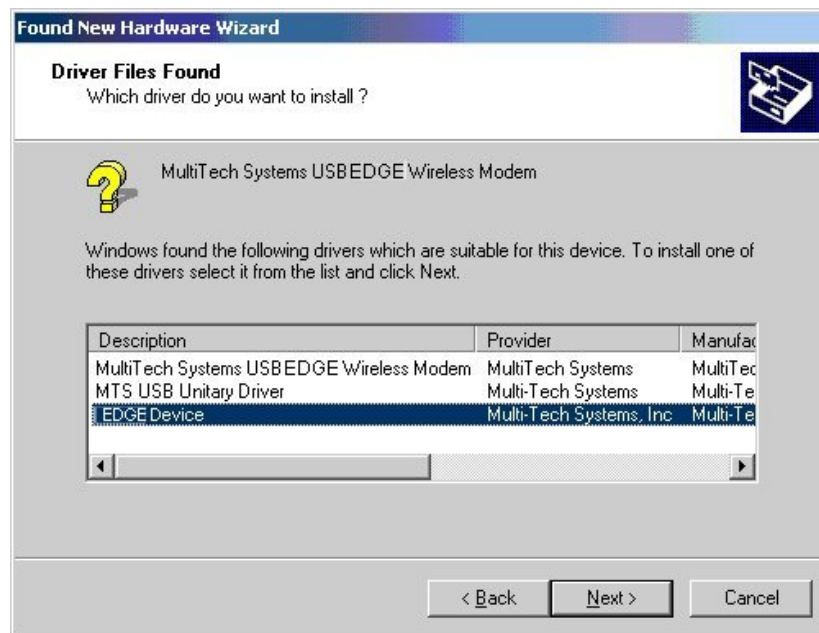

9. A *Digital Signature Not Found* screen may appear depending on operating system settings. Click **Yes**.
10. At the *Completing the Found New Hardware Wizard* screen, click **Finish**.

Installation of the USB driver is now complete.

The second *Found New Hardware* wizard will start automatically to associate the PC port with the USB driver.

Part B for Windows 2000: Associating PC Port with USB Driver

1. Wait while Windows prepares the next phase of the installation (associating the PC port with the USB drive). When the *Welcome to the Found New Hardware Wizard* screen appears, click **Next**.
2. The *Install Hardware Device Drivers* screen appears referring to the Texas Instrument UMP Serial Port. This is the beginning of the “Found New Hardware” sequence for the port. Click on **Search for a suitable driver for my device (recommended)**. Click **Next**.



3. The *Locate Drivers Files* screen appears. Ensure that **CD-ROM driver** is the only option checked. Click **Next**.
4. The *Driver Files Search Results* screen appears with the Texas Instruments UMP Serial Port device listed with the location of the driver. Click **Next**.
5. The *Completing the Found New Hardware Wizard* screen appears.

The association between the serial port and the USB driver has been made.

Click **Finish**.

The third Found New Hardware Wizard will start automatically to install the modem inf file.

Part C for Windows 2000: Installing the Modem INF File

1. After a brief delay, the *Welcome to the Found New Hardware Wizard* screen appears.
Click **Next**.
2. The *Install Hardware Device Drivers* screen appears, referring to the Multi-Tech EDGE modem.
Click on **Search for a suitable driver for my device (recommended)**.
Click **Next**.
3. The *Locate Drivers Files* screen appears. Ensure that CD-ROM drive is the only option checked.
Click **Next**.
4. The *Driver Files Search Results* screen appears with the Multi-Tech – EDGE Modem device listed with the location of the driver.
Click **Next**.
5. A *Digital Signature Not Found* screen may appear depending on operating system settings.
Click **Yes**.
6. The *Completing the Found New Hardware Wizard* screen appears.
Click **Finish**.

With the modem .inf file successfully installed, the entire software installation procedure for the Wireless USB MultiModem is complete.

Chapter 3 – Using Your Wireless Modem

Phone Number for the Wireless Modem

- Every wireless modem will have its own unique phone number.
- The wireless modem's phone number may simply be told to the subscriber by the service provider or be on the SIM or both. Wireless provider implementations may vary.

Examples of Useful AT Commands

A Note About HyperTerminal

In order to verify signal strength and roaming status, you must use a terminal application such as HyperTerminal. To open this program in Windows XP, go to **Start > All Programs > Accessories > Communications > HyperTerminal**. Other Windows operating systems have similar paths to HyperTerminal. See your system's online Help if you cannot find it.

A Note About AT Commands

AT commands can be used to operate, configure, and query your modem. A reference guide to the EDGE commands is included on the MultiModem CD and on the Multi-Tech Web site.

The following two commands let you query signal strength and roaming status.

Verify Signal Strength

Using HyperTerminal, type **AT+CSQ**

The modem responds with the received signal strength (rssi) and the channel bit error rate (ber).

RSSI ranges from 0 to 31.

Signal Strength – RSSI	
10 - 31	Sufficient
0 - 9	Weak or Insufficient
99	Insufficient

BER ranges from 0 to 7 (Seven is the highest error rate).

Checking Network Registration and Roaming Status

Using HyperTerminal, type **AT+CREG?**

The modem will respond in one of the following ways:

- +CREG: 0,0 (this tells you that the modem is not registered on any network)
- +CREG: 0,1 (this tells you that the modem is registered on the home network)
- +CREG: 0,5 (this tells you the modem is registered on a network but it is roaming)

Note: If the modem is showing not registered, perform the procedure for verifying signal strength to determine the strength of the received signal.

Checking the Modem's Identity

Use the **ATI** command (Note: This command is illustrated using the capital letter i after **AT**)

- Type **ATI**
Product information displays. For example, Siemens MC75 Revision xx.yy (xx.yy is the software version)

Establishing a Voice Call

- **Enter PIN Code (if required by your wireless provider)**

Type **AT+CPIN=1234**

Responses: OK (PIN Code accepted)
 +CME ERROR : 16 (Incorrect PIN Code)
 +CME ERROR : 3 (PIN already entered [with +CMEE : 1 mode])

- **Initiate a voice call**

Type **ATD1234;** (Note: Don't forget the semicolon ";" at the end. This stands for *voice* calls)

Responses: OK (Communication established)
 CME ERROR : 11 (PIN Code not entered [with +CMEE : 1 mode])
 CME ERROR : 3 (Operation not allowed)

- **Initiate an emergency call**

Type **ATD112;** (Note: Don't forget the semicolon ";" at the end. This stands for *voice* calls)

Responses: OK

- **Hang up**

Type **ATH**

Responses: OK

Establishing a Circuit-Switched Data Call for a Point-to-Point Connection

A Circuit-Switched Data Connection (CSD) makes the wireless modem work similar to a regular analog modem. You must have CSD service in order to make a CSD call. Note that your wireless provider charges airtime usage for these connections.

Note: Your cellular provider charges airtime usage for these connections.

1. Using HyperTerminal, you can establish a CSD connection by entering the following command:

ATD<phone number>

Notes:

- The phone number you are calling is entered between the brackets. For example, <8585551212>
- This command tells the modem to dial the desired phone number. If you are dialing to another modem, the modem should answer and a connection between the two modems will be established.

2. To disconnect, use the following commands:

+++ Wait about two seconds to see an OK response. Then type:

ATH

Note: **+++** is the escape sequence and **ATH** is the Hang-up command.

Answering a Circuit-Switched Data (CSD) Connection

A Circuit-Switched Data Connection makes the wireless modem work similar to a regular analog modem. You must have CSD service in order to answer a CSD call.

There are three phone numbers for GSM: the voice number, the data number, and the fax number. All are provided by the carrier. To answer a call:

Establish A Connection: Call into the modem by dialing the data number provided by your carrier.

Answer a Call: When you see the RING responses on the terminal screen, enter **ATA <cr>** to answer the call.

Set Auto-Answer: Enter **ATS0=x**
 This sets the modem to auto-answer. The call will be answered after the number of rings entered. **x** stand for the number rings.
 Then call into the number provided to you by the carrier.

Disconnect: Type: **+++**
 Wait about one second to see an OK response.
 Then type: **ATH**

Using Short Message Service (SMS)

If you have SMS (Short Message Service), you can manipulate such messages in these ways: send, read, store, and delete. The AT commands needed to perform these functions are listed below. Please refer to the EDGE AT Command Reference Guide for a complete list and definitions of the SMS commands.

1. Send a short message to a specified number.

Type **AT+CMGS="8585551212" <press Enter>**

Wait for the ">" before entering text.

Then type your message:

Please call me soon. <press ctrl Z>

The modem may respond with **+CMGS:<mr> OK**

2. Write a message to memory.

You can store a message to send it at a later date.

Type **AT+CMGW="8585551212" <press Enter>**

Wait for the ">" before entering text.

Then type your message:

Please call me soon. <press ctrl Z>

The modem may respond with **+CMGW: <index>** (The index number will be given)

3. Send a message from storage.

Type **AT+CMSS=x <press Enter>**

The modem may respond with **+CMSS: 1 OK** (The transmission is successful. One SMS message is sent.)

Note: The **x** represents an index location.

4. View a list of stored messages.

Type **AT+CMGL=x <press Enter>**

For **x**, substitute one of the following:

"REC UNREAD" Shows unread messages.

"REC READ" Shows read messages.

"STO UNSENT" Shows unsent messages.

"STO SENT" Shows sent messages.

"ALL" Shows all messages.

The modem will respond **AT+CMGL: 1,"REC UNREAD","8585551212",1...**

The modem will continue until all UNREAD messages, numbers, and index number are listed.

5. Read a stored message.

Type **AT+CMGR=x <press Enter>**

The modem may respond with **+CMGR: "REC READ", "8585551212",**

Note: The **x** represents an index location.

6. Delete a stored message.

Type **AT+CMGD=x <press Enter>**

The modem will respond **OK**.

Note: The **x** represents an index location.

Short Messages Examples

Send Example: Send SMS message to another SMS compatible device:

```

at+cmgf=1 (set to text mode)
OK

at+cpms="SM","SM","SM" (set memory storage when writing and sending SMS messages)
OK

at+cmgs="7632273726" (send message to the number specified in quotes)
> TEST message ONE. (Type message after the > symbol and hit <CTRL + Z> to send the message)
+CMGS: 52

OK

```

Receive Example 1: Receive SMS messages in text mode by saving to SIM memory – Notification via +CMTI unsolicited response code:

```

at+cmgf=1 (set to text mode)
OK
at+cnmi=2,1,0,0,1 (set to receive SMS and store to memory)
OK
at+cpms="SM","SM","SM" (set messages to be read from SIM and stored to SIM card)
OK

+CMTI: "SM",1 (message received and stored to the SIM card to location 1)
at+cmgr=1 (read the message in location 1)
+CMGR: "REC UNREAD","+17632273726",,"06/03/17,09:02:52+00"
TEST SMS 1 (message)

OK

at+cmgd=1 (delete message in location 1)
OK

```

Receive Example 2: Receive SMS message in text mode by directly routing the received message to the TE through the serial port:

```

at+cmgf=1 (set to text mode)
OK
at+csms=1 (set to Phase 2+ compatibility)
+CSMS: 1,1,1

OK
at+cnmi=2,2,0,0,1 (set to receive SMS messages and directly route to TE)
OK
+CMT: "+17632273726",,"06/03/17,09:06:11+00"
TEST SMS 2 (message)
at+cnma (acknowledge to the network that the message has been received)
OK

```

Internet Access

Internet access can be setup in Windows Dial-Up Networking (DUN) of the computer that the wireless modem is serving. Setup procedures will vary according to the type of wireless service provider used. To access *Dial-Up Networking* on your PC, go to **Start > Settings > Network Connections**.

Notes:

- For GSM-without-GPRS, a circuit-switched data connection is used. The user can set up Dial-Up Networking (DUN) to make a conventional V.32 modem connection to any terminating modem at the other end. The phone number specified in DUN can be one supplied by the wireless service provider or another phone number related to a different dialup modem service (e.g., a dialup modem service phone number from any commercial or private dialup network).
- For GSM-with-GPRS, a single DUN number is generally used by all of a wireless provider's subscribers throughout its area of coverage (regional, nationwide, continental, etc.). Rather than being a literal phone directory number, as in conventional DUN, this is a code that gives the modem Internet access.

Connecting to the GPRS/EDGE Network for Internet Access

After you have inserted the SIM card and all other setup steps are complete, you can establish an Internet connection through a Windows dial-up session.

Note that your wireless provider will charge you for data usage.

Requirements

- One Multi-Tech wireless EDGE modem
- The EDGE modem should have an active SIM card and must have GPRS/EDGE services
- The modem must be getting a proper signal and be showing a network registration through the wireless provider's network
- A PC running Windows XP with the Multi-Tech drivers installed for your particular model

The following instructions are for Windows XP SP2. Every PC may have slight differences which may cause the instructions to be different. Use these instructions as a guide to help you understand what is required to set up an Internet connection through your wireless service provider for all operating systems.

Note: Cellular providers provide Internet services as part of your service plan. Multi-Tech recommends that if you plan on using large amounts of data, to sign up for an unlimited data service plan with your provider. Multi-Tech Systems, Inc. will not be responsible for any charges on your cellular bill. If you have any questions about billing, service plans, service charges, etc., please contact your provider for more information.

Set the Access Point Name (APN) into the Modem's Properties on Your PC

In order for your EDGE wireless modem to connect to your provider's network, you must tell the modem the Access Point Name (APN) to which it will connect. The APN is a server name that your account is setup on with your provider. Your APN will be given to you by your provider. Here are some well-known APNs:

- Cingular Wireless: ISP.CINGULAR, or WAP.CINGULAR
- Cingular Wireless (Formerly AT&T): PROXY, or INTERNET, or PUBLIC
- T-Mobile: INTERNET2.VOICESTREAM.COM, or INTERNET3.VOICESTREAM.COM, or WAP.VOICESTREAM.COM
- Rogers AT&T of Canada: INTERNET.COM

Steps for Setting the APN

1. Start by clicking on **Start** and then clicking on **Control Panel**.
2. In the Control Panel, double-click on **Phone and Modem Options**.
3. The *Phone and Modem Options* window appears. Click on the tab labeled **Modems**. Highlight the Multi-Tech wireless modem listed in the table and then click on **Properties**.
4. A *Properties* window for your modem will display. Click on the **Advanced** tab and you should see an *Extra Settings* box. In the **Extra initialization commands** text box, type:

AT+CGDCONT=1,"IP", "<APN>"

For <APN>, type in the correct APN for your account. For example:

AT+CGDCONT=1,"IP", "ISP.CINGULAR"

Click **OK** to close the modem *Properties* window. Then click **OK** to close the *Phone and Modem Options* window.

Create Your Dial-Up Connection in Windows XP

1. Click on **Start** and then click on **Control Panel**.
2. In the *Control Panel*, double-click on **Network Connections**.
3. On the *Network Connections* screen on the left-hand side under **Network Tasks**, click on **Create a new connection**.
4. The *New Connection Wizard* should appear. It will walk you through setting up your Internet connection. Click on **Next >** to begin.
5. On the *Network Connection Type* screen, select **Connect to the Internet**, and then click **Next >**.
6. On the *Getting Ready* screen, select **Set up my connection manually**, and then click **Next >**.
7. On the *Internet Connection* screen, select **Connect using a dial-up modem**, and then click **Next >**.
Note: After clicking on Next, you may or may not be asked to select which modem to use. If you have more than one modem installed in your PC, you will be required to select the proper modem to use. If asked, please select the Multi-Tech wireless modem that has been installed.
8. On the *Connection Name* screen in the **ISP Name** box, type in a name for your new connection. You can give it any name that you would like. After you have typed in a name, click **Next >**.
9. On the *Phone Number to Dial* screen, type in the number that specifies to the modem to connect to your provider's Internet service.
 For EDGE modems, type in the number ***99***1#**.
 Then click **Next >**.
10. On the *Connection Availability* screen, specify if this connection is for anyone's use or for your use only by checking the appropriate button. Choose your preference, and then click **Next>**.
11. On the *Internet Account Information* screen, type the user name and the password for your account. In many cases, a user name and a password are not required, but some wireless providers require it. Check with your provider to see if they are needed.

Here is some helpful information:

- **For Cingular accounts using the ISP.CINGULAR APN:**
 User name: ispda@cingulargprs.com
 Password: CINGULAR1
- **For Cingular accounts using WAP.CINGULAR APN:**
 User name: wap@cingulargprs.com
 Password: CINGULAR1
- **All other APNs listed on the previous page may not require user names and passwords.**

Check the following two options if you would like them activated:

Check the box if you want this account name and password to be used by everyone.

Check the box if you want this as your default Internet connection. Then click **Next >**.

12. On the *Completing the New Connection Wizard* screen, your last task is to place a check in the box if you would like to add a shortcut to your desktop. Then click **Finish**.
13. A *Connection* screen displays on your desktop. Click the **Properties** button on the bottom of this screen.
14. The *Properties* window will open for you to make your connection. **Important:** Make sure that *Use dialing rules* is not selected, and then click **OK**.
15. Once back at your *Connection* screen, click the **Dial** button at the bottom of the screen to start the connection.
16. The connection will now tell the modem to connect to your provider's Internet service. Once connected, you should see the connection status icon in your system tray at the bottom right-hand corner of your screen.
 You should now be able to open Internet Explorer or any other browser of your preference to surf the Internet.

Disconnecting the Connection:

1. To disconnect the connection, right click on the connection icon in your system tray at the bottom right-hand corner of your screen.
2. Scroll up and click on **Disconnect**.
 You should now be disconnected from the Internet.

Mobile PhoneTools

Mobile PhoneTools is a communication software program included on your MultiModem CD. You can install this program onto your PC and use it for making Internet connections, voice calls, SMS messaging, and email. This program allows you to use your wireless modem hooked up to your PC as if it were a cell phone.

At the moment, Mobile PhoneTools does not function properly with EDGE models. We are sorry for this inconvenience.

Chapter 4 – Troubleshooting and Frequently Asked Questions

Troubleshooting Examples

Before calling the Multi-Tech Technical Support, check to the following connections:

- The right antenna is connected to the modem
- The serial cable connection is correct
- The power is connected correctly and the power lights on the modem are on
- Verify your signal strength
- Verify your network registration
- Use the following situation examples to troubleshoot the modem not answering and the modem returning a *No Carrier* message.

Situation A: The modem does not answer

If the Wireless MultiModem does not answer through the serial link upon an attempted transmission of data or voice signals, see the table below for possible causes and solutions.

Solutions for 'no connection through serial link' situation		
If the modem returns ...	Then ask ...	Action
(nothing)	Is the communication program properly configured?	In communications program, verify that modem parameters have been set to the values shown here: Data bits = 8 Parity = none Stop Bits = 1 Baud = 115200 bps
	Is another program interfering with the communication program?	Close any such application program.
	Is the modem set to autoanswer?	Type ATS0=1 (to set to auto answer on the first ring) Type ATA (to set to manual answer)
	Is the communication program receiving RING responses?	Type ATS0=1 (to set to auto answer on the first ring) Type ATA (to set to manual answer)

Situation B: The modem always returns «No carrier» when trying to originate a call

Solutions for "no carrier" message		
If the modem returns ...	Then ask ...	Action
no carrier (esp. for data communication)	Is the selected bearer type supported by the called party?	Type AT+CEER to view the extended error code (see "Error Results Codes" in the AT Command guide). Be sure that the selected bearer type is supported by the called party.
	Is the selected bearer type supported by the network?	Be sure that the selected bearer type is supported by the network. If no success, try bearer selection type: AT+CBST=0,0,3 Be sure SIM card is available for data/fax calls.
no carrier (esp. for voice communication)		Be sure that the semicolon character (";") is typed immediately after the phone number in the AT command; e.g., ATD#####;

Frequently Asked Questions

Which providers can I use?

- Two major providers are T-Mobile and Cingular.
- We are Cingular approved.

Does this modem support High-Speed Circuit-Switched Data (HSCSD)?

- No, our EDGE modems do not support HSCSD.

The modem is answering, but seems to not be doing anything?

- The modem is answering in voice mode.
- If you are trying to make a data call, make sure the account has CSD service. You will also need the data number (separate number from the main phone number that is provided by the provider).

I am trying to make a data connection by dialing from my wireless modem to an analog modem. Why does the analog modem answer and send tones, but never connect?

- To make a data call you must use the ATD<number> command.
- Make sure the account has CSD service.

How do I get the voice portion to work so I can talk to others using the wireless modem?

- You will need a cable that has the speaker pins connected to a speaker and microphone.
- We have a “Y” cable that splits out to a RJ9 connector that can be used to plug into the receiver of a handset.
- ‘ATD<number>;’ will originate a voice call.

How do I make an Internet connection to my dial-up ISP?

- Make sure you have CSD service.
- Create a dial-up connection to the ISP’s access number, then use your account username and password and choose the wireless modem as the device.

How does faxing work?

- EDGE modems support Class 1 Group 3 faxing.
- You will need fax services setup on your account. You should receive a separate phone number for fax; just like voice and data, and you must call the fax number for the modem to receive a fax.
- You will also need fax software (we do not have working software). WinFax Pro Version 10 has been tested with some success.

I can’t make outgoing calls. I just receive a NO CARRIER response.

- Make sure the antenna is connected and SIM is inserted correctly.
- Check signal and registration: ‘AT+CSQ’ (10-31 is good), ‘AT+CREG?’ (0,1 is registered & 0,5 is roaming).
- Check NO CARRIER reason with ‘AT+CEER’. Look up error code in Reference Guide.

The modem will not answer.

- To have modem autoanswer, set modem with ‘ATS0=1’ and ‘AT&W’ to store the setting.
- Send ‘ATA’ to the modem once the RING is indicated on the terminal screen.
- You may need to set modem to ignore DTR, ‘AT&D0’, if you aren’t providing DTR.

I am trying to make a GPRS/EDGE connection using a Windows dial-up session. It connects and then immediately disconnects.

- Make sure the APN is configured in the modem correctly (The APN is provided by the provider).
- Check the APN with ‘AT+CGDCONT?’ To make sure it is correct.
- If no APN is inserted, then insert the correct APN using the command ‘AT+CGDCONT=1,“IP”,“<APN>”’ with HyperTerminal or add it into the “Extra Initialization Commands:” in the modem’s properties.
- Make sure the APN is correct for your account.

When I try to establish a GPRS/EDGE connection using Windows dial-up I get an error: “Hardware Failure”.

- Check the modem to make sure it is installed and can be queried in the modem’s properties.
- Make sure the com port is not being held by another application. Look for the TR light indication. If it is on, most likely another application is holding onto the port.
- Make sure the dial-up connections maximum speed matches the modem’s properties maximum port speed.
- Try rebooting the PC.

Chapter 5 – Reference Information

Wireless Modem Reference Information

GSM reference documents: GSM 03.40, GSM 03.45, GSM 04.11, GSM 04.21, GSM05.08,
GSM 07.01, GSM 07.02, GSM 07.05, GSM 07.07.

ETSI contact: ETSI Secretariat
F-06921 Sophia Antipolis Cedex, France
e-mail: secretariat@etsi.fr

Service: The AT commands manual is available on the Multi-Tech web site:
<http://www.multitech.com>

Appendix A – Warranty and Repairs

Multi-Tech Warranty Statement

Multi-Tech Systems, Inc., (hereafter “MTS”) warrants that its products will be free from defects in material or workmanship for a period of two, five, or ten years (depending on model) from date of purchase, or if proof of purchase is not provided, two, five, or ten years (depending on model) from date of shipment.

MTS MAKES NO OTHER WARRANTY, EXPRESS OR IMPLIED, AND ALL IMPLIED WARRANTIES OF MERCHANTABILITY AND FITNESS FOR A PARTICULAR PURPOSE ARE HEREBY DISCLAIMED.

This warranty does not apply to any products which have been damaged by lightning storms, water, or power surges or which have been neglected, altered, abused, used for a purpose other than the one for which they were manufactured, repaired by Customer or any party without MTS’s written authorization, or used in any manner inconsistent with MTS’s instructions.

MTS’s entire obligation under this warranty shall be limited (at MTS’s option) to repair or replacement of any products which prove to be defective within the warranty period or, at MTS’s option, issuance of a refund of the purchase price. Defective products must be returned by Customer to MTS’s factory — transportation prepaid.

MTS WILL NOT BE LIABLE FOR CONSEQUENTIAL DAMAGES, AND UNDER NO CIRCUMSTANCES WILL ITS LIABILITY EXCEED THE PRICE FOR DEFECTIVE PRODUCTS.

Repair Procedures for U.S. and Canadian Customers

In the event that service is required, products may be shipped, freight prepaid, to our Mounds View, Minnesota factory:

Multi-Tech Systems, Inc.
2205 Woodale Drive
Mounds View, MN 55112 U.S.A
Attn: Repairs, Serial # _____

A Returned Materials Authorization (RMA) is not required. Return shipping charges (surface) will be paid by MTS to destinations in U.S. and Canada.

Please include, inside the shipping box, a description of the problem, a return shipping address (must have street address, not P.O. Box), your telephone number, and if the product is out of warranty, a check or purchase order for repair charges.

For out of warranty repair charges, go to [COMPANY/Policies/warranty/](#)

Extended two-year overnight replacement service agreements are available for selected products. Please call MTS customer service at (888) 288-5470 or visit our web site at [COMPANY/Programs/overnight_replacement](#) for details on rates and coverage’s.

Please direct your questions regarding technical matters, product configuration, verification that the product is defective, etc., to our Technical Support department at (800) 972-2439 or email support@multitech.com. Please direct your questions regarding repair expediting, receiving, shipping, billing, etc., to our Repair Accounting department at (800) 328-9717 or (763) 717-5631, or email mtsrepair@multitech.com.

Repairs for damages caused by lightning storms, water, power surges, incorrect installation, physical abuse, or user-caused damages are billed on a time-plus-materials basis.

Repair Procedures for International Customers

(Outside U.S.A. and Canada)

Your original point of purchase Reseller may offer the quickest and most economical repair option for your Multi-Tech product. You may also contact any Multi-Tech sales office for information about the nearest distributor or other repair service for your Multi-Tech product. The Multi-Tech sales office directory is available at http://www.multitech.com/COMPANY/contact_us/

In the event that factory service is required, products may be shipped, freight prepaid to our Mounds View, Minnesota factory. Recommended international shipment methods are via Federal Express, UPS or DHL courier services, or by airmail parcel post; shipments made by any other method will be refused. Please include, inside the shipping box, a description of the problem, a return shipping address (must have street address, not P.O. Box), your telephone number, and if the product is out of warranty, a check in U.S. dollars drawn on a U.S. bank or your company's purchase order for repair charges. Repaired units shall be shipped freight collect, unless other arrangements are made in advance.

Please direct your questions regarding technical matters, product configuration, verification that the product is defective, etc., to our Technical Support department nearest you or email support@multitech.com. When calling the U.S., please direct your questions regarding repair expediting, receiving, shipping, billing, etc., to our Repair Accounting department at +(763) 717-5631 in the U.S.A., or email mtsrepair@multitech.com.

Repairs for damages caused by lightning storms, water, power surges, incorrect installation, physical abuse, or user-caused damages are billed on a time-plus-materials basis.

Repair Procedures for International Distributors

International distributors should contact their MTS International sales representative for information about the repair of the Multi-Tech products.

Please direct your questions regarding technical matters, product configuration, verification that the product is defective, etc., to our International Technical Support department at +(763)717-5863. When calling the U.S., please direct your questions regarding repair expediting, receiving, shipping, billing, etc., to our Repair Accounting department at +(763) 717-5631 in the U.S.A. or email mtsrepair@multitech.com.

Repairs for damages caused by lightning storms, water, power surges, incorrect installation, physical abuse, or user-caused damages are billed on a time-plus-materials basis

Replacement Parts

SupplyNet, Inc. can supply you with replacement power supplies, cables and connectors for selected Multi-Tech products. You can place an order with SupplyNet via mail, phone, fax or the Internet at the following addresses:

Mail: SupplyNet, Inc.
614 Corporate Way
Valley Cottage, NY 10989
Phone: 800 826-0279
Fax: 914 267-2420
Email: info@thesupplynet.com
Internet: <http://www.thesupplynet.com>

Appendix B - Waste Electrical and Electronic Equipment (WEEE) Statement

July, 2005

The WEEE directive places an obligation on EU-based manufacturers, distributors, retailers and importers to take-back electronics products at the end of their useful life. A sister Directive, ROHS (Restriction of Hazardous Substances) complements the WEEE Directive by banning the presence of specific hazardous substances in the products at the design phase. The WEEE Directive covers all Multi-Tech products imported into the EU as of August 13, 2005. EU-based manufacturers, distributors, retailers and importers are obliged to finance the costs of recovery from municipal collection points, reuse, and recycling of specified percentages per the WEEE requirements.

Instructions for Disposal of WEEE by Users in the European Union

The symbol shown below is on the product or on its packaging, which indicates that this product must not be disposed of with other waste. Instead, it is the user's responsibility to dispose of their waste equipment by handing it over to a designated collection point for the recycling of waste electrical and electronic equipment. The separate collection and recycling of your waste equipment at the time of disposal will help to conserve natural resources and ensure that it is recycled in a manner that protects human health and the environment. For more information about where you can drop off your waste equipment for recycling, please contact your local city office, your household waste disposal service or where you purchased the product.



Free Manuals Download Website

<http://myh66.com>

<http://usermanuals.us>

<http://www.somanuals.com>

<http://www.4manuals.cc>

<http://www.manual-lib.com>

<http://www.404manual.com>

<http://www.luxmanual.com>

<http://aubethermostatmanual.com>

Golf course search by state

<http://golfingnear.com>

Email search by domain

<http://emailbydomain.com>

Auto manuals search

<http://auto.somanuals.com>

TV manuals search

<http://tv.somanuals.com>