Multi*FRAD*TM 3000-Series

Router/Multiport Data/Voice/Fax
Frame Relay Access Device

Models

FR3060, FR3100

FR3060/V4, FR3060/V8

FR3100/V4, FR3100/V8

User Guide



User Guide

88302202 Revision C
MultiFRAD 3000-Series (Model Numbers FR3060, FR3100,
FR3060/V4, FR3060/V8, FR3100/V4, FR3100/V8)

This publication may not be reproduced, in whole or in part, without prior expressed written permission from Multi-Tech Systems, Inc. All rights reserved.

Copyright © 1999, by Multi-Tech Systems, Inc.

Multi-Tech Systems, Inc. makes no representations or warranties with respect to the contents hereof and specifically disclaims any implied warranties of merchantability or fitness for any particular purpose. Furthermore, Multi-Tech Systems, Inc. reserves the right to revise this publication and to make changes from time to time in the content hereof without obligation of Multi-Tech Systems, Inc. to notify any person or organization of such revisions or changes.

Record of Revisions

| Revision | Description |
|------------------------|---|
| A (3/26/98) | Manual released. All pages at revision A. |
| B (12/16/98) | Manual revised to include software release version 2.00. |
| C (5/14/99) | Manual revised to include Voice/Fax feature with software release version 3.00. |

PATENTS

This Product is covered by one or more of the following U.S. Patent Numbers: **5.301.274; 5.309.562; 5.355.365; 5.355.653; 5.452.289; 5.453.986** . Other Patents Pending.

TRADEMARK

Trademark of Multi-Tech Systems, Inc. are MultiFRAD and the Multi-Tech logo.

Windows is a registered trademark of Microsoft.

Multi-Tech Systems, Inc.
2205 Woodale Drive
Mounds View, Minnesota 55112
(612) 785-3500 or (800) 328-9717
Fax 612-785-9874
Tech Support (800) 972-2439
Fax-Back (612) 717-5888
Internet: <http://www.multitech.com>
Tech Writer: brian@multitech.com

Contents

Chapter 1 - Introduction and Description

| | |
|--|----|
| Introduction | 6 |
| Preview of this Guide | 7 |
| Front Panel Description | 8 |
| Back Panel Description | 10 |
| Power Connector | 10 |
| Frame Ground (GND) Connector | 10 |
| Internal Composite Link (T1 DSU) Connector | 10 |
| Monitor (XMT/RCV) Connector | 10 |
| Command Port Connector | 10 |
| External Composite Link (RS232/V.35) Connector | 10 |
| Ethernet 10Base-T Connector | 10 |
| Channels 1 & 2 (RS232/V.35) Connectors | 10 |
| Channels 3 - 10 Connectors | 11 |
| Voice/Fax Channels 1 - 8 Connectors | 11 |
| Technical Specifications | 12 |
| Ethernet Port | 12 |
| Command Port | 12 |
| Composite Link (external) | 12 |
| Channel Connectors | 12 |
| Voice/Fax Channel Connectors | 12 |
| Electrical/Physical | 12 |
| Requirement | 12 |

Chapter 2 - Installation

| | |
|--|----|
| Introduction | 14 |
| Unpacking your MultiFRAD 3000 | 14 |
| Safety Warnings | 14 |
| Valid Voice/Fax Channel Connections | 14 |
| Cabling your MultiFRAD 3000 | 15 |
| E&M Jumper Block Positioning Procedure | 18 |

Chapter 3 - Software Loading and Configuration

| | |
|---|----|
| Introduction | 20 |
| Loading your Software | 20 |
| Detect and Map Your DLCIs | 31 |
| Build Your Phone Directory Database | 33 |

Chapter 4 - MultiFRAD Software

| | |
|------------------------------------|----|
| Introduction | 38 |
| Before You Begin | 38 |
| MultiFRAD Configuration | 39 |
| Changing IP Parameters | 40 |
| Changing IPX Parameters | 43 |
| Changing Bridging Parameters | 46 |
| WAN Port Setup | 47 |
| Point to Point Setup | 48 |
| Frame Relay Setup | 49 |
| Data Port Configuration | 54 |

| | |
|---|----|
| Changing Voice/Fax Channel Parameters | 55 |
| Interface | 55 |
| Voice/Fax | 56 |
| Regional | 57 |
| Changing the Phone Directory Database | 58 |
| Others Setup | 59 |
| Statistics | 61 |
| IP Statistics | 62 |
| IPX Port Statistics | 63 |
| STP (Spanning Tree) Port Statistics | 63 |
| SNMP Statistics | 64 |
| WAN Statistics | 64 |
| PPP Statistics | 65 |
| Data Port Statistics | 66 |
| Frame Relay Statistics | 67 |

Chapter 5 - Remote Configuration and Management

| | |
|------------------------------|----|
| Introduction | 70 |
| Remote Configuration | 70 |
| Modem-Based | 70 |
| LAN-Based | 72 |
| Remote Management | 74 |
| Telnet | 74 |
| WEB Browser Management | 76 |

Chapter 6 - Warranty, Service and Tech Support

| | |
|--|----|
| Introduction | 80 |
| Limited Warranty | 80 |
| On-line Warranty Registration | 80 |
| Tech Support | 81 |
| Recording MultiFRAD Information | 81 |
| Contacting Tech Support via E-mail | 81 |
| Service | 82 |
| The Multi-Tech BBS | 82 |
| To log on to the Multi-Tech BBS | 82 |
| To Download a file | 82 |
| About the Internet | 83 |

Appendices

| | |
|---|----|
| Appendix A - Cabling Diagrams | 86 |
| Appendix B - Regulatory Information | 90 |

Glossary

Index

Multi*FRAD*TM 3000-Series

Router/Multiport Data/Voice/Fax
Frame Relay Access Device

Chapter 1 - Introduction and Description

MultiTech[®]
Systems 

Introduction

Welcome to Multi-Tech's new MultiFRAD 3000 series, a Frame Relay Access Device (FRAD) that encapsulates data streams from the voice/fax channels, data channels, and LAN devices into frame relay frames. The MultiFRAD 3000 series contains six or ten synchronous or asynchronous data channels, four or eight Voice/Fax channels, a 10M bps Ethernet port, and a composite link that connects to a common carrier frame relay network service, private frame relay network, or a point-to-point network. The MultiFRAD 3000 series also provides additional features of data over IP and hub capabilities that allow multiple MultiFRAD 3000's to be connected together, increasing the number of available data channels.

The MultiFRAD 3000 series has six model numbers that include FR3060 which allows up to six data channel devices such as multiplexers to be connected to its RS232 data channels, an Ethernet LAN connection for IP or IPX routing or bridging of other protocols, an RS232 command port, and a composite link for access to a Frame Relay Network. The FR3100 allows up to ten devices to be connected, along with the Ethernet port, command port, and composite link connections. Voice/Fax capabilities can be added to the two base models allowing either 4 Voice/Fax channels or 8 Voice/Fax channels on either model. The 4-channel model with 6-data channels is referred to as model FR3060/V4. The 8-channel voice/fax capability with 10-data channels is referred to as FR3100/V8.

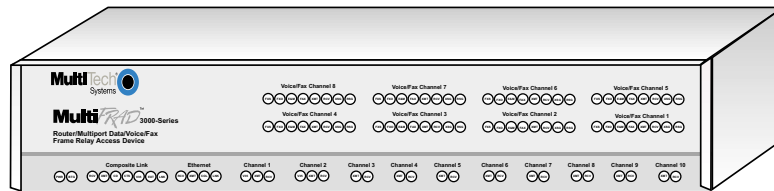

Figure 1. MultiFRAD 3000-Series

Note: At this time, the MultiFRAD does not support voice/fax operation in a Point-to-Point configuration. Voice/fax operation is only supported over a frame relay network.

Preview of this Guide

This User Guide describes the MultiFRAD and details how to install and configure it. The information contained in each chapter is as follows:

Chapter 1 - Introduction and Description

Chapter 1 describes the MultiFRAD including front panel descriptions, back panel connectors, and relevant technical specifications.

Chapter 2 - Installation

[Chapter 2](#) provides information on unpacking and cabling your MultiFRAD. Safety Warnings are detailed, followed by the installation procedure in which each of the cables are connected to the MultiFRAD and the unit is powered on.

Chapter 3 - Software Loading and Configuration

[Chapter 3](#) details the software loading and initial configuration. The MultiFRAD software diskettes are Windows based. Later chapters, as well as your on-line help program describe the MultiFRAD software in more detail.

Chapter 4 - MultiFRAD Software

[Chapter 4](#) describes the MultiFRAD software from an applications perspective, and in doing so, not every screen is shown, nor is each field within a screen defined. For explanations and parameters of each field within a dialog box, please refer to the on-line help system provided within the software.

Chapter 5 - Remote Configuration and Management

[Chapter 5](#) provides procedures for viewing and changing the configuration of a remote MultiFRAD. Two methods are provided to access a remote unit; the first method is modem based and the second method is using IP. Within the IP method, three applications can be used: 1) LAN-based using TFTP (Trivial File Transfer Protocol), 2) telnet as a client application, or 3) a standard web browser on the internet.

Chapter 6 - Warranty, Service and Tech Support

[Chapter 6](#) provides instructions on getting service for your MultiFRAD at the factory, a statement of the limited warranty, information about our internet presence and user bulletin board service, and space for recording information about your MultiFRAD prior to calling Multi-Tech's Technical Support personnel.

Front Panel Description

The front panel of the MultiFRAD contains groups of LEDs that provide the information on the composite link activity, LAN, data channels, and Voice/Fax channel activity, and the general status of the MultiFRAD.

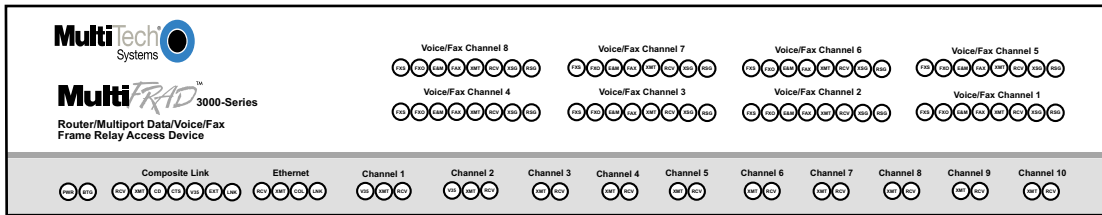

The LED's are as follows:

- PWR Power.** This indicator lights when the ON/OFF switch is in the ON position.
- BTG Booting.** This indicator lights when the MultiFRAD is booting. It takes approximately 90 seconds to boot.

Composite Link

- RCV Receive.** This indicator blinks when the composite link is receiving data.
- XMT Transmit.** This indicator blinks when the composite link is transmitting data.
- CD Carrier Detect.** This indicator lights when the MultiFRAD detects a carrier signal.
- CTS Clear To Send.** This indicator lights when the composite link device is ready to transmit data.
- V35 V.35 Interface.** This indicator lights when the composite link is configured for a V.35 interface.
- EXT External Link.** This indicator lights when the MultiFRAD is configured for an external composite device.
- LNK Link.** This indicator lights solid when all DLCIs detected become active; flashes fast when at least one DLCI is active and others are inactive; flashes slow when communication with the local frame relay switch has occurred; and off when no frame relay communication has been received.

Ethernet

- RCV Receive.** This indicator blinks when packets are being received from the local area network.
- XMT Transmit.** This indicator blinks when packets are being transmitted to the local area network.
- COL Collision.** This indicator lights when a collision is in progress; that is, when two nodes are transmitting packets at the same time.
- LNK Link.** This indicator lights indicating that the MultiFRAD is connected to the local area network.

Channels 1 and 2

- V35** **V.35 Interface.** This indicator lights when the channel is configured for a V.35 interface.
- XMT** **Transmit.** This indicator blinks when the channel is receiving data to be transmitted on the link or over IP.
- RCV** **Receive.** This indicator blinks when the channel is transmitting data received from the link.

Channels 3 through 10

- XMT** **Transmit.** This indicator blinks when the channel is receiving data to be transmitted on the link or over IP.
- RCV** **Receive.** This indicator blinks when the channel is transmitting data received from the link.

Voice/Fax Channels 1 - 8

- FXS** **Foreign Exchange Station.** This indicator lights when the voice/fax channel is configured for FXS operation.
- FXO** **Foreign Exchange Office.** This indicator lights when the voice/fax channel is configured for FXO operation.
- E&M** **Ear & Mouth Operation.** This indicator lights when the voice/fax channel is configured for E&M operation.
- FAX** **Fax.** This indicator lights when there is fax traffic on the voice/fax channel.
- XMT** **Transmit.** This indicator lights when voice or fax data is being transmitted.
- RCV** **Receive.** This indicator lights when voice or fax data is being received.
- XSG** **Transmit Signal.** This indicator lights when the FXS-configured channel is off-hook, the FXO-configured channel is receiving a ring from the telco, or the M lead is active when the voice/fax channel is configured for E&M operation (i.e., the MultiFRAD is receiving a ring from the PBX).
- RSG** **Receive Signal.** This indicator lights when the FXS-configured channel is ringing, the FXO-configured channel is off-hook, or the E lead is active on the E&M-configured channel.

Back Panel Description

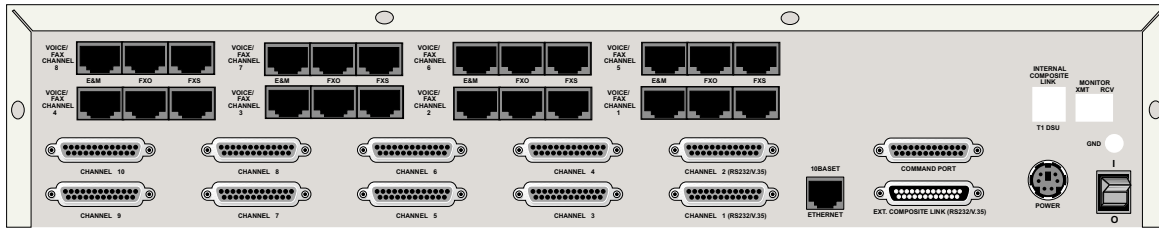

The connectors are as follows:

Power Connector

The POWER connector is used to connect the external power supply to the MultiFRAD. The connector is a 7-pin circular DIN connector.

Frame Ground (GND) Connector

Use the GND connector to connect the MultiFRAD's frame ground to the PBX's frame ground when the MultiFRAD is configured for E&M operation.

Internal Composite Link (T1 DSU) Connector

This connector is not currently supported.

Monitor (XMT/RCV) Connector

This connector is not currently supported.

Command Port Connector

Use this DB-25 female connector to connect the MultiFRAD to a PC running Windows or terminal with communications software in order to configure the MultiFRAD.

External Composite Link (RS232/V.35) Connector

Use this DB-25 male connector to connect the MultiFRAD to an external modem, DSU, ISDN terminal adapter, or any device that is synchronous, full duplex, and supplies clocking signals. The connection interface can be either RS-232 or V.35.

Ethernet 10Base-T Connector

Use the Ethernet 10Base-T (UTP) connector to connect the MultiFRAD MultiFRAD port to a LAN. The connector is an RJ-45 jack.

Channels 1 & 2 (RS232/V.35) Connectors

The connectors for Channels 1 and 2 are used to connect the MultiFRAD to data devices. A data device can be a HDLC synchronous device such as a multiplexer or an asynchronous device such as a PC. These two data channels can be either RS-232 or V.35. The connectors are DB-25 female connectors.

Channels 3 - 10 Connectors

These DB-25 female connectors are used to connect the MultiFRAD to channel devices. These connections can be to either asynchronous or HDLC synchronous RS-232 data equipment such as multiplexers.

Voice/Fax Channels 1 - 8 Connectors

E&M

Use the E&M connector to connect the MultiFRAD Voice/Fax channel to the E&M connector on an analog PBX (Private Branch eXchange) trunk when linking two PBX's together. The E&M connector is an RJ-48 jack.

FXO

Use the FXO (Foreign eXchange Office) connector to connect the MultiFRAD Voice/Fax channel to an analog station card on the local PBX. This connection is also commonly referred to as an OPX (Off Premises eXtension). The FXO connector is an RJ-11 jack.

FXS

Use the FXS (Foreign eXchange Station) connector to connect the MultiFRAD Voice/Fax channel to an analog station instrument (telephone, fax machine, or key telephone system). The FXS connector is an RJ-11 jack.

Technical Specifications

- Provides access to frame relay networks for SLIP, PPP, async and HDLC sync devices.
- Trunk and Data ports may be configured as EIA-232 or V.35
- Trunk Speeds up to T1/E1 synchronous
- 4MB DRAM
- 16MB of flash memory

Ethernet Port

- One Ethernet Interface - 10Base-T (twisted Pair) RJ-45 connector

Command Port

- Single 19.2K bps asynchronous Command Port with a DB-25 female connector

Composite Link (external)

- Access Rate: 1.544M bps (T1) or 2.048M bps (E1) sync on DTE-type RS-232 or V.35 interface.

Channel Connectors

- 6 on the FR3060; 10 on the FR3100
- Data Rate: Channels 1 and 2 up to 512K bps with V.35 interface; synchronous to 128K bps on RS-232/V.35 interface; or asynchronous to 115.2K bps on RS-232/V.35 interface.

Voice/Fax Channel Connectors

- Two RJ-11 jacks (FXO and FXS)
- One RJ-48 jack (E&M)

Electrical/Physical

- Operating Environment: 32-104°F (0-40°C); 95% non-condensing humidity
- Power Requirements: 100-250V AC at 50/60 Hz
- Dimensions: 17.4" wide x 3.75" high x 8" deep
44.2 cm wide x 8.9 cm high x 20.3 cm deep
- Weight: 7.4 lbs.
3.4 kg

Requirement

- PC with Windows 3.1x/95/98/NT, Terminal/Dumb Terminal @19,200 bps for menu driven local configuration, or Remote Configuration via web browser or Telnet.

MultiFRADTM 3000-Series

Router/Multiport Data/Voice/Fax
Frame Relay Access Device

Chapter 2 - Installation



Introduction

This chapter will guide you through the unpacking and installation of your MultiFRAD. The installation procedure, which is preceded by important safety instructions, will provide step by step instruction on cabling and powering-on the MultiFRAD. Chapter 3 will provide instruction on loading and configuring the MultiFRAD software.

Unpacking your MultiFRAD 3000

Remove all items from the box. Your shipping box should contain the MultiFRAD, a power supply, various cables, software and manual diskettes, and a MultiFRAD 3000-Series Quick Start Guide. Please inspect all items before proceeding with the installation. If any of the items appears to be damaged in any way, do not power up the unit; contact Multi-Tech's Technical Support personnel for advice (See Chapter 6). If no damage is observed, configure the MultiFRAD using the information in this chapter.

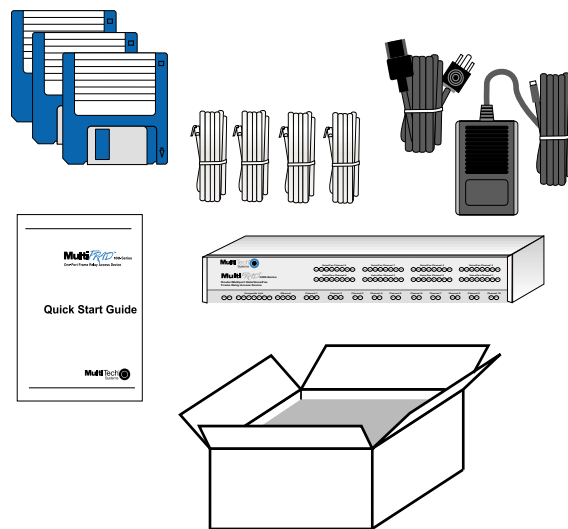

Figure 2. Unpacking

Safety Warnings

Caution

Danger of explosion if battery is incorrectly replaced.

A lithium battery on the voice/fax channel board provides backup power for the time keeping capability. The battery has an estimated life expectancy of ten years.

When the battery starts to weaken, the date and time may be incorrect. If the battery fails, the board must be sent back to Multi-Tech Systems for battery replacement.

The E&M, FXS, and Ethernet ports are not designed to be connected to a Public Telecommunication Network.

Valid Voice/Fax Channel Connections

The following Voice/Fax channel connections can be made at this time:

- FXS to FXS
- FXS to FXO
- FXS to E&M
- E&M to E&M

Data Channel Cable Connections

- Connect one end of a DB-25 cable to one of the data channel connectors on the back of your MultiFRAD (labeled CHANNEL 1-6 for the FR3060, CHANNEL 1-10 for the FR3100). See Figure 4. Connect the other end of each cable to the channel device. Repeat for each of the up to 6 or 10 channels you are connecting.

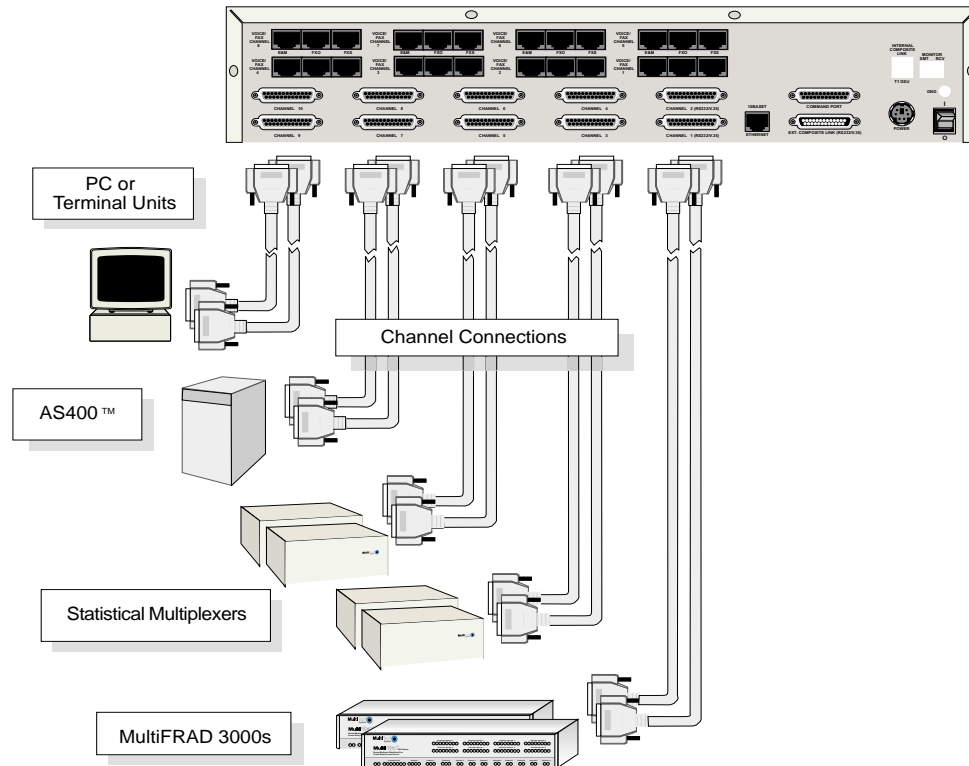

Figure 4. Channel Cable Connections

NOTE: only Channels 1, 2, and the composite link support V.35 and RS-232, all other channels are RS-232 only. There are shunts inside to select V.35 or RS-232.

Voice/Fax Cable Connections

NOTE: The E&M, FXS, and Ethernet ports are not designed to be connected to a Public Telecommunication Network.

- If you are connecting a station device; e.g., analog telephone, fax machine, or Key Telephone System (KTS) to your MultiFRAD; connect one end of an RJ-11 phone cord to the **Voice/Fax Channel 1 FXS** connector on the back of the MultiFRAD and the other end to the station device. See Figure 5.

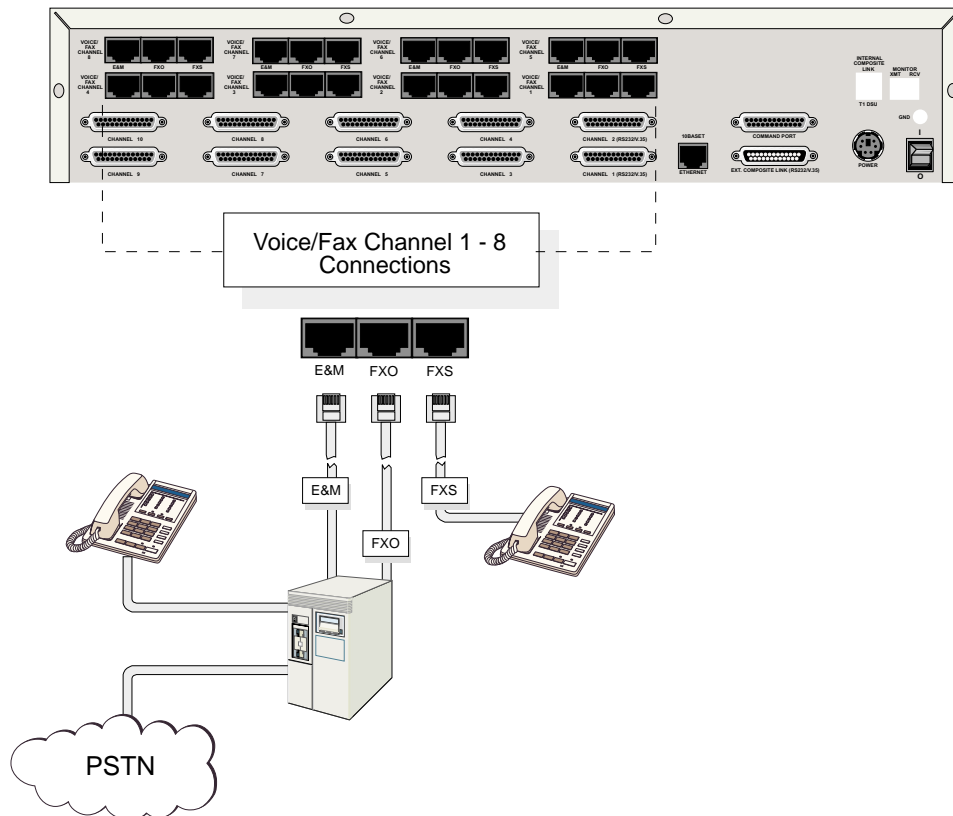

Figure 5. Voice/Fax Cable Connections

If you are connecting the station side of a telephone switch (PBX) to your MultiFRAD, connect one end of an RJ-11 phone cord to the **Voice/Fax Channel 1 FXO** connector on the back of the MultiFRAD and the other end to the phone jack.

If you are connecting an E&M trunk from a telephone switch to your MultiFRAD, connect one end of an RJ-45 phone cord to the **Voice/Fax Channel 1 E&M** connector on the back of the MultiFRAD and the other end to the trunk phone jack.

If you are connecting to an E&M trunk, you need to ensure that the E&M trunk jumper is in the correct position for the E&M type trunk. The default E&M jumper position is E&M type 2. To change the E&M jumper position, perform the E&M jumper block positioning procedure in following this procedure.

- Repeat the above step to connect the remaining telephone equipment to each Voice/Fax Channel on your MultiFRAD.
- Turn on power to the MultiFRAD by placing the On/Off switch on the back panel to the 1 position.

At this time your MultiFRAD is completely cabled. Proceed to the next section to load your software.

E&M Jumper Block Positioning Procedure

A jumper block exists for each voice/fax channel. The jumper block is to the right of each set of channel jacks. The jumper block contains 8-pairs of pins. The jumper plug fits over three pairs of pins on the jumper block. The E&M type number is labeled on the pc board. The jumper plug needs to be centered on the E&M type number. Perform the following procedure to change E&M jumper position.

- 1 Ensure that power is removed from the MultiFRAD.
- 2 Turn the unit up side down and remove the four phillips screws from the cover. Turn the unit right side up and remove the four phillips screws from the back of the top cover.
- 3 Remove the front panel by loosening the two capative phillips screws. Slide the top cover back off the chassis to expose the rear panel.
- 4 To change a jumper position, lift the jumper plug up off the jumper block and move to the new position, ensuring that the center jumper is centered on the E&M type number.

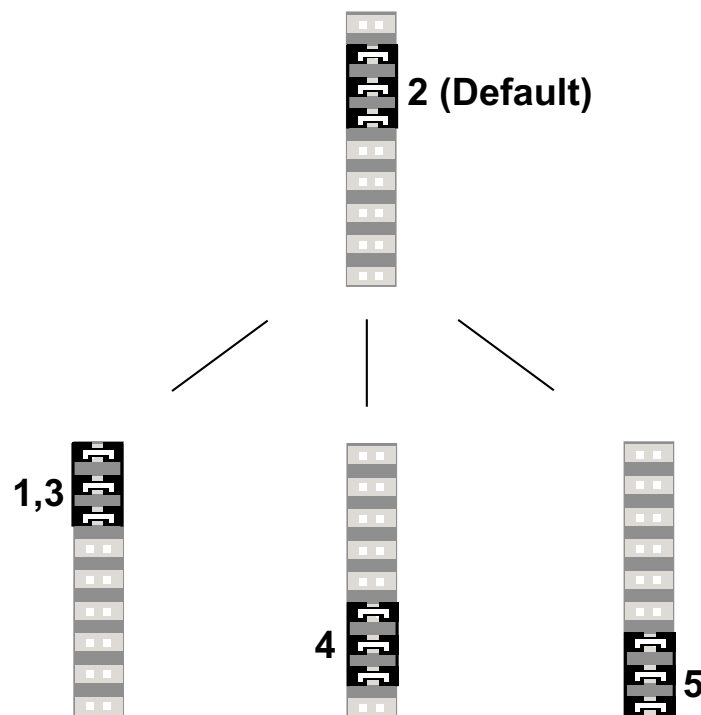

Figure 6. E&M Jumper Block

- 5 Change the jumper position for each voice/fax channel that is connecting to an E&M trunk that is not a type 2.
- 6 Slide the top cover back on to the chassis. Replace the front panel and secure it by tightening the two capative phillips screws.
- 7 From the back of the unit, replace the four phillips screws that secure the top cover. Then, turn the unit up side down and replace the four phillips that secure the top cover.
- 8 Return to your General Cabling Connections Procedure.

Multi*FRAD*TM 3000-Series

Router/Multiport Data/Voice/Fax
Frame Relay Access Device

Chapter 3 - Software Loading and Configuration

MultiTech[®]
Systems 

Introduction

This chapter will guide you through the installation and initial configuration of the MultiFRAD software included in your shipping box. [Chapter 4](#) will provide a more detailed description of the software and its features.

Loading your Software

The following loading procedure does not provide every screen or option in the process of installing the MultiFRAD software. The assumption is that a technical person is doing the installation and that a thorough knowledge of Windows and the software loading process is understood.

1. Run Windows on the pc connected to the Command Port.
2. Insert the MultiFRAD **Disk 1** diskette into the disk drive on the PC connected to the Command Port.
3. **Win3.1 users** - In Program Manager, click **File | Run**. In the **Run** dialog box, type **a:\setup.exe** or **b:\setup.exe** (depending on the letter of your floppy disk drive) in the **Command Line** field and then click **OK**.

Win95/98/NT users - click **Start | Run**. In the **Run** dialog type **a:\setup** or **b:\setup** (depending on the letter of your floppy disk drive) in the **Command Line** field and then click **OK**.

4. The Welcome screen is displayed.



Click **Next** to continue.

5. Follow the on-screen instructions to install your MultiFRAD 3000 software.

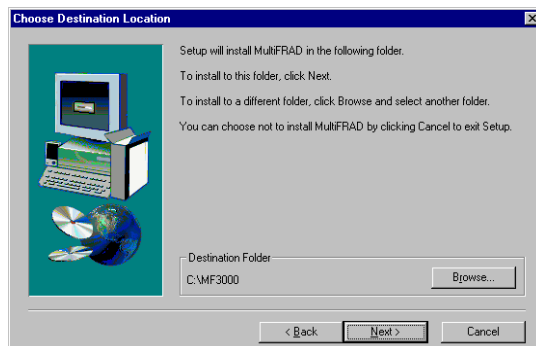

You can either choose the Destination Location of your MultiFRAD 3000 software or select the default destination by clicking **Next>**. If you click **Browse**, you can select a different destination folder for your MultiFRAD software; however, it is recommended that you accept the default folder **MF3000**.

6. The next dialog box enables you to name the Program Folder for the MF3000 files. You can select the default name, **MultiFRAD 3000**, or name it anything you like; when done, click **Next>** to continue.

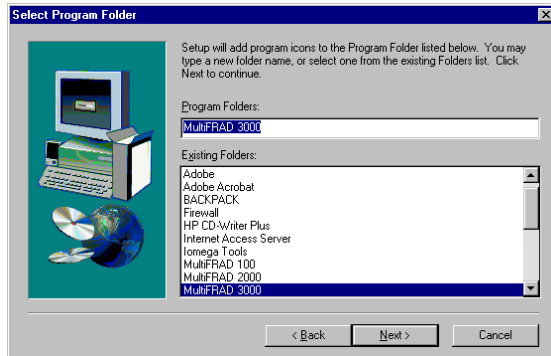

7. After all the program files from both disks are loaded, the Setup dialog box is displayed, enabling you to designate the COM port of your PC that is connected to your MultiFRAD. On the **Select Port** window, click the down arrow and choose the COM port of your PC (COM1--COM4). that is connected to your MultiFRAD.

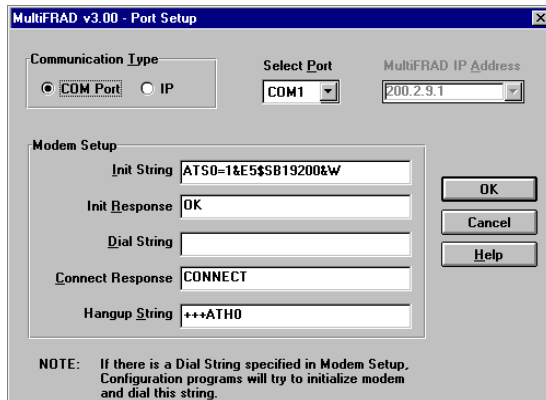

Click OK to continue.

8. The MultiFRAD 3000 software has been successfully installed, click **Finish** to continue configuring your MultiFRAD.

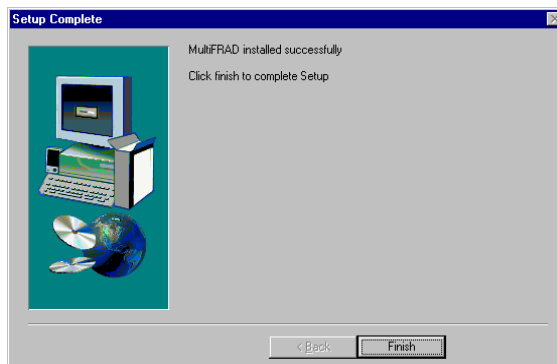

9. Do you want to download default setup? dialog box is displayed.

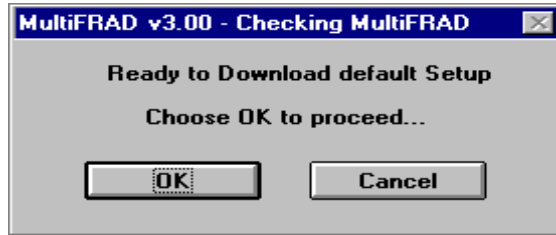

Click the **Yes** button to continue.

10. If your MultiFRAD is connected to a LAN and the network protocol is **IPX**, continue with the following steps (11 thru 14).

If your MultiFRAD is connected to a LAN and the network protocol is IP, click **IPX Routing Enable** check box to disable IPX, then click **OK** and proceed to step 15.

If no LAN is connected to the MultiFRAD, click **IPX Routing Enable** check box to disable IPX, then click **OK** and proceed to step 15 to disable IP protocol.

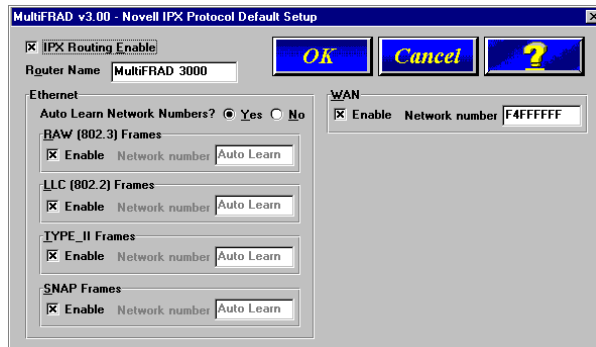

11. **MultiFRAD Name:** You can use the default MultiFRAD Name or assign a new MultiFRAD Name in this field. If you assign a new MultiFRAD Name, it must be a printable ASCII string of a maximum of 47 characters, a unique name on this network. The MultiFRAD name is used by the MultiFRAD to advertise its service in the IPX inter-network.
12. **Ethernet:** You can enable Auto Learn Network Numbers by leaving the default **Yes** or you can manually assign the network numbers by clicking **No** in the Auto Learn Network Numbers field.

If no file server is connected to the Ethernet segment, then this field should be **No**.

If you enable Auto Learn (**Yes**), the MultiFRAD will learn the IPX network numbers from the file server.

If you select **No** for Auto Learn, record the network numbers assigned by the network file server for each of the four frame types (Raw (802.3), LLC (802.2), EthernetII (Type II), SNAP) in the space provided below.

RAW (802.3) Frames Network Number _____

LCC (802.2) Frames Network Number _____

TYPE_II Frames Network Number _____

SNAP Frames Network Number _____

WAN Network Number _____

When you manually assign network numbers, you must make sure they match the network numbers assigned to your local file server (if any).

- WAN:** Enter the WAN network number for the Frame Relay WAN Port by clicking the Network Number box and backspacing through the default number and entering your new WAN Number. Make sure the WAN network number is the same as the MultiFRAD on the other end of the link.

The WAN network number has to be assigned by the Network Administrator and must be unique throughout the entire inter-network.

Note: The WAN port does not have the capability of learning the network number, unlike the LAN port (i.e., the WAN port does not have a file server).

- Click **OK** when you are satisfied with your selections.
- If your MultiFRAD is connected to an **IP** network, continue with the following steps (16 thru 21).

If no LAN is connected to the MultiFRAD, click the **IP Routing Enable** check box to disable IP protocol, then click **OK** and proceed to step 22.

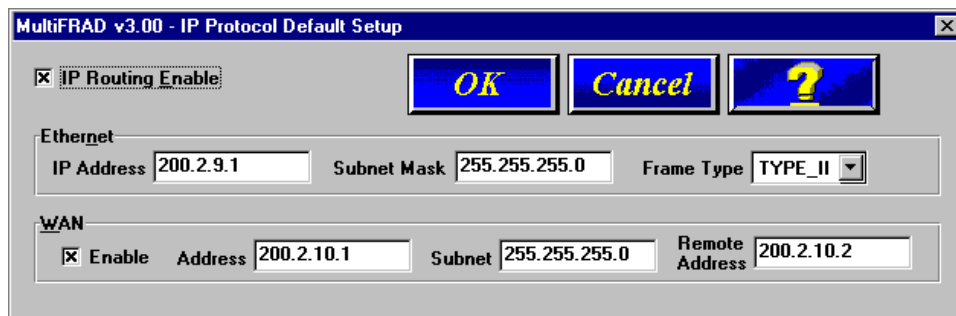

- Record the IP address protocol information for your specific network in the space provided below.

| Ethernet | | |
|---------------------|---------------------|---------------------|
| IP Address | Mask | Frame Type |
| ____.____.____.____ | ____.____.____.____ | TYPE II/SNAP |
| WAN Port | | |
| IP Address | Mask | Remote Address |
| ____.____.____.____ | ____.____.____.____ | ____.____.____.____ |

- The default Ethernet IP Address has to be changed to your unique LAN address. Enter an acceptable unique **IP address** for the Ethernet port.
- Change the default **Subnet Mask** and **Frame Type** to the values you have assigned to your LAN port.
- The default WAN Address has to be changed to your unique WAN address. Enter an acceptable unique **WAN Address** for the WAN port.
- Change the default **Subnet Mask** and **Remote Address** for WAN to the values you have assigned to your WAN.
- Click **OK** when you are satisfied with your selections.

22. If your MultiFRAD is going to be connected to a **frame relay network** with a **Synchronous** DCE device and **External Clocking**, click **OK** and proceed to step 23 to configure your data ports.

If your **Synchronous** DCE device in your frame relay network requires External Clocking from the MultiFRAD, click on **Internal Clock** and set your **Clock Speed**.

If your MultiFRAD is going to be used in a **Point-to-point configuration**, click **PPP/SLIP** and choose the **Mode** of the DCE device. If the mode is Asynchronous, then choose the **Connection Method**.

Then click **OK** to configure your data ports.

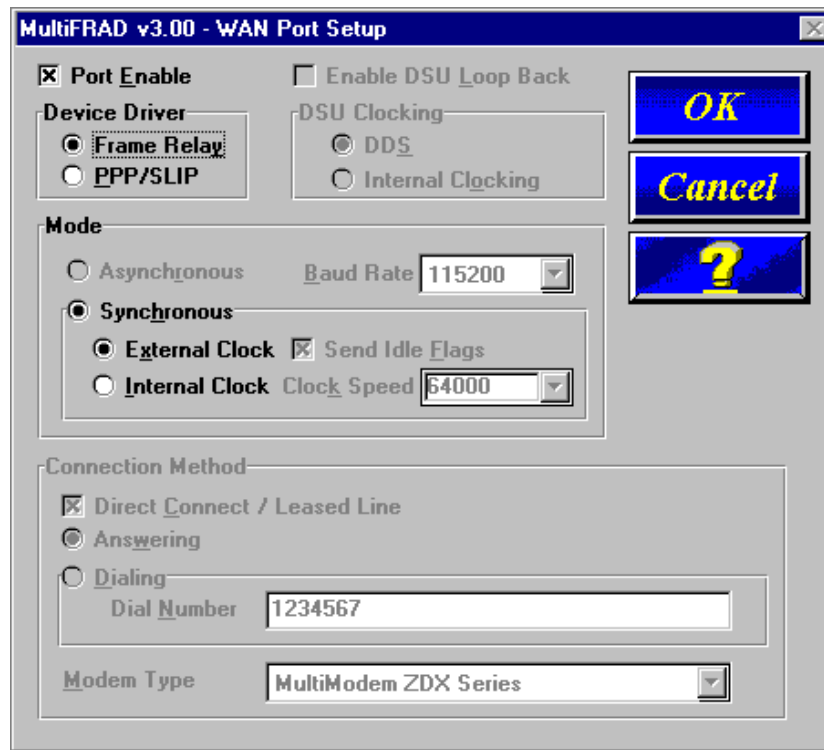

23. The Data Port Configuration dialog box allows you to configure the data channels for PPP/ Frame Relay, for data over the Internet, or as a Hub over a frame relay network. The Encapsulation Type group determines how the data channel is going to be configured.

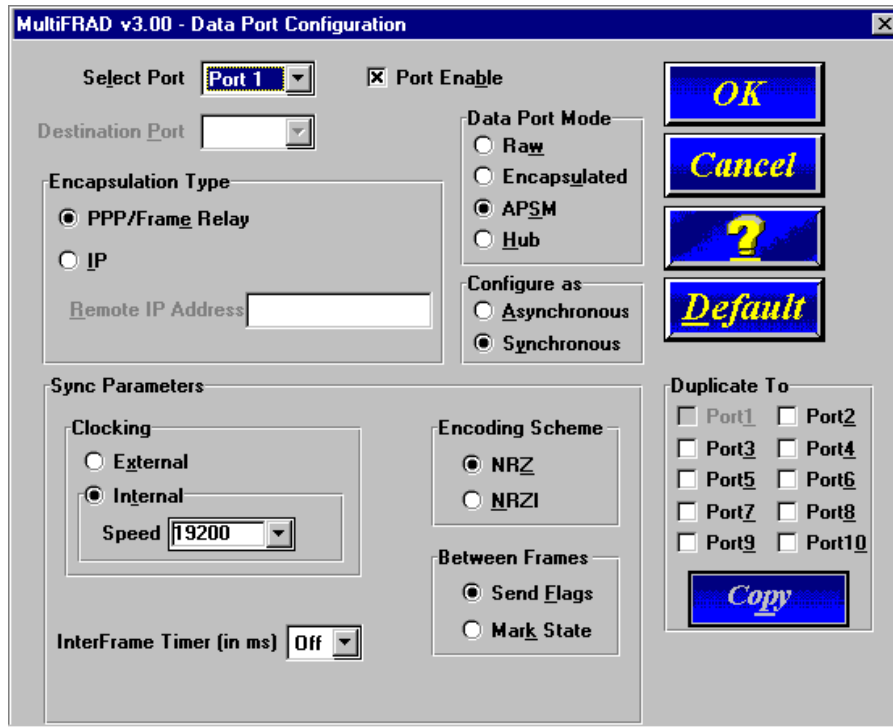

If your MultiFRAD is going to be connected to a frame relay network or point-to-point, then accept the default **Encapsulation Type** of **PPP/Frame Relay** option.

If your MultiFRAD is being configured for data over the Internet, then choose the **Encapsulation Type** of **IP** option. When the **IP** option is selected, the **Remote IP Address** field becomes active. Enter the IP address of the remote MultiFRAD.

The **Point-to-Point Protocol (PPP)** is used in serial links (asynchronous or synchronous) to transfer packets between two end-points.

24. If your MultiFRAD is going to be connected in a Point-to-Point configuration, then **Data Port Mode** is defaulted to **APSM** and all other modes are disabled.

If your MultiFRAD is being connected to a Frame Relay network (no LAN traffic) and each data channel is being mapped to its individual DLCI; then use the **Raw** option.

The **Raw** option is recommended when it is the only traffic being sent over a DLCI and the traffic is sync. Raw data has the least overhead and leaves the error correction to the upper layer of the protocol.

The **Encapsulated** option is recommended when a single synchronous data channel and LAN traffic are combined on a single frame relay DLCI.

The **APSM** option must be used when multiple data channels and/or LAN traffic are mapped to a single frame relay DLCI. **APSM** is recommended for asynchronous data, because it provides error correction. **APSM** is also the only Data Port Mode when data over the Internet (IP Encapsulation Type) is configured.

The **Hub** option is recommended when more than 10 data channels are needed per frame relay access. The Hub option connects a data channel to a virtual DSU/CSU which can be used to connect another frame relay access device to your frame relay service without adding another frame relay line.

25. If your data device is an **Asynchronous** device, then click the Asynchronous check box, and select the Baud Rate from the drop-down list. Also, select the Word Length, Parity, Stop Bits, etc. for your device. Refer to the user documentation for the parameters of the data device.

If your data device is a **synchronous** device, ensure that the clocking and, if an internal clock is used, the Speed is correct. Also, check the Encoding Scheme, Between Frames, and InterFrame Timer are correct for your channel device. Refer to user documentation for the parameters of the channel device.

26. After configuring a given channel, you can copy that channel's configuration to any of the other channels by selecting the desired channels in the "Duplicate To" group and clicking the **Copy** button.
27. Click **OK** when you are satisfied with your data port configurations. If you enabled PPP in the WAN Ports Default Setup dialog box, proceed to step 29.
28. If you enabled Frame Relay in the WAN Ports Default Setup dialog box, the Frame Relay DLCI Default Setup dialog box is displayed with all the groups inactive. Click **OK** to continue.

Your MultiFRAD will auto detect DLCIs and the frame relay management type when the unit is connected to an active frame relay network service. At this point your MultiFRAD is not communicating with the frame relay network. You should finish loading the software and then access the frame relay dialog box from the Main dialog box.

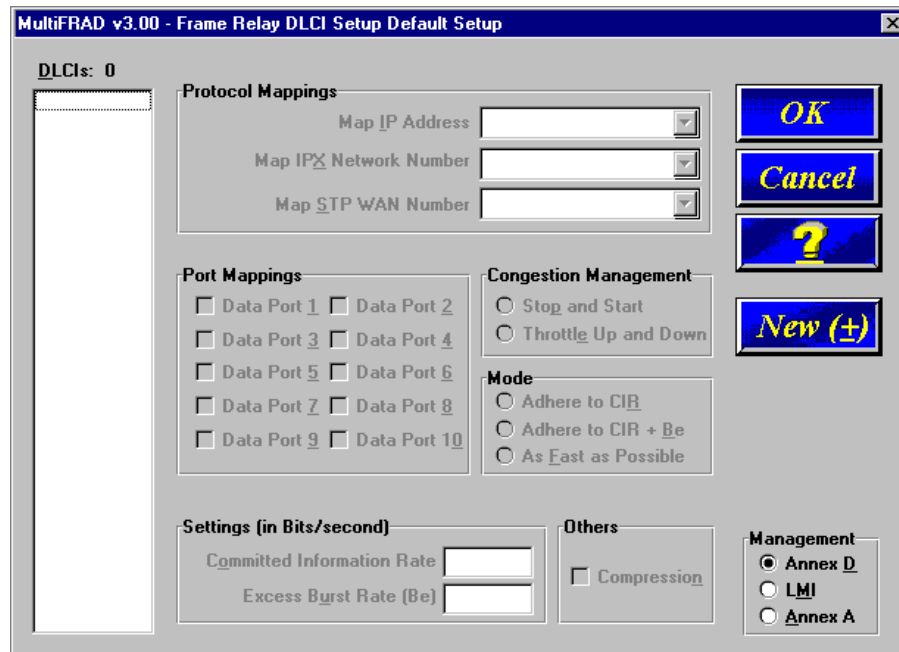

- 29 The **Voice/Fax Channel Setup** dialog box is displayed. The Channel Setup dialog boxes define the Voice/Fax channel interface, voice coder, fax parameters, and regional telephone parameters for each channel.



Configure each channel for the type of interface you are connecting to. The Interface tab defaults to **Channel 1** in the **Select Channel** group. To change the channel number, click the down arrow for the Select Channel and a drop-down list displays all the channels displayed. Highlight the channel number you want to configure.

30. The **Interface** group defaults to **FXS (Loop Start)**. Select the interface option to correspond to the interface type being connected to the Voice/Fax connector on the back panel of the MultiFRAD.

If you are connecting a station device; e.g., an analog telephone, fax machine, or KTS telephone system to the Voice/Fax connector on the back of the unit; **FXS (Loop Start)** will likely be the correct Interface option.

If the station device uses ground start, then choose the **FXS (Ground Start)** option. Refer to the device's user documentation.

If you are using an extension from your PBX, then choose the **FXO** option. Check with your in-house telephone personnel to verify the connection type.

If you are connecting to a trunk on your PBX, then choose the **E&M** option.

If you chose an **FXO** interface, then the Dialing Options Regeneration group is enabled. Check with your local in-house telephone personnel to verify whether your local PBX dial signaling is **Pulse** or tone (**DTMF**). Set the Regeneration option accordingly.

If you chose **E&M** interface, then the E&M Options group is enabled. Check with your local in-house telephone personnel to determine if the signaling is **Dial Tone** or **Wink** and if the connection is 2-wire or 4-wire. If Wink signaling is used, then the **Wink Timer** is enabled with a default of 250 milliseconds. The range of the Wink Timer is from 100 to 350 milliseconds. Consult with your local in-house telephone personnel for this timer setting.

If you want to dedicate a voice/fax channel to a point-to-point configuration; i.e., the device on a local channel will automatically call a specific channel on a remote MultiFRAD; click the **Auto Call Enable** option in the **Auto Call** group. Then enter the appropriate DLCI in the **DLCI Number** field. Change the **channel** number to the channel of the remote MultiFRAD you want to call.

Enabling the Auto Call feature means that this channel does not have to be entered in the Phone Directory Database.

31. **Duplicate to Channels** group will copy the selected configuration to other voice/fax channels. Click on the channel number(s) and click **Copy** button.
32. When you are satisfied with your interface choices, and if the default voice coder is acceptable and your country/region is the default USA, then you can click **OK** and continue building your phone directory data base.

If you need to change the voice coder, click the Voice/Fax tab and proceed to step 33.

If your country/region is not the default USA, then click the Regional tab and proceed to step 34.

33. To change the voice coder, first select the channel by clicking the **Select Channel** down arrow and highlighting the channel number, then click the **Voice Coder** down arrow and highlight your new voice coder.

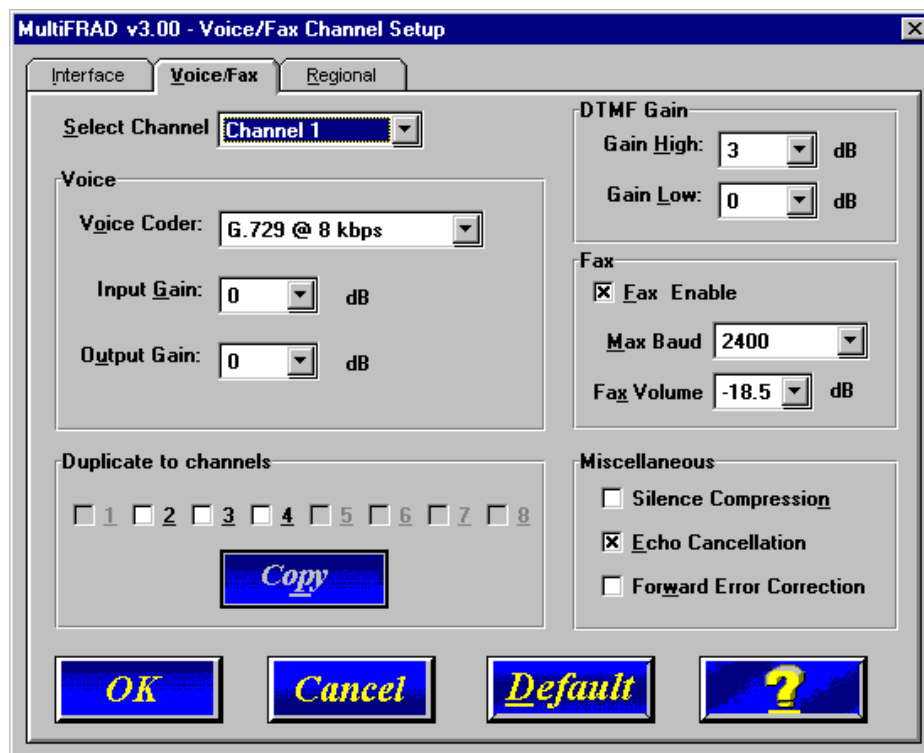

If you change the voice coder selection, ensure that the same voice coder is used on voice/fax channels communicating with each other. Voice/fax channels can use different voice coders; however, a channel using one voice coder can not connect to a channel using a different voice coder.

Duplicate to Channels group will copy the selected configuration to other voice/fax channel. Click on the channel number(s) and click **Copy** button.

34. To change the call progress signaling for your **Country/Region**, click the down arrow and highlight your specific country or region.

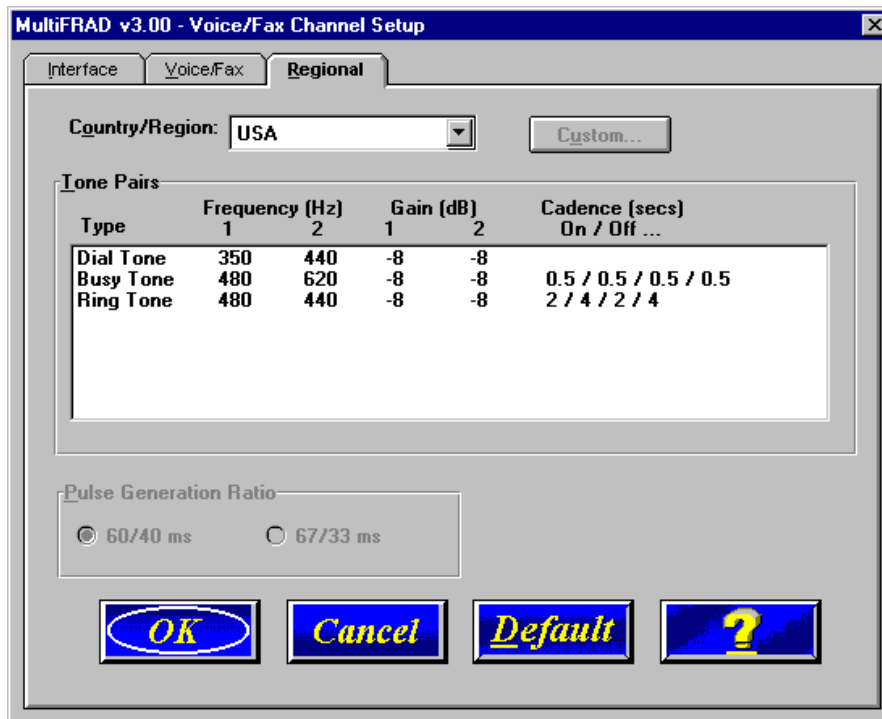

The Tone Pairs parameters change per your choice. Click **OK** to continue to building your phone directory database.

35. The **Checking MultiFRAD** dialog box is displayed.

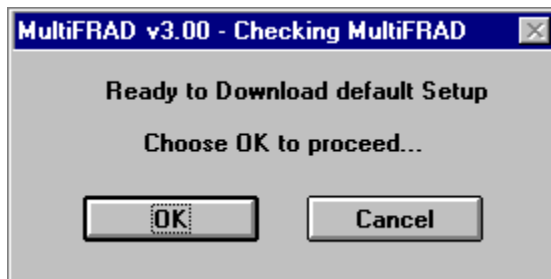

The Setup utility is "Ready to Download default setup Choose OK to proceed." Click **OK** to proceed.

36. **Writing Setup** dialog box is displayed as the setup configuration is written to the MultiFRAD.

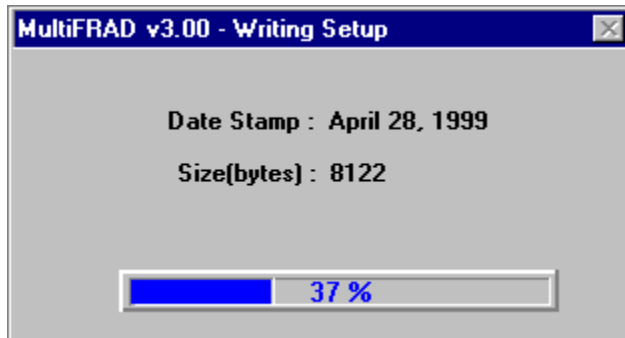

37. After writing setup to the MultiFRAD, the unit is rebooted.

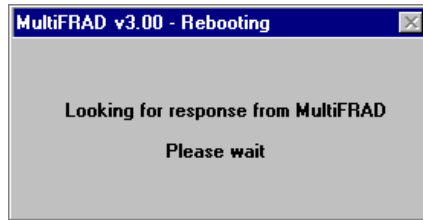

38. During reboot, the **BTG** (Booting) LED will be on. Wait for the **BTG** LED to go off. This could take up to 90 seconds for the BTG LED to go off.

39. **Win3.1 users** - you are returned to your Program Manager where the MultiFRAD Program Group and Program Item (Windows icons) have been created.

Win95/NT users - you are returned to your MultiFRAD 3000 folder which will be visible on your desktop.

40. To map the detected DLCIs to your data ports and protocols, proceed with the following steps:

Win3.1 users - from the Program Manager, double-click the **MultiFRAD Configuration** icon in the MultiFRAD 3000 Program Group. The main Setup dialog box is displayed.

Win95/98/NT users - from your desktop, highlight Programs, MultiFRAD 3000 folder, and then click **MultiFRAD Configuration**.

The Setup dialog box is displayed.

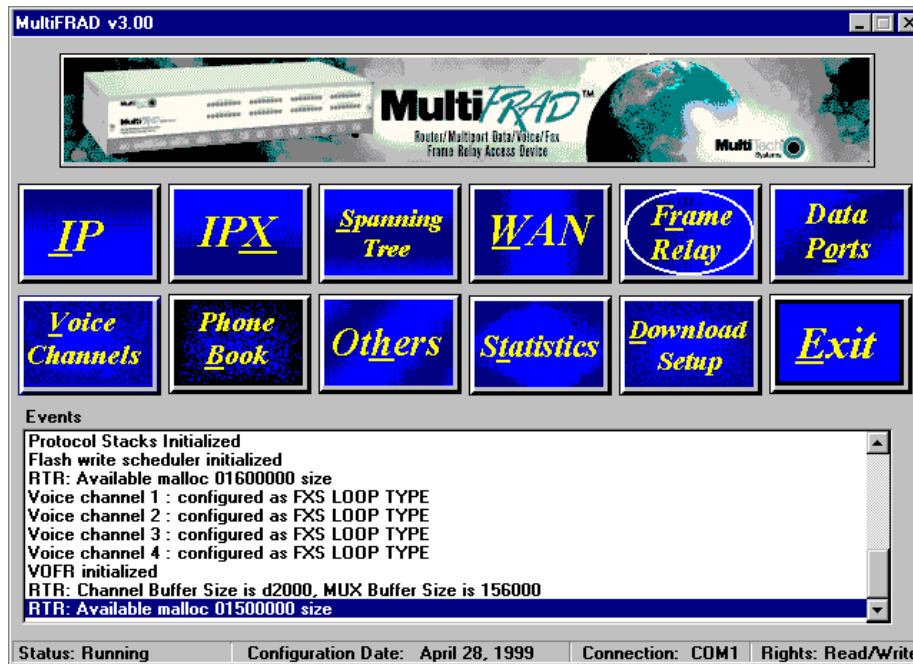

Detect and Map Your DLCIs

41. From the Setup dialog box, click the **Frame Relay** button.

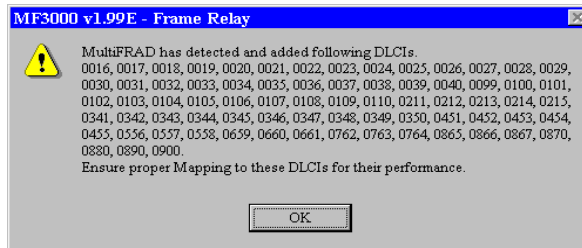

42. A Frame Relay dialog box stating “MultiFRAD has detected and added following DLCIs” is displayed. Click the **OK** button.
43. A second Frame Relay dialog box may be displayed, stating “MultiFRAD has detected Management Type to be Annex A”. The Management Types are Annex A, Annex D, or LMI. Any one could appear in this dialog box.



44. Click **OK**, the Frame Relay Setup dialog box is displayed.

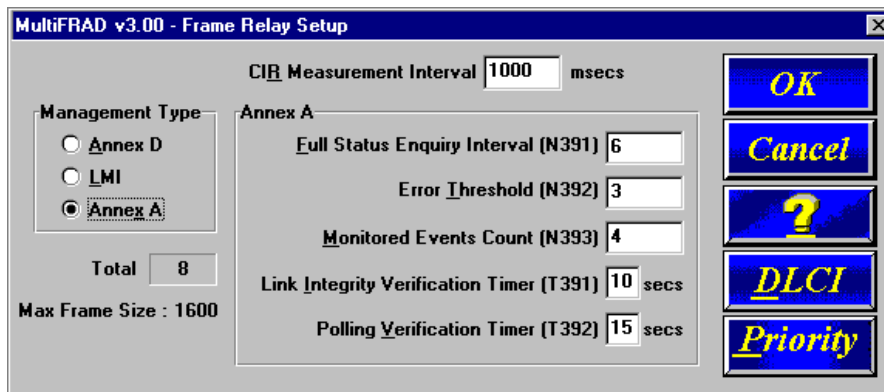

45. Click the **DLCI** button to display the Frame Relay DLCI Setup dialog box.

46. The Frame Relay DLCI Setup dialog box displays a number of DLCIs in the DLCI dialog box window. In the example, the Total DLCIs window shows 8 DLCIs detected by the Frame Relay network.

Click a DLCI that you want to map. The Protocol Mappings, Port Mappings, and all the other groups become active.

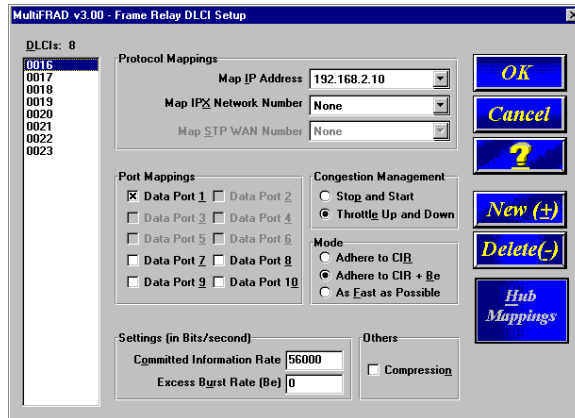

47. If a Network Protocol was enabled during the loading of the software, the protocol mapping is activated. To map a Protocol Stack to a DLCI, click the Protocol Stack's down arrow. A listing displays None and your IP WAN address and/or IPX network number. Choose the address or network number you want to map to the selected DLCI.
48. To map a data port to this DLCI, click on the data port number(s) in the **Port Mappings** that you want to associate with this DLCI.
49. Ensure that **Throttle Up and Down** in the **Congestion Management** category is selected.
50. Ensure that **Adhere to CIR + Be** check box in the **Mode** category is selected. Multi-Tech recommends this setting initially.
51. Click the **Committed Information Rate** numeric box in the **Settings (in Bits/second)** category and enter the CIR value provided by your service provider at subscription time for this DLCI.
52. Click the **Excess Burst Rate (Be)** numeric box in the **Settings (in Bits/second)** category and enter the Be value provided by your service provider at subscription time for this DLCI.
- The **Compression** option in the Others group may be useful at low link speeds (speeds up to 56Kbps). With a high speed link (above 56Kbps), Multi-Tech recommends not using this feature.
53. Repeat steps 47 through 52 for each detected DLCI to map it to its associated protocols and ports.
54. Click the **OK** button when you are satisfied with your selections.
55. The Frame Relay Setup dialog box is displayed.

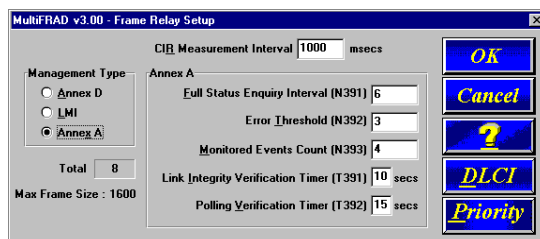

Click **OK**.

56. The Setup menu is displayed.

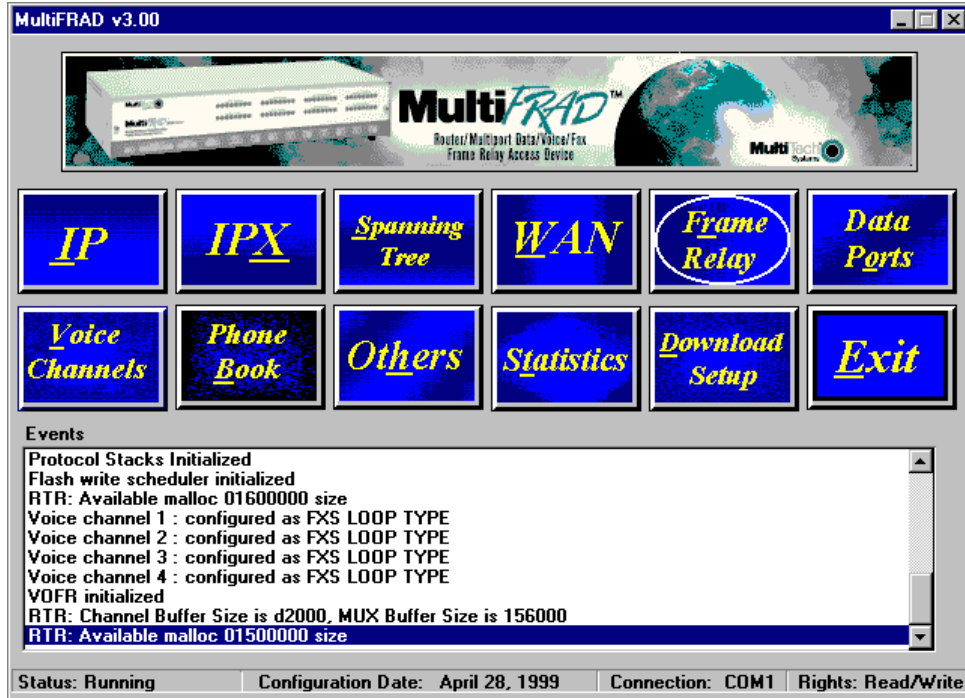

Build Your Phone Directory Database

Perform the following steps to construct your phone directory database.

57. Click **Phone Book** on the main menu. The **Phone Directory Database** dialog box is displayed. You will build your personalized MultiFRAD Phone Directory in the following steps.

The completed database will contain the telephone numbers, associated descriptions, DLCI numbers, and channels for all the MultiFRAD's available for communication on the internetwork.



The Add (+), Delete (-), and Edit buttons are active, enabling you to start building the phone directory database that will control the calls.

58. Click **Add** to begin building your phone directory database. The **Add/Edit Phone Entry** dialog box is displayed.

In the **Station Information** group, enter a unique phone number in the Phone Number field for one of the remote voice/fax channel you will be calling. For example, telephone number 101. This telephone number does not have to be a standard number of digits (7).

The **Description** field for your local phone number is optional. In the following example, we describe the phone number as, "Jerry's Desk."

The **Voice Channel** field defaults to Channel 1. To change the channel number, click the down arrow and highlight desired remote voice/fax channel number.

The Permit Hunting option enables a call to roll over to an available channel on the remote FRAD if the first channel is busy. Click on **Permit Hunting** if you want to roll over to another channel.

If there is no direct PVC, such as between two remote sites, you will need to click to check **Enable Routing** to assure that such calls will go through.

The DLCI field defaults to the number 16, which can be changed by selecting it and typing the desired number. (We are using DLCI number 20 in this example.)

59. Click **OK** and you are returned to the **Phone Directory Database** dialog box, which now displays the phone number 101 in the **Station Phone Number** list and your other information in the **Station Information** group.

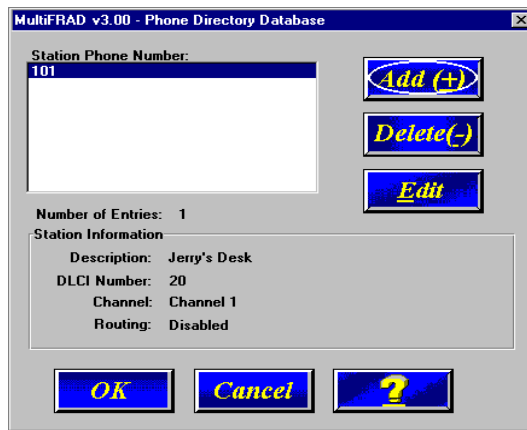

60. Repeat steps 58 thru 59 for each additional phone number. You should enter one phone number for each remote channel that is enabled. When finished, click **OK**.
61. The Main menu is displayed.

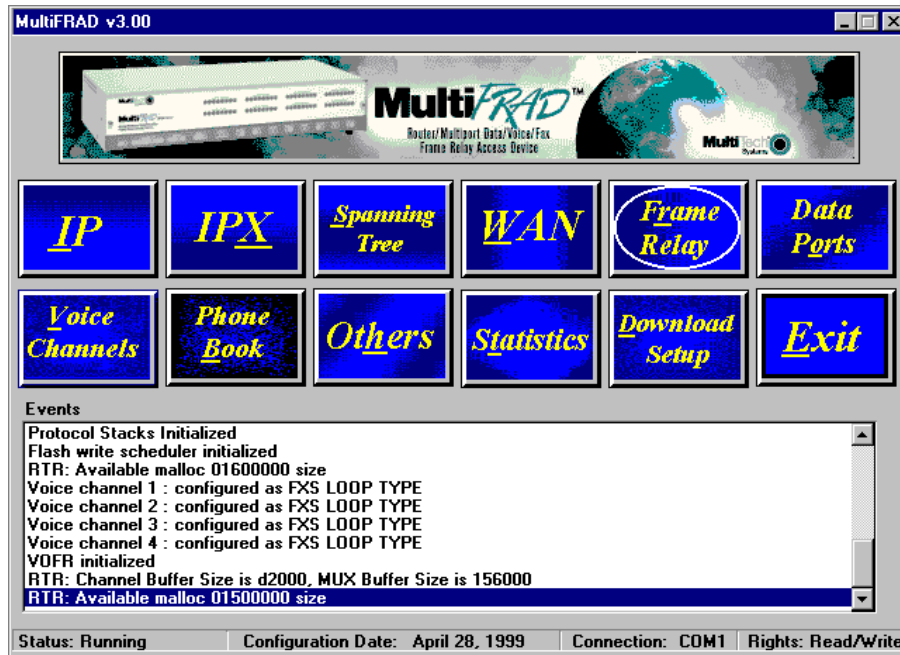

Click **Download Setup**.

62. The "Save Current Setup as User Default Configuration" is displayed. MultiTech recommends that you click the check box to save the user default configuration.

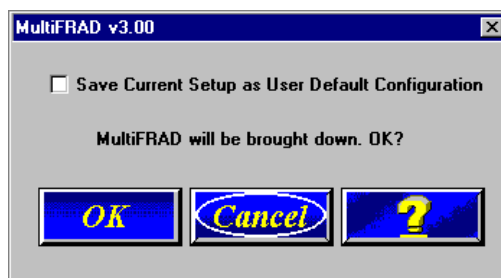

Click **OK** to continue.

63. The Writing Setup dialog box is displayed as the setup configuration is written to the MultiFRAD.

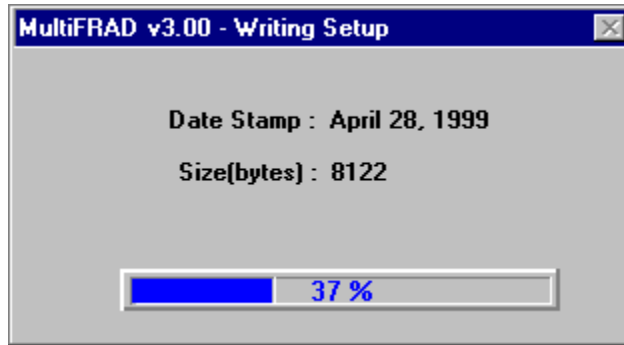

64. After setup is written to the MultiFRAD, the unit reboots.

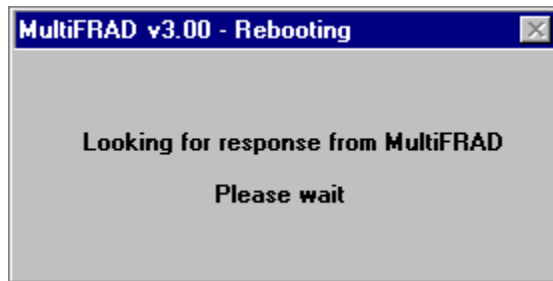

65. During reboot, the **BTG** (Booting) LED will be on. When the **BTG** LED goes off, you are returned to the Main menu.

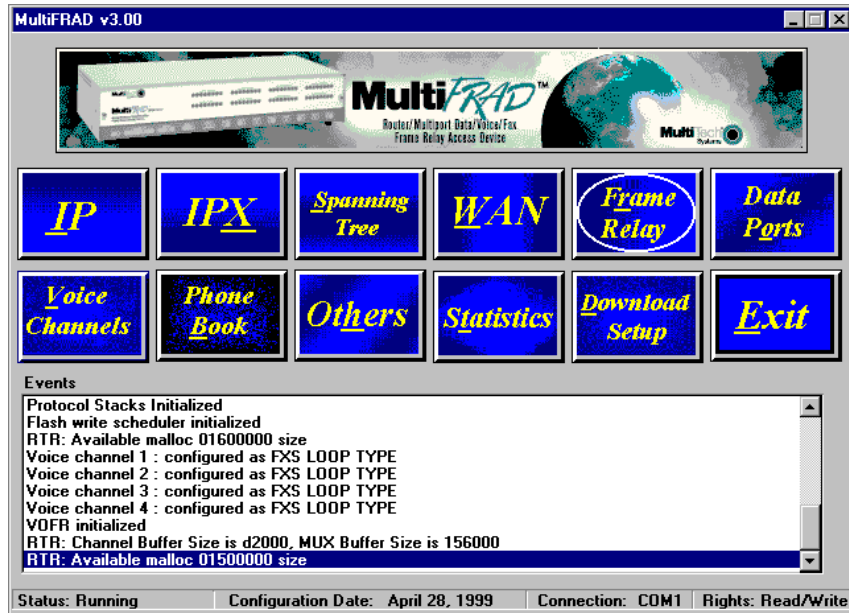

Your MultiFRAD is operational at this time.

MultiFRADTM 3000-Series

Router/Multiport Data/Voice/Fax
Frame Relay Access Device

Chapter 4 - MultiFRAD Software

MultiTech[®]
Systems 

Introduction

This chapter describes the MultiFRAD software with the intent to show you how to make changes to the configuration of your MultiFRAD. The major configuration parameters were established during the loading of the software ([Chapter 3](#)), and the MultiFRAD software and configuration utilities allow you to make changes to that initial configuration.

The MultiFRAD software allows you to refine your configuration based on your network connections. The software is based on a main menu (MultiFRAD Configuration) that allows you to consider all the parameters for a particular feature (e.g., data ports and voice channels). These features, along with others are discussed in detail in the MultiFRAD Configuration section later in this chapter.

The other six configuration utilities offer additional functionality. *Download User Defaults* utility allows you download your default settings, configured during the loading of the software. If you have made changes to your configuration and wish to revert to the default setup, you can do so through this utility. *Download Factory Defaults* utility allows you to sequence through the software loading sequence and change any previous installation parameters. The *Download Voice Coders* utility allows you to download voice decoders which may also be necessary during repair or upgrade. The *Configuration Port Setup* utility allows you to change the method by which you access the MultiFRAD (i.e., direct connection of a PC to the Command Port on the MultiFRAD, or via your Internet connection to the LAN port on the MultiFRAD). *Download Firmware* allows you to download new versions of firmware when enhancements become available. The *Uninstall MultiFRAD Configuration* utility is designed to remove the software from your PC.

Your MultiFRAD software includes the MultiFRAD Help system. The Help menus define each button, option, field, and recommend values where applicable. The Help menus are a dynamic help system which provides information corresponding to the active dialog box.

Before You Begin

The MultiFRAD software operates in a Microsoft Windows® environment. Your MultiFRAD program group contains all of the utilities described above, and is accessible in Windows by clicking **Start | Programs | MultiFRAD | (utility)**, or by double clicking on the utility icon in the program group in My Computer. The program group is shown here:

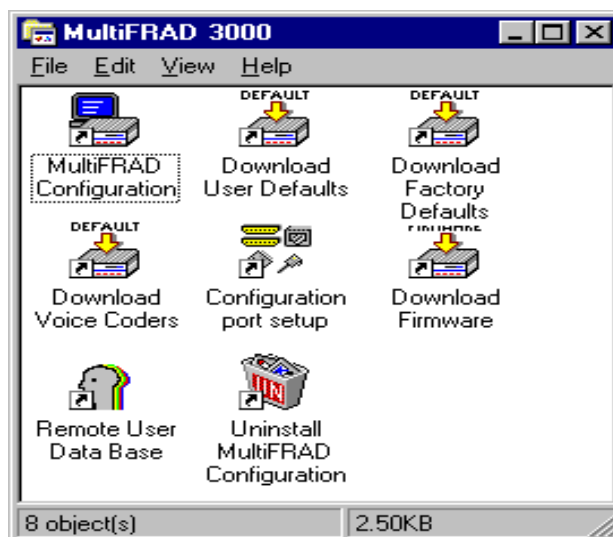

MultiFRAD Configuration

The MultiFRAD 3000-Series Setup menu consists of 12 buttons in which you can point and click, an Events window in the middle of the menu, and a status bar at the bottom of the menu. The 12 buttons allow you to display and change the protocol stacks, statistics, WAN port setup, Frame Relay parameters, data port configuration, enable applications such as SNMP Agent, Telnet Server, WEB Server, and assign a MultiFRAD password.

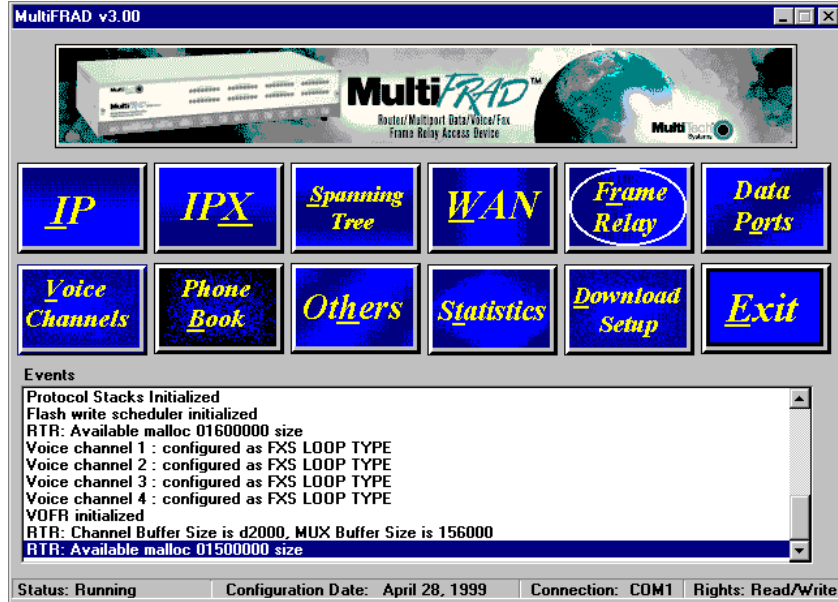

The Events window, in the center of the dialog box, provides information about the boot process and ongoing information regarding the status of “events” such as the type of frame relay management selected and which PVCs become active. It can be a useful tool in times of troubleshooting.

The status bar at the bottom displays the status of the unit, e.g., Running, the date that the unit was configured, the type of connection on the command port, e.g., if the pc connected to the command port is using its serial port to communicate with the MultiFRAD or if the pc is communicating with the MultiFRAD via an Ethernet connection. The last field on the status bar is the Rights field, which displays either Read/Write or Read only rights. The first user to communicate with the MultiFRAD has Read/Write rights. This enables the first user to change the configuration of the MultiFRAD. A second user has read only rights which means they can only view the configuration of the MultiFRAD.

If your WAN port is configured for frame relay, then the button to its right is Frame Relay. If your WAN port is configured for Point-to-Point, then the button to the right is PPP.

Changing IP Parameters

The IP Setup dialog box allows you change the IP routing capabilities, add or delete logical WANs, enable the DHCP relay agent, assign DNS address, and define default and static routes. The initial routing capabilities were established during the software installation. You can change IP routing parameters by clicking on the Advanced tab and changing, for example, the RIP Response Time or RIP Route Aging Time. The WAN tab allows you to change the WAN port IP address, the remote address, and if logical WAN ports are being added for frame relay, you can add them by clicking on the Add button.

The Ethernet IP Setup dialog box displays the parameters for your Ethernet port with the IP Address established during the initial loading of the software. The **Ethernet**, and **WAN** tabs allow you to configure parameters for the selected port. Although these tabs all contain the same option groups, certain parameters may be inactive or disabled (grayed-out) when they do not apply to the selected port.

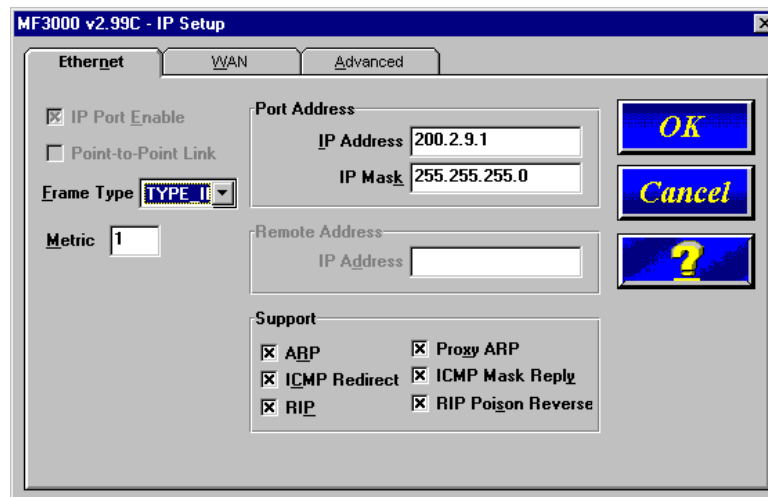

The net mask specifies the network or subnet portion of an IP address. The net mask is a 32-bit value presented in a dotted decimal notation.

The **Frame Type** option defines the MAC layer frame encapsulation to be used for IP transmissions from the specified port. The Ethernet port supports Type II and SNAP frames, but the WAN ports support only Type II frames.

In the **Support** group, **ICMP Redirect** defines if the specified port is permitted to issue an ICMP Redirect message to the source IP address. The most likely cause of this message is the delivery of a datagram to a MultiFRAD that is not on the forwarding path to the destination address. This is often due to a wrong configuration of the IP client sending the datagram. The packet causing the ICMP Redirect message to be transmitted is forwarded to the appropriate MultiFRAD.

ICMP Mask Reply enables support for nodes on the connected networks to learn their subnet masks.

RIP enables RIP based routing on the specified port, and is normally enabled. However, RIP can be disabled if you are using the WAN link in Dial-on-Demand mode. Disabling RIP will reduce traffic on the link as this will also disable periodic RIP broadcasts. RIP routing on the port will be automatically turned off when Dial-on-Demand is enabled in PPP port setup.

Finally, the **RIP Poisoned Reverse** option defines if Poisoned Reverse RIP messages are supported on the specified port. Generation and processing of poisoned routes (RIP entries with their respective metric set to 16 (defined as infinity)) is enabled/disabled by this parameter. Poisoned reverse is a method used by RIP to improve the rate of convergence of the routing tables of interconnected IP MultiFRAD. MultiFRADs supporting poisoned reverse that receive such RIPs ignore the entries set to 16 and thus prevent the propagation of unnecessary (and often incorrect

when a topology change occurs) information which in turn speeds up the rate at which RIP will correctly map the current network topology.

From the Ethernet IP Setup dialog box you can switch to the WAN IP Setup dialog box or the Advanced IP Setup dialog box.

The WAN IP Setup dialog box allows you to disable or enable IP routing on the WAN port, change the port IP Address, mask, and remote IP address. If the WAN port is configured for frame relay, this dialog box allows you to add logical WANs. How the logical IP WAN ports are configured is controlled by the WAN Port Setup dialog box.

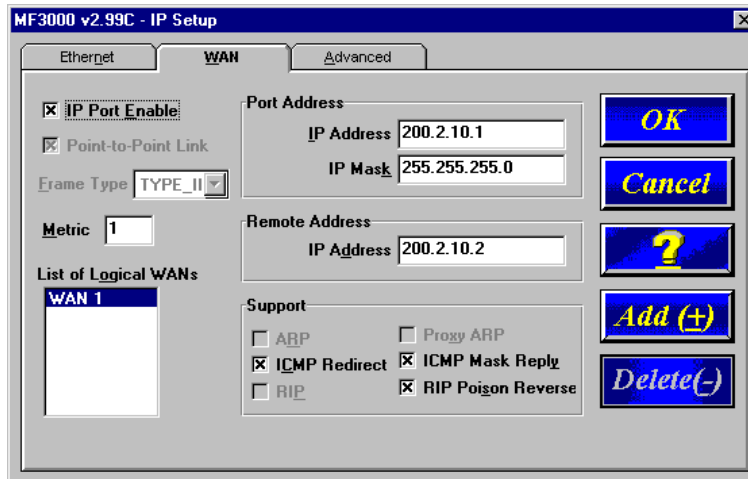

To add logical WAN in a frame relay configuration, click the Add(+) button and the next WAN number is displayed in the List of Logical WANs window on the left side of the WAN dialog box. To delete the selected logical WAN, click the Delete (-) button.

The **Remote Address** defines the IP address for the destination end of a point-to-point link and is necessary only if the selected WAN port has been enabled. Note: the remote IP address must fall within the same IP network as the local IP address.

The **Advanced** tab controls IP Routing, RIP, timers, Dynamic Host Configuration Protocol (DHCP) and Domain Name System (DNS) servers, default route, filters, and Static Routes. The options that you select here apply to all ports on which IP routing takes place.

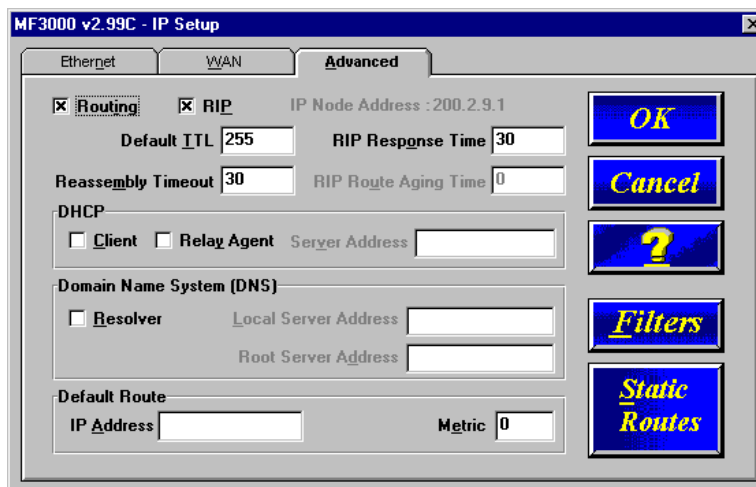

In most cases, you should not have to change any of the timers (i.e., default TTL, reassembly timeout, RIP response time and RIP route aging time). The DNS Resolver is supplied for remote Telnet clients when the MultiFRAD is configured for remote access and the terminal server application is enabled.

The **Routing** option is normally checked; however, if you do not wish to have IP packets routed, then uncheck this item. If IP routing is disabled and bridging is enabled, IP packets are bridged; i.e., IP packets are transferred.

The **RIP** option enables RIP based routing. RIP (Routing Information Protocol) is a protocol used among MultiFRADs to exchange routing table information. RIP is the most common protocol used in both IP and IPX networks. It is also used internally by client workstations in IPX networks to obtain routes (shortest, or otherwise) to any distant network. RIP based routing should normally be enabled. It can be disabled, however, if you are using WAN links in Dial on Demand mode. For DOD links, disabling RIP will reduce traffic on the link as it will also disable periodic RIP broadcasts. RIP routing on a given port will be automatically turned off when Dial on Demand is enabled on the PPP Port Setup tab for the WAN port.

The **Default TTL** text box defines the IP Time-To-Live parameter that sets the maximum number of hops a frame may travel before being dropped. This is used to limit errant frames such as those that may arise under circularly defined networks. Recommended value is decimal 255.

The **RIP Response Time** text box defines the time interval between periodic RIP broadcasts. Regular RIP broadcasts are required to keep the routing tables of all MultiFRADs in the internetwork consistent. Increasing the frequency of these broadcasts may consume precious bandwidth that could have been used for transfer of other regular packets and has a recommended value of 30 seconds.

The **Reassembly Timeout** text box defines the amount of time the IP routing software will wait for all the fragments of an IP datagram to arrive before discarding the partially reassembled datagram and has a recommended value of 30 seconds.

The **RIP Route Aging Time** text box defines the time interval that must expire before an unused route entry created by RIP is aged from the route table. The aging timer starts from the addition, reference, or change of an RIP based routed entry and has a recommended value of 180 seconds.

The **Dynamic Host Configuration Protocol (DHCP)** group is not supported on this product.

The MultiFRAD supports **Domain Name System (DNS)** group is not support on this product.

The **Default Route** group defines the default route for the MultiFRAD. The IP Address field specifies the full 32-bit IP host address of the next hop for packets being forwarded via default routing. The MultiFRAD will automatically resolve the IP address to a port number via its IP route table. The Metric defines the number of hops to the specified IP address and is typically set to a value of 1. If the default route is for an unnumbered link, select the port from the **Port** combo box. Finally, whenever you set up default routing, be sure to disable RIP based routing.

The **Static Routes** button displays a dialog box that enables you to view, add, edit, or delete static routes to a target IP address (which can be the address of an IP host, an IP network, or an IP subnetwork). You must specify the target host IP address and the Gateway Address in dotted decimal form. The Gateway Address is the IP address of the MultiFRAD that is the next hop toward the target host. The address mask is the subnet mask of the target IP host, and the Metric is the hop count to the target host or subnet and can be either 0 or 1.

Changing IPX Parameters

The IPX Setup dialog box controls the four frame types, the WAN ports setup, and the advanced tab enables IPX routing, auto learn of Ethernet network numbers, and the distributed name of the MultiFRAD.

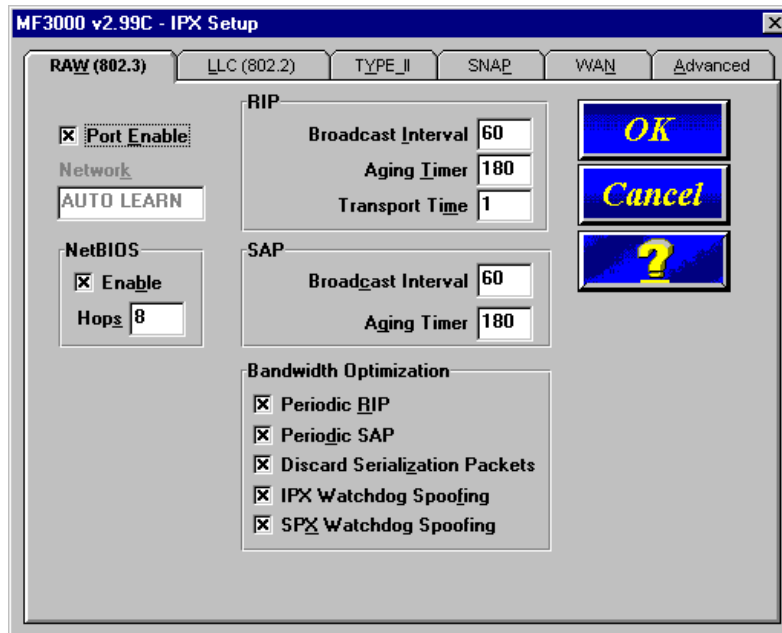

In IPX based networks using Ethernet, LAN segments can support the use of four different Ethernet frame formats over the same physical link (provided each frame type has a unique network address as a virtual port).

NetBIOS, when enabled, enables the transport of Novell encapsulated NetBIOS packets on the specified virtual IPX port. Refer to Novell documentation regarding NetBIOS operation over NetWare based LANs. The Hops text box defines the distance, in hops, for the routing of Novell encapsulated NetBIOS frames on the specified virtual IPX port, and the recommended value is 8.

For most applications, the **RIP** and **SAP** default timers should not have to be changed. Under certain circumstances, disabling IPX and SPX Watchdog Spoofing in the Bandwidth Optimization group has proven effective.

Periodic RIP (Routing Information Protocol) refers to broadcasts transmitted from the RIP virtual IPX port at a given frequency so all MultiFRADs on the internetwork maintain consistent routing tables. Increasing the frequency of RIP broadcasts can consume excessive bandwidth, especially on low-speed WAN links. Sixty seconds is the recommended interval between RIP broadcasts.

Periodic SAP (Service Advertisement Protocol) is used in IPX based networks to allow servers (application servers, file servers, print servers, communication servers, etc.) to advertise their presence on the internetwork. MultiFRADs use these advertisements to build up tables listing the servers so they can then advertise these servers on the local segments and provide MultiFRADs to the server. Client workstations can request a list of these servers from the MultiFRAD.

Discard Serialization Packets, when enabled (checked), causes the IPX MultiFRAD to discard Novell NetWare File Server serialization security frames received from the specified virtual IPX port. Novell NetWare File Servers implement broadcast frames, often referred to as security frames, that contain serialization information regarding the license of the file server executable. This feature permits filtering of these broadcasts to help reduce WAN traffic and is not intended to interfere with copyright protection mechanisms. This feature is automatically turned on when Dial-On-Demand is enabled in PPP port setup.

The IPX WAN Setup window allows you to enable or disable IPX routing on the WAN port, change the network number for the WAN port, change the default RIP and SAP timers, and optimize the bandwidth. The IPX WAN network number has to be the same on both ends of the link and must be unique throughout the internetwork. If a WAN port is configured in a point-to-point operation, both WAN network numbers have to be the same and unique.

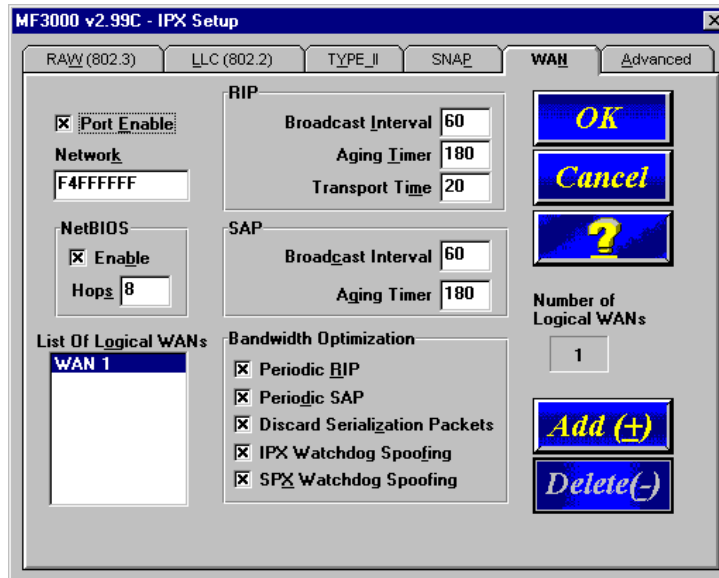

If there is a server on the local segment, then IPX network number auto learn should be enabled. If there is no server, or if for some reason the MultiFRAD comes up before the server does, the MultiFRAD will default to some random network numbers after a short period of time.

The IPX WAN network number has to be the same on both ends of the link and must be unique throughout the internetwork. If the WAN port is configured in a point to point configuration, both WAN network numbers have to be the same and unique. If the WAN port is configured in a frame relay configuration, both virtual WAN numbers have to be the same and unique. In a frame relay configuration, the logical WAN network number has to be the same and unique at both ends of the Permanent Virtual Circuit (PVC).

The Advanced IPX Setup dialog box controls the routing of the protocol and auto learn of Ethernet network numbers, defines the broadcast name of the MultiFRAD, and IPX filtering.

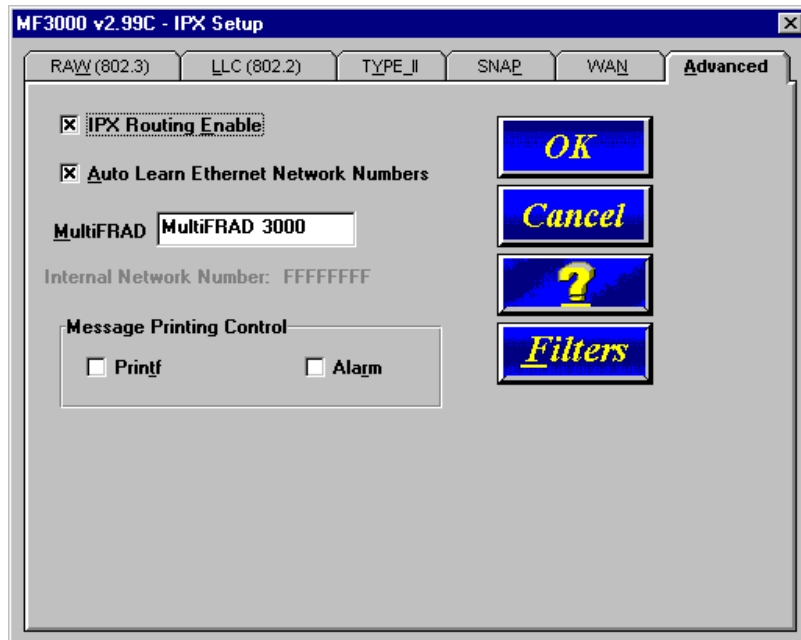

If bridging of IPX packets is desired, IPX routing must be disabled and frame type support for the frame type must be enabled.

If there is a server on the local segment, then IPX network number auto learn should be enabled. If there is no server, or if for some reason the MultiFRAD comes up before the server, the MultiFRAD will default to some random network numbers after a short period of time.

Changing Bridging Parameters

The Spanning Tree Setup dialog box controls transparent bridging when the Bridging option is enabled. If there are any loops or redundant links in the internetwork, then Spanning Tree Algorithm option must be used. Spanning Tree is a method of transparent bridging, as opposed to source route bridging which the MultiFRAD does not support.

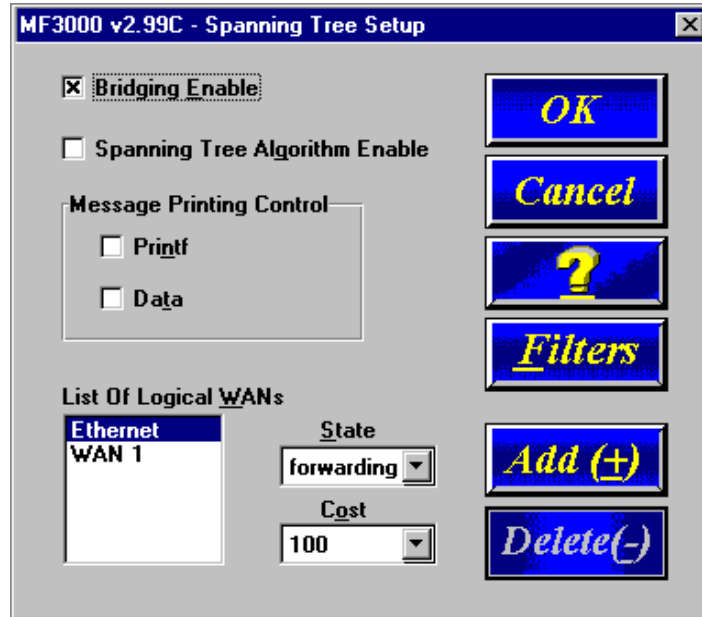

The MultiFRAD defaults with one logical WAN port. It is not necessary to map this port to a DLCI; however, care should be taken if additional logical WANs are created. Additional WANs will default to a disabled state. If they are to be used, they must be mapped to a DLCI. In most applications, the forwarding state should be enabled on the first logical WAN and blocking should be set on any additional WANs. The MultiFRAD will make the transition from blocking to forwarding automatically when it is required.

WAN Port Setup

The WAN Port Setup dialog box controls how the port is configured (i.e., frame relay or point-to-point). If the WAN port is configured for frame relay, then the mode of the port is synchronous. If the port is configured for point-to-point, then the mode can be either synchronous or asynchronous. If the mode is asynchronous, then the connection method can be either answering or dialing. If the connection method is dialing, then a number to be dialed has to be entered in the dial number field and the modem type chosen in this field.

If the Frame Relay Device Driver is chosen, the MultiFRAD encapsulates data on its composite link for transmission over a frame relay network. Enabling this device driver requires additional frame relay configuration by choosing the Frame Relay button in the Main Menu.

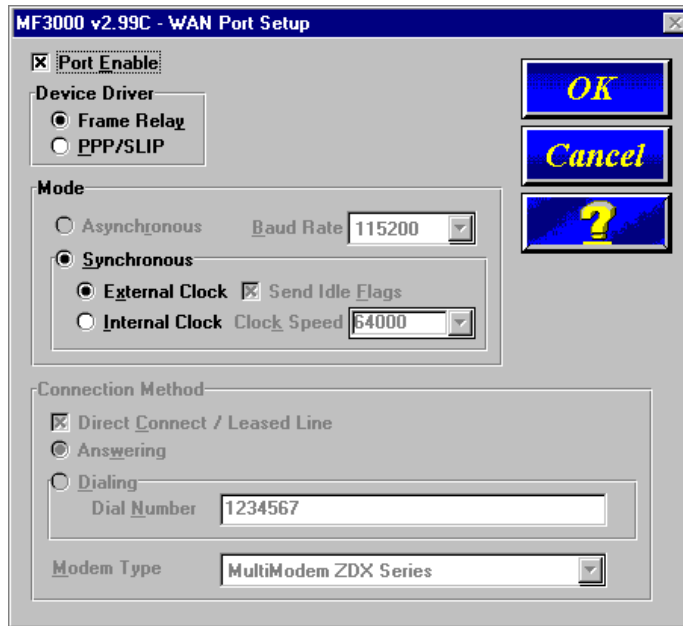

If the PPP/SLIP mode is chosen, the MultiFRAD is configured for a point-to-point configuration which allows for communication between two sites without using a frame relay network. Enabling this device driver allows for either an asynchronous or synchronous device to be connected between two sites. If an asynchronous device is chosen, the Asynchronous Mode is enabled and the Baud Rate needs to be set. When the Asynchronous Mode is enabled, the Connection Method group is activated with the Direct Connect/Leased Line and Answering options enabled. If the Asynchronous device is using a dial up connection, and you are initiating the communications, you need to enable the Dialing option and enter the number to be dialed in the Dial Number field.

Point to Point Setup

The Point to Point Setup dialog box controls the WAN port protocol, dial on demand, and remote port setup. The WAN port protocol can be either Point to Point Protocol (PPP) or Serial Line Internet Protocol (SLIP). PPP is the more robust of the two protocols in that it allows the end-points to negotiate use of the link and protocol parameters in a standardized way and also allows for standardized encapsulation of the packets. SLIP is an older protocol and requires manual authentication using a script.

Note: At this time, the MultiFRAD does not support voice/fax operation in a Point-to-Point configuration.

In order to display the PPP dialog box, the WAN Port Setup dialog box has to be configured for PPP/SLIP.

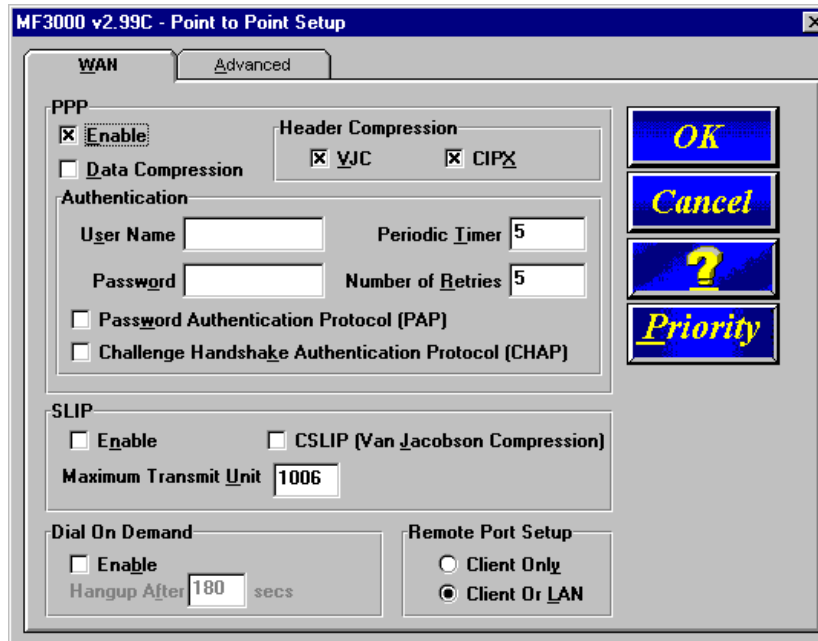

PPP is the default protocol. If SLIP is being used, click the PPP Enable option to disable PPP. Click the SLIP Enable option. Determine if the TCP header is going to be compressed using VJC compression. If VJC compression is used, click the CSLIP (Van Jacobson Compression) option.

Frame Relay Setup

The Frame Relay dialog box displays the CIR Measurement Interval in milliseconds, the Management Type and details of that management type, and the number of DLCI's that are active. The MultiFRAD can detect DLCI's and the Management Type when you are connected to an active frame relay service. So it is important that if you change any frame relay parameters, that the new parameters agree with the way your frame relay service is provisioned.

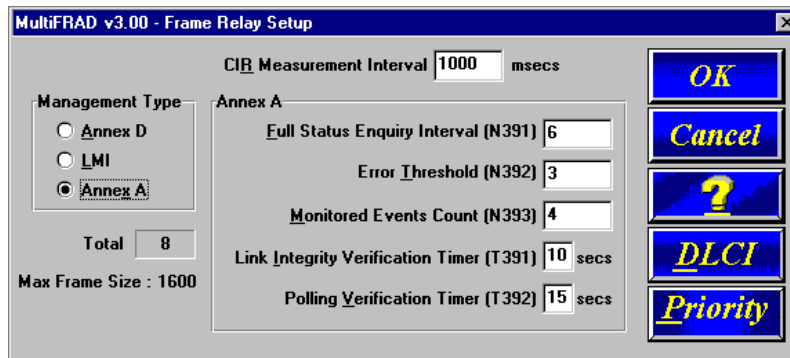

In the Frame Relay Setup dialog box, you can change the Management Type by choosing one of the three options. The detail parameters for that option are displayed to the right of the Management Type. For example, in the above dialog box, Annex D is the chosen management type with the Full Status Enquiry Interval [N391] set to 6 down thru Polling Verification Timer [T392] set to 15.

Usually, you will have no need to change the management type because the MultiFRAD will automatically detect the network's management type at power-up, or when the network becomes active. This feature takes about 1 to 2 minutes to detect the management type and get a list of the DLCI's.

Occasionally the Management Type parameters can be changed to correct a problem. In these cases making the following changes could alleviate the problem:

1. Change the **Link Integrity Verification Timer**. This feature sets how often the MultiFRAD verifies that the link is good. Changing the setting from the default value of 10 seconds, to a lower value, i.e., 5 seconds, will increase the frequency of those verifications.
2. Change the **Full Status Enquiry Interval** to affect how often DLCI Status is updated. This parameter defines how often the MultiFRAD will send a request for DLCI status information along with the Link Integrity Verification request. The default value is to include such a request every sixth time the link integrity is checked. A value less than every sixth request will allow faster detection of active/inactive DLCI's, but will also produce a slight increase in management overhead.
3. Change the **Monitored Events Count** and the **Error Threshold** to affect the MultiFRAD's sensitivity to errors on the link. Every management frame received by the MultiFRAD is considered an event, and if the link integrity sequence numbers are wrong, for example, it is considered an "errored" event. With the default settings, if **Error Threshold** is 3 and **Monitored Events Count** is 4, and 3 out of 4 events are "errored", then the link is considered to be bad, and the FRAD stops sending on all DLCI's and restarts the initial procedures to activate the link.
4. Change the **CIR Measurement Interval** to change the time frame in which the FRAD calculates throughput for each DLCI. By default, every 1000 milliseconds (1 second), the MultiFRAD calculates how much information has been sent on each DLCI, and depending on the congestion management option for a DLCI the MultiFRAD may stop sending on that DLCI because it has exceeded its CIR or CIR+Be rating. By changing the CIR Measurement interval, the throughput calculations can be made more or less often.

Note: performance could be compromised if the MultiFRAD is set to calculate throughput too often.

If you click the DLCI button on the right side of the dialog box, the Frame Relay DLCI dialog box is displayed.

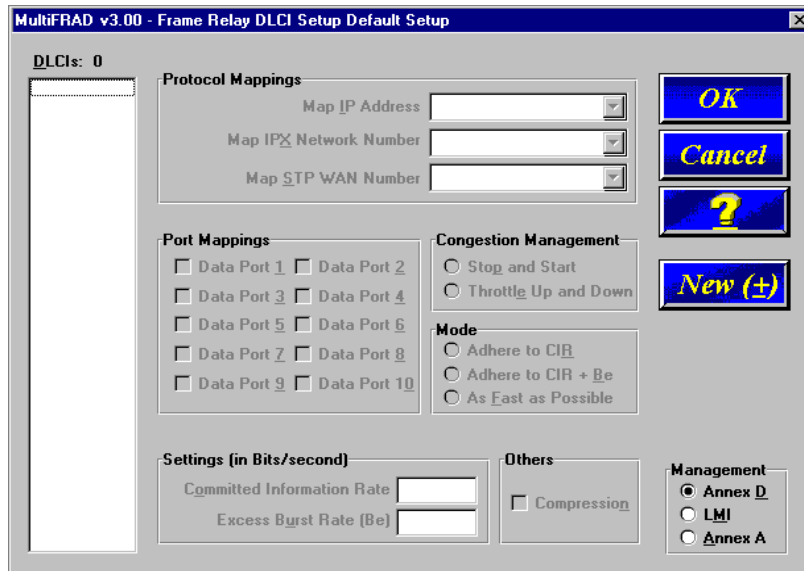

If you have connected to a frame relay service, this dialog box should display your current DLCI numbers automatically. It also shows the protocol mappings of the highlighted DLCI, which data ports are mapped to it, and how you set up your Congestion Management, Mode, CIR, and Be values. To change the mapping of a DLCI, highlight the DLCI number in the list on the left side of the dialog box. The dialog box will then display the mappings of that DLCI. To add a new DLCI that has not been auto-detected, click the New (+) button and the Frame Relay New DLCI dialog box is displayed.

To add a new DLCI Number, enter the number in the Enter DLCI Number window. You do not have to enter the leading zeros.



When you click the OK button, the new DLCI appears in the DLCI's window in the Frame Relay DLCI dialog box.

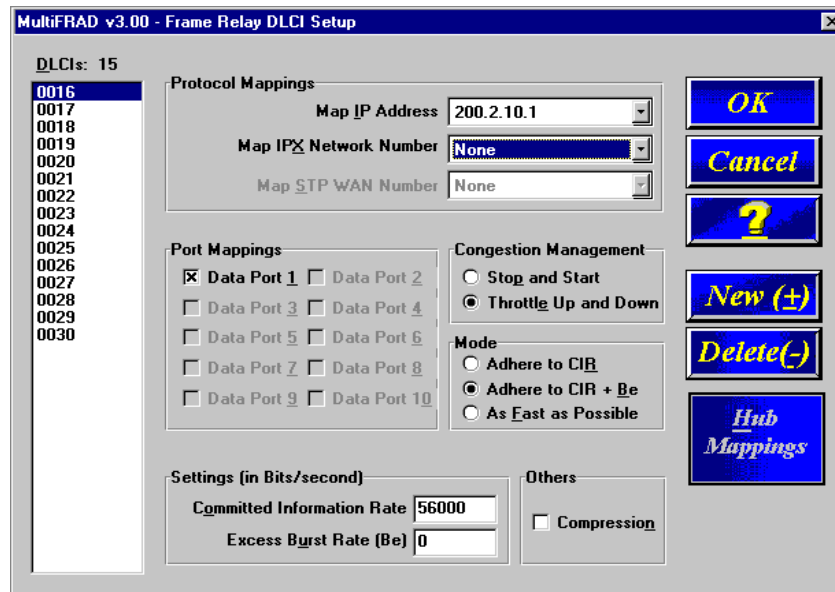

When a DLCI has just been detected, or if you have just made a new DLCI, no data ports and protocols are mapped to it. The default Congestion Management, mode, CIR, and Be are displayed. You should verify these default settings with how your new DLCI is provisioned by you service provider.

Congestion Management, Mode, and CIR/Be settings are used to avoid congestion and possible loss of data. The Committed Information Rate (CIR) and Excess Burst rate (Be) settings are throughput amounts determined by the network and user when each DLCI is ordered. The CIR is the basic throughput which the network will try to set aside for that DLCI. It will always be equal to or less than the actual access rate of the physical line (i.e., if the frame relay physical link is a 56K DDS line, the sum of the CIRs of all DLCIs on that link should not exceed 56K bps). The Be is the excess burst throughput rate (added to CIR) that the network should accept for that DLCI before significant loss of data occurs due to the discarding of frames during times of congestion. Note, however, that in frame relay there is no absolute guarantee of a congestion-free link, regardless of CIR and Be settings. The CIR and Be settings on the MultiFRAD should match the settings that the network has provisioned.

The Congestion Management and Mode settings determine how the MultiFRAD handles congestion. The Mode selects whether the MultiFRAD should use its own throughput calculations to avoid congestion, or simply send data to the network as fast as possible. The MultiFRAD calculates throughput after every CIR Measurement Interval, and can limit throughput to either the CIR (Adhere to CIR) or the CIR plus the Be (Adhere to CIR+Be). The Congestion Management setting selects whether the MultiFRAD should stop sending data when congestion is indicated (Stop and Start), or gradually reduce throughput during times of congestion (Throttle Up and Down).

Compression can be enabled on a per-DLCI basis by clicking on the Others-Compression box. If compression is required, it must be enabled on both the local and remote ends of the PVC.

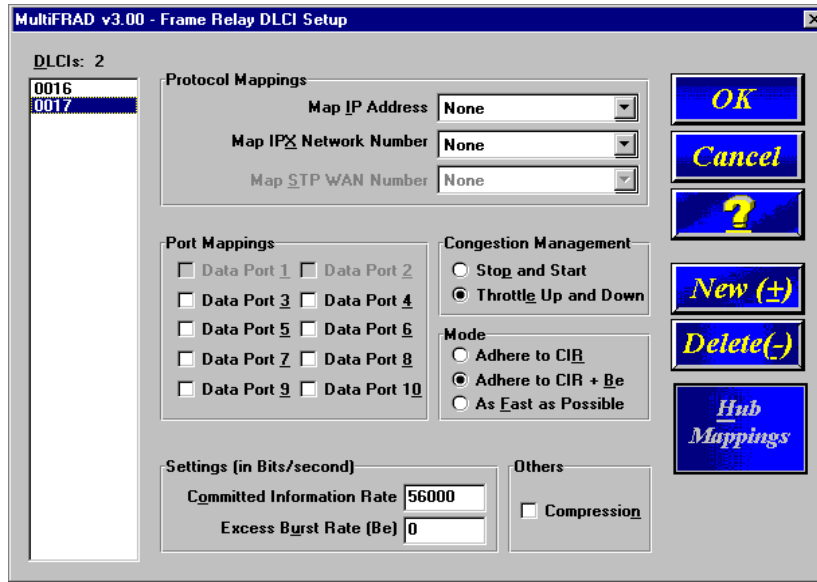

To map a protocol to a DLCI (e.g., 17), return to the Main Menu and then click the protocol stack that you are using. In the lower left part of the protocol stack dialog box, a list of Logical WANs is displayed. To add a new logical WAN, click the Add (+) button and the next logical WAN number will appear in the list on the left hand side of the dialog box.

For example lets map our new IP WAN 2 to our new DLCI 17. IP WAN 2 hypothetically requires an IP Port Address of 200.2.12.1, an IP Mask of 255.255.255.0, and a remote IP Address of 200.2.12.2. From the Main Menu, click the IP button. The IP Setup dialog box is displayed. Click the WAN tab at the top of the dialog box. The WAN parameters are displayed. Click the Add (+) button and WAN 2 is added to the List of Logical WANs. Default IP addresses will be displayed for the Port Address and Remote Address and a default IP Mask will appear in its window. If either address or mask needs to be changed, click the appropriate window and the change the numbers.

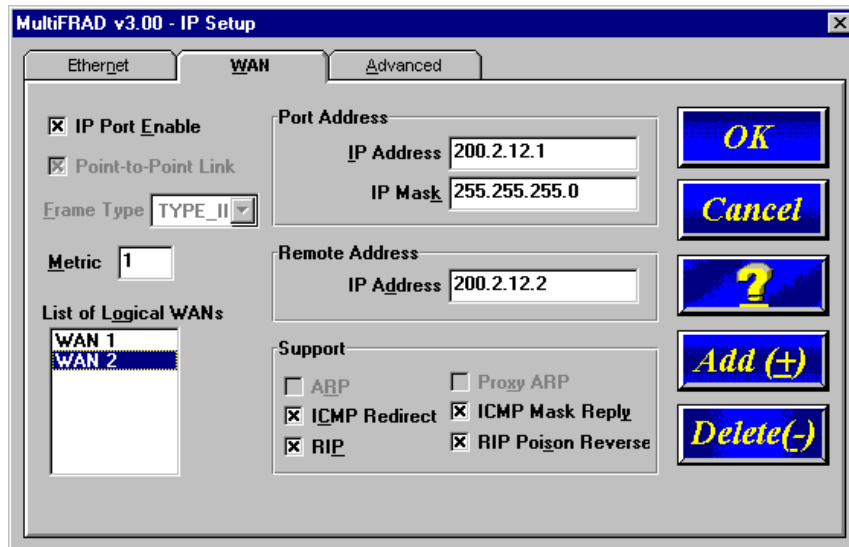

When you click the OK button in the IP WAN dialog box, you now have an IP address for a second logical WAN. Now we have to tie that IP address to a DLCI which in our example is DLCI 17. Now, return to the Frame Relay DLCI dialog box and high light DLCI 17. Click the Protocol Mappings Map IP Address down arrow and the IP address 200.2.12.1 appears. Click on this address and now IP address 200.2.12.1 is mapped to DLCI 17.

We now have WAN IP address 200.2.12.1 from the IP protocol stack mapped to DLCI 17. Let's say we also want to map a data channel to DLCI 17. The data ports that are already mapped to other DLCIs are grayed out. In our example, let's map data port 3 to DLCI 17. Simply click Port 3 in the Data Port Mappings group and an X appears in the box at the left of Port 3. Now we have both data port 3 and IP WAN address 200.2.12.1 mapped to DLCI 17. The MultiFRAD allows multiple sources of data to be mapped to the same DLCI because the MultiFRAD multiplexes all the data onto the DLCI. In other words, bandwidth for that DLCI is shared by all the data sources mapped to the DLCI. Of course, this means that all the data sources must go to the same remote site, since the frame relay network will send all data on DLCI 17 to the same place.

The screenshot shows the 'MultiFRAD v3.00 - Frame Relay DLCI Setup' dialog box. On the left, a list of DLCIs shows '0016' and '0017', with '0017' selected. The 'Protocol Mappings' section includes 'Map IP Address' set to '200.2.12.1', 'Map IPX Network Number' set to 'None', and 'Map STP WAN Number' set to 'None'. The 'Port Mappings' section has checkboxes for 'Data Port 1' through 'Data Port 10', with 'Data Port 3' checked. The 'Congestion Management' section has radio buttons for 'Stop and Start' and 'Throttle Up and Down', with 'Throttle Up and Down' selected. The 'Mode' section has radio buttons for 'Adhere to CIR', 'Adhere to CIR + Be', and 'As Fast as Possible', with 'Adhere to CIR + Be' selected. The 'Settings (in Bits/second)' section has 'Committed Information Rate' set to '56000' and 'Excess Burst Rate (Be)' set to '0'. The 'Others' section has a 'Compression' checkbox. On the right side, there are buttons for 'OK', 'Cancel', a question mark, 'New (+)', 'Delete(-)', and 'Hub Mappings'.

Data Port Configuration

The Data Port Configuration dialog box allows you to change the parameters of the data transferred between the data device and the MultiFRAD. The MultiFRAD can transfer data between the data device and MultiFRAD in either synchronous or asynchronous mode. If your data device is an asynchronous device, choose the Configure Asynchronous option and configure the MultiFRAD to match your device. If the data device is a synchronous device, choose the Configure Synchronous option and configure the MultiFRAD to match your synchronous device. The Data Port Configuration dialog box also allows you to configure each channel independently.

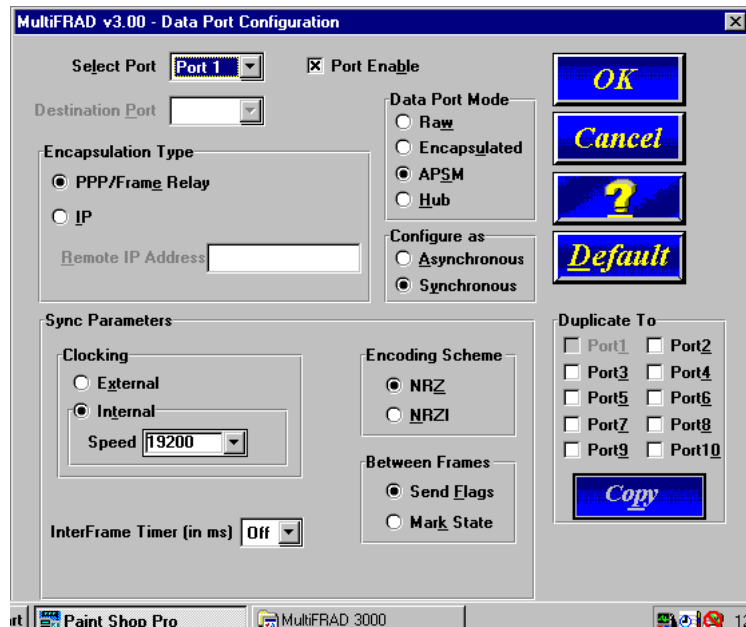

For example, port 1 could be connected to a Multi-Tech MultiMux MMH904. In this situation, port 1 could be configured with the following options:

- Data Port Mode set to APSM (Advanced Priority Statistical Multiplexing),
- Synchronous Configuration,
- Internal Clocking with Speed set to 19200,
- Encoding Scheme set to NRZ for all Multi-Tech Muxes,
- Between Frames set to Send Flags, and
- InterFrame Timer (in ms) has to be off.

The MMH904 would have to be configured for an external composite link device. This means that the 8-position DIP Switch on the MMH904 would have to be toggled to the closed position and an external composite link cable connected between the MMH904 and the MultiFRAD Channel connector.

In most applications, the encoding scheme, interframe timer, and between frames will be used at their default settings. If you are unsure of your device's configuration, start with the defaults or refer to your device's documentation.

Changing Voice/Fax Channel Parameters

The Voice/Fax channel parameters include the interface type and its options, voice and fax settings, and voice communications for the region of the world that the MultiFRAD resides in. The Channel Setup dialog box is accessed from the Main MultiFRAD menu. The Channel Setup dialog boxes contain three tabs that partition the channels into three categories, i.e., interface, voice/fax, and regional.



Interface

The interface tab defines the parameters related to the physical interface of the voice/fax channel. Depending on the interface type selected (FXS, FXO, or E&M), other options on the interface tab will turn grey (become inactive) indicating that they do not apply to the selected interface. Max Dial Digits, Inter Digit Time and Autocall features apply to all interface types.

The **Max Dial Digits** indicates the maximum number of digits the MultiFRAD will allow you to enter in the Phone Directory Database. This value is the number of digits, not an actual phone number. As soon as you have entered this number of digits, the MultiFRAD searches the database for a DLCI that matches the phone number. The range for the Max Dial Digits is from zero to 16 digits with a default of five.

The **Inter Digit Time** (in milliseconds) option in the Dialing Options group defines the amount of time the MultiFRAD waits between digits before searching the Phone Directory Database. The range for this option is 200 to 10,000 with a default of 2,000.

The **Auto Call** option allows the local MultiFRAD to call a remote MultiFRAD without the user having to dial a Phone Directory Database number. As soon as you access the local MultiFRAD voice/fax channel, the MultiFRAD immediately connects to the remote MultiFRAD that you identified in the Remote MultiFRAD Phone Number field of this option.

FXS Interface

The FXS Interface is used to connect telephones, fax machines, key telephone systems, etc., to the MultiFRAD. In addition, you need to select either Loop Start or Ground Start. Most of the equipment mentioned will use Loop Start which is the default.

FXO Interface

The FXO Interface is used to connect PBX extensions or central office telephone lines. You also, need to select DTMF or Pulse dialing in the Regeneration field of the Dialing Options group. If you are unsure of the correct selection, contact the personnel in charge of your PBX or your local telephone company to determine whether pulse or DTMF should be used.

E&M Interface

The E&M Interface is used to connect PBX E&M trunks. You will need to select between Dial Tone or Wink signaling and also between 2-wire and 4-wire mode. If wink signaling is selected, the wink timer field becomes active with a range from 100 to 350 milliseconds. Contact the personnel in charge of your PBX to determine the proper configuration of these settings.

Voice/Fax

The Voice/Fax tab controls the voice coder, Fax settings, DTMF gain, and some miscellaneous options.

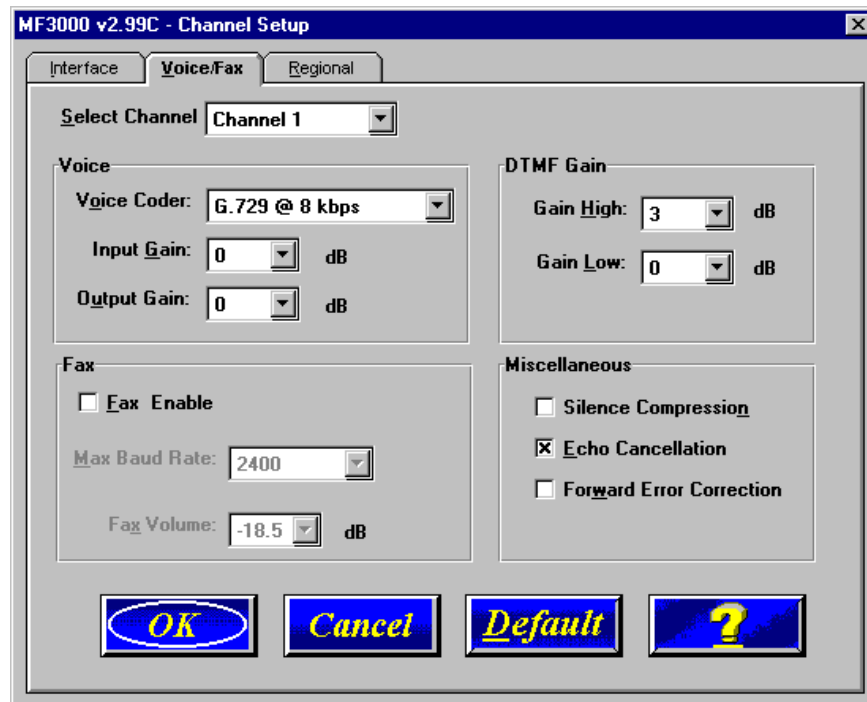

The MultiFRAD supports many state-of-the-art ITU (International Telecommunications Union) voice standards. The **Voice Coder** drop-down menu enables you to select from a range of standards with specific bandwidths. The higher the bps rate, the more bandwidth is used. The channel that you are calling has to have the same voice coder selected.

The **Fax** group enables a fax machine to transmit and receive faxes through the MultiFRAD. If a fax machine is connected to one of the voice/fax channels, the **Max Baud Rate** should be set to match the baud rate of the fax machine. This setting should be changed only under the direction of Multi-Tech's Technical Support personnel (see [Chapter 6](#)).

Regional

The regional tab controls the voice communications for the region that the MultiFRAD resides in.

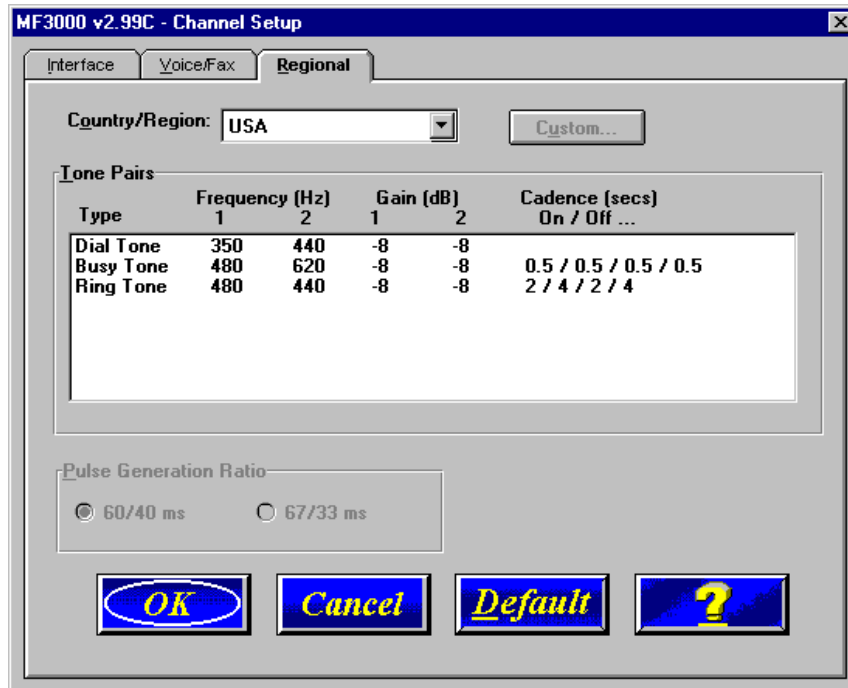

From the **Country/Region** drop-down list you can select the region or country for which you are configuring the MultiFRAD. The **Tone Pairs** group displays the tones used in the region you selected.

The **Pulse Generation Ratio** group contains two ratios, the 60/40 is basically for the USA and the 67/33 ratio is for international applications.

Changing the Phone Directory Database

The phone directory database defines each FRAD Phone Number in your MultiFRAD network. To access this database you would click on the Phone Book button in the Main MultiFRAD menu. You can add, delete, or edit any entry in the database.

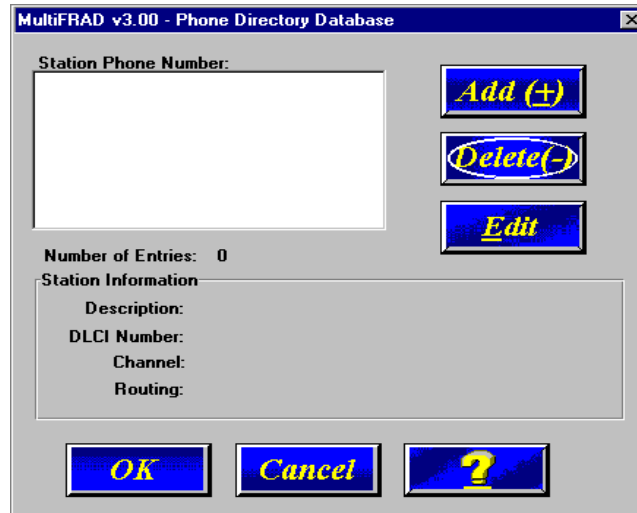

The **Station Phone Number** window displays the Phone Numbers that are reachable from this voice gateway, and the **Station Information** group displays the details of that phone number.

To add a phone number, click **Add(+)** in the **Phone Directory Database** dialog box and the **Add/Edit Phone Entry** dialog box is displayed. Assign the new Phone Number, then add a Description (optional), select the Voice Channel number and type the DLCI number in the fields provided. When done, click OK and the Station Phone Number dialog box is displayed.

To change or delete an existing phone number, highlight the number in the Station Phone Number window and click on either the **Edit** or **Delete(-)** button. If you are editing an existing phone number, the Add/Edit Phone Entry dialog box is displayed.



The MultiFRAD phone number does not have to be a conventional telephone number; for example, it does not have to be 717-5565. It can be a single digit or many digits with the exception that it can not be longer than the entry in the **Max Dial Digits** field in the Dialing Options group of the Channel Setup dialog box.

Others Setup

Clicking the **Others** button on the main menu displays the Others Setup dialog box. This dialog box lets you enable SNMP Agent (the default is *disabled*) and set up all the necessary parameters; enable or disable various remote configuration methods such as TFTP (Trivial File Transfer Protocol) Server, Web Server, Dumb Terminal, and Telnet Server; and assign a Password to the MultiFRAD for Internet security. These applications enable remote viewing and changing of the MultiFRAD configuration, or updating firmware, from anywhere on the connected internetwork.

Verify that the desired applications are enabled (checked). The default condition is all applications are checked. To disable a given application, click to uncheck the check box and disable support.

SNMP related operations can be performed only when the SNMP Agent is enabled (checked) on this dialog box. The IP address of the system (i.e., SNMP Manager) that will receive the Traps from the Multifrad should be entered in the **IP Address** field in the Trap Manager group. The **Community Name** of the SNMP Manager receiving the Traps can be a maximum of 19 characters and is case sensitive. The default Port Number of the SNMP Manager receiving the Traps is 162. The MultiFRAD currently supports a maximum of two community users at a time, and they can be assigned either Read/Write or Read Only rights.

The **MultiFRAD Password** field allows you to enter a password, up to 13 alphanumeric characters, to be used for Internet Security. Once the password is entered, remote users will be queried to enter the password before gaining access to the MultiFRAD.

For more information on using these applications, click the on-line **Help** button or refer to [Chapter 5, Remote Configuration and Management](#).

Enable Logging of Statistics

Clicking the **Log Setup** button on the Others Setup dialog box displays the **Log Statistics** dialog box which lets you Enable/Disable Logging, set the time interval (in minutes) between logging, and either Log all Statistics or only those statistics that you enable (check) on this dialog box.

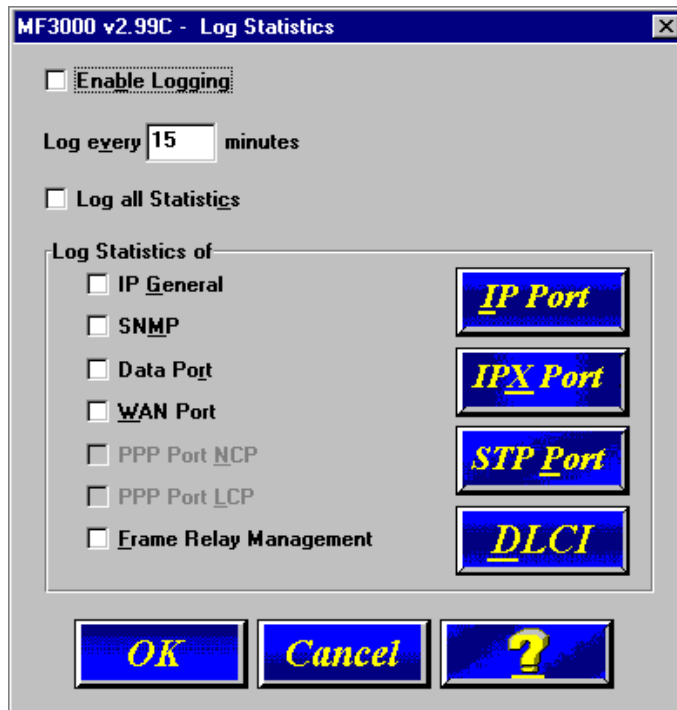

Statistics

The Statistics dialog box allows you to view statistics on the major events of the MultiFRAD. The Statistic dialog box changes depending on the way the WAN port is configured. If the MultiFRAD is configured in a point-to-point configuration, the button to the right of the WAN changes to PPP and the DLCI button will be grayed out. If the WAN port is configured for a frame relay configuration, then the button to the right of the WAN changes to Frame Relay and the DLCI button is active.



Statistics can be a helpful troubleshooting tool. For example, viewing the WAN Statistics you can see if the MultiFRAD is sending or receiving on its composite link or WAN port. When the MultiFRAD is configured in a frame relay mode, it will transmit management frames approximately every ten seconds, trying to establish communication with the provider's switch. If the unit is sending frames but not receiving any, this may be an indication of a problem with the link device or the frame relay network. Statistics in the frame relay dialog box actually show the number of management frames being sent and received, and can also indicate a link or frame relay network problem. (One way to determine if a problem is local would be to set your DSU to internal clocking and put it in loopback by means of a DSU loopback cable (RJ-45). If the MultiFRAD, the cable and the DSU are all functioning properly, the WAN statistics will reflect that fact by showing the same amount of bytes received as transmitted.)

Another helpful statistic screen is DLCI. It reflects the status of the PVC, i.e., active or inactive and whether or not the MultiFRAD is experiencing network congestion (reflected by FECNs or BECNs received).

IP Statistics

IP is a connection-less network protocol that resides in the network layer of a conventional OSI layered model. Depending on what is going on at the application layer, IP will typically use one of two transport layer protocols. User Datagram Protocol (UDP), a connection-less transport layer protocol used with TFTP or SNMP; and Transport Control Protocol (TCP) is a connection-oriented transport layer protocol used with FTP, Telnet, and SMTP.

| Packets | |
|-----------------------------|-------|
| To Transmit | 4,186 |
| Received | 4,185 |
| Forwarded | 0 |
| Could not be forwarded | 0 |
| Discarded for Lack of Route | 0 |
| Received with Header Errors | 0 |

| UDP Packets | |
|---|-------|
| Transmitted | 4,186 |
| Received | 4,185 |
| Received with Errors with Unreachable Destination | 0 |

| TCP Packets | |
|----------------------------------|---|
| Transmitted | 0 |
| Retransmitted | 0 |
| Received | 0 |
| Number of Successful Connections | 0 |
| Connection Attempt | 0 |
| Received with Errors | 0 |
| Transmitted with RST | 0 |

UDP makes use of the port concept and has no measures for flow control, reliability, or error recovery. It is used when the full services of TCP are not required, and the reliability measures must be assumed by another layer.

TCP works well in environments where the reliability measures are not assumed by other layers. It is connection-oriented and has a full range of services.

For the most part these statistics are informational, and their use as a troubleshooting tool will be contingent on the applications running in the upper layers. For instance, if you were having problems connecting to MultiFRAD's web server, you would look under the TCP section to see if any connections are being established. If not, that may indicate the web server is not enabled. Or, if you were having problems establishing a remote connection through TFTP, you could look in the UDP section to see if any packets are being received. If not, you may need to review your network addressing.

The Port Tab allows you to view generic IP statistics for a given Ethernet IP Port. Either the Ethernet (LAN) port, or any logical IP WAN port statistics can be viewed in this window. The practicality of statistical use in troubleshooting will depend on the application running in the upper layers.

IPX Port Statistics

The IPX Port Statistics dialog box displays information pertaining to the IPX Port, for example, the frame type used or the number of packets transmitted/received.

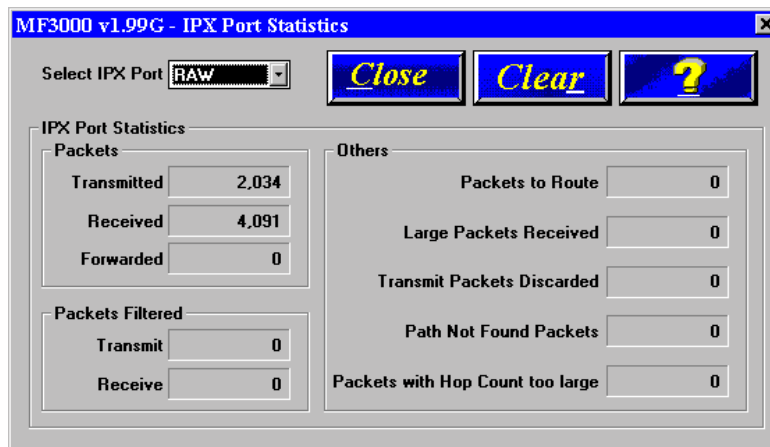

IPX is a network layer protocol that is usually associated with Novell Netware™ networks. It allows for encapsulation of four different frame types over a single physical LAN connection (provided each frame type has a unique network address): RAW (802.3), LLC (802.2), Ethernet II, and SNAP.

These statistics are mostly informational but could be useful for troubleshooting. For instance, if there was a question as to which frame type your workstation was using, you could view the statistics for each frame type and determine which one is being used by the amount of packets transmitted and received.

STP (Spanning Tree) Port Statistics

The STP (Spanning Tree) Port Statistics dialog box displays information regarding the selected STP port, for example, the number of frames discarded or forwarded.

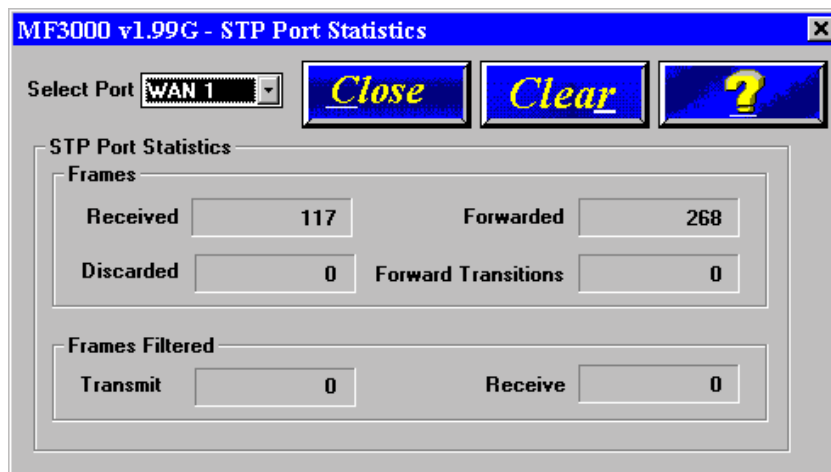

Spanning Tree transparent (STP) bridging is the method of bridging used by the MultiFRAD as specified in IEEE 802.1d standard. Enabling the spanning tree algorithm in addition to spanning tree bridging provides for a loop-free environment with redundant paths (if present) that will transition from blocking to forwarding automatically in case of a root bridge failure.

The STP Port statistics are mostly informative but may be helpful in troubleshooting. For example, viewing the number of forward transitions could indicate if the port has ever become active (in which case forward transitions will be greater than zero).

SNMP Statistics

The SNMP Statistics dialog box provides statistical information on Simple Network Management Protocol (SNMP).

| Packets Received with | |
|-----------------------|---|
| Set Request | 0 |
| Get Request | 0 |
| Get Next Request | 0 |
| Get Response Request | 0 |
| Bad Values | 0 |
| Bad Communities | 0 |
| Bad Community Uses | 0 |
| No Such Names Error | 0 |

| Packets | |
|-------------|---|
| Transmitted | 0 |
| Received | 0 |

| Asn Parse Errors | |
|------------------|---|
| Asn Parse Errors | 0 |

| Traps Received | |
|----------------|---|
| Traps Received | 0 |

| Others | |
|---|---|
| Transmit Variable too Big | 0 |
| Read Only Packets Received | 0 |
| Total Set Variable Packets Received | 0 |
| Total Request Variable Packets Received | 0 |
| Packets Sent with Get Response Request | 0 |
| Packets Received with Wrong Version | 0 |

SNMP is an application layer protocol that facilitates the exchange of management information between network devices. There are three key components in SNMP: the devices that are to be managed, agents, and the network management systems. The managed device is the network device, like a MultiFRAD. The agent is the software module residing in the managed device pertaining to network management. The network management system runs the SNMP application that controls the managed devices and monitors their status. There are four primary operations performed using SNMP. They are Set, Get, Get Next, and Trap.

You can use these statistics to help troubleshoot in the event you have a problem communicating with the MultiFRAD from your SNMP manager.

WAN Statistics

The WAN Statistics dialog box provides statistical information regarding the MultiFRAD's WAN port, including the number of packets transmitted/received, and total bytes transmitted/received.

| DSU Signals | |
|-------------|-----|
| NS | OOS |

| Packets | |
|-------------|-----|
| Transmitted | 263 |
| To Transmit | 0 |
| Received | 700 |

| Bytes | |
|-------------|--------|
| Transmitted | 3,680 |
| Received | 47,258 |

| Others | |
|-------------------------------|---|
| Transmit Errors | 0 |
| Receive Errors | 0 |
| Rejected Transmit Packets | 0 |
| Receive Buffer Overflows | 0 |
| Modem Carrier Losses | 0 |
| Modem Initialization Attempts | 0 |

The WAN Port Statistics dialog box pertains to the traffic on the MultiFRAD's composite link (WAN) port. The Statistics that fall into "Others" category relate to the physical layer between the MultiFRAD and the link device, i.e. the CSU/DSU. These statistics can be helpful in troubleshooting suspected problems at the physical layer, i.e., the WAN port itself, the link device (CSU/DSU), and any associated cabling.

PPP Statistics

The PPP Statistics dialog box provides statistical information related to Point-to-Point Protocol (PPP). For example, this dialog box displays the current protocol and compression methods enabled.

| NCP Statistics | |
|----------------------------------|---------|
| IPXCP Statistics | |
| Packets | |
| Transmitted | 11 |
| Received | 0 |
| Bytes | |
| Transmitted | 100 |
| Received | 0 |
| IPCP Statistics | |
| Packets | |
| Transmitted | 2 |
| Received | 2,080 |
| Bytes | |
| Transmitted | 40 |
| Received | 303,368 |
| Authentication Statistics | |
| Packets | |
| Transmitted | 0 |
| Received | 0 |
| Bytes | |
| Transmitted | 0 |
| Received | 0 |

The statistics in this dialog box will only apply when you are accessing your network remotely with a PPP client. The Network Control Protocol (NCP) is the means by which PPP clients negotiate the network-layer protocols. IP and IPX network-layer protocols are supported on the MultiFRAD.

The Link Control Protocol (LCP) is the means by which PPP clients negotiate and configure the data link for a given PPP connection.

Data Port Statistics

The Data Port Statistics dialog box displays statistical information, such as bytes or blocks received/transmitted, for the various data ports.

| Data Port | Bytes Transmitted | Bytes Received | Blocks Transmitted | Blocks Received | Blocks Retransmitted | Xoff Sent | Xoff Received | Buffer Utilization | Remote Port |
|-----------|-------------------|----------------|--------------------|-----------------|----------------------|-----------|---------------|--------------------|-------------|
| Port 1 | 384,000 | 382,464 | 500 | 500 | 0 | NO | NO | 0% | - |
| Port 2 | 0 | 0 | 0 | 0 | 0 | NO | NO | 0% | - |
| Port 3 | 0 | 0 | 0 | 0 | 0 | NO | NO | 0% | - |
| Port 4 | 0 | 0 | 0 | 0 | 0 | NO | NO | 0% | - |
| Port 5 | 0 | 0 | 0 | 0 | 0 | NO | NO | 0% | - |
| Port 6 | 0 | 0 | 0 | 0 | 0 | NO | NO | 0% | - |
| Port 7 | 0 | 0 | 0 | 0 | 0 | NO | NO | 0% | - |
| Port 8 | 0 | 0 | 0 | 0 | 0 | NO | NO | 0% | - |
| Port 9 | 0 | 0 | 0 | 0 | 0 | NO | NO | 0% | - |
| Port10 | 0 | 0 | 0 | 0 | 0 | NO | NO | 0% | - |

This window shows the statistics for all data channels. By highlighting and double clicking on a particular port, you can view the individual channel statistics, as well as various hardware signals (CTS, RTS, DSR, DCD, DTR) and XON/XOFF status. It also gives an indication of buffer utilization and receive flow time.

These may be indicators that either the data channels, or more likely the devices attached to them, are being driven harder than they should be. Excessive buffer utilization and/or receive flow control time can usually be reduced or eliminated by slowing the speed at which the channel is operating.

Note: When you double-click a particular Port number, the following screen is displayed.

| Bytes | | Blocks | | Others | |
|-----------------------------|---------|--------------------|-------|-----------------------------|--------------|
| Transmitted | 384,000 | Transmitted | 1,000 | Remote Port | - |
| Received | 382,464 | Received | 1,000 | Xoff Transmitted | NO |
| | | Retransmitted | 0 | Xoff Received | NO |
| | | | | Buffer Utilization | 0% |
| | | | | Receive Flow Control Time : | 00 : 00 : 00 |
| Mux Link Control Statistics | | | | | |
| Bytes Transmitted | 168 | Blocks Transmitted | 17 | | |
| Bytes Received | 10 | Blocks Received | 1 | | |

Frame Relay Statistics

The Frame Relay Management Statistics dialog box can be a useful tool for troubleshooting MultiFRAD installations and monitoring the performance of active links, and determining if the MultiFRAD is talking to the provider's switch.

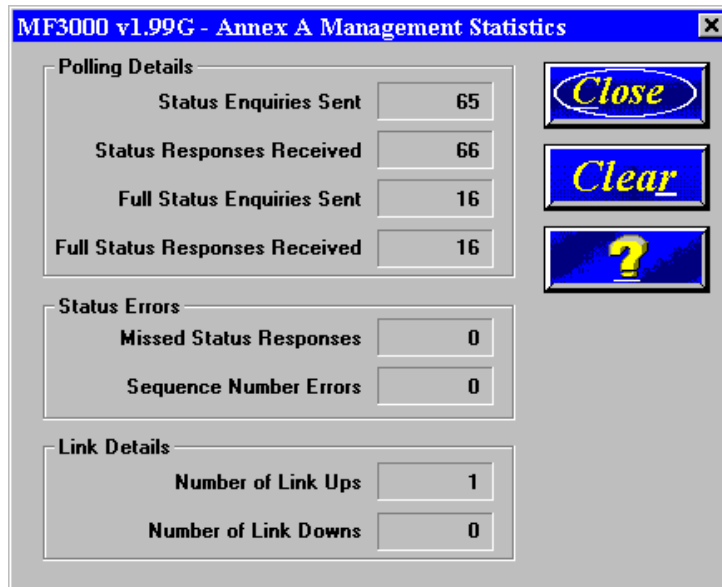

The **Polling Details** section lists the various management frames sent and received. For every Status Enquiry Sent, a Status Response should be received from the network. Likewise, for every Full Status Enquiry Sent, there should be one Full Status Response received. The two status enquiry types are used by the FRAD to verify that the frame relay network is operational, and to determine which DLCIs are active. Under default settings a status enquiry is sent every ten seconds, and every sixth enquiry will be a Full Status Enquiry.

The Enquiries Sent and the Responses Received should increment together, and should be equal under normal circumstances. Any gap between them reflects a breakdown in communication with the provider's switch, and will be reflected as Missed Status Responses.

The **Status Errors** section lists the number of errors that have occurred. A Missed Status Response means that the frame relay network did not respond to a status enquiry from the MultiFRAD before the next status enquiry was sent (by default there are 10 seconds between status enquiries).

A **Sequence Error** means that the sequence numbers in a received status response do not match what the MultiFRAD expected based on its Status Enquiry. Basically, the Status Enquiry has two numbers (or counts), and one should be incremented by the network and then both numbers should be returned to the FRAD in the Status Response. Sequence Number Errors also reflect missing packets between the MultiFRAD and the switch, but should not be a cause for alarm unless they are incrementing rapidly and steadily.

The **Link Details** section records the number of times the frame relay link between the MultiFRAD and the network has gone up (become active) or gone down (become inactive). The Link Details provide a more general picture of the status of communication between the MultiFRAD and the frame relay network.

The DLCI Statistics dialog box shows the individual DLCI status and statistics. This information can be helpful in determining if the DLCI is active, if it is going up and down, and if the MultiFRAD is experiencing frame relay network congestion (FECN/BECN). It also gives an indication of the momentary throughput on individual DLCIs.

| | Bytes Sent | Bytes Received | Frames Sent | Frames Received |
|-----------------|------------|----------------|-------------|-----------------|
| IP | 3,934 | 3,694 | 37 | 35 |
| IPX | 8,804 | 5,024 | 67 | 55 |
| STP | 0 | 0 | 0 | 0 |
| Data Port 1 | 882,914 | 685,152 | 2,227 | 1,719 |
| Data Port 2 | 0 | 0 | 0 | 0 |
| Data Port 3 | 0 | 0 | 0 | 0 |
| Data Port 4 | 0 | 0 | 0 | 0 |
| Data Port 5 | 882,792 | 706,990 | 2,226 | 1,766 |
| Data Port 6 | 0 | 0 | 0 | 0 |
| Data Port 7 | 0 | 0 | 0 | 0 |
| Data Port 8 | 882,914 | 686,860 | 2,227 | 1,727 |
| Data Port 9 | 0 | 0 | 0 | 0 |
| Data Port 10 | 0 | 0 | 0 | 0 |
| Voice Channel 1 | 102,320 | 100,020 | 932 | 912 |
| Voice Channel 2 | 26,310 | 25,540 | 241 | 234 |
| Voice Channel 3 | 0 | 0 | 0 | 0 |
| Voice Channel 4 | 0 | 0 | 0 | 0 |
| Voice Channel 5 | 0 | 0 | 0 | 0 |

When trying to troubleshoot a frame relay circuit, once it has been established that management frames are being sent and received, the next step is to determine whether the DLCIs are becoming active. This is dialog box that will give that indication. A FRAD needs to be present at both ends for the DLCI to be active. Keep in mind that the frame relay network tells the FRAD the status of the PVC with one of its status responses. But the network will not say the PVC is active until it has established management communication at both ends of the PVC. If the FRADs at both ends of the PVC show that they are communicating with the frame relay network and the DLCI still shows active, and there is a communication problem over that PVC, there may be a problem with your service provider. If all DLCIs show active at both (or all) locations and there is still an end-to-end communication problem, it is likely that it is in the configuration of the MultiFRAD. At that point you should review your protocol stack/data port parameters and DLCI mappings.

Multi*FRAD*TM 3000-Series

Router/Multiport Data/Voice/Fax
Frame Relay Access Device

Chapter 5 - Remote Configuration and Management

MultiTech[®]
Systems 

Introduction

This chapter provides procedures for viewing or changing the configuration of a remote unit. Two methods are provided to access a remote unit; the first method is modem based and the second method is using IP. Within the IP method, three applications can be used: 1) LAN-Based using TFTP (Trivial IFile Transfer Protocol), 2) Telnet as a client application, or 3) a standard web browser on the Internet.

Remote Configuration

Remote configuration requires the MultiFRAD software to be loaded on the local PC. The local PC then controls the remote MultiFRAD either via the modem connection or the LAN.

Modem-Based

To remotely configure a MultiFRAD, a local PC needs to be connected to a dial-up line and the MultiFRAD software configured to call the remote MultiFRAD. The remote MultiFRAD needs to have a modem connected to a dial-up line and the Command Port. Once the connection to the remote unit is made, you can change the configuration as you see fit. Once the configuration is changed, you can download the new configuration to the remote MultiFRAD. Refer to the Modem-Based Remote Configuration Procedure in this chapter to remotely configure a MultiFRAD.

- 1 At the remote site, remove the serial cable from the PC to the Command Port connector on the back panel of the MultiFRAD.
- 2 At the remote site, connect a special cable (Remote Configuration Cable) from the Command Port connector on the back panel of the MultiFRAD to the RS232 connector on the modem. The special cable is a serial cable with male connectors on both ends. Refer to Appendix A for cable details.

Connect the modem to your local telephone line.

Provide your telephone number to the person verifying your configuration.

Configure the remote modem for 19200 baud and turn on Force DTR.

- 3 At the main site, connect your local PC to a modem that is connected to a dial-up line.
- 4 Install the MultiFRAD software on the local PC. When installed, click **Start | Programs | MultiFRAD 3000 | Configuration Port Setup**, or double click the Configuration Port icon in the MultiFRAD 3000 program group.
- 5 The **FR3000 Port Setup** dialog box is displayed.

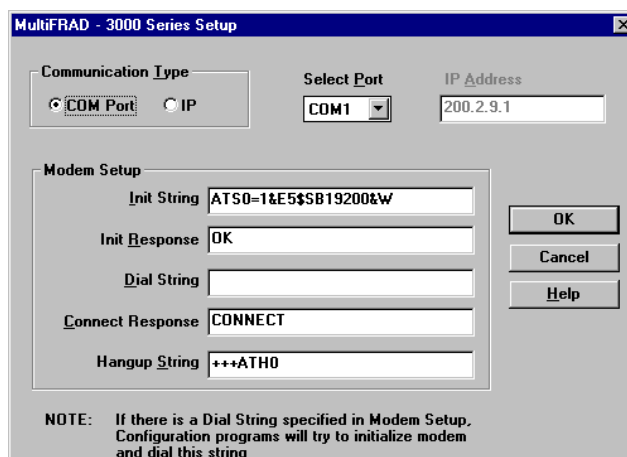

Verify that the **Communication Type** field is set for **COM Port** and the **Select Port** field matches the COM port of your local PC.

In the **Dial String** field, enter the AT command for dialing (ATDT) plus the phone number of the remote MultiFRAD.

If your Modem Initialization String, Initialization Response, or Connect Response values are different from the defaults in the dialog box, refer to your modem user documentation and change the values to match those required by your modem.

Click **OK** when you are satisfied with your selections.

- 6 Run the MultiFRAD Configuration program. Click **Start | Programs | MultiFRAD 3000 | MultiFRAD Configuration**, or double click the MultiFRAD Configuration icon in the MultiFRAD 3000 program group.
- 7 The **Dialing** MultiFRAD Dialog Box is displayed while software is dialing the remote MultiFRAD.
- 8 The **Reading Setup** Dialog Box is displayed.
- 9 The **FR3000 Setup** dialog box is displayed. This is the dialog box of the remote MultiFRAD. Refer to the online Help provided within your software for a description of each dialog box and field within a dialog box.

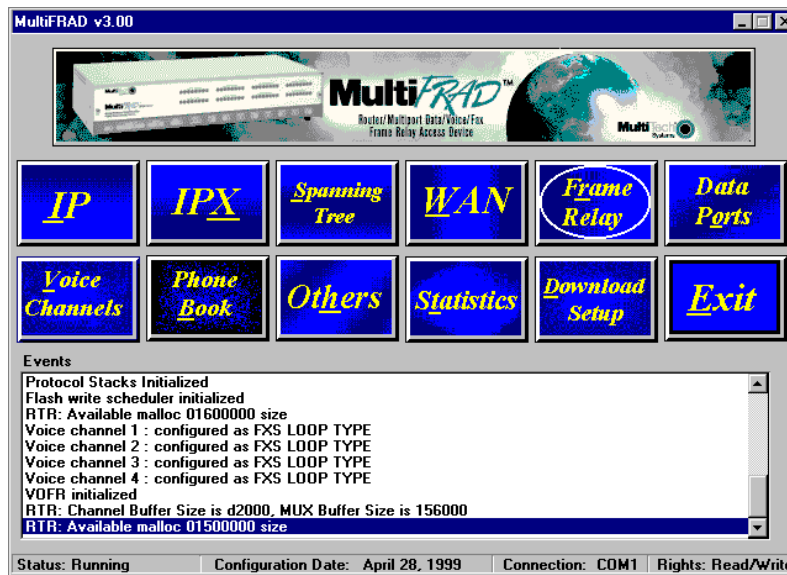

- 10 After you have changed the configuration of the remote MultiFRAD, click the **Download Setup** button to update the configuration. The remote MultiFRAD will be brought down, the new configuration written to the unit, and the unit will reboot.
- 11 Click **Exit** after the downloading is complete.
- 12 The **Hangup connection with MultiFRAD?** dialog box is displayed
Click **Yes** to disconnect the phone connection to the remote site.
- 13 If the same telephone number is not going to be used again in the immediate future, you may want to remove it from the Port Setup dialog box.
- 14 At the remote site, reconnect the MultiFRAD to the serial port of the PC and from the Program Manager screen click the **MultiFRAD Configuration** Icon to verify that the MultiFRAD is running.

LAN-Based

The LAN-based remote configuration requires a Windows Sockets compliant TCP/IP stack. TCP/IP protocol software must be installed and functional before the configuration program can be used.

- 1 You must assign an Internet (IP) address for the PC and for each node that will be managed by the configuration program. Refer to the protocol software documentation for instructions on how to set the IP addresses.

Once you have completed this step, you should be able to use the protocol Ping command for the PC host name. You should also test the network interface configuration by Pinging another TCP/IP device that is connected to the network.

- 2 Install the MultiFRAD software on the local PC. When installed, click **Start | Programs | MultiFRAD 3000 | Configuration Port Setup**, or double click the Configuration Port icon in the MultiFRAD 3000 program group.
- 3 The **FR3000 Port Setup** dialog box is displayed.

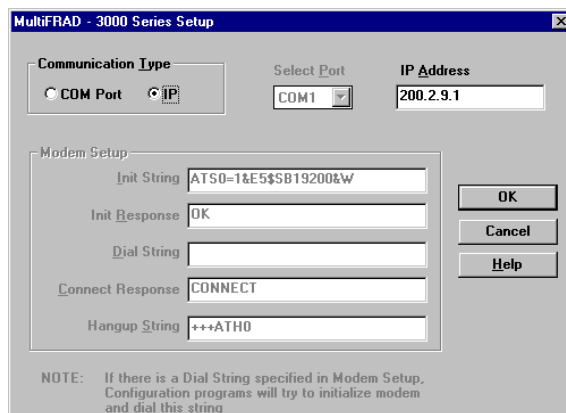

Verify that the **Communication Type** field is set **IP**.

In the **MultiFRAD IP Address** field, enter the IP Address of the remote MultiFRAD.

- 4 Click **OK** when you are satisfied with your selections.
- 5 Run the MultiFRAD Configuration program. Click **Start | Programs | MultiFRAD 3000 | MultiFRAD Configuration**, or double click the MultiFRAD Configuration icon in the MultiFRAD 3000 program group.

The **Reading Setup** dialog box is displayed.

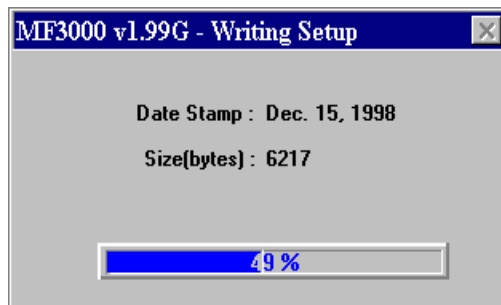

- 6 The **FR3000 Setup** dialog box is displayed. This is the dialog box of the remote MultiFRAD. Refer to the online help provided with your MultiFRAD for the definition of each dialog box and field within a dialog box.

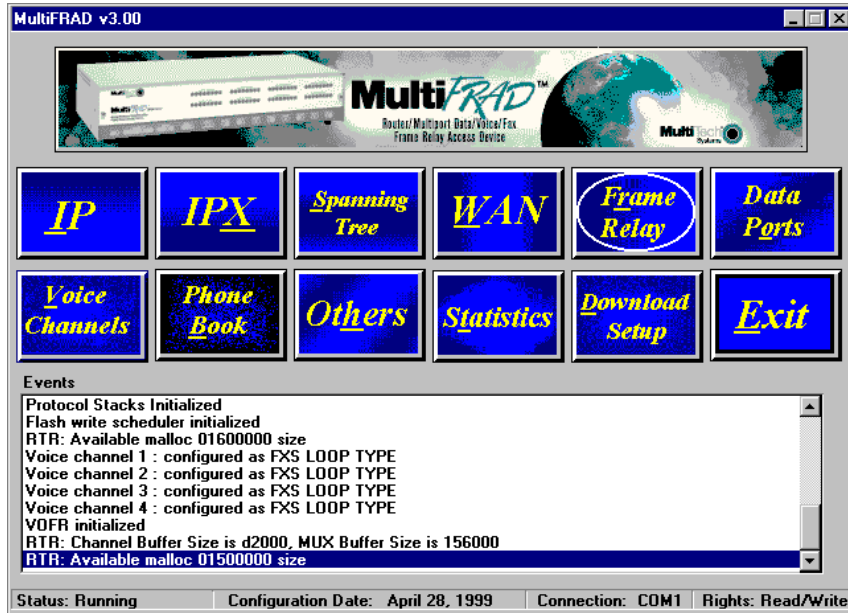

- 7 After you have changed the configuration of the remote MultiFRAD, click **Download Setup** to update the configuration. The remote MultiFRAD will be brought down, the new configuration written to the unit, and the unit will reboot.
- 8 Click **Exit** after the downloading is complete.
- 9 Double-click the **MultiFRAD Configuration** icon in the **MultiFRAD 3000** program group to verify that the MultiFRAD is running.

Remote Management

This section describes typical client applications that can be used to configure the MultiFRAD remotely. It is important to note that although any subsequent changes to configuration can be made using these applications, the initial setup and configuration of the MultiFRAD must be done on the local PC, using the MultiFRAD software provided with your unit.

Although establishing access to the MultiFRAD varies between applications, the configuration functions mirror those of the MultiFRAD software. For more information on MultiFRAD software, refer to [Chapter 4 - MultiFRAD Software](#).

Telnet

A typical Telnet client application is described next. The MultiFRAD has a built-in Telnet Server that enables Telnet client PCs to access the MultiFRAD. A typical Telnet client is allowed to configure the MultiFRAD and its data ports. In addition, the MultiFRAD can be remotely accessed and configured from anywhere on the Internet through its Web interface. A typical TCP/IP program group is shown below with a Tcpman icon and a Telnet icon.

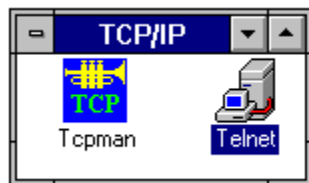

The TCP/IP stack has to be loaded before the Telnet client (a Windows application) will run. The Telnet Server option has to be selected from the Applications Setup dialog box using the Applications Setup dialog box using the MultiFRAD Configuration icon and the Others button on the FR3000 Setup dialog box. Double-click the **Telnet** icon (or shortcut) and a blank Telnet screen is displayed. Click **Connect | Remote System**, and the Connect dialog box is displayed. Select (or enter) a Host Name (the IP address of the MultiFRAD). In this example, the IP Host Name is 200.2.9.1.

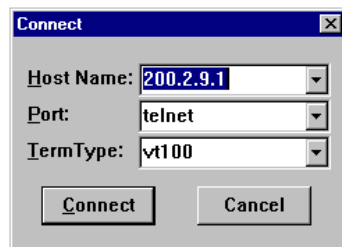

When you enter a valid Host Name (IP address) and click the Connect button, you are immediately connected to the target MultiFRAD and the MultiFRAD Management Menu screen is displayed.

MultiFRAD Management Menu

The MultiFRAD management menu provides two options; MultiFRAD Configuration and Remote User Database. The MultiFRAD Configuration options allow you to select the protocol stack, high or low level device drivers, applications, Mux data ports, filtering, priority, or system information. The Remote User Database option enables you to build and maintain a user database for remote access.

```

Telnet - 192.168.2.16
Connect Edit Terminal Help

*****
*
*      MultiFRAD 3000 Version 2.99C      *
*
*      Copyright (C) 1995 Multi-Tech Systems, Inc., *
*      Multi-Tech Systems, Inc., *
*      2205 Wooddale Drive, Mounds View, *
*      Minnesota 55112, USA. *
*      http://www.multitech.com *
*
*****

<< MultiFRAD Telnet Server >>

[ 1] MultiFRAD Configuration
[ 2] Remote User Database

Enter your choice (1 to 2, or EXIT) : █

```

When you enter a password in the Applications Setup dialog box in the MultiFRAD Software, once you choose an option from the MultiFRAD Telnet Server dialog box, you must enter your password before your choice is accepted.

MultiFRAD Configuration

The MultiFRAD Configuration option enables you to view and change parameters on the protocol stacks, high and low level device drivers, enable or disable the supported servers, configure MUX data ports, set up filtering and priority, or view system information.

```

Telnet - 192.168.2.16
Connect Edit Terminal Help

<< MultiFRAD Telnet Server >>

[ 1] MultiFRAD Configuration
[ 2] Remote User Database

Enter your choice (1 to 2, or EXIT) : 1

<< Main Menu >>

[ 1] Protocol Stacks
[ 2] High Level Device Drivers (HLDD)
[ 3] Low Level Device Drivers (LLDD)
[ 4] Others
[ 5] MUX Data Ports
[ 6] Voice Channels
[ 7] Regional
[ 8] Phone Book
[ 9] Filtering
[10] Priority
[11] System Information

Enter Your Choice (1 to 11, ESC to Previous menu, or EXIT): █

```

To select an option, enter the number of the option and hit the Enter key. For example, to select the Protocol Stacks option, type **1** <Enter>. For details on a parameter, refer to the online helps.

Remote User Database

The Remote User Database option from the MultiFRAD management menu allows you add and configure a list of users who will access the MultiFRAD remotely. After selecting Remote User Database (type **2** <Enter>) from the main menu, type **A** <Enter> to add a new user to the database. The following list of options is displayed:

```

Telnet - 192.168.2.16
Connect Edit Terminal Help
*
*      MultiFRAD 3000 Version 2.99C      *
*
*      Copyright (C) 1995 Multi-Tech Systems, Inc., *
*      Multi-Tech Systems, Inc., *
*      2205 Woodale Drive, Mounds View, *
*      Minnesota 55112, USA. *
*      http://www.multitech.com *
*
*****

      << MultiFRAD Telnet Server >>

[ 1] MultiFRAD Configuration
[ 2] Remote User Database

Enter your choice (1 to 2, or EXIT) : 2

Remote User DataBase can be configured only if the MultiFRAD is in PPP mode.
Configure it to PPP and then change the Remote User DataBase.

Enter your choice (1,or EXIT) : █

```

By selecting and configuring the various options and entering the desired information, you can construct a database of remote users for the MultiFRAD. For a detailed description of each option, refer to the online help provided in your MultiFRAD software.

WEB Browser Management

The MultiFRAD can be accessed, via a standard Web browser, from anywhere on the connected Internet. WEB Server must be checked (enabled) on the Others Setup dialog box to enable the function. Depending on the rights of the user (read/write, or read only), it is possible to view the current parameters and statistics of the MultiFRAD as well as configure and download setup changes to the MultiFRAD.

You can access MultiFRAD Configuration by typing the **IP Address** of the unit into the address line of your web browser. In this example, the IP address is 200.2.9.1.

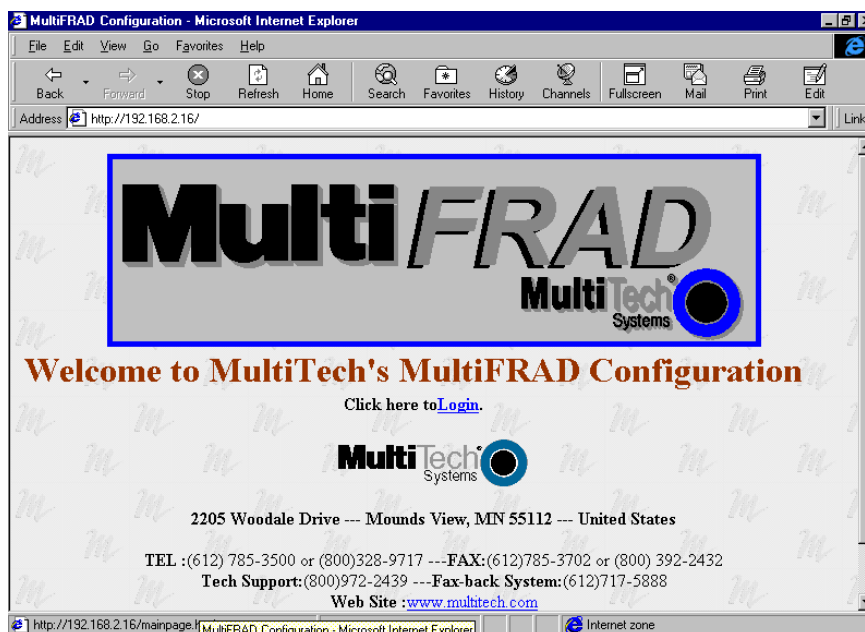

Click the word **Login** to gain access to the MultiFRAD. The following screen appears:

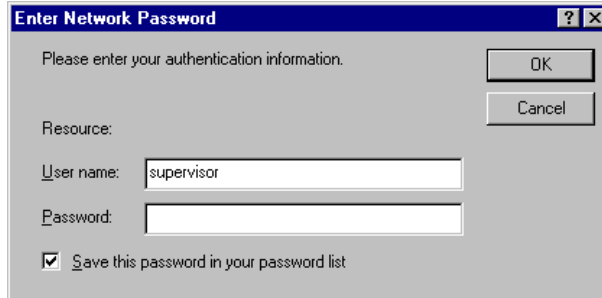

Enter Network Password

Please enter your authentication information.

OK

Cancel

Resource:

User name: supervisor

Password:

Save this password in your password list

Type **supervisor** in the **User Name** field (no password needed) and click **OK**. The **MultiFRAD 3000 Configuration** screen is displayed.

Note: the first user to access the MultiFRAD will have *read/write* rights over the unit. All subsequent users will have *read only* rights, and therefore, some of the options within the Web interface will be inactive (i.e., will not be linked).

From the **MultiFRAD 3000 Configuration** screen, you can access current settings and view statistics, as well as configure and download a new setup to the MultiFRAD.

Multi*FRAD*TM 3000-Series

Router/Multiport Data/Voice/Fax
Frame Relay Access Device

Chapter 6 - Warranty, Service and Tech Support

MultiTech[®]
Systems 

Introduction

This chapter provides the information necessary for receiving service or support for your MultiFRAD. The chapter starts with a description of the warranty, and continues with instructions for contacting the Service department, Technical Support group, and various Multi-Tech internet resources.

Limited Warranty

Multi-Tech Systems, Inc. ("MTS") warrants that its products will be free from defects in material or workmanship for a period of two years from the date of purchase, or if proof of purchase is not provided, two years from date of shipment. **MTS MAKES NO OTHER WARRANTY, EXPRESSED OR IMPLIED, AND ALL IMPLIED WARRANTIES OF MERCHANTABILITY AND FITNESS FOR A PARTICULAR PURPOSE ARE HEREBY DISCLAIMED.** This warranty does not apply to any products which have been damaged by lightning storms, water, or power surges or which have been neglected, altered, abused, used for a purpose other than the one for which they were manufactured, repaired by the customer or any party without MTS's written authorization, or used in any manner inconsistent with MTS's instructions.

MTS's entire obligation under this warranty shall be limited (at MTS's option) to repair or replacement of any products which prove to be defective within the warranty period, or, at MTS's option, issuance of a refund of the purchase price. Defective products must be returned by Customer to MTS's factory transportation prepaid.

MTS WILL NOT BE LIABLE FOR CONSEQUENTIAL DAMAGES AND UNDER NO CIRCUMSTANCES WILL ITS LIABILITY EXCEED THE PURCHASE PRICE FOR DEFECTIVE PRODUCTS.

On-line Warranty Registration

If you would like to register your MultiFRAD electronically, you can do so at the following address:

<http://www.multitech.com/register/>

Tech Support

Multi-Tech has an excellent staff of technical support personnel available to help you get the most out of your Multi-Tech product. If you have any questions about the operation of this unit, call 1-800-972-2439. Please fill out the MultiFRAD information (below), and have it available when you call. If your MultiFRAD requires service, the tech support specialist will guide you on how to send in your equipment (refer to the next section).

Recording MultiFRAD Information

Please fill in the following information on your MultiFRAD. This will help tech support in answering your questions. (The same information is requested on the Warranty Registration Card.)

Model No.: _____

Serial No.: _____

Software Version: _____

The model and serial numbers are on the bottom of your MultiFRAD.

Please note the type of external link device that is connected to your MultiFRAD before calling tech support. Also, note the status of your MultiFRAD including LED indicators, screen messages, diagnostic test results, DIP-Switch settings, problems with a specific application, etc. Use the space below to note the status:

Contacting Tech Support via E-mail

If you prefer to receive service on-line, via the internet, you can contact Tech Support via e-mail at the following address:

http://www.multitech.com/_forms/email_tech_support.htm

Service

If your tech support specialist decides that service is required, your MultiFRAD may be sent (freight prepaid) to our factory. Return shipping charges will be paid by Multi-Tech Systems.

Include the following with your MultiFRAD:

- a description of the problem.
- return billing and return shipping addresses.
- contact name and phone number.
- check or purchase order number for payment if the MultiFRAD is out of warranty. (Check with your technical support specialist for the standard repair charge for your MultiFRAD).
- if possible, note the name of the technical support specialist with whom you spoke.

If you need to inquire about the status of the returned product, be prepared to provide the **serial number** of the product sent.

Send your MultiFRAD to this address:

MULTI-TECH SYSTEMS, INC.
2205 WOODALE DRIVE
MOUNDS VIEW, MINNESOTA 55112
ATTN: SERVICE OR REPAIRS

You should also check with the supplier of your MultiFRAD on the availability of local service and/or loaner units in your part of the country.

The Multi-Tech BBS

For customers who do not have Internet access, Multi-Tech maintains a bulletin board system (BBS) that mirrors its FTP site. Information available from the BBS includes new product information, product upgrade files, and problem-solving tips. The phone number for the Multi-Tech BBS is (800) 392-2432 (USA and Canada) or (612) 785-3702 (international and local).

The BBS can be accessed by any asynchronous modem operating at 1200 bps to 33,600 bps at a setting of 8 bits, no parity, and 1 stop bit (8-N-1).

To log on to the Multi-Tech BBS

1. Set your communications program to **8-N-1**.
2. Dial our BBS at (800) 392-2432 (USA and Canada) or (612) 785-3702 (international and local).
3. At the prompts, type your first name, last name, and password; then press ENTER. If you are a first time caller, the BBS asks if your name is spelled correctly. If you answer yes, a questionnaire appears. You must complete the questionnaire to use the BBS on your first call.
4. Press ENTER until the Main Menu appears. From the Main Menu you have access to two areas: the Files Menu and News. For help on menu commands, type ?.

To Download a file

If you know the file name

1. From the Main Menu, type **F** to access the Files Menu, then type **D**.
2. Enter the name of the file you wish to download from the BBS.
3. If a password is required, enter the password.
4. Answer **Y** or **N** to the automatic logoff question.
5. Select a file transfer protocol by typing the indicated letter, such as **Z** for Zmodem (the recommended protocol).

6. If you select Zmodem, the transfer will begin automatically. If you select another protocol, you may have to initiate the transfer yourself. (In most datacomm programs, the PAGE DOWN key initiates the download.)
7. When the download is complete, press ENTER to return to the File Menu.
8. To exit the BBS, type **G** and press ENTER.

If you don't know the file name

1. From the Main Menu, type **F** to access the Files Menu. For a list of file areas, type **L**, press ENTER, then type **L** and press ENTER again. (If you do not type the second **L**, you will list all of the files on the BBS.)
2. Mark each file area you would like to examine by typing its list number and pressing ENTER.
3. Enter **L** to list all the files in the selected file areas. Enter **C** to go forward in the file list and **P** to go back.
4. To mark one or more files for download, type **M**, press ENTER, type the list numbers of the files, and press ENTER again.
5. Enter **D**. You will see a list of the files you have marked. Enter **E** if you would like to edit the list; otherwise enter **D** again to start the download process.
6. Select a file transfer protocol by typing the indicated letter, such as **Z** for Zmodem (the recommended protocol).
7. If you select Zmodem, the file will transfer automatically. If you select another protocol, you may have to initiate the transfer yourself. (In most data communications programs, the PAGE DOWN key initiates the download.)
8. When the download is complete, press ENTER to return to the File Menu.
9. To exit the BBS, type **G** and press ENTER.

About the Internet

Multi-Tech is a commercial user on the Internet, and we retrieve messages from our customers on a periodic basis. Multi-Tech's presence includes a Web site at:

<http://www.multitech.com>

and an ftp site at:

<ftp://ftp.multitech.com>

MultiFRADTM 3000-Series

Router/Multiport Data/Voice/Fax
Frame Relay Access Device

Appendices



Appendix A - Cabling Diagrams

Command Port Cable

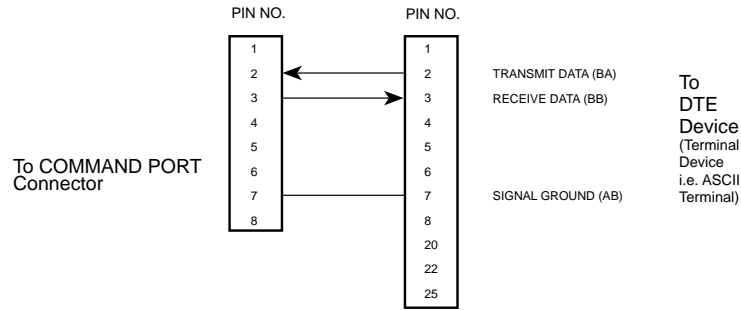
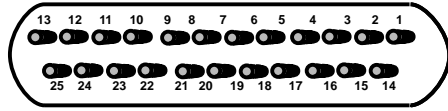

LAN Cables

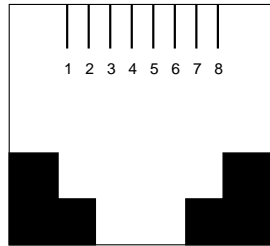

10BASE-T

10Base-T (RJ-45)

| Pin | Circuit | Signal Name |
|-----|---------|------------------------|
| 1 | TD+ | Data Transmit Positive |
| 2 | TD- | Data Transmit Negative |
| 3 | RD+ | Data Receive Positive |
| 6 | RD- | Data Receive Negative |

Voice/Fax Channel Connectors

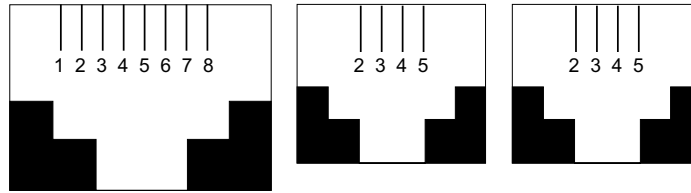

Pin Connections

| E&M | Description | FXO | Description | FXS | Description |
|-----|-------------|-----|-------------|-----|-------------|
| 1 | M | | | | |
| 2 | E | 2 | N/C | 2 | N/C |
| 3 | T1 | 3 | Ring | 3 | Tip |
| 4 | R | 4 | Tip | 4 | Ring |
| 5 | T | 5 | N/C | 5 | N/C |
| 6 | R1 | | | | |
| 7 | SG | | | | |

Trunk Cable

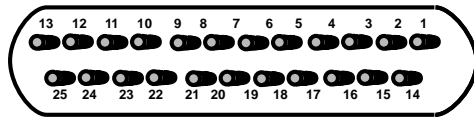

RS232C/V.24 * Link Cable

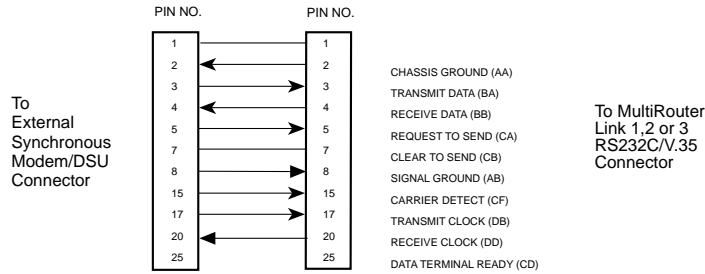

V.35 Adapter Cable Configured on a RS232C/V.35** Link Cable

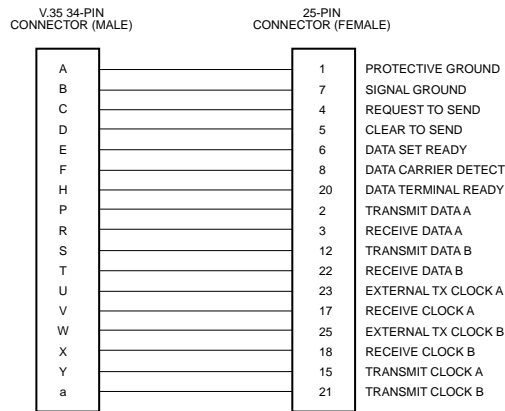
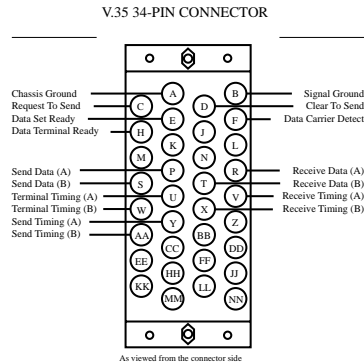

* The MultiRouter RS232C interface circuits have been designed to meet the electrical specifications given in EIA (Electronic Industries Association) RS232C and CCITT (Consultative Committee International Telegraph and Telephone) V.24 Standards.

** When configured for V.35 interface operation on the link, the V.35 adapter cable should be used. This cable uses a 25-pin female connector at one end and a 34-pin winchester male connector at the other end.

Remote Configuration Cable

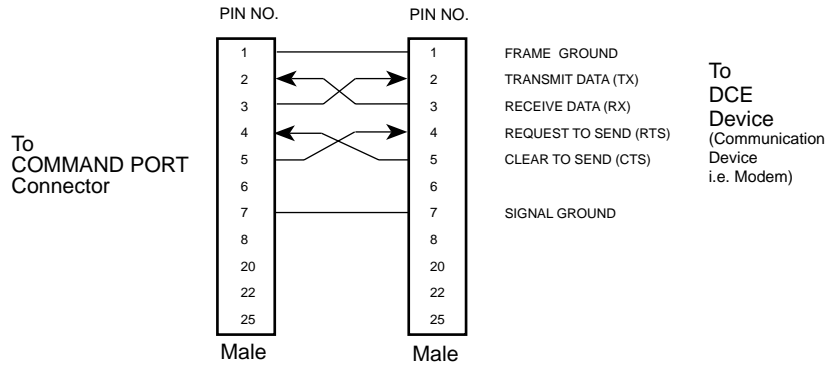

Appendix B - Regulatory Information

Note: This equipment has been tested and found to comply with the limits for a **Class A** digital device, pursuant to Part 15 of the FCC Rules. These limits are designed to provide reasonable protection against harmful interference when the equipment is operated in a commercial installation. This equipment generates, uses and can radiate radio frequency energy, and if not installed and used in accordance with the instructions, may cause harmful interference to radio communications. Operation of this equipment in a residential area is likely to cause harmful interference in which case the user will be required to correct the interference at his own expense.

Warning: Changes or modifications to this unit not expressly approved by the party responsible for compliance could void the user's authority to operate the equipment.

MultiFRADTM 3000-Series

Router/Multiport Data/Voice/Fax
Frame Relay Access Device

Glossary



A

Access: The T1 line element made up of two pairs of wire that the telephone company brings to the customer premises. The Access portion ends with a connection at the local telco (LEC or RBOC).

Accunet Spectrum of Digital Services (ASDS): The AT&T 56K bps leased (private) line service. Similar to services of MCI and Sprint. ASDS is available in $nx56/64K$ bps, where $n=1, 2, 4, 6, 8, 12$.

ACK (ACKnowledgement code) (pronounced "ack"): A communications code sent from a receiving modem to a transmitting modem to indicate that it is ready to accept data. It is also used to acknowledge the error-free receipt of transmitted data. Contrast with NAK.

Adaptive Differential Pulse Code (ADCPM): In multimedia applications, a technique in which pulse code modulation samples are compressed before they are stored on a disk. ADCPM, an extension of the PCM format, is a standard encoding format for storing audio information in a digital format. It reduced storage requirements by storing differences between successive digital samples rather than full values.

Address: A numbered location inside a computer. It's how the computer accesses its resources, like a video card, serial ports, memory, etc.

AMI line coding: One of two common methods of T1 line coding (with B8ZS). AMI line coding places restrictions on user data (B8ZS does not).

Analog signal: A waveform which has amplitude, frequency and phase, and which takes on a range of values between its maximum and minimum points.

Analog Transmission: One of two types of telecommunications which uses an analog signal as a carrier of voice, data, video, etc. An analog signal becomes a carrier when it is modulated by altering its phase, amplitude and frequency to correspond with the source signal. Compare with digital transmission.

Application Program Interface (API): A software module created to allow dissimilar, or incompatible applications programs to transfer information over a communications link. APIs may be simple or complex; they are commonly required to link PC applications with mainframe programs.

ASCII (American Standard Code for Information Interchange) (pronounced "askey"): A binary code for data that is used in communications and in many computers and terminals. The code is used to represent numbers, letters, punctuation and control characters. The basic ASCII code is a 7-bit character set which defines 128 possible characters. The extended ASCII file provides 255 characters.

Asynchronous Transfer Mode (ATM): A very high-speed method of transmission that uses fixed-size cells of 53 bytes to transfer information over fiber; also known as cell relay.

AT Commands: A standard set of commands used to configure various modem parameters, establish connections and disconnect. The "AT" is used to get the "attention" of the modem before the actual command is issued.

Availability: The measure of the time during which a circuit is ready for use; the complement of circuit "outage" (100% minus % outage = % available).

B

B7ZS (Bipolar 7 Zero Suppression) line coding: One method of T1 line coding (see also "B8ZS" and "AMI"). B7ZS line coding does not place restrictions on user data (AMI does).

B8ZS (Bipolar 8 Zero Suppression) line coding: One of two common methods of T1 line coding (with AMI). B8ZS line coding does not place restrictions on user data (AMI does). A coding method used to produce 64K bps "clear" transmission. (See also "B7ZS" and "AMI" line coding)

Backbone: 1. A set of nodes and their interconnecting links providing the primary data path across a network. 2. In a local area network multiple-bridge ring configuration, a high-speed link to which the rings are connected by means of bridges. A backbone may be configured as a bus or as a ring. 3. In a wide area network, a high-speed link to which nodes or data switching exchanges (DSEs) are connected. 4. A common distribution core that provides all electrical power, gases, chemicals, and other services to the sectors of an automated wayer processing system.

Background: An activity that takes place in the PC while you are running another application. In other words, the active user interface does not correspond to the 'background' task.

Bandwidth: The transmission capacity of a computer channel, communications line or bus. It is expressed in cycles per second (hertz), the bandwidth being the difference between the lowest and highest frequencies transmitted. The range of usable frequencies that a transmission medium will pass without unacceptable attenuation or distortion. Bandwidth is a factor in determining the amount of information and the speed at which a medium can transmit data or other information.

Backward Explicit Congestion Notification (BECN): A bit that tells you that a certain frame on a particular logical connection has encountered heavy traffic. The bit provides notification that congestion-avoidance procedures should be initiated in the opposite direction of the received frame. See also FECN (Forward Explicit Congestion Notification).

Basic Rate Interface (BRI): An ISDN access interface type comprised of two B-channels each at 64K bps and one D-channel at 64K bps (2B+D).

Bell Operating Companies (BOC): The family of corporations created during the divestiture of AT&T. BOCs are independent companies which service a specific region of the US. Also called Regional Bell Operating Companies (RBOCs).

Bell Pub 41450: The Bell publication defining requirements for data format conversion, line conditioning, and termination for direct DDS connection.

Bell Pub 62310: The Bell publication defining requirements for data format conversion, line conditioning, and termination for direct DDS connection.

Binary Synchronous Communication (BSC): A form of telecommunication line control that uses a standard set of transmission control characters and control character sequences, for binary synchronous transmission of binary-coded data between stations.

Bit (Binary digIT): A bit is the basis of the binary number system. It can take the value of 1 or 0. Bits are generally recognized as the electrical charge generated or stored by a computer that represent some portion of usable information.

Bit Error Rate Test (BERT): A device or routine that measures the quality of data transmission. A known bit pattern is transmitted, and the errors received are counted and a BER (bit error rate) is calculated. The BER is the ratio of received bits in error relative to the total number of bits received, expressed in a power of 10.

Bit robbing: The use of the least significant bit per channel in every sixth frame for signaling. The line signal bits "robbed" from the speech path conveys sufficient pre-ISDN telephony signaling information with the remaining line signal bits providing sufficient line signaling bits for recreating the original sound. See "robbed bit signaling".

Blue Alarm: An error indication signal consisting of all 1s indicating disconnection or attached device failure. Contrast "Red Alarm" and "Yellow Alarm".

Bps (bits per second): A unit to measure the speed at which data bits can be transmitted or received. Bps differs from baud when more than one bit is represented by a single cycle of the carrier.

Bridges: 1. A functional unit that interconnects two local area networks that use the same logical link protocol but may use different medium access control protocols. 2. A functional unit that interconnects multiple LANs (locally or remotely) that use the same logical link control protocol but that can use different medium access control protocols. A bridge forwards a frame to another bridge based on the medium access control (MAC) address. 3. In the connection of local loops, channels, or rings, the equipment and techniques used to match circuits and to facilitate accurate data transmission.

Buffer: A temporary storage register or Random Access Memory (RAM) used in all aspects of data communications which prevents data from being lost due to differences in transmission speed. Keyboards, serial ports, muxes and printers are a few examples of the devices that contain buffers.

Bus: A common channel between hardware devices either internally between components in a computer, or externally between stations in a communications network.

Byte: The unit of information a computer can handle at one time. The most common understanding is that a byte consists of 8 binary digits (bits), because that's what computers can handle. A byte holds the equivalent of a single character (such as the letter A).

C

Call Setup Time: The time to establish a circuit-switched call between two points. Includes dialing, wait time, and CO/long distance service movement time.

Carrier Group Alarm (CGA): A T1 service alarm generated by a channel bank when an OOF condition occurs for a predefined length of time (usually 300mS to 2.5 seconds). The CGA causes the calls using a trunk to be dropped and for trunk conditioning to be applied.

Carrier signal: An analog signal with known frequency, amplitude and phase characteristics used as a transport facility for useful information. By knowing the original characteristics, a receiver can interpret any changes as modulations, and thereby recover the information.

CCITT (Consultative Committee for International Telephone and Telegraph): An advisory committee created and controlled by the United Nations and headquartered in Geneva whose purpose is to develop and to publish recommendations for worldwide standardization of telecommunications devices. CCITT has developed modem standards that are adapted primarily by PTT (post, telephone and telegraph) organizations that operate telephone networks of countries outside of the U.S. See also ITU.

Central Office (CO): The lowest, or most basic level of switching in the PSTN (public switched telephone network). A business PABX or any residential telephone connects to the PSTN at a central office.

Centrex: A multi-line service offered by operating telcos which provides, from the telco CO, functions and features comparable to those of a PBX for large business users. See also "Private Branch Exchange", "Exchange".

Channel: A data communications path between two computer devices. Can refer to a physical medium (e.g., UTP or coax), or to a specific carrier frequency.

Channel bank: A device that acts as a converter, taking the digital signal from the T1 line into a phone system and converting it to the analog signals used by the phone system. A channel bank acts as a multiplexer, placing many slow-speed voice or data transactions on a single high-speed link.

Circuit-switched Network: A technology used by the PSTN that allocates a pair of conductors for the exclusive use of one communication path. Circuit switching allows multiple conversations on one talk path only if the end-users multiplex the signals prior to transmission.

Circuit switching: The temporary connection of two or more communications channels using a fixed, non-shareable path through the network. Users have full use of the circuit until the connection is terminated.

Clear Channel: A transmission path where the full bandwidth is used (i.e., no bandwidth needed for signaling, carrier framing or control bits). A 64K bps digital circuit usually has 8K bps used for signaling. ISDN has two 64K bps circuits, and a 16K bps packet service of which part is used for signaling on the 64K channels.

Client-Server: In TCP/IP, the model of interaction in distributed data processing in which a program at one site sends a request to a program at another site and awaits a response. The requesting program is called a client; the answering program is called a server.

Cluster Controller: A device that can control the input/output operations of more than one device connected to it. A cluster controller may be controlled by a program stored and executed in the unit, or it may be entirely controlled by hardware.

Committed Burst Size: the maximum number of bits that the frame relay network agrees to transfer during any measurement interval

Committed Information Rate (CIR): An agreement a customer makes to use a certain minimum data transmission rate (in bps). The CIR is part of the frame relay service monthly billing, along with actual usage, that users pay to their frame relay service provider.

Compression: 1. The process of eliminating gaps, empty fields, redundancies, and unnecessary data to shorten the length of records or blocks. 2. In SNA, the replacement of a string of up to 64-repeated characters by an encoded control byte to reduce the length of the data stream to the LU-LU session partner. The encoded control byte is followed by the character that was repeated (unless that character is the prime compression character). 3. In Data Facility Hierarchical Storage Manager, the process of moving data instead of allocated space during migration and recall in order to release unused space. 4. Contrast with decompression.

COMx Port: A serial communications port on a PC.

congestion: A network condition where there is too much data traffic. The ITU I.233 standard defines congestion management in terms of speed and burstiness.

congestion notification: The function in frame relay that ensures that userdata transmitted at a rate higher than the CIR are allowed to slow down to the rate of the available network bandwidth.

Consecutive Severely Errored Seconds (CSES): An error condition that occurs when from 3 to 9 SES (Severely Errored Seconds) are logged consecutively.

Customer Premise Equipment (CPE): The generic term for data comm and/or terminal equipment that resides at the user site and is owned by the user with the following exclusions: Over voltage protection equipment, inside wiring, coin operated or pay telephones, "company-official" equipment, mobile telephone equipment, "911" equipment, equipment necessary for the provision of communications for national defense, or multiplexing equipment used to deliver multiple channels to the customer.

D

D4: the T1 4th generation channel bank.

D4 channelization: Refers to the compliance with AT&T TR 62411 for DS1 frame layout.

D4 framing: The T1 format for framing in AT&T D-Series channel banks, in which there are 12 separate 193-bit frames in a super-frame. A D4 framing bit is used to identify the channel and the signaling frame. Signalling for voice channels is carried in-band for every channel, along with the encoded voice. See "robbed-bit signaling".

Data Communications Equipment (DCE): Any device which serves as the portal of entry from the user equipment to a telecommunications facility. A modem is a DCE for the telephone network (PSTN) that is commonly on site at the user's premises. Packet Switched Networks have another level of DCE which is most often located at a central office.

Data Link Connection Identifier (DLCI): One of the six components of a frame relay frame. Its purpose is to distinguish separate virtual circuits across each access connection. Data coming into a frame relay node is thus allowed to be sent across the interface to the specified "address". The DLCI is confirmed and relayed to its destination, or if the specification is in error, the frame is discarded.

Dataphone Digital Service (DDS): A private line digital service that offers 2400, 4800, 9600 and 56K bps data rates on an inter-LATA basis by AT&T and on an intra-LATA basis by the BOCs.

Data Service Unit (DSU): A device that provides a digital data service interface directly to the data terminal equipment. The DSU provides loop equalization, remote and local testing capabilities, and a standard EIA/CCITT interface.

Dedicated Line: A communication line that is not switched. The term leased line is more common.

Default: This is a preset value or option in software packages, or in hardware configuration, that is used unless you specify otherwise.

Device driver: Software that controls how a computer communicates with a device, such as a printer or mouse.

Digital Cross-connect System (DCS): The CO device which splits and redistributes the T1 bandwidth. the DCS takes time slots from various T1 lines and alters them to provide the needed connectivity. DCS connections are made with software at an administrator's workstation.

Digital Data: Information represented by discrete values or conditions (contrast "Analog Data").

Digital Loopback: A technique used for testing the circuitry of a communications device. Can be initiated locally, or remotely (via a telecommunications device). The tested device decodes and encodes a received test message, then echoes the message back. The results are compared with the original message to determine if corruption occurred en route.

Digital PBX: A Private Branch Exchange that operates internally on digital signals. See also "Exchange".

Digital Service, level 0 (DS0): The world-wide standard speed (64K bps) for digital voice conversation using PCM (pulse coded modulation).

Digital Service, level 1 (DS1): The 1.544M bps voice standard (derived from an older Bell System standard) for digitized voice transmission in North America. The 1.544M bps consists of 24 digitally-encoded 64K bps voice channels (north America) and 2.048M bps (30 channels) elsewhere.

Digital Signal: A discrete or discontinuous signal (e.g., a sequence of voltage pulses). Digital devices, such as terminals and computers, transmit data as a series of electrical pulses which have discrete jumps rather than gradual changes.

Digital Signaling Rates (DSn): A hierarchical system for transmission rates, where "DS0" is 64K bps (equivalent to ISDN B channel), and DS1 is 1.5 Mbps (equivalent to ISDN PRI).

Digital Transmission: A method of electronic information transmission common between computers and other digital devices. Analog signals are waveforms: a combination of many possible voltages. A computer's digital signal may be only "high" or "low" at any given time. Therefore, digital signals may be "cleaned up" (noise and distortion removed) and amplified during transmission.

Digitize: To convert an analog signal to a digital signal.

DIP switch (pronounced "dip switch"): A set of tiny toggle switches, built into a DIP (dual in-line package), used for setting configurable parameters on a PCB (printed circuit board).

Driver: A software module that interfaces between the Operating System and a specific hardware device (i.e. color monitors, printers, hard disks, etc.). Also known as a device driver.

Drop and Insert: The process where a portion of information carried in a transmission system is demodulated ("Dropped") at an intermediate point and different information is included ("Inserted") for subsequent transmission.

DTE (Data Terminating Equipment): A term used to include any device in a network which generates, stores or displays user information. DTE is a telecommunications term which usually refers to PCs, terminals, printers, etc.

DTMF (Dual-Tone MultiFrequency): A generic push-button concept made popular by AT&T TouchTone.

E

E&M: A telephony trunking system used for either switch-to-switch, or switch-to-network, or computer/telephone system-to-switch connection.

EIA: The Electronics Industries Association is a trade organization in Washington, DC that sets standard for use of its member companies. (See RS-232, RS-422, RS530.)

Encapsulation: A technique used by network-layer protocols in which a layer adds header information to the protocol data unit from the preceding layer. Also used in "enveloping" one protocol inside another for transmission. For example, IP inside IPX.

Errored Seconds (ES): Any second of operation that all 1.544M bits are not received exactly as transmitted. Contrast "Error Free Seconds".

Error Free Seconds (EFS): Any second of operation that all 1.544M bits are received exactly as transmitted. Contrast "Errored Seconds".

ESF Error Event: A T1 error condition that is logged when a CRC-6 error or an OOF error occurs.

Ethernet: A 10-megabit baseband local area network that allows multiple stations to access the transmission medium at will without prior coordination, avoids contention by using carrier sense and deference, and resolves contention by using collision detection and transmission. Ethernet uses carrier sense multiple access with collision detection (CSMA/CD).

Excess Zeros: A T1 error condition that is logged when more than 15 consecutive 0s or less than one 1 bit in 16 bits occurs.

Exchange: A unit (public or private) that can consist of one or more central offices established to serve a specified area. An exchange typically has a single rate of charges (tariffs) that has previously been approved by a regulatory group.

Exchange Area: A geographical area with a single uniform set of charges (tariffs), approved by a regulatory group, for telephone services. Calls between any two points within an exchange area are local calls. See also "Digital PBX", "PBX".

Exchange Termination (ET): The carrier's local exchange switch. Contrast with "Loop Termination - LT".

Explicit Congestion Management: The method used in frame relay to notify the terminal equipment that the network is overly busy. The use of FECN and BECN is called explicit congestion management. Some end-to-end protocols use FECN or BECN, but usually not both options together. With this method, a congestion condition is identified and fixed before it becomes critical. Contrast with "implicit congestion".

Extended Super Frame (ESF): One of two popular formats for framing bits on a T1 line. ESF framing has a 24-frame super-frame, where robbed bit signaling is inserted in the LSB (bit 8 of the DS-0 byte) of frames 6, 12, 18 and 24. ESF has more T1 error measurement capabilities than D4 framing. ESF and B8ZS are typically both offered to provide clear channel service.

F

Failed Seconds: A test parameter where the circuit is unavailable for one full second.

Failed Signal: A T1 test parameter logged when there are more than 9 SES (Severely Errored Seconds).

Fax (facsimile): Refers to the bit-mapped rendition of a graphics-oriented document (fax) or to the electronic transmission of the image over telephone lines (faxing). Fax transmission differs from data transmission in that the former is a bit-mapped approximation of a graphical document and, therefore, cannot be accurately interpreted according to any character code.

Firmware: A category of memory chips that hold their content without electrical power, they include ROM, PROM, EPROM and EEPROM technologies. Firmware becomes "hard software" when holding program code.

Foreground: The application program currently running on and in control of the PC screen and keyboard. The area of the screen that occupies the active window. Compare with "background".

Fractional T1 (FT1): A digital data transmission rate between 56K bps (DS0 rate) and 1.544M bps (the full T1 rate - in North America). FT1 is typically provided on 4-wire (two copper pairs) UTP. Often used for video conferencing, imaging and LAN interconnection due to its low cost and relatively high speed. FT1 rates are offered in 64K bps multiples, usually up to 768K bps.

Frequency: A characteristic of an electrical or electronic signal which describes the periodic recurrence of cycles. Frequency is inversely proportional to the wavelength or pulse width of the signal (i.e., long wavelength signals have low frequencies and short wavelength signals yield high frequencies).

Foreign Exchange (FX): A CO trunk with access to a distant CO, allowing ease of access and flat-rate calls anywhere in the foreign exchange area.

Foreign Exchange Office (FXO): provides local telephone service from a CO outside of ("foreign" to) the subscriber's exchange area. In simple form, a user can pick up the phone in one city and receive a tone in the foreign city.

Connecting a POTS telephone to a computer telephony system via a T1 link requires a channel bank configured for the FX connection. To generate a call from the POTS set to the computer telephony system, a FXO connection must be configured.

Foreign Exchange Station (FXS): See FX, FXO. To generate a call from the computer telephony system to the POTS set, a FXS connection must be configured.

Forward Explicit Congestion Notification (FECN): A bit that tells you that a certain frame on a particular logical connection has encountered heavy traffic. The bit provides notification that congestion-avoidance procedures should be initiated in the same direction of the received frame. See also BECN (Backward Explicit Congestion Notification).

Frame: A group of data bits in a specific format to help network equipment recognize what the bits mean and how to process them. The bits are sent serially, with a flag at each end signifying the start and end of the frame.

Frame Relay: A form of packet switching that uses small packets and that requires less error checking than other forms of packet switching. Frame relay is effective for sending "bursty" data at high speeds (56/64K, 256K, and 1024K bps) over wide area networks. Frame Relay specifications are defined by ANSI documents ANSI T1.602, T1.606, T1S1/90-175, T1S1/90-213, and T1S1/90-214. In using frame relay, blocks of information (frames) are passed across a digital network interface using a "connection number" that is applied to each frame to distinguish between individual frames.

Frame Relay Forum: A non-profit organization of 300+ vendors and service providers, based in Foster City, CA, that are developing and deploying frame relay equipment.

Frame Relay Implementors Forum: A group of companies supporting a common specification for frame relay connection to link customer premises equipment to telco network equipment. Their specification supports ANSI frame relay specs and defines extensions such as local management.

Frame Relay Access Device (FRAD): A piece of equipment that acts as a concentrator or frame assembler/dissassembler that can support multiple protocols and provide basic "routing" functions.

G

Gateway: 1. A functional unit that interconnects two computer networks with different network architectures. A gateway connects networks or systems of different architectures. A bridge interconnects networks or systems with the same or similar architectures. 2. A network that connects hosts.

Graphical User Interface (GUI): A type of computer interface consisting of a visual metaphor of a real-world scene, often of a desktop. Within that scene are icons, representing actual objects, that the user can access and manipulate with a pointing device.

H

Handshaking: A process that two modems go through at the time of call setup to establish synchronization over the data communications link. It is a synchronization and negotiation process accomplished by the exchange of predefined, mutually recognized control codes.

High-level Data Link Control (HDLC): An ISO standard, bit-oriented data communications protocol that provides nearly error-free data transfers.

I

Hexadecimal: A base 16 numbering system used to represent binary values. Hex uses the numbers 0-9 and the letters A-F: usually notated by an "h" (e.g., "4CF h", read "four charley fox, hex"). The result is that one hex digit represents a 4-bit value.

Implicit congestion management: A method of informing the terminal that the network is busy. This method relies on the end-system protocol to detect and fix the congestion problem. (TCP/IP is an example of a protocol using only implicit congestion management.) See also "explicit congestion management".

In-band: Refers to the type of signalling over the conversion path on an ISDN call. Contrast "out-of-band".

Insufficient Ones: A T1 error condition that is logged when less than one 1 in 16 0s or less than 12.5 % average 1s density is received.

Inter Exchange Carrier (IEC): The long distance company (LE) who's central office provides the point of reference for T1 access. Any common carrier authorized by the FCC to carry customer transmissions between LATAs.

Internet: Refers to the computer network of many millions of university, government and private users around the world. Each user has a unique Internet Address.

Internet Address (IP Address): A unique 32-bit address for a specific TCP/IP host on a network. Normally printed in dotted decimal format (e.g., 129.128.44.227).

Internet Protocol (IP): A protocol used to route data from its source to its destination in an Internet environment. The Internet Protocol was designed to connect to local area networks. Although there are many protocols that do this, IP refers to the global system of interconnecting computers. It is a highly distributed protocol (each machine only worries about sending data to the next step in the route).

Internetwork Packet Exchange (IPX): A NetWare communications protocol used to route messages from one node to another. IPX packets include network addresses and can be routed from one network to another. An IPX packet can occasionally get lost when crossing networks, thus IPX does not guarantee delivery of a complete message. Either the application has to provide that control, or NetWare's SPX protocol must be used.

Interoperable: Devices from different vendors that can exchange information using a standard's base protocol.

I/O Addresses: Locations within the I/O address space of your computer used by a device, such as an expansion card, a serial port, or an internal modem. The address is used for communication between software and a device.

IRQ Level (Interrupt Request Level): The notification a processor receives when another portion of the computer's hardware requires its attention. IRQs are numbered so that the device issuing the IRQ can be identified, and so IRQs can be prioritized.

ISA (Industry Standards Architecture) (pronounced "ice a"): The classic 8 or 16-bit architecture introduced with IBM's PC-AT computer.

ISDN (Integrated Services Digital Network): An International telecommunications standard for transmitting voice, video and data over a digital communications line. ISDN is a world-wide telecommunications service that uses digital transmission and switching technology to support voice and digital data communications. Frame relay was partially based on ISDN's data link layer protocol (LAPD). Frame relay can be used to transmit across ISDN services offering circuit-switched connection at 64K bps and higher speeds. Contrast Public Switched Telephone Network (PSTN).

ITU-TSS (formerly CCITT): International Telecommunications Union-Telecommunications Sector; the United Nations organization that prepares standards ("Recommendations") for resolving communications issues and problems.

K

Key Telephone System (KTS): Phone devices with multiple buttons that let you select incoming or outgoing CO phone lines directly. Similar in operation to a PBX, except a KTS you don't have to dial a "9" for a call outside the building.

Key Service Unit (KSU): A small device containing the switching electronics for a business key telephone system (KTS).

Key Set: A telephone set with several buttons for call holding, line pickup, intercom, autodialing, etc. Also called a touchtone phone (Ericsson) and a KTS (Key Telephone Set).

L

LAPB: Link Access Procedure Balanced; based on the X.25 Layer 2 specification. A full-duplex point-to-point bit-synchronous protocol commonly used as a data link control protocol to interface X.25 DTEs. LAPB is the link initialization procedure that establishes and maintains communications between the DTE and the DCE.

LAPD: Link Access Protocol for the D-Channel; based on the ISDN Q.921 specification. A full-duplex point-to-point bit-synchronous link-level protocol for ISDN connections; different from LAPB in its framing sequence. Transmission is in units called "frames", and a frame may contain one or more X.25 packets.

Line Coding: The representation of 1s and 0s on a T1 line. The two methods of line coding commonly used, B8ZS and AMI, differ in the restrictions placed on user data. T1 line coding ensures that sufficient timing information is sent with the digital signal to ensure recovery of all the bits at the far end. Timing information on the T1 line is included in the form of 1s in the data stream; a long string of 0s in the data stream could cause problems recovering the data.

Line Termination (LT): The electronics at the ISDN network side of the user/network interface that complements the NT1 at the user side. The LT and the NT1 together provide the high-speed digital line signals required for BRI access.

Listed Directory Number (LDN): The main number assigned by the telco; the number listed in the telephone directory and also provided by Directory Assistance. Some devices can have more than one LDN, such as ISDN devices that have one LDN for voice and another LDN for data.

Local Area Network (LAN): 1. A computer network located on a user's premises within a limited geographical area. Communication within a local area network is not subject to external regulations; however, communication across the LAN boundary may be subject to some form of regulation. 2. A LAN does not use store and forward techniques. 3. A network in which a set of devices are connected to one another for a communication and that can be connected to a larger network.

Local Access and Transport Area (LATA): A post-divestiture geographical area generally equivalent to a Standard Metropolitan Statistical Area. At divestiture, the territory served by the Bell system was divided into approximately 161 LATAs. The Bell Operating Companies (BOCs) provide Intra-LATA services.

Local Exchange Carrier (LEC): The local phone company which provides local (i.e., not long distance) transmission services. AKA "telco". LECs provide T1 or FT1 access to LDCs (unless the T1 circuit is completely intra-LATA). Inter-LATA T1 circuits are made up of a combination of Access and Long Haul facilities.

Local Management Interface (LMI): A specification for frame relay equipment that defines status information exchange.

Local Loop: A transmission path, typically twisted-pair wire, between an individual subscriber and the nearest public telecommunications network switching center. The wires provide ISDN service, but require an NT1 at the user end and an LT at the network end. (AKA, "loop" or "subscriber loop".)

Logical Link Control (LLC2): In a local area network, the protocol that governs the exchange of transmission frames between data stations independently of how the transmission medium is shared. The LLC2 protocol was developed by the IEEE 802 committee and is common to all LAN standards.

Logical Unit (LU): A type of network accessible unit that enables end users to gain access to network resources and communicate with each other.

Long Haul: The T1 element that connects to the Access portion of the long distance company's (LDC's) central office. The LDC is commonly called the point of presence (POP). Each LDC has a number of POPs, located throughout the country. The LDC is also called an IEC (Inter Exchange Carrier).

Long Haul Communications: The type of phone call reaching outside of a local exchange (LE).

M

Management Information Base (MIB): A database of network management information used by the Common Management Information Protocol (CMIP) and the Simple Network Management Protocol (SNMP).

Megacom: An AT&T service with a normal WATS line (typically T1) between the customer premise and the AT&T serving class 4 CO are the customer's responsibility.

MegaLink: BellSouth's leased T1 service.

Message: Associated with such terms as packet, frame, and segment. 1. In information theory, an ordered series of characters intended to convey information. 2. An assembly of characters and sometimes control codes that is transferred as an entry from an originator to one or more recipients.

Modem: A communications device that enables a computer to transmit information over a telephone line. It converts the computer's digital signals into analog signals to send over a telephone line and converts them back to digital signals at the receiving end. Modems can be internal and fit into an expansion slot, or external and connect to a serial port.

Multiplexer (Mux): 1. A device that takes several input signals and combines them into a single output signal in such a manner that each of the input signals can be recovered. 2. A device capable of interleaving the events of two or more activities or capable of distributing the events of an interleaved sequence to the respective activities. 3. Putting multiple signals on a single channel.

Multiprotocol: A device that can interoperate with devices utilizing different network protocols.

Multithreading: The ability of a software system to be able to handle more than one transaction concurrently. This is contrasted to the case where a single transaction is accepted and completely processed before the next transaction processing is started.

N

Nailed Connection: A permanent or dedicated circuit of a previously switched circuit or circuits.

Nailed-up Circuit: A semipermanent circuit established through a circuit-switching facility for point-to-point connectivity.

NAK (Negative Acknowledgment): Communications code used to indicate that a message was not properly received, or that a terminal does not wish to transmit. Contrast with ACK.

Network: A group of computers connected by cables or other means and using software that enables them to share equipment, such as printers and disk drives to exchange information.

Node: Any point within a network which has been assigned an address.

O

Object-Orientated: A method for structuring programs as hierarchically organized classes describing the data and operations of objects that may interact with other objects.

Office Channel Unit - Data Port (OCU-DP): The CO channel bank used as the interface between the customer's DSU and the channel bank.

Off-hook: The condition of a device which has accessed a phone line (with or without using the line). In modem use, this is equivalent to a telephone handset being picked up. Dialing and transmission are allowed, but incoming calls are not answered. Contrast "on-hook".

Off Premise Extension (OPX): An extension or phone that terminates in a location other than that of the PBX. Commonly used to provide a corporate member with an extension of the PBX at home.

Ones Density: the measure of the number of logical 1s on a T1 line compared to a given total number of bits on that line; used for timing information in data recovery in AMI and B8ZS.

On-Hook: The condition of a device which has not accessed a phone line. In modem use, this is equivalent to a telephone handset that has not been picked up. In other words, it can receive an incoming call. Contrast "off-hook".

Open Shortest Path First (OSPF): A hierarchical Interior Gateway Protocol (IGP) routing algorithm for IP that is a proposed standard for Internet. OSPF incorporates least-cost routing, equal-cost routing, and load balancing.

Outage: The measure of the time during which a circuit is not available for use due to service interrupt. Outage is the complement of circuit "availability" (100% minus % available = % outage).

Out-of-band: Signaling that is separated from the channel carrying the information (i.e., the voice/data/video signal is separate from the carrier signal). Dialing and various other "supervisory" signals are included in the signaling element. Contrast "In-band" signaling.

Out of Frame (OOF): A T1 alarm condition that is logged on the loss of 2, 3 or 4 of 5 consecutive FT framing bits.

P

Packet: 1. In data communication, a sequence of binary digits, including data and control signals, that is transmitted and switched as a composite whole. The data, control signals and, possibly, error control information are arranged in a specific format. 2. Synonymous with data frame. 3. In TCP/IP, the unit of data passed across the interface between the Internet layer and the link layer. A packet includes an IP header and data. A packet can be a complete IP datagram or a fragment of an IP diagram. 4. In X.25, a data transmission information unit. A group of data and control characters, transferred as a unit, determined by the process of transmission. Commonly used data field lengths in packets are 128 or 256 bytes. 5. The field structure and format defined in the CCITT X.25 recommendation.

Packet Assembler/Disassembler (PAD): Used by devices to communicate over X.25 networks by building or stripping X.25 information on or from a packet.

Packet Data: The information format ("packetized") used for packet-mode calls.

Packet Mode: Refers to the switching of chunks of information for different users using statistical multiplexing to send them over the same transmission facility.

Parity bit: An extra bit attached to each byte of synchronous data used to detect errors in transmission.

Permanent Virtual Circuit (PVC): A connection between two endpoints dedicated to a single user. IN ISDN, PVCs are established by network administration and are held for as long as the user subscribes to the service.

Physical Unit (PU): The component that manages and monitors the resources (such as attached links and adjacent link stations) associated with a node, as requested by an SSCP via an SSCP-PU session. An SSCP activates a session with the physical unit in order to indirectly manage, through the PU, resources of the node such as attached links. This term applies to type 2.0, type 4, and type 5 nodes only.

Point of Presence (POP): The central office's end points of the long distance carriers.

Point to Point Protocol (PPP): A protocol that lets a PC user access TCP/IP (Internet member) using an ISDN terminal adapter or a high-speed modem over a standard telephone line.

Port: A location for input or output data exchange. Computers, muxes, etc. have ports for various purposes.

Primary Rate Interface (PRI): Used on ISDN. In North America, and Japan, PRI is one 64Kbps D channel and 23 B channels. Elsewhere, it is one D channel and 30 B channels.

Primitive: An abstract representation of interaction across the access points indicating that information is being passed between the service user and the service provider. The OSI Reference Model defines four types of primitives: Request, Indication, Response and Confirm.

Private Branch Exchange (PBX): A telephone exchange located on the customer's premises. The PBX provides a circuit switching facility for telephone extension lines within the building, and access to the public telephone network. See also "Exchange".

PROM (Programmable Read Only Memory - pronounced "prom"): A permanent memory chip that can be programmed or filled by the customer after the manufacturer has set initial values. Contrast with ROM.

Protocol: 1. A set of semantic and syntactic rules that determines the behavior of functional units in achieving communication. 2. In Open Systems Interconnection architecture, a set of semantic and syntactic rules that determine the behavior of entities in the same layer in performing communication functions. 3. In SNA, the meanings of and the sequencing rules for requests and responses used for managing the network, transferring data, and synchronizing the states of network components. 4. Synonymous with line control discipline.

PSTN (Public Switched Telephone Network): A worldwide public voice telephone network that is used as a telecommunications medium for the transmission of voice, data and other information.

Public Data Network (PDN): A packet-switched network that is available to the public for individual ("subscriber") use. Typically, controlled by a government or a national monopoly.

Public Switched Telephone Network (PSTN): The group of circuit-switching voice carriers, which are commonly used as analog data communications services.

Pulse Code Modulation (PCM): 1. In data communication, variation of a digital signal to represent information; for example, by means of pulse amplitude modulation (PAM), pulse duration modulation (PDM), or pulse position modulation (PPM). 2. Transmissions of analog information in digital form through sampling and encoding the samples with a fixed number of bits.

Pulse dialing: One of two methods of dialing a telephone, usually associated with rotary-dial phones. Compare with "tone dialing".

Q

Quantizing: The process of analog-to- digital conversion by assigning a range, from the contiguous analog values, to a discrete number.

R

Random Access Memory (RAM): A computer's primary workspace. All data must be stored in RAM (even for a short while), before software can use the processor to manipulate the data. Before a PC can do anything useful it must move programs from disk to RAM. When you turn it off, all information in RAM is lost.

Rate Enforcement: The concept in frame relay where frames sent faster than the CIR are to be carried only if the bandwidth is available, otherwise they are to be discarded. (The frame relay network assumes that anything exceeding the CIR is of low priority.) Rate enforcement makes sure that the network will not get so congested that it isn't able to meet the agreed on CIR

Recognized Private Operating Agency (RPOA): A corporation, private or government-controlled, that provides telecommunications services. RPOAs, such as AT&T, participate as non-voting members in the CCITT.

Red Alarm: A T1 error condition generated when a local failure (e.g., loss of synchronization) exists for 2.5 seconds, causing a Carrier Group Alarm (CGA). See also "Blue Alarm" and "Yellow Alarm".

Request for Comment (RFC): A set of papers in which Internet standards (published and proposed), along with generally-accepted ideas, proposals, research results, etc. are published.

Ring Down Box: A device that emulates a CO by generating POTS calls for testing and product demos.

Ring Down Circuit: A tie line connecting phones where picking up one phone automatically rings another phone. A feature used for emergencies to alert the person at the other phone of the incoming call.

RJ-11: An industry standard interface used for connecting a telephone to a modular wall outlet; comes in 4-and 6-wire packages.

RJ-45: An 8-wire modular connector for voice and data circuits.

Robbed Bit Signaling: The popular T1 signaling mechanism where the A and B bits are sent by each side of the T1 termination and are "buried" in the voice data of each voice channel in the T1 circuit. Since the bits are "robbed" infrequently, voice quality is remains relatively uncompromised. See "bit robbing".

The robbed-bit signaling technique is used in D4 channel banks to convey signaling information. The eighth (least significant) bit of each of the 24 8-bit time slots is "robbed" every sixth frame to convey voice-related signaling information such as on-hook, off-hook, etc., for each channel.

MultiFRAD: A device that connects two networks using the same networking protocol. It operates at the Network Layer (Layer 3) of the OSI model for forwarding decisions.

Routing Information Protocol (RIP): A distance vector-based protocol that provides a measure of distance, or hops, from a transmitting workstation to a receiving workstation.

RS232-C: An EIA standard for a serial interface between computers and peripheral devices (modem, mouse, etc.). It uses a 25-pin DB-25, or a 9-pin DB-9 connector. The RS-232 standard defines the purposes, electrical characteristics and timing of the signals for each of the 25 lines.

RS-422: The EIA standard for a balanced interface with no accompanying physical connector. RS-422 products can use screw terminals, DB-9, various DB-25, and DB-37 connectors.

RS-530: The EIA standard for the mechanical/electrical interface between DCEs and DTEs transmitting synchronous or asynchronous serial binary data. RS-530 provides for high data rates with the same connector used for RS-232; however, it is incompatible with RS-232.

S

Serial Port: The connector on a PC used to attach serial devices (those that need to receive data one bit after another), such as a mouse, a printer or a modem. This consists of a 9- or 25-pin connector that sends data in sequence (bit by bit). Serial ports are referred to as "COMx" ports, where x is 1 to 4 (i.e., COM1 through COM4). A serial port contains a conversion chip called a "UART" which translates between internal parallel and external serial formats.

Service: The requirements offered by an RPOA to its customers to satisfy specific telecommunications needs.

Severely Errored Seconds (SES): Refers to a typical T1 error event where an error burst occurs (a short term, high bit-error rate that is self-clearing). Per the ITU-T (CCITT) G.821: any second in which the BER is less than 1×10^{-3} .

Signaling: The process of establishing, maintaining, accounting for, and terminating a connection between two endpoints (e.g., the user premises and the telco CO). Central office signals to the user premises can include ringing, dial tone, speech signals, etc. Signals from the user's telephone can include off-hook, dialing, speech to far-end party, and on-hook signals.

In-band signaling techniques include pulse and tone dialing. With common channel signaling, information is carried out-of-band.

Simple Network Management Protocol (SNMP): TCP/IP protocol that allows network management.

Simultaneous Voice Data (SVD): A technology for letting a user send data via a modem, and use a handset to talk to another user at the same time over the same connection. The alternative, making a second call, can be expensive or even impossible. The uses for SVD are telecommuting, videoconferencing, distant learning, tech support, etc.

Stop Bit: One of the variables used for timing in asynchronous data transmission. Depending on the devices, each character may be trailed by 1, 1.5, or 2 stop bits.

Superframe (D4): A T1 transmission format that consists of 12 DS1 frames, or 2316 bits. A DS1 frame consists of 193 bit positions. A frame overhead bit is in the first position, and it is used for frame and signaling phase alignment only.

Subscriber Loop: See "Local loop".

Switched 56: A circuit-switched (full duplex digital synchronous data transmission) service that lets you dial a number and transmit data to it at 56K bps. It is a relatively low cost service, widely used in North America for telecommuting, videoconferencing and high speed data transfers. Many phone companies are (or will be) phasing out Switched 56 in favor of ISDN service.

Switched Virtual Circuit (SVC): A type of data transmission where the connection is maintained only until the call is cleared.

Switched Line: In communications, a physical channel established by dynamically connecting one or more discreet segments. This connection lasts for the duration of the call after which each segment may be used as part of a different channel. Contrast with leased line.

Switched Network: A network in which a temporary connection is established from one point via one or more segments.

Synchronous Data Link Control (SDLC): A discipline conforming to subsets of the Advanced Data Communications Control Procedures (ADCCP) of the American National Standards Institute (ANSI) and High-level Data Link Control (HDLC) of the International Organization for Standardization, for managing synchronous, code-transparent, serial-by-bit information transfer over a link connection. Transmission exchanges may be duplex, or half-duplex over switched or nonswitched links. The configuration of the link connection may be point-to-point, multipoint, or loop.

Synchronous Transmission: The transmission of data which involves sending a group of characters in a packet. This is a common method of transmission between computers on a network or between modems. One or more synchronous characters are transmitted to confirm clocking before each packet of data is transmitted. Compare to Asynchronous Transmission.

T1 Line: A digital communications facility that functions as a 24-channel pathway for data or voice. A T1 line is composed of two separate elements: the Access element and the Long Haul element.

T1 Mux: A device used to carry many sources of data on a T1 line. The T1 mux assigns each data source to distinct DS0 time slots within the T1 signal. Wide bandwidth signals take more than one time slot. Normal voice traffic or 56/64K bps data channels take one time slot. The T1 mux may use an internal or external T1 DSU; a "channel bank" device typically uses an external T1 CSU.

Transmission Control Protocol / Internet Program (TCP/IP): A multilayer set of protocols developed by the US Department of Defense to link dissimilar computers across dissimilar and unreliable LANs.

Terminal: The screen and keyboard device used in a mainframe environment for interactive data entry. Terminals have no "box", which is to say they have no file storage or processing capabilities.

Terminal Adapter (TA): An ISDN DTE device for connecting a non-ISDN terminal device to the ISDN network. Similar to a protocol converter or an interface converter, a TA connects a non-ISDN device between the R and S interfaces. Typically a PC card.

Tie line: A dedicated circuit linking two points without having to dial a phone number (i.e., the line may be accessed by lifting the telephone handset or by pushing a button).

Time-Division Multiplexing (TDM): Division of a transmission facility into two or more channels by allotting the common channel to several different information channels, one at a time.

Time Slot: One of 24 channels within a T1 line. Each channel has a 64K bps maximum bandwidth. "Time slot" implies the time division multiplexing organization of the T1 signal.

Toll Call: A call to a location outside of your local service area (i.e., a long distance call).

Tone dialing: One of two methods of dialing a telephone, usually associated with Touch-Tone® (push button) phones. Compare with pulse dialing.

Topology: Physical layout of network components (cables, stations, gateways, and hubs). Three basic interconnection topologies are star, ring, and bus networks.

Transmission Control Protocol (TCP): A communications protocol used in Internet and in any network that follows the US Department of Defense standards for internetwork protocol. TCP provides a reliable host-to-host protocol between hosts in packet-switched communications networks and in interconnected systems of such networks. It assumes that the Internet protocol is the underlying protocol.

Transport Layer: Layer 4 of the Open Systems Interconnection (OSI) model; provides reliable, end-to-end delivery of data, and detects transmission sequential errors.

Transport Protocol Data Unit (TPDU): A transport header, which is added to every message, contains destination and source addressing information that allows the end-to-end routing of messages in multi-layer NAC networks of high complexity. They are automatically added to messages as they enter the network and can be stripped off before being passed to the host or another device that does not support TPDU's.

Trunk: Transmission links that interconnect switching offices.

TSR (terminate and stay resident): A software program that remains active and in memory after its user interface is closed. Similar to a daemon in UNIX environments.

Tunneling: Encapsulation data in an IP packet for transport across the internet.

Twisted pair wiring: A type of cabling with one or more pairs of insulated wires wrapped around each other. An inexpensive wiring method used for LAN and telephone applications, also called UTP wiring.

U

UART (Universal Asynchronous Receiver/Transmitter) (pronounced "you art"): A chip that transmits and receives data on the serial port. It converts bytes into serial bits for transmission, and vice versa, and generates and strips the start and stop bits appended to each character.

UNIX: An operating system developed by Bell Laboratories that features multiprogramming in a multi-user environment.

Unshielded Twisted Pair (UTP): Telephone-type wiring. Transmission media for 10Base-T.

V

V.25bis: An ITU-T standard for synchronous communications between a mainframe or host and a modem using HDLC or other character-oriented protocol.

V.54: The ITU-T standard for local and remote loopback tests in modems, DCEs and DTEs. The four basic tests are:

- local digital loopback (tests DTE send and receive circuits),
- local analog loopback (tests local modem operation),
- remote analog loopback (tests comm link to the remote modem), and
- remote digital loopback (tests remote modem operation).

Virtual Circuit: A logical connection. Used in packet switching wherein a logical connection is established between two devices at the start of transmission. All information packets follow the same route and arrive in sequence (but do not necessarily carry a complete address).

Index

A

| | |
|---|----|
| About the Internet | 83 |
| About the Multi-Tech Fax-Back Service | 85 |
| ASCII String | 22 |

B

| | |
|------------------------------|----|
| Back Panel Description | 10 |
| BBS | 82 |

C

| | |
|--|----|
| Cabling Diagrams | 86 |
| Committed Information Rate | 32 |
| Configuration Port Setup | 38 |
| Configuration Utilities | 38 |
| Connectors | |
| Channels 1 & 2 (RS232/V.35) | 10 |
| Channels 3 - 10 | 11 |
| Command Port | 10 |
| Ethernet 10Base-T | 10 |
| External Composite Link (RS232/V.35) | 10 |
| Frame Ground (GND) | 10 |
| Internal Composite Link (T1 DSU) | 10 |
| Monitor (XMT/RCV) | 10 |
| Power | 10 |
| Voice/Fax Channels 1 - 8 | 11 |
| E&M | 11 |
| FXO | 11 |
| FXS | 11 |
| Contacting Tech Support via E-mail | 81 |

D

| | |
|----------------------------|----|
| Data Port Statistics | 66 |
| DHCP | 41 |
| DNS | 41 |

E

| | |
|----------------------------|----|
| Ethernet | 22 |
| EthernetII (Type II) | 22 |
| Excess Burst Rate | 32 |

F

| | |
|------------------------------|--------|
| Frame Relay Statistics | 67 |
| Frame Types | 22, 23 |
| EthernetII (Type II) | 22 |
| LLC (802.2) | 22 |
| Raw (802.3) | 22 |
| SNAP | 22 |
| Front Panel | |
| Description | 8 |

I

| | |
|---------------------------|----|
| Internet | 83 |
| IP Statistics | 62 |
| IPX Port Statistics | 63 |
| IPX Setup | 43 |

L

| | |
|-------------------------------------|----|
| LED's | |
| BTG | 8 |
| Channels 1 and 2 | 9 |
| RCV | 9 |
| V35 | 9 |
| XMT | 9 |
| Channels 3 through 10 | 9 |
| RCV | 9 |
| XMT | 9 |
| Composite Link | 8 |
| CD | 8 |
| CTS | 8 |
| EXT | 8 |
| LNK | 8 |
| RCV | 8 |
| V35 | 8 |
| XMT | 8 |
| Ethernet | 8 |
| COL | 8 |
| LNK | 8 |
| RCV | 8 |
| XMT | 8 |
| PWR | 8 |
| Voice/Fax Channels 1 - 8 | 9 |
| E&M | 9 |
| FAX | 9 |
| FXO | 9 |
| FXS | 9 |
| RSG | 9 |
| XMT | 9 |
| XSG | 9 |
| Limited Warranty | 80 |
| On-line Warranty Registration | 80 |
| LLC (802.2) | 22 |
| Loading Software | 20 |

M

| | |
|-------------------------------|----|
| Multi-Tech BBS | 82 |
| MultiFRAD Configuration | 75 |

O

| | |
|---------------------------------------|----|
| On-line Warranty Registration | 80 |
| OSPF (Open Shortest Path First) | 41 |

P

| | |
|----------------------------|----|
| PPP Statistics | 65 |
| ProxyServer Software | 38 |

R

| | |
|---------------------------------------|----|
| Raw (802.3) | 22 |
| Recording MultiFRAD Information | 81 |
| Regulatory Information | 90 |
| Remote Address | 23 |
| Remote Configuration | |
| LAN-Based | 72 |
| Remote User Database | 76 |
| Router Name | 22 |

S

| | |
|---|--------|
| Service | 82 |
| Setup Menu | |
| IPX Setup | 43 |
| Spanning Tree Setup | 44, 46 |
| Statistics | |
| Data Port Statistics | 66 |
| Frame Relay Statistics | 67 |
| IP Statistics | 62 |
| IPX Port Statistics | 63 |
| PPP Statistics | 65 |
| SNMP Statistics | 64 |
| STP (Spanning Tree) Port Statistics | 63 |
| WAN Statistics | 64 |
| WAN Port Setup | 47 |
| SNAP | 22 |
| SNMP Statistics | 64 |
| Software | 20, 38 |
| Description | 38 |
| Spanning Tree Setup | 44, 46 |
| Statistics | |
| Data Port Statistics | 66 |
| Frame Relay Statistics | 67 |
| IP Statistics | 62 |
| IPX Port Statistics | 63 |
| PPP Statistics | 65 |
| SNMP Statistics | 64 |
| STP (Spanning Tree) Port Statistics | 63 |
| WAN Statistics | 64 |
| STP (Spanning Tree) Port Statistics | 63 |

T

| | |
|--|----|
| Tech Support | 81 |
| Contacting Tech Support via E-mail | 81 |
| Recording MultiFRAD Information | 81 |
| Technical Specifications | 12 |
| Channel Connectors | 12 |
| Command Port | 12 |
| Composite Link (external) | 12 |
| Electrical/Physical | 12 |
| EtherNet Port | 12 |
| Requirement | 12 |
| Telnet | |
| Client | 74 |
| MultiFRAD Configuration | 75 |
| Remote User Database | 76 |

U

| | |
|--|----|
| Uninstall Proxy Server Configuration | 38 |
| Unpacking your MultiFRAD 3000 | 14 |

W

| | |
|------------------------------|----|
| WAN | 23 |
| Port | 23 |
| WAN Port Setup | 47 |
| WAN Statistics | 64 |
| WEB Browser Management | 76 |

Free Manuals Download Website

<http://myh66.com>

<http://usermanuals.us>

<http://www.somanuals.com>

<http://www.4manuals.cc>

<http://www.manual-lib.com>

<http://www.404manual.com>

<http://www.luxmanual.com>

<http://aubethermostatmanual.com>

Golf course search by state

<http://golfingnear.com>

Email search by domain

<http://emailbydomain.com>

Auto manuals search

<http://auto.somanuals.com>

TV manuals search

<http://tv.somanuals.com>