

16/8/4CH MPEG-4 DVR

~Digital Video Recorder~

Real time performance 30IPS (N) / 25IPS (P) per channel

4CH



16CH / 8CH / 4CH



16CH / 8CH / 4CH Built-in DVD-RW Writer or CD-RW Writer





User's Manual

Please read instructions thoroughly before operation and retain it for future reference.

MPEG4 DVR SERIES_V0.989

IMPORTANT SAFEGUARD

	CAUTION RISK OF ELECTRIC SHOCK	
<p>CAUTION: To reduce the risk of electric shock, do not expose this apparatus to rain or moisture. Only operate this apparatus from the type of power source indicated on the label.</p>		

The lightning flash with arrowhead symbol, within an equilateral triangle, is intended to alert the user to the presence of uninsulated “dangerous voltage” within the product’s enclosure that may be of sufficient magnitude to constitute a risk of electric shock to persons.



This exclamation point within an equilateral triangle is intended to alert the user to the presence of important operating and maintenance (servicing) instructions in the literature accompanying the appliance.



CE Mark

This apparatus is manufactured to comply with the radio interference requirements.



THIS PRODUCT IS LICENSED UNDER THE MPEG-4 VISUAL PATENT PORTFOLIO LICENSE FOR THE PERSONAL AND NON-COMMERCIAL USE OF A CONSUMER FOR (i) ENCODING VIDEO IN COMPLIANCE WITH THE MPEG-4 VISUAL STANDARD (“MPEG-4 VIDEO”) AND/OR (ii) DECODING MPEG-4 VIDEO THAT WAS ENCODED BY A CONSUMER ENGAGED IN A PERSONAL AND NON-COMMERCIAL ACTIVITY AND/OR WAS OBTAINED FROM A VIDEO PROVIDER LICENSED BY MPEG LA TO PROVIDE MPEG-4 VIDEO. NO LICENSE IS GRANTED OR SHALL BE IMPLIED FOR ANY OTHER USE. ADDITIONAL INFORMATION INCLUDING THAT RELATING TO PROMOTIONAL INTERNAL AND COMMERCIAL USES AND LICENSING MAY BE OBTAINED FROM MPEG LA, LLC. SEE [HTTP://WWW.MPEGLA.COM](http://www.mpegla.com).

Note: Version: 1042-09-H6-04-AA-08 ; 0030

Note: Any changes of AP, please refer to your distributor.

Note: Any changes of this manual made to the actual product are subjects to no further notification.

TABLE OF CONTENTS

PARTS AND FEATURES

1.1 FEATURES	1
1.2 PACKAGE CONTENTS	1
1.3 SPECIFICATION	2
1.4 FRONT PANEL	4
1.5 REAR PANEL	8

GETTING STARTED

2.1 GETTING STARTED	10
---------------------------	----

BASIC OPERATION

3.1 RECORDING	11
3.2 PLAYBACK	12

DETAILED MENU CONFIGURATION

4.1 MENU TREE	14
4.2 MAIN MENU OPTIONS_RECORD	15
4.3 MAIN MENU OPTIONS_TIMER	16
4.4 MAIN MENU OPTIONS_DATE	17
4.5 MAIN MENU OPTIONS_ADVANCE	18
4.6 ADVANCE MENU_CAMERA	18
4.7 ADVANCE MENU_DETECTION	19
4.8 ADVANCE MENU_DISPLAY	21
4.9 ADVANCE MENU_ALERT	22
4.10 ADVANCE MENU_REMOTE	23
4.11 ADVANCE MENU_SYSTEM	24
4.12 ADVANCE MENU_NETWORK	25
4.13 ADVANCE MENU_BACKUP	26
4.14 ADVANCE MENU_HDD INFO	28
4.15 ADVANCE MENU_EVENT LOG	28

ADDITIONAL OPERATION

5.1 SEARCH	29
5.2 2X DIGITAL ZOOM	30
5.3 KEY LOCK	30
5.4 SWITCH THE N/P SYSTEM	30
5.5 USB UPGRADE	31
5.6 LICENSED SOFTWARE AP	31
AP BASIC OPERATION	32
AP ADVANCED SETTING	37
Network	37
DDNS	38
MAIL	39
FTP	39
DVR-CAMERA SETTING	40
DEVICE	40
DETECTION	41
NETWORK BACKUP & PLAYBACK	42
ALARM	43
ALARM LIST	43
GENERAL	44
ACCOUNT	44
ONLINE USER INFO	45
FILE PATH	45
5.7 CONNECT TO AP VIA IE BROWSER	46
5.8 GPRS	47
5.9 OPTIONAL PHERIPHERALS	47

TROUBLE SHOOTING

6.1 FAQ	48
---------------	----

<u>APPENDIX #1</u> INSTALL THE HDD	49
<u>APPENDIX #2</u> PIN CONFIGURATION	51
<u>APPENDIX #3</u> RS232 PROTOCOL	53
<u>APPENDIX #3</u> RECORDING TIME TABLE	54
<u>APPENDIX #4</u> COMPATIBLE USB BRAND	55
<u>APPENDIX #5</u> COMPATIBLE HDD BRAND	56

PARTS AND FEATURES

1.1 FEATURES

MPEG4 DVR Technology

- Compression format provides crystal clear image with real time performance

Multiplex

- Allows live display, record, playback, backup, and network all at the same time

Long-Recording Hours:

- 500GB can record more than 4 days. (16CH, Frame Best Quality, 120IPS)
- Connect to Independent Disk Array (optional) to have more storage capacity

Backup Function:

- Backup files with USB interface, DVD-WRITER or CD-WRITER and network remote recording & backup

Remote Surveillance:

- GPRS allows viewing and controlling of the system & also support remote surveillance with licensed software AP and IE browser
Web surveillance supports 5 users simultaneously

Intelligent Motion Trigger Recording:

- With advanced motion detection function, scheduled motion detection recording (4 different adjustable factors for motion detection sensitivity) and convenient search function, customized security environment is achieved
- Alarm trigger recording will send alert with images to designated e-mail and FTP address
- Supports pre-alarm recording (8MB)

Covert Recording:

- A mask replaces the live image with a blank screen & the monitor shows nothing but recording is still on

AV Support:

- Supports 4 audio-in, 2 audio-out to record sounds
- Supports VGA output to monitor (optional)

General:

- Support multi-language OSD
- System auto recovery after power reconnected
- IR remote control of the system and PTZ through RS-485
- Support daylight saving function
- Support manual / timer / motion / alarm / remote recording functions
- Watermark function ensures authentication of recorded images
- Support TCP/IP, PPPoE, DHCP and DDNS network connection

1.2 PACKAGE CONTENTS

MODEL	16CH	8CH	4CH	16CH / 8CH / 4CH DVD-RW / CD-RW
Digital Video Recorder	✓	✓	✓	✓
Adapter	✓	✓	✓	✓
Licensed Software AP	✓	✓	✓	✓
IR Transmitter and IR Receiver	✓	✓	Optional	✓
Power and Data Bus	✓	✓	✓	✓
DSUB PIN Connector	✓	✓	✓	✓
Screws	✓	✓	✓	✓

NOTE: Please check the package contents to make sure that you receive all accessories shown above.

1.3 SPECIFICATION

MODEL	16CH / 16CH (D)	8CH / 8CH (D)	4CH / 4CH (D)
Video System	NTSC / PAL (switch able)		
Video Compression Format	MPEG 4		
Video Input (Composite video signal 1 Vp-p 75 BNC)	16 Channels	8 Channels	4 Channels
Video Loop Out (Composite video signal 1 Vp-p 75 BNC)	16 Channels	8 Channels	4 Channels
Video Output	<u>Main Monitor Output:</u> Composite video signal 1 Vp-p 75 BNC <u>Call Monitor Output:</u> Composite video signal 1 Vp-p 75 BNC		
Maximum Recording Rate (Frame)	720 x 480 pixels with 120 IPS NTSC 720 x 576 pixels with 100 IPS PAL	720 x 480 pixels with 60 IPS NTSC 720 x 576 pixels with 50 IPS PAL	720 x 480 pixels with 30 IPS NTSC 720 x 576 pixels with 25 IPS PAL
Maximum Recording Rate (CIF)	352 x 240 pixels with 480 IPS NTSC 352 x 288 pixels with 400 IPS PAL	352 x 240 pixels with 240 IPS NTSC 352 x 288 pixels with 200 IPS PAL	352 x 240 pixels with 120 IPS NTSC 352 x 288 pixels with 100 IPS PAL
Adjustable Recording Speed (Frame)	120, 60, 30, 15 IPS <NTSC> 100, 50, 25, 12 IPS <PAL>	60, 30, 15, 7 IPS <NTSC> 50, 25, 12, 6 IPS <PAL>	30, 15, 7, 3 IPS <NTSC> 25, 12, 6, 3 IPS <PAL>
Adjustable Recording Speed (CIF)	480, 240, 120, 60 IPS <NTSC> 400, 200, 100, 50 IPS <PAL>	240, 120, 60, 30 IPS <NTSC> 200, 100, 50, 25 IPS <PAL>	120, 60, 30, 15 IPS <NTSC> 100, 50, 25, 12 IPS <PAL>
Image Quality Setting	Best, High, Normal, and Basic		
Hard Disk Storage (IDE type, ATA66) (over 400GB)	16CH: support HDD * 2 16CH (D): support HDD *1	8CH: support HDD * 2 8CH (D): support HDD *1	4CH: support HDD * 1 4CH (D): support HDD *1
HDD Quick Cleaning	Quick clean up the "index system" of the recorded files. 250GB under 2 seconds		
Recording Mode	Manual / Timer / Motion / Alarm		
Watermark	Yes		
Refresh Rate	480 IPS for NTSC 400 IPS for PAL	240 IPS for NTSC 200 IPS for PAL	120 IPS for NTSC 100 IPS for PAL
Multiplex Operation	live display, record, playback, backup, and network		
Audio I/O	4 audio inputs, 2 audio outputs (Mono)		
Motion Detection Area	16 x 12 grids per camera for all channels		
Motion Detect Sensitivity	4 adjustable variables with precise calculation for motion detection		
Pre-alarm Recording	Yes (8 MB)		
Backup Device	USB1.1 / 2.0 backup and network remote backup		
USB Interface	front panel * 1, back panel * 1		front panel * 1
Web Transmitting Compression Format	Motion JPEG		
Ethernet	10/100 Base-T. Support remote control and live view via Ethernet		
Mobile Surveillance	Support GPRS to access the system via mobile phone (require J2ME, MIDP2.0 protocol)		
Web Interface	Support licensed software AP, and IE browser		
Remote Alarm Notification	E-mail images, and images uploading to FTP site's specific account		
Network Protocol	TCP/IP, PPPoE, DHCP and DDNS		
IR transmitter	Remote control DVR and PTZ via IR transmitter (RS-485)		(4CH: Optional)
PTZ control	Support PELCO-D protocol		
Dwell Time (Sequential Channel Switch)	Programmable with adjustable dwell time (2, 4, 8, 16 sec.)		
Alarm I/O	16 inputs, 1 output	8 inputs, 1 output	4 inputs, 1 output
Picture Zoom	Support 2X digital zoom function		
Key Lock	Yes		
Video Loss Detection	Yes		

MODEL	16CH / 16CH (D)	8CH / 8CH (D)	4CH / 4CH (D)
Specification Continued ...			
Camera Title	Support up to 6 letters		
Video Adjustable	Hue / Color / Contrast / Brightness		
Date Display Format	YY/MM/DD, DD/MM/YY, MM/DD/YY, and Off		
Daylight Saving	Yes		
Power Source	DC 19V		
Power Consumption	< 64 W	4CH: < 42 W ; 4CH (D): < 64 W	
Operating Temperature	10 ~ 40 (50 ~104)		
Dimensions (mm)	432mm (W) x 90mm (H) x 326mm (D)		432mm (W) x 90mm (H) x 326mm (D)
System Recovery	System auto recovery after power reconnected		
Optional Peripherals	Independent Disk Array ; VGA Connector		Independent Disk Array ; VGA Connector ; IR Remote Control

—● 16CH / 16CH(D)

Total IPS		120	60	30	15
Frame <D1>	Best	109	192	349	565
	High	138	243	442	714
	Normal	182	319	581	939
	Basic	293	516	939	1517
Total IPS		480	240	120	60
CIF	Best	130	229	417	673
	High	184	323	587	949
	Normal	242	424	773	1249
	Basic	335	588	1071	1730

—● 8CH / 8CH(D)

Total IPS		60	30	15	7
Frame <D1>	Best	218	384	689	1130
	High	276	486	882	1428
	Normal	364	638	1162	1878
	Basic	586	1032	1878	3034
Total IPS		240	120	60	30
CIF	Best	260	458	834	1346
	High	368	646	1174	1898
	Normal	484	848	1546	2498
	Basic	670	1176	2142	3460

—● 4CH / 4CH(D)

Total IPS		30	15	7	3
Frame <D1>	Best	436	767	1398	2260
	High	552	972	1764	2856
	Normal	728	1276	2324	3756
	Basic	1172	2064	3756	6068
Total IPS		120	60	30	15
CIF	Best	520	916	1668	2692
	High	736	1292	2348	3796
	Normal	968	1696	3092	4996
	Basic	1340	2352	4284	6920



※ 1. For 500GB HDD record time (hour)
2. Take outdoor environment as examples.

□ Any changes made to the actual product are subjects to no further notification.

1.4 FRONT PANEL

- 16CH / 8CH
- 16CH (D) / 8CH (D) / 4CH (D)



- 1) **POWER:**
Press "POWER" button to turn on/ turn off the DVR.
(Under recording mode, please stop record before turn off the DVR)
- 2) **MENU:**
Press "MENU" button to enter main menu.
- 3) **ENTER / RECORD:**
Press "ENTER" button to confirm.
Press "RECORD" to activate the manual recording.
- 4) **" + " " - " :**
Press " + " or " - " button to change the setting in the menu / to select the channel.
Press " + " and " - " buttons to open / close the DVD / CD WRITER.
- 5) **USB:**
Support firmware update and files backup.
- 6) **LED LIGHT:**
POWER: Power on
STANDBY: Standby
HDD: HDD is reading or recording
HDD Full: HDD is full.
ALARM: Once the alarm is triggered
TIMER: When timer recording is turned on.
REC: Under recording status
PLAY: Under playing status
- 7) **MODE  :**
Press "MODE  " button to switch channel display mode.

- 8) "■ ■" :
Press "■ ■" button to pause the play back files.
- 9) "■" :
Press "■" button to stop the play back files.
- 10) "◀◀" :
Under playback mode, press "◀◀" button to fast rewind.
- 11) "▶▶" :
Under playback mode, press "▶▶" to fast forward.
- 12) "ZOOM" :
Press "ZOOM" button to enlarge the picture of selected channel (2X digital zoom).
- 13) "PLAY" :
Press "PLAY" button to playback recorded files.
- 14) "◀▶" :
Press "◀▶" to move the cursor up / down / left / right.
- 15) "SHIFT" + "SEQ" :
Press "SHIFT" + "SEQ" to activate the call monitor function and press "SEQ" to escape the call monitor mode.
- 16) "SHIFT" + "AUDIO" :
Press "SHIFT" + "AUDIO" to select live or playback sounds of the 4 audio channels.
- 17) "SHIFT" + "SLOW" :
Under playback mode, press "SHIFT" + "SLOW" to show slow playback.
- 18) "SHIFT" + "CH - " or "CH + " :
Press "SHIFT" + "CH - " or "CH + " change the setting in the menu / to select the channel.
- 19) "SHIFT" + "SET" :
Press "SHIFT" + "SET" to change channel display position.
Press "◀▶" to select the channel which You would like to change,
Press "+" or "-" select the channel which You would like to show.
Press "ENTER" button to confirm.
- 20) "SHIFT" + "SEARCH" :
Press "SHIFT" + "SEARCH" buttons to enter the search mode.
- 21) "◀◀" + "▶▶" :
Press "◀◀" + "▶▶" buttons at the same time to enter / exit the PTZ control mode.

1.4 FRONT PANEL Continued...









● 4CH



- 1) **“HDD Cartridge Lock”** :
Lock / Unlock the cartridge of the HDD.
- 2) **“USB”** :
Support firmware update and files backup.
- 3) **“LED LIGHT”** :

HDD: HDD is reading or recording
HDD Full: HDD is full.
ALARM: Once the alarm is triggered
TIMER: When timer recording is turned on
PLAY: Under playing status
REC: Under recording status
- 4) **“MENU”** :
Press “MENU” button to enter main menu.
- 5) **“ENTER” / “SET”** :
Press “ENTER” button to confirm.

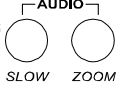
Press “SET” to change channel display position.
Press “ ◀▶ ” to select the channel which you like to change,
Press “ + ” or “ - ” select the channel which You would like to show.
Press “ENTER” button to confirm.
- 6) **“SEARCH ”** :
Press “SEARCH” button to enter the search mode.
- 7) **“SLOW ”** :
Under playback mode, press “SLOW“ button to show slow playback.

- 7) **“ZOOM”** :
- Press “ZOOM” button to enlarge the picture of selected channel (2X digital zoom).
- 8)  / “ - ” :
- Press  “ button to show the 4 channel display mode.
Press “ - ” button to change the setting in the menu.
- 9) **“SEQ”** / “ + ” :
- Press “SEQ” button to activate the call monitor function and press “SEQ” button again to escape the call monitor mode.
Press “ + ” button to change the setting in the menu.
- 10) **“POWER”** :
- Press this button to turn on / turn off the DVR.
(Under recording mode, please stop record before turn off the DVR).
- 11) **“CH1” “CH2” “CH3” “CH4”** :
- Press “1” “2” “3” “4” buttons to select the channel.
- 12) **“REC”** :
- Press “REC” button to activate the manual recording.
- 13) **“PLAY”** :
- Press “PLAY” button to playback the recorded files.
- 14) **“UP / PAUSE , DOWN / STOP, LEFT / FAST REWIND, RIGHT / FAST FORWARD”** :
- Press “  “ to move the cursor up / down / left / right.
- Under playback mode, press “  “ button to pause playback.
Under playback mode, press “  “ button to stop playback.
Under playback mode, press “  “ button to fast rewind.
Under playback mode, press “  “ button to fast forward.
- 15)  :
- Press these two buttons to select live or playback sounds of the 4 audio channels.
- 16)  :
- Press these two buttons at the same time to enter / exit the PTZ control mode.

1.5 REAR PANEL

● 16CH / 16CH (D)

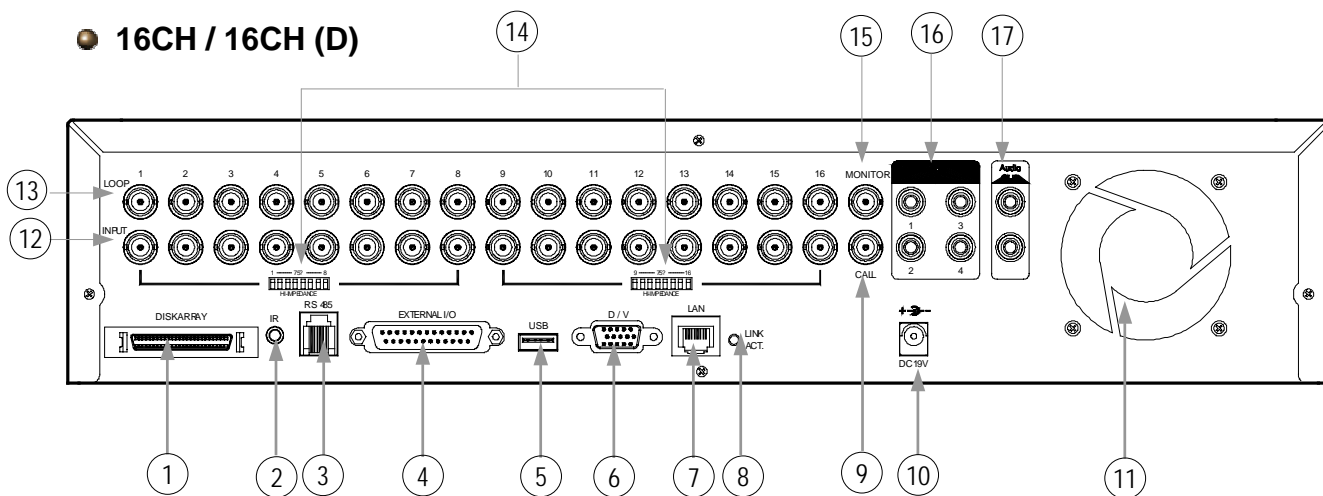

● 8CH / 8CH (D)

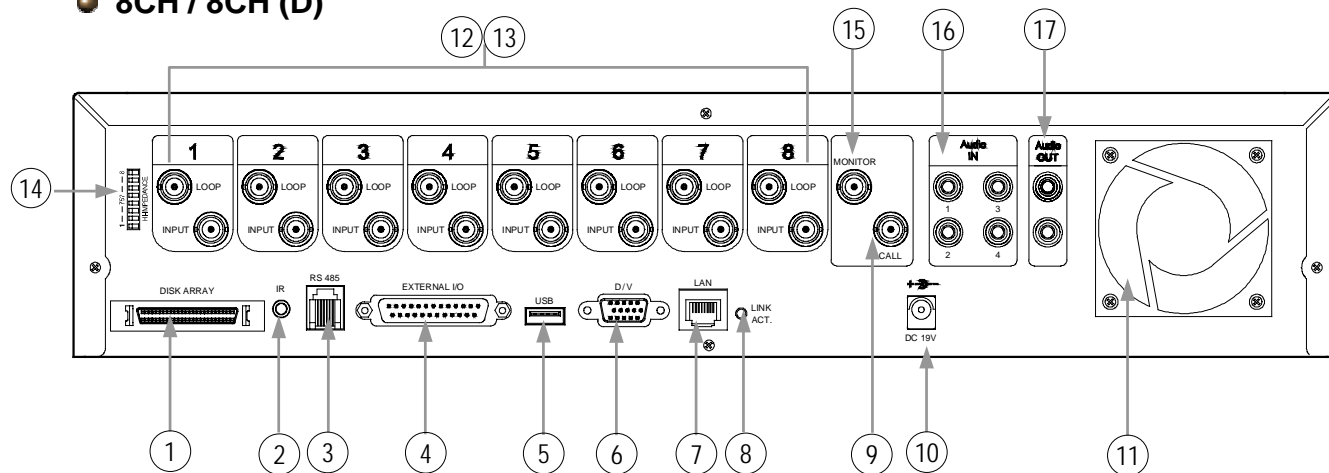

● 4CH / 4CH (D) ~ But size are different

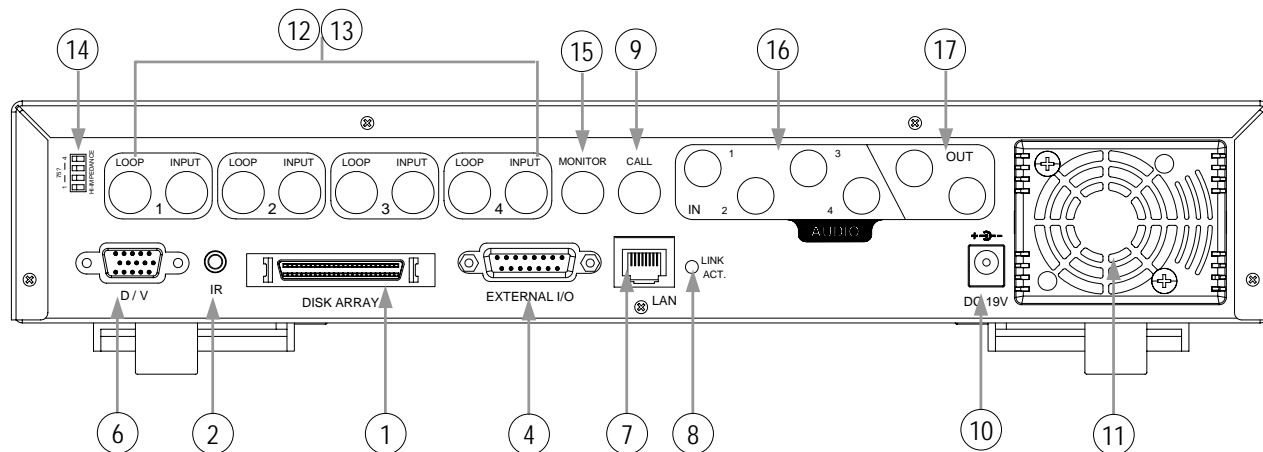

- 1) **DISK ARRAY PORT:**
Connect to disk array for extend HDD capacity.
- 2) **IR:**
Connect to IR receiver.
- 3) **RS485:**
Connect to external device (such as PTZ camera) with RS485-A and RS485-B.
- 4) **EXTERNAL I/O PORT:**
Connect to external device. Control external device or get controlled remotely by external device (alarm input, external alarm, PTZ camera).
- 5) **USB PORT:**
Support firmware update and files backup.
- 6) **D/V PORT (Digital Video Port):**
Connect to VGA connector card.
- 7) **LAN:**
Connect to Internet by LAN cable.
- 8) **LINK / ACT LED light:**
When the Internet is activated, the LED light will be on.
- 9) **CALL MONITOR:**
Connect to CALL monitor. Show the channel switch display. When the alarm is triggered, the call monitor will show the image of the triggered channel for a period of time.
- 10) **POWER:**
Connect to provided adapter.
- 11) **FAN:**
For ventilation.
- 12) **VIDEO INPUT (CHANNEL 1 – 16 / CHANNEL 1 – 8 / CHANNEL 1 – 4) :**
Connect to video source, such as camera.
- 13) **LOOP (CHANNEL 1 – 16 / CHANNEL 1 – 8 / CHANNEL 1 – 4) :**
Video output.
- 14) **75 / HI:**
When using Loop function, please switch to HI. When you don't use Loop function, please switch to 75 .
- 15) **MONITOR:**
Connect to Main monitor.
- 16) **AUDIO IN (1-4):**
Connect to audio source, such as camera which equipped with audio function. When users start the recording function, the audio input will be recorded .
- 17) **AUDIO OUT :**
Connect to monitor or speaker.
With 2 mono audio outputs from the same source.

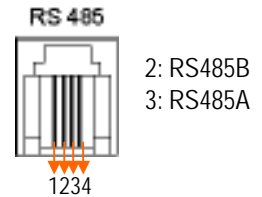

GETTING STARTED

2.1 GETTING STARTED

Connecting all the devices to construct a surveillance.

- 1) Install HDD:
The HDD must be installed before the DVR is turned on.
- 2) Connect cameras.
- 3) Connect monitors.
- 4) Connect the external devices.
- 5) Connect the AC power cord to power adapter and plug into an electrical outlet.
The standby LED would be on as red.
Press the "POWER" button. The power LED will be on as red.
It takes approximately 10 to 15 seconds to boot the system.

NOTE:

Please refer to Appendix #1 for HDD installation instructions.

NOTE:

Please refer to "Section 1.5 Rear Panel" for connection.

NOTE:

Please refer to Appendix#2 for pin configurations of the external I/O port .

Take 16CH as an example

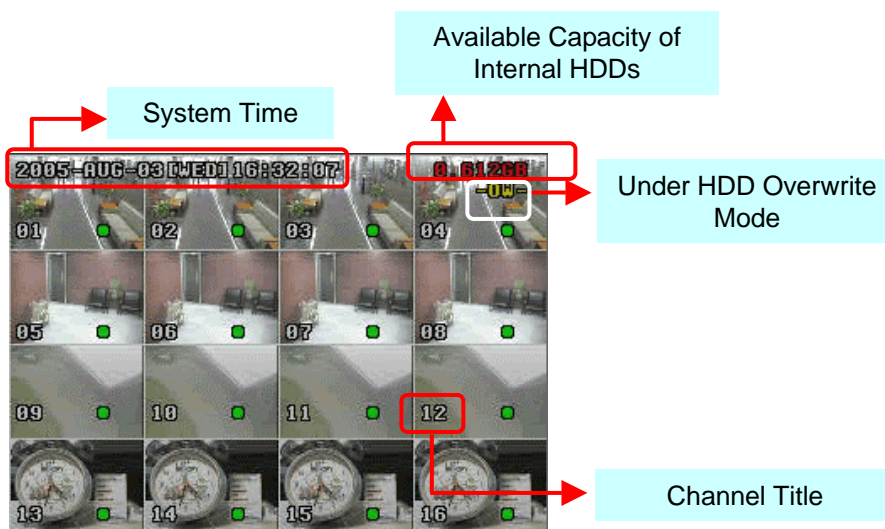
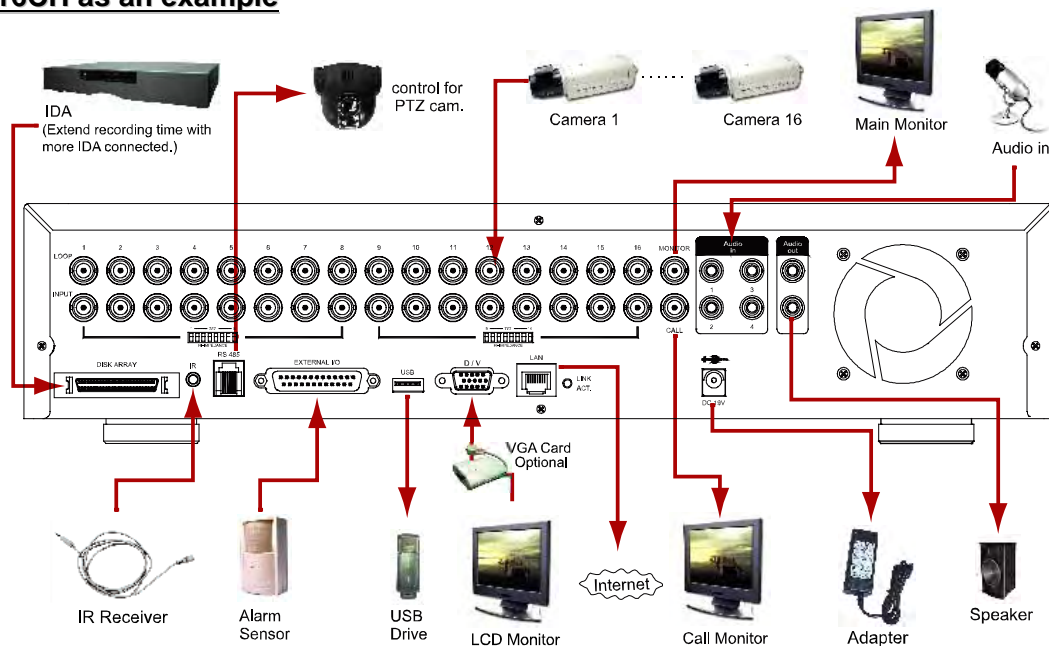

3.1 RECORDING

The DVR offers three recording modes, manual record, event recording, and timer record. If power is off accidentally, recorded video files will still be stored in the HDDs. DVR will return to original recording status after power is on again.

- 1) **MANUAL RECORDING** (continuous recording) :
Recording is initiated by manually pressing the “REC” button.
Indicated by the sign “ ”
- 2) **EVENT RECORDING** (triggered by motion and external alarm) :
When this functions is activated,
the recording is triggered by motion or external alarm.
Indicated by the sign “ ” and “ ”.
- 3) **TIMER RECORDING** (scheduled time) :
Recording is scheduled by Timer. Indicated by the sign “**TIMER RECORD**”.

Take 16CH as an example

NOTE :

When the HDDs are full under O/W recording mode, previous recorded files may be overwritten without further warning notices.

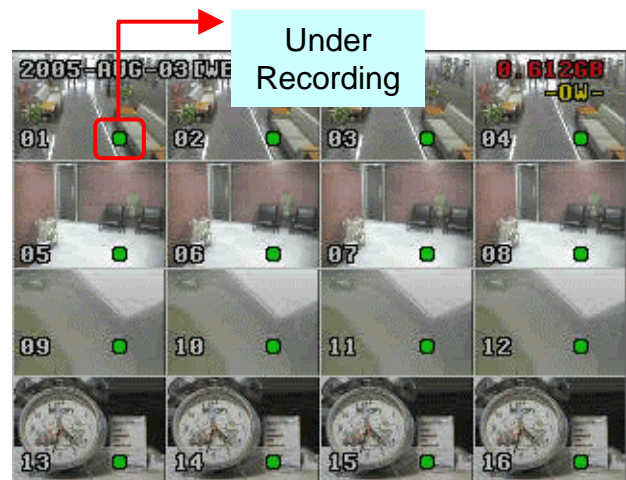

3.2 PLAYBACK

- 16CH / 8CH
- 16CH (D) / 8CH (D) / 4CH (D)

Press “PLAY” button, the DVR will display the last recording video.

1) **FAST FORWARD (F.F.) & FAST REWIND (REW):**

You can increase speed for fast forward and rewind on the DVR.

In the playback mode,

* Press “▶▶” once to get 4X speed forward and press twice to get 8X speed, ... and the maximum speed can reach 32X.

* Press “◀◀” once to get 4X speed rewind and press twice to get 8X speed, ... and the maximum speed can reach 32X.

* The type of recording image size (Frame or CIF) will also be shown on the screen.

2) **PAUSE / IMAGE JOG:**

Press “⏸” button to pause the current image displayed on the screen.

In the Pause mode,

* Press “▶▶” once to get forward by frame change.

* Press “◀◀” once to get rewind by frame change.

3) **STOP:**

Press “■” button under all circumstances, it will return DVR to live monitoring mode.

4) **CHANNEL SHIFT:**

* Display mode:

Press MODE “” button to select display mode.

* Full Screen Switch:

Press “+” or “-” button to show the full screen channels.

* Channel display switch:

Press “**SHIFT**” + “**SET**” button.

Press “ ” “ ” “◀” “▶” to select the channel which you would like to change.

Press “+” or “-” select the channel which you would like to show.

Press “ENTER” button to confirm.

5) **SLOW PLAYBACK:**

Press “**SHIFT**” + “**SLOW**” button to get 1/4X speed playback and press twice to get 1/8X speed.

6) **AUDIO:**

Press “**SHIFT**” + “**AUDIO**” to select live or playback sounds of the 4 audio channels.

* AUDIO 1 (L) ; AUDIO 1 (P)

* AUDIO 2 (L) ; AUDIO 2 (P)

* AUDIO 3 (L) ; AUDIO 3 (P)

* AUDIO 4 (L) ; AUDIO 4 (P)

Note: For the playback of the DVD or CD backup file, please refer to “Section 4.13 ADVANCE MENU_BACKUP” for detailed instruction

● 4CH

Press “PLAY” button, the DVR will display the last recording video.

1) **FAST FORWARD (F.F.) & FAST REWIND (REW):**

You can increase speed for fast forward and rewind on the DVR.

In the playback mode,

* Press “▶▶” “ once to get 4X speed forward and press twice to get 8X speed,
... and the maximum speed can reach 32X.

* Press “◀◀” “ once to get 4X speed rewind and press twice to get 8X speed,
... and the maximum speed can reach 32X.

* The type of recording image size (Frame or CIF)will also shown on the screen.

2) **PAUSE / IMAGE JOG:**

Press “⏸” “ button to pause the current image displayed on the screen.

In the Pause mode,

* Press “▶▶” “ once to get forward by frame change.

* Press “◀◀” “ once to get rewind by frame change.

3) **STOP:**

Press “■” “ button under all circumstance, it will return DVR to live monitoring mode.

4) **CHANNEL SHIFT:**

* Display mode:

Press MODE “⊞” “ button to 4 channels display.

* Full Screen Switch:

Press “+” or “-” button to show the full screen channels.

* Channel display switch:

Press “SET” to change channel display position.

Press “◀▶” “ to select the channel which you like to change,

Press “+” or “-” select the channel which You would like show.

Press “ENTER” button to confirm.

5) **SLOW PLAYBACK:**

Press “SLOW” button to get 1/4X speed playback and press twice to get 1/8X.

6) **AUDIO:**

Press “” to select live or playback sounds of the 4 audio channels.

 
SLOW ZOOM

* AUDIO 1 (L) ; AUDIO 1 (P)

* AUDIO 2 (L) ; AUDIO 2 (P)

* AUDIO 3 (L) ; AUDIO 3 (P)

* AUDIO 4 (L) ; AUDIO 4 (P)

DETAILED MENU CONFIGURATION

4.1 MENU TREE

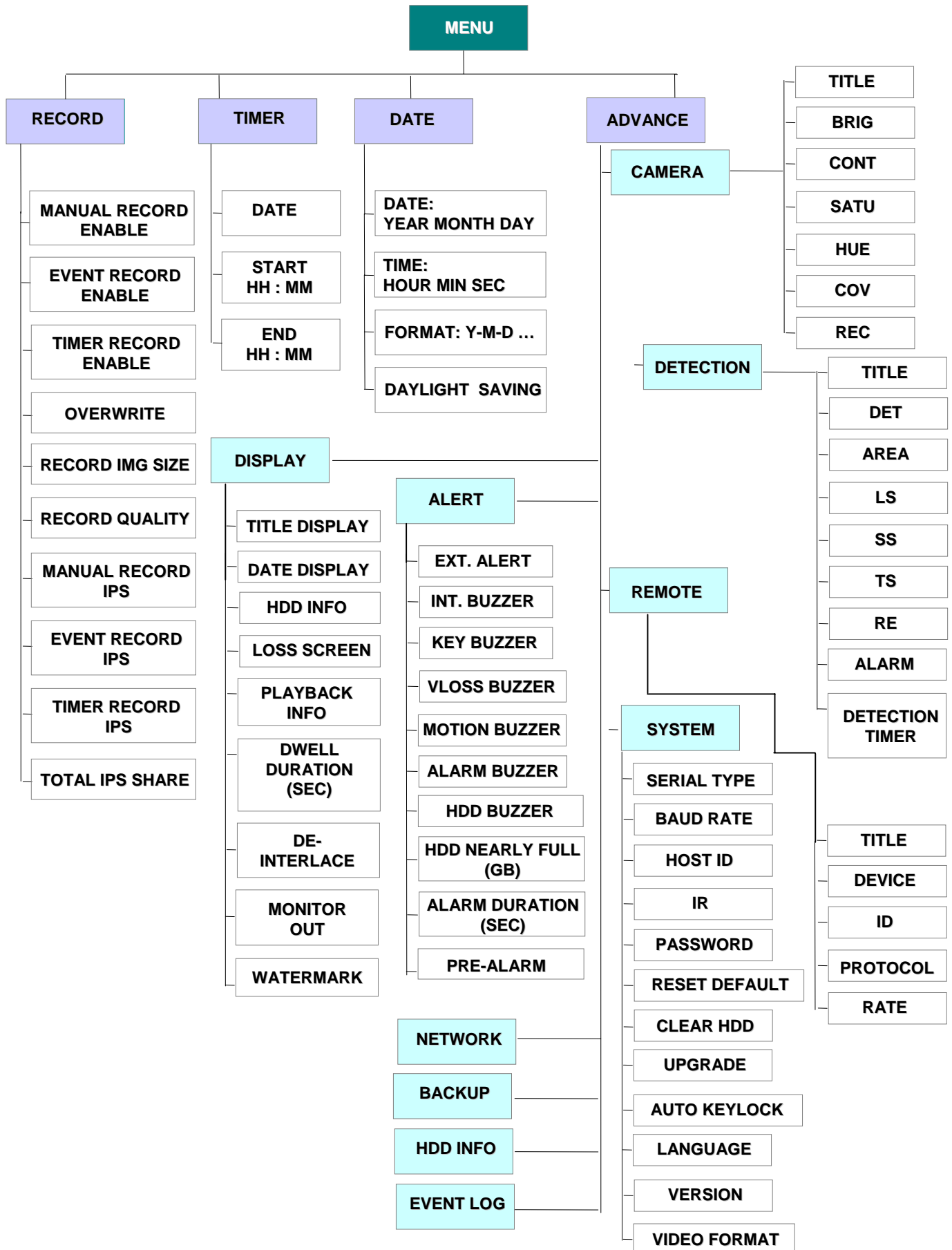

4.2 MAIN MENU OPTIONS__RECORD

Press "MENU" button to enter the main menu list. **The default admin password is 0000.** Enter the default password and press "ENTER". (Users could alter the password later, please refer to "Section 4.11 ADVANCE MENU_SYSTEM")

Move the cursor to the "RECORD", and press "ENTER", then the screen will show the following options.

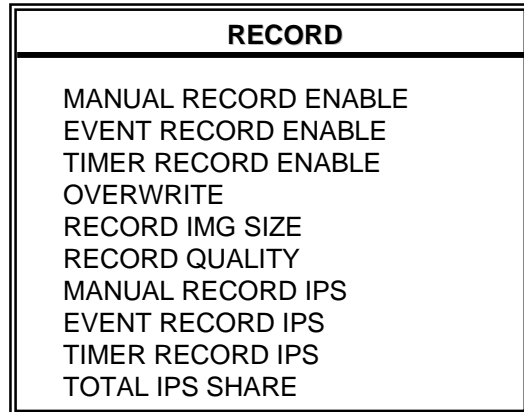
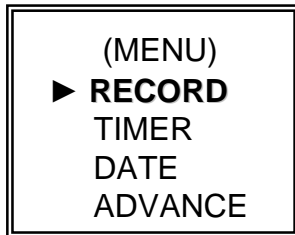

Use the following buttons for menu setting:

- " ◀▶ " to move the cursor.
- " + , - " to choose the numbers / selections.
- " ENTER " to go to the submenu / to confirm the selection
- " MENU " to go to the menu OSD
/ to confirm the change / to exit the menu OSD

- 1) MANUAL RECORD ENABLE:
Start / Stop the manual recording function.
- 2) EVENT RECORD ENABLE:
Start / Stop the event recording function. When this functions is activated, the recording will triggered by motion or external alarm
- 3) TIMER RECORD ENABLE:
Start / Stop the timer recording function.
- 4) OVERWRITE:
Select to overwrite previous recording video in HDD. When the HDD is full under O/W recording mode, previous recorded files will be overwritten without further warning notices.
- 5) RECORD IMG SIZE:
There are two recording options: FRAME & CIF. When change record image size, user need to stop recording first.
- 6) RECORD QUALITY:
There are four quality settings: BEST, HIGH, NORMAL & BASIC

In the following (7) ~ (9) sections is for 16 channels.
For 8 channels, divided the IPS by 2. For 4 channels, divided the IPS by 4.
- 7) MANUAL RECORD IPS:
Recording is activated by pressing the "REC" button. Select the images per second of MANUAL RECORD, The options are as the followings:
NTSC: FRAME: 120, 60, 30, 15 PAL: FRAME: 100, 50, 25, 12
 CIF: 480, 240, 120, 60 CIF: 400, 200, 100, 50

8) EVENT RECORD IPS:

Recording is activated by event (alarm and motion trigger). Select the images per second for event record, The options are as the followings:

NTSC: FRAME: 120, 60, 30, 15

PAL: FRAME: 100, 50, 25, 12

CIF: 480, 240, 120, 60

CIF: 400, 200, 100, 50

9) TIMER RECORD IPS:

Recording is activated by timer schedule. Select the images per second of TIMER RECORD, The options are as the followings:

NTSC: FRAME: 120, 60, 30, 15

PAL: FRAME: 100, 50, 25, 12

CIF: 480, 240, 120, 60

CIF: 400, 200, 100, 50

10) TOTAL IPS SHARE:

There are two IPS settings: (Take 16ch as example)

FIX: IPS per channel = RECORD IPS ÷ 16 channels

GROUP: Every 4 channels will form a group.

IPS per channel = RECORD IPS ÷ 4 ÷ number of channels under recording within the group.

Ex.: If you set the record IPS as 480 IPS, then

Channel 01 will get 30 IPS (120 / 4 / 1 = 30)

Channel 05 and 06 each will get 15 IPS (120 / 4 / 2 = 15)

“ ” means under recording

01				Group 1 : CH 01 - 04
05	06			Group 2 : CH 05 - 08
				Group 3 : CH 09 - 12
				Group 4 : CH 13 - 16

NOTE: When users choose the image size as “CIF”, the total IPS share will be fixed. That is IPS per channel will equal to record IPS divided by 16 channels.

4.3 MAIN MENU OPTIONS__TIMER

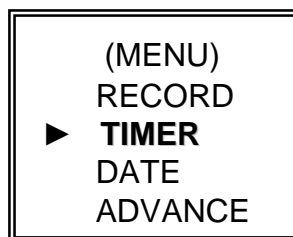

Move the cursor to the “TIMER”, and press ”ENTER”, then the screen will show the following options.

RECORD			
DATE	START		END
OFF	00 : 00	-	00 : 00
DAILY	08 : 00	-	18 : 00
SUN	06 : 00	-	23 : 00
MON-FRI	00 : 00	-	00 : 00
OFF	00 : 00	-	00 : 00
OFF	00 : 00	-	00 : 00
OFF	00 : 00	-	00 : 00

- 1) DATE:
 A scheduled record date (SUN/MON/TUE/ WED/ THU/ FRI/ SAT/ MON-FRI / SAT-SUN / DAILY/OFF) could be set to activate the timer recording.
 NOTE 1 : Specific date could be changed by “ + ” or “ - ” button.
 NOTE 2 : If you plan to set the timer recording across the midnight, there are two ways for setting the timer recording schedule, please following the instructions below.
Example 1 : If you only want to set recording timer schedule from every Sunday 23:30 to Monday 23:30, then you could set recording timer schedule as Sunday from 23:30 to 23:30.
Example 2 : If you plan to set the timer recording from Sunday 08:00 to Monday 15:00, then you could set the recording timer schedule as Sunday from 08 : 00 to 00 : 00, and Monday 00 : 00 to 15 : 00.
- 2) START:
 Select the start time for the recording.
- 3) END:
 Select the finishing time for the recording.

4.4 MAIN MENU OPTIONS__DATE

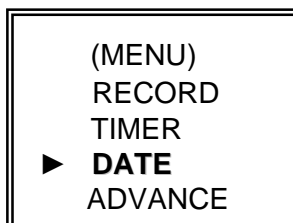

Move the cursor to the “DATE”, and press “ENTER”, then the screen will show the following options.

DATE	
DATE	2005-NOV-08 13:55:22
FORMAT	Y-M-D
DAYLIGHT SAVING	ON

- 1) DATE:
 Set the correct time of the DVR (YEAR / MONTH / DAY / HOUR / MIN / SEC)
- 2) FORMAT:
 There are three date formats: Y-M-D, M-D-Y, D-M-Y.
- 3) DAYLIGHT SAVING:
 Specify whether to use daylight saving time and time period. (START / END)
 Daylight saving time can be adjusted manually.
 Enter the daylight saving menu mode to set start time, end time and adjust hour of the daylight saving.

DAYLIGHT SAVING	
START	4TH-SUN-MAR 01: 00: 00
END	4TH-SUN-OCT 01: 00: 00
ADJUST	01 : 00

NOTE: The illustrated setting means: During the daylight saving time period (start from the 4th Sunday of March, end on the 4th Sunday of October), the DVR system time will plus one hour.

4.5 MAIN MENU OPTIONS __ ADVANCE

(MENU) RECORD TIMER DATE ► ADVANCE	ADVANCE CAMERA DETECTION DISPLAY ALERT REMOTE SYSTEM NETWORK BACKUP HDD INFO EVENT LOG
---	---

Move the cursor to the “ADVANCE”, and press ”ENTER”, then the screen will show the following options.

4.6 ADVANCE MENU __ CAMERA

Move the cursor to the “CAMERA”, and press ”ENTER”, then the screen will show the following options.

Take 16CH as an example		CAMERA				
TITLE	BRIG	CONT	SATU	HUE	COV	REC
01	110	128	128	128	NO	YES
02	110	128	128	128	NO	YES
03	110	128	128	128	NO	YES
04	110	128	128	128	NO	YES
05	110	128	128	128	NO	YES
06	110	128	128	128	NO	YES
07	110	128	128	128	NO	YES
08	110	128	128	128	NO	YES
PREV	NEXT					

- 1) **TITLE:**
Move the cursor to the title which you want to change, and press “ENTER” to access the setting screen. Assign each channel a title (up to six characters (letters or symbols...)), the default title is the channel number.
- 2) **BRIG / CONT / SATU / HUE:**
Adjust the Brightness/Contrast/Saturation/Hue of each channel.
The level is from 0 to 255. The default value of BRIG is 110, others are 128.
- 3) **COV (COVERT):**
Select “YES” to mask the selected channel which is under recording.
When this function is activated, the “COV” words will shown on the screen.
- 4) **REC (RECORD):**
Select “YES” to enable the record function; Select “NO” to disable the record.
- 5) **PREV / NEXT:**
Select “PRE” to go to the previous page; Select “NEXT” to go the next page.

4.7 ADVANCE MENU __DETECTION

Move the cursor to the "DETECTION", and press "ENTER", then the screen will show the following options.

DETECTION
DETECTION SETUP
DETECTION TIMER

1) DETECTION SETUP:

Take 16CH as an example		DETECTION					
TITLE	DET	AREA	LS	SS	TS	RE	ALARM
01	ON	SETUP	07	03	02	10	OFF
02	ON	SETUP	07	03	02	10	LOW
03	ON	SETUP	07	03	02	10	HIGH
04	ON	SETUP	07	03	02	10	OFF
05	ON	SETUP	07	03	02	10	OFF
06	ON	SETUP	07	03	02	10	OFF
07	ON	SETUP	07	03	02	10	OFF
08	ON	SETUP	07	03	02	10	OFF
PREV	NEXT						

- TITLE:
Show the title of each channel of the camera.
- DET:
Select "ON" to activate the motion detect function of each channel.
Select "OFF" to inactivate the motion detect function of each channel.
- AREA:
Press the "ENTER" button to set detection area.
Pink blocks represent the area that is not being detected. While the transparent blocks is the area that is under detection.

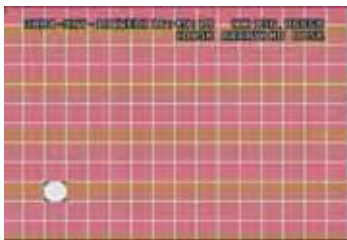

Press "ENTER" to confirm the start area

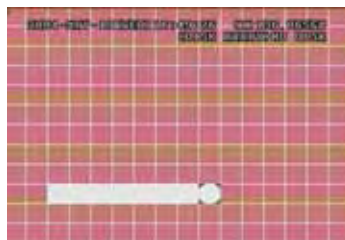

Press ◀ or ▶ to choose the width of the area



Press ◀ or ▶ to choose the height of the area, and press "ENTER" again to confirm.



Multi-detected area

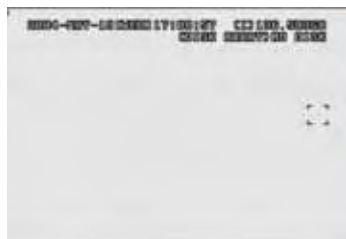

Press "-" to turn all area under detection

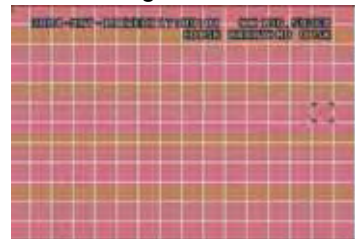

Press "+" to turn all area not to be detected

◀▶ : navigates between targets.

- d) LS :
The sensitivity of comparing two different images. The smaller the value is, the higher sensitivity for motion detection.
The highest sensitivity setting is 00, the lowest sensitivity setting is 15. The default value is 07.
- e) SS :
The sensitivity towards the size of the triggered object on the screen.(the number of motion detection grids). The smaller the value is, the higher sensitivity for motion detection.
The highest sensitivity setting is 00, and the lowest sensitivity setting is 15. The default setting is 03.
- Note: The default setting of Spatial Sensitivity is 03, which means when 3 grids are detected for motion at one time, the system will get triggered. So the value of Spatial Sensitivity must be less than the number of grids which you set up to motion detection area.
- f) TS :
The sensitivity towards how long the object gets triggered. The smaller the value is, the higher sensitivity for motion detection.
The highest sensitivity setting is 00, and the lowest sensitivity setting is 15. The default setting is 02.
- g) RE :
The value of RE is a reference for detection. The default value is 10, which means DVR will compare 10 continuous images at one time according to the sensitivity of LS, SS, TS simultaneously. Therefore the bigger the value is, the higher sensitivity for motion detection.
- h) ALARM:
Select LOW / HIGH for the alarm polarity. The default alarm value is OFF.
- i) PRE / NEXT:
Select "PRE" to go to the previous page; Select "NEXT" to go the next page. Targets set in the AREA.

- 2) DETECTION TIMER:
Set the date, start time, end time of the detection function.

DETECTION TIMER		
DATE	START	END
OFF	00 : 00 -	00 : 00
DAILY	08 : 00 -	18 : 00
SUN	06 : 00 -	23 : 00
MON-FRI	00 : 00 -	00 : 00
OFF	00 : 00 -	00 : 00
OFF	00 : 00 -	00 : 00
OFF	00 : 00 -	00 : 00

4.8 ADVANCE MENU __ DISPLAY

Move the cursor to the "DISPLAY", and press "ENTER", then the screen will show the following options.

DISPLAY	
TITLE DISPLAY	ON
DATE DISPLAY	ON
HDD INFO	ON
LOSS SCREEN	BLUE
PLAYBACK INFO	NORMAL
DWELL DURATION (SEC)	2
DE-INTERLACE	ON
MONITOR OUT	MAIN
WATERMARK	ON

- 1) TITLE DISPLAY:
Turn the channel title display on / off.
- 2) DATE DISPLAY:
Turn the date display on / off.
- 3) HDD INFO
Turn the display information of internal HDD on / off.
- 4) LOSS SCREEN
Set the color of video loss screen (Blue or Black)
- 5) PLAYBACK INFO:
Set the position where playback information will be indicated (center or normal (on the button of left-hand side of the screen)).
- 6) DWELL DURATION (SEC):
Set the duration time of each channel for CALL MONITOR (2, 4, 8, 16 sec.)
- 7) DE-INTERLACE:
Set the "DE-INTERLACE" function on / off.
- 8) MONITOR OUT:
Select video output device (Main monitor / VGA output (optional device))
- 9) WATERMARK:
In the playback mode of the software AP, users could proof the authenticity of the **BACKUP VIDEO**. If the **BACKUP VIDEO** had been altered, the video image will turn to light red and the playback will be paused.
Please refer to P. 36 for detailed instruction.

4.9 ADVANCE MENU __ALERT

Move the cursor to the "ALERT", and press "ENTER", then the screen will show the following options.

ALERT	
EXT. ALERT	ON
INT. BUZZER	ON
KEY BUZZER	ON
VLOSS BUZZER	ON
MOTION BUZZER	ON
ALARM BUZZER	ON
HDD BUZZER	ON
HDD NEARLY FULL (GB)	05
ALARM DURATION (SEC)	05
PRE-ALARM	OFF

- 1) EXT. ALERT:
Set the sound on / off when external alarm is triggered.
- 2) INT. BUZZER:
Set the sound of KEY / VLOSS / MOTION / ALARM / HDD FULL on or off.
- 3) KEY BUZZER:
Set the sound on / off when pressing the button.
- 4) VLOSS BUZZER:
Set the sound on / off when video loss happened.
- 5) MOTION BUZZER:
Set the sound on / off when motion alarm triggered.
- 6) ALARM BUZZER:
Set the sound on / off when internal alarm triggered.
- 7) HDD BUZZER:
Set the sound on / off when the HDD is full.
- 8) HDD NEARLYFULL (GB):
If HDD buzzer is on, you could choose to have a buzzer notification when the HDD available capacity is only xxx GB left..
- 9) ALARM DURATION (SEC):
Press "ENTER" or "+" or "-" button to set the duration time of alarm recording (5, 10, 20, 40 sec.).
- 10) PRE-ALARM:
Set the pre-alarm function on (8MB) / off.
When pre-alarm and event record functions are activated, the DVR will record 8MB file before alarm / motion triggered.

4.10 ADVANCE MENU __REMOTE

Move the cursor to “REMOTE”, and press ”ENTER”, then the screen will show the following options.

<u>Take 16CH as an example</u>		REMOTE		
TITLE	DEVICE	ID	PROTOCOL	RATE
01	PTZ	001	P - D	02400
02	CAMERA	002	NORMAL	02400
03	CAMERA	003	NORMAL	02400
04	CAMERA	004	NORMAL	02400
05	CAMERA	005	NORMAL	02400
06	CAMERA	006	NORMAL	02400
07	CAMERA	007	NORMAL	02400
08	CAMERA	008	NORMAL	02400
PREV	NEXT			

- 1) TITLE:
Title of each camera.
- 2) DEVICE:
Select to control normal camera or PTZ camera for each channel.
- 3) ID:
Set the ID number (0 ~ 255) of PTZ camera.
Note: After connect to PTZ correctly, the **default ID** of PTZ will be shown on the screen.
Note: Please refer to below instruction “**PTZ Connection and Control**”.
- 4) PROTOCOL:
Select NORMAL (our protocol) or PELCO-D protocol.
- 5) RATE:
Set the baud rate of each channel (2400, 4800, 9600, 19200, 57600).

*****PTZ Connection and Control: *****

- 1) Device: Our own brand PTZ / Pelco-D protocol PTZ
- 2) Connection: Detailed connection and instructions, please refer to PTZ manual.
Note:
As for “RS485A and RS485B Port” please refer to “Section 1.5 Rear Panel”, or refer to “Appendix #2 PIN Configuration”.
- 3) Control Mode: Refer to front panel / Refer to IR remote control manual.

4.11 ADVANCE MENU __SYSTEM

Move the cursor to the "SYSTEM", and press "ENTER", then the screen will show the following options.

SYSTEM	
SERIAL TYPE	RS - 485
BAUD RATE	02400
HOST ID	003
IR	ON
PASSWORD	SETUP
RESET DEFAULT	RESET
CLEAR HDD	MASTER
UPGRADE	NO
AUTO KEYLOCK	NEVER
LANGUAGE	ENGLISH
VERSION	1042-09-H6-04-AA-08
VIDEO FORMAT	NTSC

- 1) SERIAL TYPE:
Press "ENTER" or "+" or "-" button to set the control serial type (RS-485, RS-232) of DVR.
- 2) BAUD RATE:
Press "ENTER" or "+" or "-" button to set the BAUD RATE of DVR (2400, 9600, 19200, 57600).
- 3) HOST ID:
Press "ENTER" or "+" or "-" button to set the ID of DVR (0 ~ 255).
- 4) IR:
Press "ENTER" or "+" or "-" button to set the IR function on / off.
- 5) PASSWORD:
Press "ENTER" to set the password for accessing DVR (admin password or guest password). Users who use guest password to access the DVR will only allow to view the live streaming video, sequence display, shift the channel display, and key lock.
- 6) RESET DEFAULT:
Press "ENTER", and select "YES" to confirm or "NO" to cancel.
- 7) CLEAR HDD:
Press "ENTER", and "YES" to confirm clear HDD or "NO" to cancel.
In this function, you can press "+" or "-" to select the HDD MASTER HDD, SLAVE HDD or DISK ARRAY which you plan to clear.
- 8) UPGRADE:
Press "ENTER", and select "YES" to confirm upgrade or "NO" to cancel.
- 9) AUTO KEYLOCK:
Set the auto key lock function (Never / 10 sec / 30 sec / 60 sec).
- 10) LANGUAGE:
Press "ENTER", and select the language of the OSD.
- 11) VERSION:
The firmware version information will be shown on the screen.
- 12) VIDEO FORMAT:
The information of the DVR's video format will be shown on the screen.

4.12 ADVANCE MENU __NETWORK

Move the cursor to the "NETWORK", and press "ENTER", then the screen will show the following options.

NETWORK	
NETWORK TYPE	STATIC
DNS	168. 95. 1. 1
PORT	0 0 8 0

1) NETWORK TYPE (STATIC):

Select NETWORK TYPE, and press "+" or "-" button to set the network type as STATIC, and then press "ENTER" to go to the submenu of the network. In the submenu of network type, use "+" or "-" button to set all the information needed in the DVR. See the illustration below.

STATIC	
IP	60. 121. 46. 236
GATEWAY	60. 121. 46. 226
NETMASK	255. 255. 255. 254

2) NETWORK TYPE (DHCP):

This DHCP function need to be supported by router or cable modem network with DHCP service. For detailed DHCP setting, please refer to P.37 and P.38 (Licensed Software AP).

3) NETWORK TYPE (PPPoE):

This PPPoE function need to have "username" and "password" from ISP supplier. For detailed PPPoE setting, please refer to P.37 and P.38 (Licensed Software AP).

NOTE:

DHCP and PPPoE network types need to apply DDNS service to get "Hostname" to correspond to dynamic IP address. For detailed DDNS setting, please refer to P.38.

4.13 ADVANCE MENU __ BACKUP

16CH / 8CH / 4CH

Move the cursor to the "BACKUP", and press "ENTER", then the screen will show the following options.

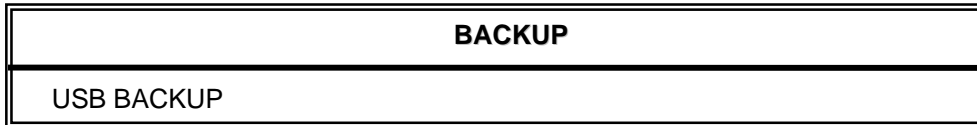

Select "USB BACKUP" and then press "Enter".

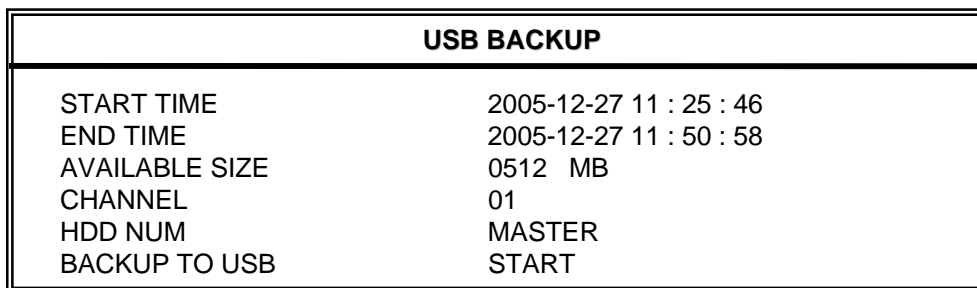

- 1) START TIME:
Select the start time of the backup.
- 2) END TIME:
Select the end time of the backup.
- 3) AVAILABLE SIZE:
The information of the USB available capacity.
- 4) CHANNEL:
Choose the channel.
- 5) HDD NUM:
Choose the HDD.
- 6) BACKUP TO USB:
Press "ENTER" to start backup the chosen file to USB.

NOTE:

- ① The USB format must be "FAT 32".
- ② If the USB is not supported by the DVR, then the "USB ERROR" message will be shown on the screen.
- ③ It is suggest that clear all the files in the USB before you backup files in your USB.
- ④ The file type of the backup files could use the licensed software to view the playback. Or convert to AVI format and playback with other software (such as Media Player or RealPlayer).

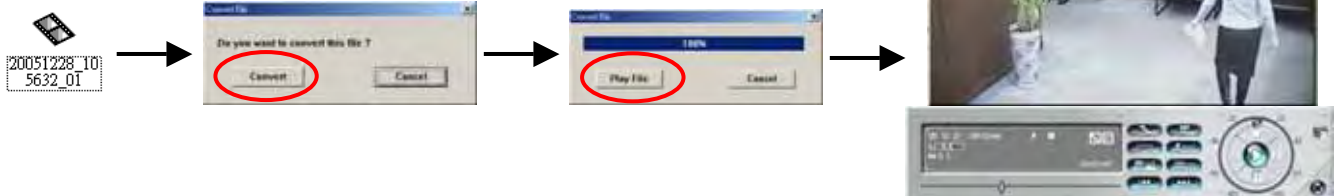

● 16CH (D) / 8CH (D) / 4CH (D)

Move the cursor to the “BACKUP”, and press ”ENTER”, then the screen will show the following options.

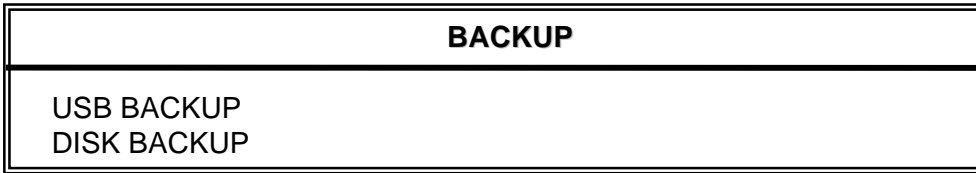

Select “DISK BACKUP” and then press “Enter”.

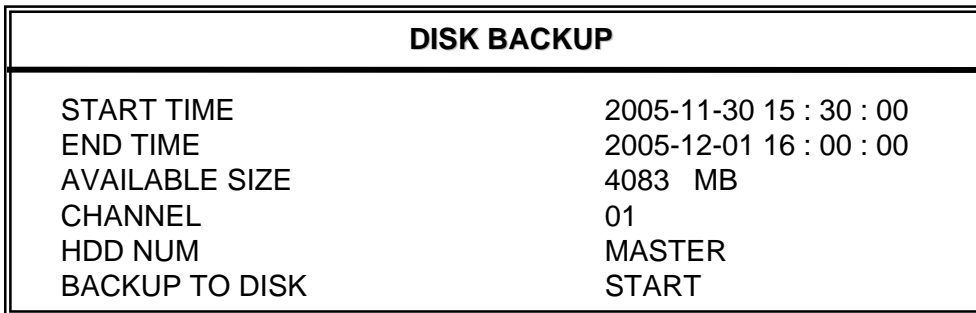

- 1) Press “+” and “-” buttons to open the **DVD / CD WRITER**. Put the **DISK** into **DVD / CD WRITER**, and press “+” and “-” buttons again to close. **(NOTE: Use DVD-R DISK only)**
- 2) Go to “DISK BACKUP” menu and set the start time, end time, channel and HDD number.
- 3) After setting up the backup information, move the cursor to “START”, and press “ENTER”. While the files are backup to **DISK**, users will see the backup completed percentage on the screen.
- 4) After backup files to **DISK**, “DISK BURN FINISH” will prompt on the screen. Press “+” and “-” to take out the **DISK** from **DVD / CD WRITER**.
- 5) Put **DISK** into the **DVD / CD -ROM** of PC. (O/S system: Windows XP, and Windows2000). And then double click the file → Convert the file → Play the backup file at PC Side.

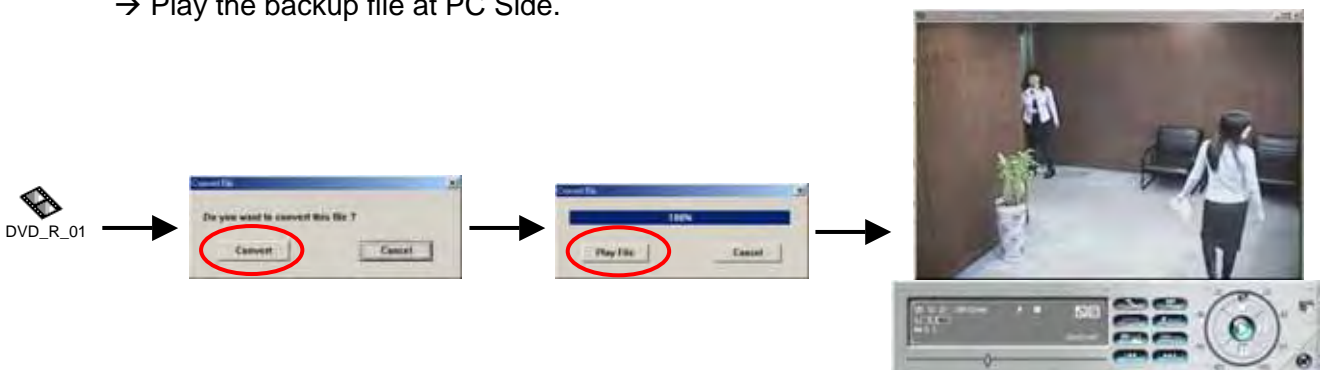

4.14 ADVANCE MENU __HDD INFO

You can get all the capacity information of the connected HDD.

HDD INFO			
HDD NUM	HDD SIZE	HDD NUM	HDD SIZE
MASTER	400.517	SLAVE	NO HDD
EXT001	400.517	EXT 002	400.517
EXT003	400.517	EXT 004	NO HDD
EXT005	NO HDD	EXT 006	NO HDD
EXT007	NO HDD	EXT 008	NO HDD
EXT009	NO HDD	EXT 010	NO HDD
EXT011	NO HDD	EXT 012	NO HDD

4.15 ADVANCE MENU __EVENT LOG

You can get all the information (event type, time, and channel) of the event list (including video loss list, net list, other lists (such as power on / off, key unlock, reset to default)). Select the event list you want to see and press "ENTER".

EVENT LOG	
VLOSS	LIST
NET	LIST
OTHERS	
CLEAN	ALL

- 1) VLOSS LIST:
Show the information of video loss list.
- 2) NET LIST:
Show the information of net login list.
- 3) OTHERS:
Show the information of power on / off, unlock, reset to default list.
- 4) CLEAN ALL:
Clear all the event log lists.

ADDITIONAL OPERATION

5.1 SEARCH

- 16CH / 8CH
- 16CH (D) / 8CH (D) / 4CH (D)

Press “**SHIFT**” + “**SEARCH**” buttons on the front panel of the DVR to enter the search mode. Then the screen will show the following options.

- 4CH

Press “**SEARCH**” buttons on the front panel of the DVR to enter the search mode. Then the screen will show the following options.

SEARCH	
HDD	MASTER
FULL	LIST
RECORD	LIST
SYSTEM	LIST
ALARM	LIST
MOTION	LIST
EVENT	SEARCH
TIME	SEARCH

- 1) HDD:
Select the the specific HDD.
- 2) FULL LIST:
List all recorded files
(R: RECORD / S: SYSTEM / A: ALARM / MS: MOTION / T: TIMER).
- 3) RECORD LIST:
List of manual recorded files.
- 4) SYSTEM LIST:
List of system recorded files.
Under continuous recording mode, the DVR system will save one recording file every one hour.
- 5) ALARM LIST:
List of alarm trigger recorded files.
- 6) MOTION LIST:
List of motion trigger recorded files.
- 7) EVENT SEARCH:
Search by specific time period (YEAR / MONTH / DAY / HOUR / MIN / CHANNEL).
Display all the motion triggered recording videos.
When you saw the playback of the motion triggered recording videos, it would play with fast speed.
- 8) TIME SEARCH:
Search by specific time period (YEAR / MONTH / DAY / HOUR / MIN).

NOTE:

Move the cursor to the specific recorded file and press “ENTER” to play the video, and press stop “■” button to return the live display.

5.2 2X DIGITAL ZOOM

Press “ZOOM” button on the front panel of the DVR to enlarge the picture of selected channel (2X digital zoom). You will have $\frac{1}{4}$ view size of the enlarged picture. Therefore use the “ ◀▶ ” to navigate.

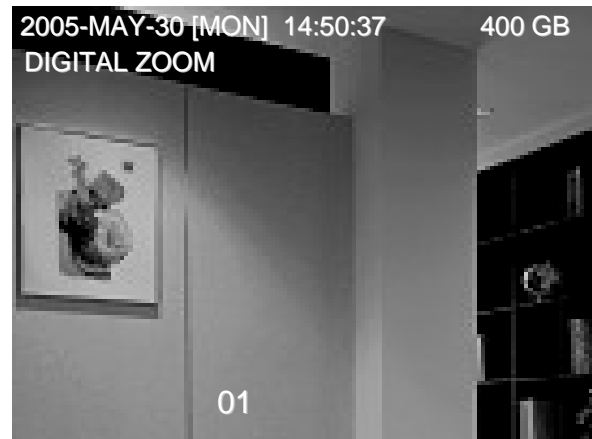

- 1) Press the “ZOOM” button again to exit the zoom picture.
- 2) Press “ ◀▶ ” button to move the zoom position.
- 3) Users could also press the “Digital Zoom” button on the IR remote control panel.

5.3 KEY LOCK

- 1) Key Lock On:
 - ① Press “MENU” + “ENTER” buttons on the DVR front panel to key lock.
 - ② Press “F2” button on the IR remote control to key lock.
 - ③ Auto key lock: refer to “Section 4.11 ADVANCE MENU_SYSTEM”.
- 2) Key Lock Off:

Press any key (except “SHIFT” and “POWER” buttons) and then key in the password to exit Key Lock mode.
- 3) Password:

As to the password setting, please refer to “Section 4.11 ADVANCE MENU_SYSTEM”.

5.4 SWITCH THE N/P SYSTEM

- 1) Press “POWER” button on the DVR front panel to shutdown, and then press “POWER” + “▶” to switch to PAL system.
(Press till the monitor show the video image of the DVR.)
- 2) Press “POWER” button on the DVR front panel to shutdown, and then press “POWER” + “◀” to switch to NTSC system.
(Press till the monitor show the video image of the DVR.)

5.5 USB UPGRADE

Users can use USB to upgrade.

Please format the USB memory device as FAT 32 format first.

- 1) Get the upgrade files from your distributor.
- 2) Save the upgrade files in your USB device (Do not change the file name).
- 3) Go to the "MAIN MENU – SYSTEM - UPGRADE" , and press "ENTER".
- 4) Select "YES", and press "ENTER" again to confirm upgrade.



1 WARNING UPGRADE ARE YOU SURE? YES NO	2 WARNING PLEASE WAIT... UPGRADE KERNEL OK	3 WARNING PLEASE WAIT... UPGRADE BOOT OK
4 WARNING PLEASE WAIT... UPGRADE HTML OK	5 WARNING UPGRADE SUCCESS REBOOT OK	6 WARNING SHUTDOWN PLEASE WAIT... OK

NOTE:

- ① The USB format must be "FAT 32".
- ② If the USB can't be detected by the DVR, the "USB ERROR" message will be shown on the screen.

5.6 LICENSED SOFTWARE AP

1) Install the Software:

- ① Place the attached CD into CD-ROM and it will start to install application programs into PC (Including AP and JAVA program).  
- ② The PC will run the setup file automatically.
- ③ After setup, user will see "  " icon on the desktop.

NOTE:

For the latest version of the software AP, please refer to your distributor, or refer to "Section 5.7 CONNECT TO AP VIA IE BROWSER".

2) Software Operation:

- ① Connect DVR to PC via RJ45 network line.
- ② LAN Setting :
The default DVR IP is “192.168.1.10”, and default “username” and “password” are both “admin”. Users should set PC’s IP address as “IP:192.168.1.XXX (1~255, except 10)” (in order to make the PC and DVR under the same domain).
- ③ Double click  to enter login page.
Key in IP (192.168.1.10), username (admin), password (admin), port (80) in the login page. After connect to the DVR with local LAN, users could modify the network settings in DVR or in system config of the licensed software AP.
- ④ Network Type ~ Static IP :
Set the network information in the DVR menu (Section 4.12) or in System Config of the licensed software AP (P.37).

Network Type ~ Dynamic IP (DHCP and PPPoE) :

Set the Network information in System Config of the licensed software AP. For detailed DHCP and PPPoE setting, please refer to P.37 and P.38.

- ⑤ After setup the network information, double click  to enter login page. Key in “Username”, “ Password”, “IP” (Static IP) or “Host name” (Dynamic IP), and “Port”. And then click the green button to connect.
- ⑥ LOGIN AP Icon Explanation.



Address Book: Press this button to add a new IP into the IP Address Book or choose any preset IP address to access the software AP.



Copy: Press this button to copy all the software installation files, so users could keep all the settings of video web server for next software installation on other PC.



Search: Search available DVR IP address in local area network and modify the network setting of the DVR.



Upgrade Firmware: Press this button, upgrade DVR firmware. The provided firmware files should be saved at PC first.



Player: Press this button to access and play the recorded files that are saved in your PC.

NOTE: The version of the licensed software will shown on the login page.

⑦ Introduction of Basic Operation : Video Web Server Control Panel.
Digital Device Control Panel ~ Take 16CH DVR as an example

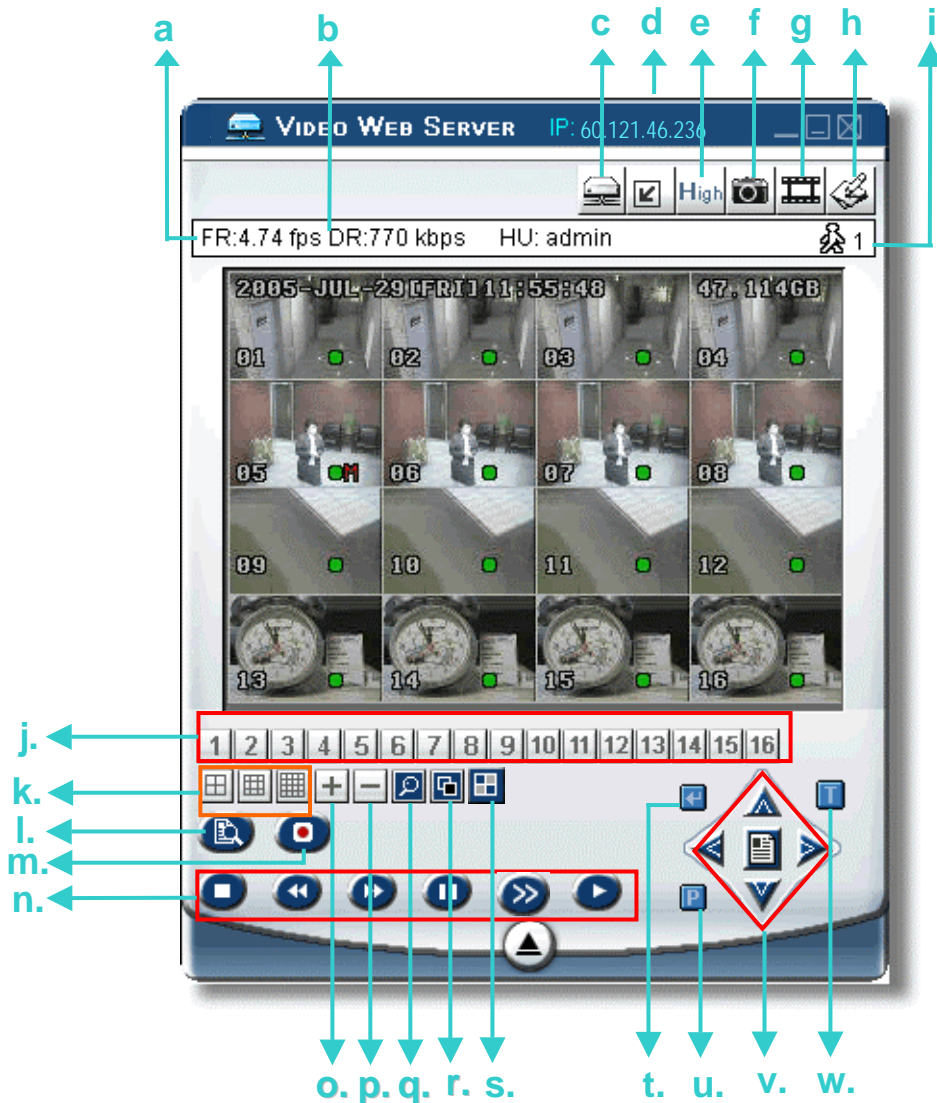

- a. Image Transfer Rate Per Second
- b. Data Transfer Rate
- c. Connect / Disconnect
- d. Resolution:
 NTSC: 320 x 228 ; 640 x 456
 PAL: 320 x 276 ; 640 x 552
- e. Image Quality (High, Medium, Low)
- f. Snapshot : press this button to have a snapshot of the image which will be saved in the designated destination.

- g. Record : press this button to start recording, and press this button again to stop recording. The recorded files will be saved to the designed path on the PC. Each recording file can be up to 18,000 frames. When the recording file is full, the new recorded file will be saved as the second file.
If the HDD space is less than 200MB, the program will stop recording.
- h. System Config: press this button to enter the setting page of the software AP.
- i. Number of Online Users
- j. CH 1 ~ 16
- k. 4, 9, 16 Channel Display
- l. Search
- m. Record
- n. Stop / Fast Rewind / Fast Forward / Pause / Slow Playback / Play
- o. +
- p. -
- q. Digital Zoom
- r. Set : press this button to change channel display position.
Press “ ◀▶ ” to select the channel which You would like to change.
Press “ + ” or “ - ” select the channel which You would like to show.
Press “Enter” button to confirm.
- s. Sequence: press this button to enter the call monitor function and press again to exit from call monitor mode.
- t. Enter
- u. PTZ Control On / Off:
When the PTZ control turned on, users could select the PTZ device, and press “OK” button to enter the PTZ control AP screen.
(Press “ESC” to exit from PTZ control AP screen and back to DVR control AP screen)

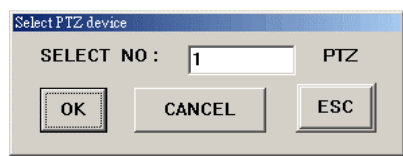

- v. Menu / Up / Down / Left / Right
- w. Turbo ON/ OFF:
To speed up menu selection or the control of the PTZ camera under software AP, users could activate "Turbo" function by clicking this button. Users are allowed to change the turbo steps from 1 to 10. .
Ex. If users activate the TURBO function, and set the value of the turbo step as 3, then when users press one of the button up/down/left/right, one mouse click will function as clicking 3 times.

Digital Device Control Panel ~ PTZ



- j. Preset 1 ~ 16
- k. AUTO
- l. Zoom Tele Zoom Wide
- m. Focus Near Focus Far
- n. Max Zoom In Max Zoom Out
- o. Enter
- p. PTZ Control On / Off:
When PTZ control mode is turned on, users could select the PTZ device, and press "OK" button to enter the PTZ control AP screen. (Press "ESC" to exit from PTZ control AP screen and back to DVR control AP screen)
- q. Menu / Up / Down / Left / Right
- r. Turbo:
To speed up menu selection or the control of the PTZ camera under software AP, users could activate "Turbo" function by clicking this button. Users are allowed to change the turbo steps from 1 to 10. .
Ex. If users activate the TURBO function, and set the value of the turbo step as 3, then when users press one of the button up/down/left/right, one mouse click will function as clicking 3 times.

⑧ Playback Operation

AP Playback Window :



AP Config. Setting Box :



One click to activate



A. Playback Information :

Display information such as “Date”, “Time”, “Resolution”, “ Rewind / Forward Speed”, “Status” and “Functions”, etc..

B. Time Progress Bar :

Show the playback progress status.

C. Functions :

- **De-interlace:** Reduce the vibration of the paused picture.
- **De-blocking:** Reduce the video mosaic phenomenon.
- **OSD:** Display the OSD of the AP playback window.
- **AVI convert:** Convert the entire recorded file to AVI format.
- **Config. Setting:** Enter AP config. setting box, and set the file destination, text color, and text color of progress status.
- **Watermark:** Proof the authenticity of the backup video.
- **Open Previous File:** Open previous backup video.
- **Open Next File:** Open next backup video.

D. Playback Control Buttons :

Play / Stop / Pause / Fast Rewind / Fast Forward

E. Snapshot :

Press this button to take a snapshot of the current image which will be saved in the designated destination.

F. Close the Player.

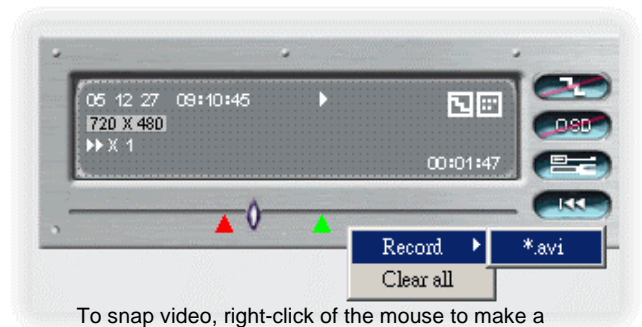

To snap video, right-click of the mouse to make a starting point (red) and click one more time to make a ending point. Then right-click to convert to AVI format.

Note:

- When users pause the playback picture, press “” button to go to the previous frame, or press “” button to go to the next frame.
- In the playback mode of the software AP, users could press “” button to check the authenticity of the **BACKUP VIDEO**. If the **BACKUP VIDEO** had been altered, the video image will turn to light red and the playback will be paused.

3) Advanced Setting:



- ❑ Press "System Config"  " button to enter the system setting page.

Network

The network configuration allows DVR to be available for Ethernet network or dial-up.

① Static IP:

Enter the "server IP", "gateway", "net mask" and "web port", then press "APPLY" to confirm.

② PPPoE:

Enter the "username" and "password" provided by your ISP (Internet Server) supplier, then press "APPLY" to confirm.

③ DHCP:

This DHCP function need to be supported by router or cable modem network with DHCP service. Choose the DHCP IP type and press "APPLY" to confirm.

Note:

PPPoE and DHCP network connection type will require to apply DDNS service to get a "Hostname" to correspond to dynamic IP address. Please refer to P.38 for details.

Note:

Some router brand may need to restart the DVR to get the IP address.

④ Web Port:

The DVR can be viewed over the network with software AP or a web browser. Typically the TCP port used by HTTP is 80. However in some cases it is better to change this port number for added flexibility or security. Valid number is 80 ~ 19999.

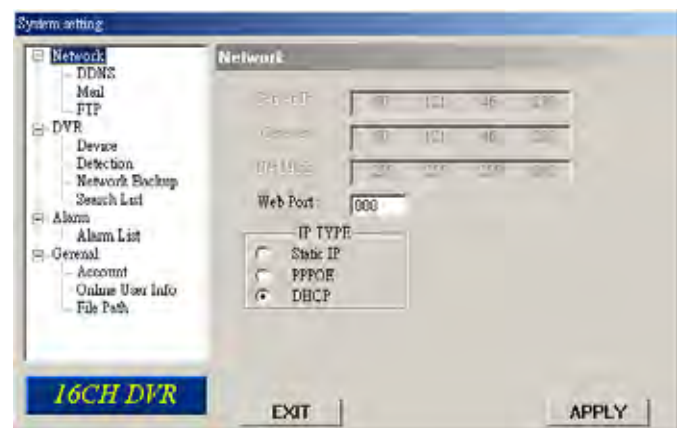
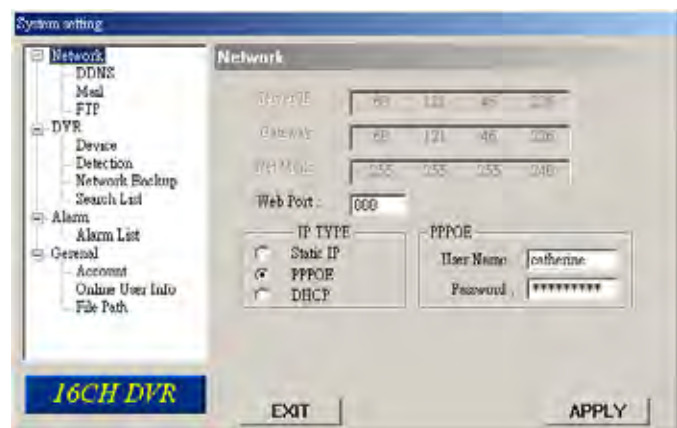

DDNS

- ① DDNS is a service for transforming dynamic IP to corresponding to a specific "Hostname".
- ② **DDNS Apply:**
Go to a website which provide free DDNS services and apply a "Hostname". See the example below.
- ③ **Enable the DDNS function:**
Enter "DDNS username" into "username" column.
Enter the "DDNS password" into "password" column.
Enter the "Hostname" into "Domain" column.
Choose the "DDNS system name".
After setting, press "APPLY" to confirm.

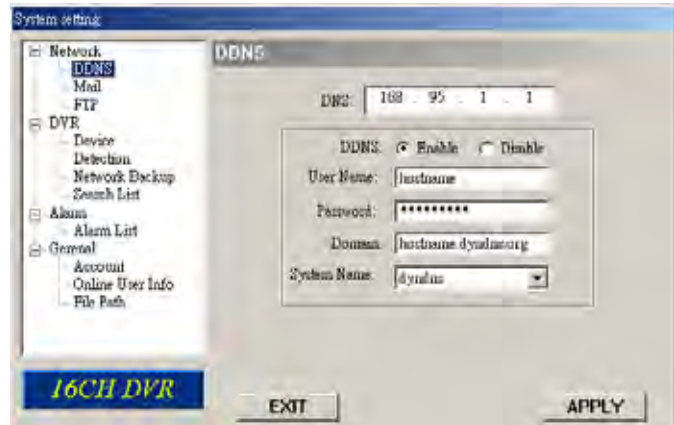

DDNS APPLY EXAMPLE:

- ❑ Go to a website which provide free DDNS services.
For example, "http://www.dyndns.org".
- ❑ Create an account in DynDNS.
- ❑ After created your account, users will receive an confirmation e-mail within few minutes. To complete registration, please follow the instructions received. Users must complete these steps within 48 hours to complete the registration. If the confirmation e-mail was not received within an hour, request "password reset" (<http://www.dyndns.org/account/resetpass/>).
- ❑ Use the DDNS username and password to login the DynDNS.
- ❑ **Create Hostname:**
Login "Account" "My Service" "Add Host Services" "Add Dynamic DNS Host" Enter and choose the hostname Click on "Add Host" DDNS Hostname created.

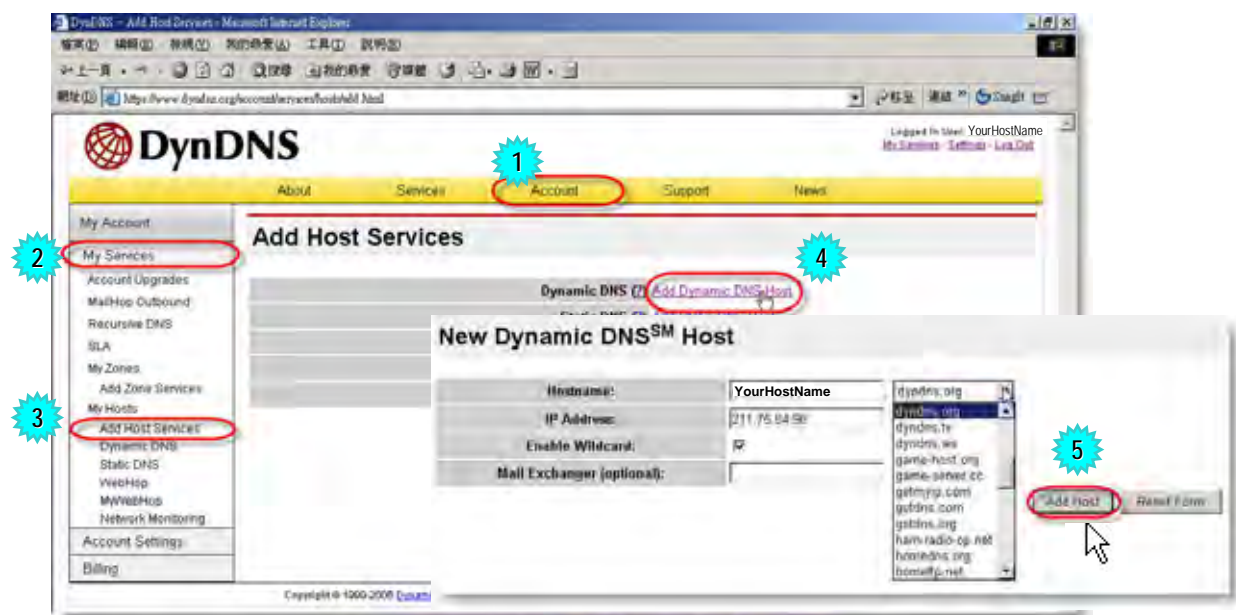

Mail

- ① When alarm or motion is triggered, a video copy file can be captured. DVR can send e-mail notification to the assigned recipients (up to 5 recipients).

*****Note***:**

To activate the e-mail notification function, please enable the function of e-mail notification in the “**Alarm**” setting first (page 43).

- ② Add the recipients' email accounts in the “**Mail Account**” column. The detailed information (SMTP server, username and password) refer to e-mail system supplier.
- ③ Please type in the entire email address in the “**Mail from**” column to ensure emails will not be blocked by SMTP.
- ④ In some cases, mail server require to verify password, please enter the “**user name**” and “**password**”.
- ⑤ After setting, press “**APPLY**” to confirm.



FTP

- ① When alarm or motion is triggered, a video copy file can be captured. And DVR can upload the captured images to the assigned FTP site.
- ② Enter the detailed FTP information.

*****Note***:**

To activate the FTP notification function, please enable the function of FTP notification in the “**Alarm**” setting first.

- ③ After setting, press “**APPLY**” to confirm.



DVR – Camera Setting

Take 16CH as an example

- ① Each camera channel can be adjusted independently.
- ② Select the desired camera channel. Press “Edit” to enter the setting box.
- ③ **Title:**
Enter the camera channel name up to 6 characters.
- ④ **Adjustment:**
Adjust the BR (brightness) / CT (contrast) / SU (saturation) / HU (hue) / REC (recording) of the camera.
- ⑤ After setting, press “OK” and then press “APPLY” to confirm.



Device

Take 16CH as an example

- ① Select the desired channel of the installed external device. Press “Edit” to enter the setting box.
- ② **Device Type:**
Choose either general camera or PTZ camera.
- ③ **ID No. :**
Set the ID number (0 ~ 255) of the installed external PTZ device.
- ④ **Protocol Type :**
Choose “NORMAL” protocol for our own brand camera.
Choose “P-D” protocol for PELCO-D protocol camera.
- ⑤ **Baud Rate :**
Set the baud rate of each channel (2400, 4800, 9600, 19200, 38400, 57600, 115200).
- ⑥ After setting, press “OK” and then press “APPLY” to confirm.

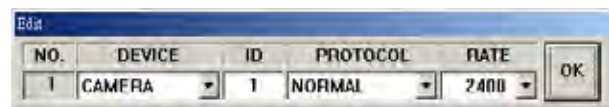
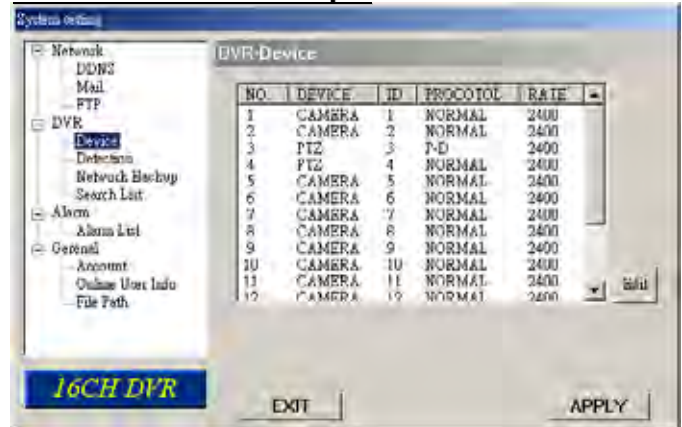

Detection

① Select the desired channel, and press “Edit” to enter the motion detection sensitivity and area setting box.

② **Motion Detection Sensitivity:**

Set the detection sensitivity in 4 different adjustable factors.

LS: The sensitivity of comparing two different images. The smaller the value is, the higher sensitivity for motion detection.

SS: The sensitivity towards the size of the triggered object on the screen (the number of motion detection grids). The smaller the value is, the higher sensitivity for motion detection.

TS: The sensitivity towards how long the object gets triggered. The smaller the value is, the higher sensitivity for motion detection.

RE: The value of RE is a reference for detection. The bigger the value is, the higher sensitivity for motion detection.

③ **Alarm:**
Select LOW / HIGH for the alarm polarity.

④ **Motion Detection Area:**
Clicking the area by PC mouse, one can choose the motion area to be detected. The under-detection area is in transparent picture while the undetected area is in pink color.
*Click the “**Select All**” to clean the previously selected detection area.
*Click the “**Clear All**” to activate the detection area as full area.

⑤ After setting, press “OK” and then press “APPLY” to confirm.

Take 16CH as an example

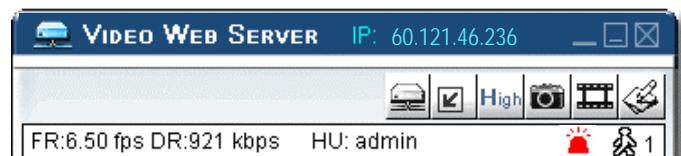
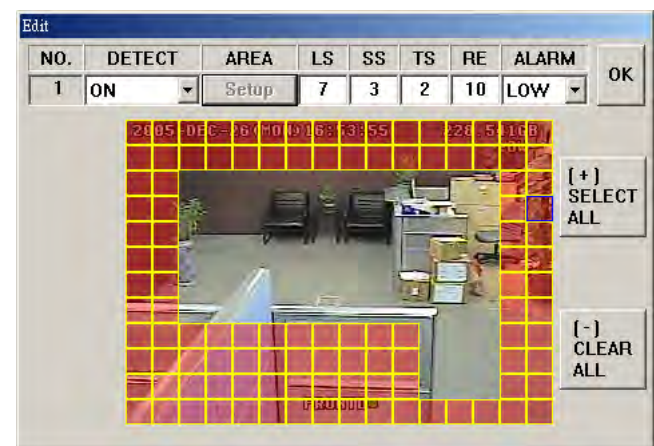

Note: Enable the motion detection function. When the motion is triggered, a “🔴” icon will shown on the screen. And software AP will start recording automatically.

Network Backup & Playback

- ① Backup the recorded files to the PC from DVR via network.
- ② Enter the backup information → Press “Start” → Success → Convert → Play File.

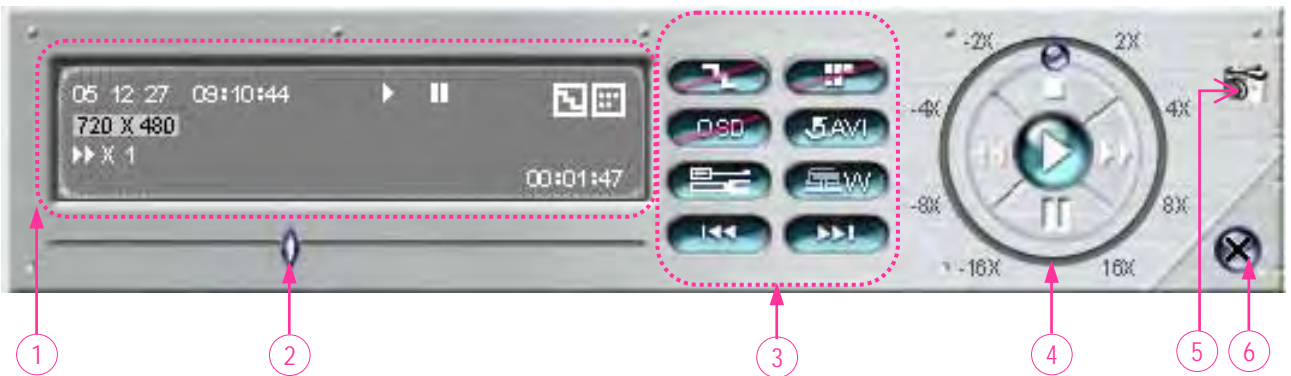
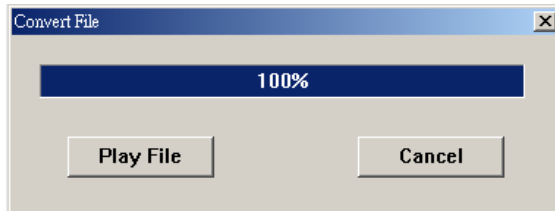
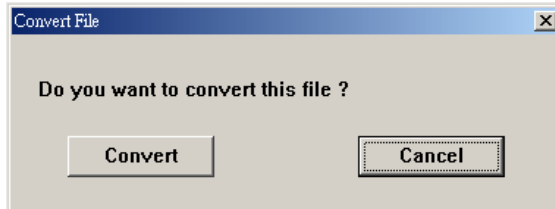
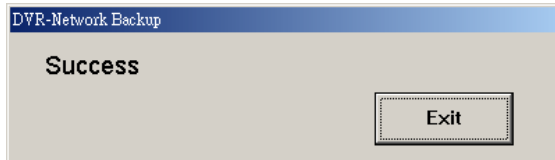
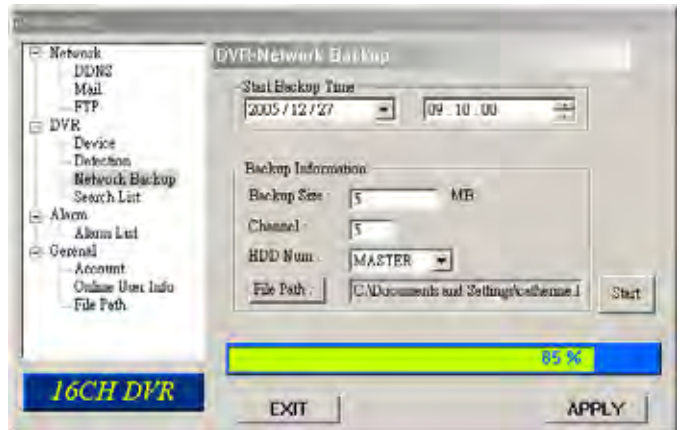

1. Playback Information

2. Time Progress Bar

3. Functions :

- (1) De-interlace
- (2) De-blocking
- (3) OSD
- (4) AVI Convert
- (5) Config. Setting
- (6) Watermark
- (7) Open Previous
- (8) Open Next File

4. Playback Control Buttons :

Play / Stop / Pause / Fast Rewind / Fast Forward

5. Snapshot

6. Close the Player.

Note:

While backup the file, users can see the live playback image at the same time.

Alarm

- ① **Alarm Trigger:**
Enable or disable Email and FTP notification function.
- ② **Alarm Method:**
Two notification methods — Email and / or FTP.
- ③ **Post Number:**
Set MJPEG pictures (1-10 pictures).
- ④ **Alarm Duration:**
Set the duration time of motion trigger recording (3 sec., 15 sec., 30 sec., 1 min., or 30 min.).
- ⑤ **Alarm Refresh:**
Clean the alarm message ‘🔔’ which is shown on the screen.

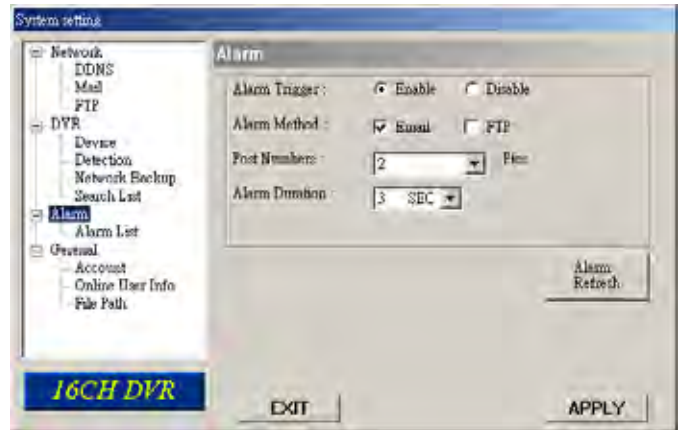

Note:

Email Notification:

MJPEG pictures will be made at your designated space set in “File Path”, plus an e-mail contained with the MJPEG pictures (1-10 pictures) to be sent to the address which is set under “Mail”.

FTP Notification:

MJPEG pictures will be made at your designated space set in “File Path”, plus a FTP file contained with the MJPEG pictures (1-10 pictures) to be sent to the address which is set under “FTP”.

Alarm List

- ① It’s a database, which precisely lists all alarm triggered events, with IP address of Video Web Server, alarm triggered time, and number of frames.
- ② Users could directly play, delete, or clear all motion trigger recording events easily.
- ③ Click on the “Refresh” button to update the database list.
- ④ All the motion triggered files will be listed systematically for easily search.

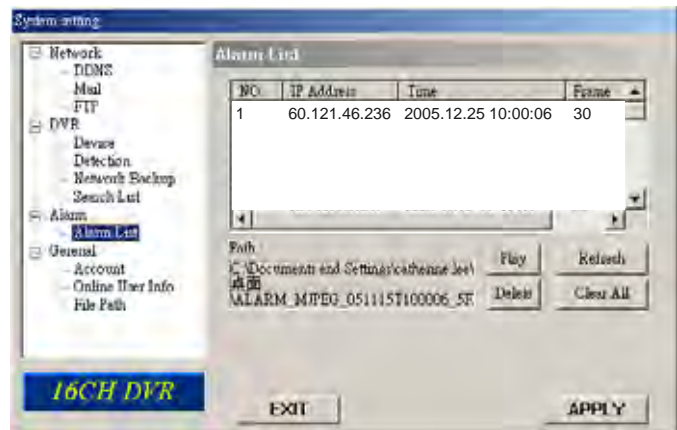

General

- ① Get the information of DVR firmware version in this window.
- ② **Select "Turbo Step" (1 - 10).**
To speed up menu selecting or the control of the PTZ camera under video web server, users can activate "Turbo" function by clicking this button. Users are allowed to change the turbo steps from 1 to 10.
Ex. If the value of turbo step is "5" means that when user press one of the button up/down/left/right, one click is as clicking 5 times.
- ③ **Max Log List:**
Set the maximum number of log list.
- ④ **Server Log:**
Press "Server Log" button to enter the server log list window.

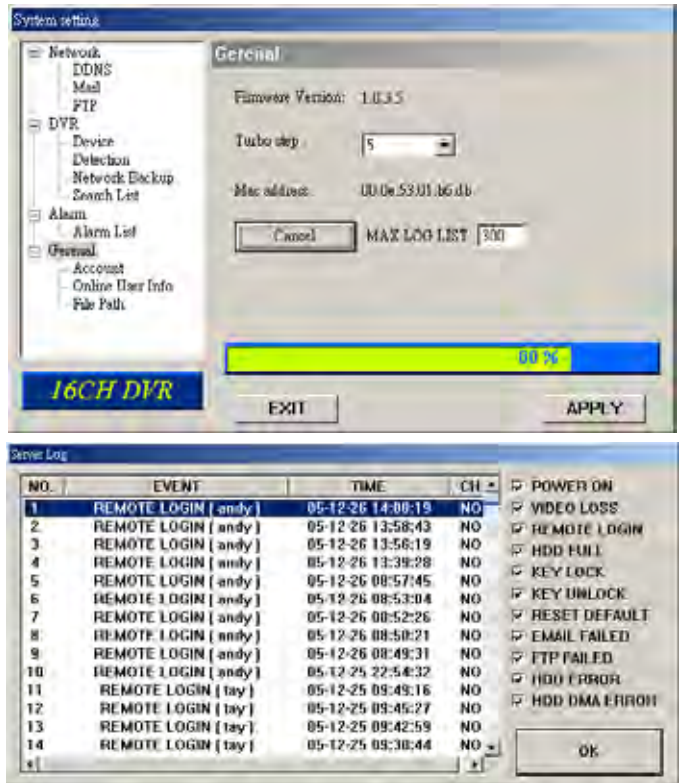

Account

- ① Set up the user's account (Max 5 accounts) , password, life time, and authority level.
(Max 5 users on line at the same time).
- ② **User's level:**
SUPERVISOR —
Control all the functions ("a", "b", "c", "d", "e" and "f").
HIGH —
Control only "a", "b", "c", "d" and "e" functions, but cannot control "f" function.
NORMAL —
Control only "a", "d", and "e" functions, but cannot control "b", "c" and "f" functions.
GUEST —
Watch the image only. Only the "a" function can be used.
- ③ **Life time :**
According to different authority level, different accounts can stay online for different time period (1min, 5min, 10min, 1hour, 1day, infinity).

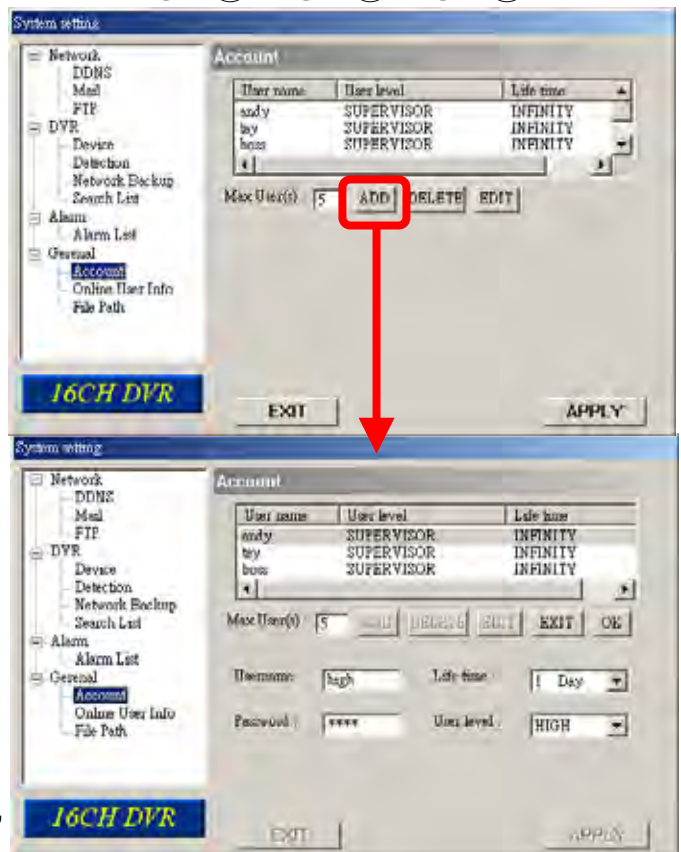
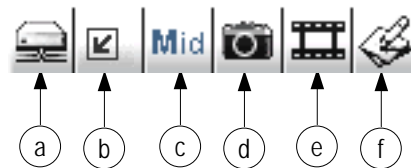

Online User Info

- ① Get all the online users' information list (Name, IP Address, Authority Level, Resolution and Image Quality).

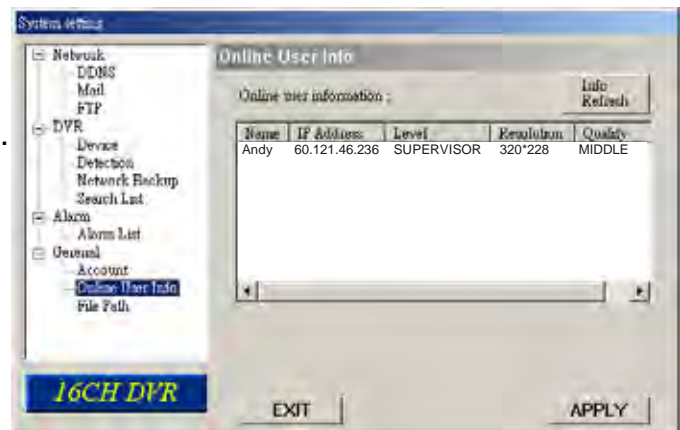

File Path

- ① **Snapshot Path:**
Assign the route for saving the snapshot picture.
- ② **Record Path:**
Assign the route for saving the manual recording file.
- ③ **Alarm Audio Path:**
The default alarm audio sound is "alarm.wav". Users could have their own alarm sound file by giving the file path.

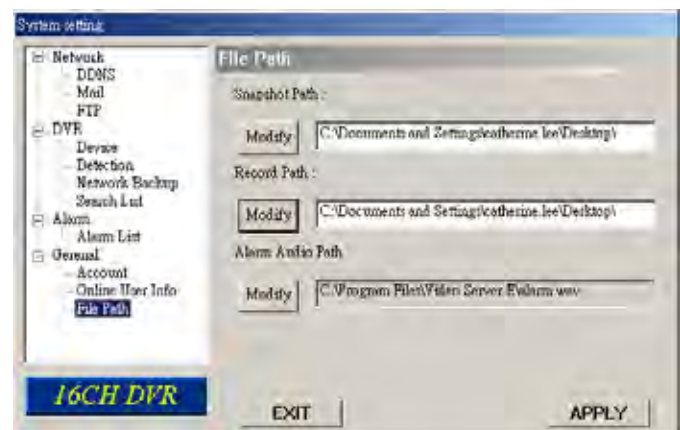

5.7 CONNECT TO AP VIA IE BROWSER

The DVR can be viewed over the network with a web browser. Please install licensed software AP first.

***** This function is suitable in both Windows 2000 and Windows XP *****

Step 1: Type in IP address into the URL address box and press enter. Then you'll see the following page.

Note: If the TCP port number is not 80, see the example below.
 IP address: 60.121.46.236 ; Port number: 888
 → Key in "http://60.121.46.236 :888" into the URL address box and press enter.



NOTE: Users can download the latest AP version from the website.
NOTE: Users can update the JAVA program from the website.

Step 3: Key in the "username" and "password". Then you'll see the following page to login

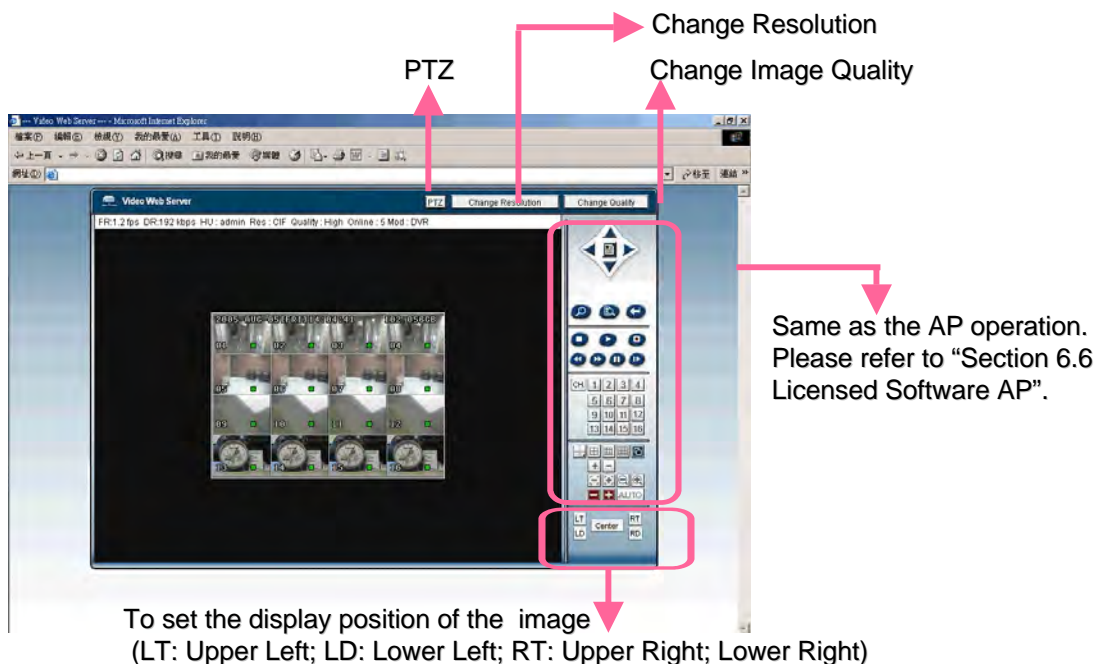

5.8 GPRS

GPRS function Installation and Viewing (Take **Motorola 768i** for example)

- 1) Your mobile service provider must have GPRS service, and the phone handset needs to support GPRS and Java MIDP 2.0 to run the application.
- 2) Connect to the website <http://211.22.74.18> via the web browser of your cell phone. (Make sure that your GPRS function is working).
- 3) Download and install "16CH_MPEG-4" / "8CH_MPEG-4" / "4CH_MPEG-4".
- 4) After installation, the "16CH_MPEG-4" / "8CH_MPEG-4" / "4CH_MPEG-4" icon will shown on the desktop of the phone.
- 5) Click the icon of the "16CH_MPEG-4" / "8CH_MPEG-4" / "4CH_MPEG-4" video server to enter the setting frame.
Please type in IP address, port, username, and password of the DVR, which you like to see. And then press "connect" button.
- 6) After connected to the "16CH_MPEG-4" / "8CH_MPEG-4" / "4CH_MPEG-4" video server, you will see AP interface shown on the screen and will see "Online" on title.
- 7) Wait 3 minutes for video signal to coming out.
- 8) After video signal is shown, you could monitor and control your security system handily anytime, anywhere.

NOTE: It's not suggested to set the DVR port as 80 port.
Because some telecommunication service provider may regulate 80 port.

5.9 OPTIONAL PERIPHERALS

For the operation of the following peripherals, please refer to their manual individually.

- 1) IDA (independent disk array).
- 2) VGA connector.
- 3) For 4CH DVR, IR Remote Control is optional.

TROUBLE SHOOTING

6.1 FAQ

Please refer to the FAQ table below for easy trouble shooting. The table below describes some typical problems and also their solutions. Please check them before calling your DVR dealer.

PROBLEM	SOLUTION
No power	Check power cord connection.
	Confirm that there is power at the outlet.
Not working when pressing any button	Press any key and then enter the password to exit "Key Lock" mode.
Timer record is not working	Check if the "RECORD ENABLE" is set to "YES".
No live video	Check camera video cable and connections.
	Check monitor video cable and connections.
	Confirm the camera is power supplied.
	Check the setting of camera lens.
No recorded video	Check if the HDD is installed and connected properly
DVR keeps rebooting	Users could align the power connector and HDD closely, or change another suitable HDD.
Detect HDD fail	Change another HDD for testing.
	Change another HDD cable for testing.
	Make sure HDD "Master", "Slave" mode is correctly set.
Can't detect USB thumb-drive	Change another USB thumb-drive to test.
When two Seagate's power-saving HDDs installed, DVR can't be turned on successfully.	Please don't use 2 Seagate's power-saving HDDs simultaneously.
Can't view the DVR over the network with a web browser	Update the JAVA program Update the firmware of the software AP

APPENDIX #1 – INSTALL THE HDD

- 16CH / 8CH
- 16CH (D) / 8CH (D) / 4CH (D)

Carefully following the steps to ensure correct installation.

*** Note: If you want to install two HDDs, please set one HDD to “Master Mode” or “Single Mode”, and the other one to “Slave Mode”. ***

- 1) Open the upper cover of the DVR and screw out the bracket. ① ~ ②
- 2) Screw HDD to the HDD bracket. ③ ~ ⑧
- 3) Connect the HDD to power connector and IDE BUS (make sure to align the HDD precisely to the pin connection). ⑨ ~ ⑭
- 4) Close the upper cover of the DVR.

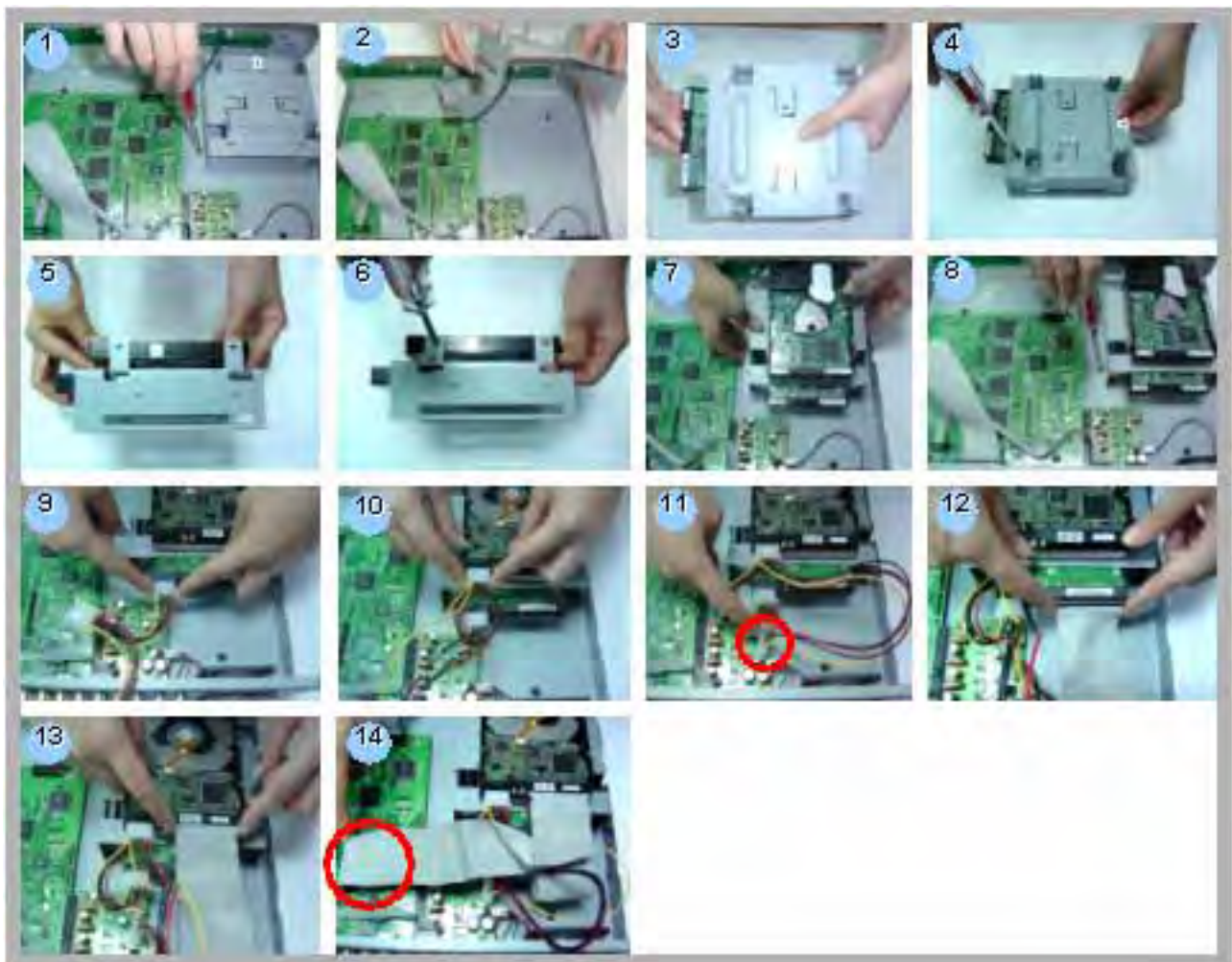

● 4CH

Carefully following the steps to ensure correct installation.

*** Note: Please set one HDD to "Master Mode" or "Single Mode" ***



- **Step 1** Connect the connector with the HDD (refer to Picture 1).
- **Step 2** Put HDD into the HDD cartridge. Please notice the bottom side is power side as chart shows (refer to Picture 2).
- **Step 3** Screw the HDD to the cartridge. Before you screw the HDD, please be aware that you must to level pin 1 of the HDD at pin 1 mark, because the screw hole is different from different HDD brands. Then screw the HDD correctly (refer to Picture 3 and 4). You must precisely align the hard disk to the pin connection to ensure correct installation.
- **Step 4** Reverse the HDD and put it into DVR (refer to Picture 5 and 6).
- **Step 5** Connect the HDD with DVR (refer to Picture 7).
- **Step 6** Lock the cabinet by turning the key clockwise (refer to Picture 8).

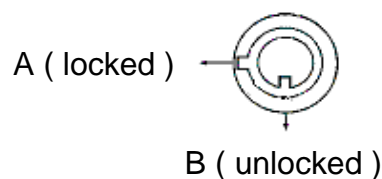

Note : If you do not lock the cabinet, the DVR system will not function properly.

- **Step 7** Close the cap (refer to Picture 9).

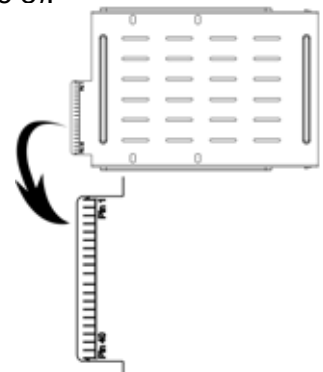

APPENDIX #2

APPENDIX #2 – PIN CONFIGURATION

- 16CH / 8CH
- 16CH (D) / 8CH (D) / 4CH (D)

PIN 1. GND
GROUND

PIN 2. ~ PIN 9. ALARM INPUT

To connect wire from ALARM INPUT (PIN 2 -- 9) to GND (PIN 1) connector,
DMR will start recording and buzzer will be on.

When Menu/ Camera/ Alarm is set up to “Low” : When alarm input signal is “ Low ”, the unit starts to record and buzzer.

When Menu/ Camera/ Alarm is set up to “High” : When alarm input signal is “ High ”, the unit starts to record and buzzer.

PIN 10. PIN OFF

PIN 11. TXD232

DVR can be controlled remotely by the keyboard of PC, using RS-232 serial communications signals.

PIN 12. RS485-A

DVR can be controlled remotely by the keyboard of PC, using RS-485 serial communications signals.

PIN 13. EXTERNAL ALARM NO.

Under normal operation COM disconnect with NO. But when Alarm triggered, COM connect with NO.

Attention: Voltage restrictions is under AV/DC 30V.

PIN 14. PIN OFF

PIN 15. ~ PIN 22. ALARM INPUT

To connect wire from ALARM INPUT (PIN 15 -- 22) to GND (PIN 1) connector,
DMR will start recording and buzzer will be on.

When Menu/ Camera/ Alarm is set up to “Low” : When alarm input signal is “ Low ”, the unit starts to record and buzzer.

When Menu/ Camera/ Alarm is set up to “High” : When alarm input signal is “ High ”, the unit starts to record and buzzer.

PIN 23. RXD232

DVR can be controlled remotely by the keyboard of PC, using RS-232 serial communications signals.

PIN 24. RS485-B

DVR can be controlled remotely by the keyboard of PC, using RS-485 serial communications signals.

PIN 25. EXTERNAL ALARM COM

Under normal operation COM disconnect with NO. But when alarm triggered, COM connect with NO.

Attention: Voltage restrictions is under AV/DC 30V.

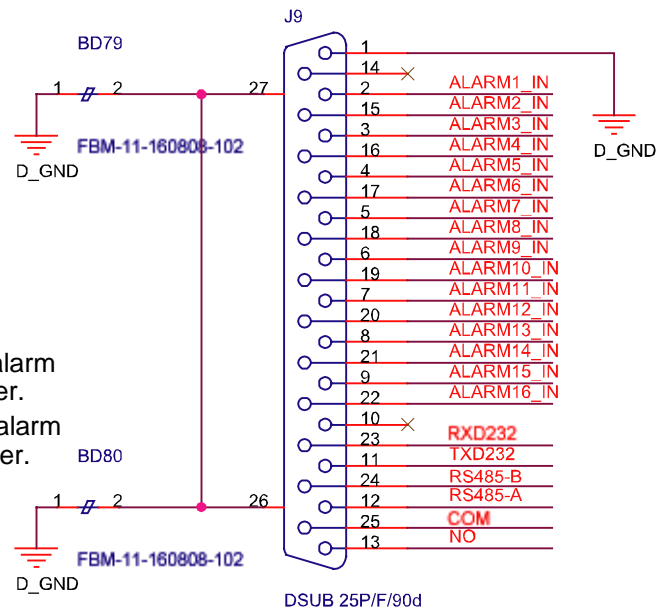

4CH

PIN 1. **RS232-TX**

DVR can be controlled remotely by the keyboard of PC, using RS-232 serial communications signals.

PIN 2. **RS232-RX**

DVR can be controlled remotely by the keyboard of PC, using RS-232 serial communications signals.

PIN 3. ~ PIN 5. **ALARM INPUT**

To connect wire from ALARM INPUT (PIN 3 -- 5) to GND (PIN 9) connector, DVR will start recording and buzzer will be on.

When Menu/ Camera/ Alarm is set up to "Low" : When alarm input signal is " Low ", the unit starts to record and buzzer.

When Menu/ Camera/ Alarm is set up to "High" : When alarm input signal is " High ", the unit starts to record and buzzer.

PIN 7. **EXTERNAL ALARM NC**

Under normal operation COM connect with NC and disconnect from NO. But when alarm is triggered, COM disconnect with NC, and connect with NO.

Attention: Voltage restrictions is under AV/DC 30V.

PIN 8. **EXTERNAL ALARM NO.**

Under normal operation COM disconnect with NO. But when Alarm triggered, COM connect with NO.

Attention: Voltage restrictions is under AV/DC 30V.

PIN 9. **GND**

Signal GND.

PIN 10. **RS485-B**

DVR can be controlled remotely by the keyboard of PC, using RS-485 serial communications signals.

PIN 11. **RS485-A**

DVR can be controlled remotely by the keyboard of PC, using RS-485 serial communications signals.

PIN 12, 13. **PIN OFF**

PIN 14. **ALARM RESET**

To connect wire from ALARM RESET (PIN 14) to GND (PIN 9) connector, it can disable ALARM. An external signal to

ALARM RESET (PIN 14) can be used to reset both ALARM OUTPUT signal and DVR's internal buzzer. When alarm has been triggered, signal becomes "Low", and it will stop all alarm activities. Under normal operation, signal remains "High".

PIN 15. **EXTERNAL ALARM COM**

Under normal operation COM disconnect with NO. But when alarm triggered, COM connect with NO.

Attention: Voltage restrictions is under AV/DC 30V.

PIN 16, 17. **GND**

Earth GND

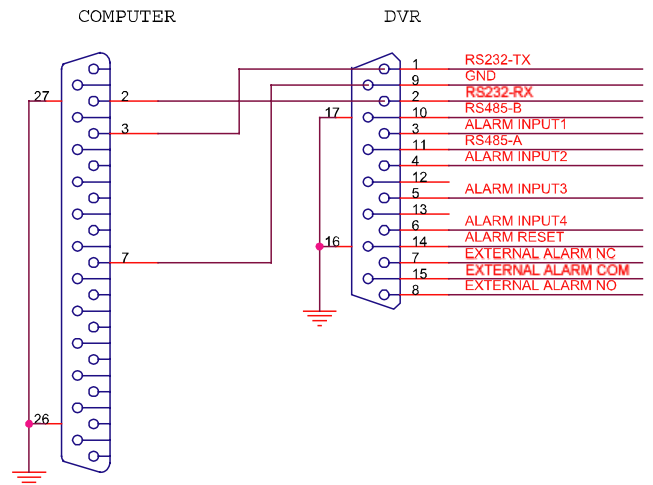

APPENDIX #3

APPENDIX #3 – RS-232 Protocol

- 1) Use PC keyboard to simulate DVR keypad.
- 2) Data: REMOTE PROTOCOL use 8 bit data, 1 start bit, 1 stop bit.

FUNCTION	CODE	ASCII	FUNCTION	CODE	ASCCI
KEY_MENU	0x4D	M	KEY_CH1	0x31	1
KEY_ENTER	0x0D	ENTER	KEY_CH2	0x32	2
KEY_4 CUT	0x61	a	KEY_CH3	0x33	3
KEY_ZOOM	0x5A	z	KEY_CH4	0x34	4
KEY_9 CUT	0x62	b	KEY_CH5	0x35	5
KEY_16 CUT	0x63	c	KEY_CH6	0x36	6
KEY_SLOW	0x53	S	KEY_CH7	0x37	7
KEY_REC	0x72	r	KEY_CH8	0x38	8
KEY_LEFT	0x4C	L	KEY_CH9	0x39	9
KEY_UP	0x55	U	KEY_CH10	0x41	A
KEY_PLAY	0x50	P	KEY_CH11	0x42	B
KEY_DOWN	0x4E	N	KEY_CH12	0x43	C
KEY_RIGHT	0x52	R	KEY_CH13	0x44	D
KEY_POWER	0x57	W	KEY_CH14	0x45	E
KEY_KEY LOCK	0x4B	K	KEY_CH15	0x46	F
			KEY_CH16	0x47	G

APPENDIX #4

APPENDIX #4 - RECORDING TIME TABLE

Take 16CH as an example

- 1) Recording time varies depending on the following factors:
 - * Different camera quality
 - * Different picture composition (such as frequency of the object movement)
- 2) Record day for 8CH: please multiply "Record day" by 2.
Record day for 4CH: please multiply "Record day" by 4.

Record mode	Quality	IPS	500GB record time(hour)	Record day
Frame	Best	120	109	4.6
		60	192	8.0
		30	349	14.6
		15	565	23.5
	High	120	138	5.8
		60	243	10.1
		30	442	18.4
		15	714	29.8
	Normal	120	182	7.6
		60	319	13.3
		30	581	24.2
		15	939	39.1
	Basic	120	293	12.2
		60	516	21.5
		30	939	39.1
		15	1517	63.2
CIF	Best	480	130	5.4
		240	229	9.5
		120	417	17.4
		60	673	28.0
	High	480	184	7.6
		240	323	13.4
		120	587	24.5
		60	949	39.5
	Normal	480	242	10.1
		240	424	17.7
		120	773	32.2
		60	1249	52.0
	Basic	480	335	13.9
		240	588	24.5
		120	1071	44.6
		60	1730	72.1

APPENDIX #5

APPENDIX #5 – COMPATIBLE USB BRAND

NOTE: Please upgrade the Firmware of the DVR to latest version to ensure the accuracy of following table

Manufacturer	Model	Capacity
Transcend	JetFlash 110	256MB
Transcend	JetFlash 110	512MB
Kingston	DataTraveler DTI KUSB DTI/256FE	256MB
Kingston	DataTraveler DTI KUSB DTI/256FE	512MB
PQI	Cool Drive (U339)	256MB
PQI	Cool Drive (U339)	512MB
Apacer	HANDY STENO HF202	256MB
Apacer	HANDY STENO HF202	512MB
SanDisk	Cruzer Micro	128MB
SanDisk	Cruzer Micro	256MB
SanDisk	Cruzer Micro	512MB

APPENDIX #6

APPENDIX #6 – COMPATIBLE HDD BRAND

NOTE: Please upgrade the Firmware of the DVR to latest version to ensure the accuracy of following table

Brand Name	Model	Capacity	Rotation
HITACHI	Deskstar HDS728080PLAT20	80GB	7200 rpm
HITACHI	Deskstar 180 GXP	120GB	7200 rpm
HITACHI	Deskstar 7K250, HDS722516VLAT20	160GB	7200rpm
HITACHI	HDS722516VLAT80	160GB	7200rpm
HITACHI	HDS722516DLAT80	160GB	7200rpm
HITACHI	Deskstar 7K250, HDS722525VLAT80	250GB	7200rpm
HITACHI	Deskstar 511DHT0021	500GB	7200rpm
IBM	Deskstar 120GXP (80GB)	80GB	7200 rpm
IBM	Deskstar 120GXP (120GB)	120GB	7200 rpm
Maxtor	DiamondMax 536DX(60GB) 4W060H4	60GB	5400rpm
Maxtor	DiamondMax Plus 9	80GB	7200 rpm
Maxtor	DiamondMax Plus 9, Model#6Y120L	120GB	7200 rpm
Maxtor	DiamondMax Plus 9, Model#6Y160L0	160GB	7200rpm
Maxtor	DiamondMax 10 6L120PO	120GB	7200rpm
Maxtor	DiamondMax 10 6L160R0	160GB	7200rpm
Maxtor	DiamondMax 10 6L200R0	200GB	7200rpm
Maxtor	DiamondMax 10 6L200PO	200GB	7200rpm
Maxtor	MaxLine Plus , Model#7Y250P0	250GB	7200rpm
Maxtor	DiamondMax 10 6L250R0-3	250GB	7200rpm
Seagate	Barracuda ATA IV, ST380021A	80GB	7200rpm
Seagate	Barracuda ATA V, ST3120023A	120GB	7200 rpm
Seagate	Barracuda 7200.7 Plus, ST3160023A	160GB	7200 rpm
Seagate	Barracuda 7200.8 ST3200826A	200GB	7200 rpm
Seagate	Barracuda 7200.8 ST3250826A	250GB	7200 rpm
Seagate	Barracuda 7200.8 ST3300831A/P	300GB	7200 rpm
Seagate	Barracuda 7200.8 ST3400832A/P	400GB	7200 rpm
Western Digital	Caviar WD1200BB-00CAA1	120GB	7200rpm
Western Digital	Caviar SE WD1200JB	120GB	7200rpm
Western Digital	Caviar SE WD1600JB	160GB	7200rpm
Western Digital	Caviar WD2000BB-00DWA0	200GB	7200rpm
Western Digital	CaviarSE WD2500JB	250GB	7200rpm



Free Manuals Download Website

<http://myh66.com>

<http://usermanuals.us>

<http://www.somanuals.com>

<http://www.4manuals.cc>

<http://www.manual-lib.com>

<http://www.404manual.com>

<http://www.luxmanual.com>

<http://aubethermostatmanual.com>

Golf course search by state

<http://golfingnear.com>

Email search by domain

<http://emailbydomain.com>

Auto manuals search

<http://auto.somanuals.com>

TV manuals search

<http://tv.somanuals.com>