

Operating Instructions

For Muratec's F-160 plain-paper fax machines

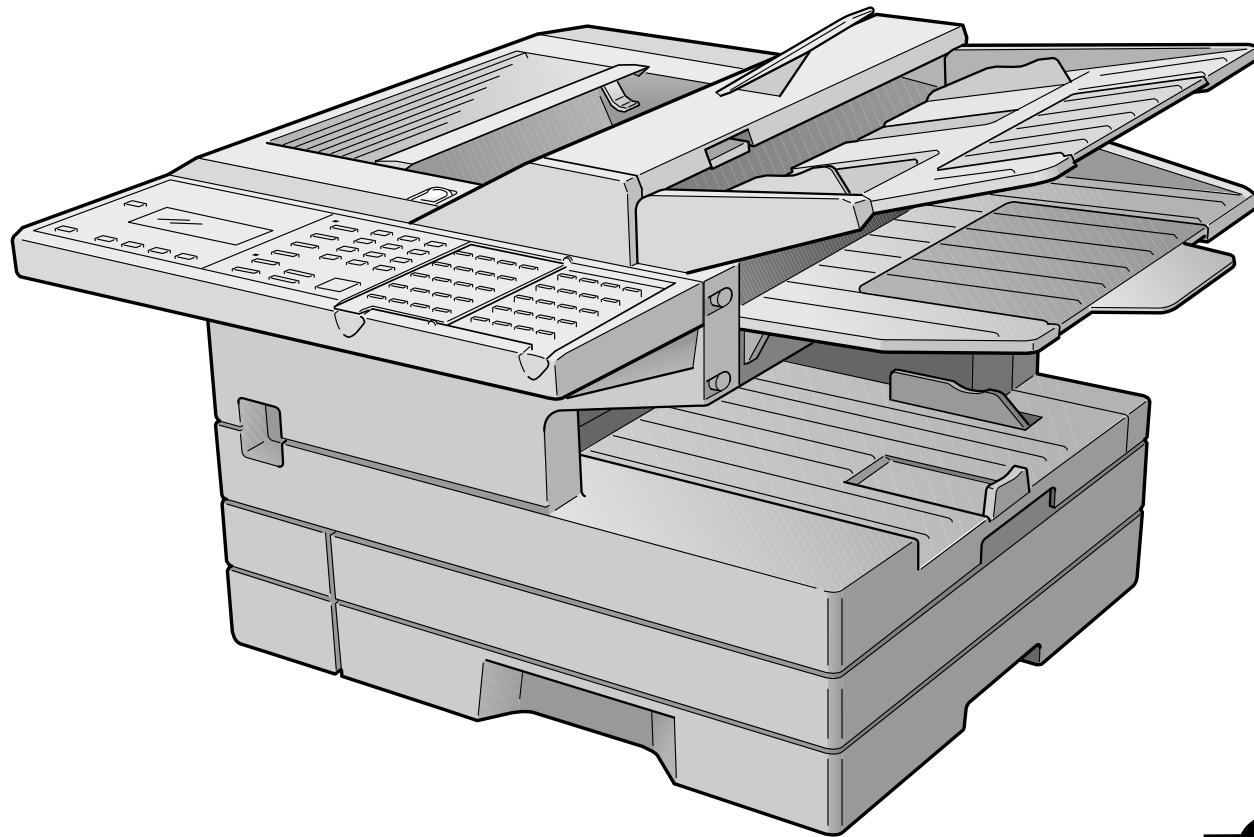

muratec
the fax specialists

Welcome ...

CE Statement

The Muratec F-160 carries the CE mark in accordance with EEC directive 89/336/EEC. This indicates that the machine complies to EN55022 1998 (Class B), EN55024 1998, EN61000-3-2 1995 +A1 +A2, and EN61000-3-3 1995.

In addition the machine has been safety tested to IEC60950 1991 +A1 +A2 +A3 +A4 based on 73/23/EEC.

The F-160 is a Class 1 laser product conforming to IEC60825-1 1993 +A1.

The machine is suitable and has been tested to be compatible to PSTN networks complying with CTR21. This equipment requires a line with analog signaling characteristics.

For further information please contact your supplier.



As an ENERGY STAR® partner, Muratec has determined that this product meets the ENERGY STAR guidelines for energy efficiency.

Trademarks

Muratec, the Muratec logo and all Muratec fax product names contained herein are trademarks of Murata machinery, Ltd and Muratec UK, Ltd.

ENERGY STAR is a registered mark of the United States Environmental Protection Agency.

Copyright

Copyright © 2000 by Murata/Muratec; All rights reserved.

Welcome to your Muratec fax machine!

These instructions are divided into three sections.

- **“Getting started”** (page 1.1) covers only what you *have* to know to use your machine immediately.
- **“Beyond the basics”** (page 2.1) provides more details. When you have time, look through it to learn more about your machine’s many features.
- Finally, **“Just in case ...”** (page 3.1) helps you if you ever have a problem with your machine. It also tells you how to give your machine the kind of easy, sensible care that should keep troubles to a minimum.

Thanks for choosing Muratec.

Find your serial number and write it down

Please note that your machine’s *serial number* is located on the *bar code label* as shown on the drawing at right. Use the blank at the bottom of this column to copy this down *before* you set up your machine.

Note: The *ID label*, required by government regulations, *do not* contain serial number information.

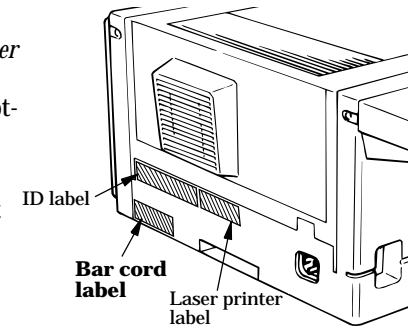

Close up, the bar code label looks something like this, but with a different set of numbers:



Please copy down your machine’s serial number below for future reference, and note the machine’s model number:

My machine’s serial number: _____

My machine’s model number: F-160

Table of Contents

Getting started

A quick introduction to fax	1.1
Packaging contents	1.2
Parts list	1.2
The keys and their functions	1.4
Operating tips	1.5
Setting up	1.6
Pick an installation spot	1.6
Power tips	1.6
Installing the printing supplies	1.6
Installing a new drum cartridge	1.7
Loading paper	1.7
Attaching the parts	1.8
Plug in and power up	1.8
Setting the paper size for the multipurpose tray	1.8
Adjusting the monitor speaker's volume	1.8
Attaching your telephone or answering machine	1.9
Attaching an optional handset	1.9
EasyStart	1.10
Getting started	1.10
Clearing stored settings	1.10
Entering initial settings	1.10
Sending faxes	1.12
Guidelines	1.12
Adjusting the machine for larger documents	1.13
Using memory transmission	1.13
Inserting a document	1.14
Sending a fax	1.14
Sending a fax using monitor/call or a handset	1.15
Redialling	1.15
Review Commands, an introduction	1.16
Receiving faxes	1.17
Answering calls manually	1.17
Reception modes	1.17
Tel Ready mode	1.17
Fax Ready mode	1.18
Fax/Tel Ready mode	1.18
Tel/Fax Ready mode	1.19
Ans/Fax Ready mode	1.19

If the paper runs out	1.20
Making copies	1.21
Using your fax machine as a phone	1.22
Redial	1.22
Dialling with the monitor speaker	1.22
EasyDial directory dialling	1.22
Checking the fax reception mode	1.22
Dialling in the event of a power failure	1.22

Beyond the basics

Entering settings for your fax machine	2.1
Scan settings	2.1
Using code to enter characters	2.2
Print settings	2.2
Copy settings	2.3
Setting the number of rings	2.4
Setting ECM	2.4
Setting silent mode	2.5
Setting the transmission confirmation stamp	2.6
Language settings	2.6
Printing your settings	2.6
Autodialler	2.7
Autodialler basics	2.7
Call groups	2.8
Using one-touch numbers	2.8
Using speed-dial numbers	2.11
Printing a call group directory	2.14
EasyDial directory dialling	2.15
Broadcasting	2.16
Broadcasting basics	2.16
Delayed broadcasting	2.16
Making changes to broadcasts	2.16
Delayed transmission	2.17
Setting up a delayed transmission	2.17
Reviewing or canceling delayed commands	2.18
Printing a delayed command list	2.19
Printing a stored document	2.19
Batch transmission	2.20
Creating or modifying a batch box	2.20

Printing a list of batch boxes	2.21
Storing a document for batch transmission	2.21
Printing a list of stored batch documents	2.22
Printing a document stored in a batch box	2.22
Erasing a document stored in a batch box	2.22
Erasing an empty batch box	2.23
Special features	2.24
Soft Keys	2.24
Copy & Fax	2.25
Cover page	2.26
Setting the activity journal	2.27
Setting the reports: TCRs and RCRS	2.28
Quick Memory transmission	2.29
Polling	2.29
Call request	2.31
Numbering pages	2.32
The power of Multi access	2.32
Audible alarm	2.33
Using alternative telephone network service providers	2.33
F-Code communication	2.35
F-Code: an introduction	2.35
Creating or modifying an F-Code box	2.35
Printing a list of F-Code boxes	2.39
Printing a list of documents stored in your F-Code boxes	2.39
Using a bulletin box	2.39
Using a security box	2.41
Using a relay box	2.42
Erasing an empty F-Code box	2.42
F-Code transmission and polling	2.43
Programmable one-touch keys	2.45
Using the power of programmable one-touch keys	2.45
Programming a delayed transmission	2.45
Programming a broadcast/group	2.47
Programming regular polling	2.49
Programming a batch transmission	2.50
Programming an F-Code transmission	2.52
Programming F-Code polling	2.54
Programming printouts	2.55
Programming a document storage operation	2.56
Fax dialling with programmable one-touch	2.57
Printing lists using programmable one-touch	2.57
Storing fax documents with programmable one-touch	2.58
Erasing a programmable one-touch key	2.58
Printing a list of your programmable one-touch keys	2.58

Security features	2.59
The passcode	2.59
Operation protection	2.59
Security reception	2.60
Masking the PIN	2.61
Setting security transmission	2.63
Setting for use with a closed network	2.64
Setting Block Junk Fax	2.64
Using department codes	2.66

Just in case ...

Clearing paper jams	3.1
Original document jams	3.1
Printout jams	3.1
Print quality problems	3.3
Troubleshooting	3.5
Alarm	3.5
LCD error messages	3.5
Errors	3.7
Caring for your fax machine	3.10
Cleaning tips	3.10
Keep the air vents clean	3.10
Corrective cleaning	3.11
Common questions	3.12
General questions	3.12
Sending faxes	3.12
Reports	3.13
Receiving faxes	3.13
Working with your answering machine	3.14
Polling	3.14
How your fax machine works	3.14
Glossary	3.15

Appendix and index

Specifications	AI.1
Index	AI.2
Safety information	AI.5
Laser safety	AI.5
Internal laser radiation information	AI.5
Warning labels	AI.5

Getting started

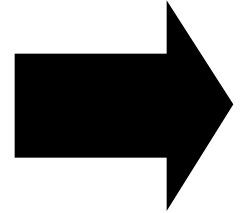

*A quick trip
through the basics
of your fax machine*

A quick introduction to fax	1.1
Packaging contents	1.2
Parts list	1.2
The keys and their functions	1.4
Setting up	1.6
EasyStart	1.10
Sending faxes	1.12
Receiving faxes	1.17
Making copies	1.21
Using your fax machine as a phone	1.22

A quick introduction to fax

What's a fax document?

A *fax document* is anything a fax user wants to fax to someone else. It can be one or more pages, and it can be text, a drawing or even a copy of a photograph.

What's a fax number?

Because your fax operates on standard phone lines, a *fax number* is just a regular phone number. And because your fax is also a high-quality, full-featured telephone, your fax number can be your regular phone number.

What are resolution and greyscale?

Just as cars are measured by engine size, fax machines are measured by *resolution* and *greyscale*.

Resolution refers to the sharpness of a fax transmission. There are three levels of resolution:

- *Normal* (8 dots/mm horizontal × 3.85 lines/mm vertical)
- *Fine* (8 dots/mm × 7.7 lines/mm)
- *Superfine* (16 dots/mm × 15.4 lines/mm).

Greyscale levels, or shades of grey –refers to the many shades of grey your fax machine sees on a document it's sending. It's likely most of your fax documents will be dark text on white paper. However, when you want to send photographs and other shaded items, you can set your fax machine to transmit in 256-level greyscale.

Why not *always* set your fax machine for superfine, or for greyscale?

Setting your fax machine for superfine resolution and greyscale mode makes your machine send more information, making transmissions last longer and driving up your phone bills on long-distance calls. You'll find that we've made it easy for you to set your fax machine for the most efficient and truest transmission for the types of documents you send.

Packaging contents

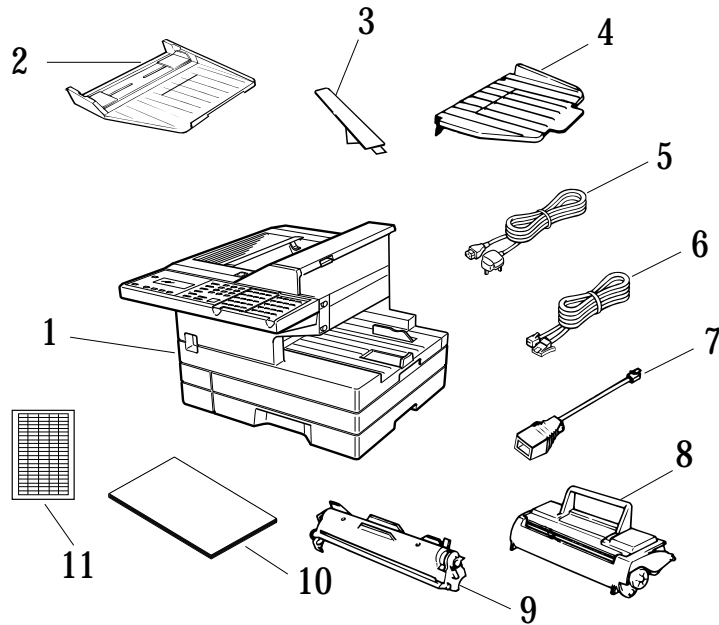

Included in your fax machine's packaging:

- | | |
|------------------------------|-----------------------------------|
| 1 Fax machine | 7 Line cable adapter |
| 2 Document hopper | 8 Toner cartridge |
| 3 Paper hopper | 9 Drum cartridge |
| 4 Document tray | 10 (This operating manual) |
| 5 AC power cord | 11 One-touch labels |
| 6 Telephone line cord | |

It's a good idea to save the packaging in case there's a need for reshipment.

Parts list

Note: Any terms used here that are unclear to you right now will be explained in detail in the coming pages.

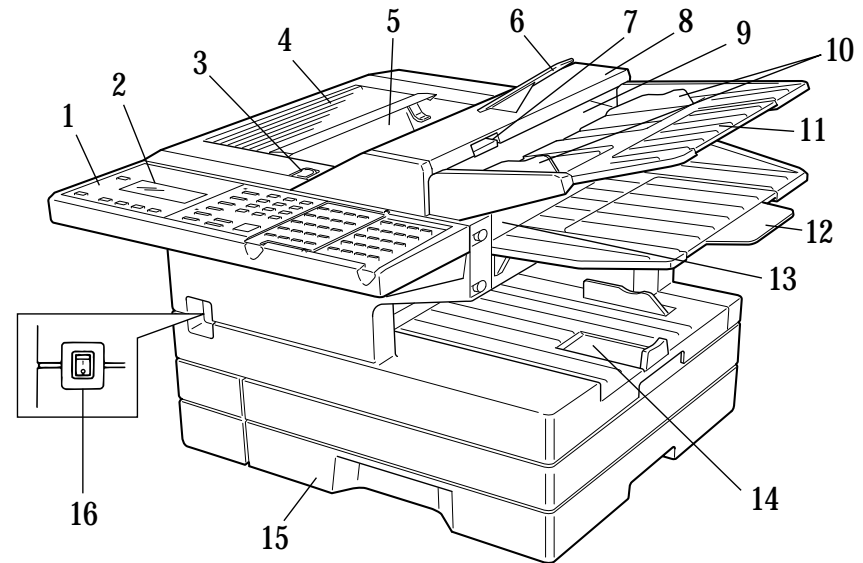

- 1 Control panel** –The keys you use to operate your machine. (See page 1.4 for more details.)
- 2 Liquid crystal display (LCD)** –Shows the machine's status and lets you see what you're programming into the machine. The display shows 2 lines, 20 characters per line. (If the LCD is blank, the machine is off.)
- 3 Printer cover release** –Push this to open the *printer cover*.
- 4 Printer cover** –Open to change the toner and drum cartridges or to fix printout jams.
- 5 Printed document exit** –Where the *printout* emerges.
- 6 Paper hopper** –Holds up the printout after it emerges.
- 7 Scanner cover release** –Pull up on this to open the *scanner cover*.

- 8 Scanner cover** – Open this by using the scanner cover release to remove *original document* paper jams.
- 9 Document feeder** – Place your original document here for faxing or copying. It holds up to 50 sheets.
- 10 Document guides** – Adjust these to fit the width of the original document so it will feed properly into the machine.
- 11 Document hopper** – This supports original documents for feeding into the machine.
- 12 Document tray** – Holds original documents after they've been scanned into the machine for faxing/copying.
- 13 Original document exit** – Where the original document emerges once it's been scanned for faxing/copying.
- 14 Multipurpose tray** – One of two locations where you put the recording paper. Holds up to 150 A4-sized sheets..
- 15 Paper cassette** – One of two locations where you put the recording paper. Holds up to 500 A4-sized sheets.
- 16 AC power switch** – Turns your fax machine on and off.

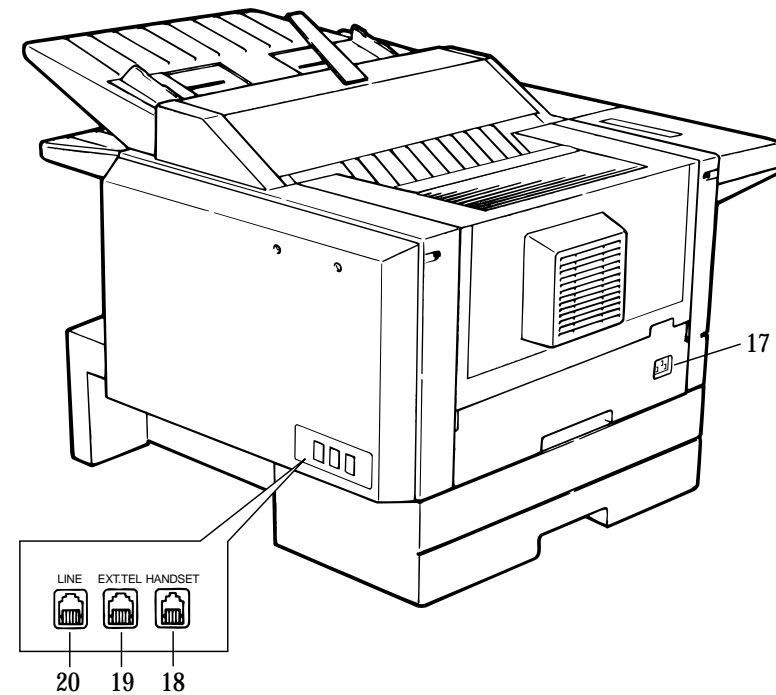

- 17 AC power jack** – Where you plug in the AC power cord.
- 18 HANDSET jack** – Where you plug in the optional handset.
- 19 EXT. TEL jack** – If you connect a second telephone to your machine, this is where you plug in the cord.
- 20 LINE jack** – Where you plug in the *telephone line cord*. (The other end of the cord plugs into a wall telephone jack.)

The keys and their functions

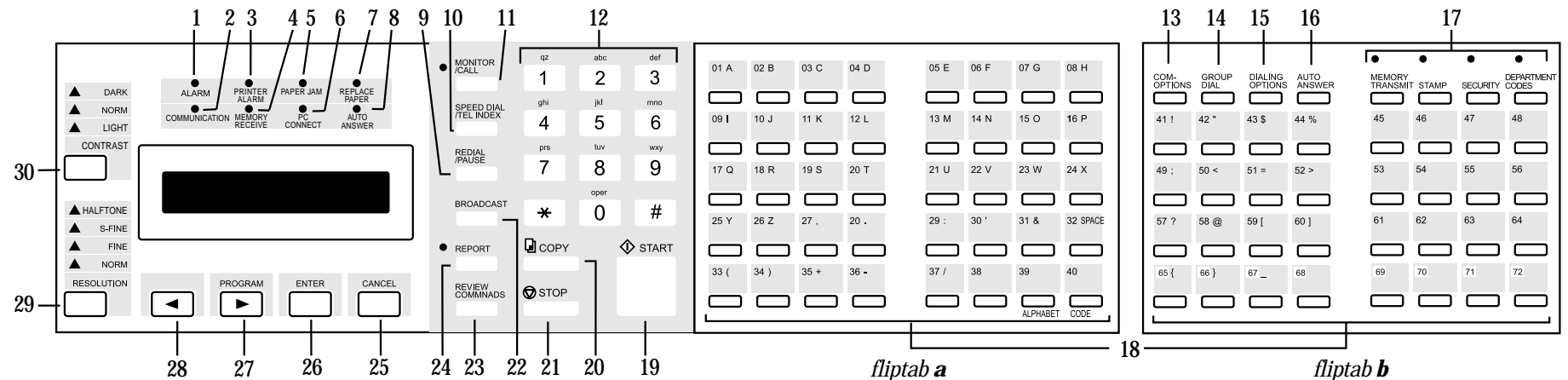

Important: Some of the functions mentioned here are covered in the “Beyond the basics” section.

- 1 ALARM light** – Glows when a problem occurs during fax communication, printing or scanning. The light stays on until the machine prints a *Check Message* report.
- 2 COMMUNICATION light** – Glows when the fax machine is communicating with another machine.
- 3 PRINTER ALARM light** – Glows when your machine encounters a problem printing a fax or copy. Check the display or an error report for more information.
- 4 MEMORY RECEIVE light** – Glows when the machine is receiving an incoming fax document into its electronic *memory*.
- 5 PAPER JAM light** – Glows when a printout jams in your fax machine.
- 6 PC CONNECT light** – Glows when your fax machine is ready to communicate using the optional RS-232C interface.
- 7 REPLACE PAPER light** – Glows when either the multipurpose paper tray or paper cassette is empty. See page 1.7 for details on replacing paper.
- 8 AUTO ANSWER light** – Glows when auto-answer mode is active. In this mode, the machine answers automatically as a fax machine.
- 9 REDIAL/PAUSE** – Redials the last number you dialed. In certain operations, it also produces a special *pause* character which can be useful when dialling long-distance numbers.

- 10 SPEED DIAL/TEL INDEX** – Starts a *speed-dialling* operation, which you finish by pushing three of the keys on the *numeric keypad*. Also displays *one-touch* and speed-dial entries sorted alphanumerically, as in a telephone directory.
- 11 MONITOR/CALL** – Turns the *monitor speaker* off or on. When it's on, it allows you to hear the call you're making. When using this feature, you can only hear the communication taking place. You cannot be heard unless you use a handset (optional). When sending a fax, this key also activates the *call request* feature.
- 12 Numeric keypad** – Just like the numeric keys on a regular tone-dialling phone. Use these to dial phone and fax numbers and to enter numbers when you're setting up the machine.
- 13 COM-OPTIONS** – Press this to choose from among six fax options: *delayed transmission, polling, batch transmission, continuous polling, F-code transmission* or *F-code polling*.
- 14 GROUP DIAL** – Press this to set up a fax transmission to a *call group*, a set of fax numbers which will receive the same document in one fax operation.
- 15 DIALING OPTIONS** – Produces a special character when dialling, and also inserts special symbols into telephone numbers (see page 2.7).
- 16 AUTO ANSWER** – Press this to select which *mode* your fax machine uses to handle incoming calls. Choose between *auto-answer* mode (your machine answers automatically as a fax machine) or *manual-answer* mode (the machine waits for the user to pick up an optional, connected handset).

- 17 Soft keys** – Shortcut keys. Any function that can be turned on or off can be programmed into these four keys. If the light above one of these keys glows, this indicates the setting that's been programmed into it (see page 2.24) is turned on.
- 18 One-touch keys** – Serve three functions: **(1)** the keys labelled **01–64** can be used for one-touch dialling, **(2)** the keys labelled **65–72** are for *programmable functions*: this lets you teach your machine a multi-step function just once, then recall the function at any time by pressing one of these keys, and **(3)** all these keys can be used to type letters and symbols for user settings.
- 19 START** – Press to begin a fax transmission or reception.
- 20 COPY** – Press to make one or more copies of a document.
- 21 STOP** – An all-purpose “Whoa!” key. Stops the current operation and ejects a document from the document feeder.
- 22 BROADCAST** – Press to send a broadcast fax (sending the same document to more than one location).
- 23 REVIEW COMMANDS** – Press to review pending fax commands or to view a brief description of delayed commands.
- 24 REPORT** – Press to turn the confirmation report feature on or off for the next fax transmission. If the **REPORT light** next to this key is glowing, your machine will print the confirmation report for the next fax transmission. If not, your machine will not print a confirmation report.
- 25 CANCEL** – Press to delete characters on the LCD and cancel commands you have entered into the machine.
- 26 ENTER** – Much as **STOP** is a “Whoa!” key, **ENTER** is a “Go!” key. It confirms user settings, begins operations and moves through command levels.
- 27 ▶/PROGRAM** – Any function can be started by first pressing this key and then entering the function number. Also, scrolls (moves) through features and command options as displayed on the LCD.
- 28 ◀** – Push to scroll through features and commands displayed on the LCD.
- 29 RESOLUTION** – When a document is in the document feeder, press this key to toggle among the three resolution modes and the *halftone (greyscale)* mode.
- 30 CONTRAST** – When a document is in the document feeder, press this key to toggle among normal, dark or light *contrast* settings.

Operating tips

To press: **0** (zero), **1**, **2**, **3**, **4**, **5**, **6**, **7**, **8**, **9**, **#** or *****

Use: The numeric keypad.

Tip: *At no other time within this manual will we refer to the letters printed below the numeric keys and their uses (such as accessing abc by pressing the 2 key.) These letters are there only for your convenience in using your fax machine as a telephone.*

To press: **A**, **B**, **C**, **D** or any other letter key

Use: The one-touch key labelled with that letter.

Tip: *Please don't confuse the zero (0) with the letter o.*

Here's an example. If we say “press ▶/PROGRAM, 7, ENTER, 0, 8, ENTER” ...

```

... you'd press ▶/PROGRAM
... then 7
... then ENTER
... then 0 (the numeric key zero)
... then 8
... and then ENTER

```

Important: Even though our example above includes commas, do not enter them into the fax machine. Those characters appear in our instructions to separate one number from the other. They do *not* need to be entered into your fax machine.

There is a function (broadcasting) which requires commas to be entered, but there is a special way to enter them. We'll explain this process later.

Setting up

Pick an installation spot

Where should you install your fax machine? The location should be:

- **Clean** – Dust build-up can damage your machine. (However, do *not* use a cover!)
- **In the open** – Allow at least 30 cm of clearance around your machine. Be sure that you *never cover* the machine. Its vents must be able to “breathe.”
- **Away from direct sunlight** – This helps avoid overheating.
- **Dry** – Avoid any location where splatters or sprays (such as from a water fountain) could reach your fax machine.
- **Level, and vibration-free.**
- **Near a phone jack** – Your fax machine uses a standard (modular) telephone jack, also known as an LJU.
- **Near an AC power outlet** – The AC power cord is about 1.5 metres long when stretched to its limit, and the power cord should *never* be stretched to its limit.

Power tips

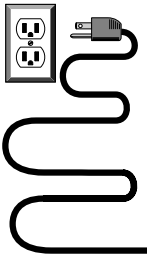

- Use a standard **three-pronged 230 VAC outlet**.
- **Make sure the outlet *isn't* controlled by a wall switch.** If it is, you'll risk occasional shutoffs to the machine, causing you to lose fax messages.
- **Don't use an outlet which also is supplying power to a large appliance**, such as a refrigerator or air conditioner. Such high-consumption appliances can cause “draw-downs” (temporary drops in the power available for other equipment on the circuit) which could damage your fax machine.
- Use an **electrical surge suppresser**, preferably one which guards *both* telephone *and* electrical lines. This device helps to shield your fax machine from damaging high-voltage electrical surges.

Voltage requirements: 230 VAC ± 10%, 50- 60% Hz.

Power consumption:

	Standby	Transmission	Reception	Copying	Maximum*
	17w	40w	495w	495w	677w

* ; simultaneous copying, communicating and scanning

Installing the printing supplies

Your fax machine prints incoming faxes and copies with a *laser print engine*. The engine requires two types of *printing supplies* (sometimes also called *consumables*):

- The *drum cartridge* – It yields 20,000 normal A4-sized printouts (see “Specifications,” page AI.1). By “normal,” we’re referring to the amount of text and/or graphics on each page. This is based on an industry-standard test document.
- The *toner cartridge* – It yields 5,500 “normal”, A4-sized printouts (see “Specifications,” page AI.1).
Note: The toner cartridge included with your machine is a *starter* cartridge which yields 3,600 printouts (see “Specifications,” page AI.1). Please purchase regular, full-yield toner cartridges from your authorised Muratec dealer.

To install these supplies:

- 1 Press the *printer cover release* and swing open the printer cover.

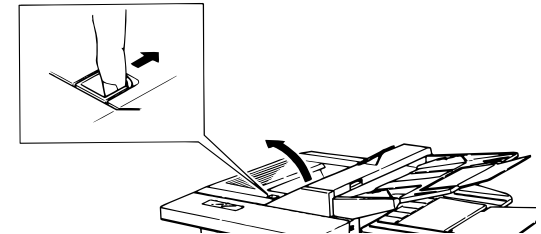

- 2 Unpack the drum cartridge from its box.

Important: Shield the drum cartridge from light, especially strong light. Later, if you have to remove the cartridge from the fax, immediately wrap it in a thick cloth to protect it from light.

- 3 Put the drum cartridge into the *printer* by aligning the cartridge's *protrusions* with the *slits* inside the *printer frame*.

Important: You must also reset the drum counter. See “Installing a new drum cartridge” (page 1.7).

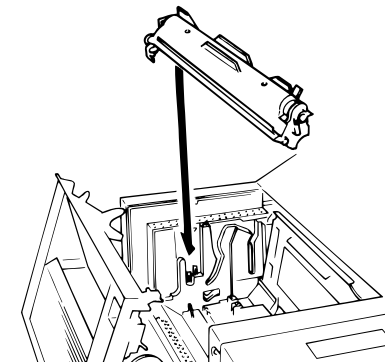

- 4** Unpack the toner cartridge from its carton. Hold the toner cartridge with both hands, and shake it well as shown.

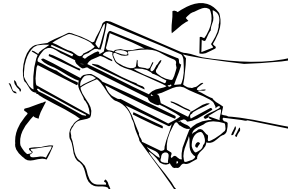

- 5** Install the toner cartridge in the printer, making sure that the cartridge's four pins (two at the front and two at the rear) fit in the slits inside the printer frame. The toner cartridge will click into place when inserted correctly.

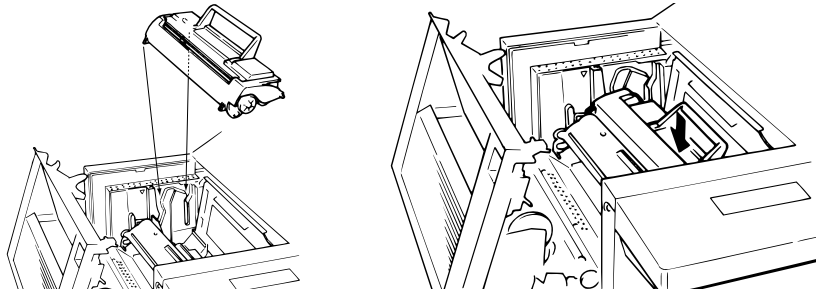

- 6** Close the printer cover. Push down on the cover to lock it into position.

Note: The fax machine will not work if the cover isn't closed properly.

Note: If you encounter problems with printouts, see "Print Quality Problems" on page 3.3 for suggestions to correct them.

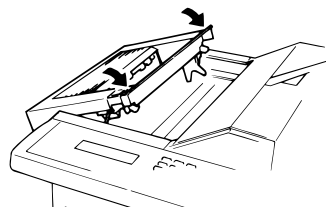

Installing a new drum cartridge

Your fax machine keeps track of how many pages go through the drum cartridge in order to let you know when the drum needs to be replaced. So whenever you install a new drum cartridge, you have to "notify" the machine by *resetting the drum counter*. (Before resetting it the very first time, you'll have to finish installing the machine and then turn it on [see page 1.8].) To reset the drum counter:

- 1** Press **▶/PROGRAM, J, 2, 4**. The LCD shows:

```
J24 Reset Drum Life
  Program/Enter
```

- 2** Press **ENTER, ENTER** to reset the drum counter.

Loading paper

Your machine holds up to 650 sheets at a time: 500 sheets in the *paper cassette* and 150 sheets in the *multipurpose tray*.

Loading the paper cassette

- 1** Pull forward on the *paper cassette* to slide it out.

- 2** Insert up to 500 *A4-sized* sheets into the cassette, placing the edges of the top sheet under the metal *tabs* on the left side of the cassette (viewed from the cassette's front, as shown).

Important: Load the cassette with *A4-sized paper only*.

- 3** Push the paper cassette closed. You'll feel a click when it's properly in place.

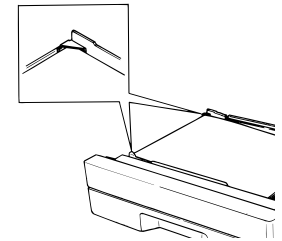

Loading the multipurpose tray

You may use *A4-sized* paper in the multipurpose tray.

- 1** Adjust the *multipurpose tray* for the length of paper you plan to load. Pull slightly upward on the *paper-length guide* in the tray, then slide the guide to the slot for the paper size you're loading.

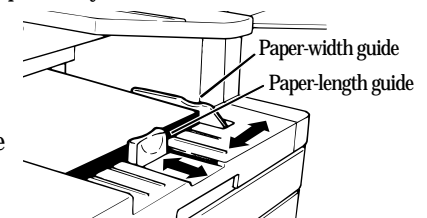

Important: You must set your machine to recognise the size of paper you've loaded (see "Setting the paper size" on page 1.8 for details).

- 2** Slightly "fan" the paper you're loading, to help ensure smooth feeding.

- 3** Insert up to 150 sheets of paper into the tray. Make sure the paper-length guide and the *paper-width guide* now fit against the paper's edges.

Important: To avoid paper jams, do not refill this tray without first removing *all* of the paper in it.

Attaching the parts

- 1 Attach the *document tray* by inserting it into the appropriate holes, as shown.

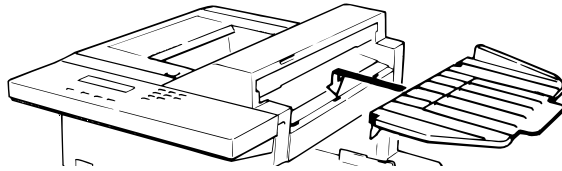

- 2 Attach the *paper hopper* into the appropriate hole, as shown. Press *gently* until the hopper won't go in any farther.

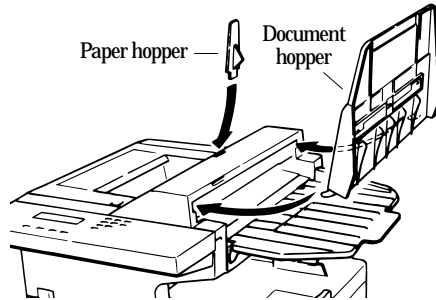

- 3 Attach the *document hopper* by inserting its two *pegs* at a slightly upward angle into the appropriate holes, as shown.

Plug in and power up

- 1 Plug one end of the telephone line cord into the **LINE** jack on the back of the machine. Plug the other end of the cord into a standard telephone wall jack, just as you would plug in a phone.

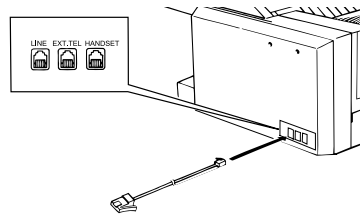

Note: If you purchased an optional handset, don't confuse its *curled* handset cord with the *uncurled* telephone line cord.

- 2 Plug the *non-pronged* end of the *AC power cord* into the *AC power cord jack* on the left side of the machine.

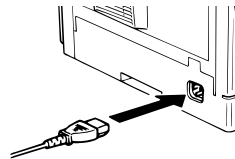

- 3 Plug the *pronged* end of the AC power cord into a 230 VAC electrical outlet (use a surge suppresser, as mentioned on page 1.6).

- 4 Use the *AC power switch* on the front of the machine to turn it on. The markings are international standards: **I** means *on*, **O** means *off*.

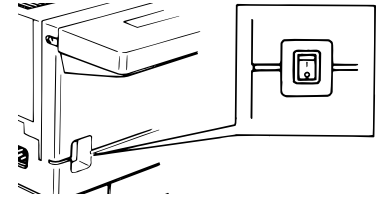

Setting the paper size for the multipurpose tray

The multipurpose tray can hold A4-sized paper for your machine. All you have to do is tell the machine that you are using A4-sized paper.

Important: If you use a different size from the size you set here, the machine won't print. Be sure to change this setting whenever you load a different paper size.

Note: If you have the option module WP-300, you can use other papers than A4-sized paper. (Refer to optional WP-300 operating instructions for the procedure of setting the paper size.)

- 1 Press **▶/PROGRAM, J, 0, 4, ENTER**. The LCD shows the tray's current setting:

```
Paper Size: A4
Program/Enter
```

- 2 Press **ENTER** to save the setting.

Adjusting the monitor speaker's volume

To adjust the volume of the monitor speaker:

- 1 Press **MONITOR/CALL** on the control panel. You should hear a dial tone, and the display shows:

```
** Tel Mode **
```

Important: If you don't hear a dial tone, make sure your fax machine is plugged into a working phone line.

- 2** Adjust the volume as needed:
To turn the volume up, press ►/PROGRAM. To turn the volume down, press ◀.
The display, or LCD, indicates the volume. The possible settings are:

** Tel Mode ** Volume: ■■■■■■	= Loudest setting.
** Tel Mode ** Volume: ■■■■	= Medium setting.
** Tel Mode ** Volume: ■■	= Low setting.
** Tel Mode ** Volume:	= Volume off.

- 3** Press MONITOR/CALL again to hang up and save the setting that appears.

Attaching your telephone or answering machine

It's easy to attach a telephone or answering machine to your fax machine.

If you do this, only your fax machine connects to the phone outlet in the wall. The other device receives phone signals *through* your fax machine.

To attach a telephone or answering machine:

- 1** If your telephone or answering machine is already plugged into a phone jack in the wall, disconnect it from that jack. *Hold onto the phone plug; you'll need it in step 3.*
- 2** Plug the line cable adapter into the EXT.TEL jack on the back of your fax machine.
- 3** Using the plug mentioned in step 1, plug the phone cable from your telephone or answering machine into the line cable adapter.
- 4** If you attach an answering machine to your fax machine, set the answering machine to answer calls after no more than two rings. (If necessary, consult your answering machine's instructions.)

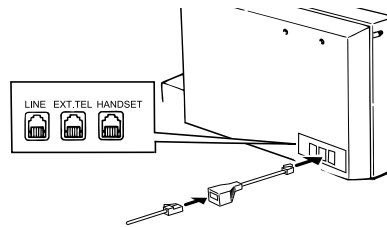

For information on how to use either an answering machine or a telephone with your fax machine, see "Receiving faxes," beginning on page 1.17.

Attaching an optional handset

To attach the optional handset:

- 1** Use the screws included with the handset and a small Phillips-head screwdriver to attach the *handset cradle* to the side of your fax machine.
- 2** Plug one end of the curled *handset cord* into the **HANDSET** jack on the back of the fax machine.
- 3** Plug the other end of the curled handset cord into the jack on the handset. If connected to a phone line, your fax machine is now "off-hook," and you can hear a dial tone.
- 4** Place the telephone handset onto its cradle. The cradle will press the handset's small "flash" button, hanging it up.



Note: You can also press the "flash" button manually to hang up the call when holding the handset.

Important: Do *not* connect the handset directly to a telephone wall jack. Connect the handset only to your fax machine.

Adjusting fax's handset

A small switch on the side of your fax machine's telephone handset controls the dialling signals produced by the handset keypad, and adjusts the ringer volume.

Note: Changing the setting of this switch is only effective after replacing the telephone onto its cradle.

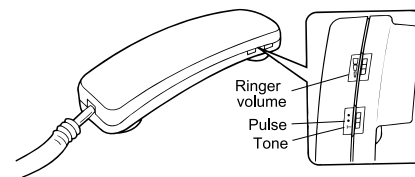

Tone/Rotary Setting – Controls the dialling signals made by the handset's keypad: It does not change the dialling signals produced by the fax machine's autodialler or numeric keypad.

Ringer Volume Control – Adjust the ringer volume to one of three settings: High, Medium, or Low.

Installation complete!

Now, see how our EasyStart feature will have you up and running within minutes.

EasyStart

EasyStart software is already installed on your Muratec fax machine. It guides you through the process of entering your machine's settings. Remember that the settings you make here can always be changed later. We'll explain more in "Beyond the basics," beginning on page 2.1.

Getting started

Determine the following before you go any further:

- 1 The type of dialling** your telephone system requires – Choose either *tone* or *pulse* (rotary) dialling.
- 2 The name and fax number you want to appear on your faxes** – Every fax page you send arrives at the receiving machine with a single line of text at the very top of the page. This text lists a *name* and a *fax number*, which are called a *Transmit Terminal Identifier (TTI)*. The TTI cannot be longer than 22 characters.

Clearing stored settings

Before using EasyStart, clear your machine's built-in *user data memory*. This ensures the memory will hold only *your* settings.

Important: After you use EasyStart, *do not* clear the memory again unless an authorised technician asks you to do so.

To clear the machine's memory:

- 1** Press ►/PROGRAM, *, **2**. The LCD now asks if you want to clear the memory:

```
Clear User Settings
Check Program/Enter
```

Note: If you *don't* want to clear the memory, just press ►/PROGRAM.

- 2** If you *do* want to clear the memory, press ENTER.

Entering initial settings

Important: If you press STOP during EasyStart, your fax machine returns to *standby mode* (its normal condition). But it will keep the settings you saved by pressing ENTER as described in these instructions.

- 1** Press ►/PROGRAM, I, ENTER.
The LCD shows the current calendar/clock setting, with a *cursor* appearing under the first digit.

```
Enter Time
'01 01/01 00:00
```

- 2** Use the numeric keypad to enter the *correct date and time*, using a *YYMMDD* format for the *date* and *24-hour* ("military") format for the *time*. For instance, to set 8:30 PM on September 11, 2000, press **0009112030**, which results in:

```
Enter Time
'00 09/11 20:30
```

Note: Your fax machine automatically inserts the spaces and date-slash. All you have to do is enter the digits.

To change a digit, press ◀ to move the cursor left, or ►/PROGRAM to move it right. Then enter the correct digit.

- 3** Press ENTER to save the clock setting and continue EasyStart.
- 4** The LCD now asks you to enter your fax number as you want it to appear on other fax machines' displays or printouts. The fax industry term for this number is *Subscriber ID*.

```
Your Fax Number
_
```

- 5** Use the numeric keypad to enter the fax number. To insert a dash, as shown here, press DIALING OPTIONS once. The number may contain up to 20 characters (numbers and dashes).

```
Your Fax Number
972-555-5525
```

Note: If you make a mistake, press **CANCEL** to erase to the left. To change just one number, press **◀** to move left, or **▶/PROGRAM** to move right. Press **CANCEL** to erase the number. Then re-enter the fax number correctly.

6 Press **ENTER** to save the number.

7 The LCD now asks you to enter the name you want to appear at the top of faxes you send. The name may be up to 22 characters in length.

Use the one-touch keys to enter letters and other non-numeric characters.

Your Name ;Upper

—

The word “Upper” means the machine will enter only upper-case letters. If you press **R**, the machine will see it as an *R* (not an *r*).

To type a lower-case letter, press **ALPHABET**. The display changes to:

Your Name ;Lower

—

This means pressing one-touch keys will enter lower-case letters: pressing **R** will produce an *r* (not an *R*) on the display.

To switch back for upper-case entries, press **ALPHABET**.

To enter spaces, punctuation and symbols, use the one-touch keys.

In “Beyond the Basics,” we’ll show you how to use the **CODE** function to enter even more characters (see page 2.2).

Note: If you make a mistake, press **CANCEL** to erase to the left. To change just one character in the name, press **◀** to move left, or **▶/PROGRAM**, to move right. Press **CANCEL** to erase the character. Then re-enter the character correctly.

8 Press **ENTER** to save the setting and continue.

9 The LCD now indicates the type of dialing.

Phone Type: Tone
Program/Enter

10 Press **ENTER** and continue.

11 The LCD now shows the machine’s current reception mode.

Fax Ready
Program/Enter

12 For now, press **◀** or **▶/PROGRAM** until the setting *Fax Ready* appears. (This setting can always be changed. We’ll discuss reception modes further on pages 1.17-1.19.)

13 Press **ENTER** to save the setting.

14 The LCD now asks if you want to print a list of all of the machine’s settings.

Print Setting List
Enter/Stop

- If you want to print a list, make sure paper is loaded into your machine for printing, then press **ENTER**. Your fax machine will print a list of its settings.
- If you don’t want to print a list, press **STOP**. Your machine will return to standby mode.

EasyStart is complete!

Sending faxes

Guidelines

Page sizes

While you'll probably send normal-sized documents most of the time, it's possible to fax a piece of paper as small as a notepad sheet or one nearly 1 meter long.

The acceptable dimensions (width × length) are:

SINGLE-SHEET TRANSMISSION		MULTIPLE-SHEET TRANSMISSION	
<i>Maximum:</i>	280 mm × 900 mm	<i>Maximum:</i>	257 mm × 364 mm
<i>Minimum:</i>	148 mm × 105 mm	<i>Minimum:</i>	148 mm × 105 mm

Things *not* to put in your fax

To avoid paper jams and damage to your machine, **don't insert:**

- Folded, curled, torn, wrinkled or very thin pages
- Documents with staples, glue, tape, paper clips or still-wet correction fluid
- "Sticky notes" (or documents with "sticky notes" attached)
- Cardboard, newspaper or fabric
- Pages with duplicating carbon on either side
- Credit cards or any small, thick items

Resolution, greyscale and contrast

Reviewing resolution and greyscale:

- *Normal resolution* ("NORM" on the control panel) is suitable for most typed documents and simple drawings.
- *Fine resolution* ("FINE" on the control panel) is ideal for maps, moderately complicated drawings, floorplans or hand-written documents.
- *Superfine resolution* ("S-FINE" on the control panel, "S Fine" on the LCD) reproduces the detail of extremely complicated drawings or line art.
- *Greyscale mode* ("HALFTONE" on the control panel; "Grey" on the LCD) captures shades in photos and drawings.

Note: If you send a fax in superfine, certain fax models (especially older, non-Muratec models) receive it only in fine mode. However, you can send a fax in greyscale mode to virtually *any* fax machine currently in use.

Reviewing contrast:

You have three choices for the *contrast* setting:

- *Normal* ("NORM" on the control panel) – Suited to most documents.
- *Light* – Lightens up overly dark, "muddy" original documents.
- *Dark* – Darkens weak, "washed-out" images.

Note: To avoid confusing the Light and Dark settings, just remember – "Light lightens" and "Dark darkens" – to keep it straight.

Entering a pause character when dialling

Some long-distance systems require dialling pauses, and pauses can also be useful when you're dialling through special telephone exchanges.

To insert a *pause* character, just press **REDIAL/PAUSE** *after* you've dialled at least one other character. -/ (the pause character) will appear on the display.

Each pause entered lasts for a factory-set two seconds (see "Changing the pause length," next page, for instructions to change this setting).

For example, if the pause is at the factory setting, pressing **9, REDIAL/PAUSE, 1972552009** dials 9 [2-second pause] 1 9 7 2 5 5 2 0 0 9.

Important: Each pause uses *two* of the characters you're allowed in a number.

Changing the pause length

The pause is set by the factory to last two seconds, but you can set it to last as long as ten seconds if necessary. To change the pause length:

- 1 Press ►/PROGRAM, J, 0, 5, ENTER.

```
Set Dialing Pause
Time (02-10): 02
```

- 2 Use the numeric keypad to enter the length you want for the dialling pause. Here, we've chosen nine seconds.

```
Set Dialing Pause
Time (02-10): 09
```

Note: The length setting requires two digits. Always enter a leading zero for lengths less than 10 seconds.

- 3 Press ENTER to save the setting.

Potential problems with call-waiting and voice mail

Telephone call-waiting signals can stop fax transmission and reception. And any service – such as voice mail – which may intercept your calls can keep your fax machine from receiving fax calls.

If you use only one line for both phone and fax, consult your telephone company to see how you can temporarily disable call-waiting or voice mail while using the fax machine.

Adjusting the machine for larger documents

You can adjust the document hopper and the document tray to allow for large documents. Just flip the top up or down as needed.

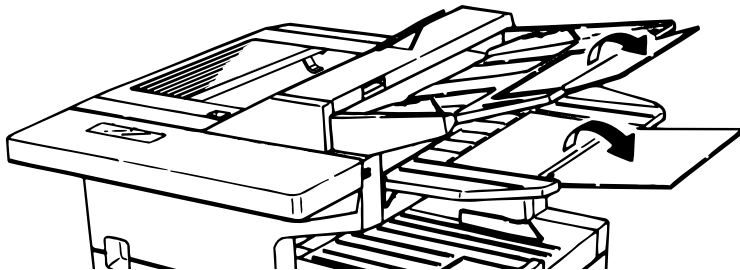

Using memory transmission

Your fax machine has a great memory! Take advantage of it, and you could:

Save Time. By using your fax machine's memory, you won't have to wait for your machine while it completes the transmission. Simply scan your document into your fax machine's memory, and you can walk away with your original in hand.

Save Money. If you're transmitting to another memory-equipped fax machine, your machine will send the document directly into the other machine's memory and hang up. (The receiving machine then prints out your message from *its* memory after the call has ended.) This cuts your actual on-line time to a minimum.

Save Even More Money. Set up a *delayed command* (see pages 2.17- 2.19) to send your document after hours, and you can save more money, because the line charges will be cheaper.

You can set your fax to transmit from memory as the *default*.

Note: Whether you decide to send your documents from memory or manually, you can override that choice one transmission at a time by pressing **MEMORY TRANSMIT** before you send your document. After completing the communication, your fax will return to the *default* setting.

Note: Some documents use up memory more quickly than others. They include documents with many pages and those with many dark areas. *When the machine's memory is full, it can transmit only through the document feeder.*

To make memory transmission the default:

- 1 Press ►/PROGRAM, J, 1, 4, ENTER.

```
Memory Tx:      On
Program/Enter
```

- 2 Press ◀ or ▶/PROGRAM until the mode you want appears. In this example, we've chosen *Off*.

```
Memory Tx:      Off
Program/Enter
```

- 3 Press ENTER to save the setting.

If the **MEMORY TRANSMIT** light glows, memory transmission is *on*.

If the **MEMORY TRANSMIT** light doesn't glow, memory transmission is *off*.

Inserting a document

1 Adjust the document guides – by sliding either of them to the left or right – to fit the page(s) you’re faxing. Your fax machine’s *automatic document feeder* will hold up to 50 pages.

2 If you’re sending a multi-page document, “fan” the pages slightly.

3 Insert the document **face up**. The fax machine “grabs” the first page of the document and positions it for faxing. (Readjust the document guides to fit the document, if needed.)

The LCD now shows the current scanning width setting (see “A4, B4, A3” in the Glossary that begins on page 3.15) and the amount of memory available:

Document Ready
A4 Memory100%

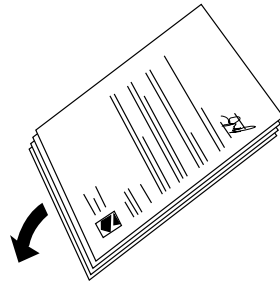

Sending a fax

To fax a document:

1 *Insert the document.*

When a document is in the feeder, the LCD shows the current scanning width and the amount of memory available:

Document Ready
A4 Memory100%

2 *Adjust resolution and contrast if necessary.*
Press **RESOLUTION** to change the resolution.
Press **CONTRAST** to change the contrast.

3 *Adjust memory transmission if necessary.*
Press **MEMORY TRANSMIT** to toggle memory transmission on and off.

4 *Enter the fax number.*
Also, enter any access codes necessary, just as you would for a regular phone call. (Example: Enter 9 to “dial out” from an office telephone system, or 1 for long-distance.)

Press Start
919725552009_

5 *Press START.*

By pressing **START**, you’ve just given your machine a command. In turn, your machine gives this action a *command number* as it scans the fax document.

This command number appears on the first line of the LCD for a few seconds:

== Command:01 ==

You’ll need this command number to cancel the transmission or to print a stored document (see pages 1.16).

- 6** Now, everything is up to the machines – yours and the one you’re dialling.
- If the fax has been set for *Quick Memory transmit*, your machine scans the first page of your document into memory, then dials the other fax. When it makes contact, your machine transmits the stored document from memory while at the same time scanning the remaining pages of your document into memory. (To set *Quick Memory transmission*, see pages 2.29.)
 - If the fax has been set for the *normal memory transmit*, your machine first scans the document into memory, then dials the other fax. When it makes contact, your machine transmits the entire stored document from memory.
 - If the fax is set for *non-memory transmission*, your machine simply dials the other fax. When it makes contact, your machine feeds the document through, scanning and transmitting it as it goes.

Note: The more “stuff” (called *black coverage*) your machine “sees” on a page, the more slowly the page feeds through as the fax scans it. And even if the page is relatively clean, sending it in greyscale mode or at certain resolutions makes your machine “see” more “stuff.”
The same is true if you set the contrast to Dark.

Important: If you want to *cancel* a transmission while *scanning* the document, press the **STOP** key.
If you want to *cancel* a transmission in progress, use the *Review Commands* function. See “Review Commands, an introduction” page 1.16.

- 7** At the end of the operation, your fax machine beeps and displays:

```
972-555-2009
** Complete **
```

Important: Whenever you transmit a document, what actually appears on the top line of the display depends on information stored in the remote fax. The line may even be blank.

Note: If the call fails, see “Redialling,” next column.

Sending a fax using monitor/call or a handset

You also can fax a document using either the monitor speaker or the optional handset to dial the call.

Note: Faxing this way disables “V.34” mode and sends the fax in normal ITU-T Group 3 fashion. See page 3.18 for more information.

- 1** *Insert the document.*
- 2** *Adjust resolution and contrast if necessary.*
Press **RESOLUTION** to change the resolution.
Press **CONTRAST** to change the contrast.
- 3** *Obtain a dial tone, either by:*
 - Pressing **MONITOR/CALL**

...or ...

 - Lifting the optional handset.

In either case, the LCD shows:

```
** Tel Mode **
_
```

- 4** *Enter the fax number by using the numeric keypad.*
Also, enter access codes with the number, just as for a regular phone call.
Note: For information on entering one-touch and speed-dial numbers, see pages 2.7- 2.15.

```
** Tel Mode **
919725552009_
```

- 5** *When you hear fax tones from the remote unit, press **START**.*
Note: If a person answers the phone, use the optional handset to tell that person that you’re trying to send a fax. When you hear fax tones, press **START**.

- 6** If you’re using an optional handset, hang up after pressing **START**.

- 7** At the end of the operation, your fax machine beeps and displays:

```
972-555-2009
** Complete **
```

Note: If the call fails and you used **MONITOR/CALL** to dial, press **MONITOR/CALL** to hang up. Or if you’ve pressed **START** to begin the fax transmission, press **STOP** to end it.

Also see “Redialling manually,” below, if the call fails.

Redialling

If your fax call fails, your machine automatically redials it. In this *Auto Redial mode*, your fax *automatically redials* the number every few minutes (see “Changing redial settings,” next page) until one of the following happens:

- It reaches the remote fax machine.
- It has attempted the number of redials programmed and has still not connected (see “Changing redial settings,” next page).

While in the *Auto Redial mode*, the machine can continue to receive faxes and can make as many as 99 fax transmissions.

Note: If you used either the speaker or a handset to dial the call, you must redial manually (see below).

Note: If the last redial attempt fails, your machine may print (and/or display) error messages. For more information, see pages 3.5- 3.9.

Redialling manually

You can always redial calls manually. And you *must* redial manually if you used either the monitor speaker or an optional handset to dial the failed call.

To redial a fax call manually *without* using the monitor speaker or an optional handset:

- 1** Make sure the document is in the feeder and that the resolution and contrast are set.
- 2** Press **REDIAL/PAUSE**, **START**.

Getting started

To redial a fax call manually *with* the monitor speaker or an optional handset:

- 1 Make sure the document is in the feeder and that the resolution and contrast are set.
- 2 Press **MONITOR/CALL** or lift the optional handset to get a dial tone.
- 3 Press **REDIAL/PAUSE**.
- 4 *When you hear fax tones from the remote unit, press **START**.*
Note: If a person answers the phone, use the optional handset to tell that person you're sending a fax. When you hear fax tones, press **START**.

To redial a voice call manually using the optional handset:

- 1 Lift the optional handset to get a dial tone.
- 2 Press **REDIAL/PAUSE**. When the other person answers, use the optional handset to speak to that person.

Changing redial settings

It's up to you how many times the fax redials a number and how long it waits between redials (that length of time between calls is the *redial interval*). To program the redial settings:

- 1 Press **►/PROGRAM, J, 0, 7, ENTER**.

```
Set # Of Redials
# (02-05): 02
```

- 2 Use the numeric keypad to enter the number of redials you want. Choose from 2 to 5 redials. In this example, we've entered *03*.

```
Set # Of Redials
# (02-05): 03
```

Important: Enter a leading zero when entering a quantity less than 10.

- 3 Press **ENTER** to save the setting.
- 4 The LCD now shows:

```
Set Redial Interval
Inter. (3-5): 3
```

- 5 Use the numeric keypad to enter the length you want between redial attempts. Choose from 3 to 5 minutes. In this example, we've chosen *4*.

```
Set Redial Interval
Inter. (3-5): 4
```

- 6 Press **ENTER** to save the setting.

Review Commands, an introduction

Your fax machine can store many "jobs" in its memory. And it keeps track of each one by assigning it a *command number*, like "C01."

Delayed commands, redial attempts and current fax transmissions are all stored in your fax machine's memory and given a command number.

The Review Commands function gives you the power to check on each job (or *command*) in your machine's memory. It also lets you *cancel* a command if you decide not to send the document.

To cancel a command:

- 1 Press **REVIEW COMMANDS**.
The LCD shows the *first* command, indicated by its command number and the phone number it will dial. If a command is in progress, that will be the first command the LCD shows:

```
C01:5552009
Program/Cancel
```

- 2 Press **◀** or **►/PROGRAM** until the command you want to cancel appears.
- 3 Press **CANCEL**. The LCD shows:

```
C01:5552009
Check Program/Cancel
```

- 4 If you want to cancel this command, press **CANCEL** again.
- 5 The LCD now shows the next command.
If you want to cancel it, too, go back to step 4.
If you *don't* want to cancel this command but *do* want to review *other* commands, press **►/PROGRAM** until the command you want appears. Then go back to step 4.
If you want to stop reviewing the stored commands, press **STOP** to return the machine to standby mode.

For more information on the Review Commands function, see page 2.18.

Receiving faxes

Answering calls manually

In any reception mode, you can always answer calls manually *if you have an optional handset installed*. Just pick it up, as you would if using a normal phone.

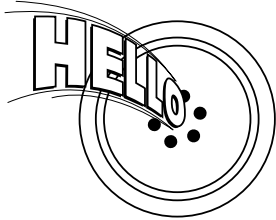

If you hear someone speaking to you, use your optional handset to speak back.

If you hear *fax tones* (“beep – beep – beep”), press **START** and hang up the optional handset. The fax machine will begin receiving a fax.

Note: Receiving this way disables “V.34” mode so that the machine receives the fax in normal ITU-T Group 3 fashion. (See page 3.18.)

Note: Don’t try to answer a call by pressing **MONITOR/CALL**. The monitor function is for dialling only.

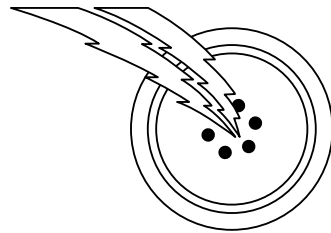

Answering fax calls using another phone, not the fax machine

If you have one phone line ringing to several phones in your office and *you have an optional handset attached to your fax*, there’s no need to run to the fax machine to answer every call. If you happen to answer a fax call while you’re at another extension, put the handset down, but don’t hang up. Walk to the fax machine and pick up the optional handset. Then press **START**.

After you press **START**, hang up both the fax machine’s handset and the second telephone’s handset. Because remote fax machines will wait several seconds to hear reception tones from your unit, you have about 30 seconds to walk to your fax, pick up the handset, and press **START**.

Reception modes

Your fax machine has five different reception modes – *Tel Ready, Fax Ready, Fax/Tel Ready, Tel/Fax Ready* and *Ans/Fax Ready*. We’ll explain each of these in this section.

Tel Ready mode

- Use it if:**
- You want to use the same line for both fax and phone calls *and*
 - On that line, you’re using at least one other phone which is *not* connected to your fax machine *or*
 - You have an optional handset installed on your fax machine

In this mode: Your fax machine never answers calls automatically. You must answer each call as described in “Answering calls manually” (this page, left column).

To select Tel Ready:

- 1** If there’s a document in the feeder, press **STOP** so it will feed out.
- 2** Press **AUTO ANSWER** until the Auto Answer light is off and the LCD shows:

<p>Tel Ready 11 Sep 1999 20:30</p>
--

To toggle between Tel Ready and your default mode, press **AUTO ANSWER**. The Auto Answer light comes on again, and your default mode shows on the LCD.

Fax Ready mode

Use it if: Your fax machine uses its own phone line and doesn't share it with a phone or an answering machine.

In this mode: Your fax machine answers each call and attempts to receive a fax.

To select Fax Ready:

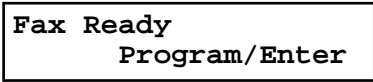
- 1 If there's a document in the feeder, press **STOP** so it will feed out.
- 2 Press **AUTO ANSWER** until the Auto Answer light glows.
- 3 Press **▶/PROGRAM, I**, and then press **ENTER** *five times*. The LCD shows your current default reception mode:

```
Fax Ready
Program/Enter
```
- 4 Press **◀** or **▶/PROGRAM** until the LCD shows:

```
Fax Ready
Program/Enter
```
- 5 Press **ENTER** to save the setting.
- 6 Press **STOP** to return the machine to standby mode.

Fax/Tel Ready mode

The Fax/Tel Ready mode is a combination of the Fax Ready and Tel Ready modes.

Use it if: An optional handset is installed on your fax machine
and
You're using the machine as both a fax machine and a telephone

In this mode: Your fax machine answers each call without ringing. If you receive a voice call, it alerts you with a special ring.

To select Fax/Tel Ready:

- 1 If there's a document in the feeder, press **STOP** so it will feed out.
- 2 Press **AUTO ANSWER** until the light Auto Answer light glows.
- 3 Press **▶/PROGRAM, I**, and then press **ENTER** *five times*. The LCD shows your current default reception mode:

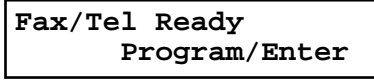
```
Fax Ready
Program/Enter
```
- 4 Press **◀** or **▶/PROGRAM** until the LCD shows:

```
Fax/Tel Ready
Program/Enter
```
- 5 Press **ENTER** to save the setting.
- 6 Press **STOP** to return the machine to standby mode.

Now your fax machine receives faxes silently *but also* alerts you when a regular voice call comes in. (Your fax machine also beeps once at the end of each reception.)

If a voice call comes in, your fax machine detects it and sounds a special ring. If you hear it, answer using your optional handset.

Note: This Fax/Tel Ready mode won't turn off ringers on other telephones in your house or office. Other phones won't distinguish between fax and voice calls.

Tel/Fax Ready mode

The Tel/Fax Ready mode is a combination of the Tel Ready and Fax Ready modes.

Use it if: An optional handset is installed on your fax machine
and
You're using the machine as both a telephone and a fax machine

In this mode: Your fax machine rings the number of times you've identified in the user settings. If you don't use the optional handset to answer the call, your fax machine answers the call. If a caller sends a fax, your machine begins receiving it. If a voice call comes in, your machine detects it and sounds a special ring, telling you to answer using the optional handset.

To select Tel/Fax Ready:

- 1** If there's a document in the feeder, press **STOP** so it will feed out.
- 2** Press **AUTO ANSWER** until the Auto Answer light glows.
- 3** Press **▶/PROGRAM, I**, and then press **ENTER** *five times*. The LCD shows your current default reception mode:

Fax Ready
Program/Enter
- 4** Press **◀** or **▶/PROGRAM** until the LCD shows:

Tel/Fax Ready
Program/Enter
- 5** Press **ENTER** to save the setting.
- 6** Press **STOP** to return the machine to standby mode.

Ans/Fax Ready mode

Use it if: You're using an answering machine that's connected directly to your fax machine.

In this mode: An answering machine connected to your fax machine answers each call. If a voice call comes in, the answering machine begins to record the incoming message. If your fax machine hears a fax tone, it begins receiving the fax message.

To select Ans/Fax Ready:

- 1** If there's a document in the feeder, press **STOP** so it will feed out.
- 2** Press **AUTO ANSWER** until the Auto Answer light glows.
- 3** Press **▶/PROGRAM, I**, and then press **ENTER** *five times*. The LCD shows your current default reception mode:

Fax Ready
Program/Enter
- 4** Press **◀** or **▶/PROGRAM** until the LCD shows:

Ans/Fax Ready
Program/Enter
- 5** Press **ENTER** to save the setting.
- 6** Press **STOP** to return the machine to standby mode.

Using an answering machine with your fax machine

To connect your answering machine to your fax machine:

- 1 Set the fax machine for Ans/Fax Ready, as described on page 1.19.
- 2 Set your answering machine to answer calls after *no more than* two rings. (See the answering machine's instructions if necessary.)
- 3 Create a new outgoing message on your answering machine. Here's a suggested message:

Hello! You've reached [your name or telephone number]. To leave a **voice** message, please wait for the beep. To send a **fax**, press **START** on your fax machine. Thanks for calling!

Important: Your answering machine's outgoing message must be *no longer than* 10 seconds.

Detection of "silent" fax machines

Some older fax machines don't send fax tones when transmitting, which can cause problems when using an answering machine with your fax.

But your fax machine can accommodate these "silent" machines *without* disrupting your answering machine operation. For more information, call your authorised Muratec dealer.

If the paper runs out

Getting the word from your machine

When your fax machine runs out of paper, the machine beeps, the **REPLACE PAPER** light glows and the LCD indicates which source has run out of paper, either the cassette or the multipurpose tray.

In this example, the cassette is empty:

Fax Ready Check Cassette Paper

Your fax machine cannot *print* fax messages or copies without paper. But it can still receive documents into its memory, as described in the section below.

Receiving when out of paper

If your machine runs out of paper, it stores up to 250 fax *receptions* in its memory. This is called *out-of-paper reception*. Once you refill the paper supply, the fax machine prints the stored messages automatically.

Note: The number of *pages* (not *receptions*) your fax machine can store for out-of-paper reception will vary. It depends on:

- Your machine's memory capacity
- Types of documents being sent to your machine
- Resolution of documents being sent to your machine

(See Specifications, page AI.1.)

Making copies

Your fax machine also doubles as a convenience *copier*.

To make copies with your fax machine:

1 Insert the document **face up**.

Remember:

- There are certain types of documents you should never insert into your fax machine. (Review “Things *not* to put in your fax,” page 1.13.)
- The document can be up to 50 pages.
- If you’re copying a multi-page document, “fan” the pages.
- Adjust the machine’s document guides to fit the document.

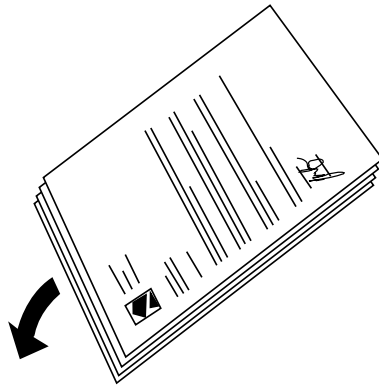

2 Adjust the resolution and contrast, if necessary.

3 Press **COPY**. The LCD shows:

Of Pgs. To Copy 01
Copy/Stop

4 Use the numeric keypad to enter the number of copies you want to make for each page in the document. Choose from 1 to 99 copies.

Here, we’ve chosen *03* copies.

Of Pgs. To Copy 03
Copy/Stop

Note: The setting requires two digits. Enter a leading zero for quantities less than 10.

5 Press **COPY** to begin copying.

Note: Because your machine has multi access performance, you can copy documents with your machine and also receive documents into memory at the same time. See page 2.33 for more information.

Using your fax machine as a phone

Your fax machine can also be used as a phone, if you have an optional handset installed. The following is a brief look at the machine's telephone features.

Redial

Press **REDIAL/PAUSE** to redial the last number dialled on your machine.

Dialling with the monitor speaker

Because your machine has a monitor speaker, you can dial without picking up the handset. For hands-free dialling:

- 1 Press **MONITOR/CALL**. You'll hear a dial tone (unless you have set your speaker volume to *Off*; see page 1.8- 1.9), and the LCD shows:

**** Tel Mode ****

—

- 2 Dial the number you want. Use either the numeric keypad, a one-touch key or a speed-dial number to dial.

Note: Remember, your fax machine's monitor speaker is *not* a speakerphone. If a person answers the call, pick up the handset to speak.

Note: If the call fails, press **MONITOR/CALL** to hang up.

EasyDial directory dialling

The EasyDial directory feature is available for regular phone calls as well as fax calls. Review the EasyDial instructions on page 2.15 for more information.

Checking the fax reception mode

While using an optional handset for your call, if you press ◀, the LCD shows the current fax reception mode. Press ◀ again to return to the TEL mode.

Dialling in the event of a power failure

Your fax machine can receive or make telephone calls even in the event of a power failure if an optional handset is attached. *But it cannot* send or receive a fax document.

This page intentionally blank.

Beyond the basics

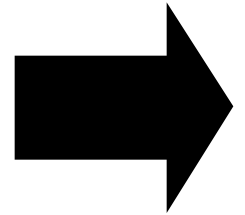

*We've covered
the "musts."
Now, let's explore
the goodies.*

Entering settings for your fax machine	2.1
Autodialler	2.7
Broadcasting	2.16
Delayed transmission	2.17
Batch transmission	2.20
Special features	2.24
F-Code communication	2.35
Programmable one-touch keys	2.45
Security features	2.59

Entering settings for your fax machine

The EasyStart feature guided you through the “just-gotta” settings on your machine. In the next few pages, we’ll cover additional settings.

Scan settings

Three different settings tell your machine how to scan documents:

- **Primary resolution mode** –Sets the resolution for your documents. Choose either normal, fine, superfine (“S Fine” on the LCD) or greyscale mode (“Gray”).
- **Primary contrast mode** –Sets how light or dark you want faxed documents to be when they arrive at their destinations.
- **Scanning width** –Sets how wide an area your machine scans for each page.

To set these modes:

- 1 Press **▶/PROGRAM, J, 0, 1, ENTER**. The LCD asks you to select a *resolution*.

```
Primary:   Normal
          Program/Enter
```

- 2 Press **◀ or ▶/PROGRAM** until the mode you want appears. In this example, we’ve chosen fine resolution.

```
Primary:   Fine
          Program/Enter
```

- 3 Press **ENTER** to save the setting. The LCD asks you to select a *contrast setting*.

```
Contrast:  Normal
          Program/Enter
```

- 4 Press **◀ or ▶/PROGRAM** until the mode you want appears. In this example, we’ve chosen light contrast.

```
Contrast:  Light
          Program/Enter
```

- 5 Press **ENTER** to save the setting. The LCD asks you to select a *scanning width*.

```
Scan Width:  B4
          Program/Enter
```

For most uses, “A4” is the proper setting. It scans the central 208 mm of each page. But for documents with an unusual width, you may want to use the “B4” setting, which scans the central 252 mm of each page. (See “A4, B4” in the Glossary on page 3.15.)

- 6 Press **◀ or ▶/PROGRAM** until the mode you want appears. In this example, we’ve chosen “A4”.

```
Scan Width:  A4
          Program/Enter
```

- 7 Press **ENTER** to save the setting.

By following the steps above, you’ve set your *defaults* for scanning. Before sending documents, you can “override” these default scan settings *for that transmission*.

To *override* the default resolution and contrast settings before sending a document:

- Press **RESOLUTION** to change the resolution.
- Press **CONTRAST** to change the contrast.

Once your document is transmitted, your machine returns to its default settings.

Using CODE to enter characters

Some settings give you a chance to enter an identifying name (see EasyStart, page 1.10). You can do this with the one-touch key, and you can also use the CODE key.

To use the CODE key to enter characters:

- 1 When the machine prompts you to enter a name, press CODE. The display changes to:

Your Name ;Code
—

- 2 Find the character you want to enter in the chart below.

First keypress

Second keypress	0	2	3	4	5	6	7	A	B	C	D	E	F
		0	@	P	`	p	Ç	É		↑	α	p	
	1	!	1	A	Q	a	q	ü	æ	°	↓	ä	q
	2	"	2	B	R	b	r	é	Æ	Γ	á	β	θ
	3	#	3	C	S	c	s	â	ô	∟	í	ε	∞
	4	\$	4	D	T	d	t	ä	ö	·	ó	μ	Ω
	5	%	5	E	U	e	u	à	ò	·	ú	σ	ü
	6	&	6	F	V	f	v	á	û	∫	ñ	ρ	Σ
	7	'	7	G	W	g	w	ç	ù	∫	Ñ	9	π
	8	(8	H	X	h	x	ê	ÿ	\	á	∫	∫
9)	9	I	Y	i	y	ë	Ö	"	q	"	∫	
A	*	:	J	Z	j	z	è	Û	ø	¿	j	∫	
B	+	;	K		k	{	ï	φ	ø	∫	x	∫	
C	,	<	L	¥	l		î	£	<	∫	φ	∫	
D	-	=	M		m	}	ì	¥	∫	∫	∫	∫	
E	.	>	N	^	n	→	Ä	Pt	"	«	ñ	∫	
F	/	?	O	_	o	←	À	f	°	»	#	■	

The legends in the black border indicate which key you press, and in which order, to get a given character. For example, to get a backslash (\) character, you'd press C, 8. (The blank areas for 2, 0 and C, 0 indicate spaces.)

- 3 To enter each character, press the key combination listed on the chart.

Important: Remember, there are three ways to enter characters:

Enter	Using
Numbers	Numeric keypad
Letters/characters	One-touch keys
Letters/characters/numbers	CODE chart for key combinations

Note: If you want to erase characters, press CANCEL to erase to the left. If you want to change just one character in the name, press ◀ to move the cursor left, or ▶/PROGRAM to move it right. Press CANCEL to erase the character. Then re-enter the character correctly.

- 4 Press ENTER to save the name.

Print settings

You can set three parameters for printing received fax messages:

- Print reduction rate
- Reduction margin
- Half-page reception

You set all three in the same procedure, discussed on page 2.3. Following is a short explanation for each:

Print reduction rate

Print reduction lets you set the machine to reduce large incoming documents to a size which fits on the paper in your machine. There is also a *copy reduction* setting that does the same for copies you make on your machine (*copy reduction rate* is discussed on page 2.3).

Below are the options for both the print reduction and copy reduction settings:

Setting	What it does
Auto	Automatically reduces printouts at variable rates down to a minimum of 50%. Tries to reduce printout to fit on one sheet of your selected paper size. If it can't, prints the image at 100% size on two or more pages.
100%	Does not reduce document. (Due to the sender's TTI, this may print <i>two</i> pages when receiving a one-page fax document. See 97%, below.)
97%	Reduces an original so that the final printout of a one-page-document (<i>if the original isn't larger than the paper in your machine</i>) will only be one page long, even with the TTI.
91%	Reduces documents slightly more.
81%	Reduces documents even more. Helpful for some international stationery sizes, as well as special applications.
75%	Turns <i>legal-sized</i> originals into <i>US letter-sized</i> printed copies.

For best results ...

Whenever possible, **load the correct size of paper before receiving a fax (or making a copy) of that size.** Although it's convenient, the reduction feature can't be used for *every* situation.

Reduction margin

Your fax machine's *reduction margin* is measured in millimetres (mm). We'll define *reduction margin* by explaining how it's used:

When a fax message enters your machine's electronic brain, the machine measures the message's length and compares it to **(a)** the length of your selected paper **plus (b)** the reduction margin you set. If the length of the incoming message is shorter than **(a)** and **(b)** put together, your machine prints the message on just one sheet. If it's longer, your machine prints the message on more than one sheet.

Note: An *Auto* reduction setting and a reduction margin setting of *24mm* will print most incoming faxes as single pages. Try this combination first and then, only if you have problems with it, select different settings.

Half-page reception

Half-page reception can conserve paper if some of the faxes you receive are half-page, "memo-sized" messages. When activated, this feature tells the machine to combine two of these half-page receptions onto a single sheet. Half-page reception only combines half-page messages sent back-to-back *during the same transmission*. It won't combine two half-page faxes from separate transmissions.

Adjusting the print settings

- 1 Press **▶/PROGRAM, J, 0, 2, ENTER**. The LCD shows the current print reduction rate:

```
Prnt Reduc Rate:Auto
Program/Enter
```

- 2 Press **◀** or **▶/PROGRAM** until the reduction setting you want appears. In this example, we've chosen *91%*.

```
Prnt Reduc Rate: 91%
Program/Enter
```

- 3 Press **ENTER** to save the setting. The LCD shows the current reduction margin:

```
Prnt Reduc Rate: 91%
Margin(00-85mm): 24
```

- 4 Use the numeric keypad to enter the reduction margin you want. If necessary, press **◀** or **▶/PROGRAM** to move the cursor. In this example, we've chosen *00mm*.

```
Prnt Reduc Rate: 91%
Margin(00-85mm): 00
```

- 5 Press **ENTER** to save the setting. The LCD shows the current setting for half-page reception:

```
Half Page Recpt: Off
Program/Enter
```

- 6 Press **◀** or **▶/PROGRAM** until the setting you want appears. In this example, we've chosen *On*.

```
Half Page Recpt: On
Program/Enter
```

- 7 Press **ENTER** to save the setting.

Copy settings

You can set two parameters for copying:

- Copy reduction rate — Works the same way as the print reduction rate (see page 2.2 for more details).
- Reduction margin — Serves the same purpose as the reduction margin for printing (see "Reduction margin," left column).

You set both parameters in the same operation:

Note: The manufacturer suggests a reduction margin of *00* for your copy settings.

- 1 Press **▶/PROGRAM, J, 0, 3, ENTER**. The LCD shows the current copy reduction rate:

```
Copy Reduc Rate:Auto
Program/Enter
```

- 2 Press **◀** or **▶/PROGRAM** until the reduction setting you want appears. In this example, we've chosen *75%*.

```
Copy Reduc Rate: 75%
Program/Enter
```

- 3 Press **ENTER** to save the setting. The LCD shows the current reduction margin:

```
Copy Reduc Rate: 75%
Margin(00-85mm): 24
```

- 4 Use the numeric keypad to enter the reduction margin you want. If necessary, press ◀ or ▶/PROGRAM to move the cursor. Here, we've chosen *00mm*.

```
Copy Reduc Rate: 75%
Margin(00-85mm): 00
```

- 5 Press ENTER to save the setting.

Setting the number of rings

You can set how many times your fax machine will ring before answering a call. Choose from 1 to 9 rings.

- 1 Press ▶/PROGRAM, J, 0, 6, ENTER. The LCD shows:

```
Set # Of Rings
#      (1-9):  2
```

- 2 Use the numeric keypad to enter the number of rings you want, from 1 to 9. Here, we've chosen 4 rings.

```
Set # Of Rings
#      (1-9):  4
```

Note: If you enter 0 (zero), the machine will beep briefly to warn you that it can't accept that setting.

- 3 Press ENTER to save the setting.

Setting ECM

"Line noise," or static on the line during a call, can easily disrupt the flow of data from one fax machine to another.

That's why your fax machine gives you the option of using *Error Correction Mode (ECM)*. When two fax machines communicate while running in ECM, the sending machine automatically *checks* the data as it sends. If the receiving fax machine can't verify the transmission, the first machine will re-send it as necessary.

Note: ECM gives you a better chance of transmitting a fax document over a bad phone line, but it could also slow down the transmission time. And the worse the line is, the slower the transmission. That's why the machine lets you turn ECM on or off as needed.

Note: Not all fax machines have ECM. If you've activated ECM and then transmit to a fax machine not currently using ECM, there will be no change in the fax transmission from a usual, non-ECM transmission.

- 1 Press ▶/PROGRAM, J, 0, 8, ENTER. The LCD shows the current ECM setting:

```
ECM Mode:      On
Program/Enter
```

- 2 Press ◀ or ▶/PROGRAM until the mode you want appears. In this example, we've chosen *Off*.

```
ECM Mode:      Off
Program/Enter
```

- 3 Press ENTER to save the setting.

Setting silent mode

Silent mode allows you to mute the ringer, alarm and key tones created by your fax.

- **Ringer** — When you turn the Ringer Silent setting *On*, your unit will not ring when you receive a fax or when you receive a voice call and a call request.
- **Alarm** — When you set the Alarm Silent mode *On*, your fax will not alert you with an audio alarm when an error occurs. The beep your fax makes after successfully sending or receiving a fax or making a copy is also silenced.
- **Key tone** — If you set the Key Silent setting *On*, your machine will not make a sound when you press buttons on the control panel.

Note: Silent mode allows you to mute the fax's *ringer* as well as its beep and key tones. If you're using your fax machine as both a fax and phone (with the optional handset), you may not want to use this feature.

Note: The silent mode can mute any alarms. However, if you set the audible alarm to on (see page 2.33), the machine alarms when it receives the fax messages.

- 1** Press **▶/PROGRAM, J, 1, 5, ENTER**. The LCD shows your fax's current setting:

```
Silent Mode:  Off
              Program/Enter
```

- 2** Press **◀ or ▶/PROGRAM** until the mode you want appears. In this example, we've chosen *On*.

```
Silent Mode:  On
              Program/Enter
```

Note: Choosing *On* allows you to select silent settings for the *Ringer*, *Alarm* or *Key tone* individually. If you chose *Off* the machine will ring and beep as usual.

Note: If you chose *Off* in step 2, skip to step 10.

- 3** Press **ENTER**. The LCD now asks if you want the ringer to be on or off:

```
Ringer Silent: Off
              Program/Enter
```

- 4** Press **◀ or ▶/PROGRAM** until the mode you want appears.

Refer to the notes at the top of this page. If you want to silence the telephone ringer in your fax for all uses, choose the *On* setting. Otherwise, the machine will ring.

- 5** Press **ENTER** to save the setting. The LCD now asks if you want the alarm turned on or off:

```
Alarm Silent:  Off
              Program/Enter
```

- 6** Press **◀ or ▶/PROGRAM** until the mode you want appears.

If you want to turn prevent the unit's alarm from ever sounding, select *On*. When this setting is *On*, all alarms are muted. Otherwise, the machine will beep.

- 7** Press **ENTER** to save the setting. The LCD now asks if you want the key tones on or off:

```
Key Buz.Silent: Off
              Program/Enter
```

- 8** Press **◀ or ▶/PROGRAM** until the mode you want appears.

If you want to turn off the tones, select *On* and all key tones will be silenced. Otherwise, the machine will beep when the keys are pressed.

- 9** Press **ENTER** to save the setting.

If you instructed your fax in the steps above to sound alarms or key tones, the machine now gives you the option to set the volume for these tones. If this option appears, go to step 10.

If you silenced these alarms and key tones, your fax machine will return to standby mode automatically.

- 10** The LCD shows your fax's current setting:

```
Alarm&Key Vol.: Mid
              Program/Enter
```

- 11** Press **◀ or ▶/PROGRAM** until the mode you want appears. Below are the possible settings:

```
Alarm&Key Vol.: Max
              Program/Enter
```

 = Loudest setting.

```
Alarm&Key Vol.: Mid
              Program/Enter
```

 = Medium setting.

```
Alarm&Key Vol.: Min
              Program/Enter
```

 = Low setting.

- 12** Press **ENTER** to save the setting.

Setting the transmission confirmation stamp

You can set your fax machine so that it will automatically place a small *stamp* mark on the front of each *original* document that it successfully scans.

Important: Turn off this feature if you're sending documents you don't want the fax to stamp.

- 1 Press ►/PROGRAM, J, 1, 9, ENTER. The LCD shows your fax's current setting:

```
Stamp:           Off
Program/Enter
```

- 2 Press ◀ or ▶/PROGRAM until the mode you want appears. In this example, we've chosen *On*.

```
Stamp:           On
Program/Enter
```

- 3 Press ENTER to save the setting.

Language settings

English is the language your machine initially displays on the LCD and uses to print reports. But you can set it to "speak" French, Spanish or German, too. As you give the order for the machine to change languages, it "rolls" from English to French to Spanish to German, and then back to English.

To make the change from one language to the next, press ►/PROGRAM, #.

Checking the language

If, after making a language change, you're not sure *which* language is showing, press ►/PROGRAM once and decide based on what you see on the LCD:

```
A Num. Une-Touche
Program./Val.
```

is French.

```
A Núm. Una-Tecla
Program./Sel.
```

is Spanish.

```
A Zielwahl
Programm/Eing.
```

is German.

If the language you see is the one you want, press STOP to return to standby mode.

If you want to change languages, press STOP to return to standby mode. Then press ►/PROGRAM, # again to go to the next language in the cycle.

Printing your settings

After you've programmed settings into your machine, print a *settings list*. We recommend this, particularly if you're sharing the machine with other users, who might change the settings.

With this list, you can quickly confirm that all of your settings are correct, without having to go back and check them on the machine. Or, if you *do* need to undo someone else's changes, this list guides you in returning the machine to your preferred settings.

Note: Please refer to the index at the end of these instructions to locate any settings you don't recognise or understand.

To print the settings list:

- 1 Press ►/PROGRAM, I, ENTER.

```
Enter Time
'99 09/11 20:30
```

- 2 Press ENTER until the LCD shows:

```
Print Setting List
Enter/Stop
```

- 3 Press ENTER to print the settings list.

Autodialler

Your fax machine's *autodialler* stores your most frequently called phone and fax numbers for instant recall so you don't have to remember them. It's something like an electronic phone book.

Autodialler basics

How do you autodial?

There are two kinds of autodialler numbers. The difference between the two is how you dial them:

Type	How to dial	Amount stored
<i>One-touch</i>	Press one of the keys, marked 01-64 on the right side of the control panel	64
<i>Speed-dial</i>	Press SPEED DIAL/TEL INDEX followed by a three-digit identifier, from <i>001</i> to <i>136</i>	136
Total amount of numbers stored		200

Autodialling fax and phone numbers

Your fax machine's autodialler will hold more than just fax numbers. You can store phone numbers, too.

This is because when you use the autodialler to dial a number, the fax checks to see if there's a document in its feeder. If there is, the machine dials as a fax machine. If there isn't, it dials as a phone.

Location IDs and the EasyDial directory

When you store numbers in your autodialler, you can give these numbers descriptive names, such as "Chicago office" or "Billing department". Your machine calls this name a *Location ID*.

Your machine's autodialler sorts these location IDs alphabetically. Using your *EasyDial directory*, you can look up these numbers by their descriptive names, just as if you were using a phone book.

We'll explain how to store the numbers and location IDs in the next few pages. The *EasyDial directory* is discussed in detail on page 2.15.

Special Dialling Characters

Your fax machine allows you to enter special dialling characters when programming the autodialler. These characters include hyphens and dashes, which make phone numbers easier to read, and special characters needed for international calls.

The chart below briefly describes each of these characters. It also tells you what keys to press on your fax machine to store those characters in your autodialler:

Char.	What it does	Keystroke(s)
-	Makes long numbers easier to read. Doesn't change fax machine operation.	DIALING OPTIONS (<i>once</i>)
/	(<i>Has no effect in the Europe.</i>)	DIALING OPTIONS (<i>twice</i>)
!	(<i>Has no effect in the Europe.</i>)	DIALING OPTIONS (<i>3 times</i>)
- /	Enters a pause, during the dialling of long-distance numbers or when you're dialling through PABX. Each pause uses two of the characters you can store in one phone number.	REDIAL/PAUSE [<i>after entry of at least one other character</i>]
- !	If your fax machine is on a pulse (<i>not</i> tone-dialling) line, switches from pulse-dialling to tone ("DTMF")-dialling. Use after the actual phone number but before any characters (such as a long-distance carrier's access code) which must be in DTMF tone. <i>Do not</i> use on a tone line.	DIALING OPTIONS (<i>once</i>), then PROGRAM (<i>once</i>), then DIALING OPTIONS (<i>3 times</i>), then PROGRAM (<i>once</i>)
/	Enter "flash" signal to exchange PABX to PSTN before actual phone number. However, "/" must be entered to the first of number	Soft key which registered the flash signal. (See page 2.24.)

Call groups

As you set up your autodialler, you may also want to set up *call groups*. These are sets of phone numbers that make it easy to send the same fax to many different locations. For example, one call group may include all of your clients in one city, another group may include all of your employees and another may include all your vendors.

Your fax machine can:

- Store as many as 200 numbers in up to 32 call groups
- Store one number in as many as 32 different groups
- Print a directory of your call groups (see page 2.14)

Using one-touch numbers

Your fax machine stores up to 64 one-touch numbers using the keys marked **01-64**.

Entering or changing a one-touch number

- 1 Press **▶/PROGRAM, A, 1, ENTER**. The LCD shows the empty one-touch number.

Select One-Touch
01:No Number Stored

Note: If a one-touch number other than **01** appears on the LCD, it means that you have already entered a number for **01**.

- 2 Press the one-touch key in which you want to store a number or change a previously stored number. Here, we've selected **02** and the LCD shows either:

Select One-Touch
02:No Number Stored

or

Select One-Touch
02:9-1-555-987-6543

- 3 If you want to select a different one-touch key, press that key now.

- 4 Press **ENTER**. Depending on whether you already have a number entered for this one-touch number, the LCD now shows either:

02:Fax Number
_

or

02:Fax Number
9-1-555-987-6543_

- 5 Use the numeric keypad to enter the number *exactly* as your machine should dial it, including whatever access codes your phone system requires. (You may want to review "Special dialling characters," page 2.7.) The number can be up to 40 characters in length:

02:Fax Number
9-1-5559292039_

Your display can show only 20 characters at a time. To view characters beyond those 20, press **◀** to scroll to the left or **▶/PROGRAM** to scroll to the right.

Note: If want to erase characters, press **CANCEL** to erase to the left. If you want to change just one character in the number, press **◀** to move the cursor left, or **▶/PROGRAM** to move it right. Press **CANCEL** to erase the character. Then re-enter the character correctly.

- 6 When the number is as you want it, press **ENTER** to store it.

- 7 The LCD now displays either:

02:Alt. No.
_

or

02:Alt. No.
9-1-555-987-6553_

You now have the option to enter (or change) an *alternative* number. Your fax machine will dial this alternative number during a transmission or *polling* operation (see pages 2.29–2.31) after all redial attempts to the regular number fail (see pages 1.15–1.16). If the alternative number also fails, the fax alarm beeps to alert you to a problem.

Note: You can enter one alternative number for one speed-dial or one-touch number you entered. Your fax holds a maximum of 10 alternative numbers in all, that is, only 10 speed-dials or one-touch numbers can have the alternative number. After you have entered the alternative numbers for 10 speed-dials or one-touch numbers, the fax will no longer show this display.

If you want to enter (or change) an alternative number, enter it now.

The number can be up to 40 characters long.

If you do not want to enter or change an alternative number, go on to step 8.

- 8 Press **ENTER**.

9 The LCD now displays:

02:Name ;Upper _	or	02:Name ;Upper S. W. Region Office_
---------------------	----	--

The machine is now prompting you for a name — a Location ID — so you'll be able to find it in the EasyDial directory (see page 2.15).

If you *do not* want to enter or change this Location ID, skip to step 11.

If you *do* want to enter or change this Location ID, go on to step 10.

10 Enter the Location ID the same way you entered your fax name during EasyStart. A number's Location ID may be up to 24 characters in length.

Important: As in EasyStart, enter letters and other non-numeric characters by using the one-touch keys.

02:Name ;Upper _

The word "Upper" means the machine is currently set for entering only upper-case letters. If you press **R**, the machine will see it as an *R* (not an *r*).

To enter a lower-case letter, press **ALPHABET**. The display changes to:

02:Name ;Lower _

This means pressing one-touch keys will enter lower-case letters: pressing **R** will produce an *r* (not an *R*) on the display.

To switch back for upper-case entries, press **ALPHABET**.

To enter spaces, punctuation and symbols, use the one-touch keys.

You can also use the **CODE** function to enter characters. Please review the explanation on page 2.2.

Note: To erase characters, press **CANCEL** to erase to the left. To change just one character in the name, press **◀** to move the cursor left, or **▶/PROGRAM** to move it right. Press **CANCEL** to erase the character. Then re-enter it correctly.

11 Press **ENTER** to save the setting and continue.

12 The LCD now displays:

02:Group No. _	or	02:Group No. 2,6_
-------------------	----	----------------------

You may now assign this number to up to 32 call groups. (If necessary, review "Call groups," page 2.8.)

If you *do not* want to change this number's call group, go to step 14.

If you *do* want to change this number's call group, go on to step 13.

13 Use the numeric keypad to enter the call groups for this number. There are 32 possible call groups, numbered 1–32.

Here, we've entered **3** to assign this one-touch number to *Call Group 3*:

02:Group No. 3_

If you want to assign the number to more than one call group, insert a *comma* after each number (except the last one) by pressing **GROUP DIAL**. For example, if you enter **3, GROUP DIAL, 1, 6, GROUP DIAL, 2, 7** to assign this one-touch number to *Call Groups 3, 16 and 27*, the LCD shows:

02:Group No. 3,16,27_

Note: To assign this number to all 32 call groups, enter *0* (zero).

Note: To erase characters, press **CANCEL** to erase to the left. To change just one character in the setting, press **◀** to move the cursor left, or **▶/PROGRAM** to move it right. Press **CANCEL** to erase the character. Then re-enter it correctly.

14 Press **ENTER**. The LCD will display the next empty one-touch number. If you *do* want to enter this one-touch number, go back to step 4. If you *do not* want to enter any more one-touch numbers, press **STOP** to finish. If you *do not* want to enter the *currently displayed* one-touch number but *do* want to enter *another* one-touch number, go back to step 2.

Use the autodialler labels in your fax's packaging to write down the stored numbers for easy reference. You can also print out a directory of your call groups. See page 2.14.

One-touch *fax* dialling

To dial a *fax* call using a one-touch number:

- 1 Insert the document.
- 2 Adjust resolution and contrast if necessary.
- 3 Toggle between transmission from the feeder or from memory if necessary, by pressing **MEMORY TRANSMIT**.
- 4 Press the one-touch key in which you've stored the number.

What happens next depends on whether you specified transmission from memory or transmission from the feeder:

If you specified Quick Memory transmission:

- Your fax machine scans the first page of your document into memory, then dials the other fax machine.
- While dialling, your machine scans the other documents into memory.
- The LCD shows the Location ID and the document's width and resolution settings:

```
Katz's Cat Care
A4           Normal
```

Note: If the entry doesn't have a Location ID, the number appears.

- When the other machine answers, your fax transmits the scanned document directly from memory. (To review Quick Memory transmission, see page 2.29.)

If you specified normal transmission from memory:

- Your fax machine scans your entire document into memory first, then dials the other fax machine.
- The LCD shows the Location ID and the document's width and resolution settings:

```
Katz's Cat Care
A4           Normal
```

Note: If the entry doesn't have a Location ID, the number appears.

- When the other machine answers, your fax transmits the document directly from memory. (To review memory transmission, see page 1.13.)

If you specified transmission from the feeder:

- Your fax machine dials the other fax machine.
- When the other machine answers, your fax feeds the document through its scanner, transmitting as it goes.
- The LCD shows the Location ID and the document's width and resolution settings:

```
Katz's Cat Care
A4           Normal
```

Note: If the entry doesn't have a Location ID, the number appears.

One-touch *phone* dialling

To dial a *phone* call using a one-touch number, you *must* have an optional handset attached to your machine. (Contact your authorised Muratec dealer to order an optional handset.)

To make the call:

- 1 Obtain a dial tone by doing one of the following:
 - Lift the handset
 - Press **MONITOR/CALL** to use the monitor speaker
- 2 Press the one-touch key in which you've stored the number. As the machine dials, it shows the number on the LCD:

```
** Tel Mode **
9-555-2842_
```

Note: Remember that your fax machine's monitor speaker is *not* a speakerphone. If you dialled by using the monitor speaker, pick up the handset to speak to the person that answers.

Note: If the call fails, and you used **MONITOR/CALL** to dial, press **MONITOR/CALL** to hang up.

Erasing a one-touch number

- 1 Press **►/PROGRAM, A, 2, ENTER**. The LCD shows the one-touch number you have already entered:

```
Select One-Touch
01:9-1-555-345-6789
```

Note: If the one-touch number that appears is other than **01**, it means that **01** is empty.

- 2** Press the key for the one-touch number you want to erase. Here, we've selected **02**:

```
Select One-Touch
02:9-1-555-987-6543
```

- 3** If you want to erase a number stored in a different one-touch key than what appears on the LCD, press that key now.

- 4** Press **ENTER**. The LCD shows:

```
Erase One-Touch
Check Program/Enter
```

Important: If you want to quit without erasing the one-touch number you've selected, press **▶/PROGRAM**. The fax will return to step 2.

- 5** Press **ENTER** to erase the number.

```
Erase One-Touch
** Complete **
```

To erase another one-touch number, repeat steps 2–5. Or press **STOP** to return to standby mode.

Printing a list of one-touch numbers

Forgot which number is stored in which one-touch key? Just print a list of your one-touch numbers. The list includes each key's number, the Location ID (if any), fax/telephone number and group number(s) you've stored in the key.

To print a list of one-touch numbers, press **▶/PROGRAM, A, 3, ENTER**.

Using speed-dial numbers

Your fax machine will store up to 136 speed-dial numbers, designated by three-digit identifier codes from *001* through *136*.

Entering or changing a speed-dial number

- 1** Press **▶/PROGRAM, B, 1, ENTER**. The LCD shows an empty speed-dial number:

```
Enter Speed-Dial No.
001:No Number Stored
```

Note: If a speed-dial number other than **001** appears on the LCD, it means you have already entered a number for **001**.

- 2** Use the numeric keypad to enter the desired speed-dial number's three-digit identifier code. Here, we've entered *005* and the LCD shows either:

```
Enter Speed-Dial No. or Enter Speed-Dial No.
005:No Number Stored or 005:9-555-397-0123
```

- 3** If you want to select a different speed-dial number, press that number's three-digit identifier code now. That number appears on the LCD.

Important: When entering the identifier code for speed-dial numbers less than 100, you must enter leading zeroes to make three digits. For example, *001-099*.

- 4** Press **ENTER**. Depending on whether you already have a number entered for this speed-dial number, the LCD now shows either:

```
005:Fax Number or 005:Fax Number
_ or 9-555-397-0123_
```

- 5** Use the numeric keypad to enter the speed-dial number *exactly* as your machine should dial it, including whatever access codes your phone system requires. (You may want to review "Special dialling characters," page 2.7.) The number can be up to 40 characters in length:

```
005:Fax Number
9-1-555-567-1234_
```

Your display can show only 20 characters at a time. To view characters beyond those 20, press **◀** to scroll to the left or **▶/PROGRAM** to scroll to the right.

Note: To erase characters, press **CANCEL** to erase to the left. To change one character in the number, press **◀** to move the cursor left, or **▶/PROGRAM** to move it right. Press **CANCEL** to erase the character. Then re-enter the number correctly.

- 6** When the number appears as you want it, press **ENTER** to store it.

7 The LCD now displays either:

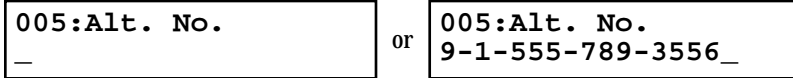

You now have the option to enter (or change) an *alternative* number. Your fax machine will dial this alternative number during a transmission or polling operation (see pages 2.29-2.31) only after redials to the regular number have failed. If the alternative number also fails, the fax alarm beeps to alert you to a problem.

Note: You can enter one alternative number for one speed-dial or one-touch number you entered. Your fax holds a maximum of 10 alternative numbers in all, that is, only 10 speed-dials or one-touch numbers can have the alternative number. After you have entered the alternative numbers for 10 speed-dials or one-touch numbers, the fax will no longer show this display.

If you *do not* want to enter or change an alternative number, go on to step 8. If you *do* want to enter or change an alternative number, use the numeric keypad to do so the same way you did in step 5. This number can be up to 40 characters long

8 Press **ENTER**.

9 The LCD now displays:

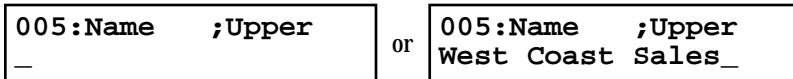

The machine is now prompting you for a name — a Location ID — so you'll be able to find it in the EasyDial directory (see page 2.15).

If you *don't* want to enter or change this number's Location ID, skip to step 11. If you *do* want to enter or change this number's Location ID, go on to step 10.

10 Enter the Location ID the same way you entered your fax name during EasyStart. A number's Location ID may be up to 24 characters in length.

Important: As in EasyStart, enter letters and other non-numeric characters by using the one-touch keys.

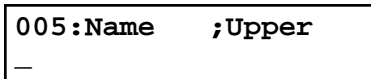

The word "Upper" means the machine is currently set for entering only upper-case letters. If you press **R**, the machine will see it as an *R* (not an *r*).

To enter a lower-case letter, press **ALPHABET**. The display changes to:

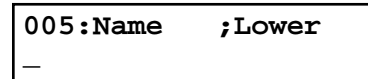

This means pressing one-touch keys will enter lower-case letters: pressing **R** will produce an *r* (not an *R*) on the display.

To switch back for upper-case entries, press **ALPHABET**.

Use the one-touch keypad to enter spaces, punctuation and symbols.

You can also use the **CODE** function to enter characters. Please review the explanation on page 2.2.

Note: To erase characters, press **CANCEL** to erase to the left. To change one character in the name, press **◀** to move the cursor left, or **▶/PROGRAM** to move it right. Press **CANCEL** to erase the character. Then re-enter the name correctly.

11 Press **ENTER** to save the setting and continue.

12 The LCD now displays:

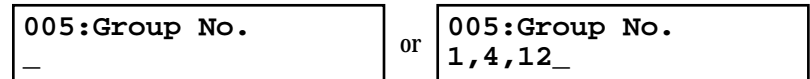

You may now assign this number to up to 32 call groups. (If necessary, review "Call groups," page 2.8.)

If you *do not* want to change this number's call group, skip to step 14. If you *do* want to change this number's call group, go on to step 13.

13 Use the numeric keypad to enter the call groups for this number. There are 32 possible call groups, numbered 1–32.

Here, we've entered **6** to assign this speed-dial number to *Call Group 6*:

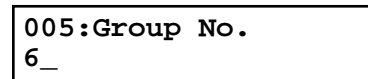

Note: You **do not** have to insert a leading zero for the call group number.

If you want to assign the number to more than one call group, insert a *comma* after each number (except the last one) by pressing **GROUP DIAL**.

Here, we've entered **6, GROUP DIAL, 1,7, GROUP DIAL, 3, 0** to assign this speed-dial number to *Call Groups 6, 17 and 30*:

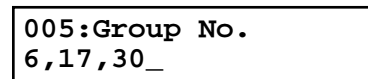

Note: To assign this number to all 32 call groups, enter 0 (zero).

Note: To erase characters, press CANCEL to erase to the left. To change just one character, press ◀ to move the cursor to the left, or ▶/PROGRAM to move it to the right. Press CANCEL to erase the character. Then re-enter the setting correctly.

- 14** Press ENTER.
The LCD will display the next empty speed-dial number.
If you want to enter this speed-dial number, go back to step 4.
If you *do not* want to enter any more speed-dial numbers, press STOP to finish.
If you *do not* want to enter the *currently displayed* speed-dial number but *do* want to enter *another* speed-dial number, go back to step 2.

Fax dialling via speed-dial

To dial a *fax* call using a speed-dial number:

- 1** Insert the document.
- 2** Adjust resolution and contrast if necessary.
- 3** Toggle between transmission from the feeder or from memory if necessary, by pressing MEMORY TRANSMIT.
- 4** Press SPEED DIAL/TEL INDEX. The LCD shows:

```
Enter Speed-Dial No.
S_
```

- 5** Use the numeric keypad to enter the three-digit identifier (such as 018, in this example) for the speed-dial number you want to dial. The LCD shows:

```
Shipping & Receiving
S018_
```

- 6** Press START.

What happens next depends on whether you specified transmission from memory or transmission from the feeder:

If you specified quick memory transmission:

- Your fax machine scans the first page of your document into memory, then dials the other fax machine.
- While dialling, your machine scans the other documents into memory.
- The LCD shows the Location ID and the document's width and resolution settings:

```
Shipping & Receiving
A4 Normal
```

Note: If the entry doesn't have a Location ID, the number appears.

- When the other machine answers, your fax transmits the scanned document directly from memory. (To review quick memory transmission, see page 2.29.)

If you specified normal transmission from memory:

- Your fax machine scans your entire document into memory, then dials the other fax machine.
- The LCD shows the Location ID and the document's width and resolution settings:

```
Shipping & Receiving
A4 Normal
```

Note: If the speed-dial entry doesn't have a Location ID, the number appears.

- When the other machine answers, your fax will transmit the document directly from memory. (To review memory transmission, see page 1.13.)

If you specified transmission from the feeder:

- Your fax machine dials the other fax machine.
- When the other machine answers, your fax feeds the document through its scanner, transmitting as it goes.
- The LCD shows the Location ID and the document's width and resolution settings:

```
Shipping & Receiving
A4 Normal
```

Note: If the speed-dial number doesn't have a Location ID, the number appears.

Phoning via speed-dial

To dial a *phone* call using a speed-dial number, you *must* have an optional handset attached to your machine. To make the call:

- 1** Obtain a dial tone by doing one of the following:
 - Lift the handset
 - Press MONITOR/CALL to use the monitor speaker
- 2** Press SPEED DIAL/TEL INDEX. The LCD shows:

```
** Tel Mode **
S_
```

- 3** Use the numeric keypad to enter the three-digit identifier (such as *018*, in this example) for the speed-dial number you want to dial. The LCD shows:

```

** Tel Mode **
9-555-5783_
    
```

Note: Remember that your fax machine's monitor speaker is *not* a speakerphone. If you dialled using the monitor speaker, pick up the handset to speak to the person that answers!

Note: If the call fails, and you used **MONITOR/CALL** to dial, press **MONITOR/CALL** to hang up.

Erasing a speed-dial number

- 1** Press **►/PROGRAM, B, 2, ENTER**. The LCD shows the speed-dial number you have already entered:

```

Enter Speed-Dial No.
001:9-555-584-6950
    
```

Note: If the speed-dial number that appears is other than **001**, it means that **001** is empty.

- 2** Use the numeric keypad to enter the three-digit identifier for the speed-dial number you want to erase. Here, we've selected *005*:

```

Enter Speed-Dial No.
005:9-1-555-987-6543
    
```

- 3** If you want to erase a different speed-dial number than the one that appears on the LCD, enter that number now.

- 4** Press **ENTER**. The LCD shows:

```

Erase Speed-Dial
Check Program/Enter
    
```

Important: If you want to quit without erasing the speed-dial number you've selected, press **►/PROGRAM**. The fax will return to step 2.

- 5** Press **ENTER** to erase the number.

```

Erase Speed-Dial
** Complete **
    
```

To erase another speed-dial number, repeat steps 2-5. Or press **STOP** to return to standby mode.

Printing a list of speed-dial numbers

You can easily print a list of your speed-dial numbers. The list includes each number's three-digit identifier, the Location ID (if any), number and any group numbers you've stored for that speed-dial number.

To print a list of speed-dial numbers, press **►/PROGRAM, B, 3, ENTER**.

Printing a call group directory

Your machine can also print a *call group directory*. (If necessary, review "Call groups," page 2.8.) This lists all your stored autodialler numbers by Location ID and lists the groups to which these numbers belong.

The directory divides the call groups into four banks, *01-09, 10-19, 20-29* and *30-32*. If you specify call group *0* (which puts the number in all call groups), the directory shows *01-32*.

For example, the directory might show:

No.	Location	00	10	20	30
001	And Sew It G	2 4			
002	KC Enterpris	7	0	1	
003	Katz Cat Car			0	2
01	Carson Co.,I	4	0 4		
02	Tex. Ofc. of	1			
03	e.e.gummings	2			

In this list, speed-dial number *001* is in call groups 2 and 4; speed-dial number *002* is in groups 7, 10 and 21; speed-dial number *003* is in groups 20 and 32; one-touch number *01* is in groups 4, 10 and 14; one-touch number *02* is in group 1; and one-touch number *03* is in group 2.

To print a call group directory, press **►/PROGRAM, H, ENTER**.

EasyDial directory dialling

EasyDial directory dialling makes your autodialler even more like an electronic phone book. EasyDial sorts and displays numbers alphabetically according to their Location IDs, so you can find them and dial them easily.

To dial using EasyDial:

- 1** For a regular phone call: *Make sure there's no document in the feeder*; then skip to step 4.
For a fax call: Insert the document.
- 2** Adjust resolution and contrast if necessary.
- 3** If you want to toggle between transmission from memory and transmission from the feeder, press **MEMORY TRANSMIT**.
- 4** Press **SPEED DIAL/TEL INDEX** *twice*. The LCD shows the *first* listing in your fax machine's EasyDial directory:

Telephone Index	[A]
ABC Company	:01

The EasyDial directory sorts entries alphabetically in the following order: **(1)** by alphabet, **(2)** by number and **(3)** by symbol.

If the listing that appears is the one you want to dial, skip to step 6.

- 5** Scroll through the listings to find the one you want. You do this by pressing the following keys on the numeric keypad:
 - **2** or **8** to select the character set — alphabet, number or symbol — for the *first* character of the Location ID.
 - **4** or **6** to check different listings within that character set.

Note: The scrolling is “open-ended.” For example, when you run out of listings beginning with alphabet “A”, pressing **4** or **6** automatically moves you into listings beginning with other characters.

- 6** When the LCD displays the name you want to dial, press **START**.
 - If there *is* a document in the feeder, your machine will dial a *fax call*.
 - If there *isn't* a document in the feeder, your machine will activate the monitor speaker and dial a regular phone call. At this point, you may either:
 - Lift the handset now
 - or*
 - Listen to the monitor speaker until you hear the other person answer, and then lift the handset.

To make a regular phone call from your machine, you must have an optional handset attached.

If an EasyDial call fails

If an EasyDial call fails, what happens next depends upon the kind of call it was.

If it was a fax call ...

... Your fax machine automatically redials the number according to the redial interval you've set (see page 1.16). It keeps trying until either of the following occurs:

- It successfully complete the fax communication.
- It reaches its maximum number of redial attempts.

If it was a regular phone call ...

... You'll have to redial manually:

- 1** Obtain a dial tone by **either** lifting the handset or pressing **MONITOR/CALL**.
- 2** Press **REDIAL/PAUSE**.

Note: If the call fails and you used **MONITOR/CALL** to dial, press **MONITOR/CALL** to hang up. Or if you've pressed **START** to begin the transmission, press **STOP** to end it.

Broadcasting

Broadcasting basics

The fastest way to fax *one* document to *many* recipients is to *broadcast* it.

In an ordinary broadcast, you send the fax as you normally would, except you just add more fax numbers. You can enter up to 230 numbers:

- 30 manually-dialled numbers **AND**
- 200 autodialler numbers **OR** 1 call group with all 200 autodialler numbers

You can broadcast using any function that requires a fax number to be entered. That means you can send a *delayed* broadcast, program a *polling* broadcast and even broadcast to “hub” units for F-Code *relay broadcast initiation*. All of these are explained in this chapter.

To send a broadcast fax:

- 1** Insert the document and make any necessary adjustments as you would for a regular fax transmission.
- 2** Press **BROADCAST**.
- 3** Enter the *first* fax number, as usual. Use either a one-touch number, a speed-dial number, a call group or a regular number dialled from the numeric keypad.
- 4** To add more fax numbers, press **BROADCAST** between each one to insert a *comma*. Then enter the number as described in step 3 (**GROUP DIAL** inserts its own comma). You can send to up to 230 numbers for a broadcast.

```
Press Start  
[03],s098,[10],9-555
```

Important: Do **not** insert a comma after the *last* fax number.

Note: If you enter characters by mistake, press **CANCEL** to erase them.

- 5** Press **START**. Your fax machine scans the document into memory and then sends it to each number or call group you've entered.

Delayed broadcasting

What if you want the broadcast to take place later? That's the purpose of setting up a *delayed broadcast*.

Note: Delayed commands are discussed in detail later. You may want to read “Delayed transmission” on page 2.17 before proceeding.

- 1** Follow steps 1–4 of “Broadcasting basics” (left column).
- 2** Press **COM-OPTIONS**, **ENTER**.
- 3** Use the numeric keypad to enter the day of the month and time (in 24-hour format) when you want the broadcast to occur. Here, we've scheduled it for 10:15 PM on the 30th.

```
Delayed  
Enter Time: 30/22:15
```

When finished, press **ENTER** to save the setting.

- 4** Press **START**. Your machine will return to standby mode, while showing this on the LCD:

```
** Reserved **  
29 Sep 1999 17:17
```

This means your fax machine is “reserved” for the delayed broadcast you just programmed, but it can still be used to send and receive faxes if your broadcast document is stored in memory.

Making changes to broadcasts

If you need to make changes in a broadcast after setting it up, use the **REVIEW COMMANDS** function. See “Reviewing or cancelling parts of a broadcast,” page 2.18.

Delayed transmission

Take advantage of lower evening and weekend long-distance rates with *delayed transmission*. Your fax machine can store up to 99 delayed commands, each of which you can program up to 31 days in advance.

Important: If you program all 99 delayed transmission commands, no further *memory* transmission is possible until one or more of the commands is completed. (To review memory transmission, see page 1.13.) However, if all 99 delayed commands are programmed, you can always transmit manually using monitor/speaker dialling or an optional handset (see page 1.15).

Setting up a delayed transmission

Important: Your machine only remembers the *day* of the month that it's supposed to send a delayed transmission. It does not remember the month itself. So if you want to send a transmission at 5:05 PM on **June** 26, don't program the transmission sooner than 5:06 PM on **May** 26.

To set up a delayed transmission:

- 1** Insert the document and make any necessary adjustments.
- 2** Press **COM-OPTIONS**. The LCD shows:

1.Delayed
Program/Enter
- 3** Press **ENTER**. The LCD shows the current day of the month, followed by the current time (in 24-hour format):

Delayed
Enter Time: 06/17:16
- 4** Use the numeric keypad to enter the day of the month and the time when you want the fax to send the delayed transmission.

Note: Press **◀** to move the cursor left, or **▶/PROGRAM** to move it right.

Here, we've set the transmission to occur on the 11th at 11:05 PM:

Delayed
Enter Time: 11/23:05

- 5** When the date and time are entered, press **ENTER** to save the delayed transmission. The LCD shows:

Enter Fax Number
—

- 6** Enter the fax number for the delayed transmission document. You can either press a one-touch key, enter a speed-dial number or use the numeric keypad to enter the fax number.

Note: If you want to erase characters, press **CANCEL** to erase to the left. If you want to change just one character in the number, press **◀** to move the cursor left, or **▶/PROGRAM** to move it right. Press **CANCEL** to erase it. Then re-enter the number correctly.

- 7** Press **START**. Your machine returns to standby mode, while showing this on the LCD:

** Reserved **
29 Sep 1999 17:17

This means your fax machine is “reserved” for the delayed transmission you just programmed.

- If you set the machine for *memory transmission*, it will scan the document into memory, after which you can use the machine normally.
- If you set the machine for *manual transmission*, the machine can *receive* faxes but can't *transmit* until your delayed command has been performed.

Important: If you've stored too much information in your machine's memory, a “Memory Overflow” message may appear on the LCD. This appears because **(1)** too many pages have been stored in the memory, or **(2)** the pages that are stored have too much information on them for your fax machine to remember. If this message appears, press **START** to tell your fax to keep as many pages in memory as possible, or press **CANCEL** to delete from memory all pages stored during the current operation (but not previous operations).

Reviewing or canceling delayed commands

If you've stored a delayed command in your fax machine, it will hold it in memory until it either completes the command successfully or reaches its maximum number of redial attempts (see pages 1.15–1.16). Your machine can store up to 99 delayed commands. It identifies each by a two-digit *command number* ranging from 01 to 99.

To see your machine's stored commands or to cancel them:

- 1 Press **REVIEW COMMANDS**.
 - **If there are no stored commands in your machine** — It beeps briefly and displays "No Command" on the LCD. It then returns to standby mode.
 - If there *are* commands in your machine's memory, the LCD shows:

```
C01:9-5552311
Program/Cancel
```

Here, you see *command 01*, followed by the number it's set to dial. If the command is to send a *broadcast*, "Broadcast" appears instead of the phone number. (See "Broadcasting," page 2.16.)

If the command is to send a *batch transmission*, the LCD shows its *batch box number* (such as "B01") rather than the command number. (See "Batch transmission," pages 2.20–2.23.)

If the command is for a *continuous polling operation*, the LCD shows its *continuous polling operation number* (such as "P01") rather than the command number. (See "Polling," on pages 2.29–2.31.)

Note: If your machine is attempting to perform a command *now*, it appears on the display.

- 2 Press **►/PROGRAM** or **◀** to scroll through currently stored commands.
- 3 If you want to cancel the command shown, press **CANCEL**. The LCD shows:

```
C01:9-5552311
Check Program/Cancel
```

- 4 To *keep* this command but to continue reviewing stored commands, press **►/PROGRAM**. Go back to step 2. To keep this command *and* stop reviewing commands, press **STOP** to return your machine to standby mode. To go ahead with cancelling the command, press **CANCEL** again. Go back to step 2 to view other delayed commands.

Note: See also "Reviewing or cancelling parts of a broadcast," next column.

Reviewing or cancelling parts of a broadcast

You also can review or cancel certain numbers within a broadcast:

- 1 Press **REVIEW COMMANDS**.
- 2 Press **►/PROGRAM** or **◀** to scroll through currently stored commands.

Note: Stop this operation at any time by pressing **STOP**.
- 3 If you want to cancel the command shown, press **CANCEL, CANCEL**. If you want to review *individual* numbers within this broadcast, go on to step 4 *without* pressing **CANCEL**.
- 4 To review *individual* numbers within this broadcast, press **BROADCAST** to see the first number. The LCD shows:

```
9-5550388
Program/Cancel
```

- 5 Press **►/PROGRAM** or **◀** until you find the number you want to cancel.
- 6 Press **CANCEL, CANCEL**. The next number will appear. If you want to cancel this number, also, repeat this step. If you want to cancel a different number, go back to step 5. If you don't want to cancel any more numbers, press **STOP**. The machine returns to standby mode.

Printing a delayed command list

Your machine can print a *command list* which tells you:

- The command's identification number
- The phone number, or "remote location"
- The start time (this appears in a *DD,HH:MM* format)
- A "note" telling if the command is a *polling* or *F-Code* operation (see pages 2.29–2.31 for more on *polling* and 2.35–2.44 for more on *F-Code communication*).

To print a delayed command list, press ►/PROGRAM, F, **1**, ENTER.

Printing a stored document

Your fax machine can print out each document stored for delayed transmission. To print a stored document, you'll need to know the document's command number, which you can get by either reviewing the commands (see page 2.18) or printing a delayed command list (see above).

- 1** Press ►/PROGRAM, F, **2**, ENTER. The LCD shows:

```
Print Stored Doc.  
Command No.:  _
```

- 2** Use the numeric keypad to enter the command's identification number, *01-99*. For example, we could enter the following for the very first command, *01*:

```
Print Stored Doc.  
Command No.:  01_
```

- 3** Press ENTER. Your fax machine will print a copy of the stored document.

Batch transmission

Batch transmission allows you to store multiple documents in an electronic “basket” throughout the day and then fax that entire basket to *one* location.

To do this, just tell the machine when and where the transmission should go. When that date and time arrives, your machine will transmit each document in the batch box to the remote fax machine. You can store up to 40 documents (each document can include one page or many pages) into your machine’s five electronic *batch boxes*.

Creating or modifying a batch box

Before sending a batch transmission, you have to create batch boxes in your fax machine. The steps below also let you modify existing batch boxes.

To create or modify a batch box:

- 1** Press **►/PROGRAM, N, 1, ENTER**. Depending on whether you already have a number entered for batch box *1*, the LCD shows:

Select Batch Box
1:No Number Stored

or

Select Batch Box
1:9-1-555-345-6789

- 2** Use the numeric keypad to enter the number (*1-5*) of the batch box you want to create or modify. Here, we’ve pressed **3** and see either:

Select Batch Box
3:No Number Stored

or

Select Batch Box
3:9-555-2110

- 3** If you want to select a different batch box than the one displayed on the LCD, use the numeric keypad to enter the batch box number now.

- 4** Press **ENTER**. The LCD now shows either:

3:Fax Number
_

or

3:Fax Number
9-555-2110_

- 5** Use the numeric keypad to enter the fax number *exactly* as your machine should dial it, including whatever access codes your phone system requires. (You may want to review “Special dialling characters,” page 2.7.) The number can be up to 40 characters in length:

3:Fax Number
9-1-555-871-9052_

Your display can show only 20 characters at a time. To view characters beyond those 20, press **◀** to scroll to the left or **►/PROGRAM** to scroll to the right.

Note: To erase characters, press **CANCEL** to erase to the left.

To change just one number, press **◀** to move the cursor left, or **►/PROGRAM** to move it right. Press **CANCEL** to erase it. Then re-enter the number correctly.

- 6** When the number appears as you want it, press **ENTER**. The LCD now displays:

3:Transmit Time
Enter Time: 26/14:00

- 7** Instruct your fax to send from this batch box in *one* of the following ways:

Option 1: *Once* at a certain time on a certain day of the month (For example: “Do this at 5:05 PM on the 30th.”) — Use the numeric keypad to enter the date and time (*24-hour format*) the machine should send the documents from the batch box:

3:Transmit Time
Enter Time: 30/17:05

Option 2: At a certain time *each day* you press the key (For example: “Do this at 5:05 PM today.”) — Use the numeric keypad to enter **0, 0** (*00*), and then the time when the fax should send the documents from the batch box:

3:Transmit Time
Enter Time: 00/17:05

Note: To change a digit in the date or the time, press **◀** to move the cursor left or **►/PROGRAM** to move it right. Then enter the correct number.

- 8** When the date and time are set, press **ENTER**.

- 9** The LCD now displays:

3:Name ;Upper
_ or 3:Name ;Upper
Bookkeeping_

The machine now asks you to name this batch box.

If you *do not* want to enter or change this batch box’s name, skip to step 11.

- 10** Enter the name the same way you entered your fax name during EasyStart. A batch box's name may be up to 24 characters in length.

Important: As in EasyStart, enter letters and other non-numeric characters by using the one-touch keys.

```
3 : Name      ; Upper
_
```

The word "Upper" means the machine is currently set for entering only upper-case letters. If you press **R**, the machine will see it as an *R* (not an *r*).

To enter a lower-case letter, press **ALPHABET**. The display will change to:

```
3 : Name      ; Lower
_
```

This means pressing one-touch keys will enter lower-case letters: pressing **R** will produce an *r* (not an *R*) on the display.

To switch back for upper-case entries, press **ALPHABET**.

Use the one-touch keypad to enter spaces, punctuation and symbols.

You can also use the **CODE** function to enter characters. Please review the explanation on page 2.2, if necessary.

Note: To erase characters, press **CANCEL** to erase to the left. To change just one character in the name, press **◀** to move the cursor left, or **▶/PROGRAM** to move it right. Press **CANCEL** to erase it. Then re-enter the name correctly.

- 11** Press **ENTER** to save the batch box information.

To create or modify another batch box, repeat steps 2–11. To finish, press **STOP**.

Printing a list of batch boxes

You can easily print a list of your batch boxes. The list includes each box's identifier number, the Location ID, fax number and date/time the transmission should start.

To print the list, press **▶/PROGRAM, N, 2, ENTER**.

Storing a document for batch transmission

Your fax machine can store up to 40 *documents* (each document can include one page or many pages) in each batch box until the date and time you designate the batch transmission to take place. Once the batch documents are transmitted, they are automatically erased from the machine's memory.

Note: For this operation to work, two things must be true:

- The batch box must exist on your fax machine.
- You must know the batch box's one-digit number (1-5).

To store a document in a batch box for batch transmission:

- 1** Insert the document and make any necessary adjustments.
- 2** Press **COM-OPTIONS** *three* times and then press **ENTER**. The LCD shows:

```
Batch Tx
Enter Box No.  _
```

- 3** Use the numeric keypad to enter the one-digit number for the batch box you want to use. Here, we've entered **5** to indicate batch box *5*.

```
Batch Tx
Enter Box No.  5_
```

Note: *Tx* is a common abbreviation for *transmission*.

- 4** Press **ENTER**. The LCD shows:

```
Press Start
Box:   5  File:  01
```

Important: Your machine gives each document in a batch box a *file number*, shown as *01* above. You will need to know this file number to erase or print the stored document. Each batch box holds up to 40 files (*01-40*).

- 5** Press **START**. The machine displays "Reserved" on the top line of the LCD. This means the document is stored in memory.

Printing a list of stored batch documents

You can print a list of the documents stored in your machine's batch boxes. This list provides you with the documents' file numbers so you can erase or print them as needed.

To print the list, press ►/PROGRAM, N, 3, ENTER.

Printing a document stored in a batch box

To print a document stored in a batch box:

- 1 Press ►/PROGRAM, N, 4, ENTER. The LCD shows:

```
Print Batch Doc.  
Enter Box No.   _
```

- 2 Use the numeric keypad to enter the number (1-5) of the batch box storing the document you want to print.

- 3 Press ENTER. The LCD shows:

```
Print Batch Doc.  
Enter File No.  _
```

- 4 Use the numeric keypad to enter the document's *two-digit* file number (01-40). If the file number is 01-09, be sure to enter the leading zero.

- 5 Press ENTER.

Your fax machine prints the document, then returns to standby mode.

Erasing a document stored in a batch box

To erase a document stored in a batch box on your fax machine:

- 1 Press ►/PROGRAM, N, 6, ENTER. The LCD shows:

```
Erase Batch Doc.  
Enter Box No.   _
```

- 2 Use the numeric keypad to enter the number (1-5) of the batch box storing the document you want to erase.

- 3 Press ENTER. The LCD shows:

```
Erase Batch Doc.  
Enter File No.  _
```

- 4 Use the numeric keypad to enter the document's *two-digit* file number (01-40). If the file number is 01-09, be sure to enter the leading zero.

- 5 Press ENTER. The fax machine now gives you one last chance to change your mind before erasing the document.

```
Erase Batch Doc.  
Check      Stop/Enter
```

Important: To quit the operation without erasing this or any document, press STOP. The machine returns to standby mode.

- 6 Press ENTER. The fax machine erases the document you've chosen, then returns to standby mode.

Erasing an empty batch box

Batch boxes must be empty to be erased. If a box has documents stored in it, then you first have to erase those documents. See page 2.22.

To erase an empty batch box:

- 1** Press ►/PROGRAM, N, 5, ENTER. The LCD shows:

```
Select Batch Box
1:No Number Stored
```

or

```
Select Batch Box
1:9-5551023
```

- 2** Use the numeric keypad to enter the number (1-5) of the batch box you want to erase. Here, we've pressed 2 and see:

```
Select Batch Box
2:9-1-972-5559900
```

- 3** If you want to erase a different batch box than what appears on the LCD, enter that batch box's number now.

- 4** Press ENTER. If the batch box is empty, the LCD shows:

```
Erase Batch Box
Check Program/Enter
```

Important: If you select a batch box which is *not* empty, the machine beeps and briefly displays:

```
Select Batch Box
Document Stored
```

Erase any documents stored in the batch box (see page 2.22), then go back to step 3.

Important: If you want to quit without erasing the batch box you've selected, press ►/PROGRAM. The fax will return to step 2.

Important: If you want to quit without erasing *any* batch box, press STOP. The machine returns to standby mode.

- 5** Press ENTER to erase the batch box.

```
Erase Batch Box
** Complete **
```

To erase another batch box, repeat steps 2-5. To finish, press STOP.

Special features

Your fax machine has numerous special features to make your communications easier. We'll cover them here.

Soft Keys

Soft Keys are shortcut keys. You can program the soft keys on the control panel to turn on or off any function with just the touch of a button. Your machine has four Soft Keys. If the light above any one of these keys glows, that means the setting programmed into that key is active.

These keys are programmed at the factory to turn the following functions on or off:

- Memory transmission (see page 1.13)
- Confirmation stamp (see page 2.6)
- Security reception (see page 2.60–2.61)
- Department codes (see page 2.66)

Note: The keys that are programmed at the factory turn the functions above them on and off, but only for the next transmission that you send from your fax machine. Once that transmission is complete, your machine returns to its default setting.

But instead of using the Soft Keys to control the functions above, you can program them to turn other functions on or off. These functions are:

- Activity journal printouts (see page 2.27)
- Half-page reception (see page 2.3)
- ECM (see page 2.4)
- Closed network (see page 2.64)
- Cover page (see page 2.26)
- Operation protection (see page 2.59)
- Quick memory transmission (see page 2.29)
- Department protection (see page 2.67)
- Copy & Fax feature (see page 2.25)
- Access to alternative telephone network (see page 2.33)
- Flash signal (see page 2.7)

Note: And instead of just turning the function on or off for the next transmission, as the factory-set keys do, changing the Soft Key settings actually sets the default for your fax machine. (These default settings can be changed, if necessary. They are not permanent.)

Setting the Soft Key

1 Press **▶/PROGRAM, E, 1, ENTER**. The LCD shows:

```
Select Soft Key No.  
1:Memory Tx
```

... or indicates another function you've stored into this key.

2 Press **◀** or **▶/PROGRAM** until the Soft Key (1-4) you want to change appears. In this example, we've chosen **3**.

3 Press **ENTER**. The LCD shows:

```
3:Security  
Program/Enter
```

4 Press **◀** or **▶/PROGRAM** until the function appears that you want to program into the key. In this example, we've chosen *Quick Tx*.

```
3:Quick Tx  
Program/Enter
```

5 Press **ENTER** to save the setting. The LCD will display the next Soft Key.

If you *do* want to set this Soft Key, go back step 3.

If you *do not* want to set the currently displayed Soft Key but do want to set another Soft Key, go back to step 2.

If you *do not* want to set any more Soft Keys, press **STOP** to finish.

Now you can use the labels included in your machine's original packaging to label the Soft Key function you just set. You can also print out a list of the Soft Keys (see below).

Printing a list of Soft Keys

A list of your Soft Keys includes each key's number and the function you've assigned to it.

To print the list, press **▶/PROGRAM, E, 2, ENTER**.

Copy & Fax

With the Copy & Fax feature turned on, your machine asks if you want to make a copy of a document each time it transmits that document from memory.

Note: The Copy & Fax function cannot be used for manual transmissions (memory transmission is off).

Note: Quick Memory transmission and the Copy & Fax function cannot be used at the same time. If both are turned on, Quick Memory will not work.

Note: The Copy & Fax feature will use the same resolution you set for the transmission for the copy's scanning resolution.

Setting the Copy & Fax feature

1 Press **►/PROGRAM, J, 2, 0, ENTER**. The LCD shows:

```
Copy&Fax:      Off
Program/Enter
```

2 Press **◀** or **►/PROGRAM** until the mode you want appears. Here, we've chosen *on*.

```
Copy&Fax:      On
Program/Enter
```

3 Press **ENTER** to save the setting.

Using the Copy & Fax function

1 Insert the document and make any necessary adjustments.

Note: Make sure that the memory transmission is on.

2 If you're storing the document for polling, follow the steps for that operation (see page 2.29 for *polling* and page 2.43 for *F-Code polling*). Then skip to step 5.

If you're faxing the document, go on to step 3.

3 Enter the fax number. Either press a one-touch key, enter a speed-dial number or use the numeric keypad to enter the fax number.

Note: To erase characters, press **CANCEL** to erase to the left.

To change just one character in the number, press **◀** to move the cursor left, or **►/PROGRAM** to move it right. Press **CANCEL** to erase it. Then re-enter the character correctly.

If you entered the fax number using a one-touch key, skip to step 5. Otherwise, go on to step 4.

4 Press **START**.

5 The LCD asks the number of copies you want to make:

```
# Of Pgs. To Copy 01
Start/Cancel
```

6 Use the numeric keypad to enter the number of copies you want for each page in the document. Choose from 01 to 99 copies. Here, we've chosen 03 copies.

```
# Of Pgs. To Copy 03
Start/Cancel
```

Important: If you *do not* want to copy the document, press **CANCEL**. The LCD shows:

```
Canceled Copying
Start/Stop
```

Press **START** to transmit or store the document.

If you want to quit without transmitting (or storing) and copying the document, press **STOP**. The fax returns to standby mode.

7 Press **START** to begin the transmission (or storing) and copying process.

Note: If you chose an immediate transmission, your fax machine will begin dialling. If you chose a delayed command or batch transmission, the machine will display "Reserved" on the top line of the display, indicating that the machine has stored the command in memory and will send the transmission later.

Cover page

Your fax machine can store a *cover page* to send at the beginning of each outgoing fax. This page includes the current date and time, your Location ID and your fax number (as stored in the TTI) and a message of up to 40 characters in length. The information appears in a box similar to this:

Fax Message From:	
19 Sep 1999 14:00	
Name:	And Sew It Goes Co.
Fax Number:	972-555-2009
We appreciate your business. Thank you!	

Turning the cover page on

- 1 Press **▶/PROGRAM, K, 1, ENTER**. The LCD shows:

Cover Page:	Off
Program/Enter	

- 2 To tell the fax machine it *should* send a cover page before each document you transmit, press **◀** or **▶/PROGRAM** until "On" appears on the LCD.

Cover Page:	On
Program/Enter	

Note: To tell the machine not to send a cover page, press **◀** or **▶/PROGRAM** until "Off" appears on the LCD and press **STOP**.

- 3 Press **ENTER** to save the setting.

Now the cover page feature is working but your message line (shown in the example as "We appreciate your business. Thank you!") is blank. To enter that message, see "Entering the cover page message," next.

Entering the cover page message

- 1 Press **▶/PROGRAM, K, 2, ENTER**.
 - 2 Use the one-touch keypad to enter a message for the cover page. Enter the message the same way you entered your fax name during EasyStart. The message can be up to 40 characters in length.
- Important:** As in EasyStart, enter letters and other non-numeric characters by using the one-touch keys.

Cover Page ;Upper
—

The word "Upper" means the machine is currently set for entering only upper-case letters. If you press **R**, the machine will see it as an *R* (not an *r*).

To enter a lower-case letter, press **ALPHABET**. The display will change to:

Cover Page ;Lower
—

This means pressing one-touch keys will enter lower-case letters: pressing **R** will produce an *r* (not an *R*) on the display.

To switch back for upper-case entries, press **ALPHABET**.

Use the one-touch keypad to enter spaces, punctuation and symbols.

You can also use the **CODE** function to enter characters. Please review the explanation on page 2.2.

Note: To erase characters, press **CANCEL** to erase to the left. To change just one character in the message, press **◀** to move the cursor left, or **▶/PROGRAM** to move it right. Press **CANCEL** to erase it. Then re-enter the message correctly.

- 3 When the message appears as you want it, press **ENTER** to save it.

Printing the cover page

To confirm that the cover page is set correctly, print a sample cover page from your fax machine. Press **▶/PROGRAM, K, 3, ENTER**.

Setting the activity journal

Just as a checkbook records your daily financial transactions, your fax machine keeps an *activity journal* which records its 100 most recent fax transactions. The activity journal lists the following information for each transaction:

- *Assigned number*, starting each day at 001
- *Remote location* called
- *Resolution mode*
- *Starting date and time*
- *Duration*, in minutes and seconds
- *Length*, in number of pages
- *Department code* (see pages 2.66–2.67)
- *Result of the call* — If preceded by an asterisk (*), this signifies an ECM communication (see page 2.4)
- *Any special operations* — For example, a fax call made using an optional handset will appear as “Manual”

Your fax machine will print the activity journal automatically after 100 transactions. To toggle this automatic printing on or off:

- 1 Press ►/PROGRAM, G, 1, ENTER. The LCD shows:

```
Auto Print:      Off
                Program/Enter
```

- 2 Press ◀ or ►/PROGRAM until the mode you want appears. Here, we've chosen *On*.

```
Auto Print:      On
                Program/Enter
```

- 3 Press ENTER to save the setting.

Printing an activity journal manually

To print an activity journal *immediately* without waiting for 100 transmissions to be completed, press ►/PROGRAM, G, 2, ENTER.

Setting the printing order of the activity journal

Your fax machine prints the activity journal for every fax transaction. For example, if your machine has to redial a call, it will list those redials on the journal.

If you want to list those activities in the order of their assigned numbers, you can change the printing order of the activity journal. To change the printing order:

- 1 Press ►/PROGRAM, G, 4, ENTER. The LCD shows:

```
Line Up:         Off
                Program/Enter
```

- 2 Press ◀ or ►/PROGRAM until the mode you want appears.

If you want the activity journal to print in the order of assigned number, choose “On”.

Otherwise, the machine will list every fax transaction of the same command and same location.

Here, we've chosen *On*.

```
Line Up:         On
                Program/Enter
```

- 3 Press ENTER to save the setting.

Setting the reports: TCRs and RCRs

Your fax machine can print *reports* of transmissions and receptions.

There are two different reports: a *transmit confirmation report (TCR)* and a *receive confirmation report (RCR)*. You can receive a TCR after sending a fax to *any* Group 3 fax machine, but the RCR function works only when you send a fax to a compatible Muratec machine. (Consult your authorised Muratec dealer with any questions about such compatibility.) Choose the type of report you want, based on the fax machines to which you're transmitting.

What the reports tell you

TCR

The TCR lists the following information for each communication:

- *Date and time* of the TCR's printout
- *Remote location* called
- *Resolution mode*
- *Starting date and time*
- *Duration*, in minutes and seconds
- *Length*, in number of pages
- *Result* of the call
- *Any special operations* — For example, a fax call made using an optional handset will appear as "Manual"
- *Sample of the document* — An image of the first page of the document

If an error occurs, the TCR tells you the remote location which was called, the *error code* and *error message* (see pages 3.5–3.8).

RCR

The RCR lists the following information for each communication:

- *Date and time*
- *Remote location* called
- *Assigned number*, starting each day at 001
- *Resolution mode*
- *Duration*, in minutes and seconds
- *Length*, in number of pages
- *Result* of the call — Either "OK" or an *error code* (see pages 3.5–3.8)

To set the printing of one or both of these reports:

- 1 Press **▶/PROGRAM, G, 3, ENTER**. The LCD shows:

```
TCR Selected
Program/Enter
```

- 2 Press **◀** or **▶/PROGRAM** until the setting you want appears. Here, we've chosen *RCR*.

```
RCR Selected
Program/Enter
```

- 3 Press **ENTER** to save the setting. The LCD shows:

```
Auto Print: Off
Program/Enter
```

Your machine is asking if it should print the selected report automatically after every fax you send.

- 4 Press **◀** or **▶/PROGRAM** until the setting you want appears. Here, we've chosen *On*.

```
Auto Print: On
Program/Enter
```

- 5 Press **ENTER** to save the setting.

To turn the confirmation report feature on or off for *only* the next fax transmission, press **REPORT**.

What happens next depends on the setting you chose:

- If the light next to the **REPORT** key glows, the fax machine will print the confirmation report automatically.
- If the light next to the **REPORT** key doesn't glow, the fax machine will not print a confirmation report.

After you send this transmission, your machine returns to the setting you chose in step 2, above.

Quick Memory transmission

Using Quick Memory transmission can save you time over standard memory transmissions.

For a *normal memory transmission*, your fax: **(1)** scans your entire document into memory, **(2)** dials the other fax machine, then **(3)** transmits the document.

But with *Quick Memory transmission*, your machine doesn't wait to scan all pages into memory before dialling. After it scans the first page of your document, your machine dials the call. While dialling, connecting and transmitting, your fax machine continues to scan in the remaining pages of the document.

You can set your fax to always use Quick Memory transmission as the default.

Important: Your fax machine's memory transmission feature must be turned on to use Quick Memory transmission (see page 1.13).

To make Quick Memory transmission the default:

- 1 Press **▶/PROGRAM, J, 2, 1, ENTER**. The LCD shows:

```
Quick Tx:      On
              Program/Enter
```

- 2 Press **◀** or **▶/PROGRAM** until the mode you want appears. Here, we've chosen *Off*

```
Quick Tx:      Off
              Program/Enter
```

- 3 Press **ENTER** to save the setting.

Polling

Polling allows someone to fax a document to you *without* having to make the call or pay for it. There are several kinds of polling:

- Regular polling — Your fax retrieves a document from a remote fax machine.
- F-Code polling — Your fax retrieves a document stored as a file in the remote fax machine. To do this, you must be communicating with another F-code-compatible fax machine. For more information on F-Code polling, see "F-Code communication," pages 2.35–2.44.
- Continuous polling — Your fax continuously retrieves a document from any remote fax machine at a designated time. For example, a hospital pharmacy can use this to check on orders waiting in fax machines throughout the hospital.

For polling to work, the remote machine must also be set up to *be polled*. See the remote machine's operating instructions, if necessary.

Regular polling

To set up your machine for regular polling:

- 1 Make sure the document is inserted in the *remote* fax machine.
- 2 Press **COM-OPTIONS** *twice* and then press **ENTER**. The LCD shows:

```
Enter Fax Number
—
```
- 3 Enter the remote fax machine's number by either pressing a one-touch key, entering a speed-dial number or using the numeric keypad.
- 4 To perform the regular polling *now*, skip to step 8. To perform *delayed* regular polling, go on to step 5.
- 5 Press **COM-OPTIONS, ENTER**. The LCD shows:

```
Delayed
Enter Time: 15/17:05
```
- 6 Use the numeric keypad to enter the date and time (use the *24-hour format*) when your machine should perform the delayed regular polling.
- 7 Press **ENTER**.
- 8 Press **START**.

When your machine polls for documents, it dials the number and, upon making contact with the other machine, begins receiving the document as if the other machine had placed the call.

Continuous polling

To set up your machine for continuous polling:

- 1 Press **COM-OPTIONS** four times and then press **ENTER**. The LCD shows the current time:

```
Cont Polling
Start Time:  18:30
```

- 2 Use the numeric keypad to enter the time your machine should *begin* the continuous polling. (Use the *24-hour format*.) Here, we've set it for 7:00 AM.

```
Cont Polling
Start Time:  07:00
```

Note: Press ◀ to move the cursor left, or ▶/**PROGRAM** to move it right.

- 3 When the start time is set, press **ENTER** to save it. The LCD shows:

```
Cont Polling
End Time:    07:00
```

- 4 Use the numeric keypad to enter the time when your machine should *finish* the continuous polling. (Use the *24-hour format*.) Here, we've set it for 3:00 PM.

```
Cont Polling
End Time:    15:00
```

Note: If you set the end time *earlier* than the start time, the polling operation will continue until the selected end time *tomorrow*.

Note: Press ◀ to move the cursor left, or ▶/**PROGRAM** to move it right.

- 5 When the end time is set, press **ENTER** to save it. The LCD shows:

```
Enter Fax Number
—
```

- 6 Enter the remote fax machine's number by either pressing a one-touch key, entering a speed-dial number or using the numeric keypad.

If you are entering only one number for continuous polling, skip to step 8. To add additional fax numbers for this operation, go on to step 7.

- 7 To add additional fax numbers, press **BROADCAST** between each one to insert a *comma* then enter the number as in step 6. You can specify up to 30 numbers (and/or call groups) for continuous polling.

```
Press Start
[03],9-5551204,s118,
```

Important: Do **not** insert a comma after the last fax number.

Note: If you enter characters by mistake, press **CANCEL** to clear them.

- 8 Press **START**.

When your machine polls for documents, it dials each number and, upon making contact with the other machine, begins receiving the document as if the other machine had placed the call. It will continue the process throughout the time period you selected in steps 2–5.

Note: When you want to end a continuous polling operation, you must delete it using the Review Commands feature (see page 2.18).

Being polled

Not only can you poll, but you can also *be* polled. To set up a document for regular polling:

- 1 If your fax machine is set for Tel Ready reception, press **AUTO ANSWER** to change it to the Auto Answer mode. The Auto Answer light will glow.

Important: Your machine **can't** be polled if it's in Tel Ready mode.

- 2 Insert the document.

- 3 Adjust resolution and contrast if necessary. (Your fax machine will be transmitting to the machine doing the polling.)

- 4 Press ▶/**PROGRAM, D, 1, ENTER**.
Your fax will scan the document into memory and return to standby mode.

Note: If you want to return to the "Tel Ready" mode after the remote machine has polled your document, press **AUTO ANSWER**. The Auto Answer light on the control panel will turn off. **But do this *only* after you're sure the remote machine has polled your document.**

Once the remote fax machine polls the document you stored, your fax machine automatically erases the document from memory.

Printing a stored polling document

To print a document you've stored for regular polling *without erasing* it, press ►/PROGRAM, D, 3, ENTER.

Erasing a stored polling document

To erase a document you've stored for regular polling from your machine's memory, press ►/PROGRAM, D, 2, ENTER.

Limiting polling access to your fax machine

Your machine's *closed network* setting (see page 2.64) works for polling, also. If a calling fax doesn't "present" the proper passcode, it cannot poll from your fax.

Note: If you're using the Block Junk Fax feature (see pages 2.64–2.65), even incoming calls which meet the passcode test must come from phone numbers you've approved.

Call request

You can send or receive a fax message *and* have a regular phone conversation *on the same call* (although, not at the same time). This is called a *call request*. It doesn't matter whether you're sending the fax or receiving it. You may fax first and then talk, or talk first and then fax.

Important: For this feature to work, the remote fax machine must have a similar call-request capability. Your machine must also have an optional handset attached.

Note: Communicating this way disables "V.34" mode, causing the fax machine to handle the call in normal ITU-T Group 3 fashion. See page 3.18 for more information.

Faxing/receiving first, then talking

To send or receive a fax first and then talk:

- 1** While your fax machine is sending or receiving the fax, press MONITOR/CALL.
- 2** At the remote fax machine, the ringer will sound after that machine receives each page.
- 3** If someone answers at the remote fax machine, your fax machine will ring several times. If so, pick up the optional handset. In a few seconds, the line will open and you can begin your conversation.

Talking first, then *sending* a fax

To talk first and then send a fax:

- 1** When you've finished your phone conversation, *don't hang up*.
- 2** Insert the document you want to fax.
- 3** Adjust the resolution and contrast if necessary.
- 4** Tell the person at the other fax machine to press START and to hang up his/her handset. *Don't hang up your handset yet!*
- 5** When you hear fax tones, press START and hang up your fax machine's optional handset. Your fax machine will send the document.

Talking first, then *receiving* a fax

To talk first and then receive a fax:

- 1 When you've finished your phone conversation, *don't hang up*.
- 2 Tell the person at the other fax machine to press **START** and to hang up his/her handset. *Don't hang up your handset yet!*
- 3 When you hear fax tones, press **START** and hang up your machine's optional handset. Your machine will receive the document and print it out.

Responding to a call request

If someone requests a call *from* you during a fax communication, you'll hear a long ring after the receiving machine has received each page. To answer the call request:

- 1 Lift your machine's optional handset, and listen for a few seconds. You may hear a brief series of fax tones.
- 2 Shortly, the line will open and the person at the other end of the line will answer. You and the other person now can have a normal phone conversation.

Numbering pages

Just before sending a fax, you can set your fax machine to number each page. This will help the person receiving the fax to keep track of all the pages.

To set up page numbering:

- 1 Count the number of pages in your document.
- 2 Insert the document.
- 3 Adjust the resolution and contrast, if necessary.
- 4 If you want to toggle between a manual transmission or memory transmission, press **MEMORY TRANSMIT**.
- 5 Press **▶/PROGRAM, L, ENTER**. The LCD shows:

Enter # Of Pages
(01-50) : 01

- 6 Use the numeric keypad to enter the number of pages in your document. If there are fewer than 10 pages, enter a leading zero and then the number (*For example: 04 for four pages*).

- 7 Press **ENTER**.

Enter Fax Number
_

From here, continue sending the document using whatever type of transmission you need (broadcast, group dial, etc.). When the remote fax machine prints the document, a note on the right side of your TTI will indicate the number of the page — such as “P.02” for page two.

The power of Multi access

Your fax machine's *multi access* feature sharply reduces the time you might spend waiting for the machine to finish its work. Multi access is a more powerful version of what already is a pretty powerful feature, called *dual access*. While a fax with normal dual access allows you to do two things at once, multi access allows you to do *four* operations at once. *For example*, even if the machine is (1) printing a copy, (2) transmitting from memory and (3) scanning documents for a different memory transmission, you can still (4) program the machine.

Audible alarm

Whenever your fax machine receives a document from another fax machine, your machine will sound the alarm tone alerting the person for whom the document is intended.

Important: The alarm tone is sounding until either the person presses **STOP** or another document is received.

Note: Your machine does not sound the alarm during:

- Polling
- Call request
- F-Code reception
- Turning off this feature

To toggle this audible alarm feature on or off:

1 Press **PROGRAM, J, 2, 2, ENTER**.

```
Audible Alarm: Off
Program/Enter
```

If the setting you see is acceptable, skip to step 3. Otherwise, proceed to step 2.

2 To change the setting, press **PROGRAM** once or twice until your desired choice appears. Here, we've chosen *On*.

```
Audible Alarm: On
Program/Enter
```

3 Press **ENTER** to save the setting.

Using alternative telephone network service providers

Your fax machine is fitted with a Soft Key on the control panel to allow easy access to other telephone networks such as Cable & Wireless (Mercury) for the U.K.

Important: For this feature to work, you must have assigned the function of *access to alternative telephone network* to one Soft Key as described on page 2.24.

The following information describes how to program the Soft Key for the Cable & Wireless (Mercury). For other networks you will have to program the appropriate access number in place of the Mercury access number. You can enter the number up to 40 digits.

1 Press **PROGRAM, J, 2, 3, ENTER**.

```
Dial Prefix No    00
_
```

2 Enter the Mercury access number on the numeric keypad. In this example, we've entered 131 (Mercury PIN code service). If you entered 132 (residential 132 service), skip to step 5.

Note: If you wish to access the Mercury network from a PBX, enter the PSTN access code followed by a dialling pause (the dialling pause is only necessary on pulse dial PBX's) before you enter the 131 or 132. *i.e.*, 9-/131-/PIN, or 9-/132 if a pause is required.

```
Dial Prefix No
131_
```

3 Press **REDIAL/PAUSE** on the control panel to enter a **"-/"** in the LCD. This instructs your fax machine to wait for a Mercury dial tone before dialling the PIN number.

```
Dial Prefix No
131-/_
```

4 Now enter your PIN number (10 digits).

```
Dial Prefix No
131-/1234567890_
```

Note: If you wish to erase your PIN number, press **CANCEL** to erase all programmed numbers before proceeding to step 5.

5 Press **ENTER** to save the setting.

To dial a number via an alternative telephone network service

Pick up the optional telephone handset or press **MONITOR/CALL** to hear the dial tone. Press the Soft Key on the control panel, then the LCD will show a "!" symbol to indicate the access to the service.

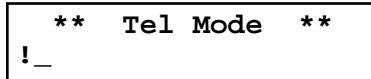

!! Tel Mode !!
!_

Dial a cost centre code (2 or 3 digits) if you selected this option when ordering Mercury service. Enter the telephone number on the numeric keypad.

Notes:

- You must enter the full National Code telephone number when dialling telephone numbers via the Mercury network.
- Your fax machine will not display your Mercury PIN number when dialling, or sound it through the monitor speaker, this is a Mercury requirement.
- You can not enter the Soft Key followed by the one-touch or speed-dial key (see below for more information).

To dial using the one-touch or speed-dial keys

You must instruct your fax machine to access the alternative telephone network when you store the telephone number into your autodialler. At first, press the Soft Key that you programmed for access to the alternative telephone network service, and then enter the telephone number.

F-Code communication

F-Code: an introduction

The ITU-T, part of the United Nations agency that standardizes international telecommunications, has created a fax industry standard for using sub-addressing and password-based communications. One name for this standard is F-Code, and that's what we'll call it in these instructions and on your machine's display.

How sub-addressing works

To help understand sub-addressing, think about how someone in a large company receives mail. For example, mail for the Accounting department is first delivered to the company's main mailroom. Then the mailroom routes the mail to Accounting.

That's the idea behind sub-addressing. Your fax and another F-Code-compatible fax exchange special signals to indicate just where the fax really should go. It's as if the sending fax is saying, "Deliver this to room 48," and the receiving fax does just that.

Your machine has up to 50 mailboxes for these special deliveries. When someone sends an F-Code fax to you, your machine receives it into one of those 50 mailboxes — whichever box the sender chooses.

Sending F-Code securely

For greater security, you can set up a password with each F-Code sub-address, which lets you use secure transmission, polling and relay broadcasting when communicating with any other F-Code compatible fax machine.

Guidelines for using F-Code

- (1) To use ITU-T sub-addressing, you must create F-Code boxes in your machine
- (2) Your machine holds up to 50 of these boxes
- (3) Your machine stores up to 30 documents into each F-Code box (each document can include one or more pages)

Creating or modifying an F-Code box

Choosing the F-Code box type

Before you set up an F-Code box, first decide how your callers will use it — as a bulletin box, a security box or a relay box.

- **Bulletin box** — Stores documents that people in remote locations retrieve by *polling* the box. For example, your sales branches could call in at any time to get a printout of your latest prices that you've stored in a bulletin box.
A bulletin box stores both scanned and retrieved documents, and it holds its contents indefinitely (as long as the unit has AC power).
- **Security box** — Receives and stores F-Code secure communications.
- **Relay box** — Receives documents, then relays them to other machines. The machine that relays the document is called a "hub". Your fax machine can *be* a hub.

4 elements of an F-Code box

Each F-Code box has the following four elements:

- (1) F-Code box number (*01-50*)
- (2) F-Code box name (up to 16 characters)
- (3) F-Code sub-address (up to 20 characters - can include numbers and the * and # characters only)
- (4) I.D. Code (4 digits)

You will choose the information for each of these elements, and enter it into your machine. The following steps will walk you through entering and changing that information.

To create or modify an F-Code box:

1 Keep pen and paper with you as you follow these steps. As you decide on a sub-address and enter it into your machine, write it down. Remember to: **(1)** write down which box goes with which sub-address, **(2)** write down any passwords or I.D. codes you enter, **(3)** keep these printed records in a safe place.

2 Press **▶/PROGRAM, P, 1, ENTER**. Depending on whether you already have a name entered for F-Code box *01*, the LCD shows:

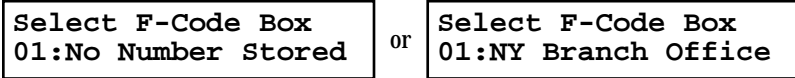

3 Use the numeric keypad to enter the two-digit number (*01-50*) of the F-Code box you want to create or modify. Here, we've entered **0, 3** and see either:

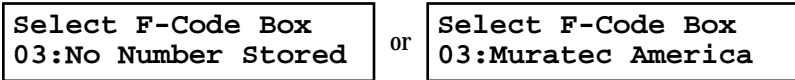

4 If want to select a different F-Code box than the one that appears on the LCD, use the numeric keypad to enter the two-digit F-Code box number now.

5 Press **ENTER**. What you do next depends on whether you're creating or modifying the F-Code box:
If creating — skip to step 7.
If modifying — the LCD asks you to enter the proper I.D. code. The LCD shows:

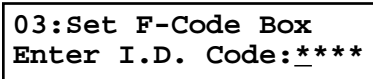

6 Use the numeric keypad to enter the 4-digit I.D. code (not the ITU-T sub-address and not the ITU-T password) and then press **ENTER**.

Note: If you enter an invalid I.D. code, the fax machine rejects the attempt and aborts this operation.

7 The machine is now asking you to name this F-Code box. The LCD shows:

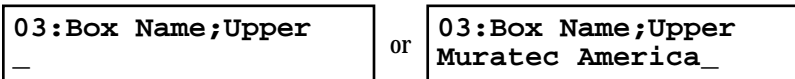

If you do not want to enter or change this F-Code box's name, skip to step 9. If you do want to enter or change this F-Code box's name, go on to step 8.

8 Enter the name the same way you entered your fax name during EasyStart. An F-Code box's name can be up to 16 characters in length.

Important: As in EasyStart, enter letters and other non-numeric characters through the one-touch keys.

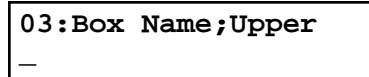

The word "Upper" means the machine is currently set for entering only upper-case letters. If you press R, the machine will see it as an *R* (not an *r*).

To enter a lower-case letter, press **ALPHABET**. The display changes to:

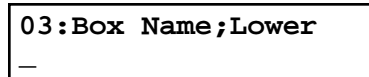

This means pressing one-touch keys will enter lower-case letters. For example, pressing R, will produce an *r* (not an *R*) on the display.

To switch back for upper-case entries, press **ALPHABET**.

Use the one-touch keypad to enter spaces, punctuation and symbols.

You can also use the **CODE** function to enter characters. Please review the explanation on page 2.2.

Note: To erase characters, press **CANCEL** to erase to the left. To change just one character in the name, press **◀** to move the cursor left, or **▶/PROGRAM** to move it right. Press **CANCEL** to erase the character. Then re-enter the name correctly.

9 Press **ENTER** to save the box's name and continue. The LCD shows:

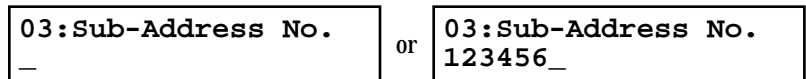

The fax machine now asks for this F-Code box's sub-address. This is the numerical identifier you must enter in order to communicate with any remote F-Code compatible fax.

If you do not want to change an existing sub-address, skip to step 11.

10 Use the numeric keypad to enter the sub-address to identify this F-Code box. The sub-address can be up to 20 characters in length and include any combination of numbers and the * and # characters (but no other non-numeric characters).

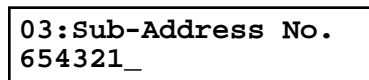

Note: No other F-Code box in this machine can have the same sub-address as the one you enter here.

Note: To erase characters, press CANCEL to erase to the left. To change just one number, press ◀ to move the cursor left, or ▶/PROGRAM to move it right. Press CANCEL to erase the character. Then re-enter the number correctly.

11 Press ENTER to save the sub-address.

Note: If you entered a sub-address already being used by another F-Code box, the machine beeps and briefly displays:

```
03:Enter Sub-Address
Sub-Address In Use
```

The machine now returns you to step 10. Please enter a different number for your F-Code box's sub-address.

12 Next, the machine asks for your F-Code box's password. This is the password for ITU-T-compatible F-Code fax transactions. The LCD shows:

```
03:Password      or      03:Password
_                123456789*#_
```

Note: You don't need to have a password for the F-Code box. However, using a password will make your F-Code communication much more secure.

If you *do not* want to enter or change this box's password, skip to step 14.

13 Use the numeric keypad to enter this box's ITU-T-compatible password. This password can be up to 20 characters in length and include any combination of numbers and the * and # characters (but no other non-numerical characters). Here, we've entered 135*7#9.

```
03:Password
135*7#9_
```

Note: To erase characters, press CANCEL to erase to the left. To change just one character in the password, press ◀ to move the cursor left, or ▶/PROGRAM to move it right. Press CANCEL to erase the character. Then re-enter the password correctly.

Note: You cannot change the *type* of an existing F-Code box. If you're modifying an existing F-Code box and want to change the box *type*, you first must erase the old box, then create a new one.

14 Press ENTER to save the password. The LCD now shows:

```
Box Type:  Bulletin
           Program/Enter
```

The fax machine is asking which box type you want to assign to this box — *bulletin*, *security* or *relay*.

Press ◀ or ▶/PROGRAM until the type of box you want appears.

15 Press ENTER.
If you chose *Bulletin*, go on to step 16.
If you chose *Security*, skip to step 17.
If you chose *Relay*, skip to step 20.

If you chose Bulletin:

16 The bulletin box has four additional settings:

- Reception protection ("Rx Protect" on the LCD)
- Automatic printing of received documents ("Auto Print")
- Overwriting documents ("Overwrite Doc.")
- Erasure of transmitted documents ("Erase Tx Doc.")

Rx Protect — *Reception protection* tells this box if it's okay to receive documents from remote locations. Callers can then poll these documents.

```
Rx Protect:      Off
                Program/Enter
```

On: *Open* this box to receive documents from callers.

Off: *Do not* open this box to receive documents from callers.

Press ◀ or ▶/PROGRAM until the mode you want appears. Then press ENTER to save the setting and go on to the next one.

Auto Print — *Automatic printing of received documents* tells the fax machine if it should print a document automatically upon receiving it into this box.

Note: This setting is available only when the reception protection setting is set to *off* (see above).

```
Auto Print:      Off
                Program/Enter
```

On: Print the document automatically when the box receives it.

Off: Print the document manually, when you want to print it.

Press ◀ or ▶/PROGRAM until the mode you want appears. Then press ENTER to save the setting and go on to the next one.

Overwrite Doc — *Overwriting documents* tells your machine if it should overwrite (erase) existing documents when it receives a new one.

Note: This setting is available only when the reception protection setting is set to off (see *Rx Protect* on page 2.37).

```
Overwrite Doc.: Off
Program/Enter
```

On: When your machine receives a new document into this box, it will erase any documents currently stored in it.

Off: When your machine receives a new document into this box, it *will not* erase the documents stored in it. Your machine can store up to 30 documents (each document can include one or more pages) in each box.

Press ◀ or ▶/PROGRAM until the mode you want appears.
Then press ENTER to save the setting and go on to the next one.

Erase Tx Doc — *Erasure of transmitted documents* tells your machine if it should erase a document from the box after a caller retrieves (polls) the document.

```
Erase Tx Doc.: Off
Program/Enter
```

On: Your machine erases the document from the box as soon as it sends it. If you choose “On”, this box can be polled only once per document.

Off: Your machine does not erase a document from the box when it’s polled. As long as your machine holds AC power and you do not erase the document from the box, the document is available indefinitely for polling.

Press ◀ or ▶/PROGRAM until the mode you want appears.
Press ENTER to save the setting. Then skip to step 24.

If you chose Security:

17 The machine asks how long you want to keep a document stored in your machine’s F-Code box. The LCD shows:

```
F-Code Doc Hold Time
Hold Time(00-31): 00
```

18 Use the numeric keypad to enter a two-digit number indicating how many days (00-31), you want your fax machine to keep received documents in this F-Code box. Here, we’ve entered 09, for nine days:

```
F-Code Doc Hold Time
Hold Time(00-31) :09
```

Note: Your fax machine can store incoming documents in F-Code boxes (up to 30 documents) as long as 31 days, after which it automatically erases the documents. But if your machine has plenty of memory, you may want to override the 31-day limit in order to keep the documents indefinitely. If so, enter 00. If you choose this, you will have to delete documents manually. (You may want to contact your authorised Muratec dealer regarding optional memory expansion.)

19 Press ENTER to save the settings. Skip to step 24.

If you chose Relay:

20 The machine asks for the fax number of remote unit.
The LCD shows:

```
Enter Relay Number
_
```

21 Enter the fax number using a one-touch key, a speed-dial number or a call group number. You cannot use the numeric keypad to enter these numbers.

To add each fax number, press BROADCAST between each one to insert a comma, then enter the number. You can specify up to 200 numbers for a remote “hub” unit.

```
Enter Relay Number
S001,G12_
```

22 Press ENTER to save the settings. The LCD shows:

```
Select TTI: Sender
Program/Enter
```

The machine asks for the type of TTI you want to appear on the faxes that are relayed to other callers.

- **Sender** — Relay the document with sender unit’s TTI (*don’t send your TTI*).
- **Both** — Relay the document with both the sender unit’s TTI and your TTI.
- **Yours** — Relay the document with your TTI instead of the sender unit’s.

Press ◀ or ▶/PROGRAM until the mode you want appears.

23 Press **ENTER** to save the settings. The LCD shows:

```
Auto Print:      Off
Program/Enter
```

On: Print the document automatically when it's received.
Off: The machine does not print it, but only relays it to the other machine.

Press **◀** or **▶**/PROGRAM until the mode you want appears.
Then press **ENTER** to save the settings and go on to step 24.

24 The machine asks for your F-Code box's four-digit security I.D. code. This is the I.D. code for the box's security, which you use to **(1)** print a document any remote F-Code-compatible fax sends to this F-Code box or **(2)** you enter before you can make any changes to this F-Code box.

```
03:Set F-Code Box
Enter I.D. Code:0000
```

If you do not want to change the I.D. code, skip to step 27.

25 Decide on a four-digit I.D. code (0001-9999) for this F-Code box.
Write it down, and put it in a safe place.

Important: Do not use 0000 as an I.D. code.

26 Use the numeric keypad to enter the four-digit I.D. code for this F-Code box.
Important: After completing this step, you must know this code to print documents sent to this F-Code box. Be sure to write it down.

27 Press **ENTER** to save the F-Code box information.

To create or modify another F-Code box, repeat steps 3-27.
To finish, press **STOP**.

Printing a list of F-Code boxes

The list of F-Code boxes includes:

- (1) Each box's identifier number
- (2) Box name (if any)
- (3) Sub-address
- (4) Password
- (5) Box type
- (6) Each box's settings

To print a list of your F-Code boxes, press **▶**/PROGRAM, P, 2, **ENTER**.

Printing a list of documents stored in your F-Code boxes

The list of documents stored in your machine's F-Code boxes includes:

- (1) Each box's identifier number
- (2) Box name (if any)
- (3) Box type
- (4) Each file number (or document number) that is stored

To print a list of documents stored in F-Code boxes, press **▶**/PROGRAM, P, 3, **ENTER**.

Using a bulletin box

Storing a document

Your fax machine can store up to 30 *documents* in each bulletin box.

Note: For this operation to work, two things must be true:

- The bulletin box must exist on your fax machine.
- You must know the bulletin box's two-digit number (01-50) and four-digit I.D. code. (See "Creating or Modifying an F-Code box", if necessary.)

To store a document in a bulletin box for polling.

- 1** Insert the document and make any necessary adjustments.
- 2** Press **▶**/PROGRAM, P, 7, **ENTER** The LCD shows:

```
Select F-Code Box
01:No Number Stored
```

OR

```
Select F-Code Box
01:Murata Machinery
```

- 3** Use the numeric keypad to enter the two-digit identifier number (01-50) of the F-Code box where you want to store the document.
Here, we've entered **0, 3**:

```
Select F-Code Box
03:Muratec America
```

- 4** If you want to use a different F-Code box than the one that appears on the LCD, enter the box number now.
- 5** Press **ENTER**. The LCD shows:

```
03:Set F-Code Doc.
Enter I.D. Code:****
```

- 6** Use the numeric keypad to enter the four-digit I.D. code. Here, we've entered *2345*:

```
03:Set F-Code Doc.  
Enter I.D. Code:2345
```

- 7** Press **ENTER**.
If you've entered an incorrect I.D. code, your fax machine rejects the attempt and returns to standby mode.
If you've entered the correct I.D. code, the display shows:

```
Overwrite Doc.: Off  
Program/Enter
```

If you choose:

On: Your bulletin box erases the currently stored document when a new document is stored in it

Off: Your bulletin box keeps both the currently stored document and the new document, up to 30 documents in each box.

- 8** Press **◀** or **▶**/PROGRAM until the mode you want appears.
- 9** Press **ENTER** to save the setting. Your machine starts scanning the document into the selected bulletin box:

```
F-Code Doc. File:1  
A4 Memory100%
```

Important: The file number (shown above as *1*) tells you how many documents are in this bulletin box. Your machine numbers files *1-30*. You need to know the file's number to erase or print it.

Printing a document stored in a bulletin box

You can print a document stored in your machine's F-Code bulletin boxes without erasing the document from memory.

To print a stored document:

- 1** Press **▶**/PROGRAM, **P**, **4**, **ENTER** The LCD shows:

```
Select F-Code Box  
01:Murata Machinery
```

- 2** Use the numeric keypad to enter the two-digit number (*01-50*) of the F-Code bulletin box that stores the document you want to print. We've entered *03*:

```
Select F-Code Box  
03:Muratec America
```

- 3** Press **ENTER**. The LCD shows:

```
03:Print F-Code Doc.  
Enter I.D. Code:****
```

- 4** Use the numeric keypad to enter your F-Code box's four-digit I.D. code. Here we've entered *2345*:

```
03:Print F-Code Doc.  
Enter I.D. Code:2345
```

- 5** Press **ENTER**.
If you've entered an incorrect I.D. code, your fax machine rejects the attempt and aborts this operation.
If you've entered the correct I.D. code, the display shows:

```
03:Print F-Code Doc.  
File No. —
```

- 6** Use the numeric keypad to enter the file number (*1-30*) of the document you want to print. Here we've entered *3*.

```
03:Print F-Code Doc.  
File No. 3_
```

Note: If you want to print *all* documents stored in the bulletin box, simply enter *0* (zero).

- 7** Press **ENTER**.
Your fax machine prints the chosen document(s), then returns to standby mode.

Note: If the F-Code box is not storing any documents, the machine briefly displays the following before returning to standby mode:

```
03:Print F-Code Doc.  
No Document Stored
```

Erasing a document stored in a bulletin box

To erase a stored document:

- 1** Press ►/PROGRAM, P, 6, ENTER The LCD shows:

```
Select F-Code Box
01:Murata Machinery
```

- 2** Use the numeric keypad to enter the two-digit number (01-50) of the F-Code bulletin box that stores the document you want to erase. We've entered 03:

```
Select F-Code Box
03:Muratec America
```

- 3** Press ENTER. The LCD shows:

```
03:Erase F-Code Doc.
Enter I.D. Code:****
```

Note: If the F-Code box is not storing any documents, the machine briefly displays the following before returning to step 2:

```
Select F-Code Box
No Document Stored
```

- 4** Use the numeric keypad to enter your F-Code box's four-digit I.D. code. Here we've entered 2345:

```
03:Erase F-Code Doc.
Enter I.D. Code:2345
```

- 5** Press ENTER.
If you've entered an incorrect I.D. code, your fax machine rejects the attempt and aborts this operation.
If you've entered the correct I.D. code, the display shows:

```
03:Erase F-Code Doc.
File No.      _
```

- 6** Use the numeric keypad to enter the file number (1-30) of the document you want to erase. Here we've entered 3.

```
03:Erase F-Code Doc.
File No.      3_
```

Note: If you want to erase *all* documents stored in the bulletin box, enter 0 (zero).

- 7** Press ENTER. The LCD shows:

```
03:Erase F-Code Doc.
Check      Stop/Enter
```

Note: If you want to quit without erasing *any* document in the bulletin box, press STOP. The machine will return to standby mode.

Note: If the F-Code box is not storing any documents, the machine briefly displays the following and then returns to standby mode:

```
03:Erase F-Code Doc.
No Document Stored
```

- 8** Press ENTER to erase the document(s) and to return to standby mode.

```
03:Erase F-Code Doc.
**      Complete      **
```

Using a security box

Printing a document you receive

When your fax machine receives a document via ITU-T sub-addressing to an F-Code security box, your machine prints a message to let you know. The message lists: (1) the F-Code box number that received the document, (2) the Box name, (3) the remote machine's TTI (if any), and (4) the file numbers stored in the F-Code box.

You then have a certain number of days (see page 2.38) in which to print out the document before your machine automatically erases it.

Note: For this operation to work, two things must be true:

- You must know the F-Code security box's two-digit number.
- You must know the F-Code security box's four-digit I.D. code.

To print a received message:

- 1** Press ►/PROGRAM, P, 4, ENTER The LCD shows:

```
Select F-Code Box
01:Murata Machinery
```

- 2** Use the numeric keypad to enter the two-digit number (01-50) of the F-Code security box that holds the documents you want to print. We've entered 03:

```
Select F-Code Box
03:Muratec America
```

- 3** Press ENTER. The LCD shows:

```
03:Print F-Code Doc.
Enter I.D. Code:****
```

- 4** Use the numeric keypad to enter your F-Code box's four-digit I.D. code. Here we've entered 2345:

```
03:Print F-Code Doc.
Enter I.D. Code:2345
```

- 5** Press ENTER.

- If you've entered the correct I.D. code, your fax machine prints all documents in the F-Code security box and then erases them.
- If you've entered an incorrect I.D. code, your fax machine aborts the operation and returns to standby mode.

Note: If the F-Code security box is not storing any documents, the machine briefly displays the following before returning to standby mode:

```
03:Print F-Code Doc.
No Document Stored
```

Using a relay box

Once your fax machine receives a document via ITU-T sub-addressing to one of its F-Code relay boxes, it sends it to the other fax machines that you've set up on your relay box. (See "Creating or Modifying an F-Code box", page 2.35)

If you set the Auto print mode to *on* when you created the relay box, your machine will *print* the received document, then relay it to the other machine. Otherwise, your machine will *only relay* it to the other machines, not print it. See page 2.39 for more details on this setting.

Also, you can send (*relay broadcast initiation*) the document to another hub machine's F-Code box and get that machine to relay it to others. See "F-Code transmission and polling" on page 2.43 for more detail.

The hub performs a *relay broadcast*, and the machine which sends the original document to the hub has performed a *relay broadcast initiation*.

Erasing an empty F-Code box

An F-Code box must be empty in order to erase it. (If you select an F-Code box in these steps which is not empty, the machine beeps. If this happens, print all documents in that box before erasing it.)

To erase an empty F-Code box:

- 1** Press ►/PROGRAM, P, 5, ENTER. The LCD shows:

```
Select F-Code Box 01:No Number Stored or Select F-Code Box 01:Murata Machinery
```

- 2** Use the numeric keypad to enter the two-digit identifier number (01-50) of the F-Code box you want to erase. Here, we've entered 0, 3 and see:

```
Select F-Code Box
03:Muratec America
```

- 3** If you want to erase a different F-Code box than the one that appears on the LCD, enter the box number now.

- 4** Press ENTER. If the F-Code box is empty, the LCD shows:

```
03:Erase F-Code Box
Enter I.D. Code:****
```

Important: If you select an F-Code box which is *not* empty, the machine beeps and, before returning to step 3, briefly displays:

```
Select F-Code Box
Box In Use
```

Print any documents received in the F-Code box, then repeat this procedure from the beginning to erase the box. Otherwise, select another F-Code box.

- 5** Use the numeric keypad to enter the four-digit I.D. code. Here, we've entered 2345:

```
03:Erase F-Code Box
Enter I.D. Code:2345
```

- 6** Press **ENTER**.
If you've entered an incorrect I.D. code, your fax machine rejects the attempt and returns to standby mode.
If you've entered the correct I.D. code, the display shows:

```
03: Erase F-Code Box
Check Program/Enter
```

Note: If you want to quit without erasing the F-Code box you've selected, press **▶/PROGRAM**. The fax will return to step 2.

Note: If you want to quit without erasing *any* F-Code box, press **STOP**. The machine returns to standby mode.

- 7** Press **ENTER** to erase the F-Code box.

```
03: Erase F-Code Box
** Complete **
```

To erase another F-Code box, repeat steps 2-7.
To finish, press **STOP**.

F-Code transmission and polling

With F-Code, your machine can send secure transmissions, perform relay broadcast initiations and even poll from other ITU-T-equipped machines, regardless of manufacturer.

You can do this two ways:

- Using the programmable one-touch key (see pages 2.52-2.55)
- Entering the ITU-T sub-address and password directly, which is what we'll describe here.

Note: For F-Code communication to work, three things must be true:

- The remote fax machine must support ITU-T sub-addressing
- The remote fax must have a mailbox with an ITU-T sub-address created on it
- You must know the ITU-T sub-address and password (if any) for the remote machine's mailbox

F-Code transmission

- 1** Insert the document.
- 2** Adjust the resolution and contrast if necessary.

- 3** If you want to toggle between manual transmission and memory transmission, press **MEMORY TRANSMIT**.

- 4** Press **COM-OPTIONS** five times and then press **ENTER**.

```
Enter Sub-Address
_
```

- 5** Use the numeric keypad to enter the appropriate sub-address in the remote machine. In this example, we've entered *123456*.

```
Enter Sub-Address
123456_
```

Note: If you make a mistake, press **CANCEL** to erase the character, then enter the correct number.

- 6** Press **ENTER**. The LCD shows:

```
Enter Password
_
```

Note: If this sub-address does not have a password, skip to step 8.

- 7** Use the numeric keypad to enter the password. In this example, we've entered *654321*.

```
Enter Password
654321_
```

- 8** Press **ENTER**. The LCD shows:

```
Enter Fax Number
_
```

- 9** Enter the fax number either by pressing a one-touch key, entering a speed-dial number or dialling from the numeric keypad. Do **not** press **START**.

- 10** What you do now depends on when you want the transmission to begin.
- To have it begin *now*, skip to step 13.
 - To delay it, go on to step 11.

- 11** Press **COM-OPTIONS**, **ENTER**. The LCD shows:

```
Delayed
Enter Time: 15/17:05
```

- 12** Use the numeric keypad to enter the day and time when the transmission should begin, then press **ENTER**.

13 Press **START**.

If in step 10 you chose an immediate transmission, your fax machine begins dialling. If you chose a delayed command, the machine shows "Reserved" on the LCD, indicating that it has stored the command in memory and will complete it later.

F-Code polling

1 Press **COM-OPTIONS** six times and then press **ENTER**.

```
Enter Sub-Address
_
```

2 Use the numeric keypad to enter the appropriate sub-address. In this example, we've entered *123456*.

```
Enter Sub-Address
123456_
```

Note: If you make a mistake, press **CANCEL** to erase the character, then enter the correct number.

3 Press **ENTER**. The LCD shows:

```
Enter Password
_
```

Note: If this sub-address does not have a password, skip to step 5.

4 Use the numeric keypad to enter the password. In this example, we've entered *654321*.

```
Enter Password
654321_
```

5 Press **ENTER**. The LCD shows:

```
Enter Fax Number
_
```

6 Enter the fax number either by pressing a one-touch key, entering a speed-dial number or dialling from the numeric keypad. Do **not** press **START**.

7 What you do now depends upon when you want the polling to begin.

- To have it begin *now*, skip to step 10.
- To delay it, go on to step 8.

8 Press **COM-OPTIONS**, **ENTER**. The LCD shows:

```
Delayed
Enter Time: 15/17:05
```

9 Use the numeric keypad to enter the day and time when the polling should begin, then press **ENTER**.

10 Press **START**.

If in step 7 you chose an immediate polling, your fax machine begins dialling. If you chose a delayed command, the machine shows "Reserved" on the LCD, indicating that it has stored the command in memory and will complete it later.

Programmable one-touch keys

Using the power of programmable one-touch keys

In order to complete some operations on your machine, you may have to follow several steps and press several different buttons. But programming your machine's *one-touch keys* (65–72) can reduce those many steps to a simple press of a key.

You can “teach” the one-touch keys to carry out any of the following operations:

Communications functions:

- Delayed transmission (explained on pages 2.17–2.19)
- Broadcasting (pages 2.16)
- Regular polling (*not* continuous) (page 2.29)
- Batch transmission (pages 2.20–2.23)
- F-Code transmission (pages 2.43–2.44)
- F-Code polling (page 2.44)

Printouts:

- One-touch numbers list (pages 2.11)
- Speed-dial numbers list (pages 2.14)
- Programmable one-touch numbers list (pages 2.58)
- Soft Keys list (pages 2.24)
- Delayed commands list (pages 2.19)
- Activity journal (pages 2.27)
- Call group directory (pages 2.14)
- Settings list (pages 2.6)
- Blocked numbers list (pages 2.65)
- Sample cover page (pages 2.26)
- Department time list (pages 2.67)
- Batch box list (pages 2.21)
- List of stored batch documents (pages 2.22)
- List of F-Code boxes (pages 2.39)
- List of documents stored in F-Code boxes (pages 2.39)

Document storage:

- Regular polling documents (pages 2.29)
- F-Code polling documents (See “Using a bulletin box,” page 2.39)

To “teach” these keys, you tell the machine four simple things:

- **How** — The key you’re programming
- **Who** — The number(s) the machine should dial
- **What** — The operation it should perform
- **When** — The date(s) and time(s) when you want it to perform the operation

Programming a delayed transmission

To program a delayed transmission into a programmable one-touch key:

- 1 Press ►/PROGRAM, C, 1, ENTER. The LCD shows the first empty programmable one-touch number available:

```
Select Program No.
65:No Number Stored
```

Note: If a programmable one-touch number other than 65 appears on the LCD, it means that you have already entered a number for 65.

Note: To *erase* a programmable one-touch key, see page 2.58.

- 2 Press the key that you want to program or change. Here, we’ve selected 68.

```
Select Program No.
68:No Number Stored
```

Note: If you’re changing a previously stored command: If your previous command for this key was a for a delayed operation, and you want to keep this key programmed for a delayed operation, use these instructions to make changes. But if you want to assign this key to a completely different operation (to Broadcast, for example), then you must first erase the stored command before programming the new one.

- 3 If you want to select a different programmable one-touch key than what appears on the LCD, press that key now.

- 4** Press **ENTER**. The LCD asks for the type of operation you want to program into the programmable one-touch:

```
68:      Type: Comm.
      Program/Enter
```

Note: If you're changing a previously stored command, skip to step 7.

- 5** Press **►/PROGRAM** repeatedly until "*Comm.*" appears.

```
68:      Type: Comm.
      Program/Enter
```

- 6** Press **ENTER**. The LCD now shows either:

```
68:Fax#/Com-Options
_
```

or

```
68:Fax#/Com-Options
9-5558743_
```

- 7** Use the numeric keypad to enter the number *exactly* as your machine should dial it, including whatever codes your phone system requires. The number can be up to 40 characters in length:

```
68:Fax#/Com-Options
9-5550629_
```

Your display can show only 20 characters at a time. To view characters beyond those 20, press **◀** to scroll to the left or **►/PROGRAM** to scroll to the right.

Important: Do **not** press **ENTER**.

Note: To erase characters, press **CANCEL** to erase to the left. If you want to change just one character in the number, press **◀** to move the cursor left, or **►/PROGRAM** to move it right. Press **CANCEL** to erase it. Then re-enter the number correctly.

- 8** Now, *while you can still see the fax number on the LCD*, press **COM-OPTIONS**, **ENTER**. The LCD shows:

```
Delayed
Enter Time: 11/20:30
```

- 9** Next, tell your fax to carry out this delayed command one of these ways:

Option 1: Perform the command *once* at a certain time on a certain day of the month. (For example, "Do this at 5:05 PM on the 30th.") To select this option, use the numeric keypad to enter the date and time when the fax should perform the command:

```
Delayed
Enter Time: 30/17:05
```

Option 2: Perform the command at a certain time *each day you press the key*. (For example, "Do this at 5:05 PM today.") To select this option, use the numeric keypad to enter **0, 0** and then the time the fax should perform the command:

```
Delayed
Enter Time: 00/17:05
```

- 10** Press **ENTER**, **ENTER**. The LCD asks if you want to make additional settings for this programmable one-touch number.

```
68: Option: Off
      Program/Enter
```

If you *do not* want to make additional settings, press **ENTER**. Skip to step 26. If you *do* want to make additional settings, press **►/PROGRAM** and **ENTER**.

- 11** The LCD asks which resolution you want to use for this programmable one-touch number.

```
68: Primary: ---
      Program/Enter
```

- 12** Press **►/PROGRAM** until the mode you want appears.

Note: For any of the following settings, choosing "**---**" tells the machine to use its *default* setting for this programmable one-touch key.

- 13** Press **ENTER**. The LCD asks you to select a contrast mode for each programmable one-touch number.

```
68: Contrast: ---
      Program/Enter
```

- 14** Press ►/PROGRAM until the mode you want appears.
- 15** Press ENTER. The LCD asks if you want the confirmation stamp on or off when using this programmable one-touch number.

```
68: Stamp: ---
      Program/Enter
```

- 16** Press ►/PROGRAM until the mode you want appears.
- 17** Press ENTER. The LCD asks if you want the memory transmission on or off when using this programmable one-touch number.

```
68: Memory Tx: ---
      Program/Enter
```

- 18** Press ►/PROGRAM until the mode you want appears.
- 19** Press ENTER. The LCD asks you for the type of confirmation report you want to set for this programmable one-touch number.

```
68: Conf.Report: ---
      Program/Enter
```

- 20** Press ►/PROGRAM until the mode you want appears.
- 21** Press ENTER. The LCD asks if you want to send a cover page for this programmable one-touch number.

```
68: Cover Page: ---
      Program/Enter
```

- 22** Press ►/PROGRAM until the mode you want appears.
- 23** Press ENTER. The LCD asks if you want to turn the Copy & Fax feature on or off for this programmable one-touch number.

```
68: Copy&Fax: ---
      Program/Enter
```

- 24** Press ►/PROGRAM until the mode you want appears.
- 25** Press ENTER.

- 26** The LCD now displays the next programmable one-touch key.
If you *do not* want to enter or change *any other* key's programming, press STOP. Your machine returns to standby mode.
If you *do* want to enter or change this key's programming, go back to step 4.
If you want to enter or change *another* key's programming, go back to step 2.

Programming a broadcast / group

Programming a broadcast is very similar to programming a delayed transmission. But instead of sending to just one phone number, you set up multiple numbers for the transmission.

To program a broadcast / group into a programmable one-touch key:

- 1** Press ►/PROGRAM, **C**, **1**, ENTER. The LCD shows the first empty programmable one-touch number available:

```
Select Program No.
65:No Number Stored
```

Note: If a programmable one-touch number other than **65** appears on the LCD, it means that you have already entered a number for **65**.

Note: To *erase* a programmable one-touch key, see page 2.58.

- 2** Press the key you want to program or change. Here, we've selected **66**.

```
Select Program No.
66:No Number Stored
```

Note: If your previous command for this key was for a broadcast / group transmission and you want to keep this key programmed for a broadcast / group transmission, use these instructions to make changes. But if you want to assign this key to a completely different operation (for a delayed transmission, for example), then you first must erase the stored command before programming the new one.

- 3** If you want to select a different programmable one-touch key than the one that appears on the LCD, press that key now.
- 4** Press ENTER. The LCD asks for the type of operation you want to program into the one-touch:

```
66:      Type: Comm.
      Program/Enter
```

Note: If changing a previously stored command, skip to step 7.

- 5** Press ►/PROGRAM until "Comm." appears.

```
66:      Type: Comm.
      Program/Enter
```

- 6** Press ENTER. The LCD now shows either

```
66:Fax#/Com-Options
_
or
66:Fax#/Com-Options
9-5558743_
```

7 Use the numeric keypad to enter up to 230 fax numbers — you can use any combination of call groups, one-touch keys, speed-dial numbers and manually-dialled numbers.

Important: Do not press ENTER.

Press BROADCAST to enter a comma between each number or call group.

Important: Do not insert a comma after the last number.

To enter a *speed-dial number*, press SPEED DIAL/TEL INDEX and the number's three-digit identifier.

To enter a *call group*, press GROUP DIAL and the group's identifier number.

```
66:Fax#/Com-Options
G5,G7,[01],S006,9-55
```

Your display can show only 20 characters at a time. To view characters beyond those 20, press ◀ to scroll to the left or ▶/PROGRAM to scroll to the right.

Note: To erase characters, press CANCEL to erase to the left. To change just one character in the number, press ◀ to move the cursor left, or ▶/PROGRAM to move it right. Press CANCEL to erase it. Then re-enter until the number correctly.

8 If you want the broadcast to begin *immediately* every time you press the key, press ENTER and skip to step 11. If you want to *delay* the broadcast, press COM-OPTIONS, ENTER.

9 Next, tell your fax to carry out this delayed command one of these ways:

Option 1: Perform the command *once* at a certain time on a certain day of the month. (For example, "Do this at 5:05 PM on the 30th.") To select this option, use the numeric keypad to enter the date and time when the fax should perform the command:

```
Delayed
Enter Time: 30/17:05
```

Option 2: Perform the command at a certain time *each day you press the key*. (For example, "Do this at 5:05 PM today.") To select this option, use the numeric keypad to enter 0, 0 and then the time the fax should perform the command:

```
Delayed
Enter Time: 00/17:05
```

10 Press ENTER, ENTER.

11 The LCD asks if you want to program additional settings for this one-touch.

```
66: Option: Off
Program/Enter
```

If you *do not* want to program additional settings, press ENTER. Then skip to step 25.

If you *do* want to program additional settings, press ▶/PROGRAM and ENTER.

12 The LCD asks which resolution you want to set for this one-touch number.

```
66: Primary: ---
Program/Enter
```

13 Press ▶/PROGRAM until the mode you want appears.

Note: For any of the following settings, choosing "---" tells the machine to use its *default* setting for this one-touch key.

14 Press ENTER. The LCD asks you to select a contrast mode for this programmable one-touch number.

```
66: Contrast: ---
Program/Enter
```

15 Press ▶/PROGRAM until the mode you want appears.

16 Press ENTER. The LCD asks is you want the confirmation stamp on or off for this programmable one-touch number.

```
66: Stamp: ---
Program/Enter
```

17 Press ▶/PROGRAM until the mode you want appears.

18 Press ENTER. The LCD asks you for the type of confirmation report you want to set for this programmable one-touch number.

```
66: Conf.Report: ---
Program/Enter
```

19 Press ▶/PROGRAM until the mode you want appears.

20 Press ENTER. The LCD asks if you want to send a cover page for this programmable one-touch number.

```
66: Cover Page: ---
Program/Enter
```

21 Press ▶/PROGRAM until the mode you want appears.

- 22** Press **ENTER**. The LCD asks if you want to turn the Copy & Fax feature on or off for this programmable one-touch number.

```
66: Copy&Fax: ---
      Program/Enter
```

- 23** Press **►/PROGRAM** until the mode you want appears.

- 24** Press **ENTER**.

- 25** The LCD now displays the next programmable one-touch key. If you *do not* want to enter or change *any other* key's programming, press **STOP**. Your machine returns to standby mode. If you *do* want to enter or change this key's programming, go back to step 4. If you want to enter or change *another* key's programming, go back to step 2.

Programming regular polling

Note: You cannot program *continuous* polling into a programmable one-touch key. For more information on continuous polling, see page 2.30.

To program a regular polling operation into a programmable one-touch key:

- 1** Press **►/PROGRAM, C, 1, ENTER**. The LCD shows an empty programmable one-touch number:

```
Select Program No.
65:No Number Stored
```

Note: If a programmable one-touch number other than **65** appears on the LCD, it means that you have already entered a number for **65**.

Note: To *erase* a programmable one-touch key, see page 2.58.

- 2** Press the key that you want to program or change. Here, we've selected **72**.

```
Select Program No.
72:No Number Stored
```

Note: If your previous command for this key was for a polling transmission and you want to keep this key programmed for a polling transmission, use these instructions to make changes. But if you want to assign this key to a completely different operation (for a delayed transmission, for example), then you first must erase the stored command before programming the new one.

- 3** If you want to select a different programmable one-touch key than the one that appears on the LCD, press that key now.

- 4** Press **ENTER**. The LCD asks for the type of operation you want to program into the programmable one-touch:

```
72:      Type: Comm.
      Program/Enter
```

Note: If changing a previously stored command, skip to step 7.

- 5** Press **►/PROGRAM** until "*Comm.*" appears.

```
72:      Type: Comm.
      Program/Enter
```

- 6** Press **ENTER**. The LCD now shows either:

```
72:Fax#/Com-Options  or  72:Fax#/Com-Options
_                          9-5558743_
```

- 7** Use the numeric keypad to enter the number *exactly* as your machine should dial it, including whatever codes your phone system requires. The number can be up to 40 characters in length:

```
72:Fax#/Com-Options
9-5550696_
```

Your display shows only 20 characters at a time. To view characters beyond those 20, press **◀** to scroll to the left or **►/PROGRAM** to scroll to the right.

Important: Do **not** press **ENTER**.

Note: To erase characters, press **CANCEL** to erase to the left. To change just one character in the number, press **◀** to move the cursor left, or **►/PROGRAM** to move it right. Press **CANCEL** to erase it. Then re-enter the number correctly.

- 8** Next, *while you can still see the fax number on the LCD*, press **COM-OPTIONS** *twice* and then press **ENTER**.

- 9** If you want the polling to begin *immediately* every time you press the key, press **ENTER** and skip to step 12. If you want to *delay* the polling, press **COM-OPTIONS, ENTER**.

10 Next, tell your fax to carry out this delayed command one of these ways:

Option 1: Perform the command *once* at a certain time on a certain day of the month. (For example, "Do this at 5:05 PM on the 30th.") To select this option, use the numeric keypad to enter the date and time when the fax should perform the command:

```
Delayed
Enter Time: 30/17:05
```

Option 2: Perform the command at a certain time *each day you press the key*. (For example, "Do this at 5:05 PM today.") To select this option, use the numeric keypad to enter **0, 0** and then the time the fax should perform the command:

```
Delayed
Enter Time: 00/17:05
```

11 Press ENTER, ENTER.

12 The LCD now displays the next programmable one-touch key. If you *do not* want to enter or change *any other* key's programming, press STOP. Your machine returns to standby mode. If you *do* want to enter or change this key's programming, go back to step 4. If you want to enter or change *another* key's programming, go back to step 2.

Programming a batch transmission

For this operation to work, two things must be true:

- The batch box you're using must exist on your fax machine.
- You must know the batch box's identifier number (1- 5).

To program a batch transmission into a programmable one-touch key:

1 Press ►/PROGRAM, C, 1, ENTER. The LCD shows the first empty programmable one-touch number available:

```
Select Program No.
65:No Number Stored
```

Note: If a programmable one-touch number other than **65** appears on the LCD, it means that you have already entered a number for **65**.

Note: To *erase* a programmable one-touch key, refer to page 2.58.

2 Press the key that you want to program or change. Here, we've selected **67**.

```
Select Program No.
67:No Number Stored
```

Note: If your previous command for this key was for a batch transmission and you want to keep this key programmed for a batch transmission, use these instructions to make changes. But if you want to assign this key to a completely different operation (for a delayed transmission, for example), then you first must erase the stored command before programming the new one.

3 If you want to select a different programmable one-touch key than the one that appears on the LCD, press that key now.

4 Press ENTER. The LCD asks for the type of operation you want to program into the programmable one-touch:

```
67:      Type: Comm.
          Program/Enter
```

Note: If changing a previously stored command, skip to step 7.

5 Press ►/PROGRAM until "Comm." appears.

```
67:      Type: Comm.
          Program/Enter
```

6 Press ENTER. The LCD now shows either

```
67:Fax#/Com-Options
_
or
67:Fax#/Com-Options
9-5558743_
```

Note: **Do not** enter any characters here. If you do, you can't program a batch transmission into this key. If you accidentally enter characters here, press CANCEL as many times as needed to erase **all** of them **before** you go on to step 7.

Note: If this key already holds a batch transmission, skip to step 8.

- 7** Press COM-OPTIONS *three times* and then press ENTER. The LCD shows:

```
Batch Tx
Enter Box No.  _
```

- 8** Use the numeric keypad to enter the one-digit identifier for the batch box you want to assign to this one-touch key. Here, we've entered 5:

```
Batch Tx
Enter Box No.  5_
```

Note: To change an identifier already entered, press CANCEL to erase it. Then re-enter the correct identifier.

- 9** Press ENTER.

- 10** The LCD asks if you want to program additional settings for this programmable one-touch number.

```
67: Option:      Off
      Program/Enter
```

If you *do not* want to program additional settings, press ENTER and then skip to step 22.

If you *do* want to program additional settings, press ►/PROGRAM and ENTER.

- 11** The LCD asks which resolution you want to set for this programmable one-touch number.

```
67: Primary: ---
      Program/Enter
```

- 12** Press ►/PROGRAM until the mode you want appears.

Note: For any of the following settings, choosing "---" tells the machine to use its *default* setting for this one-touch key.

- 13** Press ENTER. The LCD asks which contrast mode you want when using this programmable one-touch number.

```
67: Contrast: ---
      Program/Enter
```

- 14** Press ►/PROGRAM until the mode you want appears.

- 15** Press ENTER. The LCD asks if you want the confirmation stamp on or off when using this programmable one-touch number.

```
67: Stamp: ---
      Program/Enter
```

- 16** Press ►/PROGRAM until the mode you want appears.

- 17** Press ENTER. The LCD asks if you want to send a cover page when using this programmable one-touch number.

```
67: Cover Page: ---
      Program/Enter
```

- 18** Press ►/PROGRAM until the mode you want appears.

- 19** Press ENTER. The LCD asks if you want the Copy & Fax feature on or off when using this programmable one-touch number.

```
67: Copy&Fax: ---
      Program/Enter
```

- 20** Press ►/PROGRAM until the mode you want appears.

- 21** Press ENTER.

- 22** The LCD now displays the next programmable one-touch key. If you *do not* want to enter or change *any other* key's programming, press STOP to return your machine to standby mode. If you *do* want to enter or change *this key's* programming, go back to step 4. If you want to enter or change *another* key's programming, go back to step 2.

Programming an F-Code transmission

For this operation to work, two things must be true:

- You must know how the remote fax is using each F-Code box to which you're transmitting — for example, as a security box or a relay box. Different fax manufacturers may use slightly different terms, but the concepts are the same.
- You must know the remote fax's ITU-T sub-address and password for each box to which you want to transmit.

To program an F-Code transmission into a programmable one-touch key:

- 1 Press **►/PROGRAM, C, 1, ENTER**. The LCD shows the first empty programmable one-touch number available:

```
Select Program No.
65:No Number Stored
```

Note: If a programmable one-touch number other than **65** appears on the LCD, it means that you have already entered a number for **65**.

Note: To *erase* a programmable one-touch key, see page 2.58.

- 2 Press the key you want to program or change. Here, we've selected **70**.

```
Select Program No.
70:No Number Stored
```

Note: If your previous command for this key was for an F-Code transmission and you want to keep this key programmed for an F-Code transmission, use these instructions to make changes. But if you want to assign this key to a completely different operation (for a delayed transmission, for example), then you first must erase the stored command before programming the new one.

- 3 If you want to select a different programmable one-touch key than the one that appears on the LCD, press that key now.
- 4 Press **ENTER**. The LCD asks for the type of operation you want to program into the one-touch:

```
70:      Type: Comm.
          Program/Enter
```

Note: If changing a previously stored command, skip to step 7.

- 5 Press **►/PROGRAM** until "*Comm.*" appears.

```
70:      Type: Comm.
          Program/Enter
```

- 6 Press **ENTER**. The LCD now shows either:

```
70:Fax#/Com-Options
_
```

or

```
70:Fax#/Com-Options
9-5558743_
```

- 7 Use the numeric keypad to enter the number *exactly* as your machine should dial it, including whatever codes your phone system requires. The number can be up to 40 characters in length:

```
70:Fax#/Com-Options
9-5558422_
```

Your display shows only 20 characters at a time. To view characters beyond those 20, press **◀** to scroll to the left or **►/PROGRAM** to scroll to the right.

Important: Do **not** press **ENTER**.

Note: To erase characters, press **CANCEL** to erase to the left. To change just one number, press **◀** to move the cursor left, or **►/PROGRAM** to move it right. Press **CANCEL** to erase it. Then re-enter the number correctly.

- 8 Now, *while you still can see the fax number on the LCD*, press **COM-OPTIONS** *three times* and then press **ENTER**. The LCD shows:

```
Enter Sub-Address
_
```

- 9 Use the numeric keypad to enter the ITU-T sub-address for the box to which you want to send the document. Here, we've entered *123456*:

```
Enter Sub-Address
123456_
```

- 10 Press **ENTER**. The LCD shows:

```
Enter Password
_
```

Note: If there isn't a password for this box, press **ENTER**, then skip to step 12.

- 11 Use the numeric keypad to enter the appropriate ITU-T password for the box. Here, we've entered *654321*:

```
Enter Password
654321_
```

When finished, press **ENTER**.

- 12** If you want the transmission to begin *immediately* every time you press the key, press **ENTER** and skip to step 15.
If you want to *delay* the transmission, press **COM-OPTIONS, ENTER**.

- 13** Next, tell your fax to carry out this delayed command one of these ways:

Option 1: Perform the command *once* at a certain time on a certain day of the month. (For example, "Do this at 5:05 PM on the 30th.")
To select this option, use the numeric keypad to enter the date and time when the fax should perform the command:

```
Delayed
Enter Time: 30/17:05
```

Option 2: Perform the command at a certain time *each day you press the key*. (For example, "Do this at 5:05 PM today.")
To select this option, use the numeric keypad to enter **0, 0** and then the time when the fax should perform the command:

```
Delayed
Enter Time: 00/17:05
```

- 14** Press **ENTER, ENTER**.

- 15** The LCD asks if you want to program additional settings for this programmable one-touch number:

```
70: Option: Off
Program/Enter
```

If you *do not* want to program additional settings, press **ENTER**. Then skip to step 31.

If you *do* want to program additional settings, press **►/PROGRAM** and **ENTER**.

- 16** The LCD asks which resolution you want when using this programmable one-touch number.

```
70: Primary: ---
Program/Enter
```

- 17** Press **►/PROGRAM** until the mode you want appears.

Note: For any of the following settings, choosing "---" tells the machine to use its *default* setting for this one-touch key.

- 18** Press **ENTER**. The LCD asks which contrast mode you want when using this programmable one-touch number.

```
70: Contrast: ---
Program/Enter
```

- 19** Press **►/PROGRAM** until the mode you want appears.

- 20** Press **ENTER**. The LCD asks if you want the confirmation stamp on or off when using this programmable one-touch number.

```
70: Stamp: ---
Program/Enter
```

- 21** Press **►/PROGRAM** until the mode you want appears.

- 22** Press **ENTER**. The LCD asks if you want the memory transmission on or off when using this programmable one-touch number.

```
70: Memory Tx: ---
Program/Enter
```

- 23** Press **►/PROGRAM** until the mode you want appears.

- 24** Press **ENTER**. The LCD asks which confirmation report you want to receive each time you use this programmable one-touch number.

```
70: Conf.Report: ---
Program/Enter
```

- 25** Press **►/PROGRAM** until the mode you want appears.

- 26** Press **ENTER**. The LCD asks if you want to send a cover page each time you use this programmable one-touch number.

```
70: Cover Page: ---
Program/Enter
```

- 27** Press **►/PROGRAM** until the mode you want appears.

- 28** Press **ENTER**. The LCD asks if you want the Copy & Fax feature on or off each time you use this programmable one-touch number.

```
70: Copy&Fax: ---
Program/Enter
```

- 29** Press **►/PROGRAM** until the mode you want appears.

- 30** Press **ENTER**.

- 31** The LCD now displays the next programmable one-touch key.
 If you *do not* want to enter or change *any other* key's programming, press **STOP** to return your machine to standby mode.
 If you *do* want to enter or change this key's programming, go back to step 4.
 If you want to enter or change *another* key's programming, go back to step 2.

Programming F-Code polling

For this operation to work, three things must be true:

- The document which you're polling must exist in the remote fax's F-Code box (ITU-T standard sub-addressing/password box).
- You must know the remote fax's ITU-T sub-address and password (if any) for each box you want to poll.

To program an F-Code polling operating into a programmable one-touch key:

- 1** Press **►/PROGRAM, C, 1, ENTER**. The LCD shows the first empty programmable one-touch number available:

```
Select Program No.
65:No Number Stored
```

Note: If a programmable one-touch number other than **65** appears on the LCD, it means that you have already entered a number for **65**.

Note: To *erase* a programmable one-touch key, refer to page 2.58.

- 2** Press the key you want to program or change. Here, we've selected **71**.

```
Select Program No.
71:No Number Stored
```

Note: If your previous command for this key was for an F-Code polling operation and you want to keep this key programmed for an F-Code polling operation, use these instructions to make changes. But if you want to assign this key to a completely different operation (for a delayed transmission, for example), then you first must erase the stored command before programming the new one.

- 3** To select a different programmable one-touch key than the one that appears on the LCD, press that key now.

- 4** Press **ENTER**. The LCD asks for the type of operation you want to program into the programmable one-touch:

```
71:          Type: Comm.
          Program/Enter
```

Note: If changing a previously stored command, skip to step 7.

- 5** Press **►/PROGRAM** until "*Comm.*" appears.

```
71:          Type: Comm.
          Program/Enter
```

- 6** Press **ENTER**. The LCD now shows either:

```
71:Fax#/Com-Options
_
```

or

```
71:Fax#/Com-Options
9-5558743_
```

- 7** Use the numeric keypad to enter the number *exactly* as your machine should dial it, including whatever codes your phone system requires. The number can be up to 40 characters in length:

```
71:Fax#/Com-Options
9-5558422_
```

Your display shows only 20 characters at a time. To view characters beyond those 20, press **◀** to scroll to the left or **►/PROGRAM** to scroll to the right.

Important: Do **not** press **ENTER**.

Note: To erase characters, press **CANCEL** to erase to the left.
 To change just one character in the number, press **◀** to move the cursor left, or **►/PROGRAM** to move it right. Press **CANCEL** to erase it.
 Then re-enter the number correctly.

- 8** Now, *while you can still see the fax number on the LCD*, press **COM-OPTIONS** *four times* and then press **ENTER**. The LCD shows:

```
Enter Sub-Address
_
```

- 9** Use the numeric keypad to enter the ITU-T sub-address for the box you want to poll. Here, we've entered *123456*:

```
Enter Sub-Address
123456_
```

- 10** Press **ENTER**. The LCD shows:

```
Enter Password
_
```

Note: If this box doesn't have a password, press **ENTER**. Then skip to step 12.

- 11** Use the numeric keypad to enter the ITU-T password for the box. Here, we've entered *654321*:

```
Enter Password
654321_
```

When finished, press **ENTER**.

- 12** If you want the transmission to begin *immediately* every time you press the key, press **ENTER** and skip to step 15.

If you want to *delay* the transmission (perhaps to take advantage of lower phone rates), press **COM-OPTIONS, ENTER**.

- 13** Next, tell your fax to carry out this delayed command one of these ways:

Option 1: Perform the command *once* at a certain time on a certain day of the month. (For example, "Do this at 5:05 PM on the 30th.") To select this option, use the numeric keypad to enter the date and time when the fax should perform the command:

```
Delayed
Enter Time: 30/17:05
```

Option 2: Perform the command at a certain time *each day you press the key*. (For example, "Do this at 5:05 PM today.") To select this option, use the numeric keypad to enter **0, 0** and then the time when the fax could perform the command:

```
Delayed
Enter Time: 00/17:05
```

- 14** Press **ENTER, ENTER**.

- 15** The LCD now displays the next programmable one-touch key. If you *do not* want to enter or change *any other* key's programming, press **STOP** to return your machine to its usual standby mode. If you *do* want to enter or change this key's programming, go back to step 4. If you want to enter or change *another* key's programming, go back to step 2.

Programming printouts

To program a programmable one-touch key to print a list:

- 1** Press **►/PROGRAM, C, 1, ENTER**. The LCD shows the first empty programmable one-touch number available:

```
Select Program No.
65:No Number Stored
```

Note: If a programmable one-touch number other than **65** appears on the LCD, it means that you have already entered a number for **65**.

Note: To *erase* a programmable one-touch key, refer to page 2.58.

- 2** Press the key you want to program or change. Here, we've selected **68**.

```
Select Program No.
68:No Number Stored
```

Note: If your previous command for this key was for printing a list and you want to keep this key programmed for printing a list, use these instructions to make changes. But if you want to assign this key to a completely different operation (for a delayed transmission, for example), then you first must erase the stored command before programming the new one.

- 3** To select a different programmable one-touch key than the one that appears on the LCD, press that key now.

- 4** Press **ENTER**. The LCD asks which operation you want to program into the programmable one-touch:

```
68:          Type: Comm.
          Program/Enter
```

Note: If changing a previously stored command, skip to step 7.

- 5** Press **►/PROGRAM** until "*List.*" appears.

```
68:          Type: List
          Program/Enter
```

- 6** Press **ENTER**. The LCD asks which list you want to program into the programmable one-touch:

```
68:Print One-Touch
          Program/Enter
```

- 7 Press ►/PROGRAM until the list you want appears.
- 8 Press ENTER.
The LCD now displays the next programmable one-touch key.
If you *do not* want to enter or change *any other* key's programming, press STOP to return your machine to standby mode.
If you *do* want to enter or change this key's programming, go back to step 4.
If you want to enter or change *another* key's programming, go back to step 2.

Programming a document storage operation

To program a programmable one-touch key to store an F-Code polling document, two things must be true:

- The F-Code bulletin box must exist on your fax machine.
- You must know the F-Code bulletin box's two-digit number (01-50) and name.

To program your programmable one-touch to store a regular polling document or F-Code polling document:

- 1 Press ►/PROGRAM, C, 1, ENTER. The LCD shows the first empty programmable one-touch number available:

```
Select Program No.  
65:No Number Stored
```

Note: If a programmable one-touch number other than 65 appears on the LCD, it means that you have already entered a number for 65.

Note: To *erase* a programmable one-touch key, see page 2.58.

- 2 Press the key you want to program or change. Here, we've selected 69.

```
Select Program No.  
69:No Number Stored
```

Note: If your previous command for this key was to store a document and you want to keep this key programmed to store a document, use these instructions to make changes. But if you want to assign this key to a completely different operation (for a delayed transmission, for example), then you first must erase the stored command before programming the new one.

- 3 To select a different programmable one-touch key than the one that appears on the LCD, press that key now.
- 4 Press ENTER. The LCD asks what kind of operation you want to program into the programmable one-touch:

```
69: Type: Comm.  
Program/Enter
```

Note: If changing a previously stored command, skip to step 7.

- 5 Press ►/PROGRAM until "Store" appears.

```
69: Type: Store  
Program/Enter
```

- 6 Press ENTER. The LCD asks which storing menu you want to program into the programmable one-touch:

```
69:Store Polling Doc  
Program/Enter
```

- 7 Press ►/PROGRAM until the mode you want appears.

- 8 Press ENTER.
If you select the "Store Polling Doc" operation, skip to step 14.
If you select the "Store F-Code Doc" operation, go on to step 9.

- 9 The LCD asks which F-Code bulletin box you want to use.

```
Select F-Code Box  
01:Murata Machinery
```

- 10 Use the numeric keypad to enter the two-digit identifier number (01-50) of the F-Code box in which you want to store the document. Here, we've entered 0, 3:

```
Select F-Code Box  
03:Muratec America
```

- 11 To select a different F-Code box than the one that appears on the LCD, enter that box number now.

- 12** Press **ENTER**. The LCD asks if you want the box to overwrite (erase) any documents it is currently storing whenever it stores a new document.

```
Overwrite Doc.: Off
                Program/Enter
```

- On:** When your machine stores a new document into this box, it will overwrite documents stored in it.
- Off:** When your machine stores a new document into this box, it won't erase (overwrite) any documents stored in it. Your machine can store up to 30 documents in each box (each document can include one or more pages).

- 13** Press **►/PROGRAM** until the mode you want appears. Then press **ENTER** to save the setting.

- 14** The LCD asks if you want to program additional settings for this one-touch.

```
69: Option:      Off
                Program/Enter
```

If you *do not* want to program additional settings, press **ENTER**. Go to step 22. If you *do* want to program additional settings, press **►/PROGRAM** and **ENTER**, then go on to step 15.

- 15** The LCD asks which resolution you want each time you use this programmable one-touch number.

```
69: Primary: ---
                Program/Enter
```

- 16** Press **►/PROGRAM** until the mode you want appears.

Note: For any of the following settings, choosing “---” tells the machine to use its *default* setting for this programmable one-touch key.

- 17** Press **ENTER**. The LCD asks which contrast mode you want each time you use this programmable one-touch number.

```
69: Contrast: ---
                Program/Enter
```

- 18** Press **►/PROGRAM** until the mode you want appears.

- 19** Press **ENTER**. The LCD asks if you want the Copy & Fax feature on or off each time you use this programmable one-touch number.

```
69: Copy&Fax: ---
                Program/Enter
```

- 20** Press **►/PROGRAM** until the mode you want appears.

- 21** Press **ENTER**.

- 22** The LCD now displays the next programmable one-touch key. If you *do not* want to enter or change *any other* key's programming, press **STOP** to return your machine to standby mode. If you *do* want to enter or change this key's programming, go back to step 4. If you want to enter or change *another* key's programming, go back to step 2.

Fax dialling with programmable one-touch

To dial a fax call using a programmable one-touch number:

- 1** Insert the document.
- 2** Make any necessary adjustments as usual.
- 3** Press the programmable one-touch key in which you've stored the fax communication command.

Your fax will perform the operation now, or at whatever time you programmed.

Note: To review the details of each operation, review the instructions for that operation. See page 2.45 for a list of each operation and where to find it.

If you programmed this key to delay its operation, the LCD shows:

```
** Reserved **
A4           Memory 95%
```

If you programmed this key to perform the operation immediately after you press it, the LCD shows the number:

```
9-1-972-555-4335
A4           Normal
```

Printing lists using programmable one-touch

To print a list using a programmable one-touch number:

Press the programmable one-touch key in which you've stored the list operation you want to print.

Storing fax documents with programmable one-touch

To store a fax document for either polling or F-Code polling using a programmable one-touch number:

- 1 Insert the document.
- 2 Make any necessary adjustments as usual.
- 3 Press the programmable one-touch key which is programmed for the storing operation you want to use.

Erasing a programmable one-touch key

- 1 Press ►/PROGRAM, C, 2, ENTER. The LCD shows the first programmable one-touch number that has been programmed:

```
Select Program No.  
65:Delayed
```

Note: If a one-touch number other than 65 appears, it means 65 is empty.

- 2 Press the programmable one-touch key you want to erase. Here, we've selected 67:

```
Select Program No.  
67:Polling
```

- 3 To erase a different programmable one-touch key than the one that appears on the LCD, press that key now.

- 4 Press ENTER. The LCD shows:

```
Erase P One-Touch  
Check Program/Enter
```

Important: If you want to quit without erasing the programmable one-touch key you've selected, press ►/PROGRAM. The fax will return to step 2.

- 5 Press ENTER to erase the number.

```
Erase P One-Touch  
** Complete **
```

To erase another programmable one-touch key, repeat steps 2-5. Or press STOP to return to standby mode.

Printing a list of your programmable one-touch keys

Your fax machine can print a list of the commands you've stored in your programmable one-touch keys.

For a communications operation, the list includes:

- (1) each key's one-touch number
- (2) the fax/telephone number
- (3) when the command should start
- (4) which command you've selected
- (5) if applicable, the selected call group(s) or F-Code box(es) you've stored in the key
- (6) the individual settings for each key

For a list printout operation, the list includes:

- (1) each key's one-touch number
- (2) name of the list the key is programmed to print

For a storage operation, the list includes:

- (1) each key's one-touch number
- (2) which command you've selected
- (3) if you selected an F-Code polling document, the selected F-Code bulletin box name and which overwrite setting you've selected
- (4) the individual settings for each key.

To print a list of programmable one-touch keys, press ►/PROGRAM, C, 3, ENTER.

Security features

Your machine has a number of security features to keep your private fax documents private, avoid unwanted outside communication and even protect against unauthorised use of your machine.

These security features include: (1) operation protection, (2) security reception, (3) PIN mask, (4) security transmission, (5) closed network, (6) block junk fax, and (7) department codes.

The passcode

Your machine has a *passcode protection* system which must be turned on in order to use the security features listed above.

To set your machine's passcode:

- 1 Decide on the four-digit passcode (0001-9999) you want to use. *Write it down, and put it in a safe place.*

Important: Do *not* use 0000. This turns off passcode protection.

- 2 Press ►/PROGRAM, J, 1, 6, ENTER. The LCD shows:

```
Protect Passcode
Old Passcode:  _***
```

- 3 If you are *creating* a passcode, use the numeric keypad to enter 0000. If you are *changing* an *existing* passcode, enter the existing passcode.

- 4 Press ENTER.

- 5 Enter the new four-digit passcode. Here, we've entered 6296:

```
Protect Passcode
New Passcode:  6296
```

- 6 Press ENTER to save the passcode.

Note: Any time you want to turn off the passcode, change the passcode back to 0000 by repeating steps 2–6 and entering 0000 in step 5.

Operation protection

Important: For this feature to work, you must have activated the passcode protection, as described in the left column.

When your machine's *operation protection* is activated, only users who enter the correct passcode can send faxes from it or change the machine's settings.

Activating operation protection

- 1 Press ►/PROGRAM, J, 1, 7, ENTER. The LCD shows:

```
Set Opr. Protect
Enter Passcode:  _***
```

- 2 Use the numeric keypad to enter the passcode created in "The Passcode," left column. Here, we've entered 6296:

```
Set Opr. Protect
Enter Passcode:  6296
```

- 3 Press ENTER. The LCD shows:

```
Opr. Protect:   Off
Program/Enter
```

- 4 Press ◀ or ▶/PROGRAM until the setting you want appears. Here, we've chosen "On."

```
Opr. Protect:   On
Program/Enter
```

- 5 Press ENTER to save the setting.

Using your fax machine during operation protection

- 1 When you press any key on your machine, the LCD shows:

```
Operation Protected
Enter Passcode: ****
```

- 2 Use the numeric keypad to enter the four-digit passcode set in "The Passcode," page 2.59.

```
Operation Protected
Enter Passcode: 6296
```

When you enter correct passcode, the machine will let you go on to the next step in your fax operation.

Note: If you start another operation while the first is still underway, the machine will require the passcode from you one more time before it continues with your new request. However, the first operation will not be affected, even if you fail to enter the correct passcode for the second entry.

Security reception

Security reception tells your machine to keep *all* received faxes in memory (but not print them). Then you can print them out later, at your convenience. For example, you could use this if you're concerned about workers reading documents intended for your eyes only.

Important: For this feature to work, you must have activated the *passcode protection* as described on page 2.59. You must also *know* the passcode.

Note: In the following instructions, your machine's LCD shortens the word *Receive* to *Rx*.

Activating security reception

- 1 Press **▶/PROGRAM**, **0** [the letter *O*, not a zero], **1**, **ENTER**. The LCD shows:

```
Set Security Rx
Enter Passcode: ****
```

- 2 Use the numeric keypad to enter the protection passcode. Here, we've entered *6296*:

```
Set Security Rx
Enter Passcode: 6296
```

- 3 Press **ENTER**. The LCD shows:

```
Security Rx: Off
Program/Enter
```

- 4 Press **◀** or **▶/PROGRAM** until the setting you want appears. Here, we've chosen "On."

```
Security Rx: On
Program/Enter
```

- 5 Press **ENTER**. The LCD shows the machine's current clock setting:

```
Set Security Rx
Enter Time: 15:42
```

- 6 If you want security reception to begin *now* (and at this same time every day), skip to step 8. Otherwise, go on to step 7.

- 7 Use the numeric keypad to enter the time (use a 24-hour format) when security reception should begin every day. "Type over" the numbers displayed. Here, we've entered *17:35*:

```
Set Security Rx
Enter Time: 17:35
```

To change a digit, press **◀** to move to the left, or **▶/PROGRAM** to move right. Then enter the correct digit.

- 8 Press **ENTER** to save the setting.

Using a Soft key

After setting for activating the security reception, you can use the Soft key (see page 2.24) to turn the security reception on and off.

To turn the security reception on using soft key:

- 1 Press Soft key that programmed security reception.
- 2 Enter passcode and then press **ENTER**.
- 3 The LED of the Soft key will light and the security reception begins immediately.

Note: To turn the security reception off, see "*Printing from security reception/Turning off security reception*," next page.

Printing from security reception / Turning off security reception

When security reception is on, an incoming fax goes directly into your machine's memory and the **MEMORY RECEIVE** light comes on. But the fax is not printed.

To retrieve the faxes received during this security reception (and to return your machine to normal reception until the next time):

- 1 Press **►/PROGRAM, 0** [the letter *O*, not a zero], **2, ENTER**.
If you using the Soft key (see page 2.24), press the Soft key instead of this operation. The LCD shows:

```
Print Mem Rx Doc.
Enter Passcode: ****
```

- 2 Use the numeric keypad to enter the passcode. Here, we've entered *6296*:

```
Print Mem Rx Doc.
Enter Passcode: 6296
```

- 3 Press **ENTER**.
 - If you've entered the correct passcode, your fax machine will print all documents in its memory and then erase them. Then it will turn security reception off until the next time you've scheduled security reception or the Soft key which programmed security reception is pressed. If you using the Soft key, the LED light of the Soft key will be off.
 - If you've entered an incorrect passcode, your fax machine will refuse to print, and security reception remains on.

Masking the PIN

To prevent unauthorised long-distance calls, some office telephone systems require you to enter a *personal identification number (PIN)* whenever you dial long distance.

Your fax's *PIN mask feature* helps you keep that PIN number private. With the PIN mask activated, you can dial a fax number plus a PIN, but the PIN will not appear in a journal, error message printout, delayed command list or a TCR. The PIN may be up to eight characters in length. It also can include the * or # symbols, and it can be entered from the numeric keypad.

There are three possible settings for the PIN mask:

- *Off* — Turns off the PIN mask feature. Any PIN you enter will appear on any display or printout which shows the number you dial.
- *Mode 1* — Each *remote fax unit* has a departmental PIN access code.
- *Mode 2* — Each *fax user* has a departmental PIN access code.

Note: If you select Mode 1 and you will use a one-touch or speed-dial number, you must store the remote unit's PIN access code within that number. However, if you select Mode 2, this isn't necessary. (See "Autodialling while using the PIN mask," next page, right column for further details.)

Note: If you select either Mode 1 or Mode 2 and will be using batch transmission (see pages 2.20 – 2.23), you must store the PIN access code for the remote unit within the appropriate batch box.

Activating the PIN mask

Important: For this feature to work, you must have activated the *passcode protection* as described on page 2.59. You must also *know* the passcode.

- 1 Press **►/PROGRAM, J, 1, 8, ENTER**. The LCD shows:

```
Set PIN Mode
Enter Passcode: ****
```

- 2 Use the numeric keypad to enter the four-digit passcode. Here, we've entered *6296*.

```
Set PIN Mode
Enter Passcode: 6296
```

Note: If you enter an invalid passcode, the machine's security feature rejects the attempt and returns to standby mode.

- 3 Press **ENTER**.

```
PIN Mode:      Off
Program/Enter
```

- 4 Press ◀ or ▶/PROGRAM until the mode you want appears. In this example, we've chosen "Mode1."

```
PIN Mode:      Mode1
              Program/Enter
```

- 5 Press ENTER.

Autodialling while using the PIN mask

Note: The following instructions presume you understand how to set and use your machine's autodialler. If you need to review, see pages 2.7–2.15.

If you chose "Mode 1" — the PIN goes in

In Mode 1, before autodialling a number for the first time, you must add the PIN to the stored one-touch key or speed-dial number. Here's how:

- 1 Begin by creating or changing an entry in the autodialler. See pages 2.7–2.15 if necessary. While you're setting this up, the machine asks you to enter the PIN. The LCD shows:

```
Set PIN Number
Enter Passcode: ****
```

- 2 Use the numeric keypad to enter the four-digit passcode. Here, we'll use our sample passcode again.

```
Set PIN Number
Enter Passcode: 6296
```

- 3 Press ENTER. In our example, we're setting speed-dial number 001:

```
001:PIN Number
_
```

- 4 Use the numeric keypad to enter the desired PIN, up to eight characters in length.

```
001:PIN Number
1057_
```

- 5 Press ENTER to save the PIN.

Note: If you press ENTER without entering the PIN, the fax machine beeps, indicates "Invalid Number" on the LCD and then returns to step 4.

Now you may autodial the number as usual.

Important: While in PIN Mode 1, *any* autodialler numbers you use must include the PIN. This also applies to autodialler numbers used with batch transmission (see pages 2.20–2.23) or programmable one-touch keys (see pages 2.45–2.58).

Note: If you select either Mode 1 or Mode 2 and will be using batch transmission, you must store the PIN access code for the remote unit within the appropriate batch box.

If you chose "Mode 2" — as you autodial, load the code

In this mode, you *don't* have to add the PIN to the autodialler setting. Instead, you enter the PIN manually each time you autodial:

- 1 Dial the number as you normally would, using the autodialler. Here, we've pushed one-touch key A. The machine now asks for the PIN:

```
Enter PIN Number
_
```

- 2 Use the numeric keypad to enter the PIN.

```
Enter PIN Number
1057_
```

- 3 Press START. Your machine dials the number.

Note: If you select either Mode 1 or Mode 2 and will be using batch transmission (see pages 2.20–2.23), you must store the PIN access code for the remote unit within the appropriate batch box.

Dialling from the numeric keypad while using the PIN mask

If you've specified Mode 1 — use "star" power

- 1 Enter the phone number, then press the * ("star") key and enter the PIN. *The PIN always goes last.* For example, to dial 19725550911 with a PIN of "123456", enter 19725550911*123456:

```
Press Start
19725550911*123456
```

- 2 Press START. The PIN disappears from the display, and your machine dials the desired phone number.

If you've specified Mode 2 — the machine guides you

- 1 Enter the phone number as usual.

```
Press Start
19725550911_
```

- 2 Press **START**. The LCD shows:

```
Enter PIN Number
_
```

- 3 Use the numeric keypad to enter the **PIN**.

```
Enter PIN Number
123456_
```

- 4 Press **START**. Your machine dials the number.

Performing batch transmission while using the PIN mask

Note: The following instructions presume you are familiar with how to set and use both your machine's autodialler and its batch transmission feature. If you need to review, see pages 2.7–2.15 for more on the autodialler and/or pages 2.20–2.23 for more on batch transmission.

If you've specified Mode 1 or Mode 2

Important: Any autodialler number you use with batch transmission *must* include the **PIN**. (To review how to include this information in an autodialler number, review the Mode 1 instructions under "Autodialling while using the PIN mask," page 2.62.)

Before sending a batch transmission the first time, you must store the **PIN** within its batch box. Here's how:

- 1 Follow the steps for creating or modifying a batch box (page 2.20). The LCD asks for the fax number (here, we're working with batch box 1):

```
1:Fax Number
_
```

- 2 Enter an autodialler number, or use the numeric keypad to enter the fax number, to which the batch transmission should go.

Important: If you're entering a number from the numeric keypad, enter the fax number, followed by the * ("star") key and then the **PIN**.

- 3 Press **ENTER** to save the setting.

Note: If you press **ENTER** without entering the **PIN**, the fax machine beeps, indicates "No PIN Number" on the LCD and then returns you to step 2.

- 4 Continue with the steps for creating or modifying a batch box (page 2.20).

Now you can perform batch transmission to this box while the **PIN** mask is activated.

Setting security transmission

Your fax's *security transmission* feature provides extra assurance that your documents go where you're sending them. When this feature is activated and your machine sends a fax, the machine compares the last four digits of the dialled number to the other unit's Subscriber ID (the phone number at the top of that unit's transmissions; see page 1.10). If these digits match, your call goes through. If they don't, your machine disconnects the call and prints an error message telling you to check the condition of the remote unit.

Before you activate this feature, consider:

- *Not all fax machine owners enter their phone numbers in their Subscriber IDs.* — Indeed, some machines don't even *have* a Subscriber ID. So, with security transmission activated, your machine would disconnect its calls to such machines.
- *Access codes can cause confusion.* — If an autodialler entry ends with a long-distance or other access codes, activating this feature prevents calls to that fax.

Note: In the following instructions, your fax's LCD abbreviates *Transmission* as *Tx*.

- 1 Press **▶/PROGRAM, J, 1, 1, ENTER**. The LCD shows the current setting:

```
Security Tx: Off
Program/Enter
```

- 2 Press **◀** or **▶/PROGRAM** until the mode you want appears. In this example, we've chosen *On*.

```
Security Tx: On
Program/Enter
```

- 3 Press **ENTER** to save the setting.

Setting for use with a closed network

For maximum communications security, use a *closed network*. This limits your machine to only communicating with other Muratec fax machines which can “present” the proper passcode.

Important: The passcode you use for closed network operation is **not** the same as the protection passcode.

Once your machine is set up for a closed network, your machine will disconnect calls coming in from fax machines other than Muratec fax machines.

To set your fax machine's closed network password:

1 Decide on the four-digit closed network passcode (0001-9999) you want to use. **Write it down**, and *put it in a safe place*.

2 Press ►/PROGRAM, J, 0, 9, ENTER. The LCD shows the current code:

```
Set Passcode
Passcode:    0000
```

3 Use the numeric keypad to enter the desired four-digit *closed network passcode*.

```
Set Passcode
Passcode:    5627
```

4 Press ENTER to save the setting.

Note: To turn off the closed network passcode and return to normal fax reception, change the code to 0000 by repeating steps 1–4 and entering 0000 in step 3.

To set your fax machine to operate in a closed network:

1 Press ►/PROGRAM, J, 1, 0, ENTER. The LCD shows your fax's current setting:

```
Closed Net.: Off
Program/Enter
```

2 Press ◀ or ►/PROGRAM until the mode you want appears. Here, we've chosen *On*.

```
Closed Net.: On
Program/Enter
```

3 Press ENTER to save the setting.

Setting Block Junk Fax

Your fax machine's *Block Junk Fax* feature lets you bar the gates against unauthorised incoming faxes (“junk fax”). But before you block junk fax, first understand *how* this feature works, to determine if it's right for you. There are four possible settings for Block Junk Fax:

- *Off*— The feature isn't activated.
- *Mode1*— Your fax machine checks whether the last four digits of any phone number in your autodialler matches the last four digits of the remote fax's subscriber ID (the phone number part of the TTI). If it doesn't find a match, your machine disconnects the call.
- *Mode2*— This mode rejects any call from a number whose last eight digits match any number in the *blocked numbers list* (explained later). Your machine can hold up to 30 blocked numbers.
- *Mode3*— This rejects numbers that are *not* in the autodialler and also rejects numbers that *are* in the blocked numbers list. This lets you keep a number on your autodialler for transmission to it, while still blocking its incoming calls by putting it in the blocked numbers list.

But before you activate the Block Junk Fax feature, please consider:

- *Not all fax machine owners enter their phone numbers in their Subscriber IDs.*— With Block Junk Fax activated, your machine would reject faxes from these machines.
- *Access codes can cause confusion.*— If an autodialler entry ends with extra codes, such as long-distance codes, Block Junk Fax will block out calls from those faxes.

To set Block Junk Fax:

1 Press ►/PROGRAM, J, 1, 2, ENTER. The LCD shows your fax's current setting:

```
Block Junk Fax:Off
Program/Enter
```

2 Press ◀ or ►/PROGRAM until the mode you want appears. Here, we've chosen *Mode2*.

```
Block Junk Fax:Mode2
Program/Enter
```

3 Press ENTER to save the setting. What you do next depends on what you selected in step 1:

- If you selected *Off* or *Mode1*, your machine returns to standby mode.
- If you selected either *Mode2* or *Mode3*, go on to step 4.

- 4** The LCD now asks if you want to enter a number:

```
Set BlockJunk Dial
Program/Enter
```

If you want to enter or modify a number, press **ENTER** and go on to step 5. Otherwise, press **►/PROGRAM** and skip to step 10.

- 5** Depending on if you have already entered at least one number into the blocked numbers list, the display shows one of the following:

```
Enter Fax Number
01: _
```

or

```
Select BlockJunk No.
01: 555-2971
```

- 6** If you want to modify an existing entry in the blocked numbers list, press **◀** or **►/PROGRAM** until you see the number you want to modify.

... or ...

If you want to enter a new number in an already-started blocked numbers list, press **◀** or **►/PROGRAM** until you find an empty position in the list.

Then press **ENTER** to enter or modify the blocked number.

Note: To *clear* a number from the list, see “Clearing a number from the blocked numbers list,” right column.

- 7** Use the numeric keypad to enter *the last eight characters* of a fax number you want to block. For example, if you want to block a fax from someone with a Subscriber ID of *972-555-3038*, you should enter **5, 5, 5, -, 3, 0, 3, 8:**

```
Enter Fax Number
01: 555-3038
```

To change a specific digit, press **◀** to move left or **►/PROGRAM** to move right until the cursor is under the digit, then use the numeric keypad to enter the correct number.

- 8** Press **ENTER** to save the setting. The display shows the next “slot” in the blocked numbers list.
If you *do not* want to enter or change a number for this slot, go on to step 9.
If you *do* want to enter or change a number for this slot, repeat steps 5–8.
- 9** Press **STOP**. The display now asks if you want to print the list.

```
Print BlockJunk Dial
Enter/Stop
```

- 10** If you *do* want to print the list, press **ENTER** and your machine will print it. If you *don't* want to print it, press **STOP** and your machine will return to standby mode.

Clearing a number from the blocked numbers list

To *clear* a number from the list:

- 1** Press **►/PROGRAM, J, 1, 2, ENTER**.
If your Block Junk Fax setting is either *Mode2* or *Mode3*, skip to step 3.

```
Block Junk Fax:Off
Program/Enter
```

- 2** Press **◀** or **►/PROGRAM** until you see your preference, *Mode2* or *Mode3*.

```
Block Junk Fax:Mode2
Program/Enter
```

- 3** Press **ENTER, ENTER**. The display shows:

```
Select BlockJunk No.
01: 555-2971
```

- 4** Press **◀** or **►/PROGRAM** until you see the number you want to clear.

- 5** Press **CANCEL** to clear the number.
To clear another number from the blocked numbers list, repeat steps 4–5. Otherwise, go on to step 6.

- 6** Press **STOP**. The display now asks if you want to print the blocked numbers list.

```
Print BlockJunk Dial
Enter/Stop
```

If you *do* want to print the list, press **ENTER** and your machine will print it. Otherwise, press **STOP** to return your machine to standby mode.

Using department codes

You can keep track of how your machine is used through its *department code* feature. When the department code setting is activated, the machine reminds each user to enter the department code before sending or polling a document. The Activity Journal then keeps track of fax transactions by department.

After you turn on this setting, assign specific code numbers to your office's fax users and tell them to enter these department codes before sending faxes.

Note: Please note that using this setting may block access to the fax machine.

Entering a department code

Your machine can hold up to 100 separate department codes.

To enter a department code:

- 1 Press **▶/PROGRAM, M, 2, ENTER**. Depending upon whether you've already entered a department code, the LCD shows:

Enter Dept. Code
001: _

or

Select Department No
001:1555

Note: If department code operation is *protected* (see page 2.67), the fax beeps briefly and then returns to standby mode. You will have to turn off the protection first, then repeat this step.

- 2 If you have not entered any codes in your fax, skip to step 4. Otherwise, go on to step 3.
- 3 To enter a new code in a department code list that's already been started, press **ENTER**. The fax will skip to the next empty position in the list.
Note: If you want to *modify* an existing entry in the department code, you first *clear* a department code you want to modify and then enter a new code (see "Clearing a department code," right column).
- 4 Use the numeric keypad to enter the four-digit department code, *0000-9999*. Here, we've entered *1555*:

Enter Dept. Code
001: 1555

To change one digit, press **◀** to move left or **▶/PROGRAM** to move right until the cursor is under the digit, then use the numeric keypad to enter the correct number.

- 5 Press **ENTER** to save the setting.
To enter another department code, repeat steps 4-5.
To stop entering department codes, press **STOP** to return to standby mode.

Clearing a department code

- 1 Press **▶/PROGRAM, M, 2, ENTER**. The LCD shows:

Select Department No
001:1555

Note: If department code operation is *protected* (see below), the fax beeps briefly and then returns to standby mode. You will have to turn off the protection first, then repeat this step.

- 2 Press **◀** or **▶/PROGRAM** until you see the code you want to clear. Here, we've selected "3111".
- 3 Press **CANCEL**.

3111:Erase Dpt. Code
Check Program/Enter

Important: If you want to quit without clearing the department code you've selected, press **▶/PROGRAM**. The fax returns to step 2.

- 4 Press **ENTER** to clear the department code.

To clear another department code, repeat steps 2-4.

If you *don't* want to clear another department code, press **STOP** to return to standby mode.

Turning the department code setting on and off

- 1 Press **▶/PROGRAM, M, 3, ENTER**. The LCD shows:

Dept. On/Off: Off
Program/Enter

Note: If department code operation is *protected* (see next item), the fax beeps briefly and then returns to standby mode. You will have to turn off the protection first, then repeat this step.

- 2 Press **◀** or **▶/PROGRAM** until you see the setting you want.

Dept. On/Off: On
Program/Enter

- 3 Press **ENTER**.

Turning department code protection on and off

Important: This feature will work only if you've activated the *passcode protection* (see page 2.59).

- 1** Press **▶/PROGRAM, M, 1, ENTER**. The LCD shows:

```
Set Dept. Protect
Enter Passcode: _***
```

- 2** Use the numeric keypad to enter the four-digit passcode:

```
Set. Dept. Protect
Enter Passcode: 6596
```

To change one digit, press **◀** to move left or **▶/PROGRAM** to move right until the cursor is under the digit, then use the numeric keypad to enter the correct number.

- 3** Press **ENTER**.

```
Dept. Protect: Off
Program/Enter
```

- 4** Press **◀** or **▶/PROGRAM** until the setting you want appears.

```
Dept. Protect: On
Program/Enter
```

- 5** Press **ENTER** to save the setting.

Sending a fax using a department code

For this operation to work, two things must be true:

- The four-digit department code must exist on your fax machine.
- You must know the department code.

- 1** Insert the document.
- 2** Adjust resolution and contrast if necessary.
- 3** Enter the fax number by either pressing a one-touch key, entering a speed-dial number or dialling from the numeric keypad.

If you enter the fax number using a one-touch key, skip to step 6. Otherwise, go on to step 4.

- 4** Press **START**.

```
Enter Dept. Code
_
```

- 5** Use the numeric keypad to enter the appropriate four-digit department code. In this example, we've entered *1234*:

```
Enter Dept. Code
1234_
```

- 6** Press **START** again.

Printing the department time list

The department time list includes the following information for each department code:

- *Time period* covered by the department time list
- Each *department code*
- *Total communication time* (in hours, minutes and seconds; *HH:MM:SS*) — Counts the communication time up to 999:59:59 (999 hours:59 minutes:59 seconds). If the fax exceeds the maximum time, it does not count further.
- *Total printed pages* — Counts the pages up to 65535 pages. If the fax exceeds the maximum number of pages, it counts the total pages from 0 (zero).

Note: If you want to clear the total counts of each department code, see “Clearing the current department time list”, below.

To print the list, press **▶/PROGRAM, M, 4, ENTER**.

Note: If department code operation is *protected* (see left column), the fax beeps briefly and then returns to standby mode. You will have to turn off the protection first, then repeat the above.

Clearing the department time list

To clear the current total counts of each department code:

Press **▶/PROGRAM, M, 5, ENTER**.

The total communication time and total printed pages for each department code are cleared. The department code will not be erased.

Just in case ...

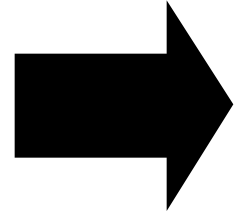

Tips on caring for your machine
What to do if problems occur
Glossary

Clearing paper jams	3.1
Print quality problems	3.3
Troubleshooting	3.5
Caring for your fax machine	3.10
Common questions	3.12
Glossary	3.15

Clearing paper jams

Original document jams

- 1 Press the scanner cover release and open the scanner cover.

Important: Hold the cover open. It won't stay open by itself.

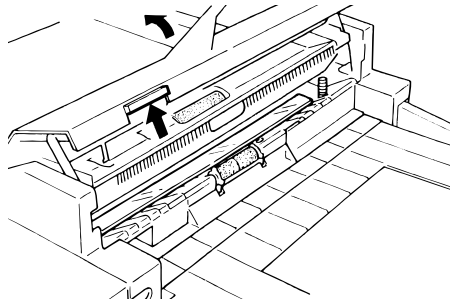

- 2 Lift the original document from your fax machine.

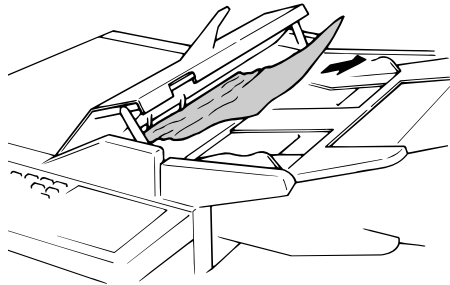

- 3 Gently close the scanner cover, making sure both sides are snapped down securely. Then re-try the transmission.

Note: If the original document is wrinkled or torn, *don't* re-send it.

Printout jams

To clear a printout jammed inside your fax machine:

- 1 Press the printer cover release button to open your fax machine's printer cover.

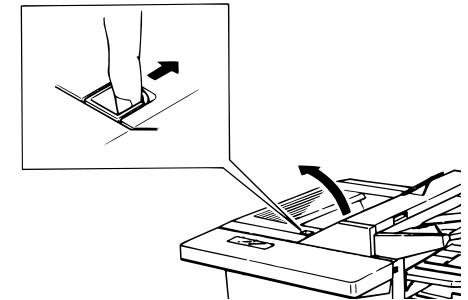

- 2 Gently pull the jammed printout *up and out*. The printout may be jammed either within the fax (*left, below*), or in the output tray (*right, below*).

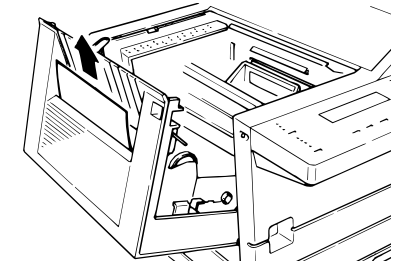
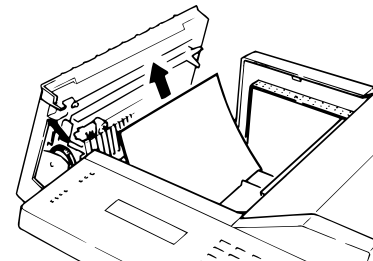

- 3 Gently close the printer cover, pressing firmly on both sides of the printer cover until you hear it click.

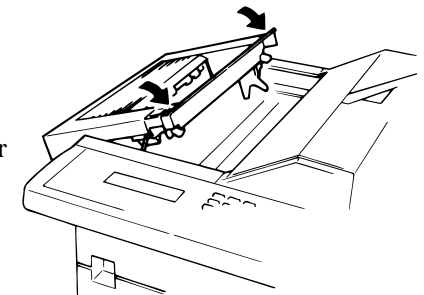

Just in case ...

To clear a printout jammed at the *paper cassette*:

1 Pull forward on the paper cassette to open it.

2 Carefully remove the jammed paper(s) from the machine's rollers, as shown.

3 Push the paper cassette closed.

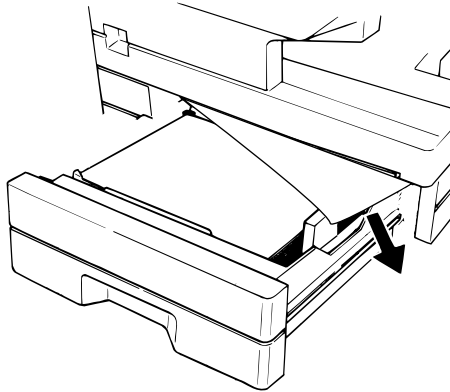

4 Press the printer cover release button and open your fax machine's printer cover.

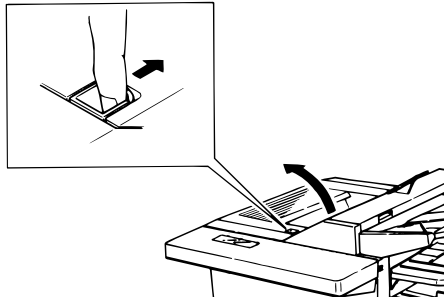

5 Gently close the printer cover, pressing firmly on both sides of the printer cover until you hear it click.

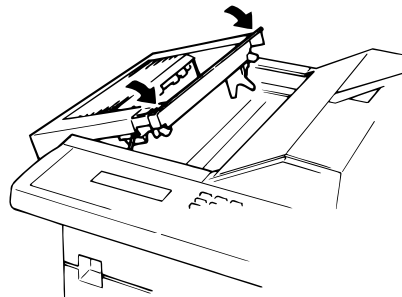

To clear a printout jammed at the *multipurpose tray*:

1 Remove the paper stack from the tray.

2 Carefully remove the jammed paper from the machine, as shown.

3 Reload the paper stack into the tray.

Note: Do *not* reload sheets that are wrinkled or torn.

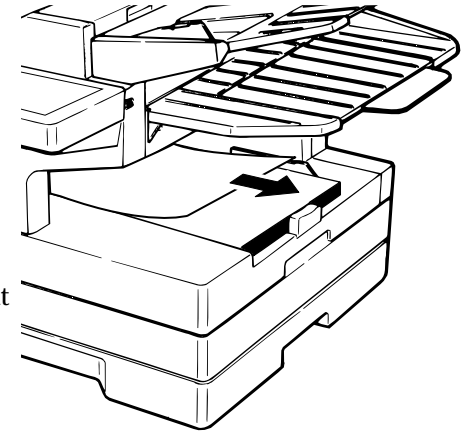

4 Press the printer cover release button and open your fax machine's printer cover.

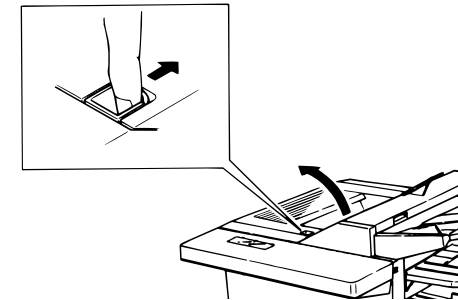

5 Gently close the printer cover, pressing firmly on both sides of the printer cover until you hear it click.

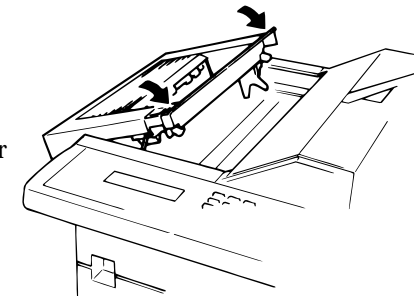

Print quality problems

If your machine's printouts develop quality problems, try to find the example below that matches your printout problem. When you find one which is like yours, try the suggested solutions. If they don't work, contact your authorised Muratec dealer.

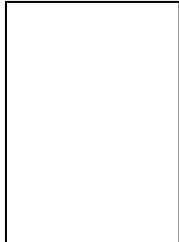

Pages are blank

- The drum cartridge or toner cartridge may not be installed correctly.
Install each cartridge correctly.
- The toner cartridge may be out of toner, or the toner may be very low.
Remove the toner cartridge and shake it a few times to redistribute the toner inside.
If the problem persists, replace the toner cartridge.
- The toner cartridge may be defective.
Remove the toner cartridge and check it for damage.
If the problem persists, replace the toner cartridge.

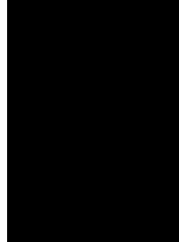

Pages are black

- The toner cartridge may be defective.
Remove the toner cartridge and check it for damage.
If the problem persists, replace the toner cartridge.
- Your fax machine's printer may be due for a service check.
Call your dealer.

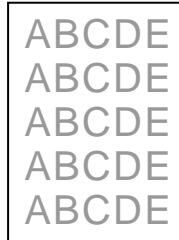

Printouts are too light

- The toner cartridge may be out of toner, or the toner may be very low.
Remove the toner cartridge and shake it a few times to redistribute the toner inside.
If the problem persists, replace the toner cartridge.
- The toner cartridge may be defective.
Remove the toner cartridge and check it for damage.
If the problem persists, replace the toner cartridge.

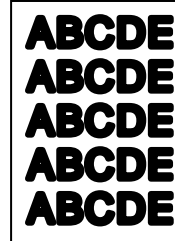

Printouts are too dark

- The toner cartridge may be defective.
Remove the toner cartridge and check it for damage.
If the problem persists, replace the toner cartridge.

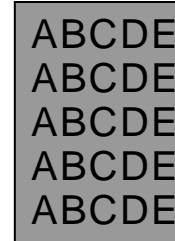

Printouts have a blurred background

- The toner cartridge may be defective.
Remove the toner cartridge and check it for damage.
If the problem persists, replace the toner cartridge.

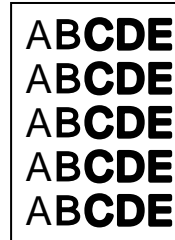

Printouts are of uneven density

- The toner may be unevenly distributed inside the toner cartridge.
Remove the toner cartridge and shake it a few times to redistribute the toner inside.
- The drum cartridge may be defective.
Remove the drum cartridge and check it for damage.
If the problem persists, replace the drum cartridge.

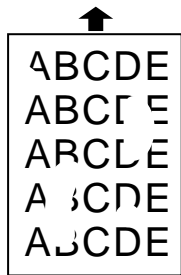

Printouts have irregularities

- The paper you're using may have absorbed moisture, perhaps due either to high humidity or water having been spilled on the paper supply. Toner will not adhere well to wet paper.
Replace the paper with dry paper and try printing again.

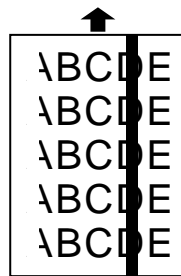

Printouts have white and/or black lines

- The toner cartridge or drum cartridge may be defective.
Remove the cartridges and check them for damage. If the problem persists, replace either or both of the cartridges as indicated.
- The charger may be dirty.
Your machine normally cleans the charger automatically. If other solutions fail, please contact your authorised Muratec dealer.

Printouts have black lines or multiple streaks

- The toner cartridge may have been stored improperly.
Try printing test pages to clear up the problem:
 - 1** Press **▶/PROGRAM**, one-touch **40**.
The fax will print one page of a chequered test pattern.
 - 2** After printing the page, the machine asks if you want to print another test page. The LCD shows:

Printer Test
Start/Stop

- 3** If the printing problem persists, press **START** to print another test page.
OR
- 4** Press **STOP** to cancel printing and return to standby mode.

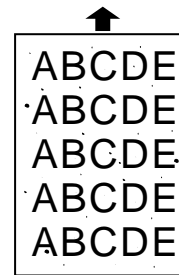

Printouts have toner smudges

- The toner may be unevenly distributed inside the toner cartridge.
Remove the toner cartridge and shake it a few times to redistribute the toner inside. If the problem persists, replace the cartridge.
- The toner cartridge or drum cartridge may be defective.
Remove the cartridges and check them for damage. If the problem persists, replace either or both of the cartridges as indicated.
- If you find smudges on the back of the printouts, the transport roller may be dirty.
Your machine normally cleans the transport roller automatically. If other solutions fail, please contact your authorised Muratec dealer.

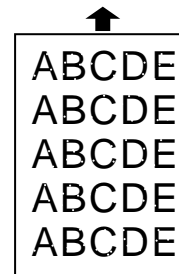

Printouts have white spots

- The charger may be dirty.
Your machine normally cleans the charger automatically. If other solutions fail, please contact your authorised Muratec dealer.

Troubleshooting

Occasionally, your fax machine encounters some trouble transmitting or receiving documents. When it does, it alerts you with an alarm. You can identify the problem with LCD messages and printed *check messages* and *error reports*, explained in the following pages.

Alarm

Your fax machine sounds an alarm tone –a series of short beeps –if either of these two problems occur:

- Trouble transmitting or receiving
- The machine is out of paper

LCD error messages

<i>What you see on the LCD</i>	<i>What it means/What to do</i>
All Commands In Use	Your fax machine has all of its 99 possible delayed commands (automatic redialling counts as one) stored in memory and cannot accept another. <i>Delete an existing command by using REVIEW COMMANDS, or wait until your fax has completed one of the delayed commands.</i>
Already Stored	You tried to enter a blocked number or department code which is already entered in the blocked numbers list or department code list for your fax machine. <i>Enter a different blocked number or department code.</i>
Box In Use	You tried to erase an F-Code box which has received at least one document. <i>Print the document(s), then try again.</i>
Call For Service	The scanner lamp is dim or inoperable. <i>Make repeated copies to help evaporate any internal moisture. If that doesn't solve the problem, call your authorised Muratec dealer or Muratec Customer Support.</i>

<i>What you see on the LCD</i>	<i>What it means/What to do</i>
Check Cassette Paper	The paper cassette is out of paper. <i>Add paper to the cassette.</i> ... or ... The paper cassette is open. <i>Close it.</i>
Check Paper Size	The paper size setting for the multipurpose tray (see page 1.8) isn't the same as the paper actually in the tray. <i>Either change the setting or change the paper so that they are the same.</i>
Check Rx Paper	Both the multipurpose tray and paper cassette are out of paper. <i>Add paper to the tray and/or the cassette.</i>
Check Tray Paper	The multipurpose tray is out of paper. <i>Add paper to the tray.</i>
Check # Of Pages	You placed fewer pages into the document feeder than you indicated in your page-numbering setting (see page 2.32). <i>To clear the error message, press STOP. Carefully recount the pages in your document, then re-try the transmission, being sure to enter the correct number of pages if you use the page-numbering function.</i>
Close Scanner Cover	The scanner cover is open. <i>Close it.</i>
Close Top Cover	The printer cover is open. <i>Close it.</i>
Communication Error	A communication error disrupted the reception or transmission. <i>If you were transmitting, press STOP to clear the error message and then re-try the transmission. If you were receiving a fax, try to contact the other person and have that person re-try the transmission.</i>
Document Full	You tried to store a document into an F-Code box or batch box, but your box has reached its capacity. <i>Delete an existing document in the F-Code box or batch box.</i>

Just in case ...

<i>What you see on the LCD</i>	<i>What it means/What to do</i>
Document Stored	You tried to erase a batch box which contains at least one document. <i>Erase the document(s), then try again.</i>
Enter No. (00-32)	You tried to enter a call group number greater than 32. Your machine can maintain 32 call groups, numbered 1-32 (call group 0 covers all the groups). <i>Determine the correct call group and re-enter its identifier number.</i>
Enter No. (01-99)	You tried to request "0" copies from your fax, which can create 1-99 copies of a document. <i>Re-enter the correct quantity.</i>
Feeder In Use	The command you tried to enter requires the use of the feeder, which is in use. <i>Wait for the fax to finish using the feeder, then try again.</i>
Hang Up Phone	The optional handset is off the hook. <i>Hang it up, making sure the upper part of the handset presses down on the "flash" button.</i>
In Relay Box	You tried to store or erase a document for polling in or from an F-Code box which is set to be a relay box. <i>Select an F-Code box which is set to be a bulletin box, then try again.</i> ... or ... You tried to print a document stored in an F-Code box, but it is set to be a relay box. <i>Select an F-Code box which is set to be a bulletin or secure box.</i>
In Secure Box	You tried to store or erase a document for polling in or from an F-Code box which is set to be a security box. <i>Select an F-Code box which is set to be a bulletin box, then try again.</i>
<i>What you see on the LCD</i>	<i>What it means/What to do</i>
In Use In P OneTouch	You tried to erase an F-Code box which is entered in a programmable one-touch key. <i>Erase the programmable one-touch key in which this F-Code box is entered, then try again.</i>
Insert Document	There was no document in the document feeder when you tried to send a fax or make a copy. <i>Place a document in the feeder and try again.</i>

<i>What you see on the LCD</i>	<i>What it means/What to do</i>
Invalid I.D. Code	The F-Code box I.D. code you entered isn't valid. <i>Try re-entering your F-Code box I.D. code.</i>
Invalid Number	You pressed a key which has no function for the current operation.
Invalid Passcode	The protection passcode you entered isn't valid. <i>Repeat the operation, entering the correct protection passcode.</i>
Line Busy	You tried to erase or print a document which someone is polling from your machine. ... or ... You tried to print a document during transmission.
Memory OverFlow	During transmission (or copying), you tried to enter more pages into memory than your fax could store. <i>Press START (or COPY) to tell your fax to keep as many pages in memory as possible, or press CANCEL to delete from memory all pages stored during this operation (but not previous operations).</i>
No Command	You pressed REVIEW COMMANDS to review upcoming commands or you requested a delayed command list, but your fax machine had none stored.
No Dept. Code	You tried to turn on the department code setting but there are no department codes stored in your fax machine. <i>Store at least one department code, then try again.</i>
No Document Stored	You tried to print a document from memory, but your fax machine doesn't have any stored.
No Number Stored	You selected an autodialler number for which there is no phone number programmed. <i>Either choose another autodialler number or dial a phone number directly from the numeric keypad.</i>
No Passcode	You tried to protect an operation or department code but there's no protection passcode stored in your fax machine. <i>Store a protection passcode in your machine, then try protecting the operation or department code again.</i>

<i>What you see on the LCD</i>	<i>What it means/What to do</i>
No PIN Number	You selected "Model1" in the PIN mask feature and tried to call using an autodialler number in which no PIN has been entered. <i>Enter a PIN, then try again.</i>
No Report	You requested an activity journal or confirmation report, but your machine has no record of any fax jobs that have occurred.
Please Call Service	The printer unit of your machine is inoperable. <i>Call your authorised Muratec dealer.</i>
Please Remove Paper	A paper jam occurred. <i>Remove the jammed paper</i> (review pages 3.1-3.2 if necessary).
Please Replace Drum	Your drum cartridge doesn't work. <i>Replace it, being sure to reset the drum counter.</i> (see page 1.7).
Please Supply Toner	The toner cartridge is empty. <i>Replace it.</i>
Please Wait	Wait until the fax machine warms up.
Polling In Use	You tried to store a polling document in your fax where one has already been stored. <i>Wait for the fax to complete the polling operation, then try again.</i>
Printer In Use	The command you tried to enter requires the printer, which is already in use. <i>Wait for the fax to finish printing, then try again.</i>
Protect Doc. Stored	A received document is in your fax's memory when you tried to turn off security reception or erase the protection passcode. <i>Print the received document from your fax's memory, then re-try the operation.</i>
Reset Document	Your document wasn't inserted correctly, or the fax to which you're sending can't handle the document's page length. <i>Reset the page and try again.</i>
Scanner In Use	The command you tried to enter requires the scanner, which is already in use. <i>Wait for the fax to complete the scan, then try again.</i>
Sub-Address In Use	You tried to enter a sub-address identical to one already being used in another F-Code box. <i>Enter a different sub-address.</i>

<i>What you see on the LCD</i>	<i>What it means/What to do</i>
Too Many Characters	You tried to enter too many numbers or other characters in the current operation. <i>Press CANCEL to delete the extra characters, then try again. You may want to review the operation's instructions.</i>
Too Many Locations	You tried to enter too many numbers for a broadcast transmission. <i>Press CANCEL to delete the extra numbers and try again.</i>

Errors

When sending faxes, your machine occasionally runs into *communications errors*. These can be caused by anything from lightning to telephone line interference. (These same factors cause the static, or *line noise*, you sometimes hear on phone calls.) They also can be caused by problems with the fax machine at the other end of the line.

Often, simply trying your call again is all that's necessary. However, *if the problem persists regularly*, call your local telephone company for help. If that doesn't help *and the problem persists regularly*, call your authorised Muratec dealer.

Error reports

When an error occurs, your fax machine prints an *error report*. Each fax error report lists an *error message* which includes:

- A possible *solution* to the problem
- The *sending location* (if the remote fax stores a Location ID of its own)
- The *result* –which is a special *error code*.
- A *sample* of the document's first page.

Kinds of error codes

The error code listed in the "Result" column of the error report indicates the specific problem encountered:

- "D" codes –Occur while *dialling*
- "R" codes –Occur during *reception*
- "T" codes –Occur during *transmission*

Specific errors

Following are some error codes you may see on an error report:

Dialling errors

- D.0.3 The remote unit didn't respond, the call couldn't be completed or **STOP** was pressed during dialling. *Re-try the call. If your machine repeats the message, call the remote fax unit's operator and verify that unit is operating properly.*
- D.0.8
- D.0.2 The remote unit is busy. *Try the call again.*
- D.0.6 Either the remote unit didn't respond, the call somehow didn't go through or
- D.0.7 **STOP** was pressed during dialling. *Try the call again.*

Reception errors

- R.1.1 The calling fax machine didn't respond to your fax machine. This can happen if someone dials a wrong number or if the remote machine restricts access through use of a passcode.
- R.1.2 The two fax machines were incompatible. Your fax machine sends and receives only ITU-T Group 3 (see Glossary, page 3.15) fax communication, the industry standard since the early 1980s.
- R.1.4 Someone pressed **STOP** at the receiving fax machine.
- R.1.5 The fax machine didn't detect the silence at the end of the call for receiving an RCR.
- R.2.3 Poor phone line conditions made fax communication impossible. *Call someone at the remote machine's location.*
- R.3.1 The sending fax machine detected too many errors from the receiving fax machine.
- R.3.3 The sending fax machine is incompatible or had a document feeder problem during transmission.
- R.3.4 Poor phone line conditions may have prevented your fax machine from properly printing some or all of the pages it received.
- R.4.2 Either the line disconnected before transmission or the transmitting fax machine needs maintenance.
- R.4.4 The fax machine has reached its memory capacity.
- R.5.1, ECM reception failed (perhaps due to line noise).
- R.5.2
- R.8.1 A compatibility error occurred.
- R.8.10 Line noise or other problems prevented line probing.
- R.8.11 The fax machine timed out while waiting for the retrain signal.

Transmission errors

- T.1.1 The remote fax machine didn't respond to your machine. *Call someone at the remote machine's location.*
- T.1.2 Your fax machine's page counter detected a possible document feeder error. *Carefully put the document back into the feeder and try the call again.*
- T.2.1 Either the phone line disconnected during transmission or fax communication became impossible due to bad phone line conditions. *Try the call again.*
- T.2.2 The two fax machines were incompatible. Your fax machine sends and receives only ITU-T Group 3 (see "Glossary," page 3.15) fax communication, the industry standard since the early 1980s.
- T.2.3 Bad phone line conditions made fax communication impossible. *Conditions can change rapidly, so try the call again later.*
- T.3.1 The page counter in your fax machine detected a document feeder error during transmission. *Carefully re-insert the document into the feeder and re-try the call.*
- T.3.2 The fax machine didn't detect the silence indicating the call had ended.
- T.4.1 The telephone line disconnected during transmission because of excessive modem errors or because remote unit ran out of paper. *Try the call again.*
- T.4.2 After transmission began, poor line conditions developed. *Try the call again.*
- T.4.4 Poor line conditions prevented transmission. *Try the call again.*
- T.5.1, ECM transmission failed (perhaps due to line noise). *Conditions can change rapidly, so try the call again later.*
- T.5.2,
- T.5.3
- T.8.1 A compatibility error occurred.
- T.8.10 Line noise or other problems prevented line probing.
- T.8.11 The remote fax machine didn't complete the equaliser training phase.

“Check Message” printouts

When there’s a problem with a fax call and your machine detects an error, it produces an error printout headed by the words “Check Message.” This printout lists the following information about the transmission:

- The resulting error code
- A communications error message (see “What error messages can mean,” below)
- The phone number (or TPI, if programmed) of the fax machine with which your machine had attempted to communicate.

What error messages can mean

The error messages on Check Message printouts can mean a variety of things. Here’s a brief summary:

Error message	Possible meanings
Check condition of remote fax.	<ul style="list-style-type: none"> • Remote machine malfunctioned • No “handshake” signals from remote fax • Wrong phone number reached
Repeat transmission.	<ul style="list-style-type: none"> • Poor phone line conditions • No “handshake” signals from remote fax • Document misfeed or miscount • Unable to reach remote machine after attempting specified number of redial tries
Line is busy.	<ul style="list-style-type: none"> • Remote machine’s line was busy • Remote machine’s line didn’t answer
Check received documents.	<ul style="list-style-type: none"> • Remote confirmation signal not received from remote fax • Poor line conditions caused a poor image
Memory full.	<ul style="list-style-type: none"> • Remote fax’s memory is full
Dialing number is not set.	<ul style="list-style-type: none"> • Stored phone number failed to dial properly
Stopped.	<ul style="list-style-type: none"> • Someone pressed STOP at the remote fax in the middle of the “handshake”

Caring for your fax machine

With proper installation and a little maintenance, your fax machine should give you dependable service for years to come.

Although it requires little day-to-day care, you can take these simple precautions to keep it in top form:

- **Always** make sure your fax machine is installed according to our specifications, including using an electrical surge suppressor. (If necessary, review “Pick an installation spot,” page 1.6.)
- **Always** use good, copier-quality paper.
- **Always** clean your fax machine as needed (see “Cleaning tips,” below).
- **Never** install your fax machine where it can overheat, gather dust or get splashed by any liquids (even water).

Cleaning tips

Some things to keep in mind about cleaning your fax machine:

- **Do** clean it! Dust and dirt, especially around the fax machine’s air vents can shorten your machine’s life.
- **Always** unplug the fax machine *before* you clean it.
- **Never spray any cleaner DIRECTLY onto your fax machine.** The drifting spray could damage components inside.
- **Never try to clean SEALED areas inside your fax machine.** They’re sealed to protect your safety and the machine.
- For cleaning *external* surfaces, such as the cover and handset: use a mild cleaning solution sprayed onto a lint-free towel or cloth.
- **Always** use a lint-free cloth (or swabs) moistened with alcohol to *gently* wipe components inside your machine.
- In areas you can’t reach with swabs, **always** use dry, dust-free compressed air to *gently* blow away dust and other material.

Keep the air vents clean

You should never cover your machine or it may overheat. However, dust can build up and *become* a sort of “cover.”

So be sure to **clean your machine’s air vents periodically.** When you do, use a vacuum cleaner or brush. **Do not** wipe the air vents with a damp cloth.

When looking at the machine from the front, the air vents are located on the left side of the machine (The drawing below is a view from the machine’s left rear):

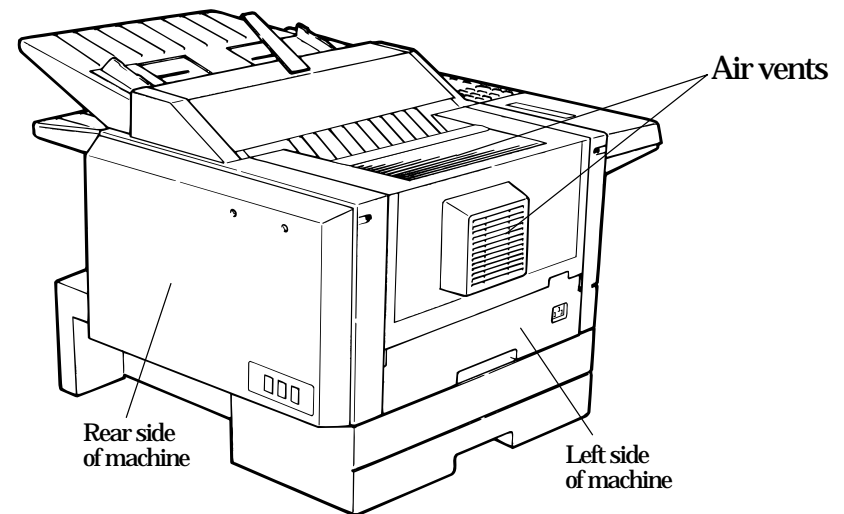

Corrective cleaning

Below are some simple cleaning tips for keeping your fax machine operating smoothly.

Curing frequent jams in the document feeder

If you're having trouble getting your original documents to feed properly, try this:

- 1 Turn off your fax machine.
- 2 Get two soft, lint-free cloths and moisten them as follows:
 - One with a cleaner suitable for use on platen/rubber rollers
 - The other with *isopropyl alcohol*

- 3 Press the scanner cover release and open the scanner cover.

Important: You must hold the cover open. It won't stay open by itself.

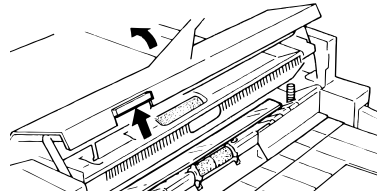

- 4 Use the cloth with the rollers cleaner to clean the *face* of the rollers. Rotate the rollers by hand to clean the entire roller surface.

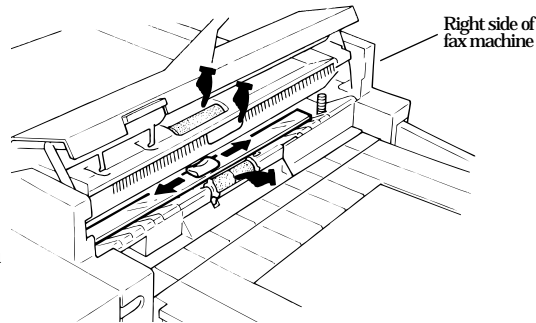

- 5 Use the cloth with the isopropyl alcohol to clean the *contact glass*.

- 6 Gently close the scanner cover, making sure both sides are snapped down securely.

If you have unsatisfactory printout quality

Your machine automatically cleans its *charger* and *transport roller*; two items which are very important to printout quality. If you notice poor printout quality, it may mean that your machine requires service. Review "Print quality problems" (pages 3.3- 3.4), and see if any of the proposed solutions helps your machine. If these don't help, please call your authorised Muratec dealer.

Common questions

General questions

- Q:** Where do I add ink or toner to make my fax machine's printouts darker?
- A:** *You can't adjust the darkness of an incoming fax printout, but you can adjust the darkness of a copy or of a transmission. Insert a document and press **CONTRAST** to adjust the contrast setting. "Dark" prints at the darkest setting. The machine will reset automatically to normal contrast after you finish copying or sending the fax.*
- Q:** When I unplug my machine or if the power goes off, will I lose the information I've stored – such as my **TTI**, autodialler entries, the time and date, etc. – and have to re-enter them?
- A:** No. There's a special battery built into your fax machine which protects user settings for several days if power fails or if you decide to move your machine. However, we do advise you to restore power to the machine as soon as possible.
- Q:** Can I use a dust cover on my fax machine?
- A:** No! A dust cover blocks air circulation, which could cause your machine to over-heat.

Sending faxes

- Q:** Sometimes, I try to send a fax while using either the optional handset or the **MONITOR/CALL** feature. But, when the other side answers, I hear a horrible screeching sound, so I hang up. What's happening?
- A:** That was the other fax machine trying to say "Hello" to your machine! You'll hear sounds like that any time you call a fax machine which is set to answer automatically (as when you set your machine to Auto Answer mode). It's by using these tones that fax machines are able to send faxes over ordinary phone lines. So, next time you hear the tones, press **START** (and, if you're using an optional handset, hang up) to send a fax.
- Q:** I just sent a fax. However, the number that appeared in my machine's display during the transmission wasn't the number I dialled. Why?
- A:** That number you saw is programmed into the remote fax machine by the user. Some users prefer different numbers to appear than the ones they're really using. And some people don't know how to change the number once it's set.

- Q:** Can I transmit and receive at the same time?
- A:** No. Use the call request feature (see page 2.31) to ask the person at the remote fax machine if he or she wants to transmit or receive after your fax communication is complete.
- Q:** How do I send a fax to an overseas telephone number?
- A:** Dialling requirements for international calls may vary depending on your local telephone company's requirements. For most international calls, call *010 or 00*, then dial the appropriate country code, city code and phone number. (You may find country and city codes in the front section of your telephone directory.)
- Q:** Can I transmit if my fax machine runs out of paper?
- A:** Yes, but confirmation reports (see page 2.28) are not available when you transmit without recording paper in your fax machine.
- Q:** Can I transmit a document that's extra long?
- A:** Yes, *if* the receiving fax machine is equipped to handle long documents. Many machines have a special setting which allows them to receive documents that exceed the normal length.
- Q:** Can I transmit a page from a newspaper?
- A:** No. A newspaper page can jam in your document feeder. First, use a copy machine to make an appropriately sized copy of the newspaper page, then transmit the copy.
- Q:** Can I transmit a page with correction fluid on it?
- A:** Yes, but only if the fluid is *completely dry* before you begin transmission.
- Q:** How can I be sure my fax was received?
- A:** Set your machine to print a confirmation report after each transmission (see pages 2.28).

- Q:** I don't want to install a dedicated phone line for my fax machine, so I've connected the machine to a PBX phone system. When I get a fax call, *all* the phones ring. How do I prevent this?
- A:** Call your PBX manufacturer or telephone company for assistance. They may be able to convert one of the PBX lines for use only by your fax machine.
- Q:** Sometimes when I dial a fax call by using either the optional handset or **MONITOR/CALL**, I don't hear the fax receiving tones from the other machine. Am I doing something wrong?
- A:** When this happens, try pressing **START** (and then hanging up the optional handset if you're using it), as usual. It's possible you're calling an older, non-standard fax machine that *doesn't* emit answering tones. Even a few Group 3 faxes (see "Glossary," page 3.15) on the market sound a *sending* tone but don't sound a *receiving* tone. After you transmit, call the person at the other fax machine's location to see if that person got your document.
- Q:** I inserted a document in the feeder and dialled a fax number, but my machine didn't transmit the document. Instead, "**** Auto Redial ****" now appears on my LCD. What does this mean?
- A:** The remote fax machine was busy, so your machine will try the call again, automatically. As long as it hasn't stored more than 99 delayed commands (counting automatic redials), your machine should still accept commands from you. If it has exceeded this quantity and will accept no more commands, try cancelling one of the delayed commands (see pages 2.18). If the machine *still* won't cooperate, keep cancelling commands until it does.
- Q:** The specifications (page A1.1) list an average per-page transmission time, but when I transmit a page it can take much longer. Why?
- A:** We base this specification on transmission of an industry-standard test document called *ITU-T Test Document 1* (sometimes also called the "Slerexe letter"). Fax manufacturers use this method to test transmission speeds. However:
- The pages you send may be darker, or otherwise contain more information, than ITU-T Test Document 1.
 - The transmission time measured for test documents doesn't include *handshake time* – the time during which two fax machines "introduce" themselves to each other and "agree on" the parameters of the call.
 - The specification time is based on the use of normal resolution mode. You may be using fine, superfine or greyscale transmission, each of which takes longer than normal mode.

Q: What's a *default*?

A: A default is a setting that your machine will always refer to if nothing else is programmed. For example, you can set the default for this machine to send a fax by using its memory. If you set this action as the default, that's how your machine will always send a fax, until you tell it to do differently.

Reports

- Q:** I called the number *011-555-555-1212*, but not all of the digits appear on my transmit confirmation report (TCR). Why didn't the whole number appear? How can I be sure my document went to the right location?
- A:** The numbers you enter using the fax keypad are temporarily stored in a memory "buffer", and it's only the last part of the phone number that the buffer "remembers." An easy way to avoid getting incomplete telephone numbers on your printouts is to store your most frequently used numbers as one-touch keys or speed-dial numbers. These autodialler numbers will appear in their entirety on your TCR.

Receiving faxes

- Q:** My fax never answers. What's wrong?
- A:** Check to make sure your fax machine is properly connected to a working AC power outlet and phone jack (see pages 1.6- 1.8). If you're using a second phone with your machine, make sure *it's* connected properly (page 1.9).
- Q:** Sometimes when I answer my machine with the optional handset, I hear a beeping sound that repeats every few seconds. Is this a fax?
- A:** Yes. When you hear these *fax tones*, someone is trying to send you a fax. Next time, press **START** and hang up the handset. Your fax will receive the message.
- Q:** Does my fax machine have to be plugged in to the AC power jack to receive a message?
- A:** Yes. Your phone will ring if the phone line is connected, but you can't receive a fax unless your fax machine is plugged into both the phone jack and the AC power jack. Make sure your fax machine is always plugged in so you never miss an important fax message.
- Q:** Can I receive a fax if I'm using the phone on my machine?
- A:** You can receive a fax from the person to whom you're talking. When that person has a document ready in his/her machine's feeder, press **START**.

Working with your answering machine

- Q:** People have complained that they call my fax machine and hear my answering machine's message, but are cut off before they can send a fax. What happened?
- A:** Any remote fax machine attempting to send a fax must "hear" responding fax tones within 40 seconds after the person at that machine presses the start key. That 40 seconds includes getting the dial tone, dialling the number, "listening" to the pause before the ringing starts and the remote fax machine answering the ring. Only after that time does your message play. That's why we urge you to create a short outgoing message. The shorter the waiting period, the more likely it is that the remote fax machine will proceed with the transmission. Please create an outgoing message on your answering machine that's no longer than 10 seconds (see page 1.20 for a suggestion).

Polling

- Q:** What's the purpose of polling?
- A:** Polling lets you automatically "pull" a document which is set in another fax machine. You can poll whenever you need to retrieve information and don't want the source to pay for the phone call. With polling, you pay for the call and get the information you need.

How your fax machine works

How a fax machine works is simple:

You put a page into your fax machine's feeder and call a fax number. Your machine makes a satisfactory connection with the other machine, and then ...

- *Your machine takes the document.*
An image scanner in your fax machine examines the information on the page.
- *Your machine wraps the document.*
Your fax machine translates the scanned information into a numeric code and compresses the code for the fastest possible transmission speed.
- *Your machine sends the document.*
Finally, your fax machine sends the compressed code.

On the other end of the line ...

- The remote fax machine *receives* the code.
- Your machine *unwraps* the document.
The remote fax machine uncompresses and deciphers the code, turning it into a representation of the scan your machine made.
- The remote fax machine prints the representation.

The only difference between a regular telephone call and a fax call is the *content* of the transmission:

- On a regular call, your telephone sends your voice.
- On a fax call, your fax machine sends a coded image.

The way fax machines work is regulated closely by the International Telecommunications Union (ITU), an agency of the United Nations. The standards the ITU applies ensure the compatibility of your fax machine with millions of other machines world-wide. However, they also limit the way you can use your machine with other devices, such as telephones and answering machines.

Glossary

This glossary contains terms you may encounter when discussing or reading about fax machines. Please use these definitions for reference only.

24-hour format – Also called *military format*. A format for keeping time that does not use a.m. or p.m. to distinguish between morning and afternoon. In the 24-hour format, one o'clock in the morning marks 1:00, noon marks 12:00 and midnight marks 24:00. To calculate the 24-hour format, add 12 hours to all times after noon.

For example, *1:30 p.m.* would be *13:30* in the 24-hour format; *10:45 p.m.* would be *22:45* in the 24-hour format. And *11:15 a.m.* would be *11:15* in the 24-hour format.

A3, A4, B4 – Standard stationery sizes defined by the International Standards Organisation, an agency of the United Nations. See also *Paper sizes*.

ADF – Automatic document feeder. See *document feeder*.

Alternate number – The number your machine dials after all attempts to the regular number fail. The user programs this alternate number, if so desired.

Answering machine – See *TAD*.

Autodialling – Enables user to store preprogrammed telephone numbers in the unit's memory. Storage capability varies from unit to unit.

Automatic fallback – The ability of a fax machine to slow down ("fall back"), when communicating with another fax which is communicating at a slower rate.

Automatic reduction – Many Muratec fax machines will automatically reduce the size of documents being transmitted to accommodate the effective printing width of the receiving unit. For example, this allows a fax machine with a 10" scanning width to send an image 10" wide to a unit with an 8.5" print width. The receiving fax machine will receive a reduced-size printout of the complete image.

Bit – The smallest unit of information in a computer. Some Muratec fax machines, which are actually computers "dedicated" to telecommunications, allow users to change bits of information to provide or cancel features through software settings.

Bits per second – See *bps*.

Black density – Also called *black coverage*. The amount of non-white area on a page. For example, most regular office correspondence has a black density well under 10%, due to the presence of margins, spaces between words, spaces between lines and paragraphs and even spaces within letters. However, drawings and photographs have a much higher black density, sometimes approaching 100%. The higher a page's black density, the more slowly a fax machine sends it.

Broadcast – A fax transmission in which a single document is sent to more than one location.

bps – Bits per second. Used to express the speed of transmission of data. Because fax transmission treats a document as a graphic image rather than as a series of alphabetic and numeric characters, bps does not correspond to the number of characters transmitted per second.

Byte – A group of digital elements, usually sent as eight bits to the byte.

Call reserve – Also called *call request*. An ITU-T standard fax feature which allows a user to request voice communication prior to, during or after transmission.

Call-waiting service – An optional telephone company service that alerts you to another incoming call when the phone is already in use. Call-waiting signals often cause interruption of fax transmission or reception.

Caller ID – Optional service provided by your local telephone company that allows you to see a display of the number (phone or fax) that is calling.

CCITT – See *ITU-T*.

CCD, CIS – Charged coupled device, contact image sensor. Two types of scanning mechanisms used in some Muratec fax machines. The CCD "reads" fluorescent light bouncing off a document. The CIS uses a flat bar of light-emitting diodes (LEDs).

Command queue – The "list" your machine keeps of all its pending commands.

Command number – The number your machine gives to each "job" it is programmed to complete. You must know the command number in order to cancel or change any of the machine's jobs that it stores.

Compatibility – The term "compatible" describes the ability of separate things to function together. Your Muratec fax machine features ITU-T Group 3 compatibility, the modern standard for world-wide communication.

Confidential transmission – See *SecureMail*.

Confirmation report – See *RCR* and *TCR*.

Continuous polling – See *Polling*.

Copy mode – Allows your fax machine to be used as a convenience copier.

Cover page (automatic) – A small, user-created message; can be the first page of every transmission.

Database polling – See *Polling*.

Data compression – Used in digital fax machines to speed transmission. See also *Digital fax*, *MH* and *MSE, SMSE*.

Default – The setting your machine will always refer to if no other action has been programmed. For example, you can set the default for this machine to send a fax by using its memory. If you set this action as the default, that's how your machine will always send a fax, until you tell it to do differently.

Delayed command – Transmission or polling operation set by the user to occur later, automatically, at a predetermined time. Great for reducing costs by making fax calls during times when telephone costs are lowest, such as late at night or on weekends.

Digital – Using the binary system (which uses a combination of *0s* or *1s*) to describe everything, so that *0* means *off* and *1* means *on*; digital fax machines convert the graphic image of your document into a series of zeros and ones by using the binary system of transmission to encode black and white occurrences. This increases transmission speed by passing over white spaces. See also *White-line skip*.

Digital fax – Unlike analogue systems that scan every portion of a document, digital fax machines survey a document's overall picture content. Digital fax machines scan a line and convert the information into a binary code of zeros and ones. The fax machine takes this information and compresses it, providing high transmission speeds. Many Muratec units offer proprietary methods for faster transmissions between Muratec-manufactured units (see also *MSE*, *SMSE*).

DIP switches – Dual in-line package switch; a two-position on/off switch. Many Muratec fax machines include DIP switches to control optional settings or features.

Document feeder – The adjustable slot into which users place documents for faxing or copying.

Effective printing width – The widest image that can be printed on a fax.

Effective scan width – The maximum width the scanner in a fax can scan during transmission.

F-Code – A fax-industry standard created by the ITU-T for sub-addressing/password-based communications. Because F-Code is an industry standard, Muratec fax machines as well as all ITU-T equipped fax machines from other manufacturers can communicate with each other using sub-addressing.

Facsimile (or fax) – A form of communication involving the scanning and decoding of a document into electrical signals and transmitting of the document, over telephone lines to another device. This device then reconstructs the signals to produce an exact duplicate of the document. Also, a machine that performs such communication.

Fallback – Group 3 fax machines operate at the highest transmission speed possible on a given telephone line. Muratec systems offer automatic fallback; if line quality drops during transmission, the fax machine will reduce speed to the fastest possible level.

File number – A number the machine gives to each document it stores for a batch, F-Code or polling operation.

Fine resolution – 8 dots/mm H × 7.7 lines/mm V. Also shown as *G3F* ("Group 3 fine") on some fax units.

Greyscale – Not a level of resolution, but a method of scanning and transmitting halftone images. Fax machines with greyscale abilities interpret photographs in levels of grey between white and black. The transmitting fax machine must have greyscale ability to send a photographic image accurately, but the receiving machine does not need it to print the image.

Group 3 – Refers to fax machines that use digital encoding. These units transmit one page in less than one minute and produce resolution of 8 dots/mm H × 3.85 lines/mm V, 8 dots/mm H × 7.7 lines/mm V, 16 dots/mm H × 15.4 lines/mm V.

Halftone – See *Greyscale*.

Handshaking – An exchange of data between telecommunications and/or computer equipment that "introduces" two systems to each other. For example, faxes use a handshaking protocol to identify the ITU-T group of each unit and to begin fax communication.

Hub – See *Relay broadcasting*.

Hz (or Hertz) – A measure of frequency equal to one cycle per second. Used in the specifications for a fax machine, it identifies the AC power the unit requires.

ITU-T – International Telecommunications Union - Telecommunications Sector. (Formerly known as *CCITT*, for *Consultative Committee for International Telegraph and Telephone*.) A telecommunications forum for member countries of the United Nations whose Study Group XIV established the primary groups for fax equipment, covering communication protocol and transmission. Muratec Group 3 fax machines offer the fastest transmissions allowed by the ITU-T when communicating with other Group 3 units.

ITU-T Test Document 1 – Also called the *Slerexe* ("*slehr-rehks*") letter; An ITU-T standard document with a known black density which fax makers often use to test transmission speeds of their fax machines. Published transmission speeds are also based on this document.

ITU-T v.29 and v.27 ter. – A standard set of communication procedures allowing fax machines to talk to all other units adhering to those standards.

JBIG – Joint Bi-level Image experts Group, the new ITU-T standard image data compression method. As JBIG compresses the data more efficiently than MMR, it is especially effective when transmitting halftone (greyscale) image document. (Of course, the compression ratio may vary with the image data.)

Laser printing – A plain-paper printing system. Toner is attached to a charged drum and an image is transferred onto plain paper through electrical currents, then fused with heat and pressure to produce a dry, permanent printout.

LCD – Liquid crystal display. Used on some Muratec units for status displays.

Leased line – See *Private line*.

Load number – A number assigned to telecommunications equipment used in Canada; designed to help prevent overloading on a telephone circuit. See also *Ringer equivalence number*.

Location ID – See *Station ID*.

lpi – Lines per inch. The way fax image resolution is measured.

Memory – Internal document storage. In Muratec fax machines, random access memory in the form of computer chips is used to store and hold documents for transmission and to hold some documents that have been received.

Memory overflow – A message that appears on the machine's LCD when the current operation requires more of the machine's electronic memory than what is available.

MH – Modified Huffman, the standard ITU-T Group 3 data compression method. A one-dimensional coding scheme that compresses data in a horizontal direction only. A feature of all Muratec fax machines, MH assures transmissions faster than one page per minute when communicating with other Group 3 units, regardless of manufacturer. See also *MR, MMR, MSE, SMSE*.

Military format – See *24-hour format*.

Modem – Modulator-demodulator. A device that converts digital data, like information from a fax machine, into an analogue signal for transmission over ordinary telephone lines. A modem is included in a fax machine and allows it to be connected directly to a PSTN telephone line.

MR – Modified Read, an ITU-T Group 3 standard data compression method. A two-dimensional coding scheme that compresses data in both horizontal and vertical directions and allows for faster transmission when communicating with other Group 3 units, regardless of manufacturer. See also *MH, MMR, MSE, SMSE*.

MMR – Modified Modified Read, an ITU-T Group 3 standard data compression method. A two-dimensional coding scheme that compresses data in both horizontal and vertical directions and allows for faster transmission when communicating with other Group 3 units, regardless of manufacturer. See also *MH, MR, MSE, SMSE*.

Monitor – A speaker in most Muratec fax machines which allows the user to hear the dialling process. This is not a speakerphone, because it has no microphone for speaking to the person being called. For regular two-way voice communication, users must use the optional handset. See also *On-hook dialling*.

MSE, SMSE – Muratec's proprietary data compression methods, allowing a Muratec-manufactured fax machine to transmit more quickly when communicating with another Muratec-manufactured unit. MSE and SMSE are features on many Muratec fax machines. See also *MH, MR, MMR*.

Multi access – Multi access allows your Muratec fax machine to perform four or more tasks simultaneously without slowing.

Normal resolution – Shown as "norm"; 8 dots/mm H × 3.85 lines/mm V. The default resolution mode for all Muratec fax machines.

One-touch dialling – Allows the fax user to store frequently used fax numbers for dialling with the touch of one key. See also *Autodialling* and *Speed-dialling*.

On-hook dialling – Dialling numbers by using the keypad on the fax unit without lifting a handset. On most Muratec fax models, the user can do this either silently or by using the monitor. See also *Monitor*.

Original document size – The largest (or smallest) document that can be fed safely through a fax machine.

Override – To change existing settings.

Paper sizes – All are width × length:

Letter-sized = 8.5" × 11.0" (216 × 279 mm)	Legal-sized = 8.5" × 14.0" (216 × 356 mm)
A5 = 5.8" × 8.3" (148 × 210 mm)	A4 = 8.3" × 11.7" (210 × 297 mm)
A3 = 11.7" × 16.5" (297 × 420 mm)	B5 = 7.2" × 10.1" (182 × 257 mm)
B4 = 10.1" × 14.3" (257 × 364 mm)	

Passcode – A four-digit code-number. On your fax machine, the protection passcode lets the user limit access to fax operations, as well as certain settings and even documents readied for polling (in the case of polling, only calling machines whose users enter the proper passcode will be able to poll the document.)

PBX (or PABX) – Private branch exchange; privately-owned telephone equipment serving a particular building, business or area. Many PBX systems use digital transmission lines which, unlike more common PSTN lines, are not compatible with fax machine use. The user should not connect a fax unit to a PBX without first checking with the system manufacturer or service representative.

PCL – Page Control Language. An industry standard for printer control. Some Muratec fax machines include or offer PCL-compatible printing for Windows-based personal computers.

Platen – A traditional copier-style top to a fax machine or digital copier. Some Muratec fax machines and multifunctional products include a platen top, allowing you to fax from books and other awkward sources.

Polling – Automatic transmission to a calling remote fax, or reception of a document from a remote fax set for this operation. Polling is convenient whenever a central unit must receive information from one or several remote faxes. The caller bears all telephone charges and prevents several remote units from calling at the same time. See also *Secure polling*.

Private line – (Or *leased line*.) A service offered by many telephone systems; provides an exclusive phone circuit between two geographic points. A Muratec fax does not require a private line. See also *PSTN*.

Proprietary – Non-standard. In fax, refers to a fax feature which works only in communications between fax machines that are the same brand.

PSTN – Public switched telephone network; the most common type of telephone lines and service in use, in contrast to private or leased lines. A Muratec fax provides fast, reliable data transmission over a PSTN line, and does not need a special or dedicated telephone line. See also *Private line*.

RCR – Receive confirmation report. An RCR is your assurance that the document you transmitted was received. The RCR prints after your transmission, identifying the receiving unit and recording the date, time, transmission mode, number of pages sent and the result. The RCR is an exclusive feature of Muratec fax machines and is available only when transmitting to other, compatible Muratec fax machines. See also *TCR*.

Receiver ID – See *Station ID*.

Redialling – The dialling again, either manually or automatically controlled, of the most recently dialled fax or phone number. Automatic redialling follows an unsuccessful dialling attempt and can be done manually or automatically.

Relay broadcasting – Lets some Muratec fax machines store a document in internal memory, transmit the document to the memory of a remote “hub” fax and then instruct that unit to relay (re-transmit) the document to each fax in a call group in the “hub” unit. This feature speeds extremely high-volume fax communication and allows a single command to initiate document transmission to hundreds of preprogrammed fax locations. It also saves phone charges for the originating machine. Your machine can initiate a relay broadcast.

Remote fax machine – The machine on the other “end” of a fax communication.

REN – See *Ringer equivalence number*.

Resolution – The resolution of documents transmitted or copied by fax machines is measured by the number of horizontal (H) dots per millimetre and vertical (V) lines per millimetre the unit can print. A Muratec unit may offer one or more of these resolution levels:

Normal	8 dots/mm H × 3.85 lines/mm V
Fine	8 dots/mm H × 7.7 lines/mm V
Superfine	16 dots/mm H × 15.4 lines/mm V

Some Muratec units also offer greyscale transmission (see also *Greyscale*) for accurate reproduction of photographs and other shaded originals.

Ringer equivalence number – Also called *REN*. A number assigned to telecommunications equipment used in the United States; designed to prevent overloading on a telephone circuit. See also *Load number*.

Scanning width – See *Effective scanning width*.

SecureMail – Allows a Muratec fax user to send a document to or receive one into (usually something confidential) an “electronic mail box.” The transmission is protected at the receiving Muratec fax by an access code; the receiving fax prints the document only when an authorised user enters the code.

Secure polling – Polling in which preset passcodes are checked between two machines before polling is allowed to take place.

Speed-dialling – Allows the fax user to store frequently used fax numbers for dialling with the touch of three keys – an identifier key (either * or #) and then a three-digit code – for each number. See also *Autodialling* and *One-touch dialling*.

Station ID – (Also called *Location ID* or *Receiver ID*.) An autodialler feature which lets the fax user enter a descriptive name to correspond with the number in an autodialler entry. For example, rather than entering only *1-972-555-3465*, the user can enter that number and a name, such as *Dallas Branch Office*. (Many Muratec models with this feature allow entry of both upper-case and lower-case letters, for greater ease of reading.)

Subaddressing – An ITU-T standard allowing fax machines to specify special delivery characteristics of a transmission. For example, subaddressing allows fax machines from different manufacturers to send and receive messages into confidential memory mailboxes, or to retrieve specific files from polling memory.

Subscriber ID – A fax machine’s telephone number, as identified by a user setting. See *TTI*.

Super Group 3 – An extension of Group 3 fax technology standards, allowing the use of high-speed v.34 bis modems for 33.6 Kbps transmission and high-speed protocols for rapid handshaking.

Superfine resolution – 16 dots/mm H × 15.4 lines/mm V. Your Muratec fax machine’s superfine transmission mode is Group-3-compatible, not the more limited proprietary version.

TAD – Telephone answering device, or answering machine. Records incoming voice messages for playback. You can connect a TAD to a Muratec fax machine and use the two on one phone line.

TCR – Transmit confirmation report; this provides proof that your Muratec fax did send the document you set for transmission. Printed after transmission, the TCR also identifies the telephone number to which the fax sent the document, plus the actual time of transmission and how many pages the unit transmitted. See also *RCR*.

Thermal (paper) printing – A thermal head heats chemically treated, thermally sensitive paper in patterns conforming to the image the machine has scanned, creating a printed image. Thermal paper’s tendency to discolour and fade, in addition to its curliness and the usual difficulty in writing on it, have made this method considerably less popular than plain-paper fax printing – particularly as plain-paper fax machines have dropped sharply in price.

Triple access – Triple access allows a Muratec fax machine to perform three tasks simultaneously without slowing.

TTI – Transmit terminal identifier. A user-programmable line of information sent automatically with every page a fax machine sends; it appears at the top of each page printed by the receiving unit.

Transmission speed – How fast a fax machine is sending a fax document. This speed depends upon the modem speed of each unit, the resolution setting, the content of the document, the encoding technique and the condition of the phone line (clean, noisy, etc.) Any change in any one of these five conditions will affect the speed, sometimes significantly.

v.29 and v.27 ter – A standard set of communication procedures allowing fax machines to talk to other units using those standards. Specifically, these standards cover fax transmission at 9600 bps or slower.

v.34 – An international standard for fax modems – and other modems – with transmission speeds of up to 28.8 Kbps. The v.34 protocol is sometimes referred to as “v.Fast”, because it represented a significant increase in possible transmission speed compared to the transmission protocol it replaced.

v.34 bis – A faster version of the v.34 standard, and sometimes referred to as “v.34 Plus” or “v.34 +”. The v.34 bis protocol allows transmission at up to 33.6 Kbps, and represents the current maximum standard transmission speed possible under ITU-T Group 3. (The term “bis” is French, and designates the “second” version of the protocol.)

White-line skip – A technique used to speed up fax transmission by bypassing redundant areas, such as white space.

This page intentionally blank.

Appendix and index

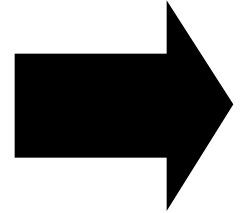

Specifications	AI.1
Index	AI.2
Safety information	AI.5

Specifications

Type: Desktop Laser plain paper facsimile.

Phone line: Normal Public Switched Telephone Line (PSTN) or equivalent.

Modem speed:

- 33,600, 31,200, 28,800, 26,400, 24,000, 21,600, 19,200, 16,800, 14,400, 12,000, 9,600, 7,200, 4,800 and 2,400 bps

Compatibility: ITU-T Super Group 3, Group 3.

Data compression method: ITU-T-standard JBIG, MMR, MR and MH, Murata-proprietary MSE.

Transmission speed: 2 seconds per page.*

Document feeder capacity: 50 pages (20-pound bond paper).

Resolution (horizontal in dots/mm × vertical in lines/mm):

	Transmission:	Copy:
Normal	8 × 3.85	12 × 7.7
Fine	8 × 7.7	12 × 11.5
Superfine	16 × 15.4**	16 × 15.4
Greyscale	8 × 7.7 (Memory Tx) 16 × 15.4** (Feeder Tx)	12 × 11.5

Greyscale: 256-level, in feeder Tx or copy; 64-level, in memory Tx.

Printing width: 202mm.

Scanning width: 252mm or 208mm, user-selectable.

Scanning method: Flatbed CCD.

Printing method: Dry, electrophotographic (laser) process.

Consumables yield: Drum cartridge, 20,000 pages; regular toner cartridge, 5,500 pages; starter toner cartridge, 3,600 pages.***

Recording paper capacity: Paper cassette, 500 A4-sized sheets; multipurpose tray, 150 A4-sized sheets.

Acceptable document size (width × height):

Single sheet – 280mm × 900mm maximum, 148mm × 105mm minimum.

Two or more sheets – 257mm × 364mm maximum, 148mm × 105mm minimum.

Weight: 18.3 Kg (40.3 pounds)

Dimensions (width × depth × height): 489mm × 531mm × 371mm.

Power: 230v ± 10%, 50-60 Hz.

Operating environment: Environmental Temperature; 10°C to 35°C (50°F to 95°F)
Relative Humidity; 15 to 85% RH

* Based on transmission of ITU-T Test Document 1 to a Muratec fax machine. Your transmission times will vary, but your Muratec fax machine always will provide the fastest transmission speeds possible under ITU-T guidelines and phone-line conditions.

** In the case that the remote fax has the ability of "16 × 15.4".
If not, the superfine resolution is "8 × 15.4", and the greyscale resolution in feeder transmission is "8 × 7.7".

*** Based on A4-sized sheets, 4% document coverage and continuous printing.

Index

A

Activity journal 2.27
 Alternative telephone network 2.33-2.34
 Alphanumeric directory See *EasyDial*
 Ans/Fax Ready mode 1.19
 Answering machine (not included with fax machine), attaching 1.9
 Answering, setting number of rings 2.4
 Attaching (your) second phone 1.9
 Audible alarm 2.33
 Autodialler 2.7-2.15

B

Batch transmission 2.20-2.23, 2.50-2.51
 Block Junk Fax 2.64-2.65
 Broadcasting 2.16, 2.47-2.49

C

Call groups 2.8, 2.14
 Call request 2.31
 Call-waiting, possible trouble with 1.13
 Cancelling commands 1.16, 2.18
 Cleaning your fax machine 3.10-3.11
 Clearing jams
 Document, original 3.1
 Printout 3.1-3.2
 Clearing settings before using EasyStart 1.10
 Closed network 2.64
 CODE key, using 2.2
 Communications problems 3.5-3.9
 Alarm 3.5
 "Check Message" printouts 3.9
 Errors, Error codes, printouts 3.7-3.8
 LCD error messages 3.5-3.7
 Confidential communication 2.59-2.67
 Confirmation reports 2.28
 Confirmation stamp 2.6
 Continuous polling See *Polling*
 Contrast 1.12
 Control panel 1.2, 1.4-1.5
 Copying 1.21
 Copy & Fax 2.25
 Copy and print reduction 2.2-2.4

Cover page 2.26

D

Date and time, setting 1.10-1.11
 Delayed transmission 2.17-2.19
 Department code 2.66-2.67
 Department code protection 2.67
 Department time list 2.67
 Dial prefix number 2.33
 Dialling upon the power failure 1.22
 Directory dialling See *EasyDial*
 Document guidelines 1.12
 Document, inserting 1.14
 Drum cartridge, installing 1.6
 Drum counter, resetting 1.7
 Dual access See *Multi access*

E

EasyDial 1.22, 2.15
 EasyStart 1.10-1.11
 Electrical requirements 1.6, AI.1
 Electrical surge suppressor 1.6
 Error Correction Mode (ECM) 2.4
 Errors See *Communications problems*
 Extension telephone (yours; not included with fax machine)
 Connecting 1.9

F

F-Code communication
 Create F-Code box 2.35-2.39
 Erase an empty F-Code box 2.42-2.43
 F-Code transmission and polling 2.43-2.44
 Print a list of document stored in F-Code box 2.39
 Print a list of F-Code boxes 2.39
 Using a bulletin box 2.39-2.41
 Using a relay box 2.42
 Using a security box 2.41-2.42
 Fax Ready mode 1.18
 Fax/Tel Ready mode 1.18
 Fine resolution 1.1, 1.12, 2.1, AI.1

- G**
Greyscale 1.1, 1.12, 2.1, AI.1
- H**
Handset (optional), summary of installation 1.9
- I**
Inserting pages (for faxing or copying) 1.14, 1.21
Installation
 AC power line connection 1.8
 Answering machine (yours) 1.9
 Drum cartridge 1.6
 Fax machine, location of 1.6
 Handset and handset cradle (optional) 1.9
 Phone line connection 1.8
 Power line connection 1.8
 Paper for printouts 1.7
 Paper-handling parts 1.8
 Telephone (yours) 1.9
 Toner cartridge 1.6-1.7
- J**
Jammed paper, removing 3.1-3.2
Journal 2.27
"Junk fax," blocking 2.6 4-2.65
- L**
Language, setting 2.6
Larger documents, adjusting machine for 1.13
Light contrast 1.12, 2.1
Line connections See *Installation*
Location ID 2.7, 2.8-2.13, 2.15
- M**
Making copies 1.21
Memory overflow error message 3.6, 3.7-3.8
Memory transmission 1.13
Monitor speaker, setting volume of 1.8-1.9
Multi access 2.32
Multipurpose tray 1.7, 1.8
- N**
Normal resolution 1.1, 1.12, 2.1, AI.1
Numbering pages 2.32
- O**
One-touch numbers 2.7, 2.8-2.11
 See also *Programmable one-touch keys*
Operation protection 2.59-2.60
Outgoing message for (your) connected answering machine 1.20
Out-of-paper reception 1.20
- P**
Page numbering 2.32
Paper cassette 1.7
Paper for printouts 1.7
Passcode protection 2.59
Pause character, entering 1.12-1.13, 2.7
PBX, using with 3.13
PIN mask 2.61-2.63
Polling 2.29-2.31, 2.49-2.50
 Being polled 2.30
 Continuous 2.30
 Passcode protection for 2.31
Power consumption 1.6, AI.1
Printing machine settings 1.10-1.11, 2.6
Print and copy reduction 2.2-2.4
Print quality problems 3.3-3.4
Program list, printing 2.6
Programmable one-touch keys 2.45-2.58
- Q**
Quick memory transmission 2.29
- R**
RCRS (receive confirmation reports) 2.28
Receiving faxes (basic instructions) 1.17-1.20
Redialling 1.15-1.16
Reduction, print and copy 2.2-2.4
Relay broadcasting (ITU-T) 2.35-2.42
Reports, confirmation (TCR and RCR) 2.28
Requirements, phone and electrical 1.6, AI.1
Resolution 1.1, 1.12, 2.1, AI.1
Review Commands 1.16, 2.18-2.19
Rings, setting number on which to answer 2.4

S

Security reception	2.60-2.61
Security transmission	2.63
Sending faxes (basic instructions)	1.12-1.16
Settings list, printing	1.10-1.11, 2.6
"Silent" fax machine, detection of	1.20
Silent mode	2.5
Soft key	2.24
Speaker, monitor, setting volume of	1.8-1.9
Special dialling characters	2.7
Special features	2.24-2.34
Specifications	AI.1
Speed-dial numbers	2.7, 2.11-2.14
Stamp, transmission confirmation	2.6
Subscriber ID	1.10-1.11
Superfine resolution	1.1, 1.12, 2.1, AI.1
Surge suppressor	1.6

T

TCRS (transmit confirmation reports)	2.28
Telephone features	1.22
Time and date, setting	1.10-1.11
Toner cartridge, installing	1.6-1.7
Transmission	<i>See Sending faxes</i>
Troubleshooting	3.5-3.9
Transmit Terminal Identifier (TTI)	1.10-1.11

U

Unpacking	1.2
User settings	1.10-1.11, 2.1-2.6

V

Verification stamp	<i>See confirmation stamp</i>
Voice mail, possible trouble with	1.13
Volume setting for monitor speaker	1.8-1.9
Voltage requirements and power consumption	1.6

Safety information

Laser safety

This fax machine contains a page printer which operates by means of a laser. There is no possibility of danger from the laser, provided the fax machine is operated according to the instructions provided in this manual.

Since radiation emitted by the laser is completely confined with a protective housing, the laser beam cannot escape from the machine during any phase of user operation.

Internal laser radiation information

For all users

Maximum radiation power: 5.0×10^{-4} (w) Wavelength: 770-810 (nm)

This is a Class IIIb laser diode assembly that has an invisible laser beam. The printer head unit is NOT A FIELD SERVICE ITEM. Therefore, the printer head unit should not be opened under any circumstances.

For United States users

Laser safety

This fax is certified as a **Class 1** laser product under the U. S. Department of Health and Human Services (DHHS) Radiation Performance Standard according to the Food, Drug and Cosmetic Act of 1990. This means that the fax machine does not produce hazardous laser radiation.

CDRH regulations

The **Center for Devices and Radiological Health** (CDRH) of the U. S. Food and Drug Administration implemented regulations for laser products on August 2, 1976. Compliance is mandatory for products marketed in the United States. The labels shown in the graphic (see right column) indicates compliance with the CDRH regulations and must be attached to laser products marketed in the United States.

Warning: Use of controls, adjustments or performance of procedures other than those specified in this manual may result in hazardous radiation exposure.

Warning labels

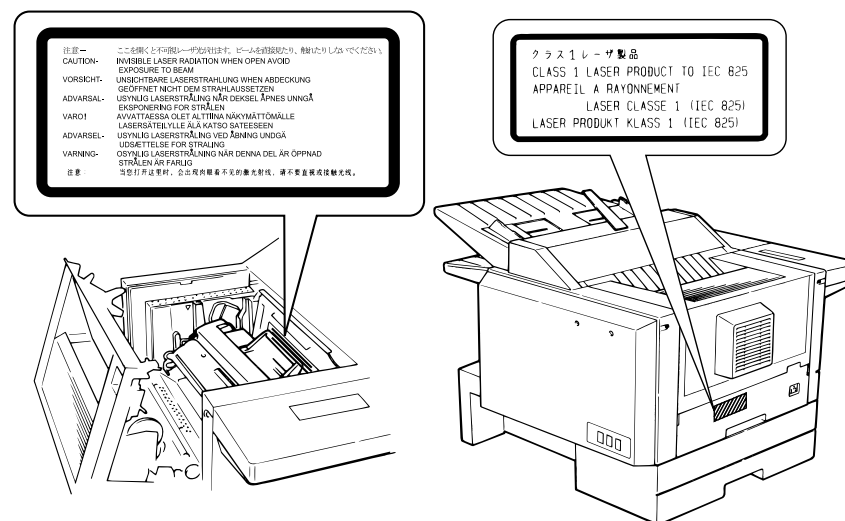

This page intentionally blank.

F-160 Quick Reference

One-Touch Keys

<u>Press</u>		<u>To:</u>	
Program	A	1	Enter
"	"	2	Enter
"	"	3	Enter

Speed-Dial Numbers

Program	B	1	Enter
"	"	2	Enter
"	"	3	Enter

Programmable One-Touch Keys

Program	C	1	Enter
"	"	2	Enter
"	"	3	Enter

Polling Documents

Program	D	1	Enter
"	"	2	Enter
"	"	3	Enter

Soft Key Features

Program	E	1	Enter
"	"	2	Enter

Delayed Commands

Program	F	1	Enter
"	"	2	Enter

Activity Journal and Reports

Program	G	1	Enter
"	"	2	Enter
"	"	3	Enter
"	"	4	Enter

Print a List of Groups

Program	H	Enter
---------	---	-------

EasyStart Settings

Program	I	Enter
---------	---	-------

User Settings

Program	J	01	Enter
"	"	02	Enter
"	"	03	Enter
"	"	04	Enter
"	"	05	Enter
"	"	06	Enter
"	"	07	Enter
"	"	08	Enter
"	"	09	Enter
"	"	10	Enter
"	"	11	Enter
"	"	12	Enter
"	"	13	Enter
"	"	14	Enter
"	"	15	Enter
"	"	16	Enter
"	"	17	Enter
"	"	18	Enter

Press

Program	J	19
"	"	20
"	"	21
"	"	22
"	"	23
"	"	24

Cover Page

Program	K	1	Enter
"	"	2	Enter
"	"	3	Enter

Numbering Pages

Program	L	Enter
---------	---	-------

Department Codes

Program	M	1	Enter
"	"	2	Enter
"	"	3	Enter
"	"	4	Enter
"	"	5	Enter

Batch Transmission

Program	N	1	Enter
"	"	2	Enter
"	"	3	Enter
"	"	4	Enter
"	"	5	Enter
"	"	6	Enter

Security Operations

Program	O	1	Enter
"	"	2	Enter

F-Code Feature

Program	P	1	Enter
"	"	2	Enter
"	"	3	Enter
"	"	4	Enter
"	"	5	Enter
"	"	6	Enter
"	"	7	Enter

Reset Printer Option

Program	Q	Enter
---------	---	-------

(Printer function requires optional equipment.)

PC-to-Fax Operations

Program	R	1	Enter
"	"	2	Enter
"	"	3	Enter

(PC-to-fax functions require optional equipment.
See your authorized Muratec dealer for details.)

Muratec (UK) Ltd

No.1 Stoke Road
Guildford, Surrey GU1 4HW
Tel (01483) 302100 Fax (01483) 301900
<http://www.muratec.co.uk>

To:

Enter	Set confirmation stamp
Enter	Set Copy & Fax feature
Enter	Set Quick Transmission
Enter	Set audible alarm
Enter	Set dial prefix No.
Enter	Reset drum life

Enter	Select the cover page option
Enter	Enter cover page information
Enter	Print cover page

Enter Set the number of pages

Enter Set the department protection

Enter Set the department code

Enter Turn department code setting on/off

Enter Print department time list

Enter Clear department time list

Enter Create or modify batch box

Enter Print list of batch boxes

Enter Print list of batch documents

Enter Print batch document

Enter Erase batch box

Enter Erase batch document

Enter Set security reception

Enter Print security reception document

Enter Set F-Code box

Enter Print list of F-Code boxes

Enter Print list of F-Code documents

Enter Print F-Code document

Enter Erase F-Code box

Enter Erase F-Code document

Enter Store F-Code document

Enter Reset printer option



Free Manuals Download Website

<http://myh66.com>

<http://usermanuals.us>

<http://www.somanuals.com>

<http://www.4manuals.cc>

<http://www.manual-lib.com>

<http://www.404manual.com>

<http://www.luxmanual.com>

<http://aubethermostatmanual.com>

Golf course search by state

<http://golfingnear.com>

Email search by domain

<http://emailbydomain.com>

Auto manuals search

<http://auto.somanuals.com>

TV manuals search

<http://tv.somanuals.com>