

# EG21 and EGS21 Series Electric Gage and Swichgage® Installation for Pressure, Temperature, Fuel Level, Voltmeter and Ammeter

## IMPORTANT NOTICE FOR ALL EG21 ELECTRIC GAGES AND EGS21 ELECTRIC SWICHGAGES FOR 24VDC AND 32VDC APPLICATIONS

A change in the dial illumination circuit has made it necessary to change the external wiring harness. If you use the incorrect wiring harness, irreparable damage will occur to the gage mechanism.

The table below lists correct wire harness assemblies for units by manufacturing date. For date code R1 (January 1996) or earlier (Q12, Q11, etc.) the wire harness can be identified by P/N and by BLACK shrink tubing on the YELLOW wire. For date code R1 (February 1996) and later (R3, R4, etc.) the wire harness can be identified by P/N and by RED shrink tubing on the YELLOW wire.

Date Code R1 or Earlier	Date Code R2 or Later
05004546	05006166
05004547	05006167
05004548	05006168
05004549	05006169
05004550	05006170
05004551	05006171
05004552	05006172

If dial illumination is NOT required, either wire harness can be used on any date code, if the YELLOW wire is NOT connected.

## Wire/Connector Assembly

**NOTE:** EG21 Series gage and EGS21 Series Swichgage movement and illumination require 12VDC to function. For 24 or 32 volt systems, voltage converters are built into the electrical wire/connector assembly **and supplied with instrument.**

Listed below are replacement part numbers for all wire/connector assemblies. Voltage converter included for 24 and 32 volt. Specify part number when ordering.

	12 VDC	24 VDC	32 VDC
EG21P / T / F	05004506	05006166 (05004546)*	05006167 (05004547)*
EGS21P / T / F	05004507	05006168 (05004548)*	05006169 (05004549)*
EG21AM	05004505	05006170 (05004550)*	05006171 (05004551)*
EGS21AM	05004504	05006172 (05004552)*	—
EG21VM	05004508	05004508	—
EGS21VM	05004504	05004504	—

\* For gages with date code R1 (January 1996) or earlier (Q12, Q11, etc.,) specify part number shown in parenthesis.

## Gage Installation

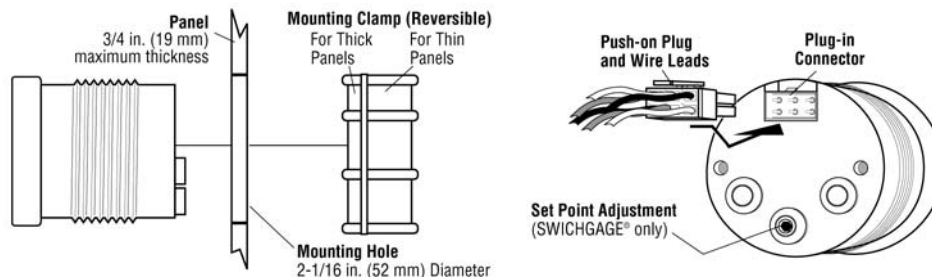

In order to consistently bring you the highest quality, full featured products, we reserve the right to change our specifications and designs at any time. MURPHY, the Murphy logo, and Swichgage® are registered and/or common law trademarks of Murphy Industries, Inc. This document, including textual matter and illustrations, is copyright protected by Murphy Industries, Inc., with all rights reserved. (c) 2008 Murphy Industries, Inc.

## Sender Installation

**CAUTION:** Do not use sender body to tighten.  
If sealant tape or pipe dope is used on the pressure sender, be sure that the tape or dope does not plug the sender's orifice.

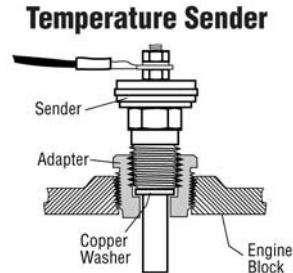
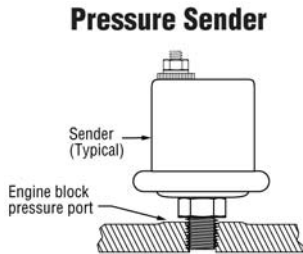

**CAUTION:** Extreme caution must be used in handling or working on or around the fuel tank. It must be worked on only in a **WELL VENTILATED** area. Keep all flame and hot materials away from it. Do not smoke while working on or around the tank. Avoid sliding or dragging the tank, or other actions which may cause a spark.

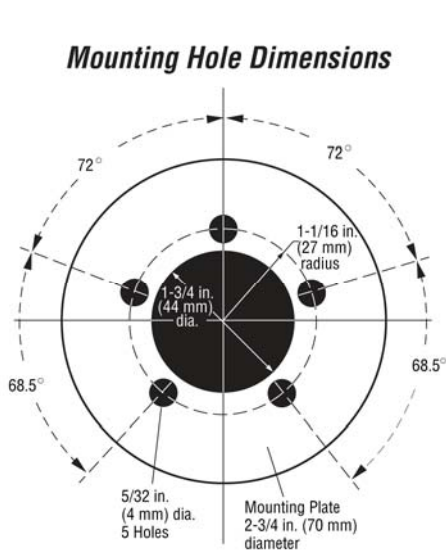

### Fuel Level Sender

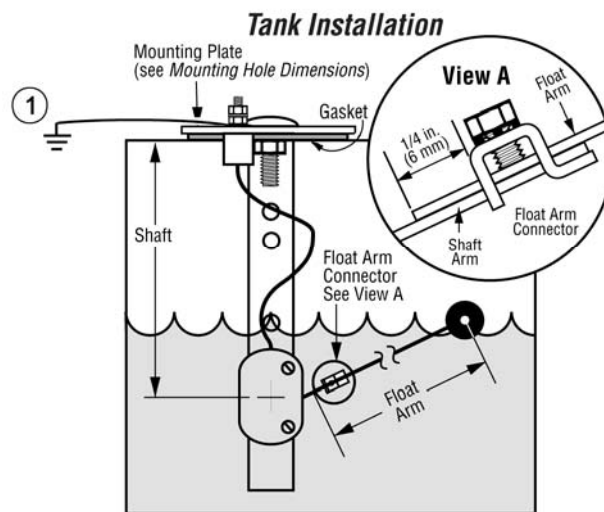

**NOTE:** When installing the fuel sender in a non-metallic tank using a single wire sender, another wire must be added from one of the sender mounting bolts to the battery ground (negative post). See ① in the 'Tank Installation' illustration above.

**Warranty** - A limited warranty on materials and workmanship is given with this FW Murphy product. A copy of the warranty may be viewed or printed by going to [www.fwmurphy.com/support/warranty.htm](http://www.fwmurphy.com/support/warranty.htm)

## Basic Wiring

**WARNING:** Disconnect battery negative cable before wiring or service.

### Pressure, Temperature, Fuel Level and Voltmeter Gage

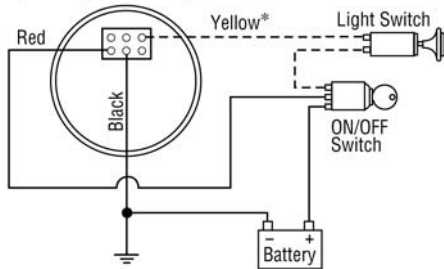

### Ammeter Gage

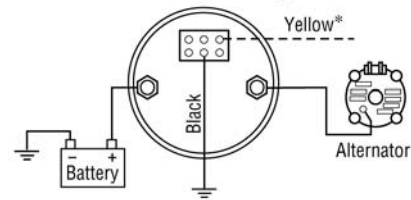

\*Yellow wire is optional for gage illumination and does not need to be connected for gage to operate.

## Sender Wiring

### Grounded Sender

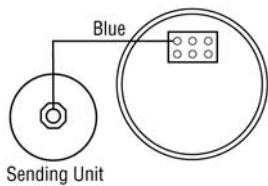

### Ungrounded Sender

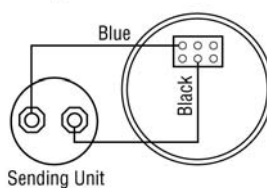

### Dual Gages with Dual Gage Sender

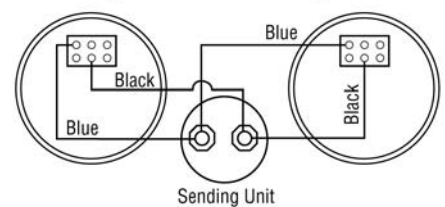

## Swichgage Wiring

**WARNING:** DISCONNECT BATTERY NEGATIVE CABLE BEFORE WIRING OR SERVICE.

**CAUTION:** Connecting full Battery potential to the brown wire can damage the Swichgage. Shutdown circuit is rated for 300 mA continuous, 900 mA inrush. Circuit rounds out at set point.

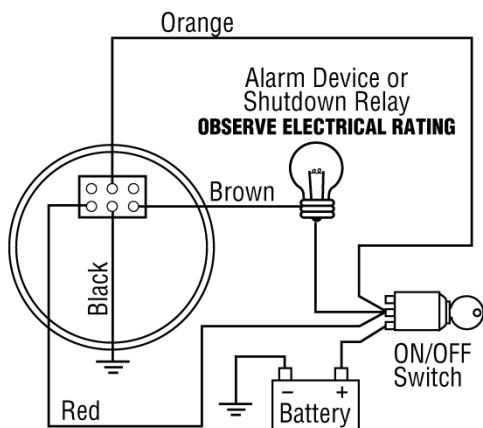

**Warranty** - A limited warranty on materials and workmanship is given with this FW Murphy product. A copy of the warranty may be viewed or printed by going to [www.fwmurphy.com/support/warranty.htm](http://www.fwmurphy.com/support/warranty.htm)

**CAUTION:** Devices containing solid state components can be damaged or caused to malfunction when used in systems which incorporate inductive loads (e.g. relays, solenoids, etc.) that can generate voltage spikes.

To reduce the potential for this type of damage, install a flyback or clamping diode across all inductive loads (see wiring diagram below).

Use Murphy diode package 65-00-0343 or equivalent. A typical diode is 1N4005 which is readily available from commercial sources. Failures of this type are not covered by our Limited Warranty.

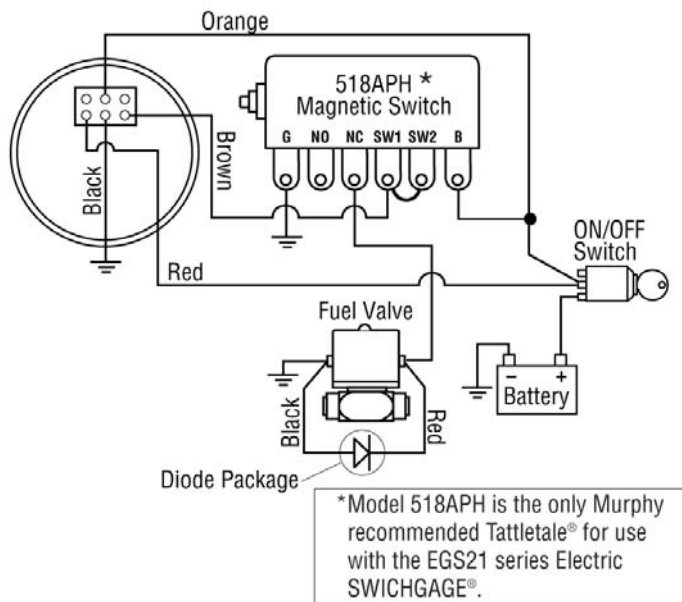
**FW MURPHY**

P.O. Box 470248  
Tulsa, Oklahoma 74147 USA  
+1 918 317 4100 Fax: +1 918 317 4266  
E-mail: sales@fwmurphy.com

**INDUSTRIAL PANEL DIVISION**

Fax: +1 918 317 4124  
E-mail: ipdsales@fwmurphy.com

**MURPHY POWER IGNITION**

Web site: www.murphy-pi.com

www.fwmurphy.com

**CONTROL SYSTEMS & SERVICES DIVISION**

P.O. Box 1819  
Rosenberg, Texas 77471 USA  
Phone: +1 281 633 4500 Fax: +1 281 633 4588  
E-mail: sales@fwmurphy.com

**FRANK W. MURPHY, LTD**

Church Rd Laverstock  
Salisbury SP1 1QZ UK  
Phone: +44 172 241 0055 Fax: +44 172 241 0088  
E-mail: sales@fwmurphy.co.uk  
Web site: www.fwmurphy.co.uk

**COMPUTRONIC CONTROLS, LTD**

41 - 43 Railway Terrace Nechells  
Birmingham B7 5NG UK  
Phone: +44 121 327 8500 Fax: +44 121 327 8501  
E-mail: info@computroniccontrols.com  
Web site: www.computroniccontrols.com

**FW MURPHY INSTRUMENTS (HANGZHOU) CO. LTD**

77 23rd Street  
Hangzhou Economic & Technological Development Area  
Hangzhou, Zhejiang 310018 China  
Phone: +86 571 8788 6060 Fax: +86 571 8684 8878



Printed in U.S.A.

**Warranty** - A limited warranty on materials and workmanship is given with this FW Murphy product. A copy of the warranty may be viewed or printed by going to [www.fwmurphy.com/support/warranty.htm](http://www.fwmurphy.com/support/warranty.htm)

## Free Manuals Download Website

<http://myh66.com>

<http://usermanuals.us>

<http://www.somanuals.com>

<http://www.4manuals.cc>

<http://www.manual-lib.com>

<http://www.404manual.com>

<http://www.luxmanual.com>

<http://aubethermostatmanual.com>

Golf course search by state

<http://golfingnear.com>

Email search by domain

<http://emailbydomain.com>

Auto manuals search

<http://auto.somanuals.com>

TV manuals search

<http://tv.somanuals.com>