

**MUSTANG SURVIVAL**



# OWNER'S MANUAL

## **MD3183 INFLATABLE PFD**

Hydrostatic Inflation  
Model - Manual with  
Automatic Backup

### **USCG APPROVALS:**

RECREATIONAL: TYPE II  
UNINSPECTED COMMERCIAL  
VESSELS: TYPE V



## **MD3184 INFLATABLE PFD**

Hydrostatic Inflation  
Model - Manual with  
Automatic Backup With  
Harness

### **USCG APPROVALS:**

RECREATIONAL: TYPE V



**WE SAVE LIVES FOR A LIVING**

## **CONTENTS**

Page	1 Approval Conditions and Carriage Requirements
	2 Note to Uninspected Commercial Vessel Operators
	2 Why are PFDs Required Safety Equipment?
	2 What is an Inflatable PFD?
	3 Instructions for Use
	3 Uninspected Commercial Vessel Use
	3 Component Inspection Instructions
	4 Readiness Checklist
	4 Sizing and Fit
	4 Donning Instructions
	5 Inflating Your Inflatable PFD
	6 Special Considerations for Inflatable Devices
	7 Deflating the Inflatable PFD
	8 Usage Below Freezing
	8 Re-arming Your PFD
	11 Repacking
	13 Sailing Harness
	14 Is Your PFD in Good and Servicable Condition?
	15 Care and Maintenance Instructions
	17 Cleaning and Storing of Your Inflatable PFD
	17 How and Why to Test Your PFD
	17 How Do You Test Your PFD Using the Automatic Inflator?
	18 How Do You Test Your PFD Using the Manual Inflator?
	19 How Do You Test Your PFD Using the Oral Inflator?
	19 Wear Your PFD
	20 Hypothermia
	21 Each of These Devices is Intended to Help You Save Your Own Life
	22 Inflatable PFD Safety Accessories
	22 Additional Information
	22 Airline Operator Policy on Carriage of Inflatable PFDs and CO <sub>2</sub> Cartridges

## **APPROVAL CONDITIONS AND CARRIAGE REQUIREMENTS**

**Recreational** - Approved for recreational use by the U.S. Coast Guard (USCG) as a Type II (Model MD3183), or Type V (Model MD3184) Personal Flotation Device (PFD). Neither are approved for water skiing or other high impact, high-speed activities. Model MD3184 has Type II performance but is approved as a Type V PFD because it has a built-in sailing harness that can cause injury if not properly used. A separate section titled "SAILING HARNESS" (p. 16) discusses requirements and features on the MD3184 only. USCG approval does not apply to the sailing harness because some of the risks associated with its use have not been evaluated.

**Commercial** - Model MD3183 is a U.S. Coast Guard approved Type V inflatable PFD, approved ONLY WHEN WORN for use on uninspected commercial vessels less than 40 feet in length not carrying passengers for hire as a substitute for a Type II PFD when used in accordance with this owner's manual.

---

**NOTE: MD3184 is not USCG approved for Uninspected Commercial Vessels.**

---

Conditions for Type V Approval in commercial applications:

1. The MD3183 must be worn before getting underway and whenever above deck and not within an enclosed space to meet the carriage requirement.
2. The operator of an uninspected commercial vessel is responsible for servicing and maintaining the MD3183 in good serviceable condition in accordance with this owner's manual. See Care and Maintenance Instructions (p. 17) for servicing information.
3. The operator of an uninspected commercial vessel is responsible for providing each person onboard with the safety information required for use of the MD3183. See page 2 for information.

**General** - When fully inflated, this Inflatable PFD will provide Type II in-water performance. This Inflatable PFD will turn most wearers from a face down to a face up position and provide support suitable for offshore conditions. See page 9 for re-arming instructions.

Inflatable PFDs are not approved for water skiing or other high-speed

activities. This Inflatable PFD was designed to be more comfortable and less restrictive to wear than inherently buoyant PFDs. When worn, used and serviced according to this owner's manual, this PFD can greatly increase your chances of survival in the water. **Not recommended for non-swimmers or weak swimmers.** Users of inflatable PFDs must be at least 16 years old.

## NOTE TO UNINSPECTED COMMERCIAL VESSEL OPERATORS

The operator of the vessel is required to provide the following user information to each person on board.

Inflatable PFDs will not provide any buoyancy without being inflated. Follow these instructions to be sure your PFD is armed and donned correctly, and that you understand how to inflate the device.

Basic visual inspection for readiness, see p. 4

Inflation system status check, see p. 4

Donning, see p. 4

Inflation, see p. 5

## WHY ARE PFDs REQUIRED SAFETY EQUIPMENT?

Drownings are the leading cause of fatalities involving recreational and commercial vessels. A PFD provides flotation to help keep your head above water, help you to stay face up in the water, and increase your chances for survival and rescue. Most adults only need an extra 7 to 12 lbs (3.2 to 5.5 kg) of flotation to keep their heads above water. The proper size PFD will properly support the weight of the wearer.

Since this Inflatable PFD does not have inherent buoyancy, it provides flotation only when inflated. Familiarize yourself with the use of this Inflatable PFD so you know what to do in an emergency.

## WHAT IS AN INFLATABLE PFD?

While traditional PFDs are inherently buoyant, inflatable PFDs, rely entirely on inflation for buoyancy. Uninflated, the Inflatable PFD is a

comfortable slim collar that can be inflated at any time with a 33-gram CO<sub>2</sub> gas cylinder. The Inflatable PFD is designed to offer maximum mobility with minimum bulk. The Inflatable PFD can be inflated either automatically by water immersion, manually by jerking a pull-tab, or orally by mouth. It is recommended that you familiarize yourself with the procedures outlined in INSTRUCTIONS FOR USE (p. 3).

## INSTRUCTIONS FOR USE

This manual supplies instructional, maintenance and safety information for both models (MD3183, MD3184). The model number is listed on the underside label.

### Uninspected Commercial Vessel Use

This Inflatable PFD is not approved for "hot work" and care must be taken to avoid damage from abrasion and sharp objects.

### Component Inspection Instructions

- 1) Examine the single point status indicator through the window panel (Fig. 1 and 2). Ensure the indicator is green. If the indicator is red, the mechanism has been fired or is incorrectly fitted (see Re-arming Your PFD, p. 9).

---

**NOTE: The single point status indicator must be green before proceeding.**

---

- 2) Undo the zipper on the wearer's left side, exposing the oral inflator.
- 3) Ensure the oral-inflation dust cap is in the stowed position (Fig. 7).
- 4) Ensure the single point status indicator is green and the pull-tab lanyard is hanging on the outside; secure the zippers on the Inflatable PFD (see Repacking, p.13).

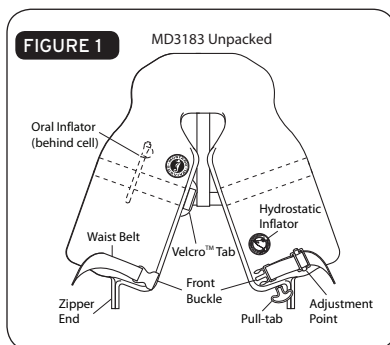

- 5) Ensure the current date is not past the date on the inflator. If it is, replace the inflator (see Re-arming Your PFD, p. 8).

### Readiness Checklist

Check your Inflatable PFD and ensure all of the checkpoints listed below are true before use.

- Single point status indicator is green (Fig. 1 and 2).
- Ensure the current date is not past the date on the inflator. If it is, replace the inflator (see Re-arming Your PFD, p. 8).
- All zippers, Velcro™ and waist buckle are securely fastened.
- Oral-inflation dust cap is in the stowed position (Fig. 7).
- Inflatable PFD is not twisted.
- Ensure the inflation pull-tab is hanging on the outside (Fig. 31).
- No rips, tears, excessive abrasion or holes; all seams are securely sewn; and the cover, straps and hardware are still strong.

Your Inflatable PFD is ready for use if all applicable boxes are checked.

---

**NOTE: Contact your Mustang Dealer if you have any concerns about the readiness of your Inflatable PFD.**

---

### Sizing and Fit

This PFD provides a minimum of 33.7 lbs of buoyancy when inflated and is designed for wearers over 16 years of age, with a chest range of 30-52 inches (76-132 cm) weighing over 80 pounds (36 kg).

### Donning Instructions

It is important that the Inflatable PFD is properly adjusted to fit the person wearing it. An incorrect fit or improper fastening of attachments could impede its effectiveness.

- 1) All belts and straps are already threaded correctly and only need to be adjusted for fit.

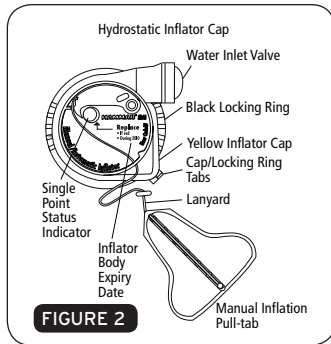

For the non-harness model MD3183, the belt should fit below your rib cage adjusted to a tight personal fit.

For the harness model MD3184, the bottom of the belt must always be worn at least 2 inches (5 cm) above the lowest rib and adjusted to a tight personal fit.

- 2) Put the Inflatable PFD on just like a jacket (Fig. 3) and fasten the front buckle. Adjust the waist belt using the side buckle on the belt and secure the belt's loose end in the belt loop.

**WARNING: Do not wear Inflatable PFDs under clothing as the inflation could be restricted or you could be injured.**

## Inflating Your Inflatable PFD

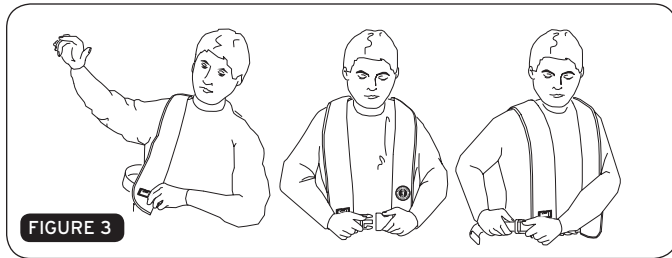

It is recommended that the following procedures be followed to inflate your Inflatable PFD:

- 1) **Manual Inflation**  
Activate the inflation system by jerking firmly downward on the pull-tab (Fig. 4). The Inflatable PFD should fully inflate within 5 seconds.

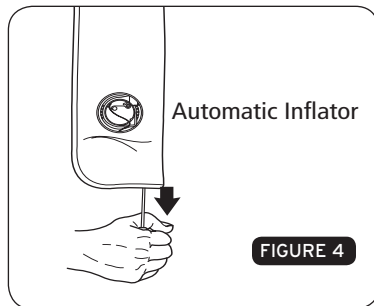

- 2) **Automatic Backup Inflation**

When the inflator is lowered more than about 4 inches in the water, then the hydrostatic valve opens and lets the water meet the water sensitive element that in turn releases a stainless steel coil spring. The spring then drives a

needle into the end of the gas cylinder, which is now punctured so that the gas instantly fills the life jacket. Total buoyancy is normally reached within 4 – 5 seconds.

### Information

When inflated, the carbon dioxide (CO<sub>2</sub> gas) used to inflate the PFD will slowly escape through the fabric over time. A slight reduction of pressure will be observed after several hours of inflation. Topping up by oral inflation may be required in the event of very prolonged immersion.

---

**IMPORTANT: See Special Considerations for Inflatable Devices**

---

### 3) Oral Inflation

Properly armed and inspected Inflatable PFDs will inflate when manually or automatically activated. However, you can fully inflate the Inflatable PFD by mouth (Fig. 5) should inflation not occur, or if you are in a non-emergency situation.



i. To orally inflate the Inflatable PFD, first ensure that each of the zippers (2) are completely opened.

---

**NOTE: Oral inflation may cause the Inflatable PFD to break-out suddenly (loudly) if any of the zippers are closed.**

---

ii. Locate the oral inflation tube by opening the wearer's left front panel of the Inflatable PFD. Remove the dust cap from the end of the oral tube and blow into the tube until the Inflatable PFD is fully inflated.

---

**WARNING: Avoid double inflation (CO<sub>2</sub> cylinder inflation after full oral inflation) as it could damage the PFD.**

---

## Special Considerations for Inflatable Devices

The Inflatable PFD might not be armed when needed, either knowingly or unknowingly. Inadvertant inflation causes several risks that you must address to avoid drowning. Much less common but also important are:



- 1) Double inflation (CO<sub>2</sub> cylinder inflation after full oral inflation) could damage the Inflatable PFD,
- 2) Inflation when stored in a tight space could damage the Inflatable PFD, and
- 3) The Inflatable PFD could inflate when you are in an awkward place or position.

If this Inflatable PFD should inflate inadvertently, a re-arm kit (MA7214) is required to re-arm the device.

**IMPORTANT: The Inflatable PFD should be re-armed according to the instructions (Re-arming Your PFD, p. 8).**

## Deflating the Inflatable PFD

- 1) To deflate the Inflatable PFD, reverse the oral-inflation tube dust cap and insert it into the valve or depress valve with fingertip. The dust cap will not lock in the deflate position so it is necessary to hold it in place (Fig. 6).
- 2) Gently squeeze the Inflatable PFD until all air or gas has been expelled. To avoid damage; do not wring or twist the Inflatable PFD. Put the inflation tube dust cap back in its stowed position on the oral inflation tube (Fig. 7).

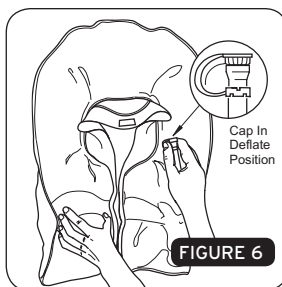

**IMPORTANT: Ensure all air has been removed from the PFD.**

- 3) Examine the single point status indicator (Fig. 1 and 2). If the indicator is red, the mechanism has been fired and the inflator requires service (see Re-arming your PFD, p. 9).

**IMPORTANT: The single point status indicator must be green before proceeding.**

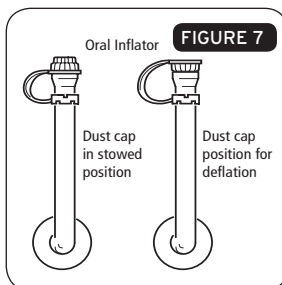

- 4) Your device is ready to be repacked (see Repacking p. 11).

## Usage Below Freezing

When the temperature is below freezing, the Inflatable PFD should be worn partially inflated because a fully discharged cylinder may not quickly or adequately inflate your Inflatable PFD. Under these conditions use the oral inflator to adequately top-up the PFD, after CO<sub>2</sub> inflation.

**WARNING: CO<sub>2</sub> inflation could over-pressurize and damage your Inflatable PFD if already fully inflated.**

## Re-arming Your PFD

**NOTE: A valid re-arm kit (MA7214) is required for this procedure.**

- 1) Place the Inflatable PFD (Personal Flotation Device) on a smooth, flat surface and wipe off any water. Access the inflator by reaching under the cover and pull it toward you, turning the cell and cover inside-out to fully expose the inflator for re-arming. Hold the CO<sub>2</sub> cylinder through the fabric, using one hand (Fig. 8).

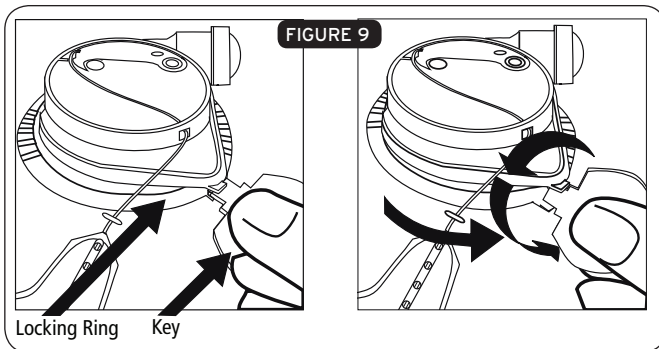
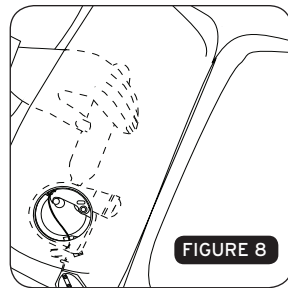

- 2) Insert the metal key between the black locking ring and labeled yellow cap. Turn the key counter-clockwise (Fig. 9).
- 3) Turn the black locking ring counter-clockwise and lift off the cap

(yellow inflator operating head Fig. 10). Dispose of the used cap.

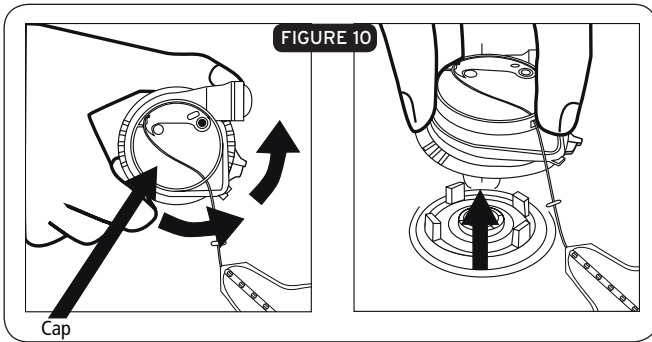

4) Squeeze the sealing ring to elongate and remove the inflator body through the sealing ring (Fig. 11).

5) Dispose of the used inflator body.

6) Check that the new inflator body indicator is green. Insert the new inflator body with CO<sub>2</sub> cylinder pointing upward inside the Inflatable PFD (Fig.13). Let the sealing ring rest on the adapter around the four lugs.

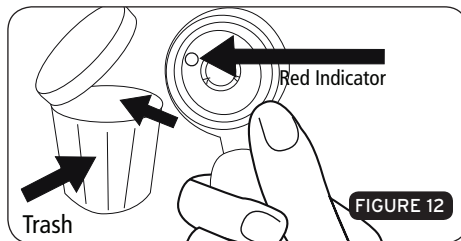
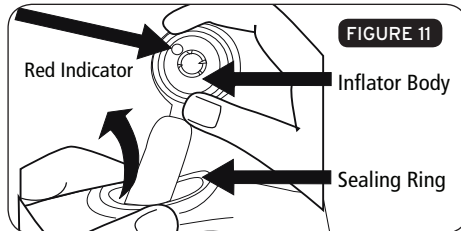

7) Now check the new manual/automatic cap as follows (Fig. 14):

1. Is the single point status indicator showing green?
2. Is the expiry day OK?

If YES is the answer to both questions, then proceed as follows. If the answer is NO to either question, get a new cap.

- 8) Hold the CO<sub>2</sub> cylinder through the fabric of the Inflatable PFD (Fig. 15). Position the replacement cap with the water inlet valve pointing to the right and press

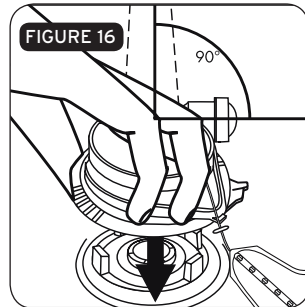
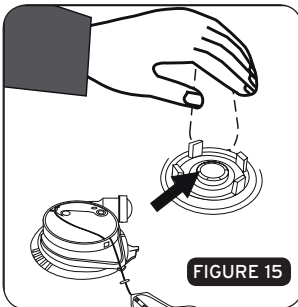
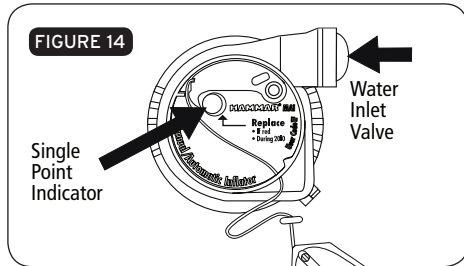
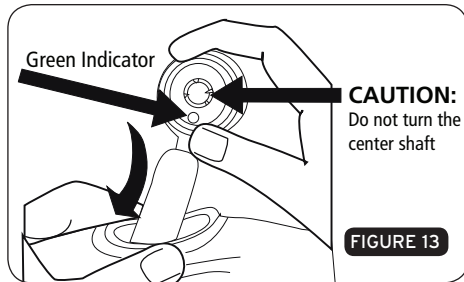

firmly onto the inflator body and sealing ring (Fig. 16).

- 9) While pressing FIRMLY onto the inflator body, turn the **BLACK** locking ring clockwise into the locked position (Fig. 17). Pull on the cap to make sure it has locked onto the inflator body.

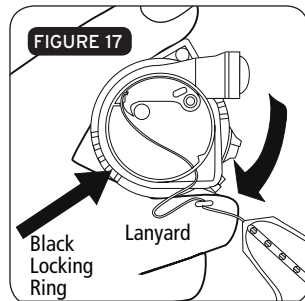

- 10) Check: To see that the single point status indicator on the cap is green; the pull to inflate lanyard is present and that the locking ring is locked.
- 11) Refold the Inflatable PFD in accordance with the Repacking section (p. 11).

## Repacking

If your Inflatable PFD has been used and/or the hydrostatic inflator replaced, always inflate through the oral tube and check that it stays inflated at least overnight. With the dust cap in the top of the oral tube, gently squeeze the Inflatable PFD until all air or gas has been expelled (Fig. 6). Do not wring or twist the Inflatable PFD. Put the oral tube dust cap back in its stowed position on the oral tube (Fig. 7). Let the life jacket dry before packing.

---

**IMPORTANT: Ensure all air is removed before repacking. Before following the repacking sequence, be sure to properly re-arm your Inflatable PFD, p. 8.**

---

- 1) Lay out the Inflatable PFD flat on a clean surface (Fig. 18).
- 2) Fold side (A) inward along the full length of the dotted line (Fig. 19). Fold cover (B) over; covering side (A) (Fig. 20).
- 3) Repeat step 2 with side (C), cover (D).
- 4) Fold over the top side (E) into thirds and fold cover back (F).
- 5) Mustang Survival uses advanced 2-step zippers. **ZIP 1 - Reset** the zipper by pulling the slider (G) around the top to the Velcro™ tab (H). **ZIP 2 - Close** by pulling the slider (G) in the opposite direction to the end of the zipper (Fig. 26). Ensure that the Inflatable cell does not get

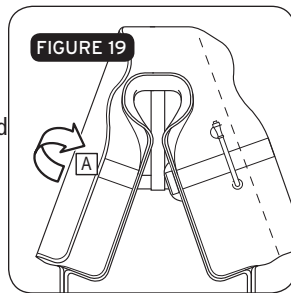
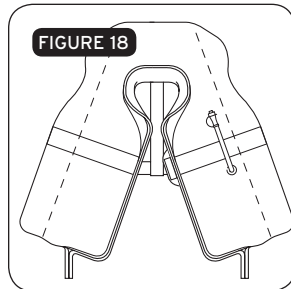

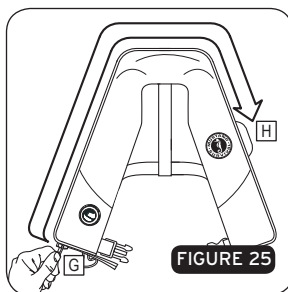
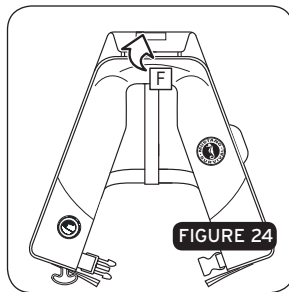
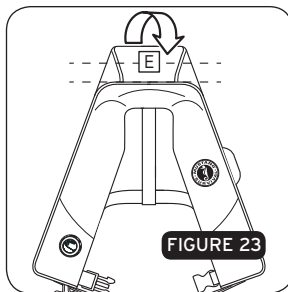
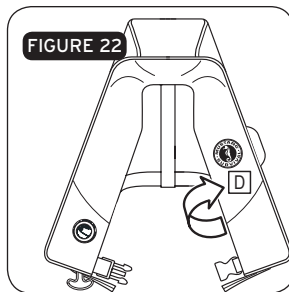
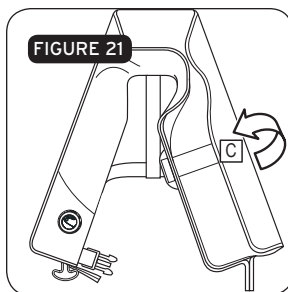
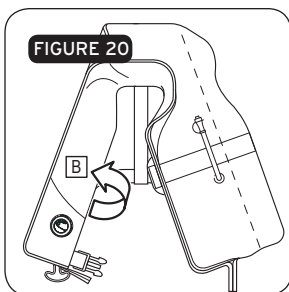

caught by the zipper when closing.

- 6) Fasten the Velcro™ tab (H) to keep zipper closed.
- 7) **ZIP 1 - Reset** the 2-step zipper by pulling the slider (I) to the Velcro™ tab (H). **ZIP 2 - Close** by pulling slider (I) in the opposite direction to the end the zipper (Fig. 29). Ensure that the Inflatable cell does not get

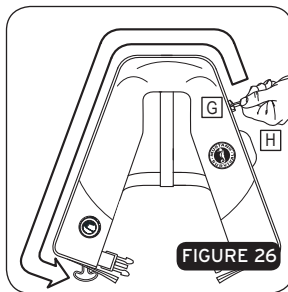

caught by the zipper when closing.

- 8) Use a finger to push the zipper ends into the openings at the bottom of the the packed Inflatable PFD (Fig. 30).
- 9) Ensure the pull-tab (J) is on the outside of the folded Inflatable PFD. Fig. 31 depicts a correctly folded Inflatable PFD.

## Sailing Harness

**CAUTION: Use only as a sailing harness harness.**

Models with a sailing harness (MD3184) are designed to prevent the user from falling overboard when used with a tether with an under-load quick-release hook and have been designed and tested in accordance with Offshore Racing Council (ORC) requirements. Care and attention must be taken to ensure that the harness is used and maintained correctly. The harness is designed to be worn by persons at least 5 feet 5 inches tall (165 cm). The harness should be worn as high on the chest as possible, but in all cases, at least 2 inches (5 cm) above the lowest rib measured from the bottom of the belt and should not be used if it does not fit in this manner. Adjust the harness using the strap adjuster so that the harness is as snug as tolerable.

Failure to adjust the harness properly could result in injury.

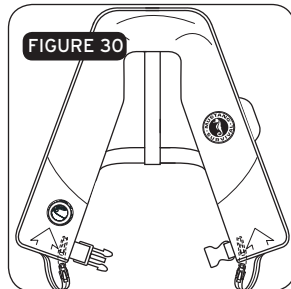
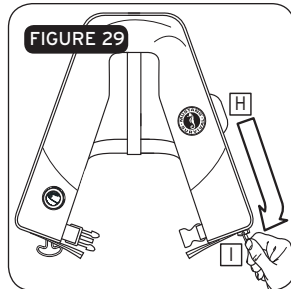
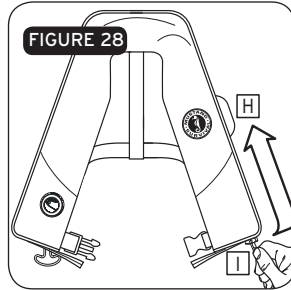
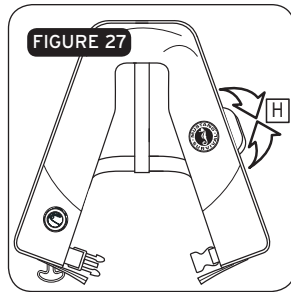

When attached to the boat use a tether of less than 6 feet 6 inches (2 m) in length with quick-release under-load hardware (Fig. 32).

Ensure that a tether is secured to both D-rings. When not in use, the D-rings can be pushed under the lapels.

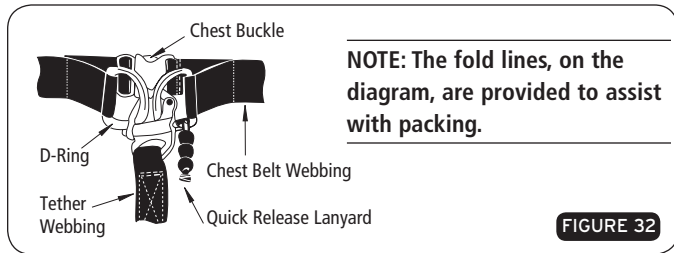
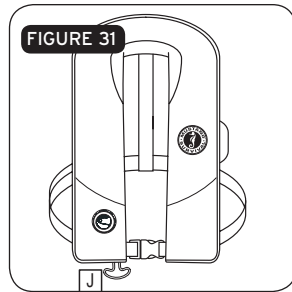

**Warning:** Use of a sailing harness to prevent falls overboard presents several risks. In case of capsizing or sinking, the boat may take you down. As such, ensure that any tether used has quick-release under-load hardware. This harness has not been designed for fall arrest, lifting or climbing and should not be relied upon in any of these instances.

US Coast Guard approval does not apply to this harness and the potential for injury has not been assessed.

## IS YOUR PFD IN GOOD AND SERVICEABLE CONDITION?

Check your Inflatable PFD between outings to be sure that it is properly armed; that it is free of rips, tears or holes; that all seams are securely sewn; and that the fabric, straps and hardware are still strong (See Readiness Checklist, p. 4). Inspect the inflatable portion of the Inflatable PFD in accordance with the CARE AND MAINTENANCE INSTRUCTIONS.



# CARE AND MAINTENANCE INSTRUCTIONS

Federal Regulations require Coast Guard approved personal flotation devices (PFDs) that are legibly marked with the Coast Guard approval number, are in good and serviceable condition, and are the correct size for each person on board. It is the responsibility of the operator to be sure this PFD is in serviceable condition. To be considered serviceable, this PFD shall not exhibit deterioration that could diminish its performance, such as broken or deformed hardware, detached webbing, rotted structural components, air leaks or nonfunctional inflators. Unless worn inflated, this PFD must also be properly armed with a cylinder installed in the inflator, and single point status indicator showing green. See Page 3 for instructions. Failure to follow these instructions rigorously could result in a non-functioning PFD causing injury or death.

Check the following at the intervals listed below.

## 1) Before Each Use:

- i) Examine the single point status indicator through the window panel, ensuring it is green. If the indicator is red, the mechanism requires service. See Re-arming Your PFD, p. 8.
- ii) Ensure the manual pull-tab is accessible.
- iii) Visually examine your Inflatable PFD for damage or excessive abrasion, wear, tear or contamination. Particular attention must be paid to the stitching, straps and hardware. If in doubt, send it to your Mustang dealer for evaluation and/or servicing.

## 2) Every Two (2) Months:

- i) Leak Test: The Inflatable PFD should be tested for general leakage by orally inflating your Inflatable PFD until firm and let stand 16 hours. A leaking Inflatable PFD will not hold its firmness and should be replaced. If your Inflatable PFD leaks, take it to your Mustang dealer for evaluation and/or servicing. Repack the Inflatable PFD as outlined in the Repacking section (p. 11).
- ii) Oral Inflation Valve Test: To check the oral inflation valve, fully inflate the Inflatable PFD using the oral inflator and hold valve under water. If bubbles appear, deflate and re-inflate to test again. Should the leak persist, take your Inflatable PFD to your Mustang dealer for evaluation and/or servicing.

---

**CAUTION: To avoid accidental inflation, don't allow the water to contact the hydrostatic inflator.**

---

iii) Perform a thorough visual examination. See **Readiness Checklist** (p. 4).

Perform these tests more often if exposed to potential damage or used in extreme conditions.

- 3) **After Each Inflation** - Re-arm the Inflatable PFD. See Re-arming Your PFD, p. 8.
- 4) **Annually** - Perform the following at the beginning of each boating season, after inflation, or whenever the integrity of the Inflatable PFD is in doubt:
  - i) Check all components for dirt or corrosion. Clean or replace, as necessary. See **Readiness Checklist** (p. 4).
  - ii) Visually examine your Inflatable PFD for damage or excessive abrasion, wear, tear or contamination. Particular attention must be paid to the stitching, straps and hardware. If in doubt, send it to your Mustang dealer for evaluation and/or servicing.
  - iii) Perform the Oral Inflation Valve Test: See the Oral Inflation Valve Test in the Every Two (2) Months Care and Maintenance Instructions section.
  - iv) Perform the Leak Test. See the Leak Test in the Every Two (2) Months Care and Maintenance Instructions section.
  - v) Ensure the current date is not past the date on the inflator. If it is, replace the inflator (see Re-arming Your PFD, p. 8).
  - vi) Ensure the single point status indicator is green (Fig. 1 and 2).
  - vii) Record as an "Annual" inspection in permanent ink on the Care and Storage label, in the Date Maintained column.

Repack the Inflatable PFD as outlined in the Repacking section (p. 11).

---

**WARNING: If you are not confident in the self-inspection and servicing of your Inflatable PFD in accordance with these instructions, take your Inflatable PFD to a Mustang dealer for professional servicing or contact Mustang Survival (see contact information on back of manual).**

---

## Cleaning and Storing of Your Inflatable PFD

To avoid inflation, do not submerge the Inflatable PFD or directly spray the inflator. Hand wash or sponge down the Inflatable PFD in warm, soapy water. Rinse the PFD and inflator with clean water, using a clean rinse cloth. Hang the Inflatable PFD to dry on a plastic coat hanger. Do not dry clean.

Always store your Inflatable PFD in a warm, dry place out of direct sunlight.

## HOW AND WHY TO TEST YOUR PFD

Inflate your Inflatable PFD and try it out in the water to:

- Make sure it floats you:
  - Comfortably (when worn properly)
  - Adequately for expected wave conditions (body shapes/densities affect performance)
- Make sure it works:
  - A flow of bubbles should not appear (see CARE AND MAINTENANCE INSTRUCTIONS for leak tests p. 17). It should inflate quick and easily.
- Learn how it works by:
  - Activating the CO<sub>2</sub> inflation system
  - Re-arming the CO<sub>2</sub> inflation system
  - Using the oral inflator tube

## HOW DO YOU TEST YOUR PFD USING THE AUTOMATIC INFLATOR?

The U.S.Coast Guard recommends that you purchase at least two spare re-arming kits (MA7214).

- 1) To test your Inflatable PFD, you will need your fully armed Inflatable PFD, and re-arming kit (MA7214) approved for your Inflatable PFD
- 2) Put on the Inflatable PFD.
- 3) Get into shallow water, just deep enough that you can stand with your head above the surface. Once the inflator is underwater, 4

inches or so, the Inflatable PFD should fully inflate automatically within 5 seconds.

- 4) See if the Inflatable PFD will float you on your back or just slightly back of vertical. In a relaxed floating position, verify that your mouth is well above the water's surface. Note the effect of where you hold your legs on how you float.
- 5) Get out of the water and remove the Inflatable PFD.
- 6) Deflate the Inflatable PFD by depressing the oral inflator valve (see Deflating the Inflatable PFD p. 7). Remove the used inflator.
- 7) Let the Inflatable PFD dry thoroughly. Re-arm (p. 8) and Repack the PFD (p. 11).

## HOW DO YOU TEST YOUR PFD USING THE MANUAL INFLATOR?

The U.S.Coast Guard recommends that you purchase at least two spare re-arming kits (MA7214).

- 1) To test your Inflatable PFD, you will need your fully armed Inflatable PFD, and re-arming kit approved for your Inflatable PFD: MA7214.
- 2) Put on the Inflatable PFD.
- 3) Actuate the inflation system by jerking firmly downward on the pull-tab. The Inflatable PFD should fully inflate within 5 seconds.
- 4) Get into shallow water, just deep enough that you can stand with your head above the surface.
- 5) See if the Inflatable PFD will float you on your back or just slightly back of vertical. In a relaxed floating position, verify that your mouth is well above the water's surface. Note the effect of where you hold your legs and how you float.
- 6) Get out of the water and remove the Inflatable PFD. Completely deflate the Inflatable PFD using the oral inflator (see Deflating the Inflatable PFD p. 7).
- 7) Let the Inflatable PFD dry thoroughly. Re-arm (p. 8) and Repack the PFD (p. 11).

## HOW DO YOU TEST YOUR PFD USING THE ORAL INFLATOR?

This test is not mandatory, however may be conducted using the following procedure.

---

**WARNING: Use only a previously fired hydrostatic inflator to perform this test. DO NOT test with a fully armed hydrostatic inflator as double inflation may occur, possibly resulting in cell damage.**

---

- 1) No spare parts or re-arming kits are needed to test your Inflatable PFD.
- 2) Put on the Inflatable PFD.
- 3) Get into shallow water, just deep enough that you can stand with your head above the surface.
- 4) If you are a weak swimmer or non-swimmer, inflate the Inflatable PFD partially so that you are supported well enough to be able to complete inflation without touching bottom, either orally or manually. Note this level of inflation because it is the minimum needed for you to safely use this Inflatable PFD.
- 5) Fully inflate the Inflatable PFD using the oral inflator.
- 6) See if the Inflatable PFD will float you on your back or just slightly back of vertical. In a relaxed floating position, verify that your mouth is well above the water's surface. Note the effect of where you hold your legs and how you float.
- 7) Get out of the water and remove the Inflatable PFD. Completely deflate the Inflatable PFD using the oral inflator (see Deflating the Inflatable PFD p. 7).
- 8) Let the Inflatable PFD dry thoroughly. Re-arm (p. 8) and Repack the PFD (p. 11).

## WEAR YOUR PFD

In approximately 80 percent of all boating fatalities, the victims were not wearing a PFD. Most fatal accidents happen on calm sunny days. This

Inflatable PFD is much more comfortable to wear than other PFD types. Get into the habit of wearing this Inflatable PFD.

Non-swimmers and children especially should wear a hybrid or non-Inflatable PFD at all times when on or near the water.

## HYPOTHERMIA

Prolonged exposure to cold water causes a condition known as hypothermia - a substantial loss of body heat, which leads to exhaustion and unconsciousness. Most drowning victims first suffer from hypothermia. The following chart shows the effects of hypothermia: how hypothermia affects most adults.

### How hypothermia affects most adults

Water Temperature °C (°F)	Exhaustion or Unconsciousness	Expected Time of Survival
0.3 (32.5)	Under 15 min.	Under 15–45 min.
0.3–4 (32.5–40)	15–30 min.	30–90 min.
4–10 (40–50)	30–60 min.	1–3 hrs
10–16 (50–60)	1–2 hrs.	1–6 hrs.
16–21 (60–70)	2–7 hrs.	2–40 hrs.
21–27 (70–80)	2–12 hrs.	3 hrs. to Indefinite
over 27 (over 80)	Indefinite	Indefinite

PFDs can increase survival time because they allow you to float without using energy treading water and because of their insulating properties. Naturally, the warmer the water, the less insulation you will require. When operating in cold waters [below 60°F (15.6°C)] you should consider using a coat or jacket style PFD or a Type V Thermal Protective PFD as they cover more of the body than the vest or belt style PFDs. Some Points to Remember About Hypothermia Protection:

- 1) Always wear your Inflatable PFD. Even if you become incapacitated due to hypothermia, the Inflatable PFD will keep you afloat and greatly improve your chances of rescue.
- 2) Do not attempt to swim unless it is to reach a nearby craft, fellow

survivor, or a floating object on which you can lean or climb. Swimming increases the rate of body heat loss. In cold water, drown-proofing methods that require putting your head in the water are not recommended. Keep your head out of the water. This will greatly lessen heat loss and increase your survival time.

- 3) Use the standard H.E.L.P. position when wearing an Inflatable PFD, drawing the legs up to a seated position, because doing so will help you conserve body heat (Fig. 33).
- 4) Keep a positive attitude about your survival and rescue. This will improve your chances of extending your survival time until rescued. Your will-to-live does make a difference!
- 5) If there is more than one person in the water, huddling is recommended while waiting to be rescued. This action tends to reduce the rate of heat loss and thus increase the survival time.

## EACH OF THESE DEVICES IS INTENDED TO HELP YOU SAVE YOUR OWN LIFE

For your Inflatable PFD to function properly, follow these suggestions to verify that it fits, floats, and remains in good condition.

- 1) Check the single point status indicator before each use.
- 2) Get in the habit of re-arming the inflation mechanism right after each inflation.
- 3) Try your wearable Inflatable PFD on and adjust it until it fits comfortably in and out of the water.
- 4) Mark your Inflatable PFD with your name if you are the only wearer.
- 5) Do not alter your Inflatable PFD. If it doesn't fit properly, get one that does. An altered device is no longer Coast Guard approved.
- 6) Your Inflatable PFD is not intended for use as a fender or kneeling pad.
- 7) If your Inflatable PFD is wet, allow it to dry thoroughly before storing

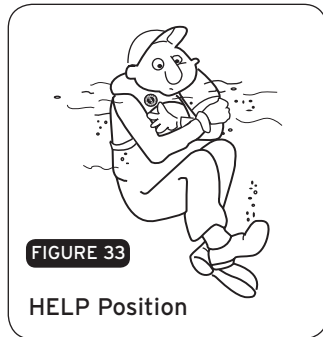

it. Store it in a well-ventilated area.

- 8) Do not dry your Inflatable PFD in front of a radiator or other source of direct heat.

## Inflatable PFD Safety Accessories

MA7214 Re-arm Kit contains 33-gram replacement CO<sub>2</sub> cylinder inflator.

## ADDITIONAL INFORMATION

If you need more information about PFDs and safe boating, contact your state boating authority, U.S. Coast Guard Auxiliary, U.S. Power Squadron, Red Cross, or your nearest unit of the U.S. Coast Guard. To find out about free boating courses in your area call 1-800-336-BOAT (in Virginia, call 1-800-245-BOAT).

## DO NOT ATTACH PFD'S TO YOUR BOAT

Each PFD has straps, hooks, buckles, or other means for securing the device in place on the wearer. Some PFDs also incorporate decorative d-rings or tabs. Such items are not to be used to attach the device to the boat. Attaching the device to the boat will not permit it to perform as intended.

---

**NOTE: Model MD3184 has a built-in sailing harnesses intended for attaching to boats with quick-release under-load tethers secured to both d-rings (see Sailing Harness p. 13). Do not attach the MD3184 to boats using any other means.**

---

## AIRLINE OPERATOR POLICY ON CARRIAGE OF INFLATABLE PFDs AND CO<sub>2</sub> CARTRIDGES

Please be aware that the following regulations apply to the air transport of this product. According to U.S. Research and Special Programs Administration Regulations Title 49 CFR 75.10(a)(25): With the approval of the aircraft operator, one small carbon dioxide cylinder fitted into a self-inflating jacket, plus one spare cartridge, may be carried by a passenger or crew in checked or carry-on baggage.

Please refer to the governing body's documentation, found online at <http://hazmat.dot.gov>.









**DO NOT REMOVE  
PRIOR TO SALE.**



## research & Design

For 40 years Mustang Survival has been committed to providing life support solutions. Through constant innovation and the application of new technologies, Mustang is the leading supplier of quality flotation and hypothermia protection products to the most demanding users - from fishermen, sailors and power boaters to the Coast Guard, fighter pilots and even NASA astronauts.

**[www.mustangsurvival.com](http://www.mustangsurvival.com)**

TOLL FREE: 1.800.526.0532  
EMAIL: [custserv@mustangsurvival.com](mailto:custserv@mustangsurvival.com)

Mustang Survival and seahorse design is a registered trademark of Mustang Survival Corp.

Our commitment to quality has earned our Burnaby facilities ISO 9001 registration, the highest of all international standards. This is our guarantee you're receiving the ultimate in design and manufacturing.

HT-1121 (Rev 12Jun2012)

**[mustangsurvival.com](http://mustangsurvival.com)**

## Free Manuals Download Website

<http://myh66.com>

<http://usermanuals.us>

<http://www.somanuals.com>

<http://www.4manuals.cc>

<http://www.manual-lib.com>

<http://www.404manual.com>

<http://www.luxmanual.com>

<http://aubethermostatmanual.com>

Golf course search by state

<http://golfingnear.com>

Email search by domain

<http://emailbydomain.com>

Auto manuals search

<http://auto.somanuals.com>

TV manuals search

<http://tv.somanuals.com>