



USER'S GUIDE

Model 8718B

*Electromagnetic
Radiation
Survey Meter*

1 Introduction

◆◆◆◆ About the Model 8718B

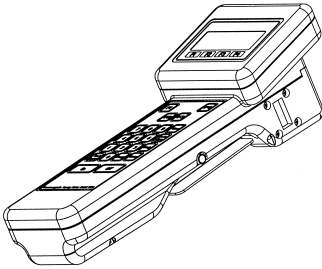

Your Model 8718B is a hand-held, battery-powered meter designed to simplify the measurement of electromagnetic fields. It can be used with any Narda 8700 Series probe. The 8718B is an upgraded version of the original Model 8718. Although there are many enhancements, the 8718B is most easily distinguished from its predecessor by the quick-release style probe connector.

The meter enables you to perform both simple measurements and more demanding ones that require averaging and/or data logging. It can be mounted on a tripod and used with an optional fiber optic link for enhanced accuracy in certain applications.

◆◆◆◆ Getting Started with the Model 8718B



Return the Owner Registration Card for updates and your copy of the Applications Booklet.

It is important to become familiar with the Model 8718B before you use it. Chapter 2 explains the basic meter hardware. Chapters 3 and 4 cover probe selection and basic operation. The menu system, which is the gateway to all the meter's advanced features, is the subject of Chapter 5.

It is strongly recommended that, as a minimum, you read Chapters 2-4, and preferably Chapter 5, thoroughly before you attempt to use the Model 8718B. The advanced features in Chapters 6 through 17 can then be referred to as required. Chapter 18 covers the use of the *User's Software*.

◆◆◆◆ **User's Guide Updates**

This User's Guide was thoroughly reviewed for accuracy prior to publication. Corrections to this guide necessitated by errors or omissions or by minor revisions to the meter firmware will be covered in the README file enclosed with the *User's Software*. The README file is available at any time from the HELP menu within the *User's Software*.

◆◆◆◆ **Equipment Supplied**

Your Model 8718B is supplied with:

- Meter
- Battery Charger/Power Supply
- Power Cord (230 volt chargers only)
- Storage Case
- Probe Extension Cable Model 8744-04
- Electric Field Attenuator Model 8713B
- User's Software (CD-ROM)
- Computer Cable
- User's Guide

◆◆◆◆ **Using this Guide with a Model 8718**

The Model 8718 can be upgraded to take advantage of most, but not all, of the improvements incorporated into the Model 8718B. The upgrade includes some minor hardware changes and the installation of the Version 3.0 firmware that is described in this guide. There are only a few differences in the operation of a Model 8718 upgraded with Version 3.0 firmware versus the new 8718B. Those differences are noted in this guide.

2

Understanding Your Model 8718B

General Description

It is important to be familiar with the Model 8718B before you use it. This section includes descriptive data keyed to highlighted illustrations to help you locate the various features of the meter. The descriptions not only identify the features but tell you how they are used.

Battery Charger and Power Cord

The battery charger and power cord are used to recharge the battery within the Model 8718B.

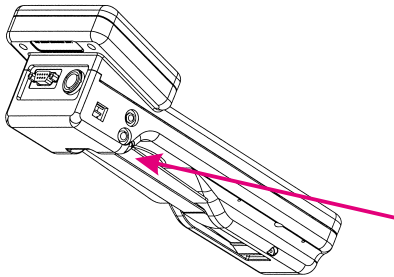

To recharge the meter, first connect the cable of the battery charger to the larger jack on the left side of the meter. Make sure the plug is fully inserted into the jack. Connect the power cord to the wall outlet.

The battery will be fully charged in about 8 hours. The indicator light on the charger illuminates during charging. A full charge will give you about 20 hours of operation (approximately 6.5 hours if back lighting is used).

The charger can also be used to power the Model 8718B when it is to be operated for periods beyond the capacity of the battery.

Note

NiCad batteries should be fully discharged (<20% indication) before recharging. Charge for a minimum of 8 hours. See Checking Battery Status in Chapter 12.

◆◆◆◆ Probe Connection

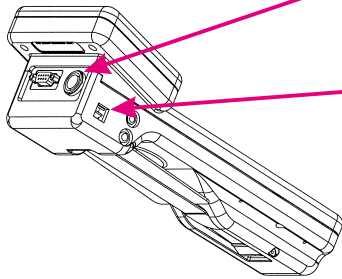

To make measurements, you must use your Model 8718B with a compatible probe. Connect the cable of the probe to the probe connector located at the top of the unit.

If you use a fiber optic link, the probe connects to a fiber optic transmitter. A fiber optic cable connects the transmitter to the rectangular fiber optic jack on the left side of the meter.

◆◆◆◆ Audio Alarm

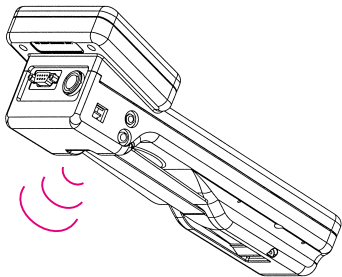

Your Model 8718B is equipped with an audible alarm that emits sound through a tiny hole on the bottom of the meter. The alarm sounds whenever the field strength exceeds the measurement range of the probe (over ranges).

You can also set the meter to sound its alarm at a specific level and/or turn on a variable-tone mode.

◆◆◆◆ Probe Test Sources

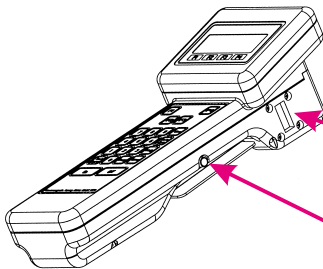

Your Model 8718B is equipped with two RF sources for testing your probes. The **Test Source** key will turn these sources on. They will stay on for approximately 20 seconds.

A microwave (waveguide) window on the right side of the probe is used for testing high frequency probes.

A contact on the right side of the meter is used for testing low frequency probes. Most probes have three test points on the head of the probe.

◆◆◆◆ Strap and Tripod Mount

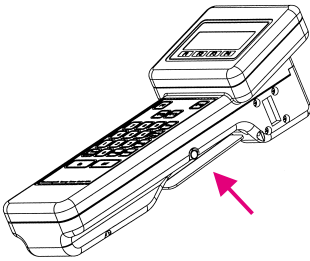

A strap is provided on the underside of the Model 8718B. It has a hook and loop closure to permit easy adjustment, around your hand.

Behind the strap is a threaded connector used to secure the meter to a tripod. Loosen the strap to access this connector.

◆◆◆◆ Operation With a Computer

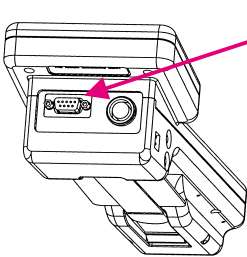

To update probe calibration information or retrieve stored measurements, you must connect your Model 8718B to a personal computer and use the *User's Software* provided by Narda.

See Chapter 18, *User's Software*.

◆◆◆◆ Operation With a Recorder

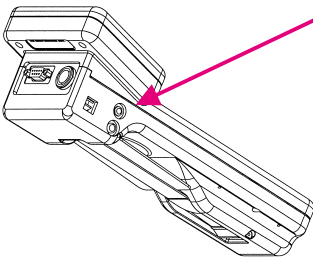

To obtain a continuous record of measurement over an extended period of time, you can connect a data recorder to the smaller jack located on the left side of the meter.

See Chapter 17, *Operation with a Data Recorder*.

Note

The keys on the 8718B must be firmly depressed to perform their function and give a tactile feedback when properly depressed.

Keypad

The Model 8718B has four groups of keys distinguished by their color.

Function keys	(green)
Numeric keys	(yellow)
Special Function keys	(white)
Power keys	(blue, green)

Power Keys

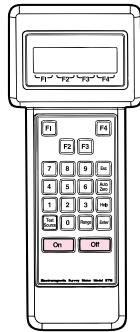

Two power keys are used to turn the Model 8718B **On** and **Off**.

Function Keys

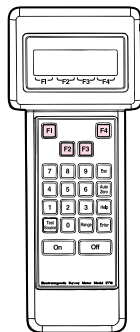

Use the four function keys

(**F1-F4**) to select the options displayed on the bottom line of the display screen directly above the F1, F2, F3, and F4 markings. In a few cases the options will be spelled out on the display.



Numeric Keypad

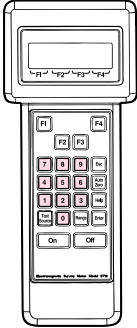

Use the numeric keypad to enter number data into the Model 8718B. You also use the numeric keypad to select a numbered option listed on the display screen.



Special Function Keys

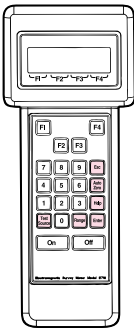

Six special function keys enable you to perform specific functions.

- Esc** Returns you to the previous menu. In a few cases you must enter a selection rather than use the **Esc** key.
- Auto Zero** Enables you to automatically zero the meter and probe.
- Help** Displays a help screen that explains your options.
- Test Source** Turns on the built-in low frequency and high frequency probe test sources for approximately 20 seconds.
- Range** Locks in a specific measurement range for the bar graph. The digital display is not affected. The meter automatically displays a digital value over the probe's entire measurement range. See *Bar Graph Ranges* on page 23.
- Enter** Stores data you entered with the numeric keypad. Confirms an option you selected from a menu screen.

3

Probe Selection

Introduction

The 8700 series RF measurement system offers a very broad selection of probes. The factors that you should consider in selecting the probe, or probes, best suited for your task are described in this section.

Key Factors in Selecting a Probe

FREQUENCY RANGE

The probe frequency range should include the frequencies of all the emitters to be surveyed at one time.

POWER DENSITY OR FIELD STRENGTH

The measurement range of the probe should be adequate for the field levels that you anticipate, i.e., do you expect strong fields or weak fields? Probes give more accurate and more stable readings when they are not used at the extreme low end of their sensitivity range. Therefore, if you anticipate measuring very weak fields, select a probe with a lower power full-scale measurement range to get greater sensitivity. In contrast, higher power probes give additional safety margins, especially at microwave frequencies where field strength can change rapidly with a small change in distance to the source. Select a probe with a higher power full-scale measurement range if you anticipate measuring high level fields.

ELECTRIC FIELD VERSUS MAGNETIC FIELD

Most standards recommend that you measure both electric (E) and magnetic (H) fields below 300 MHz (due to the possibility that measurements may be made in the near field). Since most experts agree that the electric field poses a greater danger at lower frequencies due to induced and contact currents that can occur, the electric field is normally measured first. Higher frequency measurements are normally made of only the electric field since measurements will generally be made in the far field.

FLAT RESPONSE OR SHAPED FREQUENCY RESPONSE

Flat response probes are the most common. Narda's patented shaped frequency response probes read out in **Percent of Standard** and are particularly useful in complex, multi-signal environments where exposure limits are different for the various emitter frequencies and in classified environments.

SIZE AND MINIMUM MEASUREMENT DISTANCE

The majority of the 8700 series probes have four-inch (10 cm) diameter heads. The minimum measurement distance for these probes is about 4 inches (10 cm) from the outside surface of the probe. Measurements made at closer distances can result in inaccurate readings due to capacitive coupling. The Models 8721D, 8723D, and 8725D have two-inch (5 cm) diameter heads that can be used as close as 2 inches (5 cm) from the source to the outside of the probe. These probes are ideal for the measurement of **waveguide leaks**. Similarly, the Model 8781D has a one-inch (2.5 cm) diameter head with a flexible shaft that is designed for locating leaks in densely packaged microwave systems.



Shaped Frequency Response Probes

The goal in designing and manufacturing a traditional, "flat" frequency response probe is to make the probe equally responsive to energy at every frequency within its rated frequency range. In contrast, Narda's patented shaped frequency response probes are designed and manufactured so that their sensitivity mirrors a particular standard as closely as possible. For example, many of the major standards in the world set limits for maximum exposure at the lowest frequencies of 100 mW/cm². These same standards typically limit exposure in the VHF region to 1 mW/cm² and to 5-10 mW/cm² in the microwave region. A shaped frequency response probe designed for such a standard is 100 times more sensitive in the VHF region than at the lowest frequencies. The result is that energy from all sources within the probe's rated frequency range are not only summed in terms of RMS power but are also weighted in direct proportion to a particular standard's frequency dependent exposure limits.

Note

It is important to understand that each shaped frequency response probe model is designed to conform to a particular standard.

The readout on the 8718B is shown in terms of **Percent of Standard**. The full scale of Narda's shaped probes is typically either 300% or 600% of a standard. This permits measurements of exposure environments where the weighted field strengths range from as high as three to six times the maximum permissible exposure (MPE) level to environments where the levels are less than one percent of the MPE.

Connecting a Probe

Connect a cable with a quick-release, eight-pin connector to the connector at the top of your Model 8718B. This cable will be either (1) a short adapter cable for attachment to older style 8700 series probes with integral cables or (2) a 4 ft. (1.2m) long cable with a quick-release connector on both ends for use with the 8700 "D" series probes. The D series probes have a quick-release, eight-pin connector that allows the probe to attach directly to your 8718B or be used with a cable

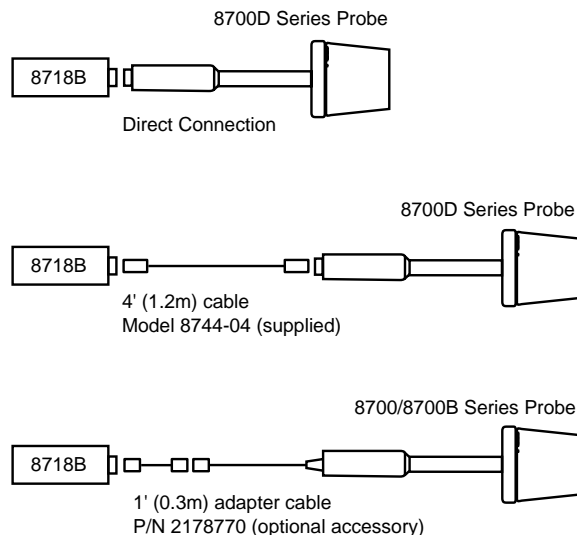

A direct connection can be useful for certain low frequency measurements. See *Low Frequency Measurements* in the Applications Booklet.

◆◆◆◆ Probe Identification

Narda 8700D series probes use the following labels and indicators:

- Certified Calibration Date Label
- Model Identification Label

- Field Type (E or H)
- Full Scale Measurement Range
- Model Number
- Standards (Shaped Probes Only)
- Frequency Range
- Serial Number

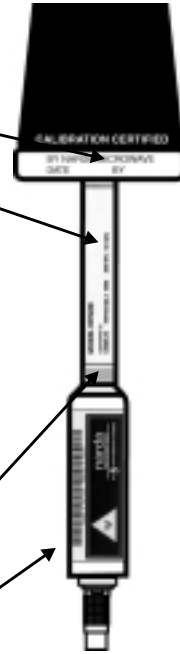
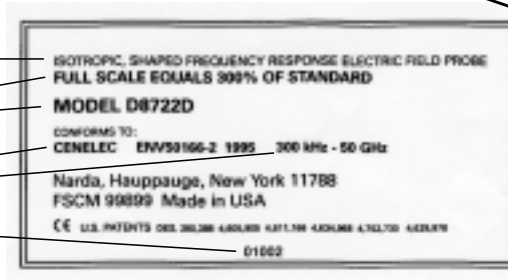

- Color Band to Indicate the Full Scale Measurement Range (20 mW/cm² probes do not have a colored band)
- Calibration Label With Frequency Correction Factors

- Correction Factor Listed for Every Calibration Frequency
- Model Number and Serial Number

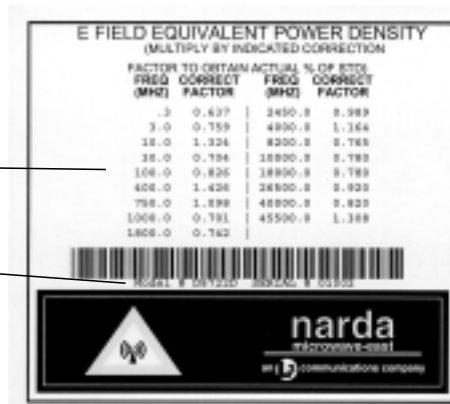

4

Making a Measurement

Introduction

This chapter will help you make measurements with your Model 8718B. Information is included for turning the meter on, selecting, zeroing, and testing a probe, plus an explanation of the main measurement screen of the meter. Some general information is also included about measurement surveys, precautions you should observe, and the use of probe correction factors.

Getting Started

Press the **On** power key. The meter model, serial, and firmware version will be displayed briefly. After a few seconds, the *Opening Menu Screen* will appear.

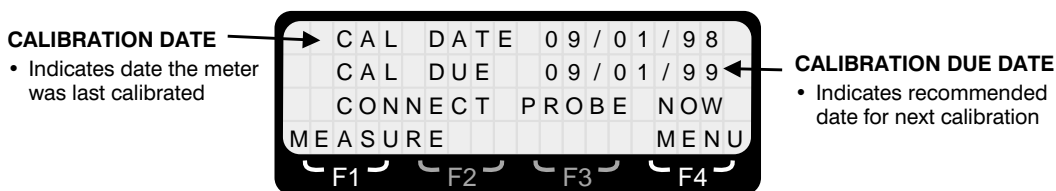

To Make Measurements...

1. Select the probe you want to use and connect it to the meter.
2. Proceed as directed in *Entering the Probe Model*.

Note

See Chapter 5, *Using the Menu System*, for details on features and operation.

To access the meter's menu system to perform some other function...

1. Press **F4 (MENU)**. The *First Menu Screen* will appear. See Chapter 5, *Using the Menu System*.



Entering the Probe Model

The single most important thing you must do is tell the 8718B meter which probe you are using.

Narda's 8700 Series system is completely modular — all 8700 series meters work with all 8700 series probes. The single most important thing you must do is tell the 8718B meter which probe you are using.

The Model 8718B has the basic characteristics of every 8700 Series probe stored in its internal memory. All you have to do is select the correct model number and the meter automatically sets the correct scales.

The Model 8718B **can also store the specific calibration details for up to six probes**. This includes the probe serial number, calibration date, and the calibration factors marked on the handle of the probe. Probes with this additional detail stored in the meter are referred to as **probes in memory**.

Putting probes into memory has several advantages:

- It makes it easier to select a probe
- Data that is downloaded after using a data logging mode will include a record of the probe's calibration date and its serial number.
- It makes using frequency correction much easier.

Probes are put into the meter's memory using a personal computer:

- *By Narda* on the day of shipment for all probes shipped at the same time as the meter.
- *By you* at any time when you use the *User's Software* supplied by Narda and a personal computer. Refer to Chapter 18, *User's Software* for detailed information regarding computer operations.

To select from the PROBES IN MEMORY...

1. If you haven't already, press **F1 (MEASURE)**.
2. The model number and the serial number of the last probe used will be displayed on the second line of the display. If you want to use the same probe, press **Enter**.

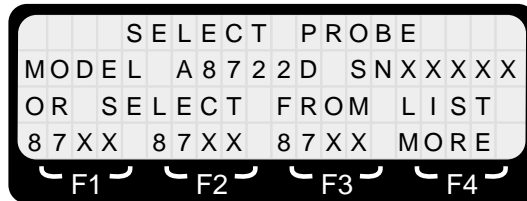

3. If you want to use a different probe, look for the model number in the positions above the F1, F2, or F3 legends. If more than three probes are in memory they can be found by pressing **F4 (MORE)**.
4. Press the appropriate function key and the probe model and serial number will be displayed on the second line of the screen. If this is correct, press **Enter**.
5. A new screen will appear specifying probe model number, serial number, frequency range, field type, maximum measurement range, and type of response (flat or shaped). If this information is correct, press **F1**. If this information does not match your requirements, you need to select another probe. Press **F2** and you will go back to the *Select Probe* screen to make another selection.

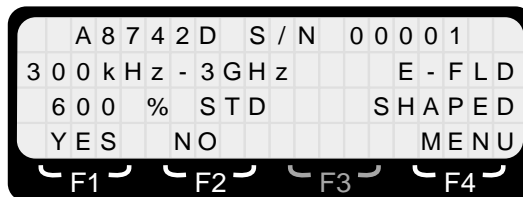

6. Proceed with the probe zeroing process. See *Zeroing the Probe* on page 17.

To use a PROBE that is NOT IN MEMORY...

1. If you haven't already, press **F1 (MEASURE)**.
2. The model number of the last probe used will be displayed on the second line of the display. If you want to use the same model probe, press **Enter**.

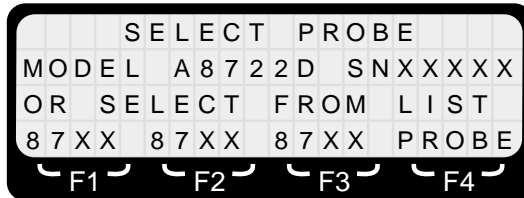

3. If you want to use a different model probe, select **PROBE** by pressing **F4**. If more than three probes are in memory, you will have to press **F4** twice (**MORE**, then **PROBE**). One of several screens that list all 8700 series probes will appear.



Note

You must return to the Opening Menu Screen and repeat the probe selection and zeroing process if you want to change probes. Press 7 (Probe) from the First Menu Screen and then press F4 (RESTART).

4. If you see the model of the probe you want to use, press the appropriate number key. The newer "D" series probes are listed first.
5. If you do not see the model number you want, use the **7 (BACK)** or **8 (NEXT)** keys to page forward and backward until you do. Press the appropriate number key to select a probe model.
6. A new screen will appear specifying probe model number, frequency range, field type, maximum measurement range, and type of response (flat or shaped). If this information is correct, press **F1**. If this information does not match your requirements you need to select another probe. Press **F2** and you will go back to the **Select Probe** screen to make another selection.

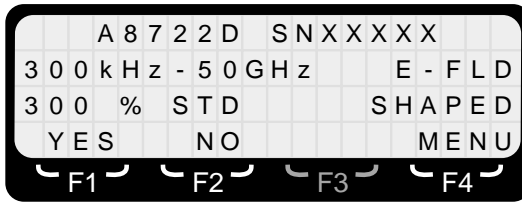

7. Proceed with the probe zeroing process.

◆◆◆◆ **Zeroing the Probe**

The probe and meter must be “zeroed” together. It is important that the probe is not exposed to radiated fields during the zeroing process. The storage case is shielded and provides a convenient “zero density” environment.



Position the probe in the case with one test point pointed downward and the other two test points above the foam. This will insure that the test points are not touching the foam.

To zero the probe...

1. Place the probe in the storage case. Be careful not to move the probe while zeroing takes place (on probes with low frequency test points, you can create static which will give inaccurate results).
2. When you are ready, press the **ENTER** key. The screen will say **ZEROING**.
3. The meter will beep and the main measurement screen will appear in about 15 seconds after zeroing is completed.

If you get a message that the probe could not be zeroed, the most likely causes are:

- *The probe is not connected properly.* Check the connector and retry.
- *The meter is set for a fiber optic input and you are using the standard cable input (or vice versa).* Turn the meter off. Turn the meter back on and press **(F4) (MENU)** to access the menu system. Press **8 (NEXT)** to get to the *Second Menu Screen*. Press **3 (CABLE/FO)** to the probe input status. Press **F1 (OK)** if it is correct or **F4** to select the alternate. Then press **Esc** to return to the *Opening Menu Screen*.



See Chapter 12, **Probe Zero**, for additional information on the characteristics of the survey system including the causes of zero drift.

- *The field strength is not low enough.* Move away from the RF field source, use the storage case to zero the probe.
- *The probe is damaged.* Try another probe.

To reconfirm the zero while the instrument is in use...

1. Establish a zero density environment for the probe as before.
2. Press the **Auto Zero** key. This will automatically “touch up” the zero and correct for any drift in a few seconds.

◆◆◆◆ **Measurement Display Screens**

There are two display screen options:

- *The Main Measurement Display Screen.*
- *The Alternate Measurement Display Screen.*

◆◆◆◆ **Main Measurement Display Screen**

The *Main Measurement Display Screen* shows a maximum value on the third line of the display. The *Alternate Measurement Display Screen* provides frequency-specific, real time information instead of a maximum value.

◆◆◆◆ Main Measurement Display Screen (Shaped Probes)

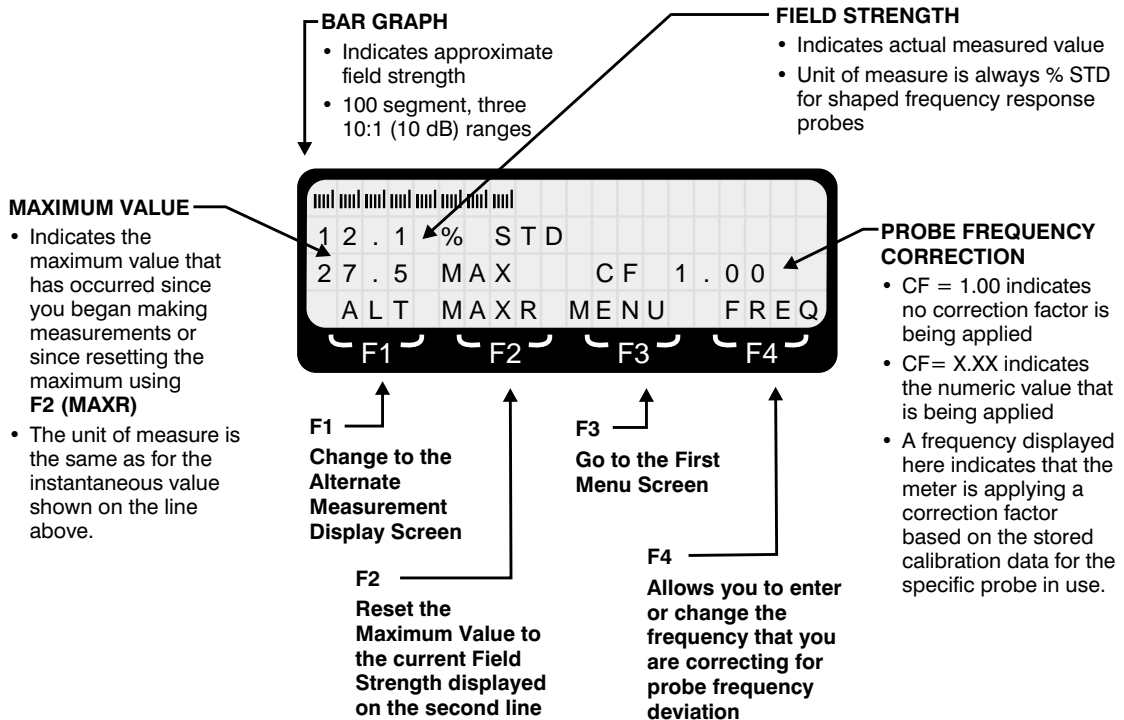

◆◆◆◆ Main Measurement Display Screen (Flat Probes)

The Main Measurement Display Screen for flat frequency response probes is the same as the screen for shaped frequency response probes except as indicated below.

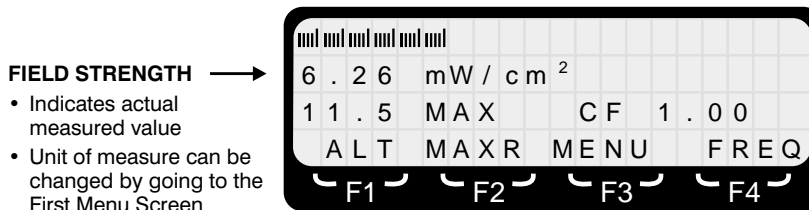



Note

The Alternate Measurement Display Screen should only be used for single frequency measurements or where all emitter frequencies are close and the exposure standard has the same limits. Refer to Using Probe Correction Factors on page 24.

Alternate Measurement Display Screen

The *Alternate Measurement Display Screen* is very similar to the *Main Measurement Display Screen* with one difference. This display mode is used to show frequency-specific, real time information on the third line of the display instead of a maximum value. It should be used only for single frequency or narrow band measurement applications. The information that is shown depends on whether a flat frequency response probe or a shaped frequency response probe has been selected.

- **Flat Frequency Response Probes.** This display mode instantly converts the measured value to a percent of the referenced exposure standard at a particular frequency.
- **Shaped Frequency Response Probes.** This display mode instantly converts the measured value, shown in Percent of Standard, to an equivalent power density value at a particular frequency.

The use of the *Alternate Measurement Display Screen* also introduces an automatic correction for probe frequency deviation for probes in memory.

The option to change display screens is only available when other options such as spatial averaging, data logging or time averaging have not been turned on.

To use the Alternate Measurement Display Screen...

1. Make sure that the 8718B is set to the correct exposure standard. See Chapter 11 *Using the Standards Feature*.
2. Press **F4 (FREQ)** from the *Main Measurements Display Screen*. A new screen will appear to allow you to enter a frequency.
3. Enter the frequency that you are measuring. You must fill all four positions. If you make a mistake just enter more digits until correct. For greater accuracy, use the units that allow the larger number. For example, enter 10.00 kHz, not 00.01 MHz.

◆◆◆◆ Alternate Measurement Display Screen (Shaped Probes)

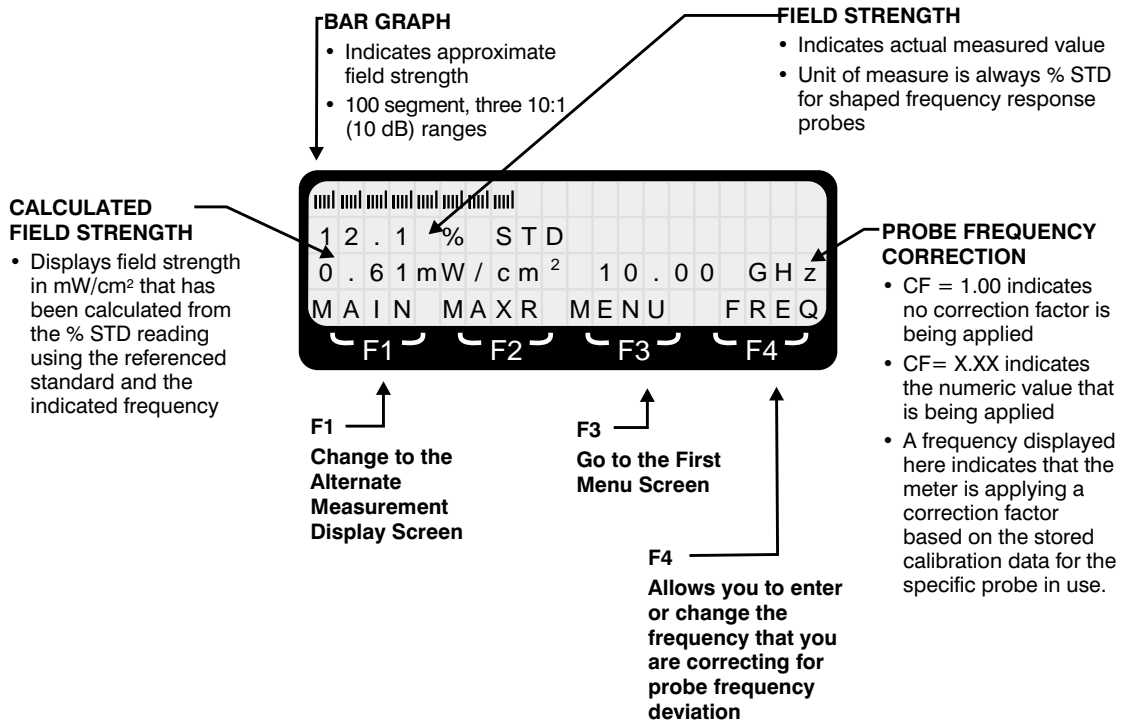

◆◆◆◆ Alternate Measurement Display Screen (Flat Probes)

The Alternate Measurement Display Screen for flat frequency response probes is the same as the screen for shaped frequency response probes except as indicated below.

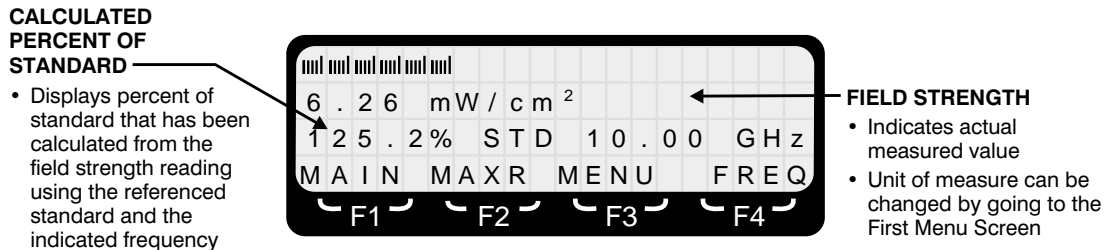



Alternate values cannot be calculated at low frequencies for standards with very high magnetic field limits. A “greater than” symbol (>) is shown under these conditions.

4. Change the units (if needed) by pressing either **F1 (kHz)**, **F2 (MHz)**, or **F3 (GHz)**.
5. Press **F4 (SAVE)**. The probe correction factor will be displayed briefly if you are using a probe in memory and you will automatically return to the measurement screen. See *Using Probe Correction Factors* on page 24.
6. From the Main Measurement Screen press **F1(ALT)** to select the *Alternate Measurement Display Screen*.

To return to the Main Measurements Display Screen...

1. From the *Alternate Measurement Display Screen*, press **F1 (MAIN)** to select the *Main Measurements Display Screen*.



Bar Graph Ranges

The **Range** key is used to control how the bar graph displays information. The digital display is not affected and the meter automatically displays a digital value over the probe's entire measurement range. There are four available settings: **AUTO**, **HIGH**, **MID**, and **LOW**. The bar graph has 100 divisions.



Note
The Range Key only affects how the bar graph displays information.

You will probably find it convenient to use the **AUTO** setting most of the time, but under a few conditions you may find one of the three fixed ranges useful. The following table illustrates how the range setting will affect the bar graph. For simplicity, a probe with a full scale rating of 100 mW/cm² is used as an example.

Range	Measurement Range
AUTO	As the field level increases the bar graph automatically switches between three ranges: 0.01 to 1, 1 to 10, and 10 to 100.
HIGH	1 to 100
MID	0.1 to 10
LOW	0.01 to 1

If you exceed the upper limit of either the **MID** or **LOW** range, the bar graph will be replaced with the message **RANGE OVERLOAD**. The digital display will continue to show the correct value. If you exceed the full scale measurement range of the probe, the word "OVERLOAD" will appear



Testing the Probe

Your Model 8718B is equipped with two RF sources for testing probes. Press **Test Source** and both sources will stay on for approximately 20 seconds.

A contact on the right side of the unit is used for testing low frequency probes and the low frequency section of ultra-broadband probes. Most probes have three test points around the head of the probe. Position the probe so that one of the test points touches the contact on the meter. You should

Note

A probe that does not show a movement of the bar graph for all three (or six) tests may be damaged and should not be used to make measurements.

get a deflection on the bar graph but the amount of deflection is not important. Repeat for the other two test points to insure that the probe is working correctly. The D series magnetic field probes have a single, conductive test point that is used to simultaneously test all three sensors.

A microwave window on the right side of the probe is used for testing high frequency probes. Hold the probe parallel to the right side of the meter and position the probe head against the test window so that one of three arrows on the probe is pointing towards the window. These arrows indicate the location of the three sensors inside the probe. A deflection of any magnitude on the bar graph is acceptable. Repeat for the other two sensors to insure that the probe is working correctly.

Ultra-broadband probes contain both high frequency and low frequency sensors. These probes require six checks – three high frequency and three low frequency.



Using Probe Correction Factors

All probes have a certain amount of frequency sensitivity. Frequency sensitivity is the amount of deviation from the correct measured value that a probe yields at various frequencies. Obviously, the smaller the deviation, the better. But since a certain amount of frequency deviation is unavoidable, the more frequencies that you calibrate the probe at, the better. At each calibration frequency, you have a correction factor.

Multiplying the reading on the meter by a correction factor marked on the handle of a Narda 8700 Series probe compensates for the probe's frequency sensitivity. The Model 8718B is unique because it can perform this task automatically.

Correction factors can be used:

- When there is only a single emitter being surveyed.
- When there are multiple emitters all operating at the same frequency (this is often the case with industrial equipment).

- When there are multiple emitters with frequencies that are close to each other and the nearest calibration frequencies have very similar correction factors.

Correction factors should NOT be used:

- When the frequencies of the emitters are diverse. Correction factors may vary considerably and there is no way to determine the distribution of energy from the various emitters. It is more accurate not to use a correction factor under these conditions. See *Measurement Uncertainty* on page 27.



Do not use correction factors in a broadband, multi-emitter environment.

To use a correction factor for a probe in memory...

1. Press **F4 (FREQ)** from the measurement screen. A new screen will appear to allow you to enter a frequency.
2. Enter the frequency for which you want to correct readings. Make sure you fill in all four positions. If you make a mistake just enter more digits until correct. For greater accuracy, use the units that allow the larger numbers. For example, enter 10kHz, not 00.01 MHz.
3. Change the units (if needed) by pressing either **F1 (kHz)**, **F2 (MHz)**, or **F3 (GHz)**.
4. Press **F4 (SAVE)**. The meter will automatically calculate the correction factor for the frequency you have entered from the two closest correction factors that were stored when you put the probe in memory. The calculated numeric value will be displayed briefly before the meter automatically returns to the measurement screen. See page 64 for a more complete description.
5. The frequency that you are correcting for will be displayed on the right side of the third line of the display.

To use a correction factor for a probe NOT in memory...

1. Press **F3 (MENU)**. The *First Menu Screen* will appear.

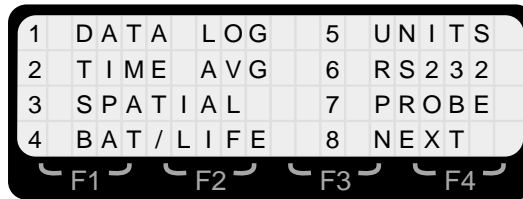

2. Press **8 (NEXT)** to access the *Second Menu Screen*.

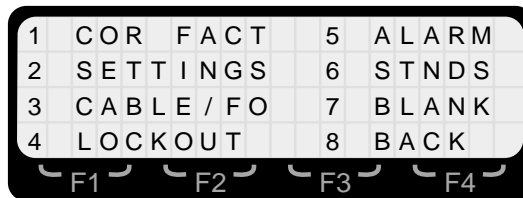

3. Press **1 (COR FACT)**. A screen will appear that shows the correction factor.
4. Use the correction factors on the handle of the probe to determine the appropriate correction factor and then use the numeric keys on the meter to enter this value. Enter a three digit number, ignoring the decimal point, and rounding to two digits to the right of the decimal point. If you make a mistake, just enter more digits until correct. For example, to enter a correction factor of 1.22, simply enter **1**, **2**, and then **2** while a correction factor of 0.94 is entered as **0**, **9**, and **4**.
5. Press **Enter** to save this correction factor. The meter automatically returns to the measurement screen.
6. The numeric correction factor will be displayed on the right side of the third line of the display in the form **CF X.XX**.

◆◆◆◆ Checking or Changing the Probe Model

To check the probe model that the meter is currently set to...

1. Press **F3 (MENU)**. The *First Menu Screen* will appear.
2. Press **7 (PROBE)**. A Screen will appear that shows the model number and basic characteristics of the probe. The probe serial number is shown for probes selected from memory.

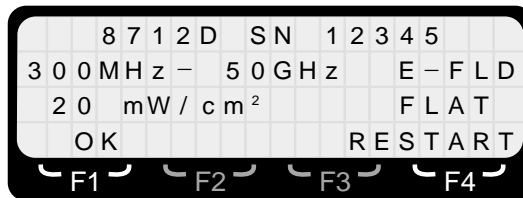

3. Press **F1 (OK)** key to return to the *First Menu Screen*.
4. Press **Esc** to return to the *Measurement Display Screen*.

To change to another probe without turning the meter off...

1. Press **F3 (MENU)**. The *First Menu Screen* will appear.
2. Press **7 (PROBE)**. A screen will appear that shows the model number and basic characteristics of the probe.
3. Press **F4 (RESTART)** to return to the *Opening Menu Screen*. Press **F1 (MEASURE)** and begin the probe selection process.

◆◆◆◆ Measurement Uncertainty

The uncertainty of any measurement includes several factors related to the probe and meter.

- Frequency response or frequency sensitivity is typically ± 1 dB to ± 2 dB (from about $\pm 25\%$ to about $\pm 55\%$). The correct use of correction factors can greatly reduce the amount of uncertainty associated with frequency response.

- Ellipse ratio is ± 0.75 dB or better, depending on the model of the probe. The ellipse ratio is the ratio of readings that occur when one rotates the probe around the axis of its handle. Narda calibrates its probes by rotating the probe about its axis and using the mean value to determine the correction factor. If you rotate the probe around its axis and use the mean value, ellipse ratio can be eliminated as a source of uncertainty.
- Isotropic response is the error that occurs when the probe is pointed in different directions. It includes the ellipse ratio plus some additional uncertainties. Although the probes pick up energy from all directions, they are most accurate when pointed at the source of energy. Generally speaking, the isotropic response is no greater than the ellipse ratio providing that the probe is pointed towards the source.
- Calibration uncertainty represents another 0.5 dB.
- The Model 8718B meter has a maximum uncertainty of $\pm 3\%$.

A good rule of thumb is that the total uncertainty is no greater than ± 3 dB when correction factors are not used, providing that the probe is pointed at the source of energy. There are other issues related to field perturbation that can be more significant sources of uncertainty. See *Field Perturbation in Measurement* in the Applications Booklet.

◆◆◆◆ **Making a Measurement**

Refer to the Applications Booklet for both general and specific information on making measurements.

◆◆◆◆ **Precautions**

When making measurements of electromagnetic fields, a potential exists to expose yourself to excessive levels. Approach the source of energy slowly and begin making measurements from a distance at which low field levels exist. Be prepared to evacuate the area immediately if RF field levels in excess of the applicable standard are observed.

5

Using the Menu System



General

The menu system allows you to store data and to select various operating modes. It is accessed by pressing the appropriate function key that corresponds to **MENU** on the bottom line of the display screen. The menu is comprised of two menu screens and several sub-menus. Press the number on the keypad that matches the number on the menu to make your selection.

Instructions or sub-menus appear when one of the basic menu options is selected. Press the **Help** key or refer to the appropriate chapter of this guide for detailed instructions.

The following keys are used to move through the various menu options and to set measurement parameters:

Function Keys F1 - F4	Most menu options are offered on the fourth (bottom) line of the display. Simply press the function key that matches the marking just below the display.
Numeric Keys 0 - 9	Used to make a selection where options are listed on several lines of the display. Often, multiple options are listed in two columns. Used to input a specific value or range (frequency, data logging interval, time and date, etc.).
ENTER Key	Press the ENTER key after entering a numeric value to complete the selection process.
ESC key	Press the ESC key to return to the previous screen without making a selection.

◆◆◆◆ First Menu Screen

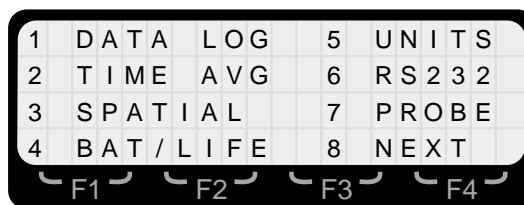

Key	Menu	Options	Chapter
1	DATA LOG	Log with time and date stamp. Log spatially averaged values with time and date stamp. Continuous logging at various rates.	8
2	TIME AVG	Turn fixed time averaging (various duration) <i>on</i> or <i>off</i> .	9
3	SPATIAL	Turn the spatial averaging mode (used for whole body averaging) <i>on</i> or <i>off</i> .	7
4	BAT/LITE	Check battery charge status and estimated time remaining. Turn the back light <i>on</i> or <i>off</i> .	12
5	UNITS	Select from all appropriate units of measure (i.e., mW/cm ² , V/m, V ² /m ²) for the probe in use. Percent of Standard is the only unit of measure for shaped frequency response probes.	6
6	RS232	Change the baud rate. Turn the RS232 port <i>on</i> or <i>off</i> . (Automatic on for Model 8718B. Menu is for Model 8718 only)	17
7	PROBE	Show the model and serial number of the probe in use. Select another probe and restart the zeroing process	4
8	NEXT	Go to the <i>Second Menu Screen</i> .	

◆◆◆◆ Second Menu Screen

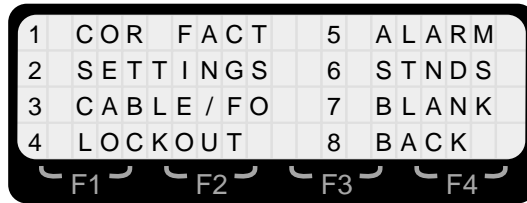

Key	Menu	Options	Chapter
1	COR FACT	Enter a numeric probe correction factor.	4
2	SETTINGS	<p>Check or set the meter's internal clock (time/date)</p> <p>Enter a value for temperature. Used when the probe is separated from the meter and operating at a different ambient temperature.</p> <p>Clear the memory of logged data.</p> <p>Set the function keys for right or left handed operation.</p> <p>Adjust the display contrast.</p>	15
3	CABLE/FO	Select between the standard probe cable input and the fiber optic receiver.	16
4	LOCKOUT	Lock the keypad so that settings will not accidentally be changed. To release, press ENTER and ESC together.	13
5	ALARM	<p>Turn the audio alarm <i>on</i> or <i>off</i>.</p> <p>Set the alarm threshold in terms of percent of full scale of the probe in use (1% to 99%).</p> <p>Turn the variable tone alarm <i>on</i> or <i>off</i>.</p>	10
6	STNDS	Check or set the standard that is referenced for various measurement options.	11
7	BLANK	Blank the display and lock the keypad. To release, press ENTER and ESC together.	13
8	BACK	Return to the first menu screen.	

◆◆◆◆ **Menu Commands**

The following is a list of menu commands that are shown on the fourth line of the display and selected by using the four function keys (F1-F4).

AUTO	Auto – returns the meter to the normal, automatic temperature correction mode.
ABORT	Abort clearing the memory
BEGIN	Begin – confirms that the meter is ready to perform time averaging to meet the requirements of a specific standard.
CABLE	Cable – changes the meter input from fiber optic receiver to the standard cable input.
CANCEL	Cancel making the selection and return to the previous menu.
CONT	Continuous – initiate logging for an undefined interval.
CLEAR	Clear the memory of logged data.
CLR	Clear the screen and return to making real time measurements.
DISCARD	Discard this data point without storing it.
END	End the logging run or averaging interval.
FO	Fiber Optic – changes the meter input from the standard cable input to the fiber optic receiver.
FREQ	Frequency – change or enter a frequency.
GHz	GHz – used to enter a frequency.
HR	Hours – used to define a logging interval.
kHz	kHz – used to enter a frequency.
LEFT	Left – set menus for left-handed operation.
LOG	Log the current measured value.

MAIN	Main – switch to the Main Measurement Display Screen.
MAXR	Maximum Reset - reset the maximum value to the instantaneous value.
MEASURE	Measure – begin the measurement process by selecting and zeroing the probe.
MEM	Memory – display the available memory.
MENU	Menu – access the <i>First Menu Screen</i> .
MIN	Minutes – used to define a logging interval.
MHz	MHz – used to enter a frequency.
NO	No – the current probe selection is incorrect. Return to the menu to make another selection.
OFF	Off – turn special mode off.
OK	OK – continue with the same setting.
ON	On – turn special mode on.
PAUSE	Pause during data logging or time averaging.
QUIT	Quit special mode and return to the standard measurement screen.
RESTART	Restart the probe selection and zeroing process.
RGT	Right – set menus for right-handed operation.
SAVE	Save the data point or the new setting.
SEC	Seconds – used to define a logging interval.
SET	Set the time, date, temperature, or display contrast.
START	Start averaging or data logging.
STNDS	Standards – access the menu of available exposure standards.
STOP	Stop the current averaging run.
YES	Yes – the current probe selection is correct. Proceed with zeroing process.

◆◆◆◆ **Default Conditions Upon Turn-On**

The Model 8718B is designed to automatically return to a basic set of operating parameters every time it is turned on. Although in some cases this may require additional key strokes to set up the meter as desired, this feature is designed to minimize the chance of making measurements while unknowingly having the meter incorrectly configured.

The table below lists the operating parameters that can be expected upon turn-on.

Parameter	Default Condition
Alarms	Last Used settings will be used
Back Light	OFF to conserve battery power.
Blank Out	OFF – display will be active.
Cable/Fiber Optic	Last Used input will be active.
Data Logging	OFF
Display Contrast	Last Used setting will be in use.
Display Screen	Main Measurement Display Screen
Lockout	OFF – keypad will be active.
Probe Model	Last Used probe model will be featured on the probe selection screen.
Right/Left	Last Used setting for function key location will be in use.
RS232 Port	OFF to conserve battery power.
Spatial Averaging	OFF
Standard	Last Used standard will be referenced.
Temperature Correction	OFF – the meter will sense ambient temperature and automatically correct.

Time Averaging

OFF

Unit of Measure

Last Used unit of measure will be in use if previous and current probe both have flat or shaped frequency response. If current probe is shaped, unit will be % of STD. If current probe is flat and previous probe was shaped, then unit will be mW/cm².

6 Units of Measure

Available Units of Measure

The 8718B Meter allows you to quickly select any unit of measure that is appropriate for the probe in use. The available units of measure depend on whether the probe is designed to measure the electric field or the magnetic field. It also depends on whether the probe has a “flat” frequency response or a “shaped” frequency response. The available units of measure for the various types of probes are:

Field Component	Frequency Response	Units of Measure
Electric	Flat	mW/cm ² , W/m ² , V/m, V ² /m ² , pJcm ³
Magnetic	Flat	mW/cm ² , W/m ² , A/m, A ² /m ² , pJcm ³
Electric	Shaped	Percent of Standard
Magnetic	Shaped	Percent of Standard

Note

Percent of Standard is the only unit of measure available for shaped frequency response probes. Shaped probes have frequency response curves designed to mimic a particular exposure standard. See Chapter 3, Shaped Frequency Response Probes.

◆◆◆◆ Changing the Unit of Measure

To change the unit of measure that the meter is set for ...

1. Access the menu system by pressing the function key that corresponds to the legend below **MENU** on the bottom line of the display.
2. Press the number **5** on the keypad to select **UNITS** from the *First Menu Screen*. A screen will appear that offers the available units of measure for the probe in use.

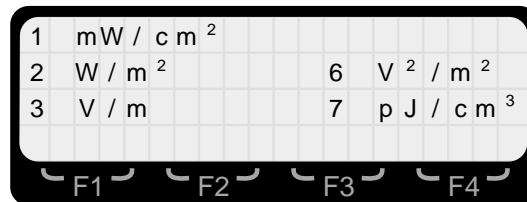

3. Press the number key on the keypad that matches the desired unit of measure. For example, pressing **1** selects **mW/cm²** as the unit of measure. This unit of measure is available for all probes with a flat frequency response.
4. The meter will automatically return to the measurement screen. If you had accessed the menu system from the *Opening Menu Screen*, you will return to that screen.

7

Spatially Averaged Measurements



Understanding Spatial Averaging

The major standards concerned with human exposure to radio frequency radiation specify maximum exposure levels averaged over the whole body. The co-linear dipole antenna arrays that are very common in modern wireless communications systems, for example, have multiple lobes close to the antenna. The field strength typically varies by 6-7 dB along the length of an array. Therefore, the measured value is highly dependent on not only the distance from the antenna but the height above the ground.

The traditional method of making spatially-averaged measurements is to use a “storypole”. A storypole is a non-conductive pole, often wooden, equal in height to an average adult with distance marks equally spaced along its length. Measurements are made alongside the storypole at each height and then mathematically averaged. The height and spacing of each measurement varies from standard-to-standard. For example, the IEEE C95.1-1999 standard specifies measurements from 0 centimeters (ground level) to 200 centimeters in 20 centimeter increments. Some exposure standards, such as Canada’s Safety Code 6, require that measurements be averaged across two dimensions – vertically and horizontally. Modern wireless communications sites make this manual technique more difficult than ever since field levels at many sites, particularly multi-user sites, are constantly varying. For example, paging systems go on and off and the number of cellular channels in use is constantly changing. Thus, a series of measurements made at varying heights can vary more as a function of time than location.

◆◆◆◆ **Spatial Averaging with the 8718B**

The Model 8718B uses time to quickly make precise, spatially averaged measurements. With the 8718B set for spatial averaging, press the **F1** function key to start the timer. Pressing the same key again stops the timer. During this interval of time, the meter takes a large number of measurements. The results are presented as both an average value and a peak value. Effective measurement technique requires you to simply move the probe slowly from toe-to-head while the timer is running. Although this technique may not be specifically called out in a particular exposure standard, it is technically sound and much more accurate than averaging a series of measurements. It is anticipated that future updates of the major standards will reflect this automatic technique now that the survey equipment makes it practical.

To make spatially averaged measurements ...

1. Access the menu system by pressing the function key that corresponds to the legend below **MENU** on the bottom line of the display.
2. Press the number **3** on the keypad to select **SPATIAL** from the *First Menu Screen*.

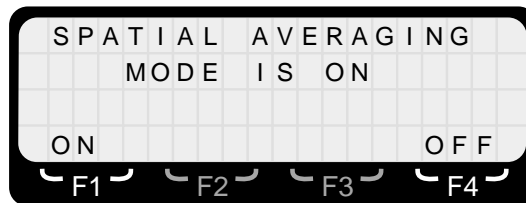

3. Press **F1 (ON)**.
4. The meter will automatically return to the measurement screen with new options for the function keys. If you had accessed the menu system from the *Opening Menu Screen* (where the calibration dates are shown), you will return to that screen.
5. Holding the meter in one hand and the probe in the other, touch the head of the probe to the ground.

Note

It is important to move the probe vertically at a constant rate to obtain an accurate spatially averaged measurement.

- Press **F1 (START)** while slowly moving the probe vertically at a constant rate of movement.

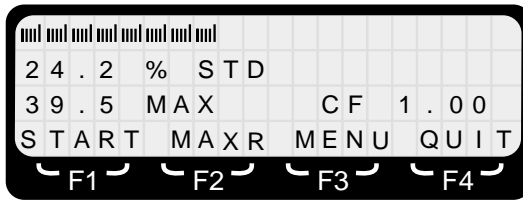

- Strive for an interval of about ten seconds between starting and stopping the timer. The meter will beep every second as a timing aid.
- When the probe reaches the height equal to the top of an adult's head (about 6 ft./1.9 m), press **F1** again (**STOP**).

Note

The averaging time resolution is approximately 1/4 second.

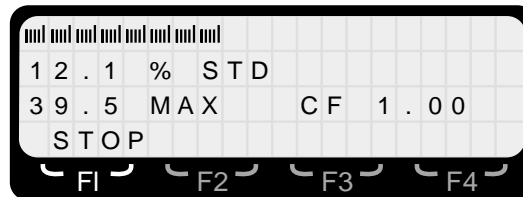

- The meter will show the average value on the second line of the display and the maximum value on the left side of the third line of the display. The bar graph will be indicating the instantaneous field magnitude in real time. The averaging interval will be shown on the right side of the third line, which can be useful in perfecting your spacial averaging technique.

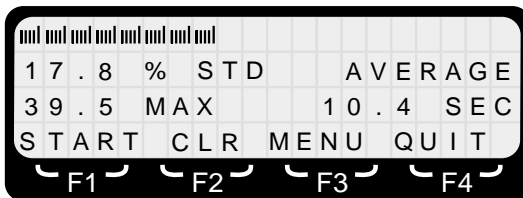

10. To make another spatially averaged measurement, press **F1 (START)** again.
11. To temporarily suspend the spatial average mode and make real time measurements, press **F2 (CLR)**. To make another spatially-averaged measurement, press **F1 (START)** again.
12. To end spatial averaging altogether, press **F4 (QUIT)**. The meter will automatically return to the standard measurement screen. If you had accessed the menu system from the *Opening Menu Screen*, you will return to that screen.
13. To initiate spatial averaging again at a later point, use the menu system to select **SPATIAL** from the *First Menu Screen*.

8

Data Logging

◆◆◆◆ Logging Options

The 8718B Meter features several methods of collecting data. The basic choices are:

- **Logging Data with the Meter.** The logged data stored in the meter is downloaded to a computer at a later date using the *User's Software*, where it can be viewed and printed. The data can also be exported in spreadsheet or database formats for further processing.
- **Continuous Output to a Computer.** Data collection, if any, is performed by the computer.
- **Analog Output.** An analog voltage is continuously available for use with a Chart Recorder or A/D converter.

◆◆◆◆ Logging Data

The 8718B has three logging modes to collect field strength measurements, store the data in the meter's memory, and later export the data to a personal computer via the RS232 port on the top of the meter. The three logging modes are:

Mode 1

- Collect a series of up to 999 data points, one at a time, and automatically assign a *reference number* to each data point. The reference numbers can refer to either site plan locations or to a diagram of the industrial equipment being surveyed. Each data point also has a time and date stamp.

Mode 2

- Collect a series of up to 999 spatially-averaged data points, one at a time, and automatically assign a *reference number* to each data point. Both the average value and the maximum value at each location are stored. The reference numbers can refer to either site plan locations or to a diagram of the industrial equipment being surveyed. Each data point also has a time and date stamp.

Mode 3

- Automatically collect a series of data points at specific intervals of time for a specific time period. Each data point also has a time and date stamp.



Format for Logged Data

A record contains a header and one or more data points. Each record is identified by a user-defined two-digit *survey number* and the time and date the survey was performed. The header defines the serial number of the 8718B meter, its calibration date, the probe model used, and a number of other settings. These settings may include logging rate, frequency correction, averaging mode, and averaging time.

If the probe used was selected from memory, the header will also include the serial number of the probe and its calibration date.



If you access the menu system from the Opening Menu Screen, you will return to that screen. Once a probe has been selected and zeroed, the measurement screen will reflect the logging mode that you have selected.

To initiate one of the three logging modes described above...

1. Access the menu system by pressing the function key that corresponds to the legend below **MENU** on the bottom line of the display.
2. Press the number **1** on the keypad to select **DATA LOG** from the *First Menu Screen*.
3. A new menu will appear, presenting the three logging modes. If any of the three logging modes is currently active, the line showing that option will be flashing.

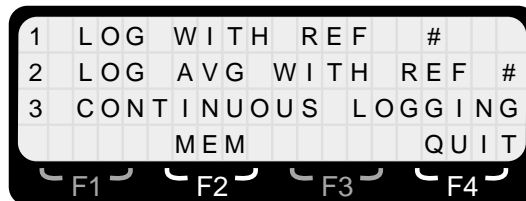

4. To review the available memory before beginning to make logged measurements, press **F2 (MEM)**.
5. A screen will appear showing the approximate amount of available memory and the amount of memory already used. The bar graph is a rough indicator of remaining memory capacity as a percentage of total capacity. See *Memory Capacity* at the end of this chapter for information on how to determine the number of additional measurements that can be stored.



6. Press **Esc** to return to the logging menu screen.
7. To turn off the logging feature, press **F4 (QUIT)**.

◆◆◆◆ Mode 1 Logging

To initiate Mode 1 logging (a series of data points with a reference number assigned to each data point)...

1. Press the number **1** on the keypad to select **LOG WITH REF #** from the logging menu screen.
2. A screen will appear requesting that you assign a two-digit *survey number* to this logging run of data points. Use the numeric keypad to enter the two-digit number and then press **F1 (OK)** or **ENTER**. Make note of this number so that you can later associate this survey number with the data points collected. If you make a mistake, press **F2 (CLR)** to clear the screen and enter a new survey number.

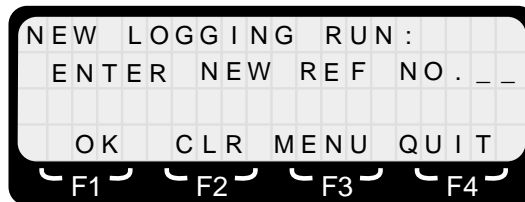

3. Press **F4 (QUIT)** or **F3 (MENU)** if you change your mind.
4. The meter will automatically return to the measurement screen with new options available for the function keys.

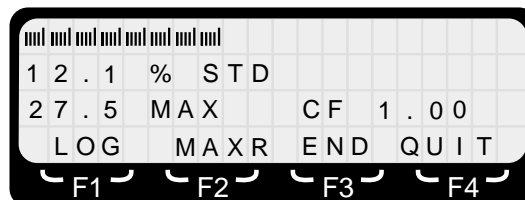

5. Proceed to make measurements as normal. To log the value of the point currently being measured and displayed on the second line of the display, press **F1 (LOG)**.

6. A screen will appear that indicates the value of reading that has been *temporarily* stored in memory and the number of the data point. The first data point will be **001**.

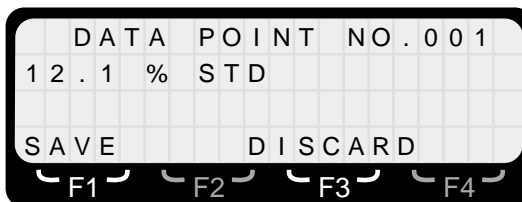

7. Press **F1 (SAVE)** to *permanently* log this data point into the meter's memory with its associated data point number. The meter will automatically return to the measurement mode.
8. Press **F3 (DISCARD)** to erase the data point from the meter's temporary memory. The meter will automatically return to the measurement mode.
9. Press **F1 (LOG)** again to log the second data point. It will automatically be assigned data point **002** providing that you had saved the first data point. If you had elected to discard the first data point, then this point will be designated data point **001**.
10. Press either **F1 (SAVE)** or **F3 (DISCARD)**. The meter will automatically return to the logged measurements screen.
11. Continue to record up to 999 data points in this manner.
12. To end this logging run and begin a new run, press **F3 (END)**. The screen will appear that allows you to enter another two-digit survey number.



13. Use the numeric keypad to enter a new two-digit survey number and then press **F1 (OK)** or **ENTER**. Again, make note of this number so that you can later associate this survey number with the data points collected. If you make a mistake, press **F2 (CLR)** to clear the screen and enter a new survey number. The meter will automatically return to the logged measurements screen.
14. To end logging altogether and return to the standard measurement screen, press **F4 (QUIT)**. To initiate logging again at a later point, use the menu system to select **DATA LOG** from the *First Menu Screen*.

◆◆◆◆ Mode 2 Logging

To initiate Mode 2 logging (a series of spatially-averaged data points with a reference number assigned to each data point)...

1. From the main data-logging screen, press the number **2** on the keypad to select **LOG AVG WITH REF #** from the logging menu screen.

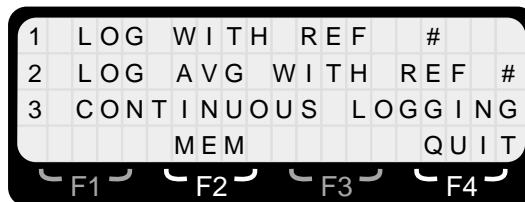

2. A screen will appear requesting that you assign a two-digit *survey number* to this logging run of data points. Use the numeric keypad to enter the two-digit number and then press **F1 (OK)** or **ENTER**. Make note of this number so that you can later associate this survey number with the data points collected. If you make a mistake, press **F2 (CLR)** to clear the screen and enter a new survey number.

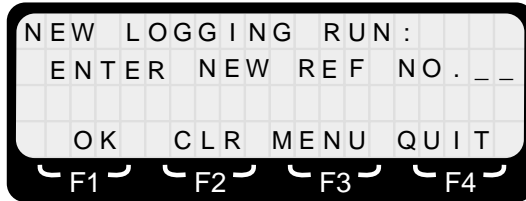

3. Press **F4 (QUIT)** or **F3 (MENU)** if you change your mind.
4. The meter will automatically return to the measurement screen with new options available for the function keys.

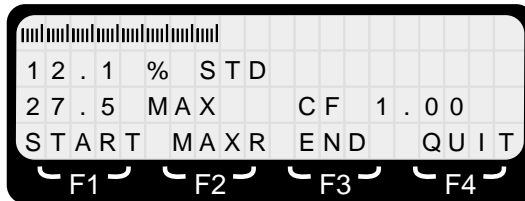

Note

It is important to move the probe vertically at a constant rate to obtain an accurate spatially averaged measurement.

5. Proceed to make measurements as normal. To initiate making a spatially-averaged measurement that will be logged, hold the meter in one hand and the probe in the other with the head of the probe touching the ground.
6. Press **F1 (START)** while slowly moving the probe vertically *at a constant rate of movement*. Keep your finger on the **F1** key during this operation.
7. Strive for an interval of about ten seconds between starting and stopping the timer. The displayed value will flash and the audio signal will sound every second as a timing aid.
8. When the probe reaches the height equal to the top of an adult's head (about 6 ft./1.9 m), press **F1** again (**STOP**).

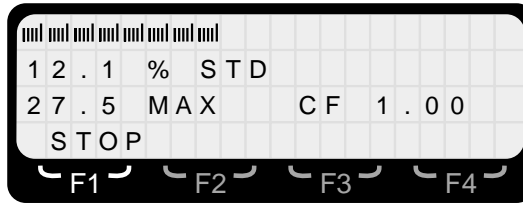

9. A screen will appear that indicates the average and maximum values of the reading that has been *temporarily* stored in memory and the number of the data point. The first data point will be **001**.

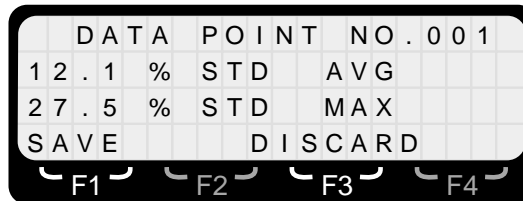

10. Press **F1 (SAVE)** to *permanently* log this data point into the meter's memory with its associated data point number. The meter will automatically return to the logged measurement screen.
11. Press **F3 (DISCARD)** to erase the data point from the meter's temporary memory. The meter will automatically return to the logged measurement screen and display real time values.
12. Press **F1 (START)** again to begin the second spatially averaged data point. It will automatically be assigned data point **002** providing that you had saved the first data point. If you had elected to discard the first data point, then this point will be designated data point **001**.
13. Press either **F1 (SAVE)** or **F3 (DISCARD)**.
14. Continue to record up to 999 spatially-averaged data points in this manner. Both the average and maximum values will be saved and will be associated with a specific data point number.

- To end this logging run and begin a new run, press **F3 (END)**. The screen will appear that allows you to enter another two-digit survey number.

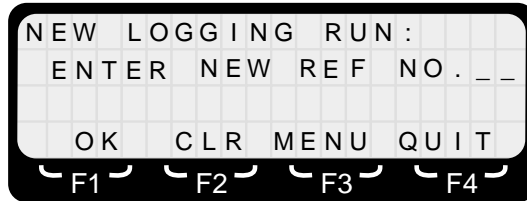

- Use the numeric keypad to enter a new two-digit survey number and then press **F1 (OK)** or **ENTER**. Again, make note of this number so that you can later associate this survey number with the data points collected. If you make a mistake, press **F2 (CLR)** to clear the screen and enter a new survey number. The meter will automatically return to the logged-measurements screen.
- To end logging altogether and return to the standard measurement screen, press **F4 (QUIT)**. To initiate logging again at a later point, use the menu system to select **DATA LOG** from the *First Menu Screen*.

◆◆◆◆ Mode 3 Logging

To initiate Mode 3 logging (a series of data points automatically logged at specific intervals)...

- From the main data logging screen, press the number **3** on the keypad to select **CONTINUOUS LOGGING** from the logging menu screen.

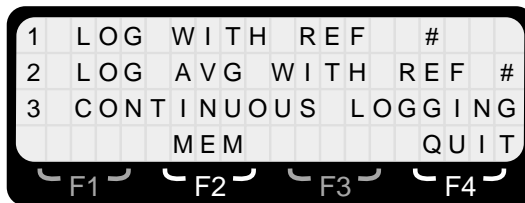

2. A screen will appear requesting that you assign a two-digit *survey number* to this logging run of data points. Use the numeric keypad to enter the two-digit number and then press **F1 (OK)** or **ENTER**. Make note of this number so that you can later associate this survey number with the data points collected.

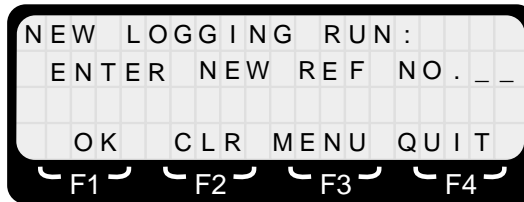

3. A new menu screen will appear that offers five different logging rates: **1/SEC**, **10/MIN**, **1/MIN**, **10/HR**, and **2/HR**.



4. Press the number on the numeric keypad (1-5) that corresponds to the desired logging rate.
5. A new menu screen will appear. The numeric keypad and the function keys are used to define the duration of time to be logged.

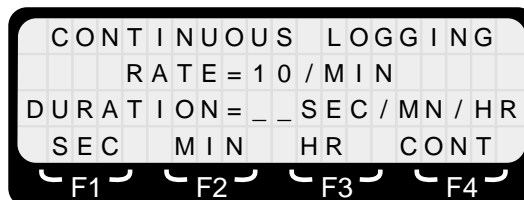

6. To log for a specific interval of time, enter a two-digit number on the keypad. If you make a mistake entering a number, simply continue entering numbers until the correct value is displayed. Then press either **F1 (SEC)**, **F2 (MIN)**, or **F3 (HRS)** and the meter will automatically return to the measurement screen with new options available for the function keys.
7. To log for an indeterminate interval of time (until you tell the meter to stop or the memory is filled), press **F4 (CONT)**. The meter will automatically return to the measurement screen with new options available for the function keys.

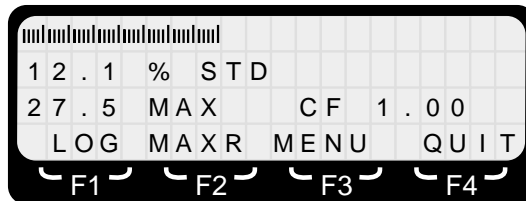

8. Proceed to make measurements as normal. To initiate logging, press **F1 (LOG)**. The meter will beep every time a data point is recorded.

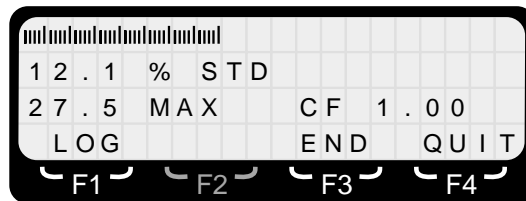

9. If a specific interval of time had been selected, the meter will automatically stop logging at the end of this interval. To stop logging earlier or when set to an indeterminate period of time, press **F3 (END)**.

10. A screen will appear requesting that you assign another two digit survey number to the new logging run. Use the numeric keypad to enter the two-digit number and then press **F1 (OK)** or **ENTER**. Again, make note of the number for later use. If you make a mistake, press **F2 (CLR)** to clear the screen and enter a new survey number. The meter will automatically return to the logged measurements screen.

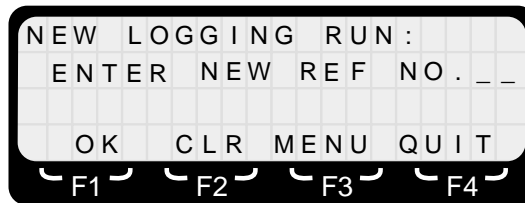

To begin another logging run at a different rate or for a different duration...

- Press **F3 (MENU)**. Press the number **1** on the keypad to select **DATA LOG** from the *First Menu Screen* and proceed as previously described.

To end logging altogether and return to the standard measurement screen...

- Press **F4 (QUIT)**. To initiate logging again at a later point, use the menu system to select **DATA LOG** from the *First Menu Screen*.

◆◆◆◆ ***Memory Capacity***

To determine the remaining memory of the 8718B meter...

1. Access the menu system by pressing the function key that corresponds to the legend below **MENU** on the bottom line of the display.
2. Press the number **1** on the keypad to select **DATA LOG** from the *First Menu Screen*.

3. Press **F2 (MEM)**.
4. A screen will appear showing the approximate amount of available memory and the amount of memory already used. The bar graph is a rough indicator of remaining memory capacity as a percentage of total capacity.



A record contains a header and one or more data points. To estimate the approximate number of data points and records (logging runs) that can be stored with the available memory ...

1. Allocate 33 bytes for each header. A separate header is used for each record.
2. Allocate 7 bytes for each data point from Mode 1 and Mode 3 logging.
3. Allocate 14 bytes for each for each spatially averaged data point from Mode 2 logging. More memory is used in this mode because both average and peak values are stored.
4. Determine whether there is sufficient available memory to perform the desired task. If there is, proceed with logging as described above.
5. If you determine that there is insufficient memory to perform the desired task because much of the meter's memory has been used, it will be necessary to empty the memory. Press **F4 (QUIT)**
6. To download the current memory contents, you must connect the 8718B to a computer. See Chapter 18, *User's Software*.

7. To discard the contents of the meter's memory once the contents have been downloaded or without saving the information, access the menu system by pressing the function key that corresponds to the legend below **MENU** on the bottom line of the display.
8. Press **8 (NEXT)** to get to the *Second Menu Screen*.
9. Press **2 (SETTINGS)**.
10. A new screen will appear offering several options.

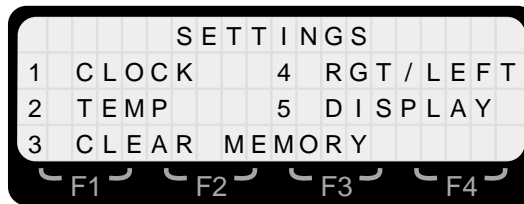

11. Press **3 (CLEAR MEMORY)**. A screen will appear requesting that you confirm your request and warning that the stored information will be lost.

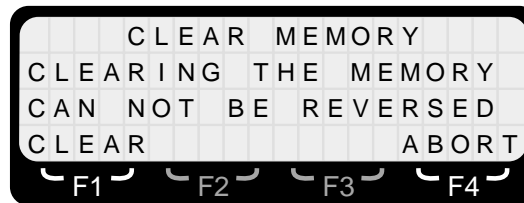

12. Press **F1 (CLEAR)** to clear the memory or **F1 (ABORT)** to return to the *First Menu Screen* without clearing the memory.

◆◆◆◆ Analog Output

The 8718B Meter allows the user to output a DC voltage that is proportional to the instantaneous measured value. When connected to a typical chart recorder, it will provide a continuous analog record of the measured field strength. See Chapter 17, *Operation with a Data Recorder*.

9

Time-Averaged Measurements

Measurement Options

The 8718B meter features two averaging modes:

Mode 1

- Perform fixed-time averaging over any one of several specific time intervals.

Mode 2

- Perform averaging to meet the requirements of a specific standard. The averaging period is automatically set by meter.

Making Time-Averaged Measurements

To make time averaged measurements ...

1. Access the menu system by pressing the function key that corresponds to the legend below **MENU** on the bottom line of the display.
2. Press number **2** on the keypad to select **TIME AVG** from the *First Menu Screen*.
3. A new menu will appear offering two averaging modes. The status of both modes will be shown.

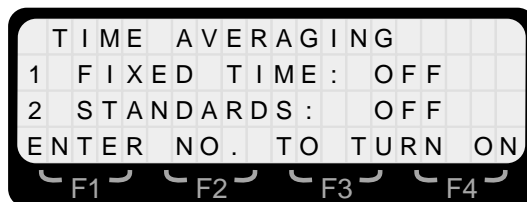

4. Press **F4 (OFF)** to turn either time averaging mode off and return to the measurements screen.

◆◆◆◆ Mode 1 Averaging

To initiate Mode 1 averaging (fixed time averaging over any one of several specific time intervals)...

1. Press number **1** on the keypad to select **FIXED TIME** from the averaging menu screen. Selecting Mode 1 averaging will automatically shut off Mode 2 averaging if it is on.
2. A new menu screen will appear that offers four different averaging intervals: **30 SEC**, **1 MIN**, **6 MIN**, and **30 MIN**. If an averaging interval had previously been selected and is currently active, that selection will be flashing.

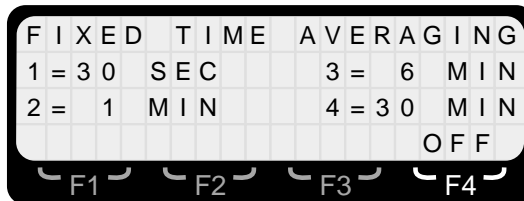

3. Press the number on the numeric keypad (**1-4**) that corresponds to the desired averaging interval and the meter automatically returns to the measurement screen with new options available for the function keys. If you had accessed the menu system from the *Opening Menu Screen*, you will return to that screen.

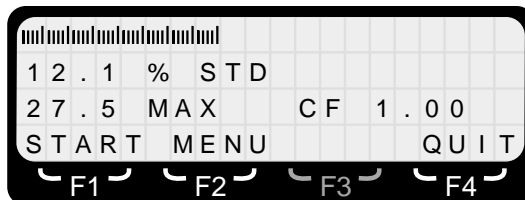

4. At any time you can press **F4 (QUIT)** to turn the time averaging mode off and return to the normal measurements screen.

5. The meter will continue to make real-time measurements until you initiate making the time-averaged measurement.
6. Determine where you want to make the averaged measurement and place or hold the probe in the desired position. For short intervals, it may be practical to hold the meter in one hand and the probe in the other. For longer intervals, it is suggested that you place the probe on some form of non-conductive stand so that it does not move. At frequencies above 50 MHz, the meter should be separated from the probe by a minimum of 12 inches (30 centimeters) to minimize any interaction between the meter, the probe, and the electromagnetic field. At the lower frequencies, the measurement techniques are very different. See *Low Frequency Measurements* in the Applications Booklet.
7. Press **F1 (START)** when you are ready to begin the time-averaged measurement.
8. The averaged value is displayed on the screen and will flash each time it is updated (one second intervals). The meter will automatically stop at the end of the selected averaging interval.
9. To end time averaging prior to the end of the averaging interval, press **F4 (STOP)**.

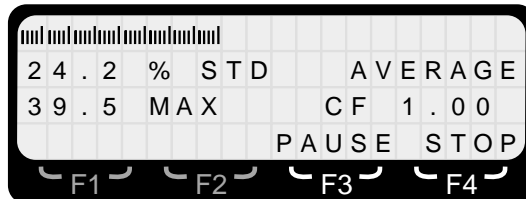

10. At the end of the averaging interval, the meter will show the time-averaged value and the averaging interval on the second line of the display. The maximum value will be shown on the third line of the display. The bar graph will be indicating the instantaneous field strength in real time.

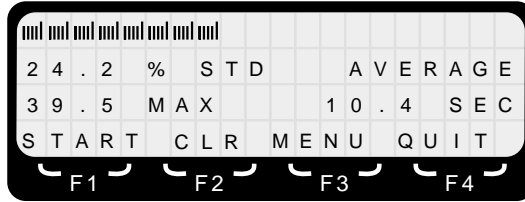

11. To make another time-averaged measurement over the same interval, press **F1 (START)** again.
12. To temporarily suspend the time average mode (once the current measurement interval has been completed or stopped) and make real time measurements, press **F2 (CLR)**. To make another time-averaged measurement over the same interval, press **F1 (START)** again.
13. To end time averaging altogether and return to the standard measurement screen (once the current measurement interval has been completed or stopped), press **F4 (QUIT)**. To initiate time averaging again at a later point, use the menu system to select **TIME AVG** from the *First Menu Screen*.



Note
If you access the menu system from the Opening Menu Screen, you will return to that screen. Once a probe has been selected and zeroed, the measurement screen will reflect the averaging mode that you have selected.

To temporarily pause during a time-averaged measurement...

1. To temporarily suspend time averaging, press **F3 (PAUSE)**. The word ***PAUSED*** will appear on the fourth line of the display. To resume time averaging and complete the measurement, press **F1 (START)**.

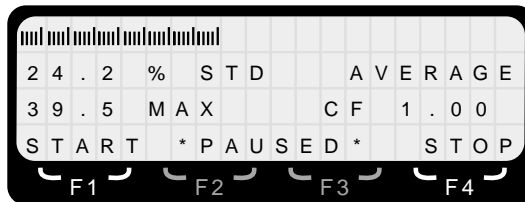



The PAUSE feature can be useful when measuring the average value from certain rotating radars. The effective measurement technique requires you to pause during the period of time when you are not in the beam of the radar. Continue this technique for two or more revolutions (depending on the RPM) to obtain a realistic average value of the field in the beam at your location. For details on this measurement technique, see Radar Measurements in the Applications Booklet.

2. You may continue to pause and start the averaging as many times as needed. The time interval initially selected applies only to the measurement time.
3. To end time averaging while ***PAUSED***, press F4 (**STOP**).

To change the averaging interval...

1. To change the averaging interval (once the current measurement interval has been completed or stopped), press **F4 (QUIT)**. To initiate a new time averaging interval, use the menu system to select **TIME AVG** from the *First Menu Screen*.
2. Proceed as previously described to select **FIXED TIME** from the averaging menu screen and then the new averaging interval.



Mode 2 Averaging

Mode 2 averaging (time averaging to meet the requirements of a specific standard) requires two parameters to be properly set before being used:

- The meter must be set to the correct standard for your application.
- The meter must be set for a specific frequency because the averaging time in many standards is frequency dependent. For example, IEEE C95.1-1999 specifies a six minute averaging period for *Controlled Environments* from 3 kHz to 15 GHz. Above 15 GHz, the averaging period decreases to ten seconds at 300 GHz based on a logarithmic function.

To set the meter for a specific frequency...

1. Press **F4 (FREQ)** from the measurement screen. A new screen will appear to allow you to enter a frequency.

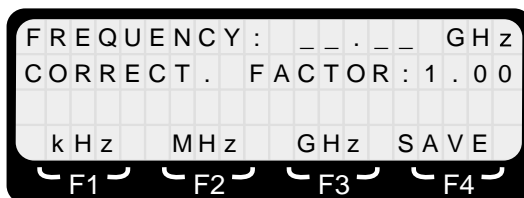

2. Enter the frequency that you want to use for the time-averaged measurements. Make sure you fill in all four positions. If you make a mistake just enter more digits until correct. For greater accuracy, use the units that allow the larger number. For example, enter 10.00 kHz, not 00.01 MHz.
3. Change the units (if needed) by pressing either **F1 (kHz)**, **F2 (MHz)**, or **F3 (GHz)**.
4. Press **F4 (SAVE)**. The meter will automatically return to the measurement screen.
5. If the probe used is a *probe in memory*, the frequency that you have set will be displayed on the right side of the third line of the display. The meter will also automatically correct the readings for probe frequency deviation. The meter does this by using the closest calibration frequencies above and below the selected frequency to calculate and apply an appropriate correction factor. This new correction factor is briefly shown on the second line of the display after you press **F4 (SAVE)** before the meter automatically returns to the measurement screen.

To initiate Mode 2 averaging (averaging to meet the requirements of a specific standard)...

1. Make sure that the meter is set for the correct standard or change it if needed. See Chapter 11, *Using the Standards Feature*.
2. Make sure the meter is set to the correct frequency for the measurement you are making. See page 64.
3. Press number **2** on the keypad to select **STANDARDS AVG** from the averaging menu screen. Selecting Mode 2 averaging will automatically shut off Mode 1 averaging if it is on.
4. A new screen will appear stating that averaging has been enabled in accordance with a specific standard.

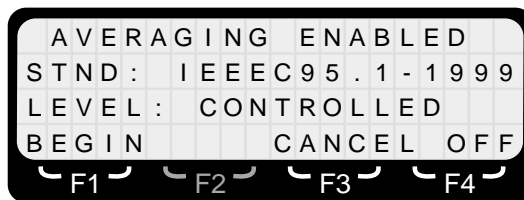

5. Press **F3 (CANCEL)** to return to the initial time averaging menu screen to make another selection or press **F4 (OFF)** to turn time averaging off and return to the standard measurement screen.
6. Press **F1 (BEGIN)** to automatically return to the measurement screen with new options available for the function keys.



7. The meter will continue to make real time measurements until you initiate making the time-averaged measurement.
8. Press **F1 (START)** when you are ready to begin the time-averaged measurement.
9. The averaged value is displayed on the screen and will flash every second each time it is updated. The meter will automatically stop at the end of the averaging interval, which was determined by the standard and the frequency.
10. To end time averaging prior to the end of the averaging interval, press **F4 (STOP)**.

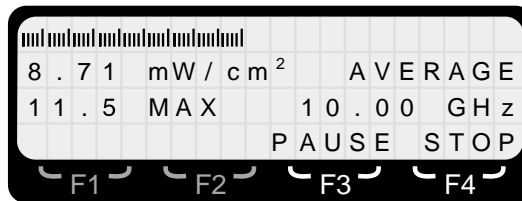

Note

If you access the menu system from the Opening Menu Screen, you will return to that screen. Once a probe has been selected and zeroed, the measurement screen will reflect the averaging mode that you have selected.

11. At the end of the averaging interval, the meter will show the time-averaged value on the second line of the display and the maximum value on the third line of the display. The bar graph will be indicating the instantaneous field strength in real time.

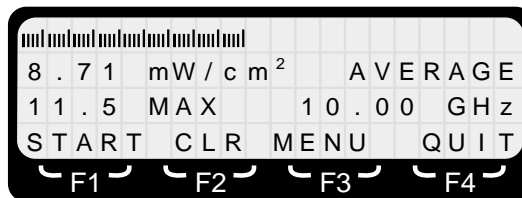

12. To make another time-averaged measurement at the same frequency, press **F1 (START)** again.

Note

The PAUSE feature can be useful when measuring the average value from certain rotating radars. The effective measurement technique requires you to pause during the period of time when you are not in the beam of the radar. Continue this technique for two or more revolutions (depending on the RPM) to obtain a realistic average value of the field in the beam at your location. For details on this measurement technique, see Radar Measurements in the Applications Booklet.

- To temporarily suspend the time average mode (once the current measurement interval has been completed or stopped) and make real time measurements, press **F2 (CLR)**. To make another time-averaged measurement under the same conditions, press **F1 (START)** again.
- To end time averaging altogether and return to the standard measurement screen (once the current measurement interval has been completed or stopped), press **F4 (QUIT)**. To initiate time averaging again at a later point, use the menu system to select **TIME AVG** from the *First Menu Screen*.

To temporarily pause during a time averaged measurement...

- To temporarily suspend time averaging, press **F3 (PAUSE)**. The word ***PAUSED*** will appear on the fourth line of the display. To resume time averaging and complete the measurement, press **F1 (START)**.



- You may continue to pause and start the averaging as many times as needed. The time interval determined by the standard and the frequency applies only to the measurement time (excludes time when "PAUSED").
- To end time averaging while ***PAUSED***, press **F4 (STOP)**.

To change the frequency...

1. To change the frequency (once the current measurement interval has been completed or stopped), press **F2 (CLR)** if the averaged value is displayed.
2. Once the meter is displaying real time values, the frequency menu is accessed by pressing **F3 (FREQ)**.
3. Proceed as previously described to set the meter to a new frequency.

10 Alarm Settings

Alarm Description

The Model 8718B Meter is equipped with an audible alarm that emits sound through a tiny hole on the bottom of the meter. The alarm sounds automatically whenever the field strength exceeds the measurement range of the probe or *over ranges*.

The meter can also be set to sound its alarm at a specific level and/or to sound a variable tone indication of field strength.

Controlling the Alarm Functions

Note

If you access the menu system from the Opening Menu Screen, you will return to that screen. Once an alarm setting has been made, the alarm function will be initiated once the meter is placed into the measurement mode.

To make changes to the audio alarm settings...

1. Access the menu system by pressing the function key that corresponds to the legend below **MENU** on the bottom line of the display.
2. Press **8 (NEXT)** to go to the *Second Menu Screen*.
3. Press **5 (ALARM)** to access the alarm menu. A new menu will appear that allows you to:
 - Turn the audio alarm *on* or *off*.
 - Set the alarm threshold in terms of percent of full scale of the probe in use (1% to 99%).
 - Turn the variable tone alarm *on* or *off*.

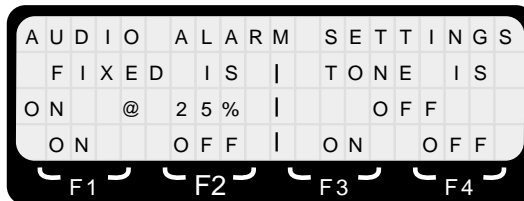

4. The left side of the display gives the status of the fixed alarm. It indicates whether the fixed alarm is either *on* or *off* and the current alarm threshold setting in terms of percent of full scale of the probe in use (1% to 99%).
5. The right side of the display indicates whether the variable tone alarm is either *on* or *off*.
6. The bottom line of the display indicates which function key (**F1-F4**) is used to turn the two alarms *on* or *off*.



Fixed Alarm

If you change to another probe with a different full scale measurement range, the alarm threshold will also change. A setting that is often used with shaped frequency response probes is 50% of Standard. To set the alarm for one of the 8722 series probes, which have full scale measurement ranges of 300% of standard, calculate the threshold setting by dividing the desired alarm level by the full scale value. In this case $50/300 = 16.66\%$. Set the alarm threshold to 17% and the alarm threshold will be 51% of Standard when using a 8722 series probe.

1. Use **F1 (ON)** or **F2 (OFF)** to change the status of the fixed alarm.
2. Use the numeric key pad to enter a two-digit alarm threshold number. This number is equal to the percent of full scale of the measurement range of the probe in use. For example, to set the meter to sound its alarm at 5 mW/cm² when using a Model 8721D probe, which has a full scale measurement range of 20 mW/cm², set the alarm threshold to 25%.
3. If you want to turn the variable tone alarm *on* or *off* do that next. See *Variable Tone Alarm* on the following page.
4. When you are satisfied with all the alarm settings, press **ENTER** and the meter will return to the measurement screen.



Variable Tone Alarm



The fixed and variable tone alarms operate independently of each other. The meter can be set to have both alarms off, either one of the alarms on, or both alarms on. If both alarms are turned on, the variable tone rate will vary with the field strength unless the measured field strength exceeds the fixed alarm threshold. The alarm will then sound a continuous tone.

1. Use **F3 (ON)** or **F4 (OFF)** to change the status of the fixed alarm. The variable tone alarm constantly generates a series of tones that increase in frequency in direct proportion to field strength.
2. If you want to turn the fixed alarm *on* or *off*, do that next See *Fixed Alarm* on the previous page.
3. When you are satisfied with all the alarm settings, press **ENTER** and the meter will return to the measurement screen.

11

Using The RF Exposure Standards Feature

Application

The Model 8718B Meter is always set to reference a particular safety standard, regulation, or guidance.

The 8718B uses the referenced standard in two ways:

- The *Alternate Measurement Display Screen* displays additional information about the instantaneous measurement at a particular frequency. See *Alternate Measurement Display Screen* on page 20.
- Time-averaged measurements are made to conform to the referenced standard at the specified frequency.

Checking or Changing the Standard

To determine which standard the 8718B is currently set to reference ...

1. Access the menu system by pressing the function key that corresponds to the legend below **MENU** on the bottom line of the display.
2. Press number **8 (NEXT)** to select the *Second Menu Screen*.
3. Press number **6** to select **STNDS**.
4. A screen will appear that specifies the current standard. The specific level or tier will be specified for standards with more than a single tier.

Note

Many standards have more than one tier, i.e., IEEE C95.1-1999 establishes different Maximum Permissible Exposure (MPE) levels and averaging times for Controlled Environments and for Uncontrolled Environments.

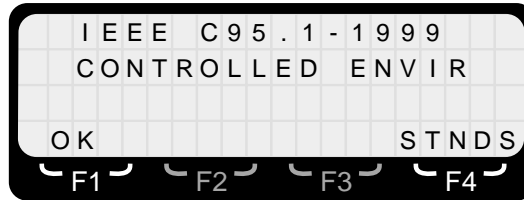

5. Press **F1 (OK)** to continue using this standard as a reference without change.

To change the standard or tier that the 8718B references...

6. Press **F4 (STNDS)**. A new menu screen will automatically appear that lists several major international standards.



7. Press the number on the keypad that matches the desired standard.

For standards with only a single tier...

8. A new screen will appear that lists the complete standard number.

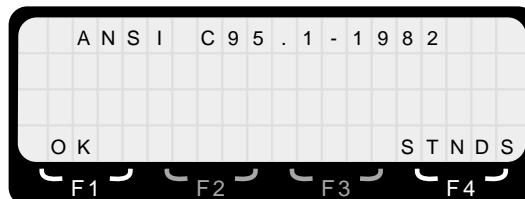

9. Press **F1 (OK)** to begin using this standard as a reference.
10. Alternately, press **F4 (STNDS)** to select another standard.

For standards with two or three tiers...

11. A new screen will appear that lists the complete standard number at the top of the display. The available tiers will be listed below the basic standard.



Changing the level referenced on a multi-tier standard does NOT change the characteristics of a probe ie. a probe rated at 600% of occupational limits always yields an output in Percent of the Occupational limits.

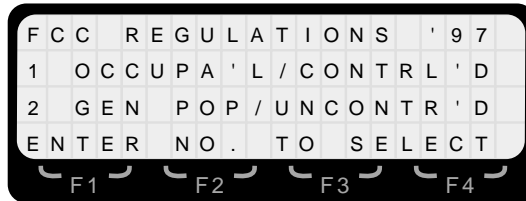

12. Press the number on the keypad that matches the desired tier. The screen will change so that only the standard and the selected tier are shown with two options available for the function keys.

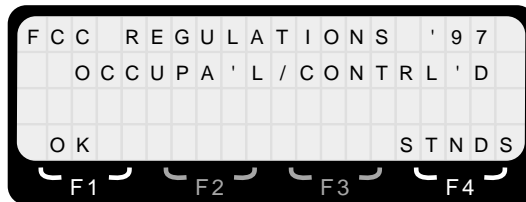

13. Press **F1 (OK)** to begin using this standard and tier as a reference.
14. Alternately, press **F4 (STNDS)** to select another standard.

12

Back Light and Battery Status

Application for Back Light

The liquid crystal display (LCD) on the Model 8718B Meter provides high contrast in bright outdoor light. However, LCD's do not generate any light and can be difficult to read in low light conditions. The LCD on the 8718B contains a high brightness back light that can be turned on whenever it is needed.

The only disadvantage to using the back light is that it consumes much more energy than the meter circuits and significantly reduces operating time between battery charges.

Controlling the Back Light

To turn the back light on or off...

1. Access the menu system by pressing the function key that corresponds to the legend below **MENU** on the bottom line of the display.
2. Press **4** to select **BAT/LITE** from the *First Menu Screen*. A new screen will appear that indicates both battery status and back light status.



3. Press **F3 (ON)** or **F4 (OFF)** to turn the back light *on* or *off* as required.
4. Press the **ESC** key to return to the *First Menu Screen*. Press it again to return to the measurements screen.

◆◆◆◆ **Battery Capacity**

The Model 8718B Meter uses a custom rechargeable battery. Under normal conditions, the battery provides about 20 hours of use before it must be recharged. The two features on the 8718B that significantly increase the current draw and therefore reduce the operating time are the back light and the RS232 serial port. It is for this reason that the default condition upon turn-on for both these features is *off*. Operating time with the back light on is about 6.5 hours. This is normally sufficient for a full day of measurements but it is a factor that must be considered.

◆◆◆◆ **Checking Battery Status**

To check the battery status...

1. Access the menu system by pressing the function key that corresponds to the legend below **MENU** on the bottom line of the display.
2. Press **4** to select **BAT/LITE** from the *First Menu Screen*. A new screen will appear that indicates both battery status and back light status.



3. The bar graph indicates the approximate charge level of the battery. The charge level is also shown as a numerical percentage on the left side of the third line of the display.

The estimated operating time *under the current operating conditions* is shown on the left side of the bottom line of the display. Turning the back light on, for example, reduces the operating time significantly.

4. Press the **ESC** key to return to the *First Menu Screen*. Press it again to return to the measurements screen.

◆◆◆◆ **Accuracy of Battery Status Indicator**

The characteristics of Ni-Cad rechargeable batteries make it difficult to provide a truly accurate indication of charge level. This is because there is very little voltage difference over a broad range of charge levels.

The battery status indicator on the 8718B is reasonably accurate when indicating charge levels of more than 80% or less than 20%. Unfortunately, indicated charge levels greater than 20% but less than 80% are only very rough estimates.

It is a characteristic of these batteries to get a large voltage increase with only a brief charging period if one starts with a battery that is completely discharged. However, under such conditions, the battery has very little capacity and the voltage drops quickly in use. Since the status indicator circuits measure battery voltage, this can lead to erroneous indications of charge level when the meter is first turned on. This false indication will only occur when the batteries do not receive a complete charge.

The battery should be charged for a minimum of eight hours, but ideally only when the status indicator shows a level of less than 20%. The back light can be turned on to speed up the discharge process when desired. These batteries obtain a maximum charge when charging takes place with batteries close to fully discharged.

13

Keypad Lockout and Display Blanking

Description

The *Lockout* feature disables the keypad to prevent inadvertent changes in operation. This feature can be useful while climbing and/or if the meter is left unattended during a long data logging session.

The *Blank* feature both disables the keypad and blanks the display. This feature can be useful if the meter is left unattended during a long data logging session.

Keypad Lockout

To lock the keypad...

1. Access the menu system by pressing the function key that corresponds to the legend below **MENU** on the bottom line of the display.
2. Press number **8 (NEXT)** to select the *Second Menu Screen*.
3. Press **4** to select **LOCKOUT**.
4. The meter will automatically return to the measurements screen and the keypad will be locked. Only the **Off** key will respond to commands individually.

To unlock the keypad...

5. Simultaneously depress both the **Enter** and **Esc** keys to unlock the keypad. These are the two dark blue keys.

◆◆◆◆ **Display Blanking and Keypad Lockout**

To both blank the display and lock the keypad...

1. Access the menu system by pressing the function key that corresponds to the legend below **MENU** on the bottom line of the display.
2. Press number **8 (NEXT)** to select the *Second Menu Screen*.
3. Press **7** to select **BLANK**.
4. The meter will automatically return to the measurements mode but will be blank. The keypad will also be locked. Only the **Off** key will respond to commands individually.

To both activate the display and unlock the keypad...

5. Simultaneously depress both the **Enter** and **Esc** keys to both activate the display and unlock the keypad. These are the two dark blue keys.

14 Probe Zero

◆◆◆◆ Understanding the Zero Function

The purpose of “zeroing” the probe and meter is to set the meter to indicate a zero field strength when there is no measurable field strength. The Narda 8700 series survey system maintains measurement accuracy under all conditions by insuring that all probes always provide true RMS (Root Mean Squared) indications of field strength. Diode detectors, which are used in many of Narda’s electric field probes, are always operated in the square law region. Since the diodes are not operated in a saturated mode to insure accuracy in multi-signal conditions, the survey system must be “zeroed”.

The Model 8718B establishes the zero reference as a small positive voltage inside the meter. This *zero offset* allows the use of only positive voltages while handling both positive and negative zero drift. While it is difficult to distinguish between a positive zero drift and the presence of an actual field, a negative indication on the meter must be due to zero drift. This is indicated on the display by a flashing negative sign between the field strength value and the unit of measure on the second line of the display.

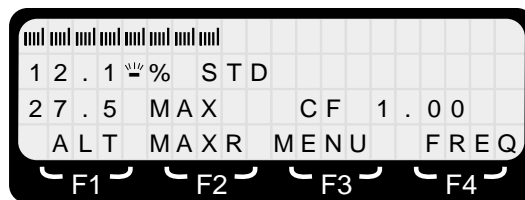

◆◆◆◆ Causes of Zero Drift

All sensors have a change in output that is a function of temperature. In a probe, it is both the thermal coefficient of the detector and the gain of the probe amplifier that determine how much a probe drifts over temperature. Thermal compensation circuitry in the probe is used to minimize the impact of temperature change. Thermocouple detectors have the lowest thermal coefficient but their very low level output requires much more amplifier gain than diode sensors, especially in electric field probes. Therefore, Narda probes with the greatest amount of thermal drift are the microwave- band electric field probes, which all use thermocouple sensors. The lower frequency electric field probes use diodes and require much less gain. Narda magnetic field probes use thermocouples but the circuit requires lower gain than the electric field probes.

The other possible cause of zero drift can occur when a probe is subjected to a very high field level and then is moved to an area with a very low field. The high field heats the sensor and can cause drift. However, this type of drift normally corrects itself within a few minutes.

Many competitive diode sensor probes exhibit drift for another reason - reaction to infrared light on the diodes. *Narda probes do not have this problem.* Narda uses special diodes with an integral light shield, photographic paper inside the probe cover, and a combination anti-static shield and blackout coating on the inside of the probe cover.

◆◆◆◆ Checking for Zero Drift

There are two indications that the probe may have drifted enough to require correction.

- Whenever the *negative zero drift* exceeds 0.1% of full scale of the probe, the words “**RE-AUTO-ZERO**” will flash on the top line of the display. This will replace the bar graph.

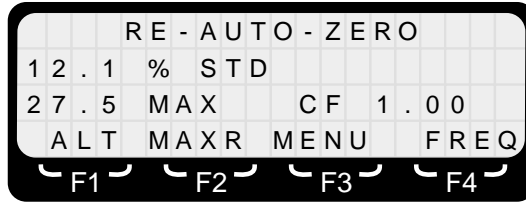

- Whenever the meter continues to show low-level values and never seems to get back to a zero-field condition, *positive zero drift is a possibility*. This can be confirmed by shielding the probe to see if the meter goes back to a zero reading. See *Shielding the Probe* on the following page for suggested methods.



Temperature Concerns

It is important to allow the meter and probe to become conditioned to the ambient temperature before attempting to zero the system. This is especially important when the meter and probe have been transported or stored at a different temperature such as in a vehicle, for example. Diode sensor-based probes require only a few minutes to stabilize. The thermo-couple sensors used in microwave band and ultra broadband probes may require 15-20 minutes to stabilize.



Establishing a Zero Field

It is important to “zero” the probe while the probe is not exposed to a significant RF field level. For accuracy, the field level should be lower than the lowest value that the probe is capable of reading. If previous measurements have indicated that the ambient field level is very low, the probe can be zeroed without shielding. This is often the case in a typical office environment. It is recommended that the ambient field level be at least 30 dB below the full scale measurement range of the probe. When it is necessary to zero a probe in higher field areas, the probe must be shielded.



Shielding the Probe

The probe must be shielded from significant RF fields whenever it is zeroed with the meter. This is to establish a zero reference for the field.

There are four ways to shield the probe during zeroing:



The Electric Field Attenuator can not be used to zero magnetic field probes.

- Use the Model 8713B Electric Field Attenuator supplied with the meter. This conductive fabric is the same material that is used in RF protective clothing. The attenuator should be put over the head of the probe and closed off around the neck of the probe above the handle using the hook-and-loop fastener band.
- Use the shielded storage case. Place the probe in the case and close the lid carefully on the cable with the meter outside the case. Be careful not to move the probe while zeroing takes place (On probes with low frequency test points you can create static which will give inaccurate results, although this is less of a concern with the new 8700D series probes).
- Use aluminum foil to shield the head of the probe. Fully wrap the head of the probe and close it around the neck of the probe about half way down. If the probe has metallic low frequency test points, these must be insulated from the aluminum foil. One way to do this is to use electrical tape to cover the test points. The other solution is to use a wide elastic band around the head of the probe over the test points. The elastic band can easily be moved to use the 8718B's built-in low frequency RF test source. Alternately, use an aluminum can.
- Use your body to shield the probe from the source of energy.



Zeroing the Probe While In Use

The meter and probe are initially zeroed before the meter is allowed to go into the measurement mode. If you determine that significant drift may have occurred, it is simple to fine tune the zero. See *Checking for Zero Drift* on page 82.

To zero the probe while in use...

1. Shield the probe using one of the methods described in *Shielding the Probe*.
2. Press the **Auto Zero** key. The meter will correct for any probe drift in about eight seconds. The meter will then automatically return to the measurements screen.

15 *Advanced Settings*

Description

The *Settings* menu is used to control several features of the Model 8718B that need to be accessed infrequently. The options available under the *Settings* menu are:

- Check or set the meter's internal clock (time/date).
- Enter a value for temperature. This feature is used *only* when the probe is separated from the meter and operating at a different ambient temperature.
- Clear the memory of logged data.
- Set the function keys for right or left handed operation.
- Adjust the contrast of the display.

Accessing the Settings Menu

To access the Settings menu...

1. Access the menu system by pressing the function key that corresponds to the legend below **MENU** on the bottom line of the display.
2. Press **8 (NEXT)** to select the *Second Menu Screen*.
3. Press **2** to select **SETTINGS**. A new screen will appear that offers five choices.



◆◆◆◆ Setting the Clock

To check and/or change the time and date...

1. Access the settings menu by following the procedure described in *Accessing the Settings Menu*.
2. Press **1** to select **CLOCK**. A new screen will appear that displays the time on the left side of the screen and the date on the right. The time is in 24 hour format, i.e. 13:30 equals 1:30 P.M. The date format is MM/DD/YY.

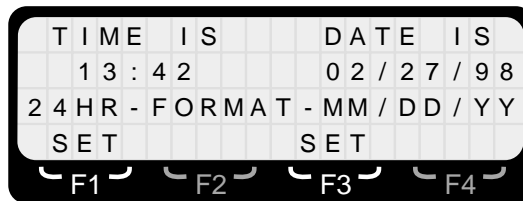

3. Press the **Esc** key to return to the *First Menu Screen* without making any changes.

To set the time...

1. Press **F1 (SET)**. The display will change to show four underscored lines where the new time must be entered.

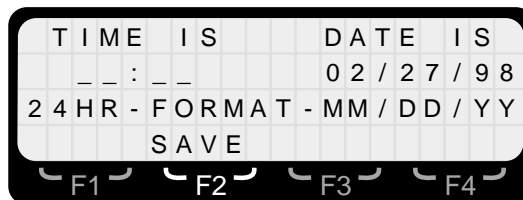

2. Enter the new time in 24-hour format using the numeric keypad. If you make a mistake, simply enter more numbers until the correct time has been entered.
3. Press **F2 (SAVE)** to save the new time.

4. Proceed to setting the date, if required.
5. Alternately, press the **Esc** key to return to the *First Menu Screen*. Press **Esc** again to return to the measurements screen.

To set the date...

1. Press **F3 (SET)**. The display will change to show six underscore lines where the new date must be entered.

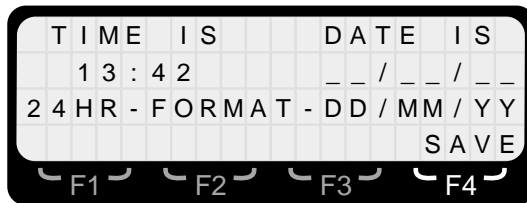

2. Enter the new date in DD/MM/YY format using the numeric keypad. If you make a mistake, simply enter more numbers until the correct time has been entered.
3. Press **F4 (SAVE)** to save the new time.
4. Proceed to setting the time, if required.
5. Alternately, press the **Esc** key to return to the *First Menu Screen*. Press **Esc** again to return to the measurements screen.

◆◆◆◆ **Temperature Correction**

This feature is *only used when the meter and probe are operating at significantly different ambient temperatures.*

This situation can occur when the meter is located indoors and the probe is outdoors. Either a probe extension cable or a fiber optic link system is normally used for such applications. Temperature correction circuitry is used in the probe and there is a temperature sensor located inside the meter. To achieve the highest level of accuracy, it is important that the sensor inside the meter sense the ambient temperature that the probe is subjected to. If the two components are operating in different ambient temperature environments, the 8718B can be set to

correct for the temperature differential. The amount of error that can occur when the meter and probe are operating at different temperatures depends on the particular probe design as well as the temperature differential. The maximum error that can occur is about 1% per degree Centigrade for diode probes and about 0.1% per degree Centigrade for thermocouple probes. The change may either increase or decrease the meter reading from the true value, depending on the probe model.

To correct for a significant temperature differential...

1. Access the settings menu by following the procedure described in *Accessing the Settings Menu*.
2. Press **2** to select **TEMP**. A new screen will appear that shows the current mode. The default mode is *Auto Correct*.

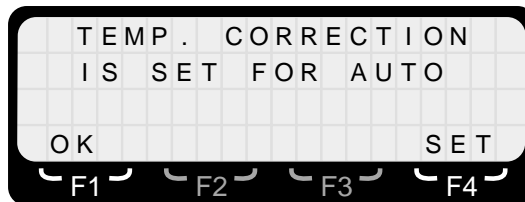

3. Press **F1 (OK)** to continue with the same setting without change.
4. Press **F4 (SET)** to either set or change to a specific probe temperature.
5. If the meter was set for a specific temperature and you want to return to the auto correct mode, press **F1 (AUTO)**.
6. A new screen will appear that shows two underscored lines where the probe ambient temperature should be entered. Use the numeric keypad to enter the temperature *of the probe* in degrees Centigrade.

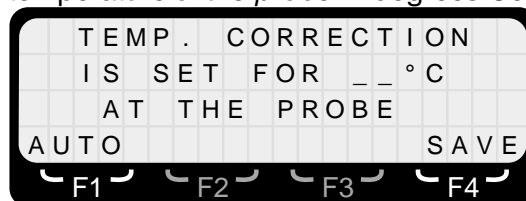

7. Once the correct probe temperature is displayed on the screen, press **F4 (SAVE)**. The meter will automatically return to the measurements screen.
8. Alternately, press **F1 (AUTO)** to return to the default auto correct mode.

◆◆◆◆ **Clearing the Memory**

If you determine that there is insufficient memory available to perform the desired logging task because much of the meter's memory has been used, it will be necessary to empty the memory. *All data will be lost when the memory is cleared.*

To download the current memory contents prior to clearing the memory you must connect the 8718B to your computer. See Chapter 18, *User's Software*.



All data will be lost when the memory is cleared.

To clear the memory...

1. Access the settings menu by following the procedure described in *Accessing the Settings Menu*.
2. Press **3 (CLEAR MEMORY)**. A screen will appear requesting that you confirm your request and warning that the stored information will be lost.

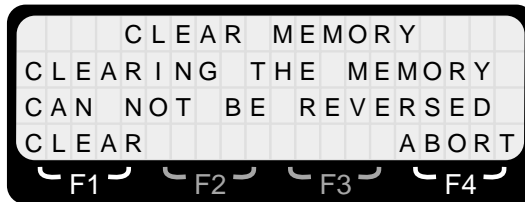

3. Press **F1 (CLEAR)** to clear the memory or **F4 (ABORT)** to return to the *First Menu Screen* without clearing the memory. Press **Esc** to return to the measurements screen.

◆◆◆◆ **Function Key Position**

The position of the commands for the function keys (**F1-F4**), as described in this guide, is for *right-hand operation*. Conventionally, right-handed people hold the probe in their right hand and the meter in their left hand. The choice of function key location for the **START** and **LOG** commands is particularly important because it is often desirable to press these keys without looking at the meter. This situation occurs during spatial averaging, data logging, and time averaging.

The four function keys on the Model 8718B allow for easy operation with your thumb and the raised area around each key makes it easy to be certain that your thumb is in the correct location. The **START** and **LOG** functions are always operated with the **F1** key for *right-hand operation*.

The 8718B allows you to change to *left-handed operation* with a few keystrokes. When set for *left-handed operation*, the **START** and **LOG** functions will be operated with the **F4** key. The functions normally associated with the **F4** key are then operated with the **F1** key. The meter will remain set the same way upon turn-on and can only be changed by following the procedure described below.

To check or change the function key location...

1. Access the settings menu by following the procedure described in *Accessing the Settings Menu*.
2. Press **4** to select **RGT/LEFT**. A new screen will appear that shows the current mode.

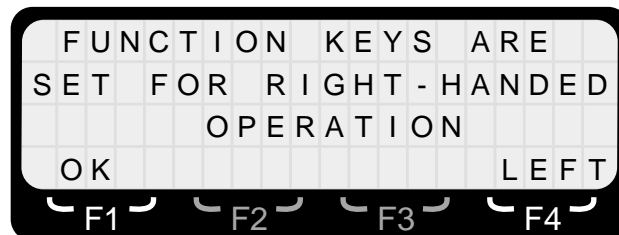

3. Press **F1 (OK)** to continue with the same setting without change. The meter will return to the *First Menu Screen*. Press **Esc** to return to the measurements screen.
4. Press **F4 (LEFT)** or **F4 (RG T)** to change to the alternate setting for function key menu position. The meter will return to the first menu screen. Press **Esc** to return to the measurements screen.

◆◆◆◆ **Adjusting the Display Contrast**

The LCD display is set at the factory for the best contrast under typical conditions. The user can adjust the contrast to optimize visibility under specific lighting conditions.

To adjust the display contrast...

1. Access the settings menu by following the procedure described in *Accessing the Settings Menu*.
2. Press **5** to select **DISPLAY**. A new screen will appear that shows the current setting. The adjustment range is from **0-9**, with **0** the lightest setting and **9** the darkest setting.



3. Press **F1 (OK)** to continue with the same setting without change. The meter will return to the *First Menu Screen*. Press **Esc** to return to the measurements screen.

4. Press **F4 (SET)** to change the display contrast setting. The screen will change to show both the current setting and display an underscore where the new setting is entered.



5. Use the numeric keypad to enter a single digit from **0-9** with **0** for the lightest setting and **9** the darkest setting. The contrast will change as soon as the numeric value is entered. You may continue to experiment as many times as needed by entering a new value.
6. When you are satisfied with the setting, press **F4 (SAVE)**. The meter will return to the *First Menu Screen*. Press **Esc** to return to the measurements screen.

16

Operation with a Fiber Optic Link

Description

Narda fiber optic link transmitters are compatible with all 8700 series probes and the Model 8718B meter. The meter has a built-in fiber optic receiver compatible with the HP Versatile Link type plastic cables and connectors. The fiber optic transmitter connects directly or via a short cable to the probe. A fiber optic cable connects the 8718B to the transmitter.

The transmitter contains a rechargeable battery that provides both power for its own circuitry and to operate the amplifier in the probe. Full system calibration is maintained because each of the components in the system – meter, fiber optic transmitter, and probe – are independently calibrated. The fiber optic transmitter converts the analog DC voltage out of the probe amplifier to a series of pulses. The pulse rate is directly proportional to the probe output.

Application

The fiber optic link provides total isolation between the meter and the probe which is often desirable when making low frequency measurements. At frequencies below 50 MHz, and especially below 10 MHz, there is significant interaction between the field, the individual making the measurements, and the survey equipment. There is also the possibility that the probe and meter will be at different electrical potentials which can result in a false indication of what is actually a scalar field. See *Low Frequency Measurements* in the Applications Booklet for additional information.

The fiber optic link system also allows the meter and probe to be separated by up to 50 meters. One application is surveying towers. A skilled climber carries the probe while the person actually making the measurements remains on the ground.

◆◆◆◆ **Controls and Indicators**

The fiber optic transmitter has the following controls and indicators:

Control	Function	Indication
S1	BAT Test	LED On ^a
	OFF	LED Off
	ON	LED Off
S2	CAL 1	Meter mid-scale
	NORM	Variable Level
	CAL 2	Above mid-scale

a. The battery is considered charged when above 15.0 Vdc.

◆◆◆◆ **Setting the Meter**

The meter has two input ports to receive information from probes:

- The standard probe cable input
- The fiber optic receiver input

Only one input can be in use at any time. The default input upon turn-on is the last input port used. It is important to remember this if you switch back and forth between using the standard input and the fiber optic receiver.

To set the meter to use the fiber optic receiver input...

1. Access the menu system by pressing the function key that corresponds to the legend below **MENU** on the bottom line of the display.
2. Press **8 (NEXT)** to select the *Second Menu Screen*.
3. Press **3** to select **CABLE/FO**. A new screen will appear that shows the current input status.

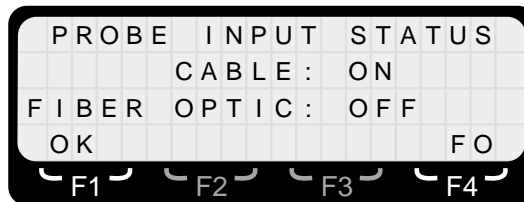

4. Press **F1 (OK)** to continue with the same input without change. The meter will return to the *First Menu Screen*. Press **Esc** to return to the measurements screen.
5. Press **F4 (FO)** to change to the fiber optic receiver input. The meter will return to the *First Menu Screen*. Press **Esc** to return to the measurements screen.

To set the meter to use the cable input...

6. Access the **CABLE/FO** menu as previously described. A screen will appear that shows the current input status.

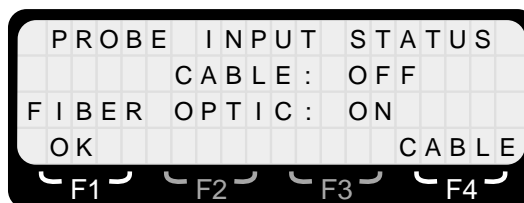

7. Press **F1 (OK)** to continue with the same input without change. The meter will return to the *First Menu Screen*. Press **Esc** to return to the measurements screen.

8. Press **F4 (CABLE)** to change to the cable input. The meter will return to the *First Menu Screen*. Press **Esc** to return to the measurements screen.

◆◆◆◆ **System Checks**

To insure that the entire system – meter, fiber optic transmitter, and probe – are functioning properly...

1. Set the 8718B to use the fiber optic receiver input as previously described.
2. Connect the probe to the fiber optic transmitter.
3. Connect a fiber optic cable between the meter and the fiber optic transmitter.
4. Check the battery charge level in the transmitter by turning switch S1 (**BATT TEST-ON**) to **BATT TEST**. Verify that the green LED is illuminated which signifies that the battery is adequately charged for operation. If the LED fails to illuminate, charge the transmitter overnight. A full-battery charge takes approximately 16 hours.
5. Set S1 to the **ON** position and S2 to the **NORM** position.
6. Zero the 8718B using the standard procedure.
7. Move S2 (**CAL1-NORM-CAL2**) to the **CAL1** position. The meter should read 45-55% of the full scale rating of the probe. The actual error from the combination of the 8718B and the fiber optic transmitter is less than ($\pm 3\%$).
8. Move S2 to the **CAL2** position. The meter should read approximately 25% higher than the **CAL1** position. The exact value is not critical.
9. Set S2 to the **NORM** position to begin making measurements providing that all the system checks were successfully completed.

17

Operation with a Data Recorder

◆◆◆◆ *Description*

The Model 8718B provides an output signal that can be connected to a data recorder to provide a continuous record of measurement over an extended period of time. The recorder output is available via the smaller of the two jacks located on the left side of the meter. The output is always on.

◆◆◆◆ *Output Level*

The recorder output ranges from 0.0 volts to 3.0 volts. The level corresponds directly with the indication on the bar graph of the display. Under normal conditions, the bar graph is in the AUTO mode which results in the bar graph using three 10 dB ranges to cover the entire dynamic range of the probe, which is typically 30 dB. Thus, the recorder output would produce a sawtooth pattern if the measured field strength was slowly increased in a linear fashion over the entire dynamic range of the probe. For example, the recorder output level with the 8718B bar graph range level set to AUTO used with a probe with a full-scale measurement range of 100 mW/cm, such as the Model 8723D, would follow the table on the next page.



The recorder output can be set to one of three fixed ranges by changing the bar graph range setting. See Bar Graph Ranges on page 23.

Field Strength	Recorder Voltage	Bar Graph
0.01 mW/cm ²	0.03 volts	1 % of Full Scale
0.50 mW/cm ²	1.50 volts	Half Scale
1.00 mW/cm ²	3.00 volts	Full Scale
1.01 mW/cm ²	0.03 volts	1% of Full Scale
5.0 mW/cm ²	1.50 volts	Half Scale
10.0 mW/cm ²	3.00 volts	Full Scale
10.1 mW/cm ²	0.03 volts	1% of Full Scale
50 mW/cm ²	1.50 volts	Half Scale
100 mW/cm ²	3.00 volts	Full Scale
> 100 mW/cm ²	4.2-4.5 volts	"RANGE OVERLOAD"

The recorder output has an approximate 1/4 second RC time constant.

18 *User's Software*

Description

The 8718B *User's Software* is a Windows™ - based program that performs three basic functions:

- Probe Calibration Data. The *User's Software* is used to enter probe calibration information into the memory of the Model 8718B.
- Data Retrieval. The *User's Software* is used to download data collected with the Model 8718B with one of its three data logging modes.
- Diagnostics and Upgrades. The *User's Software* is used to provide meter diagnostics and to load firmware updates into the meter.

The *User's Software* for the Model 8718B is supplied on a compact disk. It should be permanently installed on the hard drive of a personal computer.

System Requirements

In order to install and operate the *User's Software* successfully, your system must meet the following minimum requirements:

- An IBM or 100% compatible personal computer with 4 MB of RAM.
- 1 MB of hard drive space.
- Microsoft Windows™ 3.1, Windows™ 95, Windows™ 98, Windows™ NT or later.
- A printer supported by Microsoft Windows (required for printing reports).
- A CD ROM drive.
- A mouse.
- A cable to connect the computer to the 8718B (supplied).

◆◆◆◆ **Installing the User's Software**

To set up the program...

1. Turn on the computer and start Microsoft Windows (type **WIN**) at the DOS prompt if your computer doesn't start Windows automatically).
2. Insert the *User's Software* into your CD-ROM drive. The CD starts automatically and the 8718B-menu screen appears.
3. Follow the instructions that appear on your screen. The setup program places all of the program files in a directory on your hard drive called 8718B. A new program group called RF Safety will be created.

◆◆◆◆ **Starting and Exiting the 8718B User's Program**

To start the 8718B User's Program...

1. Click on **P**rograms from the **S**tart menu in Microsoft Windows.
2. Select the **8718B User's Software** icon. The *Main Menu Screen* appears.
3. Make sure you exit the **8718B User's Software** before turning off your computer by selecting Exit from the File menu. You can also double click on the Control-menu box. Do **NOT** use **Ctrl+Alt+Del** to exit the program.

◆◆◆◆ **Establishing Communications between the Meter and the Computer**

You must establish communications between the meter and the computer in order to enter, change, or view probe calibration information or to download data from the meter. You can only view stored logged data using your computer.

◆◆◆◆ **Main Menu Screen**

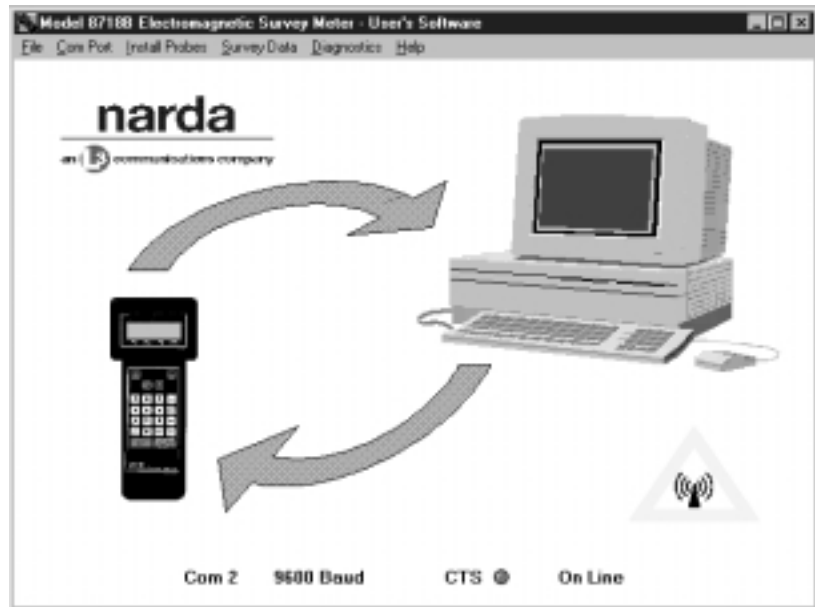

Note

The cable must be a RS232 serial cable with a DB9 male connector on one end and a DB9 female connector on the other end. Do NOT use a null modem cable since these are wired differently. Note that certain older model computers have a 25-pin connector for a serial port that will require either an adapter or a different cable.

Note

Operation of an older model 8718 meter that has been upgraded to Version 3.0 firmware is different. The default condition upon meter turn-on for the RS232 port is off (to conserve power). The RS232 port must be turned on from the meter menu.

To establish communications between the meter and the computer...

1. Use the supplied computer cable to connect between the RS232 connector on the meter and a **COM** port (**COM 1** or **COM 2**) of your computer.
2. Start the User's software. The *Main Menu Screen* shows the COM port and baud rate settings. Check that the COM port setting matches the location of the cable. Note the baud rate setting. The default setting is 9600 baud.
3. Change the baud rate and/or COM port if desired by selecting the **ComPort** pull down menu and selecting the desired rate and/or COM port.

The *User's Software* indicates the communications status. Prior to establishing communications, the **CTS (Clear To Send)** indicator will be black and the words "**Not On Line**" will be shown below the indicator.

4. Turn the Model 8718B on.
5. Once the meter has finished booting up, press **F4 (MENU)** on the meter to access the *First Menu Screen*.
6. Press **6 (RS232)** to select the communications port menu.
7. Check that the baud rate on the meter is set to the same as the *User's Software*. The meter setting will be the same as the last time the meter was used.
8. Check that the **CTS** indicator on the computer screen has turned red and the status has changed to "**On Line**".

Viewing or Changing Probe Calibration Data

The 8718B knows the basic parameters of all 8700 series probes i.e. frequency range, type of probe (electric or magnetic field), measurement range, and standard calibration frequencies. The term "installed" means that the meter has stored the calibration date and the correction factors for a specific probe. Narda installs probes that are shipped at the same time as the 8718B.

You can have a maximum of six probes installed at any time. Since the serial number of the probe is identified as well as the model number, more than one probe of the same model number may be installed at the same time.

To view or change probe calibration data in the meter's internal memory...

1. Establish communications between the meter and your computer as described in paragraph in ***Establishing Communications...***
2. Select **Install Probes** from the **Install Probes** menu. The 8718B will beep to indicate that stored probes information has been retrieved. The *Probe Installation Screen* will appear on the computer.

The table in the top left hand corner lists the probes by model and serial number that have been installed in your Model 8718B. A small box just below the table lists the total number of installed probes.

To simply view the details of any installed probe proceed to *Viewing Installed Probes* section. If you have less than six probes installed and want to install a probe you can proceed as described in *Installing a Probe*. If you already have six probes installed, you must first remove one or more probes to make room. Proceed to the *Removing Installed Probes* section.



Viewing Installed Probes

To view the information on a specific probe that has already been installed...

1. Go to the *Probe Installation Screen*.
2. Highlight the model and serial number of the probe that you want to view from the list in the **Installed Probes** box. The calibration information for that specific probe will appear.
3. To leave the **Probe Installation** window and return to the *Main Menu Screen* click the **Close** button.

Installing a Probe

Note

Probe Models 8782D and 8782 are unique low frequency electric field probes that feature a range switch on the probe to cover a total of 60 dB. The 8782 series probes must be entered as two separate probes since there are two different full-scale measurement ranges (dependent on the switch on the probe that the meter cannot control or know the status of) and each range has different calibration factors.

Note

A correction factor greater than 2.0 or less than 0.5 will not be accepted and will automatically be changed to one of these values. Narda probes never have a correction factor outside of this range for any frequency within their rated frequency range.

You may have a maximum of six probes installed in the 8718B at any time. If you have six probes installed and want to install another probe, you must first remove a probe. See *Removing Installed Probes*.

To add a probe to the meter's memory...

1. Click on the **New Probe** button. The **Select Below...** dialog box will appear.
2. Select the model number of the probe you want to install from the list of files by either double clicking on it or highlighting it and choosing OK. Each standard Narda 8700 series probe has a separate file that defines its basic characteristics. The file names are simply the model number of the probe preceded by the letter "p". The window will now show the model number of the probe selected, its basic characteristics - frequency range, full scale measurement range, field type, and response (flat or shaped) - and the standard calibration frequencies will be entered in the table on the right.
3. Enter the five-digit serial number in the highlighted box in the center of the window.
4. Enter the calibration date by highlighting the box to the right of legend **Enter Cal Date**. This date is shown on the handle of the probe. Hit the Tab key on the computer.
5. The **Calibration Due** date is automatically calculated as one year after the calibration date. Enter a different calibration date if you are using a different calibration cycle.
6. Enter the correction factor for each calibration frequency of the probe by highlighting the default value of 1.0. A default correction factor value of 1.0 (CF 1.0) is automatically entered in the table to minimize measurement error in case the user fails to enter a value.

◆◆◆◆ **Probe Installation Screen**

Model 87100 Probe Installation

Installed Probes

Probe#1	87610	SN	12153
Probe#2	87640	SN	23456
Probe#3	87410	SN	12151
Probe#4	87330	SN	12378
Probe#5	87210	SN	12152
Probe#6	A87220	SN	01015

of Installed Probes
Maximum - 6

Model # Enter S/N

Enter Cal Date month/day/year

Calibration Due month/day/year

Frequency Range: 300kHz to 50GHz

Frequency	Factor
0.30 MHz	1.07
3.00 MHz	1.01
10.00 MHz	0.89
30.00 MHz	0.70
0.10 GHz	1.11
0.30 GHz	0.70
0.75 GHz	1.31
1.00 GHz	1.42
1.80 GHz	1.40
2.45 GHz	0.87
4.00 GHz	1.05
8.20 GHz	1.02
10.00 GHz	0.85
18.00 GHz	1.11
26.50 GHz	1.15
40.00 GHz	1.13
45.50 GHz	1.18

Full Scale Factor: 300 ±5TD

Probe Type: E field

Response: Shaped Probe

7. Enter any special calibration frequencies on the extra lines provided and enter the appropriate calibration factors. Delete any standard calibration frequencies that were not used.
8. Click on the **Install Probe** button. A dialog box will appear asking you if you are sure you want to install the probe.
9. Click on **OK**. The program will automatically send the calibration information to the meter via the modem and cable. The program will then verify that the probe has been successfully installed in the meter by reading the meter's memory.
10. The model number and the serial number of the probe just installed will now appear in the table of **Installed Probes**.
11. To leave the **Probe Installation** window and return to the main menu click the **Close** button.



Removing Installed Probes

To remove a specific probe from the meter's memory...

1. First view an installed probe as described in *Viewing Installed Probes*.
2. Click on the **Remove Probe** button. A dialog box will appear asking you to confirm that you want to remove a probe from the meter's memory.
3. Click **OK**. The probe will automatically be removed from the meter's memory.
4. The model number and the serial number of the probe just removed will disappear from the table of **Installed Probes**.
5. To leave the **Probe Installation** window and return to the *Main Menu Window* click the **Close** button.

◆◆◆◆ *Downloading Logged Data from the Meter*

To download data from the meter...

1. Establish communications between the meter and your computer described in Establishing Communications....
2. Select **D**ownload New Survey from the Survey Data menu. A dialog box will appear that reminds you to make sure that the 8718B is in a menu and not in a measurement mode..
3. Click **OK**.
4. The message **Downloading, please wait...** will flash on the computer screen.
5. Once the data has been downloaded the **Downloading, please wait...** message will stop flashing and a dialog box will appear.

The dialog box specifies the file name that has been given to the downloaded data and its location on your hard drive. Make note of this information and click **OK**.

◆◆◆◆ *File Format for Survey Data*

Data files can have one of three forms identified by the suffix in the file name.

1. The file name will be an eight-digit number with a **.SVY** (survey) extension. The eight digits are derived from the time and date that you downloaded the data. The format is **MDDHHmm.SVY** (month, day, hour, and minute).
2. Exported files that have been converted to standard spreadsheet files have the same prefix as the original file with the suffix **csv**. These files are automatically stored in the subdirectory labeled **Ssdata**.
3. Exported files that have been converted to tab files (standard ASCII text files commonly used in data base programs) have the same prefix as the original file with the suffix **txt**. These files are automatically stored in the subdirectory labeled **Ssdata**.

Three sample files were loaded on your hard drive when installed the *User's Software*. There is a sample for each of the three modes of data logging.

◆◆◆◆ **Selecting a File to View**

To view stored surveys on your computer...

1. Select **View Stored Surveys** from the **Survey Data** menu. A dialog box will appear titled **Open Survey File**. Normal downloaded survey files stored on the computer's hard drive will be listed in the table on the left. Downloaded survey files are stored in a subdirectory labeled **Svy**. You can change drives, select which types of files are listed, or change directories from this box.
2. Select the data file you want to view from the list of files by either double clicking on it or highlighting it and choosing **OK**.
3. A new window labeled **Logged Survey Data** will appear. The file name will be shown to the right at the top of the window.

◆◆◆◆ **Logged Survey Data Window**

The Logged Survey Data window is comprised of two parts:

- 1) The header section at the top of the window defines the equipment that was used to make the survey.
 - a) The first line shows the meter model number, serial number, **Cal. Date**, and calibration **Due** date.
 - b) The model number, serial number, **Cal. Date**, and calibration **Due** date of the probe used are shown on the second line.
 - c) Line three identifies whether or not probe frequency correction (**PROBE CORRECTION**) was used during the survey. Probe correction can be in the form of a frequency that was entered or a numeric correction factor.

◆◆◆◆ **Logged Survey Data Screen**

Logged Survey Data - File: SAMPLE2.SVY

File Export View File

METER: 8718B S/N: 0804 Cal. Date: 01/18/00 Due: 01/18/01
 PROBE: A8722D S/N: 01015 Cal. Date: 01/28/00 Due: 01/28/01
 PROBE CORRECTION: Frequency: N/A Correction Factor: 1.00
 Run Ref. Number: 02 Record #2 of 2 Date: 02/01/00 Start Time: 16:23

Data Point #	Average % of STD	Max. % of STD
001	5.54	6.39
002	4.64	5.96
003	3.10	5.18
004	2.91	6.69
005	4.84	8.83
006	2.82	4.43
007	3.19	8.75
008	2.91	4.55
009	3.65	18.18
010	2.94	4.75
011	2.91	3.90
012	4.39	8.99
013	3.81	6.62
014	3.81	11.55
015	2.83	9.49
016	3.54	11.68

Spatial Average & Max.

Field Strength (% of STD) vs Data Point

Scroll Back Scroll Forward Increment or Decrement by: 1 Prev. Record Next Record Close

- d) The fourth line shows the **Run Ref. Number** that was entered by the user at the beginning of the survey, the **Record** number and total number of records in the file and the **Date** and **Start Time** when the first data point was taken.

2. The lower section of the window shows the measured data in both tabular and graphical form.

- a) The table on the left side of the screen displays up to eighteen (18) data points at one time. The **Data Point #** number will be a continuous sequence shown sequentially in the time the data points were taken. The **Field Strength** is shown in the unit-of-measure used during the survey. Mode 2 data (a series of spatially averaged data points) shows both the **Average** and **Max.** (or peak) value for every data point. Mode 3 data (continuous logging mode) shows the **Time** that each data point was taken
- b) The bar graph on the right side of the screen shows the same data listed in the table. The title of the bar graph is **Logged Data** for Mode 1 data, **Spatial Average & Max.** for Mode 2 data, and **Continuous Log** for Mode 3 data.
- c) The range of the vertical axis of the graph is automatically adjusted to accommodate the data. The number of data points will also vary depending on the data with a maximum of thirty (30) displayed at one time.
- d) The **Scroll Back and Scroll Forward** buttons are used when there are more than sixteen data points to view. Each time you click on one of these buttons you advance or go back by sixteen data points.
- e) The **New Record and Old Record** buttons allow you to go back and forth between different records within the same file. Each survey is a different record identified by the **Run Ref. Number** that was entered by the user at the beginning of the survey.



If you used the PAUSE feature during continuous logging, the time shown for each data point will be incorrect for all data points after the pause feature was used.

- f) The up and down keys to the right of **Increment or Decrement By** are used to determine how many records you advance or go back every time you click on the **Prev.** (previous) **Record** and **Next Record** buttons. The small window to the right of the arrows indicates the current setting.

To view another survey file...

1. Select **Load Survey File** from the **File** menu to close the current logged data window and view another logged data file. A dialog box will appear titled **Open Survey File**. Normal downloaded survey files stored on the computer's hard drive will be listed in the table on the left. Downloaded survey files are stored in a subdirectory labeled **Svy**. You can change drives, select which types of files are listed, or change directories from this box.
2. Select the data file you want to view from the list of files by either double clicking on it or highlighting it and choosing **OK**.
3. The new **Logged Survey Data** window will appear.

To return to the Main Menu Window...

1. To leave the **Logged Survey Data** window and return to the *Main Menu Window* click the **Close** button.



Printing a Logged Data Record

To print a copy of the Logged Survey Data window that you are viewing...

1. Select **Print Screen** from the **File** menu. The information will print automatically.
2. To print very large records with many data points it is suggested that you export the data and use another program.

◆◆◆◆ **Exporting Data**

To export a logged data file for use in a spreadsheet program...

1. Select **M**ake **S**preadsheet **(.csv) F**ile from the **E**xport menu. A dialog box will appear titled **M**ake **S**preadsheet **(.csv) F**ile. The file selected to be exported drive will be listed in the table on the left. The default directory for exported survey files is **S**sdata, which is a subdirectory under **8718B**. You can select any drive and directory to export your file from this dialog box.
2. Click **OK** to convert the file and store it in the selected location.

To export a logged data file for use in a word processor or text editor program...

1. Select **M**ake **T**ab **(.txt) F**ile from the **E**xport menu. A dialog box will appear titled **M**ake **T**ab **(.txt) F**ile. The file selected to be exported drive will be listed in the table on the left. The default directory for exported survey files is **S**sdata, which is a subdirectory under **8718B**. You can select any drive and directory to export your file from this dialog box.
2. Click **OK** to convert the file and store it in the selected location.

◆◆◆◆ **Clearing the Meter's Memory**

To clear the meter's memory of logged data with the User's Software...

1. Select **C**lear Survey Data from the **S**urvey Data menu. A dialog box will appear titled Clear Survey Data. It will ask to confirm that you want to clear the survey data from the meter's memory.
2. Click **OK** to clear the meter's memory of logged data.
3. If you make a mistake and want to restore the meter's memory, Select **R**estore Survey Data from the **S**urvey

Data menu. A dialog box will appear titled **Restore Survey Data**. It will ask to confirm that you want to clear the survey data from the meter's memory.

4. Click **OK** to restore the last survey data to the meter's memory.

To clear the meter's memory of logged data using the meter's menu system...

1. Select **2 (SETTINGS)** from the *Second Menu Screen*.
2. Press **3 (CLEAR MEMORY)**. A screen will appear requesting that you confirm your request and warning that the stored information will be lost.
3. Press **F1 (CLEAR)** to clear the memory or **F4 (ABORT)** to return to the *First Menu Screen* without clearing the meter's memory.

◆◆◆◆ ***Diagnostics***

The password-protected **Diagnostics** menu of the *User's Software* can be used if you experience a problem with your 8718B. Narda may be able to troubleshoot the problem using the built-in diagnostic tools of the *User's Software*. Contact Narda if you believe the meter is not functioning properly.

◆◆◆◆ ***Update Meter Firmware***

A powerful feature of the Model 8718B is the ability to update its operating software, or firmware, in the field. The password-protected **Update Meter Firmware** menu of the *User's Software* is used to update the firmware. Narda may periodically offer new firmware to correct problems and/or to add new features.

The update process uses the meter's memory to temporarily store files during the update process. *All logged data will be lost. Therefore, it is very important to download any data that you want to save prior to updating the firmware.*

To update the meter's firmware ...

Note

Download any data that you want to save prior to upgrading the firmware. All stored data will be lost during the update process.

Note

Do not interrupt the update process. If the process is interrupted the firmware file may become corrupted. The meter will be inoperative and will have to be returned to Narda for repair.

1. Turn your meter on. Observe the firmware version number, which is displayed briefly about three seconds after you turn the meter on. The meter can be updated if the firmware version is 3.0 or higher. Stop if the firmware version is lower than 3.0 – these meters cannot be updated in the field.
2. Establish communications between the meter and your computer as described in **Establishing Communications...** It is very important that you make good connections at both ends of the cable used to connect the meter to your computer.
3. Since stored data will be overwritten during the update process, download any survey data that you want to save by following the directions described under **Downloading Logged Data from the Meter.**
4. Select **Update Meter Firmware** from the **Update Meter Firmware** menu.
5. Read the directions and click **OK** to continue or click **Cancel** to abort the update process.
6. Enter the password obtained from Narda and click **OK.**
7. Read the description of the three meter models. Click **Yes** to update a Model 8718B meter. Click **No** if your meter is a previously updated Model 8718 unit that currently has firmware version 3.0 or higher. Click **Cancel** if the meter is a Model 8718 that has a firmware version lower than 3.0. These meters cannot be updated in the field.
8. The update process begins when you click either **Yes** or **No** as described above. *Do not interrupt the update process.*
9. You should get a message box that the firmware has been updated in about three minutes (at the recommended 9600 baud rate). Click **OK.**
10. You can now use your updated meter.



Communications with a Computer

Application

The Model 8718B can be connected to a computer for real time transmission of data via the meter's RS232 connector. A limited number of the meter's functions can also be controlled remotely via the RS232 bus.

Checksum and Modulo Description

Modulo 256 is the remainder of any number X divided by 256. As an example, if the checksum is 1234, Modulo 256 of 1234 is 210. The two ASCII digits to be transmitted as the checksum would be D and 2 (the decimal-hex conversion of 210). An equivalent calculation is to convert the sum to Hex and transmit the two lowest digits. The Hex of 1234 is 4D2, therefore the digits to transmit are ASCII D and 2.

Computer to Model 8718B Message Format

The first character in any message is the ">". This allows the Model 8718B to synchronize to the computer. Upon detection of the ">" character, the 8718B will:

- Set itself to a listen mode, thereby eliminating the possibility of a bus contention problem.
- Reset its character counter to allow storage of succeeding characters in an internal buffer.

The next character(s) is selected from the functions listed in Command Character Function table.

Command Characters	Function
>A000CSCR	AUTO ZERO
>C000CSCR	READ CLOCK (TIME DATE)
>Dr00CSCR	Display averaging change r=1, 2, 3, 4 low to high display averaging
>E003XXXCSCR	SET CF (Correction Factor)
>F0r4XXXCSCR	SET FREQ X is DATA, r is kHz, MHz, GHz r=0=kHz, r=1=MHz, r=2=GHz
>H000CSCR	SEND HEADER (24 bytes of data)
>P000CSCR	DUMP PROBE DATA (432 bytes of data)
>L000CSCR	DUMP LOG DATA
>V000CSCR	READ displayed VALUE Last displayed value (6 bytes) + units (6 bytes)
>X000CSCR	READ MAX

Command Characters	Function
I. Communications Protocol	
A) Ground Rules	
1) CS= two digit checksum (2 ASCII (Hex) characters)	
NOTE: The ">" is NOT included in the checksum calculation	
2) CR= one digit carriage return (13 or \$0D)	
3) x= data	
4) r= range	
5) >=ASCII ">" (\$3E)	
B) General send format:	
1) > cmd letter 0 0 # of digits in data data CS CR	
2) All characters are sent and received as capital letters, don't send lower case letters unless one is specifically requested.	
3) Checksum (CS) is always sent or received as a hexadecimal value, e.g., "A7", "BC", "2E", etc.	
4) Data is always sent or received as a decimal value.	

Command Characters**Function**

II To Change or initiate the following:

	SEND	RESPONSE
A)	Auto Zero >A000CSCR ASCII >A000D1CR Hex 3E 41 30 30 30 44 31 0D	ACR ACR 41 0D
B)	Read Clock >C000CSCR ASCII >C000D3CR Hex 3E 43 30 30 30 44 33 0D (Where: S= seconds in BCD format M= minutes in BCD format H= hours in BCD format X= N/A D= day of month in BCD format N= month in BCD format Y= year (00-99) in BCD format CS= two byte checksum CR= carriage return)	SMHXDNYCSCR
C)	Correction Factor >E003xxxCSCR Example: to set CF to 1.53, xxx=153 ASCII >E00315371CR Hex 3E 45 30 30 33 31 35 33 37 31 0D	ACR
D)	Frequency >F0r4xxxxCSCR r=0 for kHz, 1 for MHz or 2 for GHz Note: r is in binary, not ASCII Hex Example: to set frequency for 27.12 MHz ASCII >F0142712A7CR 3 Hex 3E 46 30 01 34 32 37 31 32 41 37 0D	ACR
E)	Clear All Survey Data >M000CSCR ASCII >M000DDCR Hex 3E 4D 30 30 30 44 44 0D	ACR
F)	Read Field Strength >V000CSCR ASCII >V000E6CR Hex 3E 56 30 30 30 45 36 0D	x...xCSCR

Response format 12 data bytes (6 data, 6 units) + CSCR.
[Last displayed value (6 characters) + units of last displayed value (6 characters) exactly as displayed, except squared and cubed symbols.]

Note: Superscript 2 or 3 are Hex 80 or Hex 81, respectively.
Response Example: ASCII ".0631 mW/cm² 58"
Hex 2E 30 36 33 31 20 60 57 2F 63 6D 80 35 42 0D

Command Characters**Function**

		SEND	RESPONSE
G)	Read Max	>X000CSCR	xxxxxxCSCR
	ASCII	>X000E8CR	(6 data characters returned
	Hex	3E 58 30 30 30 45 38 0D	exactly as displayed)
H)	Reset Max	>Y000CSCR	ACR
	ASCII	>Y000E9CR	
	Hex	3E 59 30 30 30 45 39 0D	
I)	Display Averaging	>Dr00CSCR	ACR
		r=l for minimum to 4 for maximum display averaging	
		Example: to set minimum display averaging (4:1)	
	ASCII	>D100D5CR	
	Hex	3E 44 31 30 30 44 35 0D	
J)	Read Calibrated		
	Probe Data	>P000CSCR	x..xCSCR
	ASCII	>P000EOCR	(432 data bytes returned)
	Hex	3E 50 30 30 30 45 30 0D	
K)	Read Log Data	>L000CSCR	x..xCSCR
	ASCII	>L000DCCR	(depends on size of log)
	Hex	3E 4C 30 30 30 44 43 0D	
L)	Read Header		
	(setup data)	>H000CSCR	x..xCSCR
	ASCII	>H000DSCR	(24 data bytes sent, use
	Hex	3E 48 30 30 30 44 38 0D	definition table to decode bits)



Theory of Operation

Overall Functional Description

The meter is a portable, battery-operated instrument that forms a complete RF Radiation Survey System when used with an interconnected Narda 8700 Series probe. Optionally, the system may employ a fiber optic transmitter and cable between the probe and meter. The survey system is designed to detect electromagnetic fields and to display the field level on the meter's Liquid Crystal Display (LCD). The probe detects the electromagnetic radiation and transmits a DC signal to the meter. The meter processes the signal from the probe for viewing on the LCD screen. The meter displays the field levels in various units of measure dependent on the field component detected and the characteristics of the probe used.

Probe Functional Description

The probe senses the electromagnetic fields and develops a signal for transmission to the meter. The probe has an isotropic sensing pattern so that the radiation may be sensed from any direction, except through the handle. Detectors in the probe sense the electromagnetic radiation present and apply signals to preamplifiers U1 and/or U2 located within the probe. Preamplifiers U1 and U2 amplify the signals from the detectors and route them to the meter via connector P1.

Model 8718B Meter Functional Description

The meter receives the signal(s) from the probe, processes the signal(s) and provides a visual display of the levels detected. The signal(s) received from the probe at PROBE connector J1 is routed to amplifier U2. Amplifier U2 amplifies the signal(s) from the probe and generates a signal to drive the A/D converter U3. The output of the A/D converter is routed to microprocessor U5 that drives the LCD.

The meter also contains built-in self-testing facilities for checking the condition of the batteries, the operation of the probe and for zero adjustment of the probe.

The meter provides a means for automatically zero adjusting the meter and probe. When in an operating mode and the probe is in a zero field, the operator presses the **Auto Zero** key to begin the auto zeroing routine. The 8718B meter uses a unique digital method to set the zero reference.

The meter provides a means of testing whether the probe is operational using built-in test signal sources. The test is used to prove that the probe is operational by generating upscale indications on the Model 8718B meter.

(a) **High Frequency Test Source.** A 10.5 GHz (nominal) oscillator and waveguide aperture for illuminating the probe. Power output is capable of producing an upscale indication on the meter of approximately 0.75 mW/cm² (± 3 dB).

(b) **Low Frequency Test Source.** An external test point provides a 10 kHz (nominal) signal at the unit and test points on the probe to excite each low frequency element and produce an upscale indication on the meter. The amount of deflection will vary depending on the model probe being used.

When the **Test Source** key is depressed, U5 (and part of U1) and Q1A within the meter generate test signals that are sensed by the probe, causing the level displayed on the LCD to move upscale. If no change in reading is observed, either the probe or the meter may be defective. The test source automatically shuts off after twenty seconds. The test must be performed with the meter in the correct location relative to the meter.



Model 8718B Meter Circuits

The 8718B is comprised of five main assemblies: printed circuit boards (PCB) A1 and A2, keypad S1, LCD display D1 and the battery pack B1. This section provides an overview of the 8718B circuits. There are no adjustable components (i.e., potentiometers or variable resistors) used within the 8718B.

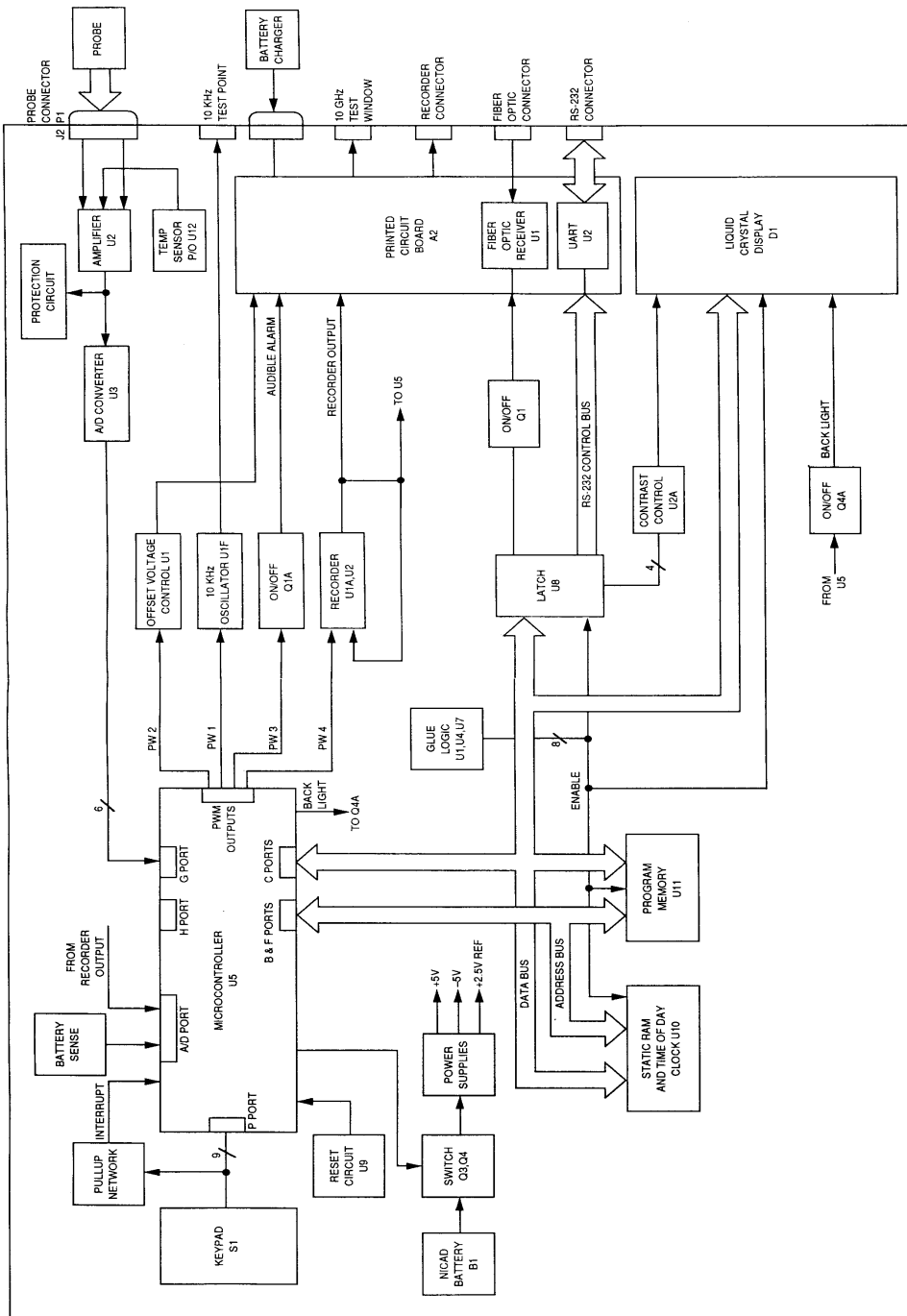

Model 8718B Functional Block Diagram

Calibration is performed using the RS-232 port, a voltage source and a computer.

PCB A1

PCB A1 is the primary circuit board within the meter. The majority of the components are surface mount. It is located in a heavily shielded area beneath the keypad. Operating power from battery B1 is routed through Q3 and Q4 that form a momentary switch for the micro controller U5. U5 provides a control signal to the +5V, -5V and +2.5V power supplies made up of U12, U13 and U14. The DC voltage output (two voltages if a ultra-broadband probe with a two channel amplifier is used) from the field sensing probe is coupled through the A2 PCB into an input amplifier made up of U2 and then input into the Analog to Digital converter U3. U3's digital output is applied to the micro controller U5. The on-board data bus is used to drive the LCD display. The data bus interfaced with latch U8, static Random Access Memory (RAM) and Time-of-Day U10 and the program memory U11. The LCD module receives input from the data bus, along with a contrast control input from U8 through U2A, R2 and R21. The LCD back light control is provided from P/O Q4, which is controlled by U5. The address bus circuit is made up of U5, U10, U11 and the glue logic circuit comprised of U4, U7 and parts of U1, U6 and U4. The circuit provides RS-232 interfacing through U8, which also controls A2U2, the RS-232 UART. The 10 GHz test source is controlled by U8 in conjunction with Q2 and Q3A. Micro controller U5 also provides Pulse Width modulated (PWM) signals that are used by the 8718. The 10 kHz source control is provided by U5's PWM along with U1. A PWM line and Q1 drive the audible alarm circuit. A PWM line and U1 and U2 also control the Recorder Output.

PCB A2

This small circuit board primarily handles input/output (I/O) functions for the meter. It is located in a shielded area behind the probe connector. A2 contains the RS232 circuit and interfaces with the charger jack, the recorder output jack, the probe and fiber optic inputs, and the high frequency test source. A2 connects to A1 via a filtered connector mounted on A1.

LCD Display D1

The LCD is a self-contained display and meter circuit assembly. The display has four lines with twenty characters per line. Each character is a 5 x 7 dot matrix. The display is backlit for improved visibility under low light conditions. It connects directly to PCB A1.

Keypad S1

The keypad has 22 keys. It is shielded in aluminum and connects directly to PCB A1.

Battery B1

The battery pack is a custom package consisting of six individual NiCd cells. It has a rated output of 7.2 volts with a capacity of 7.2 Ah. The battery pack contains an over current protection device. It connects directly to PCB A1.



Probe Designs

The probes used with the Model 8718B meter measure either the electric field or the magnetic field. Some have a flat frequency response, others have a shaped frequency response (see Chapter 3, *Probe Selection*). All 8700 series probes have square law characteristics that provide an accurate summation of field levels present from multiple frequency sources. All probes are internally coated with a thin film, high resistive coating. The film is on the order of 0.5 M per square inch and provides a shield against electrostatic charges. All 8700 series probes utilize a preamplifier in the handle to amplify the detected signals from the sensors. This eliminates probe-to-meter cable modulation. The probe amplifiers are connected to the probe elements by inflexible monolithic resistive leads. This prevents cable modulation from affecting the signal derived from the elements. Each instrumentation amplifier consists of three distinct sections: two analog and one digital.

Communications Band Electric Field Probes

The 876xD series probes operate from 300 kHz to 3 GHz. They use three sensors supported along mutually orthogonal axes. Each sensor consists of a dipole-diode combination. The dipoles are approximately 8 cm in length. The broad beam width is achieved through the capacitive divider effect of the dipole-diode combination. Some linearity correction is provided for field levels that approach full scale. A patented circuit design maintains RMS detection over the entire dynamic range of the probe.

Microwave Band Electric Field Probes

The 872xD series probes operate from 300 MHz to >50 GHz. They contain resistive thermocouples distributed along the length of the dipole. The spacing prevents resonance over the operating frequency range of the probes. The dipole may be viewed as a group of series connected small resistive dipoles or as a very low Q resonant circuit. Element sensitivity decreases with frequency. At frequencies above 12 GHz the dipole begins to align along the Poynting Vector with the cold junctions oriented tangential to the electric field. This is the traveling wave mode of operation.

Each of the three mutually orthogonal elements contains four resistive dipoles with the cold junctions oriented at right angles. This provides for the independence of probe orientation relative to the polarization of the field.

Ultra-broadband Electric Field Probes

These probes operate from 300 kHz to 50 GHz. Two distinct sets of isotropic sensors are used to cover this very broad bandwidth. The output from each set of detectors is processed separately by separate amplifier circuits in the probe handle. The two signals are summed within the 8718B meter. Models include the Model 8741D that has a flat frequency response and the x8722D series that have shaped frequency response characteristics.

In the lower frequency region below 1500 MHz, a dipole with diode detector and both distributed and discrete components are used. Three orthogonally mounted conductive dipoles, each terminated in diode detector, form the low frequency detection circuit. These diode detectors are operated in their square law region. This region is defined as that in which the DC diode current is proportional to the square of electric field tangential to the dipole. The elements that are used in the higher frequency region are thin-film thermocouples. They provide true square law output and function in two modes. Between 1.5 and 12 GHz, they are resistive dipoles. As a resistive dipole, each probe contains three mutually perpendicular elements. Above 12 GHz, it utilizes the phase delay of a traveling wave to produce additional output. In this mode, the dipole is aligned along the Poynting Vector with the cold junctions oriented tangential to the electric field. Each of the three mutually orthogonal elements contains four resistive dipoles with the cold junctions oriented at right angles.

This provides for the independence of probe orientation relative to the polarization of the field. The instantaneous charge distribution on adjacent cold junction elements produces a potential difference across the thin-film resistive thermocouples and a resultant dissipation of energy in these films. As the frequency increases, the phase difference between the potentials developed in adjacent junctions also increases the open circuit voltage.

Low Frequency Electric Field Probes

The Model 8764D operates from 100 kHz to 300 MHz. It contains three orthogonal displacement energy sensors with diode detectors. This unique design has much lower impedance than traditional dipole designs. The major advantage is the greatly reduced interaction between the meter and probe, the human body making the measurements, and the RF field.

The Model 8782D uses an “active antenna” design to accurately measure RF fields as low as 3 kHz over a 60dB dynamic range.

Low Frequency Magnetic Field Probes

These probes are responsive to the H-Field component. Each of the three mutually perpendicular coils in every probe has a diameter of 3.5 inches (8.9 cm), consists of multiple turns and is series-resonated somewhat below the low frequency end of the band. The RF current induced by the “H” field dissipates power in the thermocouple elements, heats the hot junctions and provides a DC output voltage proportional to the square of the induced current. Circuitry is added to minimize high frequency out-of-band responses typical in many H-field probe designs.



Maintenance

◆◆◆◆ ***General***

The Model 8718B requires very little maintenance. No operator adjustments are required. The electronic circuitry is contained in a very rugged aluminum housing. However, this housing is not watertight and should not be immersed in water. The LCD display and the case may be cleaned using a damp cloth. Do not use any type of detergent or solvent.

◆◆◆◆ ***Calibration***

The Model 8718B is calibrated before it is shipped. Narda recommends that the Model 8718B be calibrated every two years. Narda will perform this calibration for a nominal charge. The meter is completely tested using Automated Test Equipment (ATE) as part of the calibration service.









◆◆◆◆ ***Replacement Parts***

None of the parts within the meter are considered user serviceable. The table below contains the model numbers and part numbers of the accessories supplied with the 8718B and available as optional accessories.

Description	Model or Part Number	Comments
Battery Charger, 115 volt	84156000	
Battery Charger, 230 volt	84156001	
Power Cord	89707000 to 89707008	Supplied with 230 volt charger only, see table for outline
Storage Case	32542703	
Probe Extension Cable	87744-04	
Electric Field Attenuator	8713B	
Computer Cable	87239000	
User's Software	990125	CD ROM
User's Guide	42983600	
Insulated Tripod/Handle	21797900	Optional Accessory
Tripod Adapter	32595900	Optional Accessory

◆◆◆◆ **Battery Charger and Line Cord Options**

The Model 8718B contains a rechargeable battery. The meter is supplied with either a 115-volt 50/60 Hz or a 230-volt 50/60 Hz charger. The 115-volt charger plugs directly into the style of wall outlets common to North America. The 230-volt charger has an IEC receptacle and is supplied with any one of nine different power cords that meet virtually all international requirements. The table on page 117 identifies the power cord by its outline.

OUTLINE	MAJOR USE COUNTRIES	PART NUMBER
	Continental Europe	89707000
	Australia & New Zealand	89707001
	U.K. & Ireland	89707002
	Denmark	89707003
	India	89707004
	Israel	89707005
	Italy	89707006
	U.S., Canada & Japan	89707007
	Switzerland	89707008

◆◆◆◆ **Rechargeable Battery Management Program**

The Model 8718B contains a rechargeable nickel-cadmium battery that must be recycled or disposed of in compliance with applicable federal, state, or local environmental regulations.

Narda maintains a rechargeable battery management program in keeping with its highly proactive policy on environmental protection and conservation of natural resources. This service is available to our customers at no charge. At the end of this product's effective life cycle, it may be returned to Narda for proper disposal.

INDEX

Audio Alarm		Fiber Optic Link, operation with	
Alarm Description	4, 67	Application	95
Controlling Alarm Function	67	Controls and Indicators	95
Fixed Alarm	68	Setting the Meter	96
Variable Tone Alarm	69	System Checks	98
Back Light	75	Keypad	
Bar Graph	23	Function Keys	6
Battery		Numeric Keypad	6
Accuracy of		Power Keys	7
Battery Status Indicator	77	Special Function Keys	7
Battery Capacity	76	Keypad Lockout	79
Charger, description	3, 130	Maintenance	
Charger, line cord options	3, 131	Calibration	129
Checking Battery Status	76	Battery Charger and	
Rechargeable		Line Cord Options	130
Management Program	131	Rechargeable Battery Program	131
Clock	88	Replacement Parts	129
Communications with Computer	117	Measurements	
Correction Factors	24	Getting Started	13
Data Logging		Entering a Probe Model	14
Format for Logged Data	44	Making a Measurement	28
Memory Capacity	54	Precautions	28
Mode 1 Logging	46	Uncertainty	27
Mode 2 Logging	48	Memory	91
Mode 3 Logging	51	Menu System	
Options	43	Commands	32
Data Recorder, operation with		Default Conditions	34
Description	5, 56, 99	First Menu Screen	30
Output Level	99	Second Menu Screen	31
Display Blanking	80	Probe Selection	
Display Screens, measurement		Changing the Probe Model	27
Alternate	20	Connecting a Probe	4, 11
Main	19	Entering a Probe Model	14
		Identifying a Probe	12
		Key Factors in Selecting a Probe	9
		Shaped Frequency	
		Response Probes	10

INDEX

Probe Test			
Sources	4		
Testing the Probe	23		
Probe Zero			
Causes of Zero Drift	82		
Checking for Zero Drift	82		
Establishing a Zero Field	83		
Shielding the Probe	84		
Temperature Concerns	83		
Understanding the Zero Function	81		
Zeroing the Probe, in use	85		
Zeroing the Probe, initial	17		
Spatially-Averaged Measurements			
Spatial Averaging with the 8718B	40		
Understanding Spatial Averaging	39		
Standards Feature	71		
Time-Averaged Measurements			
Making Time-Averaged Measurements	57		
Measurement Options	57		
Mode 1 Averaging	58		
Mode 2 Averaging	61		
Tripod	5		
Units of Measure			
Available Units of Measure	37		
Changing the Unit of Measure	38		
Settings, Advanced			
Clock, setting the	88		
Display Contrast, adjusting	93		
Function Keys, right or left handed	92		
Memory, clearing the	91		
Menu, accessing the	87		
Temperature Correction	89		
Theory of Operation			
Meter, functional description	121		
Meter Circuits	122		
Probe Designs	125		
Probe, functional description	121		
User's Guide	1, 2		
User's Software			
Description	101		
Data Window, logged survey	110		
Downloading Data from the Meter	109		
Diagnostics, meter	115		
Establishing Communications	102		
Exporting Data	114		
File Format for Survey Data	109		
Firmware Update	115		
Installing a Probe	106		
Installing the Software	102		
Memory, clearing the meter	114		
Printing a Logged Data Record	113		
Probe Data,			
viewing or changing	104,105		
Removing a Probe	108		
Selecting a File to View	110		
Starting and Exiting the Program	102		
System Requirements	101		
Zeroing the Probe			
See Probe Zero	17, 81-85		

Warranty

Narda Safety Test Solutions (Narda STS) warrants each product of its manufacture to be free from any defect in material and workmanship for a period of one year from date of shipment to, and return by, the original purchaser. All warranty returns, however, must first be authorized by a factory office representative.

The limit of liability under this warranty shall be to repair or replace any product, or part thereof, which proves to be defective after inspection by Narda STS. This warranty shall not apply to any Narda STS product that has been disassembled, modified, physically or electrically damaged, or any product that has been subjected to conditions exceeding the applicable specifications or ratings.

Narda STS shall not be liable for any direct or consequential injury, loss or damage incurred through the use, or the inability to use, any Narda STS product.

Narda STS reserves the right to make design changes to any Narda STS product without incurring any obligation to make the same changes to previously purchased units.

This warranty is the full extent of obligation and liability assumed by Narda STS with respect to any and all Narda STS products. Narda STS neither makes, nor authorizes any person to make, any other guarantee or warranty concerning Narda STS products.



USA: 435 Moreland Road
Hauppauge, NY 11788
Tel 1-631 231-1700 **Fax** 1-631 231-1711
E-Mail NardaSTS@L-3COM.com
www.narda-sts.com

GERMANY: Sandwiesenstrasse 7
D-72793 Pfullingen
Tel +49-7121-9732-777 **Fax** +49-7121-9732-790
E-Mail support@narda-sts.de
www.narda-sts.de

Free Manuals Download Website

<http://myh66.com>

<http://usermanuals.us>

<http://www.somanuals.com>

<http://www.4manuals.cc>

<http://www.manual-lib.com>

<http://www.404manual.com>

<http://www.luxmanual.com>

<http://aubethermostatmanual.com>

Golf course search by state

<http://golfingnear.com>

Email search by domain

<http://emailbydomain.com>

Auto manuals search

<http://auto.somanuals.com>

TV manuals search

<http://tv.somanuals.com>