



## **L130, L230 and L300 Ethernet Virtual Desktops with vSpace™**



## **User Manual**

## Important Notices

Please note that reproduction of this User Guide in whole or in part, without express written permission from NComputing, is not permitted.

NComputing reserves the right to make improvements and/or changes to this User Guide and to the products, programs and/or specifications described herein at anytime without notice. Information contained in this document may have been obtained from internal testing or from a third party. NComputing shall not be liable for any direct, indirect, special, incidental or consequential damages in connection with the use of this material. The latest version of this User Guide can be downloaded from the “Documentation” page in the support section of the NComputing website at: [www.ncomputing.com](http://www.ncomputing.com)

Refer to the Limited Hardware Warranty applicable to your region for information on what is and what is not covered by the warranty, your responsibilities, exclusions, and how to obtain service. It is your responsibility to download a copy of the warranty at the time of purchase to keep for your records. The warranty can be downloaded from the “Documentation” page in the support section of the NComputing website.

Please refer to the End User License Agreement (EULA) and Terms of Use (TOU) that are presented for your review during the software installation process. The information contained in these documents is very important. The EULA and TOU constitute agreements between you and NComputing and are accepted by you by installing and using the product. It is your responsibility to print a copy of the EULA and TOU directly from the installer in order to keep for your records.

This product gives users shared access to computer resources. It is not a computer, and may not support all software applications, especially high-resolution graphics applications or 3D games that are designed to be supported by stand-alone computers. Similarly, it may not support all hardware peripherals that are designed to be supported by stand-alone computers.

Refer to your computer operating system and application software vendors’ license agreements for information on using these products with NComputing systems. Additional software licenses may be required.

Microsoft® Windows® Licenses. You are licensed by NComputing to use the vSpace software under the terms of the EULA. You must also acquire the appropriate number of Windows Server licenses and Client Access Licenses for each device or user accessing Windows Server software. You cannot use the vSpace software with Windows Client software (i.e., Windows Vista, Windows 7) unless a single user and no other user accesses the same Windows Client software at any one time, or you are authorized to do so under an applicable license from Microsoft or as expressly set forth in the “Microsoft Windows Server to Windows XP License Rights” section of the NComputing EULA. In all cases, your rights and obligations with respect to the use of vSpace software with Windows Server software and Windows Client software are defined by both the NComputing vSpace software EULA and the applicable Microsoft Software License Agreement or EULA. For more information on licensing with Microsoft operating systems see: [www.ncomputing.com/mslicensing](http://www.ncomputing.com/mslicensing)

For single user applications of your L-series product such as remote control, digital signage and 1:1 VDI refer to the same web page for information on client operating systems currently supported.

The NComputing hardware and software products described in this user manual are protected by numerous granted and pending U.S. and international patents.

© 2003-2010 NComputing Inc. All rights reserved. NComputing, vSpace, and Numo are registered trademarks of NComputing Inc. – USA. Microsoft, Windows, Windows Media, and DirectShow are registered trademarks of Microsoft Corporation. Intel, Core 2, Core i5, and Core i7 are registered trademarks of Intel Corporation. KCC is a trademark of KCC Corporation. Matroska is a trademark of CoreCodec, Inc. VESA is a trademark of Video Electronics Standards Association. Kensington is a trademark of ACCO World Corporation. QuickTime is a registered trademark of Apple, Inc. DivX is a registered trademark of DivX, Inc. Youtube is a registered trademark of Google. Adobe and Adobe Flash are registered trademarks of Adobe Systems, Inc. All trademarks are the property of their respective owners.

## TABLE OF CONTENTS

Safety Information	4
Regulatory Compliance	4
Product Overview	6
Installation	8
vSpace software installation	8
L300 Device Setup	12
Product Registration	14
Online Registration	14
Offline Registration	16
Add Additional vSpace License	18
Completing the Offline Registration Process	18
Updating the vSpace Software	19
Uninstallation	19
Using Your L-series Access Device	20
L130/L230 Access Devices	20
L300 Access Devices	25
L300 Multimedia Acceleration	32
Using the vSpace Management Console	32
Software Settings (local)	37
Software Settings (LAN)	43
Hardware Settings (LAN/local)	44
Troubleshooting error messages	47
Glossary	50
FAQ	52

## Safety Information

Refer to the following to prevent any physical injury or loss of assets caused by damage to the product.

A user must read this User Manual carefully before use and properly follow the instructions.

- Make sure that the place of installation is not too hot (above 35°C), too cold (below 0°C), or too wet (above 85% relative humidity).
- Avoid any severe impacts to the product
- Make sure that the product is not exposed to direct sunlight or any hot machinery.
- Please keep the product away from any items which have strong magnetic properties.
- Do not disassemble, repair or rebuild the product.
- Please properly route all cables and power cords to avoid a tripping hazard. An electric shock, fire, damage to the product or physical injury may occur as a result of tripping over the cable.

## Regulatory Compliance

### FCC Information

This equipment has been tested and found to comply with the limits for a class B digital device, pursuant to part 15 of the FCC Rules.

These limits are designed to provide reasonable protection against harmful interference in a residential installation. This equipment generates, uses, and can radiate radio frequency energy, and if not installed and used in accordance with the instructions, may cause harmful interference to radio communications. However, there is no guarantee that interference will not occur in a particular installation. If this equipment does cause harmful interference to radio or television reception, which can be determined by turning the equipment off and on, the user is encouraged to try and correct the interference by one or the following measures:

- Reorient or relocate the receiving antenna
- Increase the separation between the equipment and the receiver
- Connect the equipment to a power outlet on a circuit different from which the receiver is connected
- Consult your dealer or an experienced radio TV technician for help

Changes or modifications not expressly approved by the party responsible for compliance could void the user's authority to operate the equipment.

This device complies with part 15 of the FCC Rules.  
Operation is subject to the following two conditions:

- (1) This device may not cause harmful interference, and
- (2) This device must accept any interference received, including interference that may cause undesired operation.



전자과적합등록 (EMC Registration)



NCC-L300 (B)

- 기기의 명칭(모델명) : Network virtual desktop (L300)
- 인증 번호 : NCC-L300 (B)
- 인증 받은 자의 상호 : 엔컴퓨팅 주식회사
- 제조자/제조국가 : 엔컴퓨팅 주식회사/한국
- 제조년월 : 제품 뒷면 참고



NCC-L230 (B)

- 기기의 명칭(모델명) : Multi-User Computing Access Device (L230)
- 인증 번호 : NCC-L230 (B)
- 인증 받은 자의 상호 : 엔컴퓨팅 주식회사
- 제조자/제조국가 : 엔컴퓨팅 주식회사/한국
- 제조년월 : 제품 뒷면 참고



NCC-L130 (B)

- 기기의 명칭(모델명) : Multi-User Computing Access Device (L130)
- 인증 번호 : NCC-L130 (B)
- 인증 받은 자의 상호 : 엔컴퓨팅 주식회사
- 제조자/제조국가 : 엔컴퓨팅 주식회사/한국
- 제조년월 : 제품 뒷면 참고

이 기기는 가정용으로 전자파 적합 등록을 한 기기로서 주거지역에서는 물론 모든 지역에서 사용할 수 있습니다.

European Community:



Disposal Information:



This symbol means that according to local laws and regulations your product should be disposed of separately from household waste. The separate recycling of your product will help ensure that it is recycled in a manner that protects human health and the environment.

## Product Overview

The NComputing L-series access devices with vSpace™ desktop virtualization software dramatically cut your computing costs by enabling up to 30 users to share a single PC, server or virtual machine. Each user gets their own virtual desktop with a rich, multimedia computing experience that is practically indistinguishable from running on a full PC. Best of all, IT staff and end users do not need special training because this end-to-end solution is easy to manage and is compatible with standard desktop applications.



## Product Comparison

This user manual covers three distinct L-series products: L130, L230 and L300. The entry-level L130 provides all of the basic features needed for a good virtual desktop experience, complete with keyboard, mouse, monitor and speaker connections. The L230 adds a USB port for connecting storage devices, a microphone port, and more color depth for an even better user experience. The L300 delivers the best possible virtual desktop experience with the addition of a high-performance video acceleration system that supports full screen motion video, higher screen resolutions and more USB peripheral ports. The following table summarizes the key differences between the products in the L-series family.

	L130	L230	L300
Maximum Screen Resolution (Wide)	1440x900	1440x900	1920x1080
Maximum Screen Resolution (Standard)	1280x1024	1280x1024	1680x1050
Maximum Color Depth	16-bit	24-bit	24-bit
Mouse & Keyboard Ports	PS/2	PS/2	USB 1.1
Speaker Port	Yes	Yes	Yes
Microphone Port	No	Yes	Yes
USB Peripheral Ports	None	1 x USB 1.1*	2 x USB 2.0*
Video acceleration for full-screen video support	No	No	Yes

\*NComputing L-series access devices use remote USB 1.1 or 2.0 to provide transparent USB redirection.

### System Requirements

The minimum recommended system specifications for a vSpace installation can be very minimal. The host PC may only need 1-2 GB of memory, a 2.4 GHz single-core processor, and less than 100 MB of free hard drive space to run a few users. However the number of users, intended application suite and overall performance expectation will ultimately determine how powerful a computer must be in order to deliver the desired multi-user experience.

**Note:** It is not advised to use a notebook PC as the host. Notebooks use power-saving features and technologies different than a typical desktop PC. This may cause power management and memory incompatibilities.

Minimum Host Hardware Configuration (L130 or L230)						
Host Configurations		Number of Users				
		1-3	4-7	8-10	10-20	20-30
Most Applications	CPU* (minimum or Equivalent)	2.4 GHz or Dual Core	3.0 GHz or Dual Core	Dual Core	Fast Dual Core	Fast Dual or Quad Core
	Host Memory	1-2 GB	2 GB	3 GB	3-4 GB	4 GB

\* CPU recommendations are for Pentium class of processor or newer

The table below gives recommended specifications for a vSpace host computer, based on number of users and the type of applications used. NComputing recommends you test your environment in advance of deployment to ensure it meets your expectations.

Recommended Host Hardware Configuration (L300)						
Host Configurations		Number of Users*				
		1-3	4-7	8-10	10-20	20-30
Productivity Applications	CPU** (minimum or Equivalent)	Core™ 2	Core 2	Core 2	Core i5	Core i7
	Host Memory	2 GB	3 GB	3 GB	4 GB	4 GB
Multimedia Applications	CPU** (minimum or Equivalent)	Core 2	Core i5	Core i7	Core i7	Core i7
	Host Memory	2 GB	3 GB	3 GB	4 GB	4 GB

\* For the L-Series access terminal, the maximum number of users is 30. The number of users a customer's installation will support depends upon the host's configuration and performance expectations of the customer. Performance results are highly dependent upon the individual host hardware, memory, video card, applications being used, OS and network conditions within any LAN/WAN. Host requirements will vary, please test your multi-user environment before deployment. For more information on supporting multiple simultaneous multimedia streams see the document "Configuring an L300 Multiuser Environment".

\*\* CPU recommendations are generation of processor or equivalent

**Note:** This table is only a guideline; actual use may vary based on system utilization.

For Microsoft OS licensing information see the paragraph on page 2.

For each L-series device you will need:

- Keyboard and mouse (PS/2 for L130/L230 or USB for L300)
- Monitor
- A category 5/6 network cable to connect to your existing Ethernet network
- Optional: speakers, headphones, microphones and USB peripherals

## Installation

### vSpace software installation

- Insert the software installation CD into the host computer's CD drive. In most cases, a window will automatically appear after a few seconds with installation options. If it does not appear, go to "My Computer," open the CD drive's icon, and start the "Setup" application.
- At the initial setup screen, click the "Download Latest Software" button. This will launch a browser window at the NComputing Software Download Center, Locate the correct software based on product model and operating system, and download the corresponding "zip" folder.
- (Note the current version of vSpace is always located at [www.ncomputing.com/downloads](http://www.ncomputing.com/downloads))
- If internet access is unavailable, click "Browse CD" to locate the installer file per the next step
- After downloading and extracting the installer files, or alternately locating them on the product CD, run the vSpace Installer MSI.
 

**Note:** If the MSI file is not present, instead run "setupnc.exe"
- At the installer's "Welcome" screen, click on the "Next" button.
- At the antivirus and firewall warning screen, read and follow the instructions, then click on the "Next" button.





**Note:** When dealing with certain firewall applications, you may need to make sure that the NComputing .exe files have proper access permission to the network. These .exe files include:

KMSERVC.EXE, BOOTSRV.EXE, KMMMSG.EXE, KMUPDATE.EXE, KMREGWIZ.EXE

Within the Exceptions tab of the Windows Firewall the ports that should be opened are:

TCP-Protocol: 27605, 27615, 3581, 3597, 3645, 3646, 3725

UDP-Protocol: 1027, 1283, 3581, 3725

Please see our Knowledge Base at <http://www.ncomputing.com/support.aspx> for more details.

- At the software End User License Agreement screen, please read the agreement. When you are finished, if you agree, click on the "I agree" checkbox, and then click on the "Next" button.
- At the software Terms of Use screen, please read the terms of use. When you are finished, if you agree, click on the "I agree" checkbox, and then click on the "Next" button.
- At the "Additional Options" screen, you may choose to install the Network Administrator Console, which expands vSpace's control capabilities, so that multiple host PCs may be administered from one location. If you choose to use an administrator password, enter it and retype it. Click on the "Next" button.

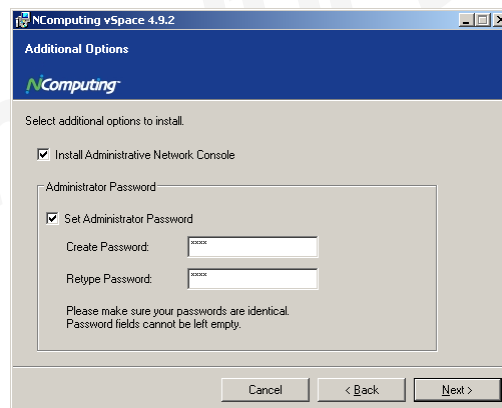

- At the "Choose destination location" screen, you can install to the default location, or you can choose a different location. When you are finished, click on the "Next" button.
- At the final "Confirm Installation" screen, click "Install" to begin the software installation. This process may take up to 5 minutes to complete, and it is normal for the system to beep frequently. The installer may appear to freeze or cause a lock-up, but if the mouse cursor regularly switches between the pointer and the hourglass, everything should be proceeding normally. If the installer takes longer than 15 minutes to complete, please contact NComputing technical support for assistance.
- At the "vSpace successfully installed" screen, click "Close" to end the installer, and select whether or not to immediately restart the computer (a restart is required before vSpace can be used).

**L130 and L230 Device Setup**  
 (For L300 devices, see next section)



**Before**



**After**

The access device must be connected via Ethernet to the host PC. This can be done using an Ethernet switch, a router, or some other network connection method.

**Network connection**

If the network is configured to use DHCP to get dynamic IP addresses, you can setup the access device to use it. Turn on the access devices and once you see the main screen select the "Options" button, and then select the "Setup" button.



In the "Network" tab, select whether to use a dynamic IP address or a static IP address.

If you choose to use a dynamic IP address, click on the "Save" button.

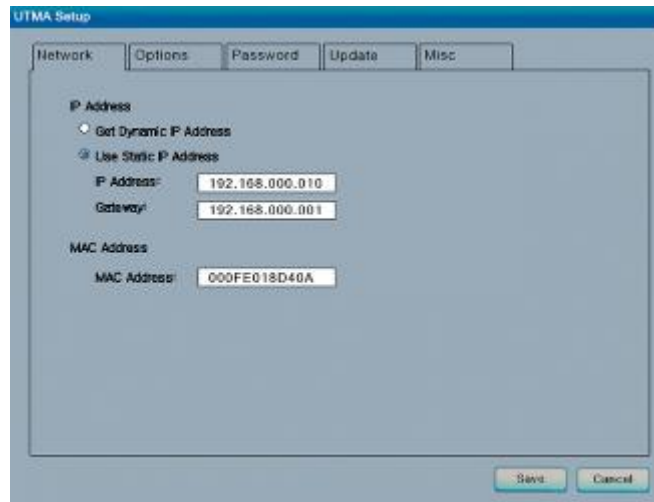

If you choose to use a static IP address, you must enter the IP address and the default gateway. Then click on the "Save" button.

### Installation with monitor mount

The L130 and L230 products include a monitor mount, mounting collar, monitor mount screws (silver color) and mounting collar screws (black color) for mounting it to the back of a monitor.

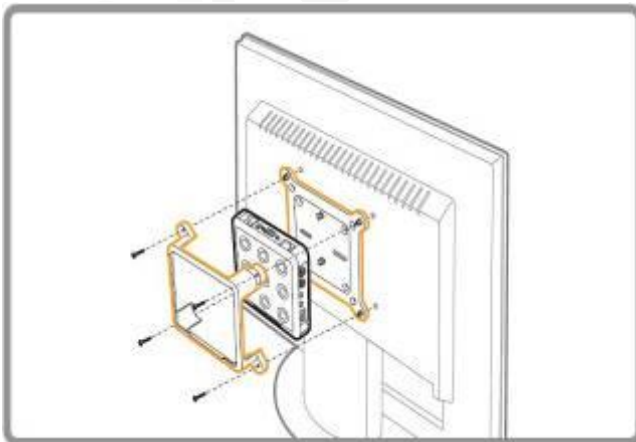

These pictures show the L230 mounting process, and the final product, fully mounted and ready for use.

## L300 Device Setup



The L300 must be connected to the host PC via an Ethernet switch, router, or other network connection. The L300 has USB ports dedicated for mice and keyboards, as indicated by the mouse and keyboard symbols below the horizontally oriented USB ports. The vertically oriented USB ports to the left of the audio connections are for other USB devices.

**NOTE:** The USB keyboard and mouse ports ONLY support these types of devices. No other types of USB devices are supported on these ports. The USB keyboard and USB mouse must be directly connected to these ports and cannot go through a separate USB hub. Peripherals with integrated USB hubs or combination keyboard/mouse devices are not supported by these ports. Other USB peripherals can be connected to the vertically oriented ports that are to the left of the audio ports – note that these generic ports are not active until you have connected to a vSpace session.

### Network connection

The L300 device can be configured to use DHCP-assigned network settings, or use settings specified by the user. To use DHCP-assigned settings, power on the device, then go into the Device Setup, click the “Network” tab, and select the bullet labeled “DHCP.”

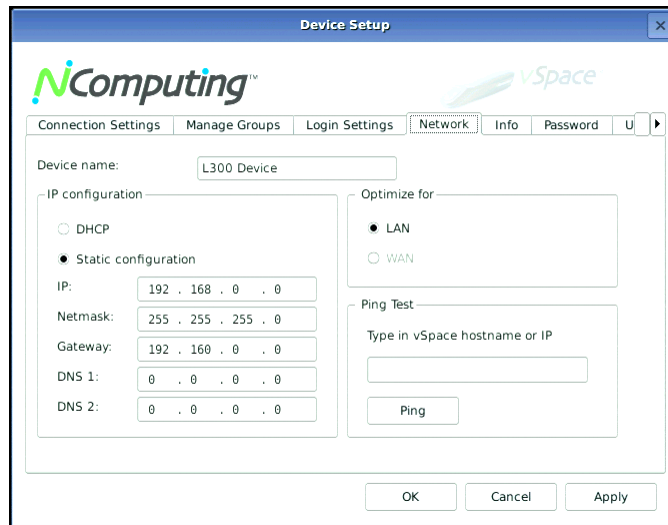

If static addressing configurations are used on the network, select “Static configuration” and supply the appropriate IP, Subnet Mask, Gateway, and DNS server (primary and alternate) information. Click “OK” to save changes and return to the Server Selection screen.

When your L300 device is connected to the network the “LNK” light (indicating Ethernet link) on the L300 front panel should be on and you should see that the Ethernet activity light, “ACT,” also blinks when there is active Ethernet traffic to/from the device.

### Installation with monitor mount

The L300 device comes with a mounting plate and two mounting screws, which can be secured to a monitor via 75mm or 100mm VESA™-compliant mounting holes. The L300 device then attaches to the mounting plate, resulting in a zero-footprint workstation. In general, we recommend using the top two mounting holes on the monitor to give maximum cable access space.



**Note:** The L300 product also comes with a Kensington™ security lock interface, for additional theft protection.

## Product Registration

### IMPORTANT NOTICE!

**DEVICE AND VSPACE SOFTWARE REGISTRATION ARE REQUIRED.**

**UNTIL YOU HAVE REGISTERED, SESSIONS WILL TIME OUT AND DISCONNECT AFTER 1 HOUR.**

**YOU HAVE 30 DAYS AFTER THE INITIAL INSTALLATION TO REGISTER. IF YOU DO NOT REGISTER WITHIN 30 DAYS, DEVICES WILL NOT BE ABLE TO CONNECT TO THE HOST. IF THE 30 DAY LIMIT IS REACHED YOU CAN STILL ACCESS THE REGISTRATION WIZARD ON THE HOST TO COMPLETE REGISTRATION.**



Product registration is required for all L-series devices and vSpace software to enable normal product use, downloading updates, and technical support. Prior to registering, sessions will time out after one hour and devices will not be able to connect after 30 days. When registering the software, all the access devices must be connected to the host PC using Ethernet.

Select "vSpace Registration" in the Windows Start menu.

At any time during the registration process, click on the "Cancel" button and the process will be cancelled, or use the "Back" button to return to previous screens in the registration process and modify entries.

- At the registration program "welcome" screen, if vSpace password protection is turned on, you will need to enter your password. Then click the "Next" button.
- Next, you are presented with the vSpace End User License Agreement (EULA). If you agree, click in the "I agree" check box, and then click the "Next" button.

## Online Registration

In the case of Online Registration, follow the instructions below. Otherwise skip to the section titled "Offline Registration."

- If you want to register your software and L-series access devices online, leave the "Register" radio button selected, and click "Next."



- At the "Customer Data" screen, if the data fields are not already populated, enter the registered user's relevant information. Each field in this window must be filled in. Once all data has been entered, click on the "Next" button.
- Select "Register online, using your internet connection" and click "Next."  
**Note:** If you use a Proxy Server for internet connectivity, enter the Proxy connection data here.
- The registration wizard will then show you a list of all unregistered L-series access devices that are currently connected to this vSpace host. You cannot select which devices will be registered – all devices shown in this list will be registered.
- Before the registration wizard communicates with the registration server, you will get the following "Summary" screen showing all user information that will be registered with the vSpace software. Also, any connected but unregistered L-series access devices will be listed for registration. If the data is correct, click on the "Register" button to initiate the registration or click "Back" if you wish to change any of the information.



- When your registration is complete, you see the "Registration results" screen. Be sure to click the check box for the "Register future L-series devices in the background" option, if you want vSpace to automatically register any unregistered L-series access devices that connect to this system in the future. Use of this "background registration" feature requires standard internet connectivity.



## Offline Registration

In the case of Offline Registration, follow the instructions below. If you have completed the online registration section, skip to “Using the access device”.

- If you don't have standard internet connectivity, you can use standard email to register your vSpace software and L-series access devices.
- To use offline registration, you again select the “Register” option, and click “Next.”



- At the "Customer Data" screen, if the data fields are not already populated, enter the registered user's relevant information. Each field in this window must be filled in. Once all data has been entered, click on the "Next" button.
- The registration wizard will then show you a list of all unregistered L-series access devices that are currently connected to this vSpace host. You cannot select which devices will be registered – all devices shown in this list will be registered.
- On the next screen you then select the “Create off line registration file” option and click “Next.”



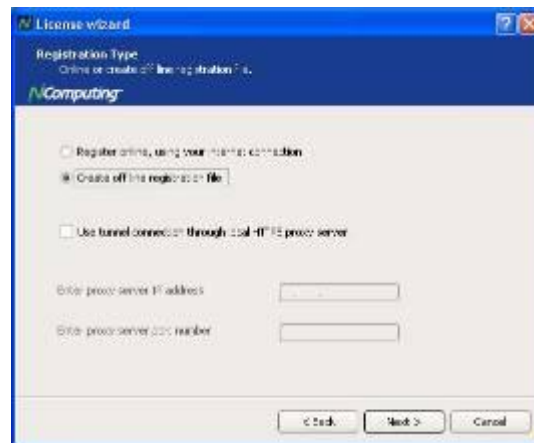

- You'll need to select the location where you wish to store the registration data file that you'll later email to NComputing. Note that you cannot type directly into the "Create activation file" field, but you must click on the "Select" button to navigate to the directory where you wish to store the offline registration data file.
- The window below shows the navigation screen that allows you to place the data file in the desired location. Feel free to change the "File name" to something other than "activation" – but don't change the "Save as type" field. The registration file must be of type "txt" – even though the data inside is encrypted and must not be modified.



- Before the registration wizard writes the data file, you will get a "Summary" screen showing all user information that will be written to the data file. Also, any connected but unregistered L-series access devices will be listed for registration.
- If the data is correct, click on the "Register" button or click "Back" if you wish to change any of the information.
- Next, email the created "txt" file to [registration@ncomputing.com](mailto:registration@ncomputing.com). Alternately, you can copy the "txt" file to another PC, if necessary, to send the email.

## Add Additional vSpace License

The second option on the “Type of Registration” screen is a feature reserved for future use in extending vSpace software capabilities by adding additional or optional vSpace licenses.

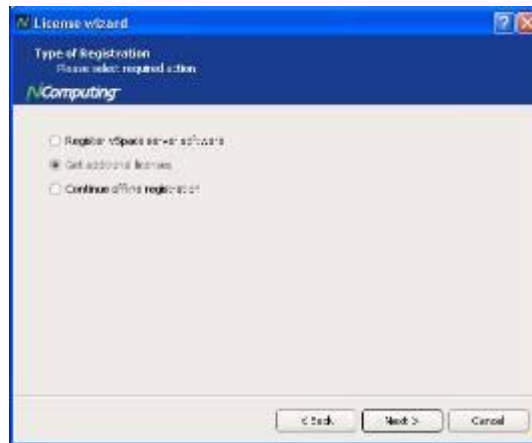

## Completing the Offline Registration Process

It should normally take only one or two minutes to receive the vSpace license file by returned e-mail.

When you receive the license file, save it in a convenient disk location, and restart the “Registration Wizard,”

Select the “Complete offline registration by using activation file” option and click “Next” and navigate to the disk directory where you have stored the returned license/activation file.

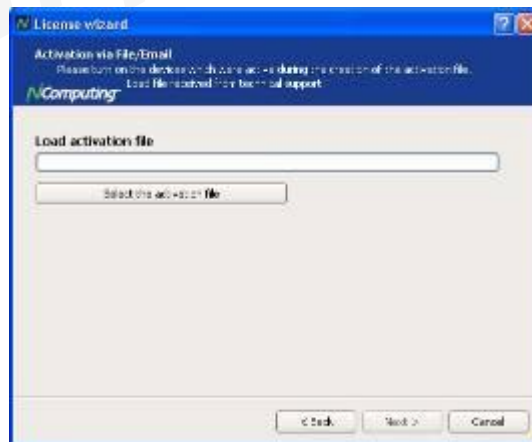

Click “Select” to do the navigation, and click “Open” once you have located the correct license file. Then click “Next” to load the license file and apply it to the vSpace host system.



After the offline file is loaded, you see the “Registration results” screen. Click the “Next” button to complete the offline registration process. Your devices are now registered and ready for continuous use.

## Updating the vSpace Software



Once you have successfully completed the registration process, you can update the vSpace software directly over the Internet by selecting “vSpace Update” from the Start Menu.

**Note:** If the “Enter Password” window appears, enter the vSpace administrator password you selected during vSpace installation.

Click the “Connect” button to check for a software update. If there is a new version available, click on the “Download” button to start the update process. If there is no new version available, click on the “Exit” button. When the download is complete, the installation of the new version will begin.

Alternately, the latest NComputing software can be obtained from <http://www.ncomputing.com/downloads>.

## Uninstallation

To uninstall the vSpace program, select “Uninstall vSpace” under the “NComputing vSpace” folder in the Start Menu (or select vSpace from the Add/Remove Programs utility in the Windows Control Panel). Follow the uninstall utility’s prompts to remove the program components. After the programs are uninstalled, you must restart the host PC to complete removal process.

## Using Your L-series Access Device

### L130/L230 Access Devices

(For L300 devices, see next section)

The available connection list shows the vSpace hosts to which the device can connect. Select a host from the list and click on the "Connect" button to start.

The "Refresh" button refreshes the available connection list.



### The Options Menu

The "Options" button brings up a menu where you can view and change the access device's settings.



Within the "Options" screen, the "Reset" button resets the access device

The "Info" button brings up a window to view the following information about the access device:

- Version: the version of firmware running on the access device
- Build: The build number of the firmware running on the access device
- Date: The date of the firmware running on the access device
- Device Model: The model number of the access device
- Loaded Schema Version: The schema version running on the access device
- IP Address: The IP address the access device is configured to use
- Gateway: The IP gateway the access device is configured to use
- MAC Address: The MAC address of the access device
- Serial Number: The serial number of the access device
- Alias: The alias of the access device, defined using the vSpace admin console

- "Loaded from . . .": How the access device loaded its latest firmware update.

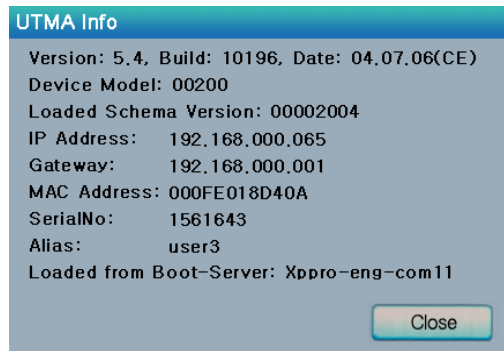

The "Close" button closes the options menu.

### The “Setup” Menu

Within the “Options” screen, the "Setup" button brings up a set of tabs for viewing and changing the access device settings. *Note that this is an optional step to be used for more control of the device.*

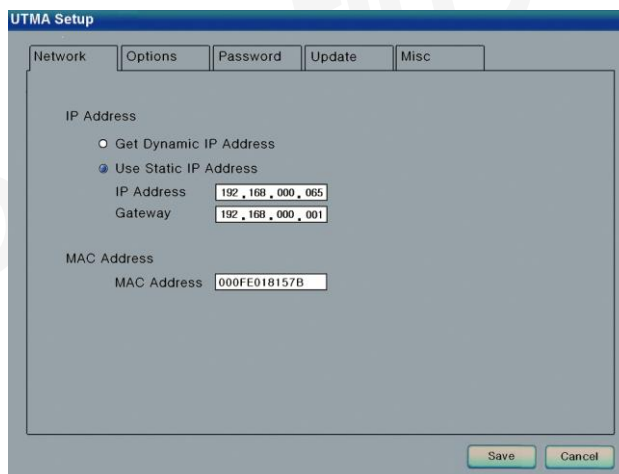

The "Save" button saves all the changes made in the tabs and closes the window. This brings the user back to the host PC list.

The "Cancel" button discards all the changes made in the tabs and closes the window. This brings the user back to the host PC list.

### The “Network” Tab

The "Network" tab contains settings for network connectivity.

If you plan to use a static IP configuration, click on the "Use Static IP Address" radio button to set an IP address and gateway address for the access device to use.

Otherwise, click on the "Get Dynamic IP Address" radio button to configure the access device to use DHCP to get its IP address. Note, the MAC address is shown here for reference only and cannot be edited.

## The "Options" Tab

The "Options" tab contains settings for host PC connections.

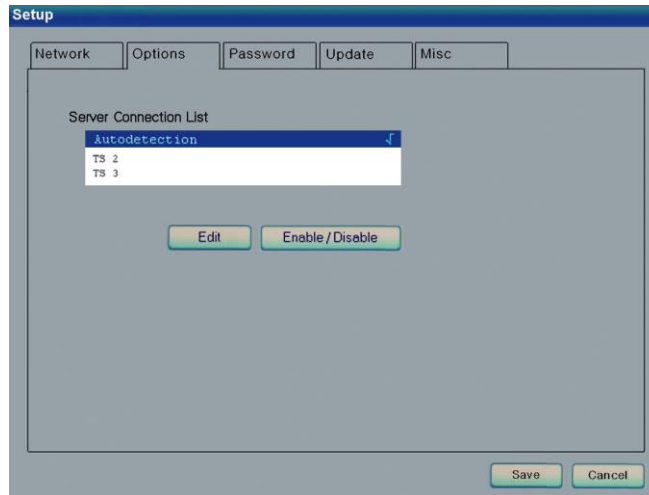

The "Server Connection List" is a list of three connection profiles. There is a check mark to the right of each profile that is enabled.

Select a profile and click on the "Edit" button to view and change its settings.

Select a profile and click on the "Enable/Disable" button to enable or disable the profile.

The first profile is called "Autodetection." Unlike the other profiles, its name can never be changed and it has no specified server network address.

The second and third profiles' default names are "TS 2" and "TS 3," respectively. You can change these profile's names and they have a "Server Network Address" field where you set a host PC IP address.

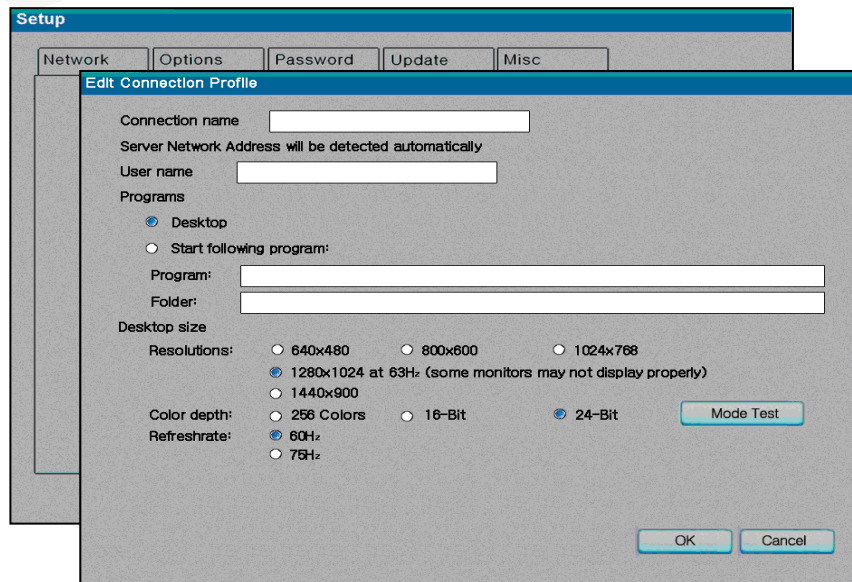

In each profile, there are the following settings:

- The “Autoconnect Enabled” radio button, when activated, sets the access device to automatically connect to the selected server when the device is turned on.
- In the “User name” field, you can enter the user name that you want to be entered into the Windows login dialog box upon access device connection.
- In the “Domain” field (only accessible from the vSpace admin console), you can enter the domain that you want input to the Windows login dialog box upon connection.
- In the "Programs" section, you can define the application that launches when the access device connects to a host PC using that profile. You can make the desktop come up, or a define a program to be run that's specified by program name and the folder where it exists on the host PC.
- In the "Desktop Size" section, you can set the video behavior when the access device connects to a host PC using that profile. You can set the resolution, color depth, and frequency. For example, you can choose a resolution of 1024x768 at a color depth of 16 bits.
- The "Mode Test" button allows you to choose a desktop setting and do a basic test to see if it works with your monitor. Click on the button and the video output will change to the specified resolution, color depth and frequency. To exit the video mode test, press the "Esc" key on the keyboard.
- Click on the "OK" button to save the changes and close the window.
- Click on the "Cancel" button to discard the changes and close the window.

**Note:** Some monitors may not properly display certain video modes.

## The “Password” Tab

The "Password" tab contains settings for protecting the access device options with a password.

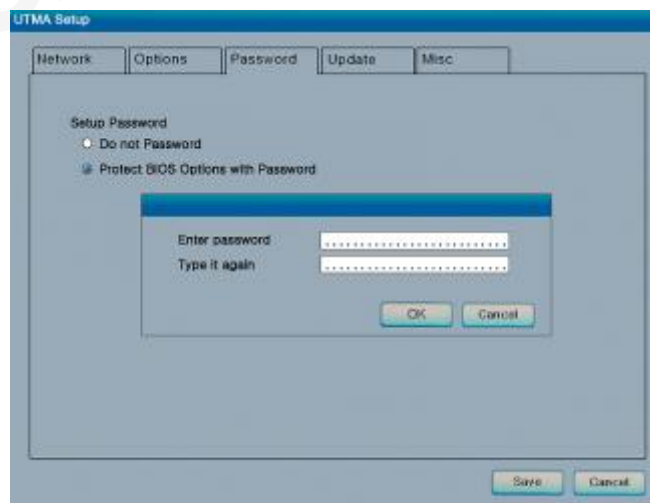

If you select "Do not use Password", there will be no password required to view or change the access device's settings.

If you select "Protect device Setup Options with Password, a dialog box will pop up where you will be required to enter a password twice. Then, when users click on the "Setup" button in the "Options" sub-menu, they will be asked to enter the password. No other menus are affected by this password.

NComputing recommends setting the password to improve security.

### The “Update” Tab

Your NComputing L-Series access device may at times require a firmware update. To do this, select the "Update" tab and click on the "Update" button. When the access device asks you for a password, enter "updateme" (without the quotes). Your access device will walk you through the process of updating the firmware.

It is crucially important that you follow the instructions. If you turn off the access device during the firmware update process, it may become non-functional.

After the firmware update process is complete, reset the access device by turning it off and on.

Certain changes in the vSpace software require a firmware update in each access device connecting to it. NComputing notifies customers via product Release Notes when a firmware update is required by a given vSpace software update.

NComputing™



## L300 Access Devices

### The “Server Selection” Screen

The “Server Selection” screen is the first to appear when the L300 device starts. From here, the user can:

- Connect to a vSpace host computer on the network

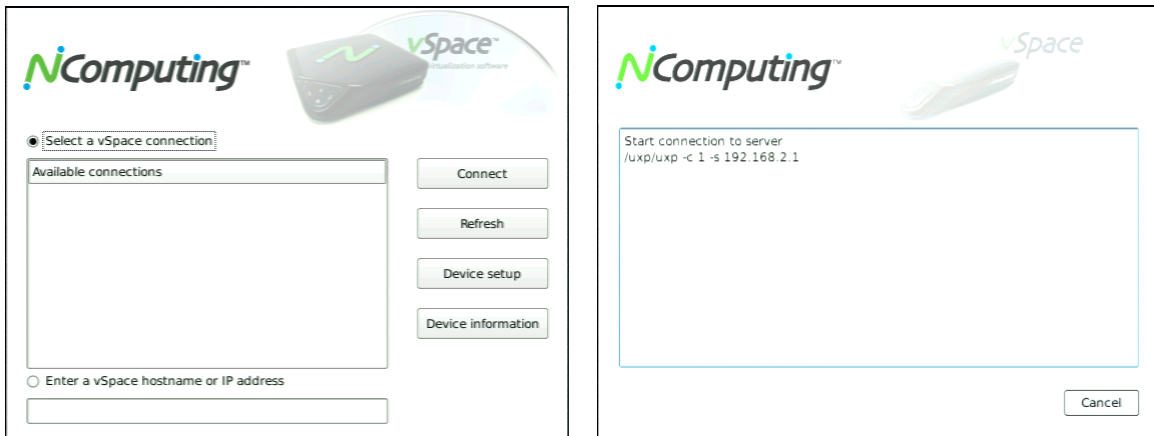

- Refresh the Server List

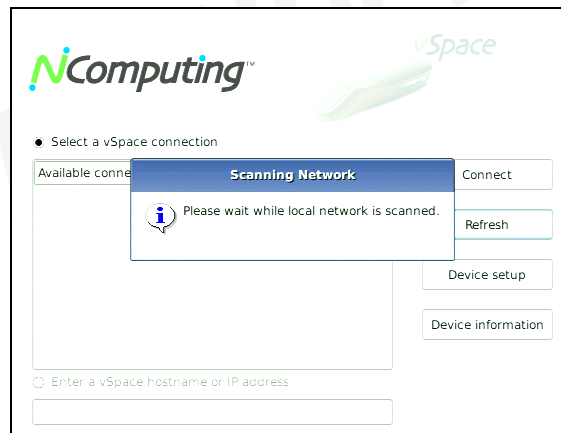

- Configure the device via *Device Setup*
- View the *Device Information* screen, which displays:
  - Device ID
  - Firmware Version
  - Board Version
  - Serial Number
  - IP Address
  - Network Mask
  - Gateway
  - MAC Address



### The “Device Setup” Screen

The Device Setup screen holds all of the device’s configuration data, which is divided into eight categories:

- Connection Settings (default tab)
- Manage Groups
- Login Settings
- Network
- Info
- Password
- Update

When the user is finished configuring device settings, they can click “OK” to save their changes and exit the Setup screen, click “Apply” to save their changes and remain in the Setup screen, or click “Cancel” to exit the Setup screen *without* saving their changes.

**Note:** If changes have been saved with the “Apply” button, clicking “Cancel” will not undo them.

### Device Setup - The “Connection Settings” Tab

The Connection Settings tab is used to configure how the device locates and connects to servers (vSpace hosts) on the network.

- “Autoconnect” the device to a specified server or server group (see “Manage Groups” below), without prompting the user.
- Populate the server list with:
  - Discovered Hosts
  - Manual IP or Hostname entry
  - Group List

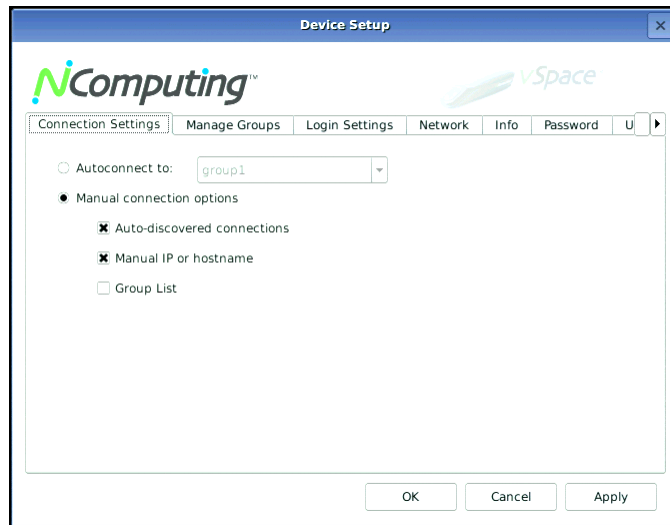

### Device Setup - The “Manage Groups” Tab

The Manage Groups tab gives administrators more control over their device’s connection options. From this tab, they can:

- Add a new Group to the group list
- Modify an existing Group
- Delete an existing Group

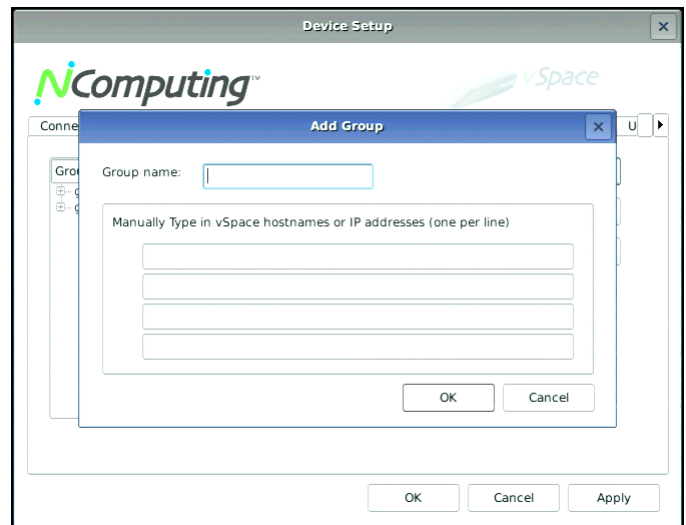
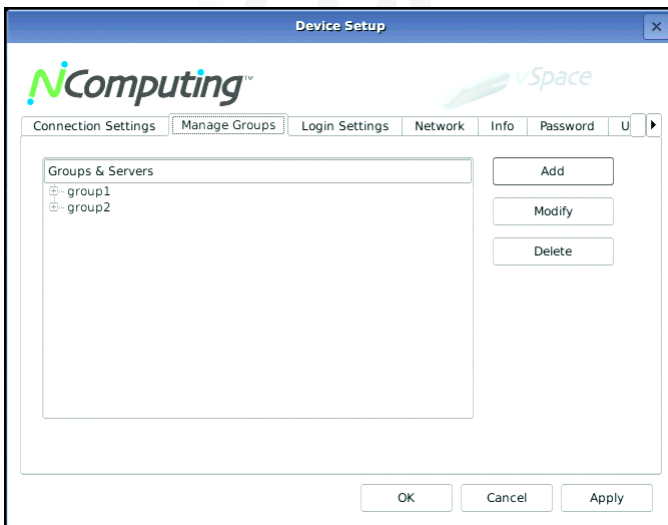

When adding a group, the user must populate a group name, and has the option of immediately adding up to four hosts to the group, entered by their Hostname or IP.

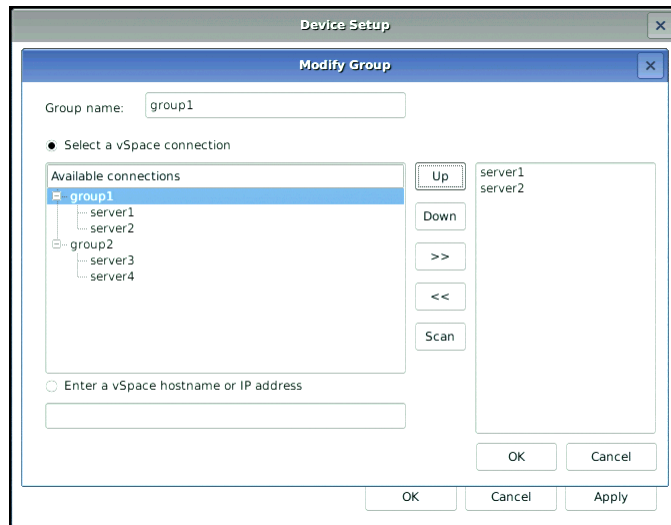

After a group has been created, the user may choose modify the group to add hosts, remove hosts, or alter the Group Name. To accommodate flexible failover scenarios, a server is allowed to be a member of multiple groups, and can be included in the same connection group multiple times.

### Connection Group - Auto Rollover

NComputing L-series devices and vSpace software have been designed from the beginning to minimize administrative management requirements, and the L300 builds on that legacy. The L300 has a new auto rollover feature that can provide extended control for those customers needing those capabilities

When an L-series device is configured for “Autoconnect,” anytime the device is power cycled, and anytime a user logs off the device, the device automatically attempts to connect to the vSpace server specified in the autoconnect parameter.

The L300 adds the concept of a “server group” to the autoconnect feature which in turn creates the auto rollover feature.

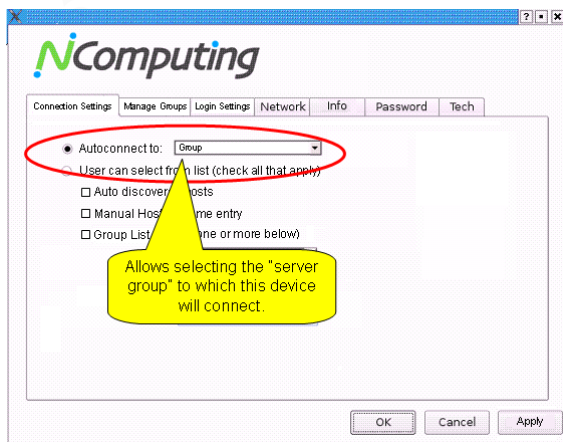

A “vSpace server group” is a collection of one or more individual vSpace servers specified by a name that’s currently defined from inside each L300 devices setup interface.

If a server group contains only one name (or IP address), then the L300 attempts to connect to that server until successful or until the L300 is reset. If the server group contains more than one name (or IP address), the L300 tries to connect to the first server in the list for 5 seconds, and if no successful connection is made, the

L300 attempts to connect to the second server in the list (i.e., the device does an “auto rollover” to the next server). If after 5 seconds, the L300 does not successfully connect to the second server in the list, the device attempts to connect to the third device in the list, etc. When the L300 reaches the end of the list, it starts again at the beginning of the “server group” and continues until a connection is made or until the L300 device is reset. (To allow for unusual requirements or server weighting algorithms, an individual server name or IP address may exist in multiple places in the list.)

Whenever an L300 disconnects from a session, autoconnect (if set) begins at the top of the connection cycle. The device does not keep track of the last server to which it successfully connected. Issuing a device reset command from the admin console will also cause the autoconnect processing to restart at the top of the cycle.

In the future as management features are added to the vSpace console, groups will be extended from a local device implementation to allow administrators to create and use “server groups” that are global in scope and management from the host vSpace console, until then groups must be managed on each device.

### Device Setup - The “Login Settings” Tab

The Login Settings tab contains various device settings related to performance within Windows, including:

- Video Settings
  - Resolution
  - Color Depth
- Login Settings
  - Username
  - Password (must be set within vSpace console on host)
  - Domain
  - “Start following program...” (kiosk mode)

**Note:** To launch an application instead of going to the desktop, enter the executable name in the “Program” field, and its drive/folder directory in the “Folder” field. For example, launching Internet Explorer on login would require “iexplore.exe” in the Program field and “C:\Program Files\Internet Explorer” in the Folder field.

- Sleep if Idle (this setting operates within the device firmware to help prevent screen burn-in. Within Windows, the standard Windows screen saver must be used)

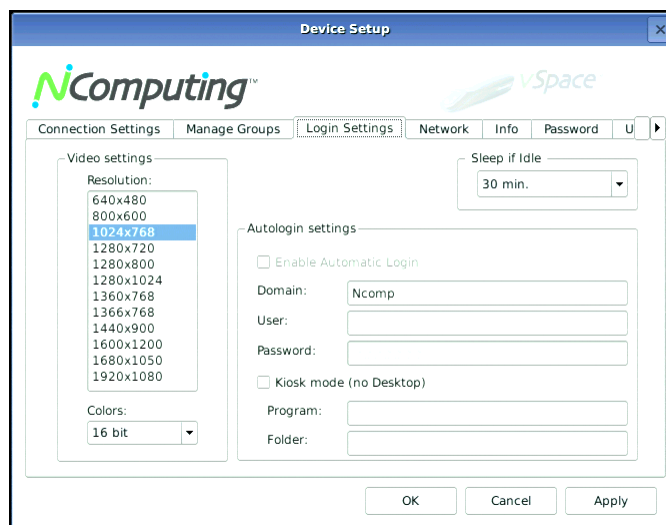

## Device Setup - The “Network” Tab

The Network tab contains the device’s network communication settings, as well as a Ping Test tool. The settings that can be configured are:

- Device Network Name (use to identify the device within the vSpace administration console)
- IP Configuration
  - DHCP (dynamically obtains settings from the network’s DHCP server)
  - Static Configuration (requires manual population of the IP settings)
    - IP
    - Subnet Mask
    - Gateway
    - DNS 1
    - DNS 2
  - Optimize for
    - LAN
    - WAN (this feature currently disabled)

The Ping Test utility can help in troubleshooting network connectivity problems. For instructions on using the Ping Test utility, simply leave the text field blank and click “Ping”.

## Device Setup - The “Info” Tab

The Info tab shows all of the data available from the Info Screen (see “Server Selection Screen” above), with the addition of two fields:

- IP Conflict – This field indicates whether the device has been assigned an IP Address already in use on the network. For the device to function, this value should be “no”.

- **Link Detected** – This field indicates whether the device’s Ethernet port is actively communicating with the network. If the value is “no”, a network cable may be unplugged, and the device will not function properly.

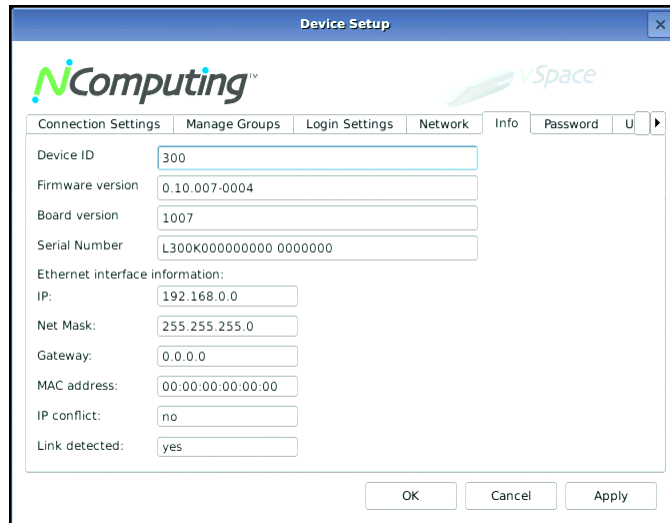

### Device Setup - The “Password” Tab

The Password tab allows the user to enable or disable the device’s firmware password. If set, the device will prompt for the password anytime a user attempts to access the Device Setup screen or tries to cancel an automatic connection. It is recommended that this password be set before deployment, to prevent tampering by unauthorized users.

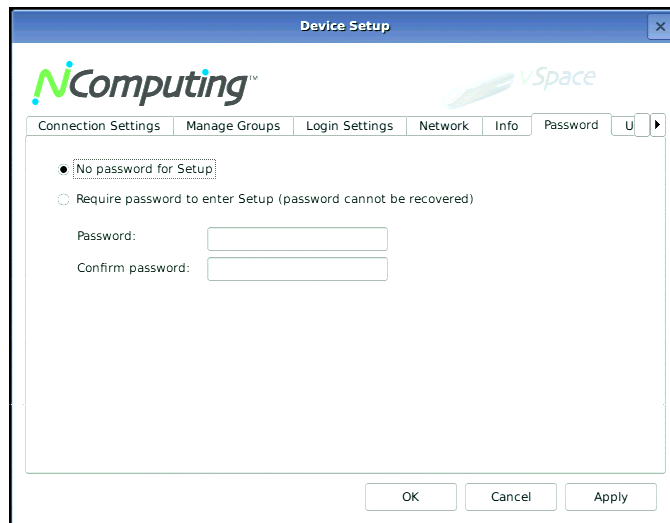

### Device Setup - The “Update” Tab

The Update tab allows the user to update the device firmware from a vSpace host on the network. To load firmware from the vSpace host, simply check the “Automatic firmware update” checkbox and click “Apply”. The

device will automatically check for newer versions of firmware on the network; simply follow the on-screen prompts to complete the firmware update process.

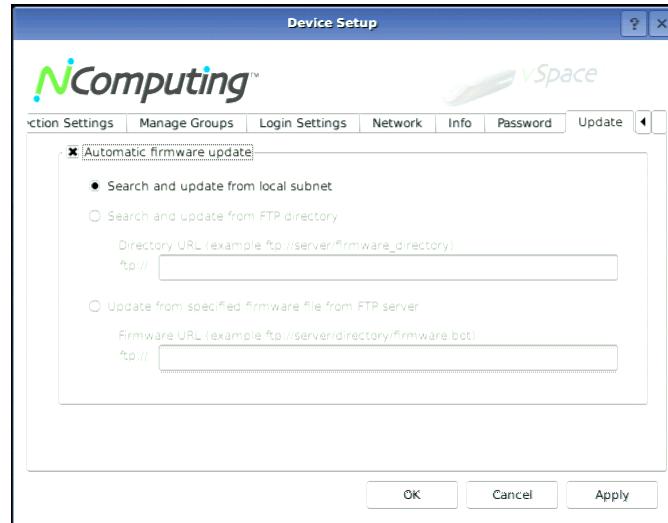

## L300 Multimedia Acceleration

The L300 will display full screen streaming video across multiple user sessions and is optimized to do so using NComputing's vSpace transcoding process. This process works transparently to stream video and support multimedia content in a terminal device well beyond what has been seen in thin client or multiuser computing before. Full screen streaming video with matched sound synchronism in the norm for vSpace and the L300.

## vSpace Multimedia Transcoding and Numo

vSpace transcoding is designed to replicate the multimedia experience that the user would see on the host. vSpace uses has two optimized video pipeline implementations to achieve the performance:

### 1. Direct JPEG

- Streaming content that is capable on host is captured by our device driver, compressed and passed over the wire to the Numo chip for decoding and scaling.
- Direct JPEG has the capability to stream video content that the host is capable of streaming. This makes Direct JPEG a seamless method of delivering vSpace transcoding on the L300 without having configured the many video setting.

### 2. Directshow API

- This method is similar to above but uses Microsoft's API that allows for another level of optimizations

Either method provides a great media streaming experience on the L300.



The Numo™ system-on-chip (SOC) in the L300 device and the vSpace-enabled host PC work closely together to balance video streaming workloads. The vSpace software for the L300 features a unique transcoding engine that can take most any media file format and transcode it for a low bandwidth transfer over the network to the L300 client which then decodes and scales locally. This efficient approach allows NComputing to offer low cost clients that can provide full-screen streaming video, up to display sizes of 1920 x 1080.

The vSpace transcoding process works as follows. A streaming video file (.mp4, .wmv, etc.) is activated from the L300 virtual desktop. The vSpace transcoding engine starts with the video that has been decoded by the host computer and media player (and optimized with Directshow) and then it encodes the data into a compressed video stream. This compressed video data is then sent over NComputing’s UXP protocol to the L300 device. The Numo SOC in the L300 then decodes the data locally and scales it to fit the screen and window resolution set in the user’s desktop. The diagram below illustrates this process:

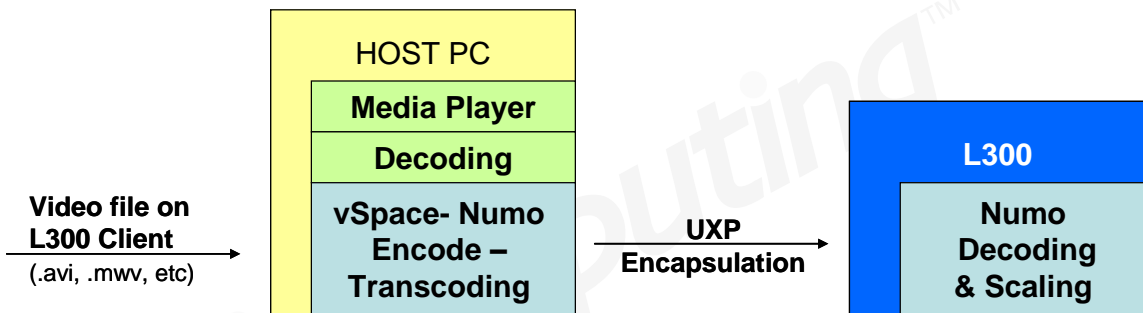

A key advantage of the vSpace transcoding process is that the original video file’s codec processing takes place on the host. This allows vSpace to work with a wide variety of codecs within the PC that may be updated from time to time. These multiple video formats using multiple codecs are then processed by the vSpace transcoding engine into a single compressed video stream that is decoded in dedicated hardware on the L300. This enables the L300 to deliver an exceptional level of performance at a low cost. The transcoding process for streaming video uses compression that removes data that will generally not be detectable by the end user. However, the standard display graphics for normal 2D applications are extended in a separate lossless process. This ensures the best possible user experience for all types of interaction with the desktop.

Another key advantage of this approach is that full screen scaling on the L300 does not impact the CPU utilization on the host since the Numo SOC’s scalar capabilities handle this function locally.

The L300 virtual desktop accelerates most video formats through standard media players, such as Windows Media Player (which is included in all current Microsoft operating systems) or Media Player Classic (which is included in the vSpace installation).

By default, these media players only playback a limited number of media types with just a few preinstalled codecs (coder/decoder). Most host PCs do NOT come configured for a wide range of support for media types, so additional supported codecs can be added when setting up the host and configuring the NComputing vSpace installation. For an L300 to stream a given file the host must be able to stream it first. The vSpace acceleration method on the host system directs the output of the

media playback to a compute-efficient transcoding engine that creates a low-bandwidth stream that is transmitted to the L300 device over the network. The L300 then decompresses and scales the video stream locally in hardware up to 1920x1080 resolution for optimal video quality and always with flawless sound synchronization.

NComputing video acceleration for up to full-screen resolution directly supports Windows Media Player 10 and 11 as well as Media Player Classic. Any other media player can be used for effective display of videos in windows that are at approximately 480x360 resolution or less where acceleration is not required. Some of these additional media players may also take advantage of the NComputing video acceleration capabilities when configured to use the Directshow API and the appropriate codecs -- check the online knowledge base or forum for community supported media player options.

The following table shows many of the popular media formats that are supported by the L300 video acceleration feature using Windows Media Player 10 and 11 or Media Player Classic with appropriate codecs installed. A reference of common industry codec's can be found at [www.ncomputing.com/mediareference](http://www.ncomputing.com/mediareference).

### Media formats accelerated by L300 virtual desktop in Windows Media Player 10 and 11 or Media Player Classic

Media type	File extension	Example supported codecs*
QuickTime™	.mov	h.264
Audio Video Interleave	.avi	MJPEG, DivX®, Xvid (MPEG-4)
Windows Media Video	.wmv **	Windows Media 9 +
DVD	.vob **	MPEG-2
Matroska	.mkv	h.264
M4V	.m4v	h.264
MP4	.mp4	MPEG-4
MPG	.mpg	MPEG1-MPEG-2
Flash™ Video	.flv **	h.264

\*Not a complete list. Refer to full listing of enabled codecs provided with your codec pack

\*\* Supported with Media Player Classic only

### Optimizing for DirectShow

As mentioned Direct JPEG has the capability to stream video content that the host is capable of streaming. This makes Direct JPEG a seamless method of delivering vSpace transcoding on the

L300 without having configured the many video setting. But Directshow does offer some added performance benefits and using it will maximize the number of streams that can be obtained from a single host, therefore we have provided what are mostly industry standard steps to configure Directshow properly.

Microsoft's market leading Directshow API or by using NComputing Microsoft's Directshow API is the world's most popular video playback API is therefore the most widely supported. Maximum performance can be achieved with a standard install but to support a wider range of video file types the administrator or user should:

- Choose a video player that supports the Directshow API and configure it for Directshow (Windows Media Player and Media Player Classic are installed by default)
- Download the proper codecs for any video files they wish to play and enable them for the player. Also setting the MIME type to the appropriate player will make sure the association to the correct player is made
- For playing .avi files, apply a filter to determine the true file encoder used.

Some video players that support Microsoft's API do not do so by default and configuration may be needed. Proper setup of filters and codecs can assist in making this process simpler. The process mentioned in the previous and next section will ensue that the maximum performance of the L300 can be achieved across a wide range of video types.

Players that do not support Directshow or Direct JPEG should be avoided as streaming files that are greater than ~480 x 360 will result in dropped frames, an overall reduction in video quality and greater network bandwidth use.

## Players, Codecs, and Filters

Windows Media Player is installed by default with any Microsoft OS and our vSpace installer now includes Media Player Classic; therefore both players will be installed by default.

Download the proper codecs to support the video files types that are desired and enable them for the player. A reference of common industry codec's can be found at [www.ncomputing.com/mediareference](http://www.ncomputing.com/mediareference), but others can be used.

Optimally a filter may be needed to determine the true file type of a .avi file. The instructions for one such filter, Matroska, are described in the L300 User's Guide. Also setting the mime type to the appropriate player will make sure the association to the correct player is made.

As NComputing determines the optimal settings for players and/or Codec's we will post them as Knowledge Base articles.

## Browser-based video acceleration

In addition to the media types supported above in stand-alone media players, the L300 also supports acceleration of browser-based embedded video including Flash video. Unlike stand-alone media players with discreet graphics output, the graphics output of browser-based video is combined with the other web page content. vSpace software detects when embedded video is being played in a

browser and then directs the output of that video to the vSpace transcoding engine which creates a low-bandwidth stream that is transmitted to the L300 device over the network. The L300 then decompresses and scales the video stream in hardware up to full screen resolutions for optimal video quality.

Users will find that video on popular websites such as YouTube™ will display full-motion content up to 480p that can scale to full-screen at 1920x1080 resolution. During this process the display might show a very brief blue window where the streaming content is going to play, this is part of vSpace setting up for the transcoding process.

## Browser-based animation optimization

Flash animations are optimized through vSpace and default rendering in the L300. The native rendering of desktop application content by vSpace assures that users get fast updates, smooth scrolling, and synchronized audio. The hardware-optimized performance of the L300 gives users a great multimedia experience.

## Using the vSpace Management Console

The vSpace Management Console is used to administrate client sessions and configure advanced features. Several basic console commands can be accessed by administrators through the vSpace system tray icon. These include:

- vSpace Management Console – This opens the Management Console so that advanced settings and configurations can be made for the client sessions.
- Station Information – Displays basic identifying data for the current access device.
- vSpace - Send Message – Opens the vSpace messaging window, which can be used to display messages on any terminal connected to the same host.

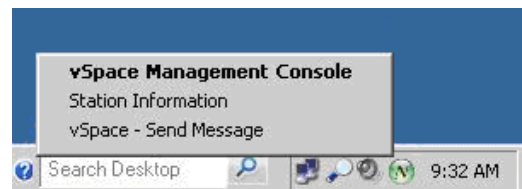

Non-administrator users also have access to several settings through the vSpace system tray icon. These include:

- Station Information (see above)
- vSpace - Send Message (see above)
- Browser Acceleration – Enable or disable Browser Acceleration to alter browser-based streaming-media performance (L300 access devices only).
- vSpace - Keyboard Settings – Configure the station's keyboard default num-lock, caps-lock, and scroll-lock states (access devices only).

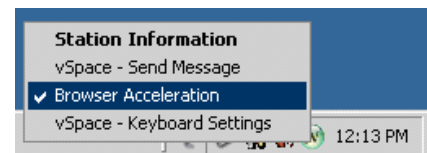

To make advanced configurations, launch the vSpace Administration Console either from the (administrator session's) system tray icon or by the Start Menu shortcut labeled "vSpace Console".

## Software Settings (local)

The "Software Settings (local)" tree allows you to see and change settings for the host PC.

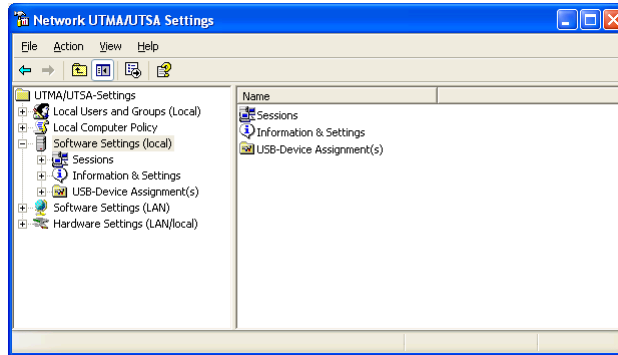

## Sessions

The "Sessions" item shows information about all the sessions currently active on the vSpace software. By clicking on a session in the left window pane, you will see two tabs of available information.

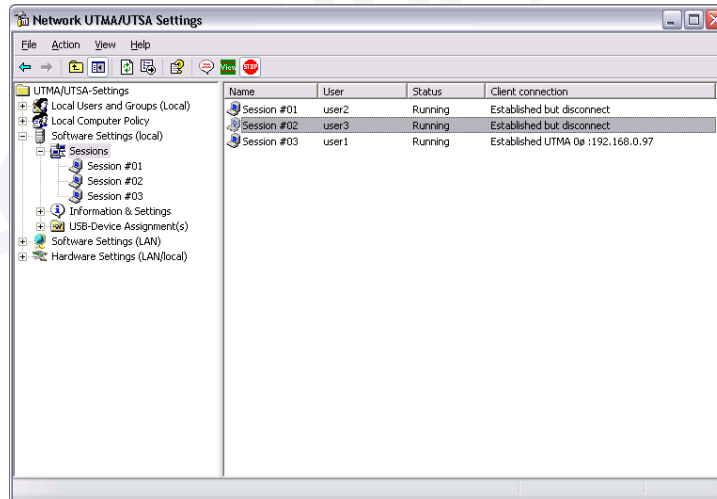

The "Application loaded" tab shows all the applications running on the selected session.

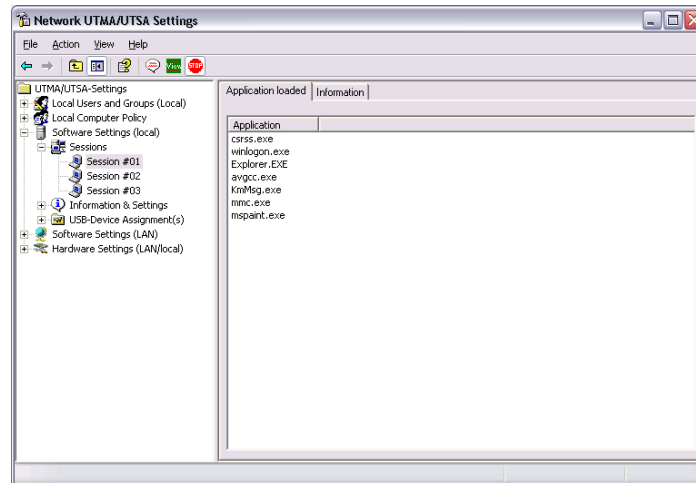

The "Information" tab shows the following information about the selected session:

- The "Station name" field shows the access device's name that was defined via the vSpace admin console.
- The "Logged in user" field shows the username that is currently logged in.
- The "Default user" field shows the default username for the vSpace user session. If one is not configured, it shows the last user that logged in.
- The "Status" field shows the session connection status.
- The "Client connection" field shows the UTMA session and the IP address of the access device used.
- The "Display Id" field shows the access device's display ID.
- The "Hardware Id" field shows the access device's virtual hardware ID.
- The "Keyboard Id" field shows what type of keyboard interface is used.
- The "Pointer Id" field shows what type of pointer interface is used.

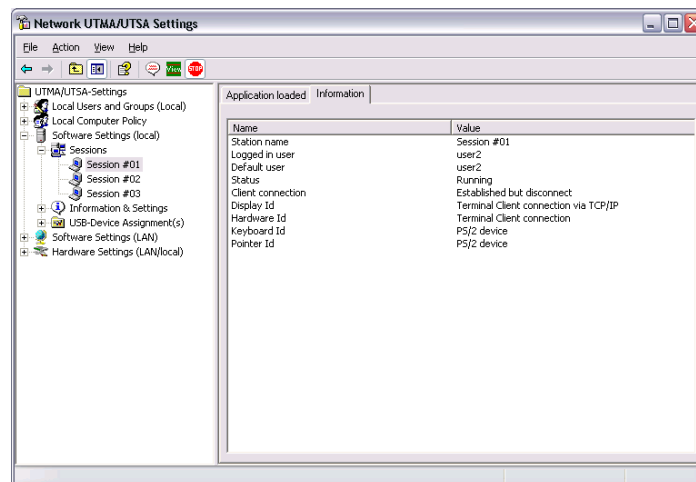

In the toolbar, there are three buttons: "Send Message," "View Station" and "Stop Station."

Note: The “View Station” button may not be present if this function is disabled. The “View Station” button is not present when you select the session that you are currently using.

To send a message to a session, select the session and click on the “Send Message” button in the toolbar. The “Broadcast” tab allows you to select an access device to send the message to, a “From” entry, and a message. The access device must be connected to the same host PC. The “Network Broadcast” tab allows you to send a message to an access device that is connected to the same host PC or a different host PC on the same network.

To view a session’s screen, select the session and click on the “View Station” button. When viewing a session’s screen, you may select whether or not to control the mouse and keyboard remotely and whether or not to allow the user to control the mouse and keyboard. To see and change these settings, right-click on the title bar of the session view to bring up a menu. There are two settings, “Controlled by TS Admin” and “User Input Allowed.”

To stop a session, select the session and click on the “Stop Station” button

## Information & Settings

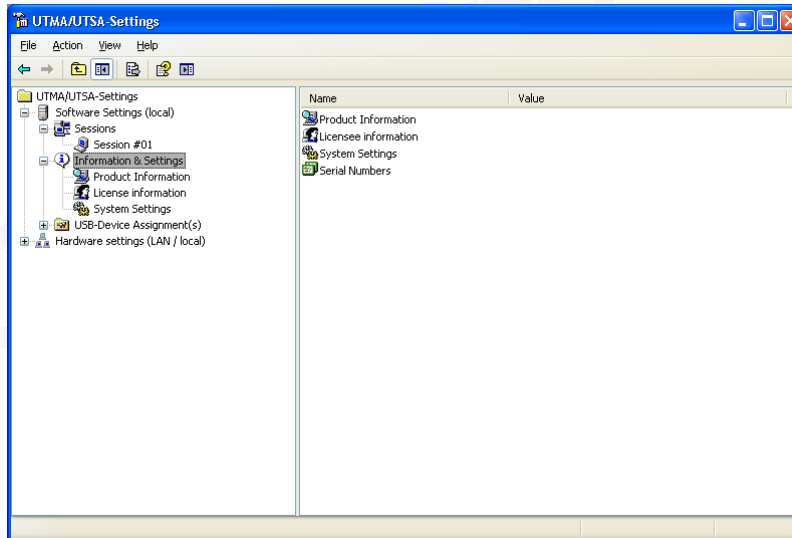

The "Product Information" tree item shows information about the host’s vSpace software.

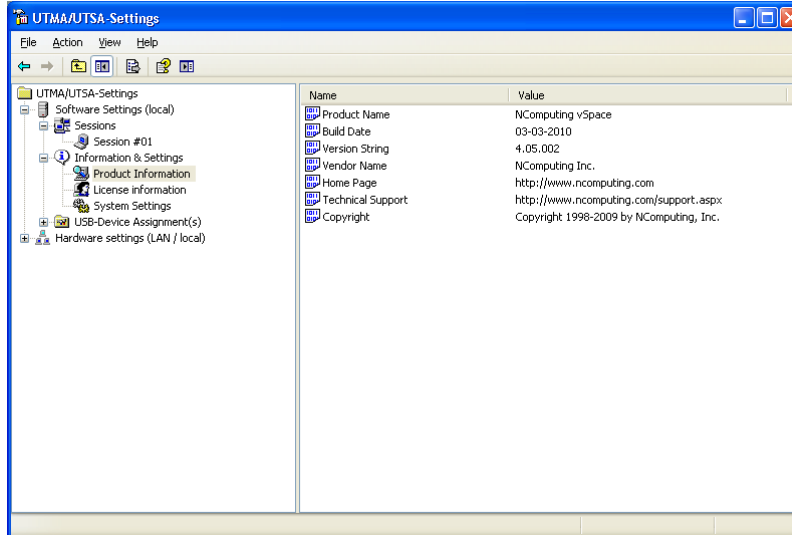

The "License information" tree item shows the information entered during the registration process (or, as shown below, how much longer the product will function before registration is required).

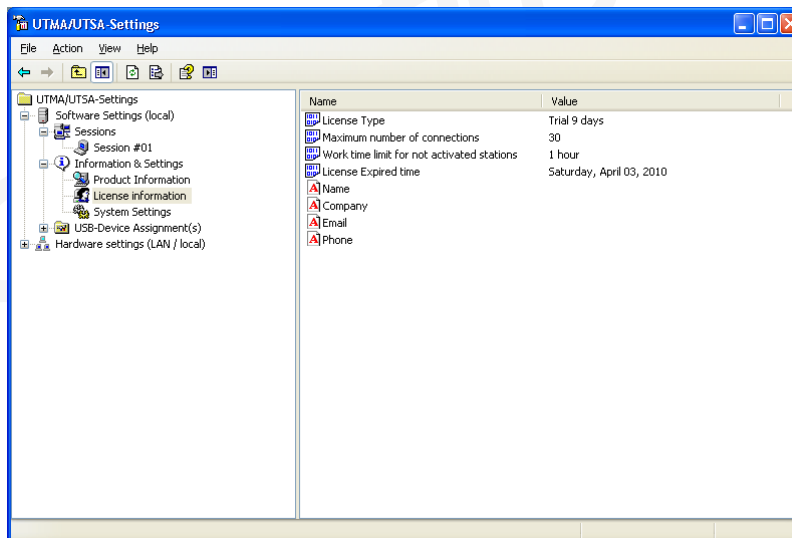

The "System Settings" tree item shows the following settings for the vSpace software. Double-clicking on the name of the setting allows you to adjust it (unless it is read-only, which is specified below).



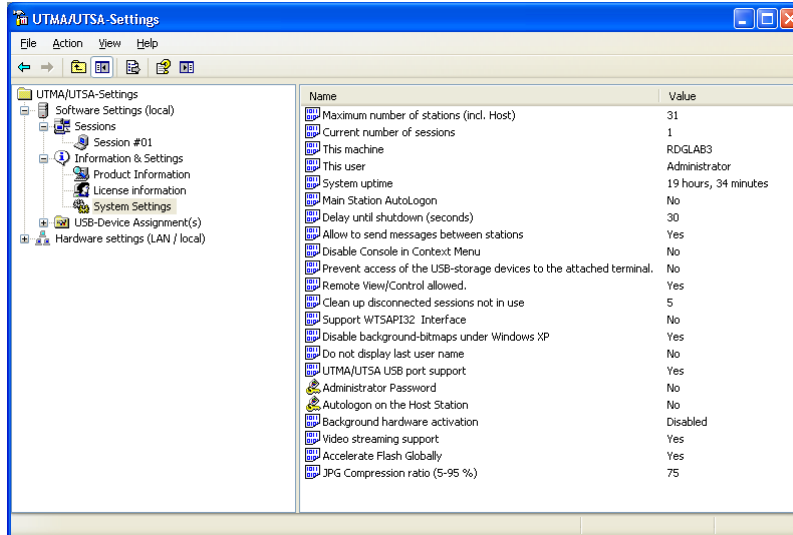

- **Maximum number of stations (incl. Host):** Displays the maximum number of sessions the vSpace software is configured to support. This number includes the host PC. This setting is read-only.
- **Current number of sessions:** Displays the number of active sessions. This setting is read-only.
- **This machine:** Displays the name of the host PC. This setting is read-only.
- **This user:** Displays the currently logged-in user's username. This setting is read-only.
- **System uptime:** Displays how long the host computer has been logged on. This setting is read-only.
- **Main Station AutoLogon:** Displays whether or not the host PC is set to automatically logon at boot-up.
- **Delay until shutdown (seconds):** Displays the default amount of time after a shutdown command is issued on the host until the shutdown occurs. After the shutdown command is issued on the host, the shutdown timer starts. Then, a window pops up on each access device that tells the users they must logoff since the host is shutting down. Each user must save their work. Also, a window pops up on the host that enables the administrator to abort the shutdown timer and start the shutdown immediately, or cancel the shutdown. When the shutdown timer expires, the shutdown occurs.
- **Disable Send Broadcast Message:** Displays whether or not the administrator has disabled broadcast messages. See the description of the "Sessions" tree item for more information about how broadcast messages work.
- **Disable Console in Context Menu:** Displays whether or not the administrator has disabled the Console Icon from showing up in the Windows system tray of a user's virtual desktop session.
- **Prevent access of the USB-storage devices to the attached device:** Displays whether or not the administrator has globally prevented access to USB devices on access devices.
- **Remote View/Control allowed:** Displays whether or not the administrator has configured the vSpace software to allow administrators to remotely view user and control user sessions.
- **Clean up disconnected sessions not in use:** Displays whether the vSpace software automatically looks for disconnected sessions that are not in use and logs them out after a defined period of time. If this feature is turned off (set to "No" or "0"), when any access device drops its connection, the connection remains active on the host. When the user reconnects, their disconnected session is reconnected to their new session and all their open files and applications are available again. Also, in this case, the only way to end a disconnected session is for an administrator to stop the session from

the console software. If this feature is turned on (set to any whole number up to 999), the same behavior applies, but when a session is disconnected, a timer starts. If the user reconnects before the timer is up, their disconnected session is reconnected to their new session and all their open files and applications are available again. If the timer runs out and the session is still disconnected, the vSpace software will end the session by itself. This makes sure that disconnected sessions do not reserve resources for an indefinite period. By default, this is set to “5.”

- **Support WTSAPI32 Interface:** Displays whether or not the vSpace software has turned on support for the WTSAPI32 interface.
- **Disable background-bitmaps under Windows XP:** Displays whether or not the user is able to set their own background bitmap for their Windows desktop.
- **Do not display last user name:** Displays whether or not the vSpace software displays the last user name that logged on using a particular access device. This is sometimes enabled as a security measure.
- **UTMA/UTSA USB port support:** Displays whether the administrator has set the vSpace software to allow using the USB port on L230 access devices.
- **Administrator Password:** Displays whether an administrator password is set.
- **Autologon on the Host Station:** Displays whether the host PC is set to boot up without the Windows logon screen showing on the host PC.
- **Background Hardware Activation:** Displays whether the software silently activates newly-connected devices.
- **Video Streaming Support:** Displays whether the host will provide streaming video to compatible devices. (L300 only)
- **Accelerate Flash Globally:** Displays whether the host will leverage video streaming to deliver high-quality Flash to the access device at the cost of higher processor utilization.
- **Compression Ratio (5-95 %):** Displays the level of compression used on the access device’s real-time output. A higher number results in higher display quality at the access device, but also utilizes greater network bandwidth.

## USB-Device Assignment(s)

Note: This feature is only available on the L200 (older model), L230, and L300.

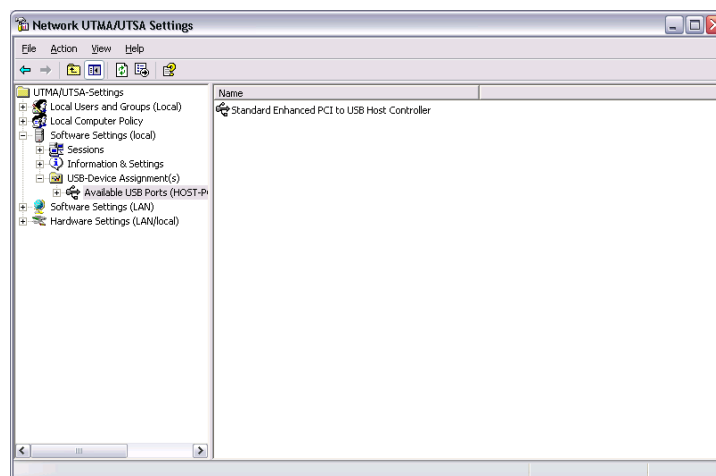

In the "USB

-Device Assignment(s)" tree item, you can control connections between USB ports on the host and vSpace sessions. To use this function, navigate the tree to select a USB port. When you right-click on an entry under "USB-Device Assignment(s)", you can de-select the "Hide the ports that are not connected" item to see all ports. After selecting a port, the following information is displayed:

- The port number.
- If a device is connected, the device's simple name.
- The device's longer name, usually including the manufacturer and model.
- A check box for "Allow all users access to every USB port". When this is selected, all USB ports are connected, as if in one hub. When the box is not checked, a list of available USB ports is displayed where you can select which one(s) is/are to be connected to the selected device. This list shows each access device's MAC address and its serial number along with a checkbox.

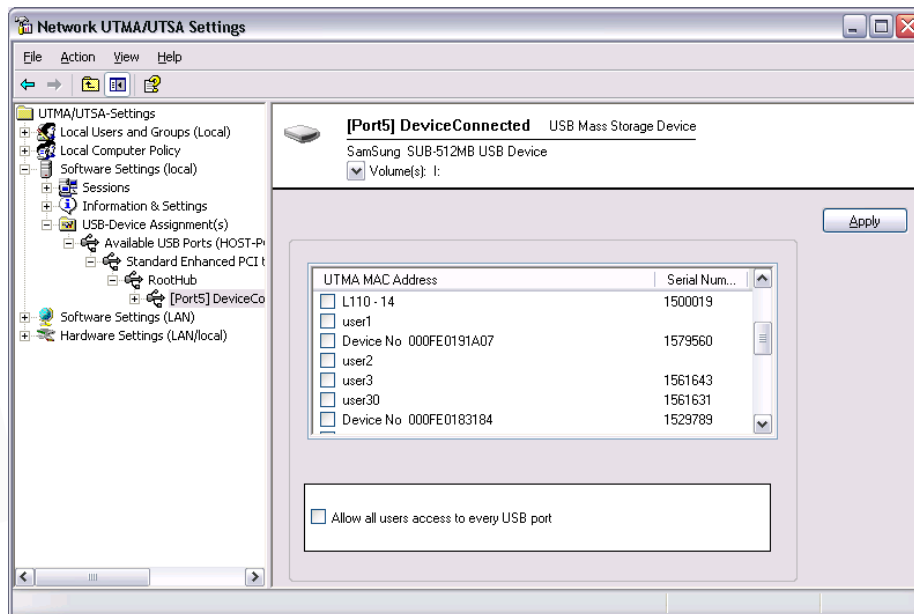

When you click on the "Apply" button, changes to the USB-Device assignments are saved. To discard changes, simply navigate to another tree item or close the console without clicking on the "Apply" button.

Note: NComputing L-series access devices use remote USB 1.1 or 2.0 to provide transparent USB redirection. Transfer speeds are subject to protocol & network limitations and these USB devices may require driver software that is network & multiuser aware; please test peripherals before deploying.

## Software Settings (LAN)

The "Software Settings (LAN)" tree allows you to see and change settings for the host PC and all other PCs on the network that are running the vSpace software. Once you select a server in the tree, the same settings are present as are in the "Software Settings (local)" tree item.

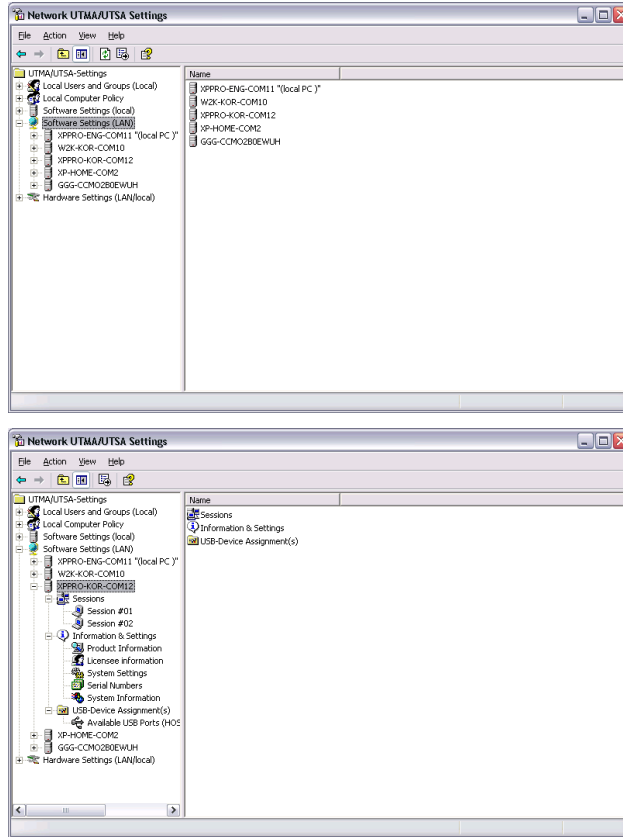

## Hardware Settings (LAN/local)

The "Hardware Settings (LAN/local)" tree allows you to see and change settings for all access devices on the network.

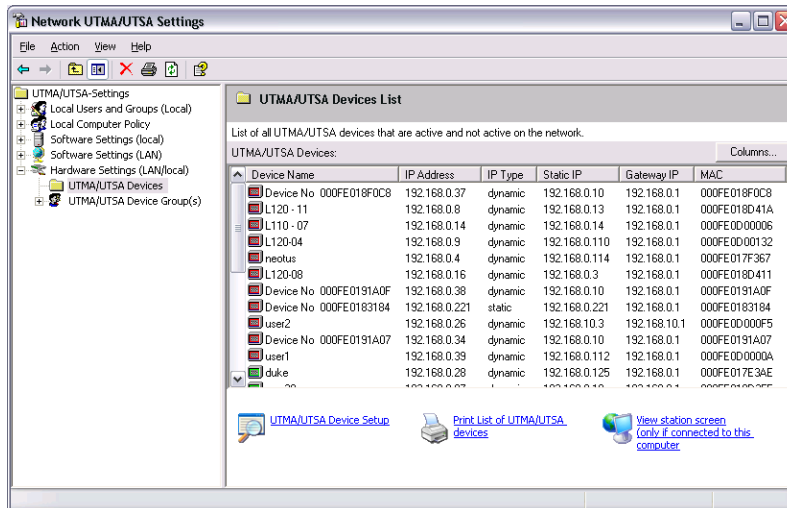

When you select the "UTMA/UTSA Devices" tree item, there is a table in the right side of the window that contains information about each access device. There is a very wide variety of information available for each access device. Clicking on the "Columns" button enables you to select what columns are displayed. You can

select a preconfigured group of columns or you can click on the "Advanced" button to select individual columns to display.

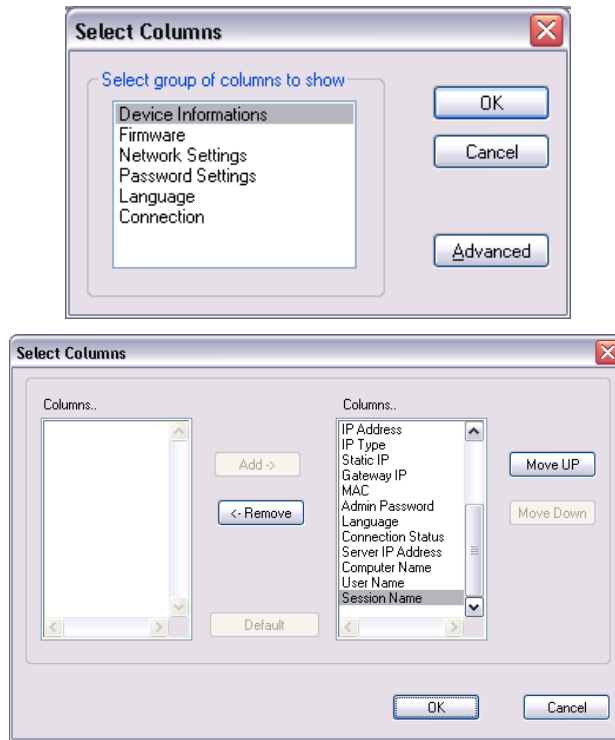

Double-clicking on an entry in the table brings up the "Device Properties" window that shows a list of properties and buttons for changing the device's settings.



The settings you can change are all the same settings you can change when you use the "Options" window on the access device itself. See the access device setup section for details on these settings.

Note: There are four settings you can change in the "Device Properties" window that you can't change in the access device's "Options" window.

- One is the device's name. You can configure it on the management console by clicking on the "Connection Settings" button.

- The second is the access device's group membership. You can add the access device to a group or multiple groups by clicking the "Member of Groups" button and adding the groups to the list.
- The third is enabling and disabling USB on the selected device. In the "Device Properties" window, there is a checkbox labeled, "Enable USB on this device".
- The fourth is the "Auto-Connect" feature. It is available under the "Connection Settings" button in device configuration. This feature enables configuring the access device to automatically connect using a specific profile when it is restarted or logged off.

You can print the access device's information by clicking on the "Print" button.

For L230 devices, a check box appears on the Device Properties screen that allows the administrator to specify whether or not the USB port can be used on that access device.

In the "UTMA/UTSA Device Group(s)" tree item, you can create groups of access devices for administrative purposes. You can use groups to organize your access device records by any criteria. Access devices can belong to as many groups as necessary.

Right-clicking on the "UTMA/UTSA Device Group(s)" tree item will bring up a context menu where you can create a group.

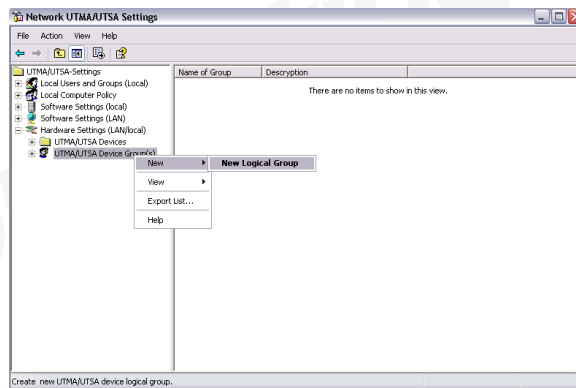

In the "Enter UTMA Device group name" window, enter the group name and description.



## Troubleshooting error messages

For the latest information and troubleshooting help, please visit the NComputing online knowledge base at:  
<http://www.ncomputing.com/support.aspx>

### DHCP server was not found

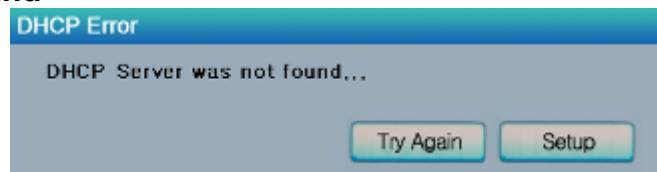

If the access device cannot find a DHCP server, this error message appears.

Make sure there is a DHCP server on the current network.

Make sure a LAN cable is connected to the access device.

Make sure the LAN cable connected to the access device is not a cross-over cable.

Make sure the LAN cable is properly connected to the networking equipment.

If there is no DHCP server on the current network, change to using a static IP address. See the section on installing the access device for instructions.

### No Terminal Server found message

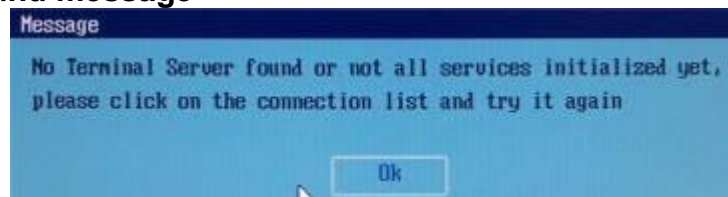

This occurs when the access device is set to find the host PC and it does not find the host PC where the vSpace software is installed.

Make sure the vSpace program is installed on the host computer.

Make sure the LAN cable is properly connected to the host computer.

Make sure the host computer and access device are in the same subnet/local area network.

Make sure any firewall or anti-virus programs installed in the host computer or network equipment are compatible with the vSpace software.

## Host unreachable...

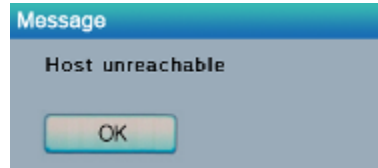

When the access device cannot connect to the host PC, this message appears.

Make sure the server connection list is configured correctly. See the section about configuring the access device.

Make sure the vSpace software is installed on the host PC.

Make sure the host computer and access device are in the same subnet/local area network.

Make sure any firewall or anti-virus programs installed in the host computer or network equipment are compatible with the vSpace software.

## TS ERROR – INVALID OR NO SERIAL NUMBER!

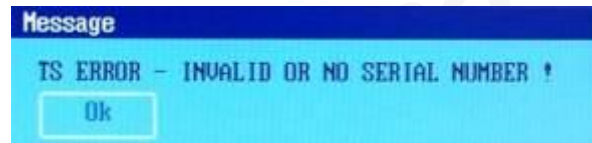

This message appears when no serial number exists in the host computer. This message does not indicate an error regarding the serial number of the access device.

Please see the section about product registration to register the vSpace software and the access devices.

## Connection was closed Message

“Connection was closed but your data is not lost and application is still running on the server. Please connect to the terminal server later.”

This message appears when the connection stops due to abnormalities occurring on the host PC or network equipment.

Check the Host PC or the network equipment when this message appears and restart the Host PC and access device. Unless the Host PC is rebooted, existing data in the Host PC may be used as is.

Check to see if the host PC is overloaded or experiencing stability issues.

Check to see if the network traffic is overloaded.

There is a feature in the vSpace software that keeps disconnected sessions running and available. If the user reconnects while a disconnected session for that username is present, the software will connect the disconnected session to the new session. The user will see the desktop as it was when the disconnection occurred.

The administrator can configure the software to keep disconnected sessions running and available indefinitely or to close them automatically after being disconnected for a specified period of time. The setting is in the administrative console's system settings and is called, “Clean up disconnected sessions not in use.”



## Authorization error



When two access devices use the same serial number simultaneously, the error message appears.

Check all serial numbers in the vSpace software admin console.

## TS ERROR – Stations Limit Exceeded!

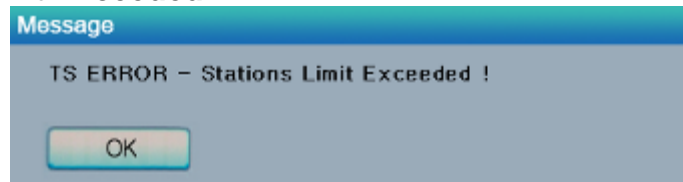

When an access device attempts to connect to the host PC and the number of allowed connections is exceeded, this message appears.

Check how many access devices are connected to the host PC.

Check what operating system is installed on the host PC.

## Glossary

- **Access device:** a network computing device using NComputing patented technology. It doesn't use CPU, VGA, and PC chipsets; it only uses a programmable SoC to connect to a Host PC. An access device using NComputing User eXtension Protocol (UXP) can be connected to Host PCs by using the LAN cable. Also, it can be connected to remote PCs through the Internet using TCP/IP.
- **Administrator:** a person who is responsible for managing a multi-user computing environment, such as a local area network (LAN). The responsibilities of the system administrator typically include: installing and configuring system hardware and software; establishing and managing user accounts; upgrading software; and backup and recovery tasks.
- **Alias:** a fictitious name used by an individual as an alternative to her or his true name.
- **Client/Server:** describes the relationship between two computer programs in which one program, the client, makes a service request from another program, the server, which fulfills the request.
- **Console:** the text entry and display device for system administration messages, particularly those from the [BIOS](#) or [boot loader](#), the [kernel](#), the [init](#) system and the [system logger](#).
- **DHCP:** (Dynamic Host Configuration Protocol) is a communications protocol that lets network administrators centrally manage and automate the assignment of Internet Protocol (IP) addresses in an organization's network. Without DHCP, the IP address must be entered manually at each computer in an organization and a new IP address must be entered each time a computer moves to a new location on the network.
- **Download:** the transmission of a file from one computer system to another.
- **Ethernet:** the most widely-installed local area network (LAN) technology - specified in a standard, IEEE 802.3.
- **Firewall:** a set of related programs (located at a network gateway server) that protect the resources of a private network from users on other networks and control what outside resources its own users have access to. (The term also implies the security policy that is used with the programs.)
- **Gateway:** a network point that acts as an entrance to another network. On the Internet, a node or stopping point can be either a gateway node or a host (end-point) node.
- **Host Computer:** a computer in which the vSpace program has been installed
- **Internet:** a worldwide system of computer networks in which users at any one computer can, if they have permission, get information from any other computer (and sometimes talk directly to users at other computers).
- **IP Address:** the Internet Protocol ([IP](#)) is basically the set of rules for one network communicating with any other (or occasionally, for broadcast messages, all other networks). Each network must know its own address on the Internet and that of any other networks with which it communicates. To be part of the Internet, an organization needs an Internet network number, which it can request from the Network Information Center (NIC). This unique network number is included in any packet sent out of the network onto the Internet.
- **LAN:** local area network (LAN) is a group of computers and associated devices that share a common communications line or wireless link and typically share the resources of a single processor or server within a small geographic area (for example, within an office building). Usually, the server has applications and data storage that are shared in common by multiple computer users. A local area

network may serve as few as two or three users (for example, in a home network) or as many as thousands of users (for example, in an FDDI network).

- Log on: in general computer usage, logon is the procedure used to get access to an operating system or application. Almost always, a logon requires that the user have (1) a user ID and (2) a password. Often, the user ID must conform to a limited length such as eight characters and the password must contain at least one digit and not match a natural language word
- MAC Address: in a LAN or other network, the MAC (Media Access Control) address is your computer's unique hardware number. (On an Ethernet LAN, it's the same as your Ethernet address.) When you're connected to the Internet from your computer, a correspondence table relates your IP address to your computer's physical (MAC) address on the LAN.
- vSpace: NComputing Desktop Virtualization software
- PC: Personal Computer
- Router: in packet-switched networks such as the Internet, a router is a device or, in some cases, software in a computer, that determines the next network point to which a packet should be forwarded toward its destination. The router is connected to at least two networks and decides which way to send each information packet based on its current understanding of the state of the networks it is connected to.
- User: one who uses a computer system. Users may need to identify themselves for the purposes of accounting, security, logging and resource management. In order to identify oneself, a user has an account and a username.
- USB: (Universal Serial Bus) is a standard designed to allow peripherals to be connected to a computer using a standardized interface socket and to improve [plug-and-play](#) capabilities by allowing devices to be connected and disconnected without [rebooting](#) the computer.
- UTMA: Ultra Thin Multi Access

## FAQ

For the latest information and FAQ, please visit the NComputing online knowledge base at:

<http://www.ncomputing.com/support.aspx>

Q: Must the versions of the vSpace software in a network be the same?

A: Yes, different versions can cause data communication problems. Please keep all vSpace software updated with the latest version.

Q: When I start my access device, why is the server connection list blank? I have the vSpace software on a host PC in my network. I can connect to the host PC if I provision its IP address in the access device.

A: This condition occurs when the host and access devices are on independent subnets. The access device can run in this mode, but will never see the host PC in its server connection list.

Q: When I go to the device list in the administration console, why do some of my access devices never show up in the list?

A: This condition occurs when the host and access devices are on independent subnets. The access device can run in this mode, but its record will never appear in the administration console's device list.

Q: When I try to do a manual firmware update on the access device, why does it not connect to the host PC and download the firmware?

A: This condition occurs when the host and access devices are on independent subnets. An access device can run in this mode, but it can only download firmware updates when it is on the same subnet as the host PC.

Q: When I start my access device, why does it not automatically update its firmware from the host PC like my other access devices do?

A: This condition occurs when the host and access devices are on independent subnets. The access device can run in this mode, but it can only download firmware updates when it is on the same subnet as the host PC.

Q: I can't download any vSpace software updates.

A: Make sure that the software is registered and the correct TCP/IP ports are open (see "Product Registration" section).

Q: Why does a warning message appear when I install the vSpace software?

A: Windows provides a firewall that displays a security warning message when a new network port is used (see below). If you click the "Keep Blocking" button, you will not be able to find NComputing servers. If you select the "Unlock" button, the port will be open unless you block it manually. If you select the "Ask Me Later" button, the port will be open temporarily and the security message will continue to appear whenever the port is accessed.

Q: Can the product support 10Mbps or 1Gbps?

A: No, only 100Mbps is supported.

Q: What is transcoding?

A: Transcoding is the process of converting media formats from one type to another. This is a common technique used when wanting to optimize video for a given player or device. For instance, you may transcode some video to play on a mobile phone. vSpace has an efficient transcoding engine that converts video into a stream that can be locally decoded and displayed on the L300 device in real time, completely transparent to the end user.

Q: If a customer wants to publish video content optimized for the L300, what format is best?

A: Original content up to standard DVD resolution (D1 - 720x480) will have the best playback experience. Content may be encoded in many codecs, but if being distributed over the web, high compression H.264 or MPEG4 delivers small file sizes, but if size is not an issue, lower compression formats such as MPEG2 require less processing on the server. Please create a test clip in one of the supported formats mentioned in the Multimedia section and test it on your intended video player.

Q: The accelerated multimedia feature of the L300 sounds like simple multimedia redirection. How is this different?

A: Multimedia redirection found in terminal server products from Microsoft or Citrix simply send the entire media file over the network to be played by the client. This means that the client must have a full media player software stack and the necessary codecs to decode those files. This means that to achieve the same quality of video as the L300, a thin client must be 2-3X more expensive and require painful management of the local software stack to constantly ensure that codecs are loaded. Typically, this means the device needs to be similar to a full PC.

## Free Manuals Download Website

<http://myh66.com>

<http://usermanuals.us>

<http://www.somanuals.com>

<http://www.4manuals.cc>

<http://www.manual-lib.com>

<http://www.404manual.com>

<http://www.luxmanual.com>

<http://aubethermostatmanual.com>

Golf course search by state

<http://golfingnear.com>

Email search by domain

<http://emailbydomain.com>

Auto manuals search

<http://auto.somanuals.com>

TV manuals search

<http://tv.somanuals.com>