

NEC

COLOUR TELEVISION PF-51V21

INSTRUCTIONS

Thank you for your purchasing this NEC colour television.
To ensure your complete understanding, please read this manual thoroughly before operation.

Contents

1. Specifications	1	6. Control Your TV	6
2. Important safeguard	2	7. Tuning Procedure.....	9
3. Television Installation	3	8. Menu Operation	10
4. Control Panel	4	9. Trouble Shooting	13
5. Remote Control Hand Unit	5		

1 Specification

Television RF system	B, G
Colour System	PAL, NTSC 3.58/4.43(AV input only)
Channel and frequencies	VHF Low channel (VL) =46.25 to 168.25 MHz VHF high channel (VH) =175.25 to 463.25 MHz UHF channel U) =471.25 to 863.25 MHz
Power input	AC 240V, 50/60 Hz
Power consumption	Maximum 115W
Screen size (measured diagonally)	Picture tube 55 cm Visible area 51 cm
Audio output	5 W + 5 W (Rated output)
Speakers	(5 cm x 9 cm) oval x 2
External input/output	VIDEO inputs (RCA) at rear and front left AUDIO L/R inputs (RCA) at rear and front left S-Video input at rear VIDEO output (RCA) at rear AUDIO L/R output (RCA) at rear Headphone jack: mini jack (dia 3.5mm) at front left
Dimensions (WxHxD)	585 x 520 x 465
Weight	24.1 kg
Accessories	Remote control unit: RE-001 x 1 AAA/ R03 /UM-4 dry battery x 2

All specifications are subject to change without notice.

2 IMPORTANT SAFEGUARDS

Warning: To prevent fire or shock hazard, do not expose this TV set to rain or moisture.

LOCATION

Place the TV set on a flat, level surface and in a dry area free from dust and moisture. Do not place the unit in direct sunlight, or where it would be affected by smoke, steam, vibration or heat from heat radiating appliances. To prevent excessive internal temperature rise, place the unit so that there is at least 15 cm of space between it and the surrounding walls.

FIRE AND SHOCK PRECAUTIONS

- Adequate ventilation must be provided to prevent heat build up inside unit. Keep the inside of unit free from foreign objects, such as hairpins, nails, paper, etc. Do not build the set into a bookcase or other enclosures in which it would be poorly ventilated. Do not place it on carpet or a bed as low ventilation holes could become obstructed.
- Do not set liquids, including flower vases and vessels filled with chemicals or water etc., on top of the unit as liquid could get inside the unit. If a hazardous object falls inside the TV set, unplug it immediately and call a qualified technician for removal.
- When placing or moving the TV set, take care to insure that the power cord is fitted into the allocated slot. To avoid damage to the power cord, never allow heavy objects such as the TV set itself to be placed on the power cord. Keep cord away from heat radiating appliances. Do not allow cord to become knotted or tangled. Do not lengthen the cord. When removing the power plug from the socket, always hold onto the plug, never pull by the cord.

WARNING

- Do not remove the back cover of the TV set. Accidental contact with high voltage components could result in electric shock. When internal adjustment is necessary, please contact your distributor.
- If your set produces sound but no picture, or it emits smoke or produces a strange sound or smell, continued operation is dangerous. Immediately turn off power and remove the power plug from the socket and contact your distributor.
- During vacation or other occasions when you will not be using the set for an extended period, remove the power plug from the socket.
- This appliance should not be operated by children or infirm persons without adequate supervision.

CUSTOMER NOTICE

If a continual DISCOLOURATION or a COLOURED PATCH appears on your picture image, it may be caused by one of the following..

- External speakers placed near to the TV.
- Vacuum cleaners switched ON or OFF near the TV.
- Moving or rotating the position of the TV while it is turned on.
- The TV has been left in the STANDBY mode for some period of time, without being turned OFF using the front panel power button.

If this happens then...

1. Switch OFF the TV by using the FRONT PANEL POWER button.
2. Leave the TV switch OFF for at least 20 minutes.
3. Then switch ON the TV using the FRONT PANEL POWER button.

Note: You may need to repeat steps 1, 2 and 3 for the best result.

3 Television Installation Connect antenna or video facility

1. Use 75 Ω coaxial cable plug or 300-75 Ω impedance converter to plug in antenna input terminal on the rear of the cabinet.
2. Connect the video facility to the audio, video in jack on the rear of the cabinet.

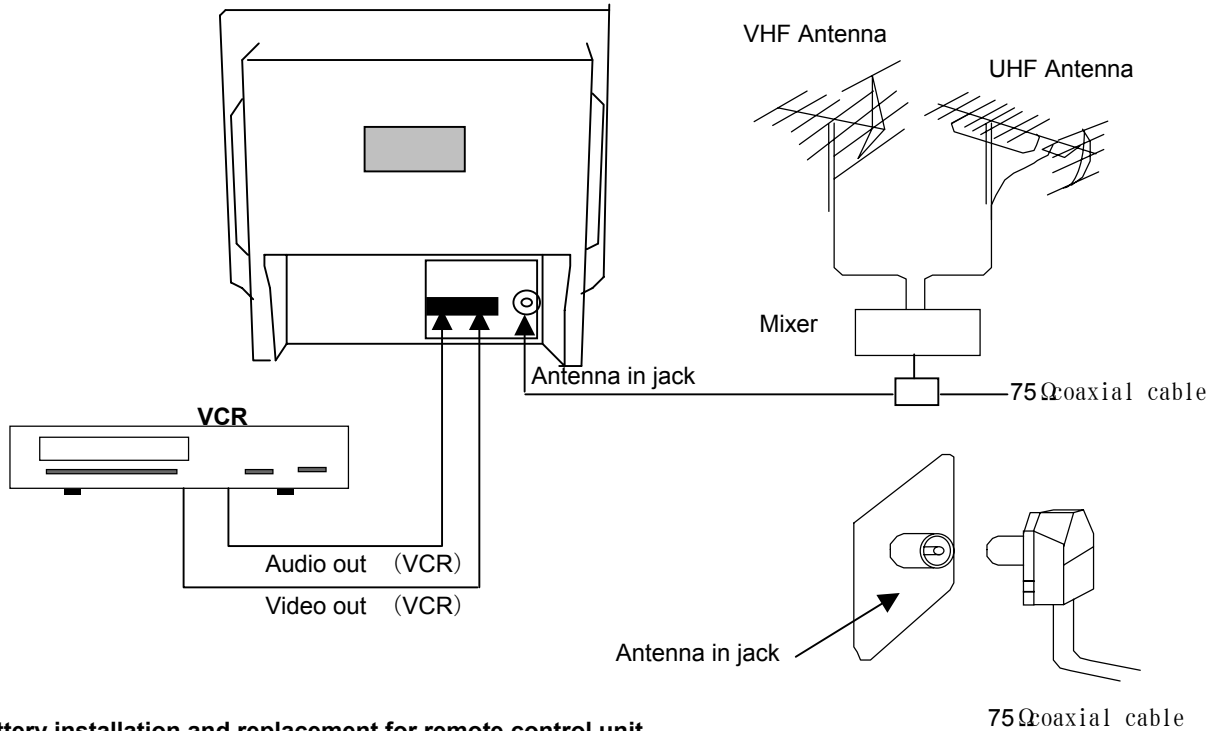

Battery installation and replacement for remote control unit.

The remote control unit uses two 1.5v AAA batteries. For battery installation and replacement see as follows:

1. Turn the remote control unit upside down. Press down the grip of the battery compartment and slide the cover in the direction of the arrow.
2. Install two new batteries, make sure that battery polarity matches with the (+)(-) marks inside the compartment, otherwise it would damage the unit.
3. Close the battery compartment cover.

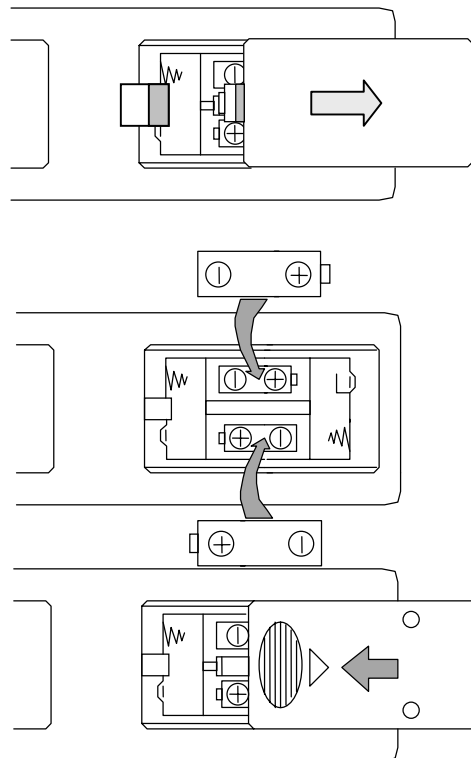

4 Control Panel

Front Controls

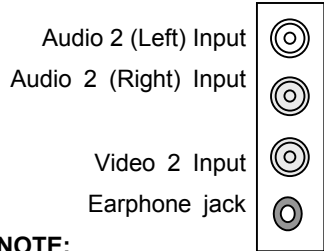

NOTE:

When plug in to this earphone jack, sound from speakers would not be muted.

Volume control for the earphone can be done independently.

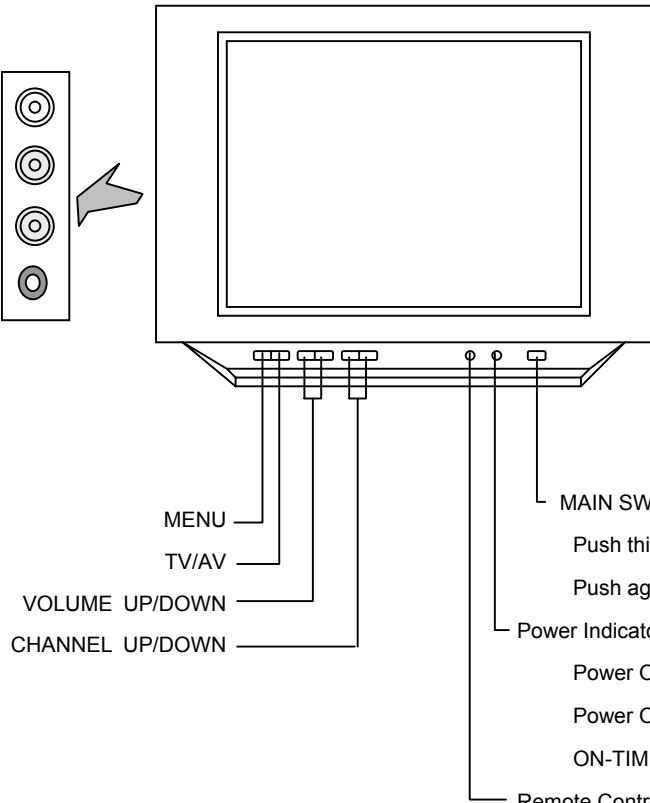

Rear Terminals

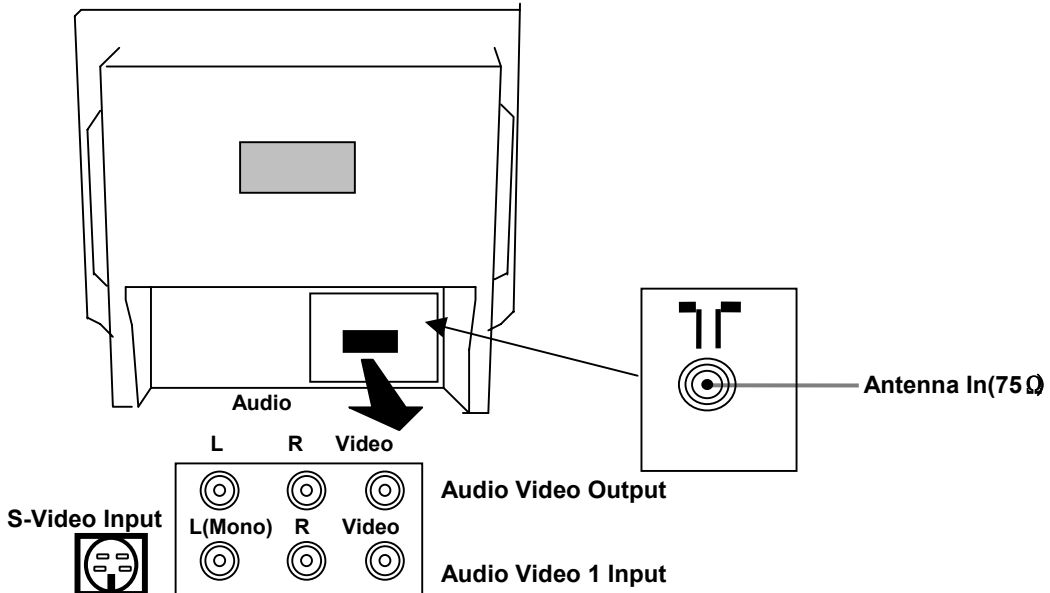

5 Remote Control Hand Unit

Please refer indicated pages.

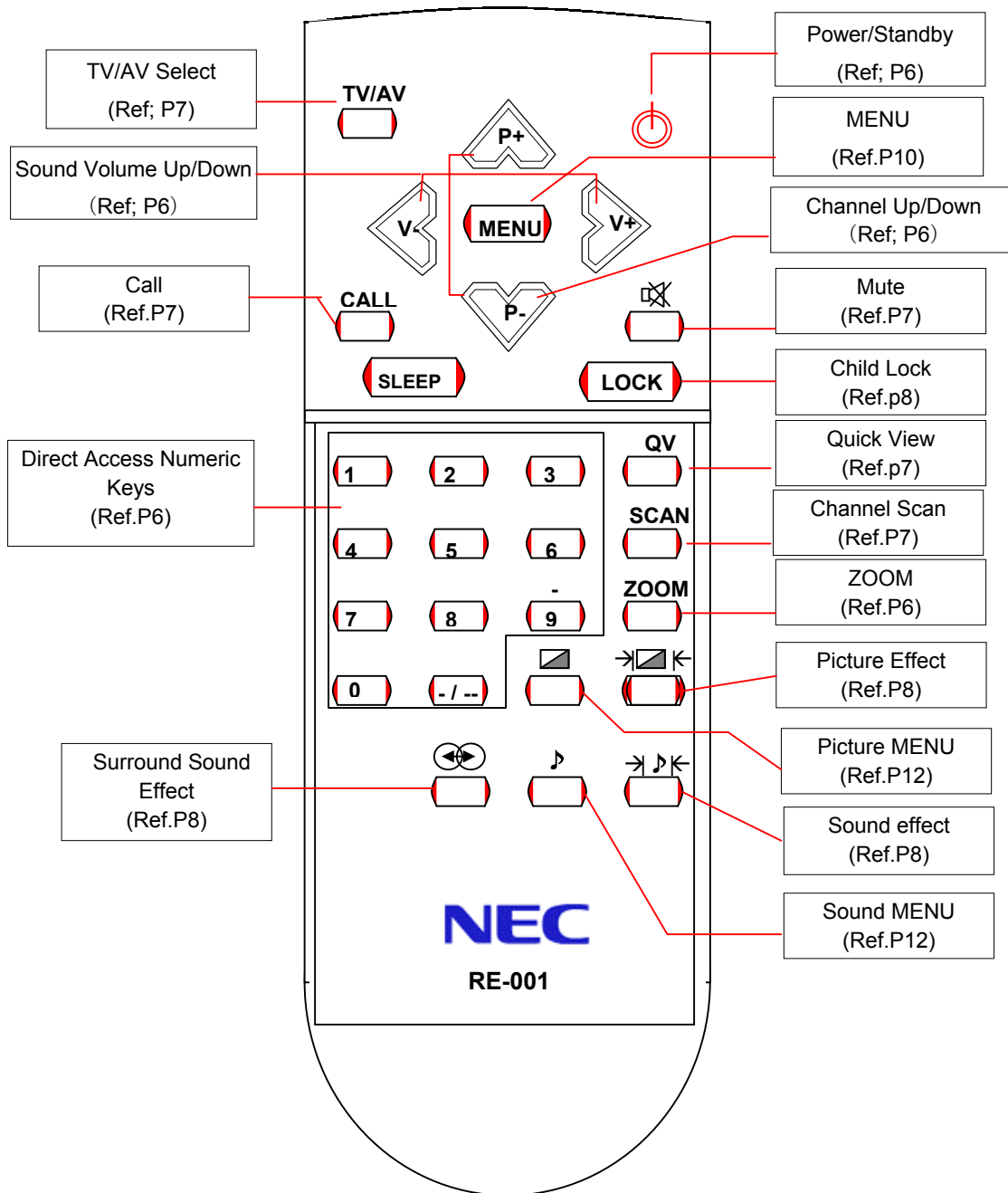

6 CONTROL YOUR TV

6-1 MAIN Power ON/OFF



※ This switch will turn the television ON/OFF totally.

With Mains status On, you can also turn off using Remote Control Hand Set.

This status is called Stand-By mode.

In this mode;

※ You can also turn ON the TV by pushing the Channel Up/Down keys on the front controls.

※ The TV has an Automatic Power OFF function. With No Signal condition, the TV will automatically turn OFF after 10 min.

6-2 Channel Up/Down

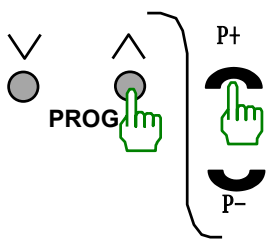

Push [P+] key, to change Channel Up

Push [P-] key, to change Channel Down.

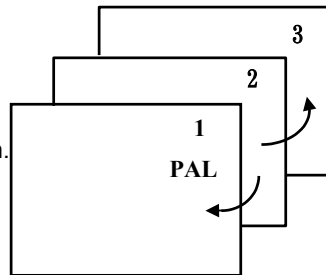

6-3 Direct Access Tuning

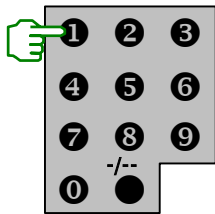

Using the numeric keys on Remote Control Hand Piece, Channels can be selected directly.

Or repeatedly press the “-/-” button, to select the desired mode then press numeric buttons.

“-” 1 digit mode

“- -” 2 digit mode

“- - -” 3 digit mode (Max Ch. 129)

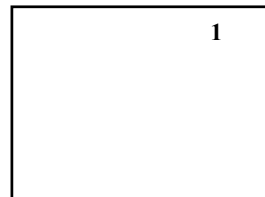

6-4 Volume Control

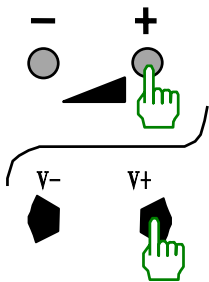

Push [V+] key, for Volume Up

Push [V-] key, for Volume Down

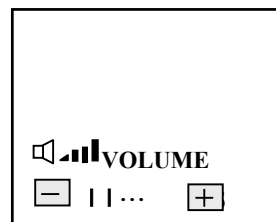

6-5 ZOOM



Push [ZOOM] key, to change as follows:

NORMAL → WIDE → ZOOM

WIDE — picture height is reduced.

ZOOM — picture height is expanded.

6-6

MUTE



By pushing this key, sound output will be muted.
Push [MUTE] again, or Volume Up/Down, and sound Volume will return.

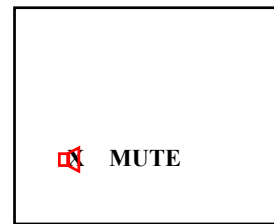

6-7

TV/AV Selection

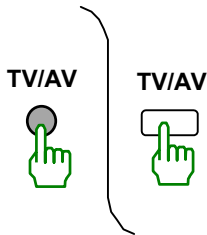

You can select your video source by the [TV/AV] key.

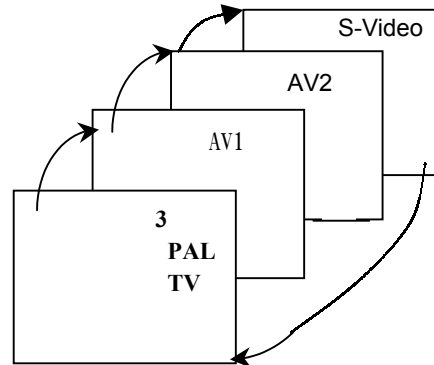

6-8

QUICK VIEW



TV Mode: Channel will quickly return to the previous Channel being watched.

AV Mode: Back to TV channel

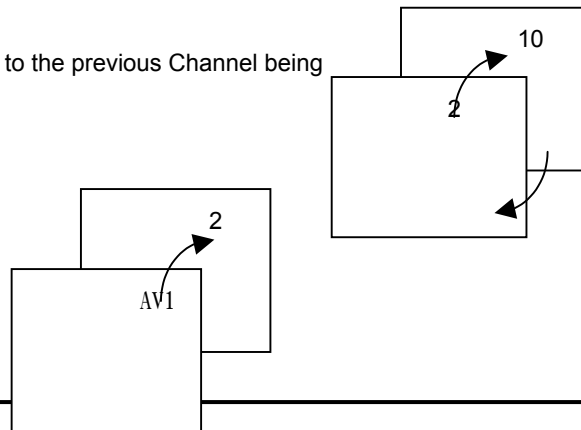

6-9

Channel Scanning



By pushing this key, Channels will change automatically
Each channel will be previewed for 3 seconds, and stop at original channel.
Skipped channels will not be previewed.

6-10

CALL



This key will call the On screen display.
Push again, to remove the on screen display.

OFF Timer and clock

(These two options appear after being set.)

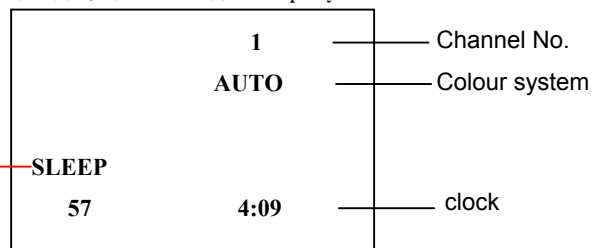

6-11



Picture EFFECT

By repeatedly pushing this key, picture effects will change as follows.

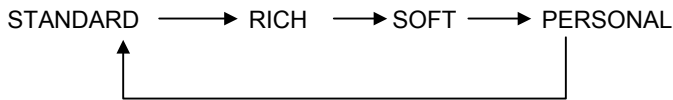

※ TINT setting is not included.

Personal is the last setting made by you.

6-12

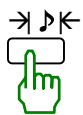

SOUND EFFECT

By repeatedly pushing this key, sound effects will change as follows:

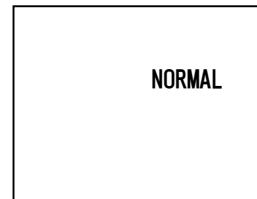

6-13



SURROUND SOUND EFFECT

By repeatedly pushing this key, surround sound effects will change as follows:

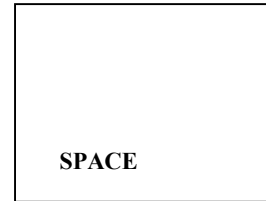
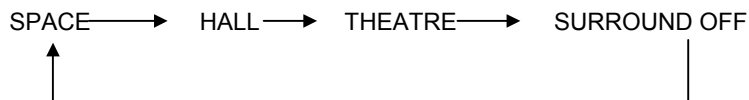

6-14



LOCK

By pushing the [LOCK] key, the lock screen will appear.

By pushing this key again for over 3 seconds continuously, LOCK situation will change.

In "LOCK On" status, front panel buttons will be locked, except when turned off by the same [LOCK] procedure.

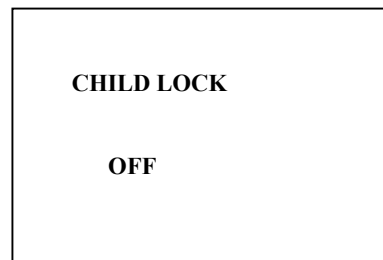

7 Tuning procedure

7-1 Auto Search Function: Automatic Search and Memory (ASM) is available for program installation from Antenna input.

Using [MENU] key on the front or [MENU] key on the Remote for ASM.

- Push [MENU] key repeatedly to select "PRESET"
- Push [P+] or [P-] key, to select "ASM"
- Push [V+] or [V-] key, to start ASM .
and memorize into program list (0~129).
- Wait until function has finished.

PRESET	
▶ ASM	
POSITION :	8
BAND :	UHF
SKIP :	OFF
AFT :	ON
FINE TUNING	
SEARCH	
SWAP	
◀ · I ·····	▶

7-2 SEARCH

- Push [MENU] key repeatedly to select "PRESET".
- Using [P+] or [P-] key, select "POSITION" .
Using [V+] or [V-] or numeric keys to change POSITION Number.
- Push [P+] or [P-] key to select "BAND" .
Push [V+] or [V-] key to change BAND.
- Push [P+] or [P-] key to select "SEARCH" .
- Push [V+] or [V-] key to start search.
- Wait until function has finished.

PRESET	
ASM	
POSITION :	8
BAND :	UHF
SKIP :	OFF
AFT :	ON
FINE TUNING	
◀ SEARCH	
SWAP	
◀ · I ·····	▶

7-3 FINE TUNING

- Push [MENU] key repeatedly to select "PRESET".
- Using [P+] or [P-] key, select "POSITION" .
Using [V+] or [V-] change POSITION.
- Using [P+] or [P-] key, select "FINE TUNING" .
- Using [V+] or [V-] key, adjust for best tuning.

PRESET	
ASM	
POSITION :	8
BAND :	UHF
SKIP :	OFF
AFT :	ON
◀ FINE TUNING	
SEARCH	
SWAP	
◀ · I ·····	▶

7-4 AFT Function: **Automatic Fine Tuning**
Keep Tuning at the best position., always.

- Push [MENU] key repeatedly to select "PRESET".
- Using [P+] or [P-] key, select "AFT" ,
Using [V+] or [V-] key, to set AFT ON or OFF.

7-5 SKIP Function: Use to “SKIP” Channels. After setting to “ON”, the channel will not be selected by Channel Up/Down keys.

- A. Push [MENU] key repeatedly to select “PRESET”
- B. Using [P+] or [P-] key, select “POSITION”.
Using [V+] or [V-] key, change POSITION.
- C. Using [P+] or [P-] key, select “SKIP” .
Using [V+] or [V-] key, select “ON” or “OFF” .

PRESET	
ASM	
POSITION :	8
BAND :	UHF
SKIP :	OFF
AFT :	ON
FINE TUNING	
SEARCH	
SWAP	
[] · I ·····	[+]

7-6 SWAP Function: Program Number and Channel exchange

- A. Push [MENU] key repeatedly to select “PRESET”.
- B. Using [P+] or [P-] key, select “SWAP”.
Using [V+] or [V-] key, enter to SWAP.
- C. Using [P+] or [P-] key, select “PROGRAM A”
or “PROGRAM B” .
- D. Using [V+] or [V-] key or numeric keys, change
“PROGRAM A №” or “PROGRAM B №”.
- E. Pushing [P+] or [P-] key, select “EXCHANGE”
Push [V+] or [V-] key repeatedly until “OK” is displayed
on screen. PROGRAM A and PROGRAM B are exchanged.

PRESET	
ASM	
POSITION :	8
BAND :	UHF
SKIP :	OFF
AFT :	ON
FINE TUNING	
SEARCH	
SWAP	
[] · I ·····	[+]

PROGRAM EXCHANGE	
PROGRAM A	6
PROGRAM B	2
EXCHANGE	OK

8 Menu Operation

8-1 [MENU] key on front

TV mode : Push [MENU] key continuously, to scroll through the MENU selection, as follows.

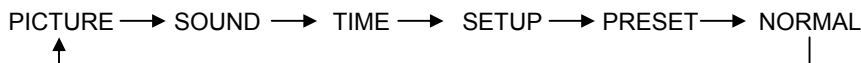

AV mode : Push [MENU] key continuously, to scroll through the MENU selection, as follows.



8-2 [MENU] key on the remote handset

TV mode : [MENU] key selects as follows:

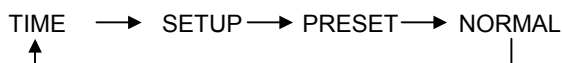

AV mode [MENU] key selects as follows:



8-3 TIME

(The ON/OFF timer cannot be set unless the clock has already been set.)

- A. Select "TIME" with the [MENU] key.
Using the [P+]/[P-] key, select the item.
- B. Using the [P+]/[P-] key, select "CLOCK", "OFF-TIME" or "ON-TIME"
- C. Using the [V+] key, minutes will increase from "00" to "59".
Using the [V-] key, hours will increase as follows;
"0,1...23,-- : --"
- D. Using [P+]/[P-] keys, select "POSITION"
Using [V+]/[V-] keys, change POSITION.
- E. Using [P+]/[P-] keys, select "ALARM"
Using [V+]/[V-] keys, ALARM timer can be set.
After presetting, preset time has come, alarm symbol will be displayed on screen.
The timer can be set "0" to "90" Minutes.

TIME	
● CLOCK	-- :--
OFF-TIME	-- :--
ON-TIME	-- :--
POSITION	-
ALARM	--

8-4 SETUP

Setup your TV as your favorite

- A. Using the [MENU] key, select SETUP.
Using the [P+]/[P-] keys, select the item.
- B. Using [P+]/[P-] keys, select "BLUE BACK" or "C-SYS" .
- C. Using the [V+] or [V-] keys, change to ON or OFF.
- D. Pushing [P+]/[P-], select "C-SYS".
Using the [V+]/[V-] keys, the colour system will be changed as follow:

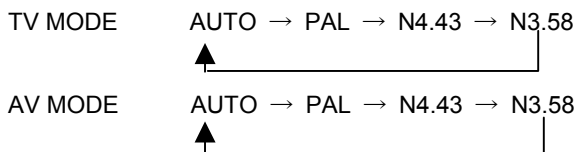

SETUP	
BLUE BACK	ON
C-SYS	AUTO

8-5 PICTURE MENU

Function: Brightness, Contrast, Colour Sharpness, Tint

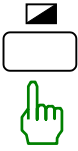

- By pushing the  key, Picture Menu will appear.
- Select each function using the [P+]/[P-] keys.
- Each value can be controlled by the [V+]/[V-] keys.
- Repeat any functions if required.

PICTURE	
● BRIGHT	32
CONTRAST	32
COLOUR	42
SHARP	32
TINT	32

- | | | + 32

NOTE: TINT control will be appeared only if a NTSC signal is being received.

8-6 SOUND MENU

Function: Bass, Treble, Balance.



- By pushing the  key, Sound Menu will appear.
- Select each function using the [P+]/[P-] keys.
- Each value can be controlled by the [V+]/[V-] keys.
- Repeat any functions if required.

SOUND	
● BASS	32
TREBLE	32
BALANCE	00
HEADPHONE	ON
HEADPHONE VOL	32

- | | | + 32

9 Trouble Shooting

Before arranging for service, firstly know the status and then check simply as follows:

Problems	Check
No picture or sound.	Check if the power supply is plugged in. Check if the power switch is in "on" position.
Picture is OK, no sound.	Check if the volume control is set to the minimum or mute position.
Remote control doesn't work.	Check if the power switch is in "on" position. Check if the batteries are out of use or not connected well. Make sure that there is no strong light striking the sensor window of remote control unit. Check there are no obstacles between the sensor window and remote control unit.
No TV signal.	Check if the TV/AV button is not set to TV status. Check if the antenna is well connected. Check if you installed the TV correctly.
No external video signal.	Check if you installed the TV correctly. Check if the TV/AV button is set to AV position.
Picture lacks colour or picture too dark.	Check colour, brightness and contrast controls are correctly adjusted.
All channels lose colour intermittently.	Check if the antenna is broken. Check if the antenna is disconnected. Check if the antenna is damaged.
Poor reception, loss of colour with certain channels.	Check if channels are correctly tuned (see "Fine tuning").
Diagonal stripes appear on picture.	The receiver may be affected by interference (e.g. from nearby radio broadcasting transmitter or from another TV receiver).
Picture has "snow".	Check if the antenna is broken. Check if the antenna is disconnected. Check if the antenna is damaged.
Ghost images appear.	Check if the antenna direction has been changed by a storm or strong wind, etc. (because ghost images are caused by the arrival at the antenna of both the signal which has traveled directly from the transmitter and the signal which has been reflected from a hill or a large building. The direction of the antenna should be chosen for minimized ghosting.)



NEC Australia Pty. Ltd.

ABN 14 004 803 490

Home Electronics Group

NEC Service Centres

NEW South Wales

Sydney	184 Milperra Rd, Revesby 2212	(02)9780 8688
Newcastle	120 Parry Street, Newcastle West 2302	(02)4926 2466

Victoria

Melbourne	480 Princes Highway, Noble Park 3174	(03)9554 6245
-----------	--------------------------------------	---------------

Queensland

Brisbane	116 Ipswich Rd, Woollongabba 4102	(07)3361 5858
Southport	Shop 1, 48 Ferry Rd, Southport 4215	(07)5591 3670

South Australia

Adelaide	84A Richmond Road, Keswick, 5053.	(08)8375 5710
----------	-----------------------------------	---------------

Western Australia

Perth	45 Sarich Court, Osborne Park 6017	(08)9446 5333
-------	------------------------------------	---------------

For Service in outer areas, please contact your NEC retailer for the address of the nearest Authorized NEC Service Centre.

NEC Australia Pty., Ltd.

244 Beecroft Road EPPING 2121

Tel. 131-632 Fax. (02) 9930 2380

Free Manuals Download Website

<http://myh66.com>

<http://usermanuals.us>

<http://www.somanuals.com>

<http://www.4manuals.cc>

<http://www.manual-lib.com>

<http://www.404manual.com>

<http://www.luxmanual.com>

<http://aubethermostatmanual.com>

Golf course search by state

<http://golfingnear.com>

Email search by domain

<http://emailbydomain.com>

Auto manuals search

<http://auto.somanuals.com>

TV manuals search

<http://tv.somanuals.com>