

PlasmaSync Plasma Monitor

PlasmaSync[™] 42PD2/50PD1

User's Manual



NEC

NEC Technologies

Important Information

Precautions

Please read this manual carefully before using your NEC Plasma Monitor and keep the manual handy for future reference.

CAUTION



**RISK OF ELECTRIC SHOCK
DO NOT OPEN**



CAUTION: TO REDUCE THE RISK OF ELECTRIC SHOCK, DO NOT REMOVE COVER. NO USER-SERVICEABLE PARTS INSIDE. REFER SERVICING TO QUALIFIED SERVICE PERSONNEL.

This symbol warns the user that uninsulated voltage within the unit may have sufficient magnitude to cause electric shock. Therefore, it is dangerous to make any kind of contact with any part inside of this unit.

This symbol alerts the user that important literature concerning the operation and maintenance of this unit has been included. Therefore, it should be read carefully in order to avoid any problems.

WARNING

TO PREVENT FIRE OR SHOCK HAZARDS, DO NOT EXPOSE THIS UNIT TO RAIN OR MOISTURE. ALSO DO NOT USE THIS UNIT'S POLARIZED PLUG WITH AN EXTENSION CORD RECEPTACLE OR OTHER OUTLETS, UNLESS THE PRONGS CAN BE FULLY INSERTED. REFRAIN FROM OPENING THE CABINET AS THERE ARE HIGH-VOLTAGE COMPONENTS INSIDE. REFER SERVICING TO QUALIFIED SERVICE PERSONNEL.

DOC compliance Notice

This Class A digital apparatus meets all requirements of the Canadian Interference-Causing Equipment Regulations.

WARNING

This equipment has been tested and found to comply with the limits for a Class A digital device, pursuant to Part 15 of the FCC Rules. These limits are designed to provide reasonable protection against harmful interference when the equipment is operated in a commercial environment. This equipment generates, uses, and can radiate radio frequency energy and, if not installed and used in accordance with the instruction manual, may cause harmful interference to radio communications. Operation of this equipment in a residential area is likely to cause harmful interference in which case the user will be required to correct the interference at his own expense.

Warnings and Safety Precaution

The NEC plasma monitor is designed and manufactured to provide long, trouble-free service. No maintenance other than cleaning is required. Use a soft dry cloth to clean the panel. Never use solvents such as alcohol or thinner to clean the panel surface.

The plasma display panel consists of fine picture elements (cells). Although NEC produces the plasma display panels with more than 99.99 percent active cells, there may be some cells that do not produce light or remain lit.

For operating safety and to avoid damage to the unit, read carefully and observe the following instructions. To avoid shock and fire hazards:

1. Provide adequate space for ventilation to avoid internal heat build-up. Do not cover rear vents or install in a closed cabinet or shelves.
The unit is equipped with cooling fans. If you install the unit in an enclosure, be sure there is adequate space at the top of the unit to allow hot air to rise and escape. If the monitor becomes too hot, the overheat protector will be activated and the monitor will be turned off. If this happens, turn off the power to the monitor and unplug the power cord. If the room where the monitor is installed is particularly hot, move the monitor to a cooler location, and wait for the monitor to cool for 60 minutes. If the problem persists, contact your NEC dealer for service.
2. Do not use the power cord polarized plug with extension cords or outlets unless the prongs can be completely inserted.
3. Do not expose unit to water or moisture.
4. Avoid damage to the power cord, and do not attempt to modify the power cord.
5. Unplug unit during electrical storms or if unit will not be used over a long period.
6. Do not open the cabinet which has potentially dangerous high voltage components inside. If the unit is damaged in this way the warranty will be void. Moreover, there is a serious risk of electric shock.
7. Do not attempt to service or repair the unit. NEC is not liable for any bodily harm or damage caused if unqualified persons attempt service or open the back cover. Refer all service to authorized NEC Service Centers.
8. Do not attempt to install or mount the unit yourself. Please contact your NEC dealer for installation.

NOTE:

When you connect a computer to this monitor, attach the supplied ferrite cores. If you do not do this, this monitor will not conform to mandatory FCC standards. Attaching the ferrite cores.

Set the ferrite cores on the both ends of the DVI cable (not supplied), and the one end of the power cable (supplied).

Close the lid tightly until the clamps click.

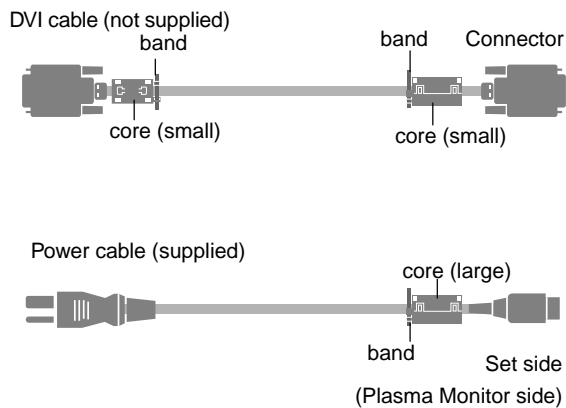

To avoid damage and prolong operating life:

1. Use only with 120V 50/60Hz AC power supply. Continued operation at line voltages greater than 120 Volts AC will shorten the life of the unit, and might even cause a fire hazard.
2. Handle the unit carefully when installing it and do not drop.
3. Locate set away from heat, excessive dust, and direct sunlight.
4. Protect the inside of the unit from liquids and small metal objects. In case of accident, unplug the unit and have it serviced by an authorized NEC Service Center.
5. Do not hit or scratch the panel surface as this causes flaws on the surface of the screen.
6. As is the case with any phosphor-based display (like a CRT monitor, for example) light output will gradually decrease over the life of a Plasma Display Panel.

Recommendations to avoid or minimize phosphor burn-in

Like all phosphor-based display devices and all other gas plasma displays, PlasmaSync monitors can be susceptible to phosphor burn under certain circumstances. Certain operating conditions, such as the continuous display of a static image over a prolonged period of time, can result in phosphor burn if proper precautions are not taken. To protect your investment in this NEC PlasmaSync monitor, please adhere to the following guidelines and recommendations for minimizing the occurrence of image burn:

- * Always enable and use your computer's screen saver function during use with a computer input source.
- * Display a moving image whenever possible.
- * Always power down the monitor when you are finished using it.

NEC has built-in several operating modes in your PlasmaSync PD Series monitor to help you reduce the likelihood of phosphor burn. These are called the AccuShield Phosphor Protection System. If the Plasmasync monitor is in long-term use or continuous operation, use the functions available in AccuShield to reduce the likelihood of perceptible phosphor burn or to diminish its perceptible effects if it occurs. See pages 42,44 and 45 for instructions on how to use the Orbiter, Low Brightness and Inverse RGB modes of AccuShield.

- * Lower the Brightness and Contrast levels as much as possible without impairing image readability. (See page 24, 29)
- * Display an image with many colors and color gradations (ie. photographic or photo-realistic images).
- * Create image content with minimal contrast between light and dark areas, for example white characters on black backgrounds. Use complementary or pastel color whenever possible.
- * Avoid displaying images with few colors and distinct, sharply defined borders between colors.

Contact NEC Technologies at 1-800-836-0655 for other recommended procedures that will best suit your particular application needs.

Précautions

Veillez lire ce manuel avec attention avant d'utiliser votre PlasmaSync NEC moniteur et conserver ce manuel à portée de la main pour une consultation ultérieure.

ATTENTION



**RISQUE D'ELECTROCUTION
NE PAS OUVRIR**



MISE EN GARDE: AFIN DE REDUIRE LES RISQUES D'ELECTROCUTION, NE PAS DEPOSER LE COUVERCLE, IL N'Y A AUCUNE PIECE UTILISABLE A L'INTERIEUR DE CET APPAREIL. NE CONFIER LES TRAVAUX D'ENTRETIEN QU'A UN PERSONNEL QUALIFIE.

Ce symbole a pour but de prévenir l'utilisateur de la présence d'une tension dangereuse, non isolée se trouvant à l'intérieur de l'appareil. Elle est d'une intensité suffisante pour constituer un risque d'électrocution. Eviter le contact avec les pièces à l'intérieur de cet appareil.

Ce symbole a pour but de prévenir l'utilisateur de la présence d'importantes instructions concernant l'entretien et le fonctionnement de cet appareil. Par conséquent, elles doivent être lues attentivement afin d'éviter des problèmes.

AVERTISSEMENT

AFIN DE REDUIRE LES RISQUES D'INCENDIE OU D'ELECTROCUTION, NE PAS EXPOSER CET APPAREIL A LA PLUIE OU A L'HUMIDITE. AUSSI, NE PAS UTILISER LA FICHE POLARISEE AVEC UN PROLONGATEUR OU UNE AUTRE PRISE DE COURANT SAUF SI CES LAMES PEUVENT ETRE INSEREES A FOND. NE PAS OUVRIR LE COFFRET, DES COMPOSANTS HAUTE TENSION SE TROUVENT A L'INTERIEUR. LAISSER A UN PERSONNEL QUALIFIE LE SOIN DE REPARER CET APPAREIL.

DOC avis de conformation

Cet appareil numérique de la classe A respecte toutes les exigences du Règlement sur le Matériel Brouilleur du Canada.

AVERTISSEMENT

Cet équipement a été testé et certifié conforme avec les limitations des équipements numériques de Classe A, conformément à l'article 6 (du règlement FCC. Ces limites sont conçues pour assurer une protection raisonnable contre les interférences nuisibles lorsque l'équipement est utilisé en milieu commercial. Cet équipement génère, utilise, et peut produire de l'énergie de fréquence radio et, s'il n'est pas installé et utilisé selon le manuel d'instruction, peut provoquer des interférences nuisibles aux communications radio. L'utilisation de cet équipement dans une zone résidentielle est susceptible de provoquer des interférences nuisibles, dans quel cas l'utilisateur est tenu de remédier à ces interférences à ses frais.

Mises en garde et précautions de sécurité

Le moniteur PlasmaSync NEC a été conçu et fabriqué pour une utilisation fiable et durable. Il ne nécessite aucun entretien en dehors du nettoyage. Utiliser un chiffon doux et sec pour nettoyer la surface de l'écran. Ne jamais utiliser de solvant comme l'alcool ou le diluant. Le panneau à affichage plasma est constitué de fines particules d'images ou pixels (cellules). Bien que NEC produise des panneaux à affichage plasma avec plus de 99,99 % de cellules actives, il peut y avoir des cellules qui ne produisent pas de lumière ou qui restent allumées.

Pour des raisons de sécurité et pour éviter d'endommager l'appareil, lire attentivement les instructions suivantes.

Pour éviter les risques d'électrocution et d'incendie:

1. Laisser suffisamment d'espace autour de l'appareil pour la ventilation et éviter toute augmentation excessive de la température interne. Ne pas couvrir les événements ou l'installer dans un endroit trop exigü. L'appareil est équipé de ventilateurs de refroidissement. Si vous installez l'appareil dans un espace clos, assurez-vous qu'il y ait suffisamment d'espace au dessus pour permettre à l'air chaud de s'élever et de s'évacuer. Si la température du moniteur devient excessive, la protection contre les surchauffes entrera en action et coupera l'alimentation. Dans ce cas, éteindre l'appareil et débrancher le câble d'alimentation. Si la température de la pièce dans laquelle le moniteur est installé est particulièrement excessive, déplacer l'appareil dans un endroit plus frais et le laisser refroidir 60 minutes. Si le problème persiste, prendre contact avec le revendeur NEC pour le service après-vente.
2. Ne pas utiliser la fiche polarisée du cordon d'alimentation avec des prolongateurs ou des prises de courant, sauf si les lames peuvent être insérées à fond.
3. Ne pas exposer à l'eau ou à l'humidité.
4. Eviter d'endommager le cordon d'alimentation, et ne pas modifier le cordon d'alimentation.
5. Débrancher l'appareil pendant les tempêtes ou si l'appareil n'est pas utilisé pendant une longue période.
6. Ne pas ouvrir le coffret. Des composants de haute tension se trouvent à l'intérieur. Si l'appareil est endommagé de cette manière, la garantie devient caduque. De plus, il y a risque d'électrocution.
7. Ne pas essayer de réparer ou entretenir l'appareil soi-même. NEC ne saura être tenu pour responsable pour toute blessure ou dommage causé par des personnes non qualifiées qui essaient de réparer ou d'ouvrir le couvercle arrière. Confier toute réparation à un centre de service agréé NEC.
8. N'essayez pas d'installer ou d'assembler l'appareil vous-mêmes. Veuillez contacter votre revendeur NEC pour l'installation.

REMARQUE:

Lorsque vous branchez un micro-ordinateur sur ce moniteur, fixez les noyaux en ferrites fournis. Si vous ne le faites, le moniteur ne sera pas en conformité avec les exigences des standards FCC.

Fixation des noyaux en ferrite.

Installez les noyaux en ferrite sur chaque bout du câble DVI (non fourni), ainsi que sur un côté du câble d'alimentation électrique (fourni).

Fermez doucement le couvercle jusqu'à ce que les crans se clipsent.

Utilisez le collier plastique pour fixer la tore en ferrite.

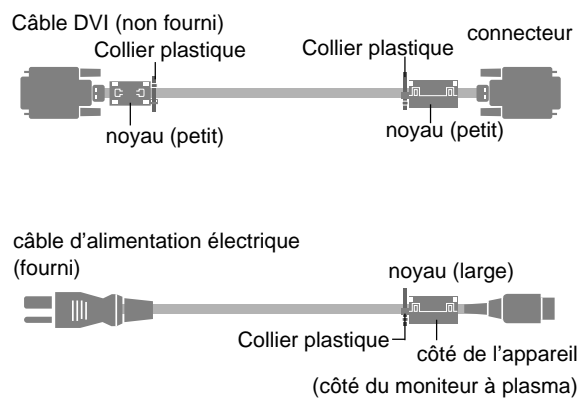

Pour éviter des dommages et prolonger la durée de service de l'appareil:

1. N'utiliser qu'une source d'alimentation de 120 V 50/60 Hz CA. Le fait d'utiliser l'appareil en continu à des tensions de ligne supérieures à 120 Volts CA réduit sa durée de vie et risque de provoquer un incendie.
2. Manipuler l'appareil avec soin pendant son déplacement et ne pas le faire tomber.
3. Eloigner l'appareil des endroits chauds, très poussiéreux et exposés en plein soleil.
4. Éviter que des liquides et des petits objets métalliques pénètrent à l'intérieur de l'appareil. En cas d'accident, débrancher l'appareil et le confier à un centre de service agréé NEC.
5. Ne pas frapper ou rayer la surface de la écran plasma, car des défauts risquent de se produire sur la surface de la écran plasma.
6. Comme c'est le cas pour tout affichage à base de phosphore (comme un moniteur CRT, par exemple), la puissance de lumière baisse graduellement au cours de la vie du Panneau d'Affichage à Plasma.

Pour éviter le risque de combustion au phosphore, les mesures suivantes sont recommandées :

Comme tous les appareils d'affichage à base de phosphore et tous les autres affichages à gaz plasma, les moniteurs Plasmasync peuvent être sujets à la combustion au phosphore dans certaines circonstances. Certaines conditions d'utilisation, telles que l'affichage continu d'une image statique pour une durée prolongée, peuvent causer des brûlures au phosphore si aucune précaution n'est prise. Pour protéger votre investissement dans ce moniteur PlasmaSync NEC, veuillez suivre les directives et les recommandations suivantes pour minimiser l'occurrence de brûlure d'image :

- Assurez-vous de mettre en marche et d'utiliser l'économisateur d'écran chaque fois que c'est possible lorsque vous l'utilisez avec une source d'entrée d'ordinateur.
- Affichez une image en mouvement aussi souvent que possible.
- Coupez toujours l'alimentation lorsque vous avez terminé d'utiliser la moniteur.

Si le PlasmaSync moniteurs est en usage continu ou longue durée, prenez les mesures suivantes afin d'éviter l'occurrence de combustion au phosphore :

- Abaissez le niveau de l'image (contraste, luminosité) autant que possible, sans faire perdre la lisibilité de l'image.
- Affichez une image avec de nombreuses couleurs et graduations de couleur (par ex. des images photographiques ou photo-réalistes).
- Créez un contenu d'image avec un contraste minimal entre les zones sombres et les zones claires, par exemple, des caractères blancs sur un fond noir. Utilisez des couleurs complémentaires ou pastels le plus souvent possible.
- Évitez d'afficher des images avec peu de couleurs et des limites nettes et clairement définies entre les couleurs.

Contactez NEC Technologies au 1-800-836-0655 pour d'autres procédures recommandées qui conviendront le mieux au besoin de votre appareil.

Limited Warranty Plasma Monitors

NEC Technologies, Inc. (hereinafter NECTECH) warrants this product to be free from defects in material and workmanship under the following terms and, subject to the conditions set forth below, agrees to repair or replace (at NECTECH's sole option) any part of the enclosed unit which proves defective. Replacement parts or products may be new or refurbished and will meet specifications of the original parts or product.

HOW LONG IS THE WARRANTY?

Parts and labor are warranted for (1) One Year from the date of the first customer purchase.

WHO IS PROTECTED?

This warranty may be enforced only by the first purchaser.

WHAT IS COVERED AND WHAT IS NOT COVERED

Except as specified below, this warranty covers all defects in material or workmanship in this product. The following are not covered by the warranty:

1. Any product which is not distributed in the U.S.A. or Canada and Mexico by NECTECH or which is not purchased in the U.S.A. or Canada or Mexico from an authorized NECTECH dealer.
2. Any product on which the serial number has been defaced, modified or removed.
3. Damage, deterioration or malfunction resulting from:
 - a. Accident, misuse, abuse, neglect, fire, water, lightning or other acts of nature, unauthorized product modification, or failure to follow instructions supplied with the product.
 - b. Repair or attempted repair by anyone not authorized by NECTECH.
 - c. Any shipment of the product (claims must be presented to the carrier).
 - d. Removal or installation of the product.
 - e. Any other cause which does not relate to a product defect.
 - f. Burns or residual images upon the phosphor of the panel.
4. Cartons, carrying cases, batteries, external cabinets, magnetic tapes, or any accessories used in connection with the product.
5. Service outside of the U.S.A. , Canada and Mexico.

WHAT WE WILL PAY FOR AND WHAT WE WILL NOT PAY FOR

We will pay labor and material expenses for covered items, but we will not pay for the following:

1. Removal or installation charges.
2. Costs of initial technical adjustments (set-up), including adjustment of user controls. These costs are the responsibility of the NECTECH dealer from whom the product was purchased.
3. Payment of shipping charges.

HOW YOU CAN GET WARRANTY SERVICE

1. To obtain service on your product, consult the dealer from whom you purchased the product.
2. Whenever warranty service is required, the original dated invoice (or a copy) must be presented as proof of warranty coverage. Please also include in any mailing your name, address and a description of the problem(s).
3. For the name of the nearest NECTECH authorized service center, call NECTECH at 800-836-0655.

LIMITATIONS OF LIABILITY

Except for the obligations specifically set forth in this warranty statement, we will not be liable for any direct, indirect, special, incidental, consequential, or other types of damages, whether based on contract, tort, or any other legal theory, whether or not we have been advised of the possibility of such damages.

This warranty is in lieu of all other warranties express or implied, including, but not limited to, the implied warranties of merchantability or fitness for a particular purpose.

EXCLUSION OF DAMAGES

NECTECH's liability for any defective product is limited to the repair or replacement of the product at our option. NECTECH shall not be liable for:

1. Damage to other property caused by any defects in this product, damages based upon inconvenience, loss of use of the product, loss of time, commercial loss; or
2. Any other damages whether incidental, consequential or otherwise. Some states do not allow limitation on how long an implied warranty lasts and/or do not allow the exclusion or limitation of incidental or consequential damages, so the above limitations and exclusions may not apply to you.

HOW STATE LAW RELATES TO THE WARRANTY

This warranty gives you specific legal rights, and you may also have other rights which vary from state to state.

FOR MORE INFORMATION, TELEPHONE 800-836-0655

NEC TECHNOLOGIES, INC.

1250 N. Arlington Heights Road, Suite 500
Itasca, Illinois 60143-1248

Note: All products returned to NECTECH for service MUST have prior approval. To get approval, call NEC Technologies at 800-836-0655.

Contents

How to Attach Options to the Plasma Monitor	8
Introduction	
Introduction to the PlasmaSync 42PD2/50PD1	9
The features you'll enjoy include	9
Contents of the Package	9
OPTIONS	9
Setup Procedure	10
Part Names and Functions	
Front View	12
Side View Terminal Board L/R	13
Remote Controller	14
Battery Installation and Replacement	15
Operating Range / Using the wired remote control mode	16
Making the DIP Switch Settings	
DIP Switch Functions and Settings	17
Power Management Function	18
Power Management Modes	18
Installation	
Wiring Diagram	19
Connecting Your PC or Macintosh Computer	20
Connections with Equipment that has a Digital Interface	20
Connecting Your VCR or Laser Disc Player	20
Connecting Your Document Camera	20
Daisy-chaining Your monitors	21
Operation	
Power/General Controls/Adjustment of the Display	22
Adjustment of the Display (Direct)	23
Returning the Screen Adjustment to the Factory Default Settings (NORMAL)	23
Adjustment of the Image	24
Returning the Image Adjustments to the Factory Default Settings (NORMAL)	24
Adjustment of the Display (Menu Control)	
List of Setting Details	25
Before Making Adjustments	26
To Reset the Adjustment Value (to the Factory Default Setting) During the Setting	27
Adjustment of the Image (Visual Controls)	29
Adjustment of Screen Position (Horizontal)	30
Adjustment of Screen Position (Vertical)	31
Color Temperature	32
Adjustment of the White Balance	33
Adjustment of the On-screen Display Position	34
Setting the On-screen Display OFF Time	35
Adjustment of the Clock Frequency/Clock Phase (AUTO PICTURE)	36
Normal Screen	37
Next Page Screen	38
Information Screen	39
Timer Screen	40
Auto Timer Screen	41
Multiple Screens	43
Other Setting Screens (1)	44
Other Setting Screens (2)	45
Set Selection Screen for Allotting ID Numbers to Multiple Screens/Each Set	46
Troubleshooting	47
Specifications	48
Appendix	
Signal Identification For Raster Preset	50
Pin Configuration and Signal Level of mini D-Sub 15-Pin (Analog) Input Connector	51
Pin Configuration and Signal of the RGB 3 IN Connector (DVI Connector)	51
Function and Pin Configuration of the External Control Connector	52
Cabinet dimensions	63

How to Attach Options to the Plasma Monitor

You can attach your optional mounts or stand to the plasma monitor in one of the following two ways:

- * In the upright position. (See Drawing A)
- * Lay the screen face down (See Drawing B). Lay the protective sheet, which was wrapped around the monitor when it was packaged, beneath the screen surface so as not to scratch the screen face.

This device cannot be used or installed without a separate Tabletop Stand or other optional mounting accessory. For proper installation it is strongly recommended to use a trained, NEC authorized serviceman. Failure to follow correct mounting procedures could result in damage to the equipment or injury to the user or installer. Product warranty does not cover damage caused by improper installation. Failure to follow these recommendations could result in voiding your warranty.

Drawing A

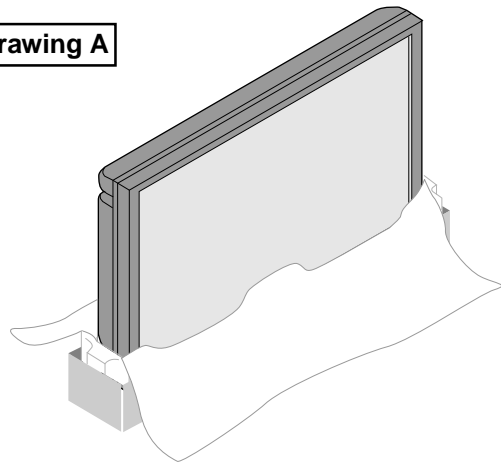

Drawing B

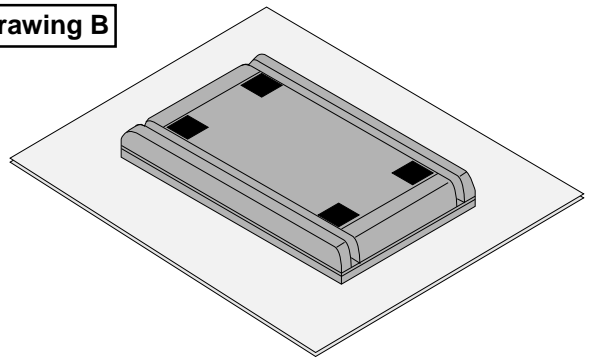

Ventilation Requirements for enclosure mounting

To allow heat to disperse, leave space between surrounding objects as shown in the diagram to the right.

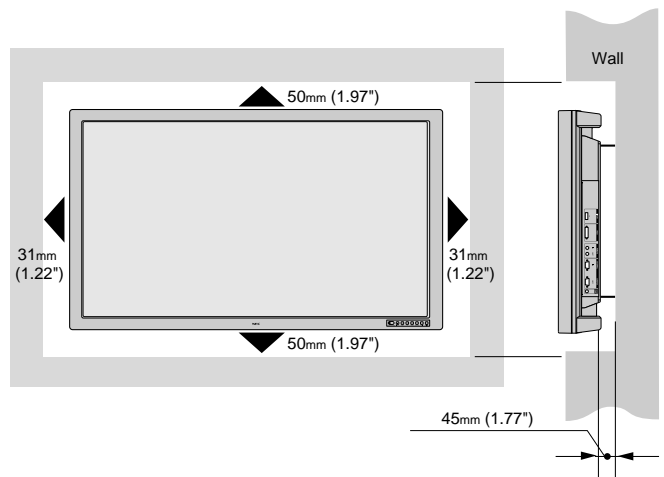

Pulling Out and Reinserting the Retractable Feet

The Retractable Feet are housed at 2 locations on the bottom surface of the main unit.

1. Grasp the end and pull out.
2. The feet will open automatically when your hand is removed.

To house the Retractable Feet, close them and then continue to push them inside the main unit.

Notice:

- * Installation of only the main unit is not possible. Be sure to use and install the main unit in conjunction with a stand or special unit.

Note:

RETRACTABLE FEET ARE FOR TEMPORARY USE ONLY AND ARE NOT INTENDED FOR PERMANENT INSTALLATION.
 MODEL # PX-42VPU1-ST STAND IS REQUIRED FOR PERMANENT TABLETOP INSTALLATION.
 REPLACE THE FEET WHEN YOU MOVE THE MONITOR.

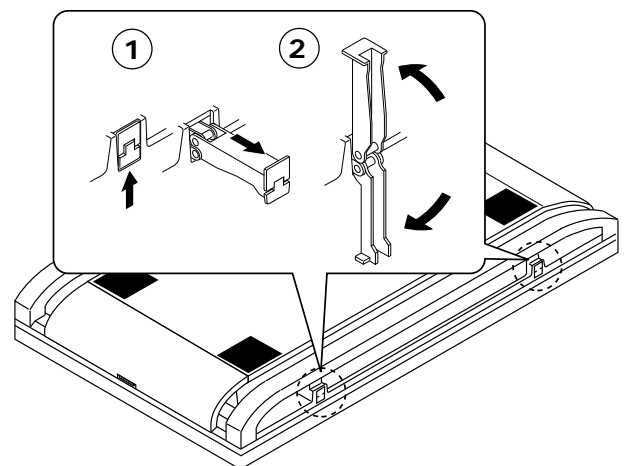

Introduction

OSM and IPM are trademarks of NEC Technologies, Inc. IBM PC/AT, PS/2, VGA, S-VGA, 8514/A and XGA are registered trademarks of International Business Machines Corporation.

Apple and Macintosh are registered trademarks of Apple Computer, Inc.

Microsoft is a registered trademark of Microsoft Corporation. Windows is a trademark of Microsoft Corporation.

Introduction to the PlasmaSync 42PD2/50PD1

This section introduces you to your new PlasmaSync 42PD2/50PD1, provides a list of materials that comes with your monitor and describes the features and controls.

The features you'll enjoy include:

- * This unit can be used with IBM PC/AT, Macintosh, and compatibles.

(For details, see "Factory Setting Values Preset Table." Pg.50)

- * Easy-to-operate multifunction remote control and external control connector

A single remote control can be used as a wireless or as a wired remote control (with automatic switching by cable connection) and the remote THROUGH OUT connector permits simultaneous operation of multiple monitors.

(A maximum of 3 units can be connected.)

The external control connector with a THROUGH OUT feature permits various control functions to be made externally.

- * ID No. settings can be made for up to 256 units.
- * NTSC, PAL, SECAM, and M-NTSC composite video signals can be accommodated

Video signals from video cameras, video decks, video disc players, and other video equipment adhering to NTSC as well as PAL, SECAM, and M-NTSC (with a 4.43 MHz chroma signal) standards can be selected on screen.

- * Varied set of input connectors

Video input signals: BNC video connector, S video connector. Each type is equipped with its own THROUGH OUT connector, single system.

Analog RGB input: mini D-Sub 15-pin connector, BNC (R, G, B, H/CS, V connectors). BNC is equipped with its own THROUGH OUT connector, single system.

- * Can be used with Digital RGB input (DVI standard compliant)
- * Can be used with multiple screens
- * Power management function

RGB3 input mode complies with DMPM (Digital Monitor Power Management) of DVI.

A great reduction in power consumption when not being used is achieved through the VESA-proposed DPMS system.

The unit can also be used with the Energy Star standard (in which case power consumption will be 15 W or less when not being used).

- * The personal computer and the operating system that are to be connected must be compatible with VESA DPMS. Personal computers that are to be connected to the RGB3 input must be compatible with DVI DMPM.

- * OSM (On Screen Manager) function

The OSM function displays a variety of screen adjustment and correction menus on the screen to allow fine settings to be made.

- * Plug and Play compatible

The RGB3 input is compatible with DDC2B only.

Ready to be used with Plug and Play which are supported by Windows 98 and Windows 95.

(VESA DDC1 and DDC2 level B)

- * Windows 98 or Windows 95 and a personal computer with VESA DDC are required to use Plug and Play.

- * Can be used with RS-232C

Contents of the Package

The following lists all of the items included in your Plasma Sync monitor package. Please save the original box and packing materials for future transportation or shipment of this monitor.

1. PlasmaSync 42PD2/50PD1
2. Power cord
3. Wireless/Wired remote control unit and two AAA batteries
4. Remote cable
5. RGB cable (15-Pin mini D-Sub To 15-pin mini D-Sub Connector)
6. User's manual
7. Core (large) and two cores (small)

Setup Procedure

1. Determine the installation location
 - * To ensure safe use, see “Before Use” and “Observe the Following,” then install properly.
2. Connect the equipment
 - Set the termination switch (75Ω/high impedance).
 - Set the DIP switches to suit the application and system structure. (See Page 17.)
 - (Loop-out connections are for one unit, maximum.)
3. Install the remote control batteries.
 - * To use the remote control in the wired arrangement, connect the supplied remote control cable.
4. Connect the supplied power cable
 - * The maximum current rating 5.6(A) : 42PD2
 - * The maximum current rating 7.4(A) : 50PD1
5. Switch on the power of each of the devices
 - * When connected with a computer, switch on the power of the computer first.
6. Input an analog RGB signal or a video signal to this unit
7. Select the input mode
 - * Select the appropriate RGB input or video input.
8. Adjust the screen
 - * Make adjustments when adjustment of the screen display position or distortion is required.
9. Adjust the image
 - * Make adjustments when adjustment of the tint, brightness, or contrast is required.

Warning

For proper installation and mounting it is strongly recommended to use a trained, authorized NEC dealer. Failure to follow correct mounting procedures could result in damage to the unit or injury to the installer. Product warranty does not cover damage caused by improper installation.

Notice:

This monitor requires the use of a tabletop stand or wall mount unit for permanent installation and use. This monitor cannot be used without one of these accessories.

Note:

RETRACTABLE FEET ARE FOR TEMPORARY USE ONLY AND ARE NOT INTENDED FOR PERMANENT INSTALLATION. MODEL # PX-42VPU1-ST STAND IS REQUIRED FOR PERMANENT TABLETOP INSTALLATION. REPLACE THE FEET WHEN YOU MOVE THE MONITOR.

Opening the Terminal Board Cover

Slide the knob and at the same time lift the cover.

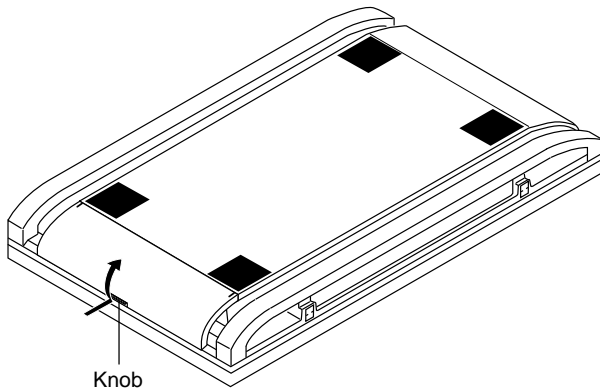

Attaching the Remote Control Holder

Insert the top hook of the remote control holder into the installation hole of the main unit and then insert the bottom hook into its respective hole.

To remove the remote control holder, first release the bottom hook, then release the top hook.

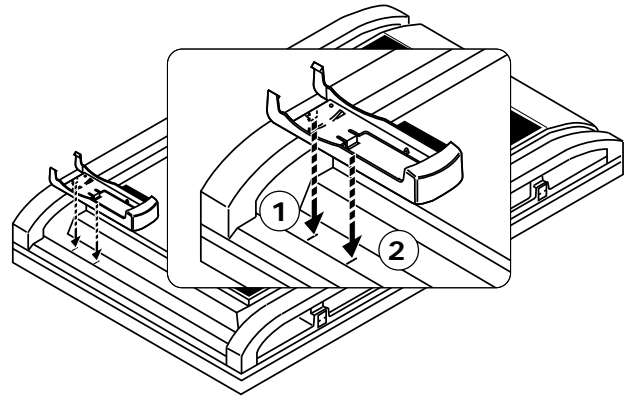

Removing the Terminal Board Cover

This unit's terminal board cover can be removed.

First, open the cover and then:

1. Pull the top hook in the direction of the arrow.
2. Pull the entire terminal board cover downward.

To attach the terminal board cover, insert the bottom hook into the hole, then pull the top hook and insert it into the hole.

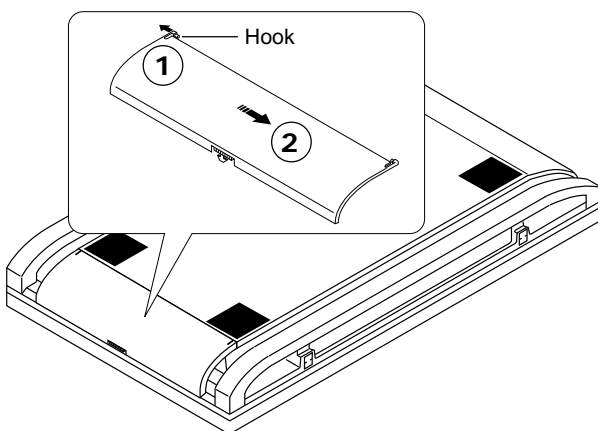

Housing the Remote Control in the Remote Control Holder

First insert the bottom part of the remote control and continue to push it in until the top part clicks into place.

To remove, lift the remote control up from the top part and remove it from the holder.

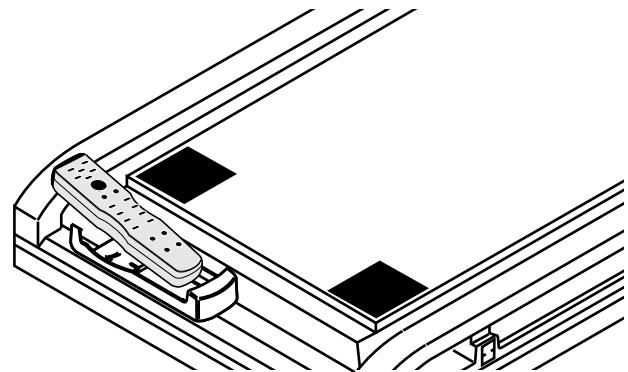

Part Names and Functions

Front View

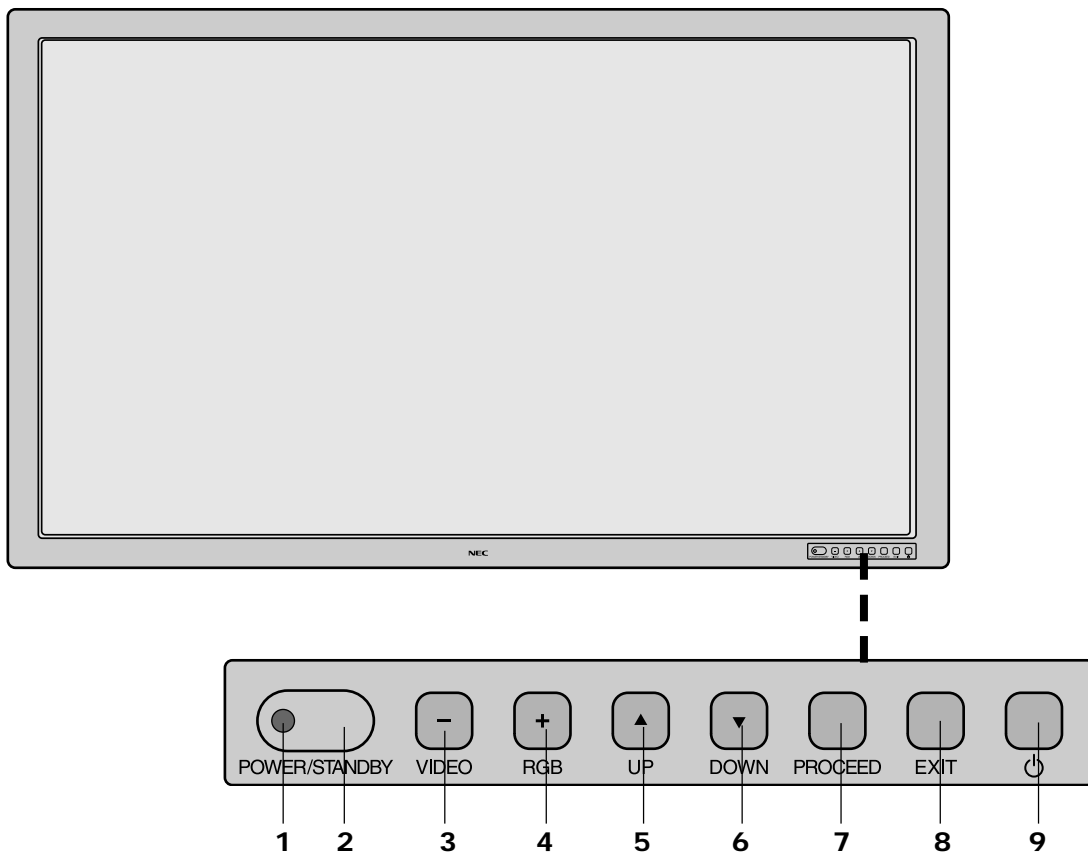

1 POWER/STANDBY

The lamp color indicates the mode of power on/standby or power management.

2 Remote control sensor

Receives the signal from the remote control (when using the wireless remote control).

3 VIDEO button

Switches to the signal connected with the VIDEO input connector.

Functions as the (-) button in the on-screen display (OSM) mode.

4 RGB button

Switches to the signal connected with the RGB input connector. (Toggle switches between RGB1/RGB2/RGB3.)

Functions as the (+) button in the on-screen display (OSM) mode.

5 UP button

Functions as the (▲) button in the on-screen display (OSM) mode.

6 DOWN button

Functions as the (▼) button in the on-screen display (OSM) mode.

7 PROCEED button

Sets the on-screen display (OSM) mode and displays the on-screen menu.

8 EXIT button

Exits the on-screen display (OSM) mode.

9 POWER button

Switches the main power on/off.

Note: When the "CONTROL LOCK" toggle switch on the monitor's input panel is set to "ON", the buttons on the set's front bezel control panel do not function.

Side View.... Terminal Board L/R

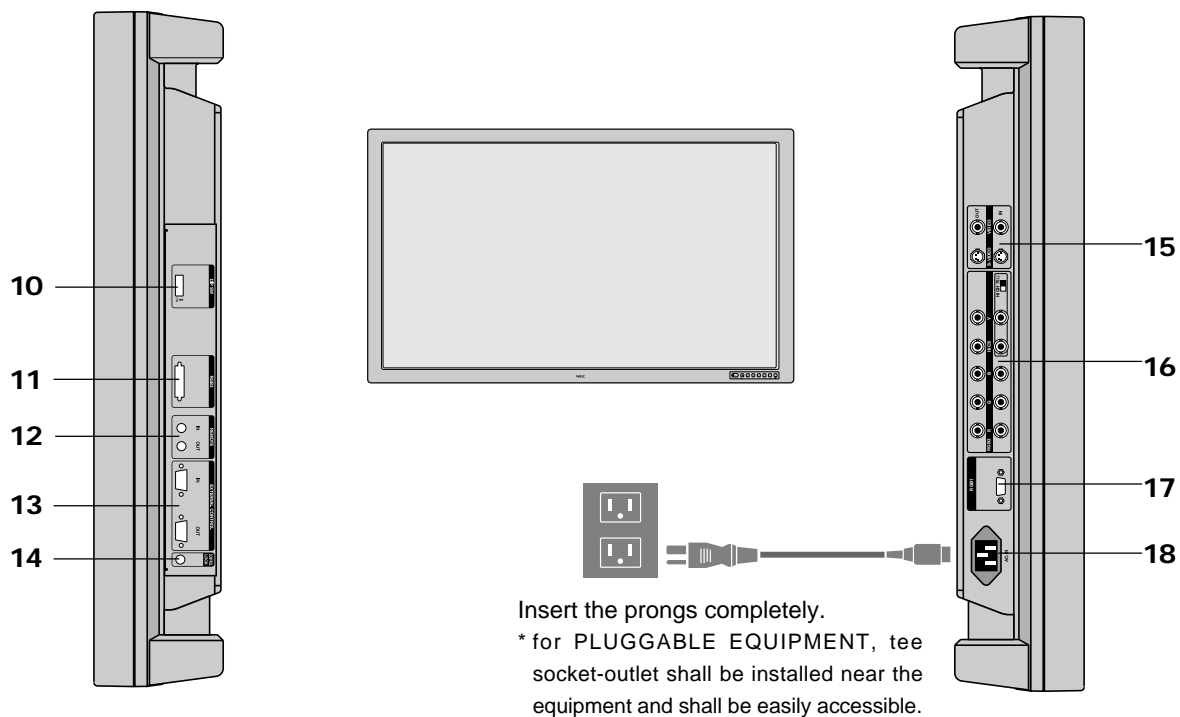

10 DIP SW

Sets the various modes of this unit.

11 RGB3 (DVI 29pin)

IN connector: Inputs a digital RGB signal. (TMDS)

Note: This connector does not support analog input.

12 REMOTE (Mini jack)

IN jack: This jack connects the wired remote control.
THROUGH OUT jack: Outputs as is the remote control signal that is connected to the REMOTE IN jack.

* This is used when operating multiple monitors (i.e., of this unit) with a single remote control.

13 EXTERNAL CONTROL (mini D-Sub 15 pin)

Controlled by the computer's RS-232C interface.

IN connector: Used when operating this unit with EXTERNAL CONTROL from a personal computer.

THROUGH OUT connector: Outputs as is the signal that is input to the EXTERNAL CONTROL IN connector.

14 CONTROL LOCK

When "CONTROL LOCK" is set to "ON", the buttons on the set's front bezel control panel do not function.

15 VIDEO

IN [BNC] connector (BNC): Inputs the video (composite video signal).

IN [S] connector (DIN 4 pin): Inputs the S video (Y/C separate signal).

* When connections are made to both the BNC connector and the S video connector, the signal of the S video connector has priority.

THROUGH OUT [BNC] connector (BNC): Outputs the same signal connected to the VIDEO IN [BNC]

THROUGH OUT [S] connector (DIN 4 pin): Outputs the same signal connector to the connector.

16 RGB2 [R, G, B, H/CS, V] (BNC)

IN connector: Inputs the analog RGB signal.

The H/V composite signal is connected to the H/CS connector.

THROUGH OUT connector: Outputs as is the signal input to the RGB2 IN connector.

75Ω/HIGH switch: This switch selects the impedance of the connector. It is usually used in the "75Ω" position.

17 RGB1 (mini D-Sub 15 pin)

IN connector: Inputs the analog RGB signal of a personal computer, etc.

18 AC IN connector

Connects with the supplied power cable.

Remote Controller

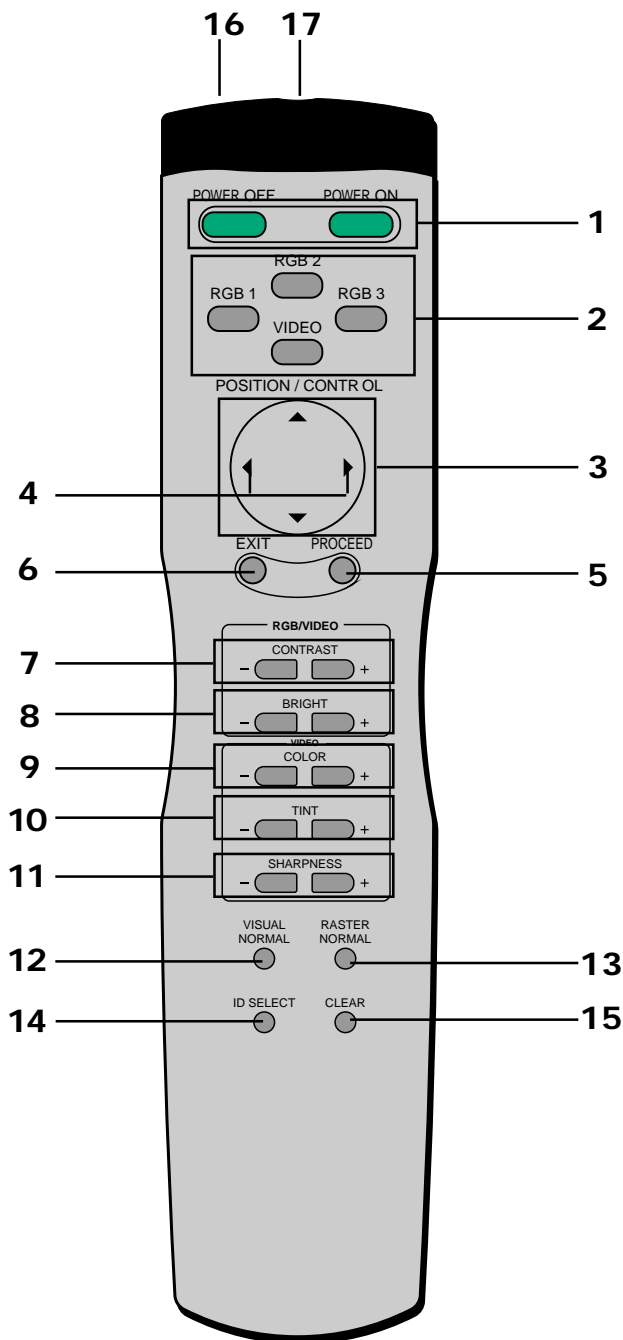

1 POWER ON/OFF button:

Switches the power on/off.

(If the POWER/STANDBY led is not glowing, then these controls will not work.)

2 Input selection buttons:

Select the input signal that will be displayed on the screen.

VIDEO: Switches to the signal that is connected to the VIDEO IN connector.

RGB1: Switches to the signal that is connected to the RGB1 IN (mini D-sub 15-pin) connector.

RGB2: Switches to the signal that is connected to the RGB2 IN (BNC type: R, G, B, H/CS, V) connector.

RGB3: Switches to the signal that is connected to the RGB3 IN connector.

RASTER CONTROL (Screen Adjustment)

3 POSITION/CONTROL buttons (▲▼◀▶):

Used for screen position adjustment and on-screen manager (OSM) mode adjustment settings.

4 POSITION/CONTROL buttons (◀▶):

Enable item selection and adjustments/settings.

ON SCREEN (Screen and Image Adjustment via Menu Control)

5 PROCEED button:

Displays the main menu of screen and image adjustments.

Press this button during the display of the main menu to go to the sub menu.

6 EXIT button:

Exits the on-screen adjustments.

Press this button during the display of the sub menu to return to the main menu.

VISUAL CONTROL (Image Adjustment)

7 CONTRAST button:

Adjusts the contrast of the RGB signal and the video signal.

8 BRIGHT button:

Adjusts the brightness of the RGB signal and the video signal.

9 COLOR button:

Adjusts the saturation of the video signal colors.

10 TINT button:

Adjusts the tint of the video signal.

(Does not function in the PAL or SECAM settings.)

11 SHARPNESS:

Adjusts the fine screen quality of the video screen.

12 VISUAL NORMAL button:

Returns the screen adjustments to the default factory visual settings.

13 RASTER NORMAL button:

Returns the screen adjustments to the default factory raster settings.

14 ID SELECT:

Selects the ID number of each monitor in a video wall so that each monitor can be adjusted with the remote control one at a time.

15 CLEAR:

Deletes the ID number that was set with ID SELECT.

16 Remote control transmitter:

Transmits the remote control signal. (Used with the wireless remote control.)

17 Remote jack:

Connects the supplied remote control cable when used as a wired remote control.

Battery Installation and Replacement

The remote control is powered by two 1.5V AAA batteries.

1. Press and open the cover.

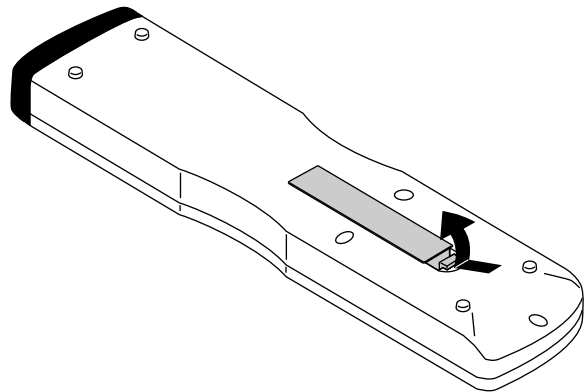

2. Align the batteries according to the (+) and (-) indications inside the case.

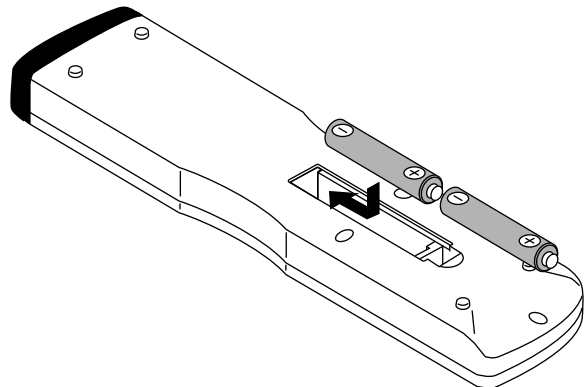

3. Replace the cover.

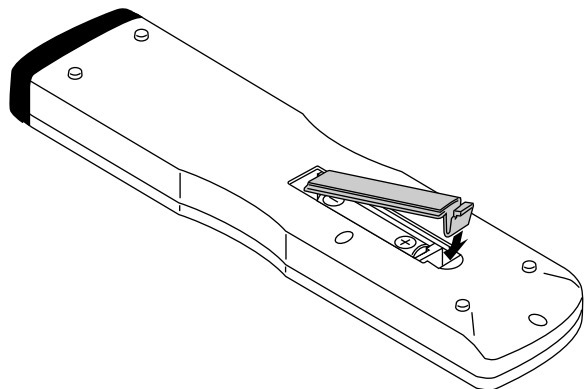

Operating Range

- * Use the remote controller within a distance of about 7 m / 23ft. from the front of the monitor's remote control sensor and at a horizontal angle of within 30°.
- * The remote control operation may not function if the monitor's remote control sensor is exposed to direct sunlight or strong artificial light, or if there is an obstacle between the sensor and the remote control unit.

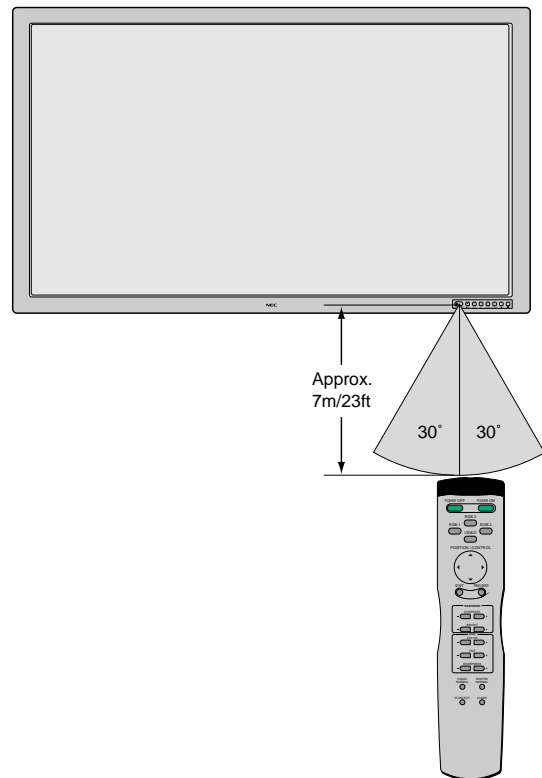

Using the wired remote control mode

Connect the included remote control cable to the remote control's remote jack and "REMOTE IN" jack on the monitor.

When the cable is connected, the mode automatically switches to wired remote control.

When the wired remote control mode is used, the remote control unit can be operated even if no batteries are loaded.

Note:

When you connect a remote control cable to this monitor, attach the supplied ferrite core. If you do not do this, this monitor will not conform to mandatory FCC standards. (42PD2 only)

Note:

Do not connect the wired remote control to the REMOTE THROUGH OUT jack. If doing so, the remote control does not work.

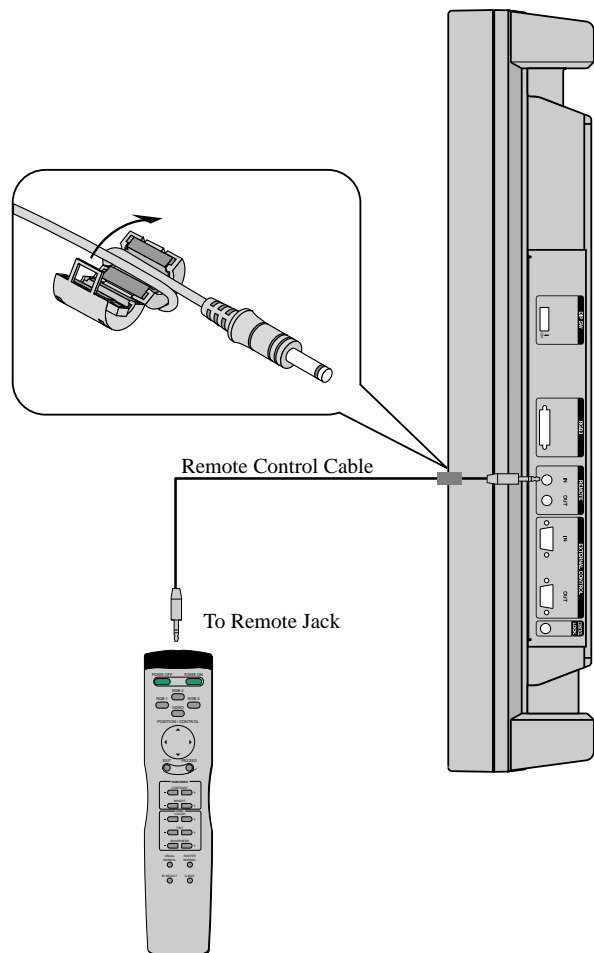

Making the DIP Switch Settings

Before connections are made, the DIP switch should be set to suit the application and the system structure.

* DIP switches are moved up or down with something fine and pointed such as a miniature screwdriver or the tip of a ballpoint pen.

Note: Be sure to switch off the main power before making settings.

DIP Switch Functions and Settings

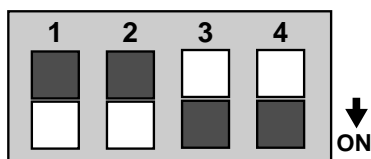

Factory Default Settings

Pin No.	Setting details	Setting when shipped	Switch position
1	On-off switching of on-screen display (OSM)	On	ON
2	On-off switching of wireless remote control	On	ON
3	Sync control mode	Automatic selection	OFF
4			OFF

No. 1: On/off switching of on-screen display (OSM)

* Set to "ON" when performing adjustments and viewing displays with the on-screen display.

Set to "OFF" when displays are not desired.

No. 2: On/off switching of wireless remote control

* When using multiple units under wireless remote control operation, the remote control signal also enters other monitors and may control them at the same time. Monitors for which the reception of the wireless remote control signal is not desired should be set to "OFF."

* Be sure to switch the units on when the wireless remote control is to be used.

Note: that use of the wired remote control is not related to this setting.

Pin Nos. 3 and 4 Sync Control Settings

* These are settings of the input sync signals.

* When this unit is set to automatic, it automatically detects the separate sync, composite sync, and green sync (sync-on-green).

Separate sync should be recognized automatically.

Note: When both pins No. 1 and No. 2 are set "ON" the synchronization may be disturbed. Do not set both these pins "ON."

Sync control setting	Switch position	
	No.3	No.4
Automatic	OFF	OFF
Manual 1 (Composite)	OFF	ON
Manual 2 (Sync-on-green)	ON	OFF

Power Management Function

The power management function is an energy saving function that automatically reduces the power consumption of the display when the keyboard or the mouse have not been used for a fixed period. The power management function of the display becomes operational when the monitor is used with a personal computer based on the VESA DPMS and DVI DMPM system.

When preparing to display a personal computer screen, check that the personal computer is properly connected to this unit and that the personal computer power is on.

When the personal computer power is off, the power management function will be activated and this unit will be set to the off mode.

For information about the power management setting method, see the operating system (OS) manual of the personal computer you are using. To see the video when the power management function is operating, setting the input selection to video will switch the function off.

Power Management Modes

There are three modes in the power management function.

* Standby mode

The standby mode is set when the horizontal sync signal from the personal computer is not input.

The image will be displayed immediately upon the input of the horizontal sync signal.

* Suspend mode

The suspend mode is set when the vertical sync signal from the personal computer is not input.

The image will be displayed about 4 seconds after the input of the vertical sync signal.

* Off mode

This unit is set to the off mode when the horizontal/vertical sync signals from the personal computer are not input.

The image will be displayed about 4 seconds after the input of the horizontal/vertical sync signal.

This is the only power management mode using RGB3 input. When there is no TMDS link, the off mode is set. (This power state is equivalent to the DPMS "off" state.) Displayed approximately 4 seconds after the TMDS link is restored.

The color in which the STANDBY/POWER lamp lights indicates the mode (listed below) in which the unit is set.

Mode	STANDBY/POWER lamp display	Notes
Power ON	Green	---
* Standby	Yellow	Immediate return to normal display
* Suspend	Orange	15 W or less, returns to normal display in about 4 seconds
* OFF	Orange	Maximum 8 W or less, returns to normal display in about 4 seconds
Power OFF	Orange	Remote control in standby mode
	Not lit	Power cord not connected

* Standby suspend, off in the table is the condition that exists when power management is ON.

This is not the standby condition set by the remote control.

Installation

Wiring Diagram

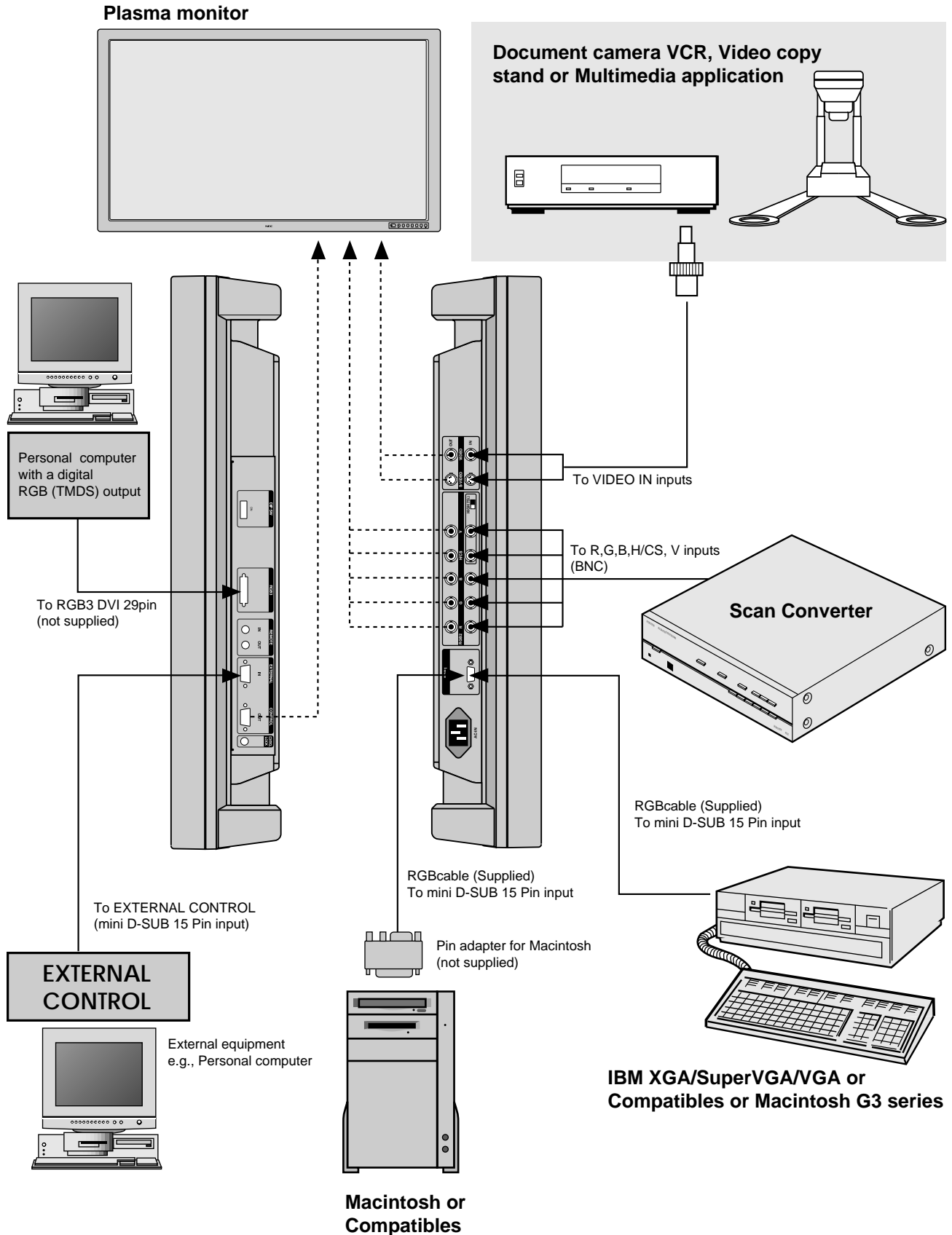

Connecting Your PC or Macintosh Computer

Connecting your PC or Macintosh computer to your plasma monitor will enable you to display your computer's screen image. All of these following display standards are supported:

To connect to a PC, Macintosh or computer equipped with an XGA/SuperVGA/VGA adapter or compatible graphics adapter, simply:

1. Turn off the power to your monitor and computer.
2. If your PC does not support XGA/SuperVGA/VGA you will need to install an XGA/SuperVGA/VGA graphics board. Consult your computer's owner's manual for your XGA/SuperVGA/VGA configuration. If you need to install a new board, see the manual that comes with your new graphics board for installation instructions.
3. Use the signal cable that's supplied to connect your PC or Macintosh computer to the RGB1 input terminal.
4. Turn on the monitor and the computer.

Note: Refer to your computer's owner's manual for more information about your computer's video output requirements and any special identification or configuring your monitor's image and monitor may require.

Connections with Equipment that has a Digital Interface

Connections can be made with equipment that is equipped with a digital interface compliant with the DVI (Digital Visual Interface) standard.

- * Use a DVI 29-pin signal cable (available separately) and the ferrite cores (supplied) when making connections to the RGB3 IN (DVI) connector of the main unit.

Notes:

1. Input TMDS signals conforming to DVI standards. The TMDS input corresponds to 1 link.
2. To maintain display quality, use a cable with a quality prescribed by DVI standards that is within 5 meters in length.

Connecting Your VCR DVD or Laser Disc Player

Use a composite video cable with BNC connector and RCA video cables (not provided) to connect your VCR, DVD or laser disc player to your PlasmaSync monitor. To make these connections, simply:

1. Turn off the power to your monitor and VCR, DVD or laser disc player.
2. Connect one end of your video cable to the video output connector on the back of your VCR, DVD or laser disc player, connect the other and to the VIDEO input terminal (BNC type) of the monitor.
NOTE: You will need a BNC to RCA adapter (not included) to connect a video cable with an RCA pin jack to the BNC input terminal of the PlasmaSync monitor.
3. Turn on the monitor and the VCR, DVD or laser disc player.

Note: Refer to your VCR or laser disc player owner's manual for more information about your equipment's video output requirements.

Note: S-VIDEO IN terminals will take preference over VIDEO IN terminals when a component is connected to each terminal and S-VIDEO selected.

Connecting Your Document Camera

You can connect your plasma monitor to a document camera. To do so, simply:

1. Turn off the power to your monitor and document camera.
2. Use a standard video cable to connect your document camera to the VIDEO input terminal (BNC-type) of the monitor.
3. Turn on the monitor and the document camera.

Note: Refer to your document camera's owner's manual for more information about your camera's video output requirements.

Daisy-chaining Your monitors

The REMOTE IN/OUT terminals allow you to control multiple monitors using one remote control.

1. Connect the REMOTE OUT of the monitor to the REMOTE IN of the next monitor using the optional remote cable.

When using the VIDEO inputs:

THROUGH OUT Connections

1. To pass the VIDEO IN (BNC-type) or S-VIDEO signals, connect THROUGH OUT BNC or S-VIDEO to the external equipment.

When using the RGB2 Input:

THROUGH OUT Connections

1. To pass the RGB2 signal, connect the THROUGH OUT RGBH/V (RGBCS) to the external equipment.

Note: "Plug and Play" is not available for the RGB2 BNC terminals.

Note: In order to make sure that there is no signal loss, do not loop out to more than 3 other devices (maximum 4 units when taking the first unit into consideration).

Note: When looping from one unit to the next, make sure that the 75ohm termination switch is set only on the last unit. All other units should be set in the HIGH position.

Operation

Power

The main unit enters the standby mode when the AC cable is plugged in.

This section describes how to select a computer or video source and how to adjust the picture.

General Controls

Before you turn on your plasma monitor ensure that the computer or video source is turned on.

1) To adjust:

1. Turn On The Monitor

The power button is on the front panel of the monitor. By turning this switch on, the POWER/STANDBY indicator will turn to green and the monitor will become ready to use. OSM is also usable from the front panel.

After you press the POWER OFF button on the remote control, the monitor will go into its standby mode and the POWER/STANDBY indicator will glow orange.

NOTE: The monitor is set to the standby mode when the power cord is plugged in.

2. Select The Computer Or Video Source

Press the "VIDEO" or "RGB 1" "RGB 2" or "RGB 3"(computer) button on the remote control to display the image. Or press the button on the front panel to select your video source: "VIDEO", "RGB 1", "RGB 2" or "RGB 3".

NOTE 1: In the U.S.A. the standard video signal format is NTSC, therefore make sure that the AUTO or NTSC is selected on OSM system control menu. See page 41.

NOTE 2: Select the over scan mode for VIDEO display.

When the RGB input is used, the mode of the power management function can only be in the off state.

In the absence of TMDS signal input, the unit will be in the off state.

(The DVI standard DMPM Active-off power state is equivalent to this.)

The picture will be projected about 4 seconds after the TMDS signal input returns.

3. Adjust The Raster or The Picture Control.

You can adjust the raster such as the horizontal size, vertical size and the brightness and contrast of the image with the remote control.

4. Turning Off The monitor.

Press the POWER OFF button on the remote control or press the POWER button on the front panel.

Adjustment of the Display

There are two methods of adjusting the screen/image using the remote control. One way is direct adjustment by pressing the various buttons and displaying the desired adjustment screens. The other way is to select the menu and display the adjustment screen. This is the menu control adjustment.

When Using the Power Management Function

This unit is designed for use with power management function of the VESA DPMS and DVI DMPM system.

When connected with a personal computer or other equipment incorporating the power management software, power consumption is reduced while the monitor is not being used. During power management operation, the STANDBY/POWER lamp changes color to orange or yellow.

* The fan may stop during power management operation. This does not indicate a failure.

Adjustment of the Display (Direct)

Press the buttons of the remote control to make direct adjustments and settings. A press of the desired button will show the adjustment display. The adjustment condition is stored in memory even after the power is switched off.

Preparation: Select the input screen (VIDEO, RGB1, RGB2, RGB3) that is to be adjusted, after the input signal is connected.

Adjustment of the Screen

The adjustment of screen size is made easier when a geometric shape such as a square is displayed. Press the button to show the adjustment display. The display will go off about 3 seconds after your finger is released from the button.

Adjustment of the screen display position

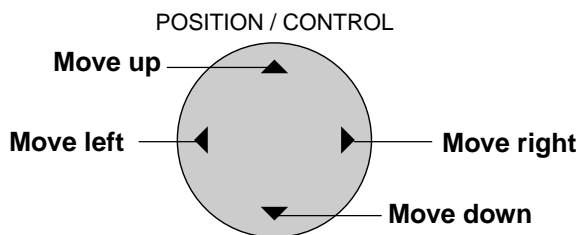
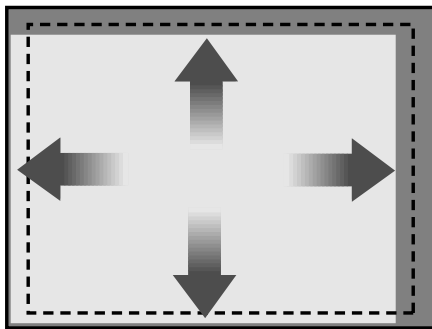

Adjustment display of the up/down position

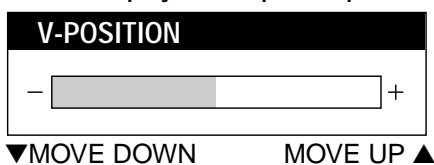

Adjustment display of the left/right position

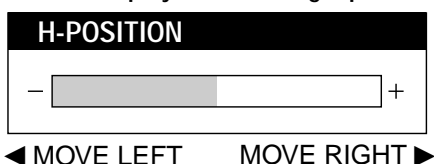

Returning the Screen Adjustment to the Factory Default Settings (NORMAL)

The display position (POSITION) will return to the factory default setting. At this time the following settings of the menu control will also simultaneously return to the factory default settings: AUTO PICTURE, PICTURE ADJUST, FINE PICTURE, H/V-POSITION 1, H/V-POSITION 2, H-WIDTH (Multiple Screens only), V-HEIGHT (Multiple Screens only) and OSM location.

1. Press the RASTER NORMAL button

The verification sub menu is displayed.

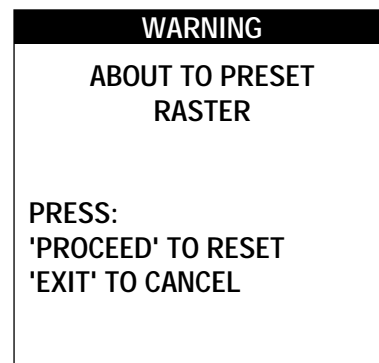

2. A press of the PROCEED button will reset the adjustment.

To cancel the reset, press the EXIT button.

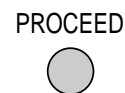

* Use the RASTER NORMAL button. A press of the VISUAL NORMAL button will not return the screen adjustment to the factory default setting.

* A press of the NORMAL button during the on-screen display will return only the display item to the factory default setting.

* H-POSITION 1,2 and V-POSITION 1,2 are not available at the time of RGB input when AUTO PICTURE is turned on.

To adjust H-POSITION 1,2 and V-POSITION 1,2 at the time of RGB input, turn off AUTO PICTURE.

NOTE: See page 30 on how to adjust the H/V Positions.

Adjustment of the Image

Press the button to show the adjustment display. The display will go off about 3 seconds after your finger is released from the button.

Items adjusted with the VIDEO and RGB signals

Contrast adjustment (CONTRAST)

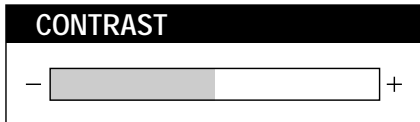

CONTRAST

Image becomes fainter - + Image becomes denser

Brightness adjustment (BRIGHTNESS)

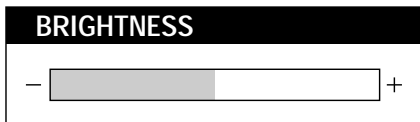

BRIGHT

Screen becomes darker - + Screen becomes brighter

Items adjusted with only VIDEO signals

Color density adjustment

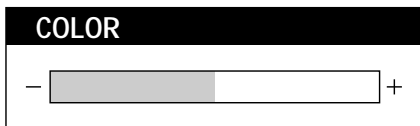

COLOR

Color becomes lighter - + Color becomes deeper

Tint adjustment

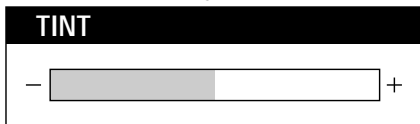

TINT

Screen is tinted toward red - + Screen is tinted toward green

Sharpness adjustment (SHARPNESS)

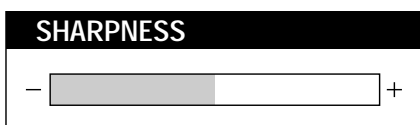

SHARPNESS

Softer quality - + Sharper quality

Returning the Image Adjustments to the Factory Default Settings (NORMAL)

The contrast, brightness, color, tint, gamma, color temp and sharpness adjustments can be returned to the factory default settings. At this time, White Balance of the menu control will simultaneously return to the factory default setting.

1. Press the VISUAL NORMAL button

The verification sub menu is displayed.

VISUAL
NORMAL

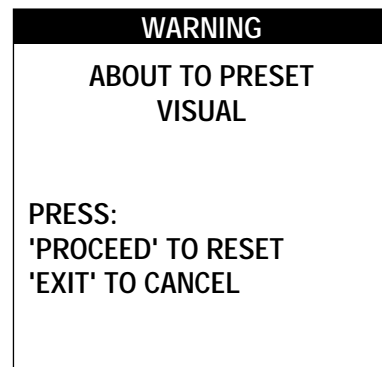

2. A press of the PROCEED button will reset the adjustment.

To cancel the reset, press the EXIT button.

PROCEED



* Use the VISUAL NORMAL button. A press of the RASTER NORMAL button will not return the screen adjustment to the factory default setting.







* A press of the NORMAL button during the on-screen display will return only the display item to the factory default setting.







Adjustment of the Display (Menu Control)

Use of the on-screen display (OSM) function allows the setting of various fine adjustments to be made. The adjustment details will be stored even when the power is switched off.

The on-screen display (OSM) function puts an adjustment display onto the screen and adjustments are made while viewing this display.

List of Setting Details

Icon	On-screen menu	Sub menu	Adjustment details
	Visual Control	At time of video input selection Brightness Contrast Color Tint Sharpness Gamma At time of RGB input selection Brightness Contrast Gamma	Image adjustment (The display will differ between video input selection and RGB input selection.) Brightness adjustment Contrast adjustment Adjustment of the saturation of the colors Tint adjustment Sharpness adjustment Adjustment of the gamma characteristics (Adjusts the brightness of dark portions) Brightness adjustment Contrast adjustment Adjustment of the gamma characteristics (Adjusts the brightness of dark portions)
	H-Position	H-Position 1 H-Position 2 H-Width	Horizontal position 1 Used to align the raster on the PDP Horizontal position 2 Only needs to be adjusted when H-Position 1 does not allow the complete image to fill the screen. (Adjustment is not required with a standard signal.) Horizontal enlargement ratio adjustment (Only for Multiple Screens)
	V-Position	V-Position 1 V-Position 2 V-Height	Vertical position 1 Used to align the raster on the PDP Vertical position 2 Only needs to be adjusted when V-Position 1 does not allow the complete image to fill the screen. (Adjustment is not required with a standard signal.) Vertical enlargement ratio adjustment (Only for Multiple Screens)
	Color Temp	High Low At time of USER selection Gain Bias	Color temperature adjustment High Low White balance adjustment White balance adjustment of bright images (high brightness) White balance adjustment of dark images (dark colors)
	OSM Location	OSM H-Position OSM V-Position OSM Angle OSM Display Time	On-screen adjustment On-screen horizontal position adjustment On-screen vertical position adjustment On-screen angle setting (Horizontal and vertical display) On-screen display OFF time setting
AUTO	Auto Picture	Auto Picture INPUT MODE RGB MODE Picture ADJ Fine Picture WIDE MODE	Used to automatically adjust the clock frequency and clock phase in personal computer screen adjustment. Signal discrimination RGB MODE setting Clock frequency adjustment Clock phase adjustment WIDE MODE setting
	Normal	All Visual Normal All Raster Normal All Normal	Visual setting reset Raster setting reset Visual/Raster setting reset
	Next page		

Icon	On-screen menu	Sub menu	Adjustment details
	Previous page		
	Display Mode	Source Info: H-Freq.: V-Freq.: H-Pol.: V-Pol.:	Display mode display Display source (VIDEO/RGB1,2,3) Horizontal frequency (kHz) Vertical frequency (Hz) Polarity of horizontal sync Neg./Pos. (Negative polarity/Positive polarity) Polarity of vertical sync Neg./Pos. (Negative polarity/Positive polarity)
	Present Time	Timer	Present Time Timer ON/OFF time and mode setting
	VIDEO WALL Menu	Screen Divider Setting Position of Divider	Multiple screens settings Screen division setting Screen division position setting
	SETTINGS 1	Color System Power On Mode Power Manage External Control All Reset	Color system setting Power ON mode setting Power management setting External control setting Settings reset
	SETTINGS 2	Long Life Mode 1 Long Life Mode 2 Long Life Mode 3 Gray Level Set ID No. RGB 3 ADJ All Reset	Long life mode 1 setting Long life mode 2 setting Long life mode 3 setting Gray level setting Set ID number setting Set when the image of RGB 3 is in disorder. Settings reset
	Previous page		

Before Making Adjustments...

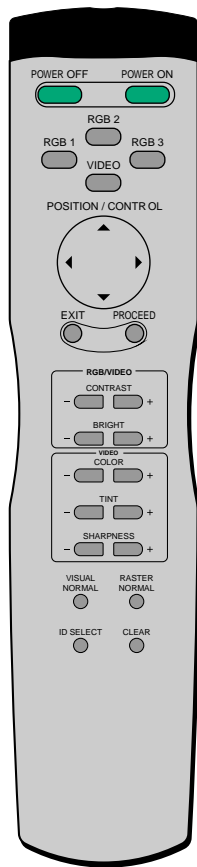

Adjust using the remote control buttons.

PROCEED button

Press to display the main menu.

Press in the main menu to display the sub menu.

EXIT button

Press in the main menu to turn off the display and exit.

Press during the display of the sub menu to return to the main menu.

POSITION/CONTROL ▲ / ▼ buttons

Moves the cursor up or down and selects the adjustment item.

POSITION/CONTROL ◀ / ▶ buttons

Moves the cursor left or right and selects an icon. Press during the display of the sub menu to increase or decrease the adjustment value (and the bar will lengthen or shorten in the positive (+) or negative (-) direction).

VISUAL NORMAL button or RASTER NORMAL button

Resets the adjustment value of the selected item in the menu display. (Values return to the factory default settings.) When a menu is not being displayed, all of the screen adjustments or all of the image adjustment items are reset. (There are two types of NORMAL functions: one is "RASTER" for screen adjustments and the other is "VISUAL" for image adjustments.)

Operation of the On-screen Display

Main menu



Display the next page

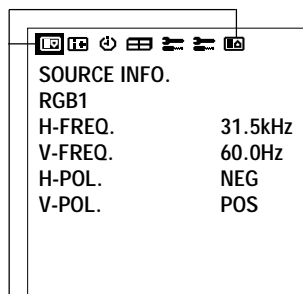

Display the previous page

Sub menu

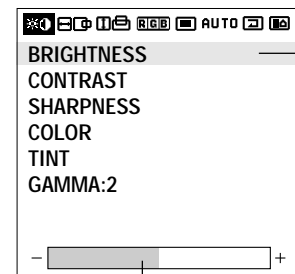

Display the adjustment value

The items of the main menu are displayed as icons.

See Page 25 for details.

While this icon is displaying, pressing the POSITION/CONTROL ◀ button allows you to go to the next page.

To Reset the Adjustment Value to the Factory Default Setting

1. Press the **VISUAL NORMAL** button or **RASTER NORMAL** button.

The verification sub menu is displayed.



2. A press of the **PROCEED** button will reset the adjustment.

To cancel the reset, press the EXIT button.

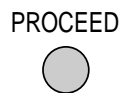
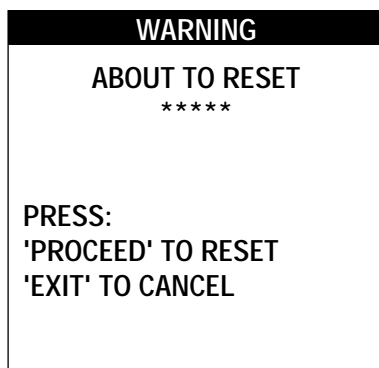

Automatic Storage

The settings values are stored automatically once the PROCEED button is pressed.

Adjustment of the Image (Visual Controls)

These controls adjust the brightness, contrast, color, tint, and sharpness.

1. Align the cursor with icon (1).

The cursor is moved left and right with the POSITION CONTROL ◀/▶ buttons.

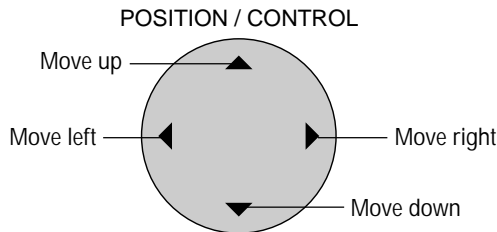

Visual control screen

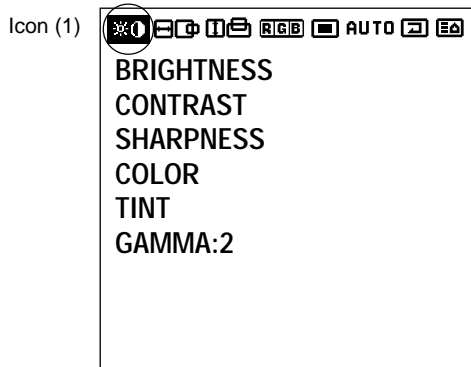

2. Align the cursor with the desired item

The cursor is moved up and down with the POSITION CONTROL ▲/▼ buttons.

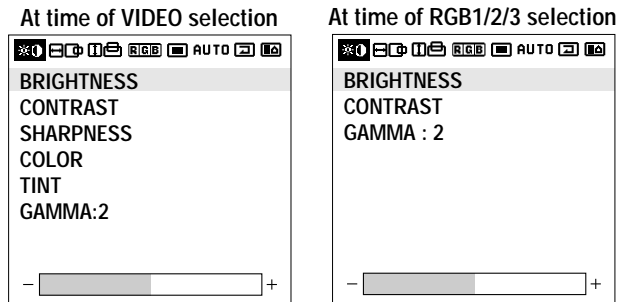

3. While watching the screen, press the ◀/▶ buttons and adjust

Please use the table below as reference.

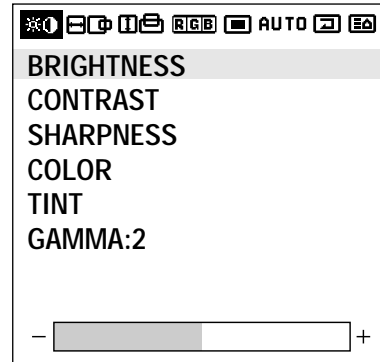

Becomes weaker Becomes stronger

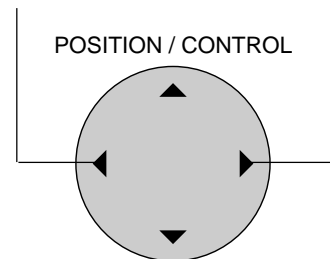

4. Return to the main menu

EXIT



- * To reset the adjustment value, press the VISUAL NORMAL button before pressing the EXIT button.
- * To delete the main menu, press the EXIT button once more.

Display (Adjustment details)	Pressing the ◀ button	Pressing the ▶ button
Brightness (Brightness adjustment)	Screen becomes darker	Screen becomes brighter
Contrast (Contrast adjustment)	Image becomes fainter	Image becomes denser
Color (Color saturation adjustment)	Color becomes less saturated	Color becomes more saturated
Tint* (Tint)	Screen is tinted toward red	Screen is tinted toward green
Sharpness (Sharpness adjustment)	Softer quality	Sharper quality
Gamma (Adjusts the brightness of dark portions)	Normal	Darker

*Tint cannot be adjusted when the video system selection switch is set to PAL or SECAM.

*Switching to GAMMA is not possible when LONG LIFE MODE3 is set to INV or WT.

Note: When dark portions appear rough, adjust Gamma to provide an easy-to-view image.

Adjustment of Screen Position (Horizontal)

Horizontal (H) Adjustment Screen

1. Align the cursor with icon (2)

The cursor is moved left and right with the POSITION CONTROL ◀ / ▶ buttons.

H-WIDTH: Horizontal enlargement ratio adjustment (Displayed only with Multiple Screens)

Adjustment is possible only in multi mode.

H-POSITION 2 cannot be adjusted at the time of VIDEO input.

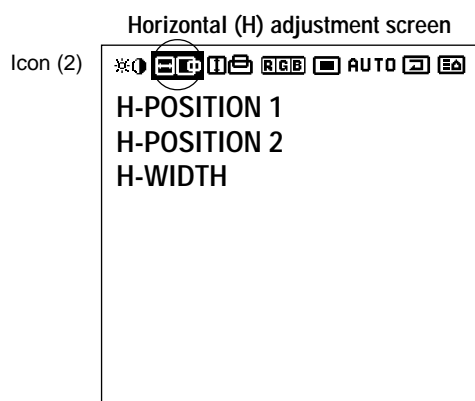

2. Align the cursor with the desired item

The cursor is moved up and down with the POSITION CONTROL ▲ / ▼ buttons.

H-POSITION 1: Horizontal position 1

Used to align the raster on the PDP.

H-POSITION 2: Horizontal position 2

Only needs to be adjusted when H-Position 1 does not allow the complete image to fill the screen.

(Adjustment is not required with a standard signal.)

H-WIDTH: Horizontal enlargement ratio adjustment (Displayed only with Multiple Screens)

Adjustment is possible only in multi mode.

H-POSITION 2 cannot be adjusted at the time of VIDEO input.

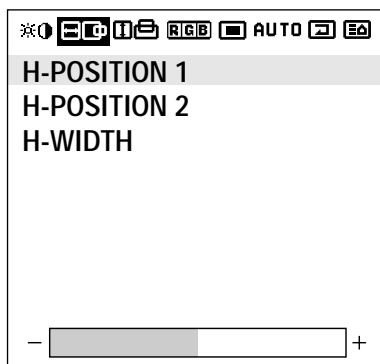

3. While watching the screen, press the ◀ / ▶ buttons and adjust

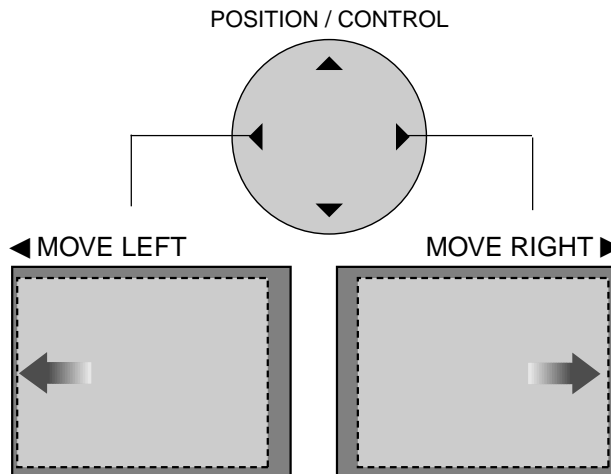

4. Return to the main menu



- * To reset the adjustment value, press the RASTER NORMAL button before pressing the EXIT button.
- * To delete the main menu, press the EXIT button once more.
- * H-POSITION 1,2 and V-POSITION 1,2 are not available at the time of RGB input when AUTO PICTURE is turned on.
To adjust H-POSITION 1,2 and V-POSITION 1,2 at the time of RGB input, turn off AUTO PICTURE.
- * Horizontal and Vertical Position Controls
Both the horizontal and vertical position controls in the OSM include a POSITION 1 and a POSITION 2 adjustment when an RGB signal is selected for display. These two position controls provide access to the entire raster position (POSITION 1) and a fine adjustment within the raster (POSITION 2). First adjust POSITION 1 so that the raster fills the entire screen. After the raster position is set properly, then select POSITION 2 to make sure that the image fills the raster and all of the image is filling the screen.

NOTE: Make sure that none of the actual image is missing, left to right or top to bottom.

Adjustment of Screen Position (Vertical)

Vertical (V) Adjustment Screen

1. Align the cursor with icon (3)

The cursor is moved left and right with the POSITION CONTROL ◀/▶ buttons.

V-HEIGHT: Vertical enlargement ratio adjustment (Displayed only with Multiple Screens)

Adjustment is possible only in multi mode.

V-POSITION 2 cannot be adjusted at the time of VIDEO input.

Vertical (V) adjustment screen

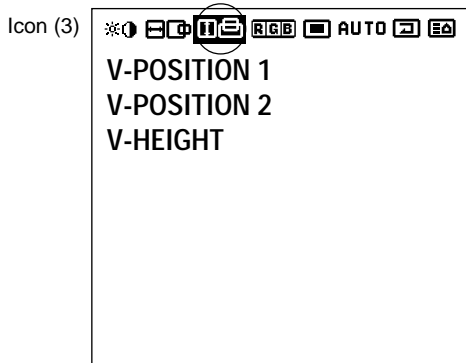

2. Align the cursor with the desired item

The cursor is moved up and down with the POSITION CONTROL ▲/▼ buttons.

V-POSITION 1: Vertical position 1

Used to align the raster on the PDP.

V-POSITION 2: Vertical position 2

Only needs to be adjusted when V-Position 1 does not allow the complete image to fill the screen.

(Adjustment is not required with a standard signal.)

V-HEIGHT: Vertical enlargement ratio adjustment (Displayed only with Multiple Screens)

Adjustment is possible only in multi mode.

V-POSITION 2 cannot be adjusted at the time of VIDEO input.

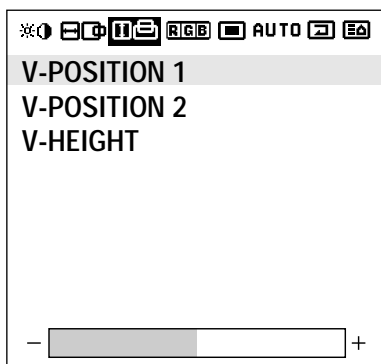

3. While watching the screen, press the ◀/▶ buttons and adjust

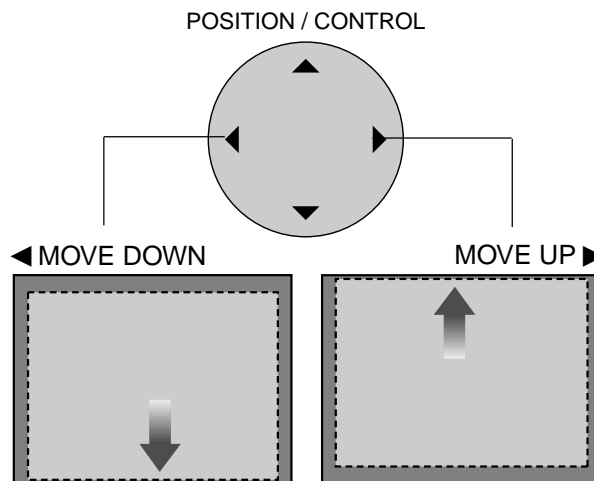

4. Return to the main menu

EXIT



- * To reset the adjustment value, press the RASTER NORMAL button before pressing the EXIT button.
- * To delete the main menu, press the EXIT button once more.
- * H-POSITION 1,2 and V-POSITION 1,2 are not available at the time of RGB input when AUTO PICTURE is turned on.
To adjust H-POSITION 1,2 and V-POSITION 1,2 at the time of RGB input, turn off AUTO PICTURE.
- * Horizontal and Vertical Position Controls
Both the horizontal and vertical position controls in the OSM include a POSITION 1 and a POSITION 2 adjustment when an RGB signal is selected for display. These two position controls provide access to the entire raster position (POSITION 1) and a fine adjustment within the raster (POSITION 2). First adjust POSITION 1 so that the raster fills the entire screen. After the raster position is set properly, then select POSITION 2 to make sure that the image fills the raster and all of the image is filling the screen.

NOTE: Make sure that none of the actual image is missing, left to right or top to bottom.

Color Temperature (COLOR TEMP)

This adjusts the color temperature.

1. Align the cursor with icon (4)

The cursor is moved left and right with the POSITION CONTROL ◀/▶ buttons.

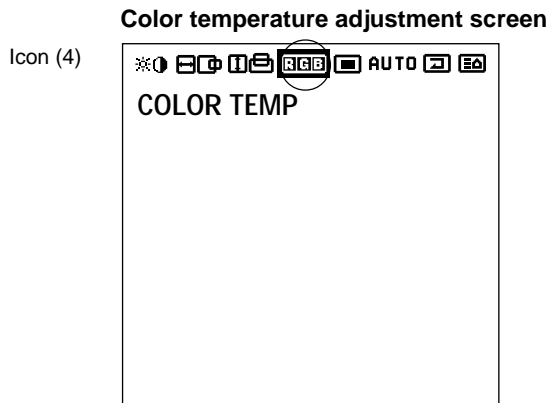

3. Return to the main menu

EXIT



- * To reset the adjustment value, press the VISUAL NORMAL button before pressing the EXIT button.
- * To delete the main menu, press the EXIT button once more.

2. Align the cursor with COLOR TEMP and set with the ◀/▶ buttons.

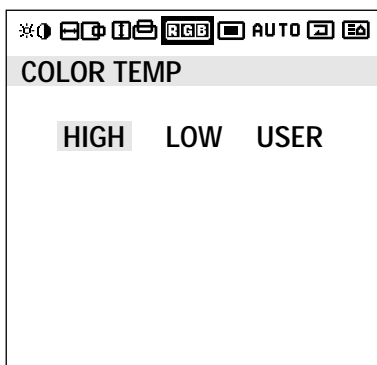

Color temperature adjustment

HIGH : High

LOW : Low

USER : User setting

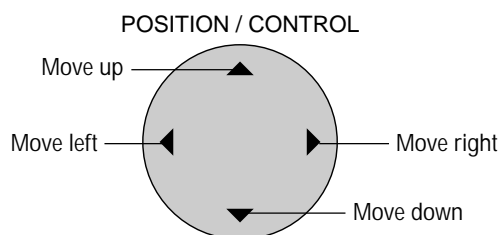

Adjustment of the White Balance

This adjusts the white balance of bright images (Gain) and dark images (Bias).

1. Align the cursor with icon (4)

The cursor is moved left and right with the POSITION CONTROL ◀/ ▶ buttons.

Color temperature adjustment screen

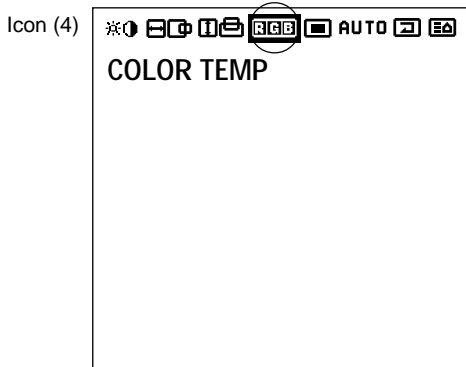

2. After selecting COLOR TEMP, align the cursor with USER and press the PROCEED button.

The cursor is moved left and right with the POSITION CONTROL ◀/ ▶ buttons.

PROCEED

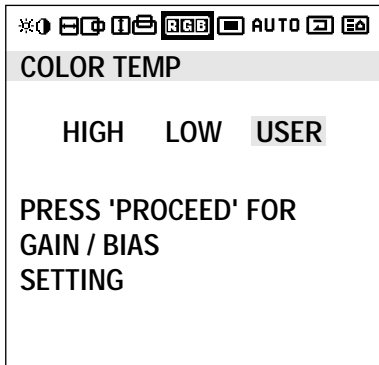

3. Align the cursor with Gain or Bias of the sub menu, then make the adjustment with the ◀/ ▶ buttons while watching the screen.

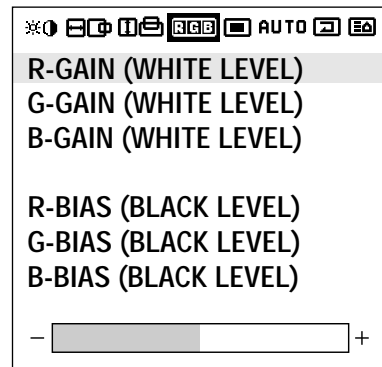
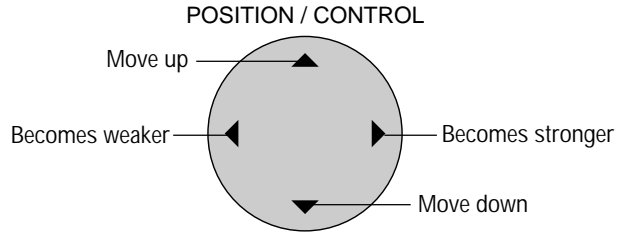

4. Return to the main menu

EXIT



- * To reset the adjustment value, press the VISUAL NORMAL button before pressing the EXIT button.
- * To delete the main menu, press the EXIT button once more.

Adjustment of the On-screen Display Position

1. Align the cursor with icon (5)

The cursor is moved left and right with the POSITION CONTROL ◀ / ▶ buttons.

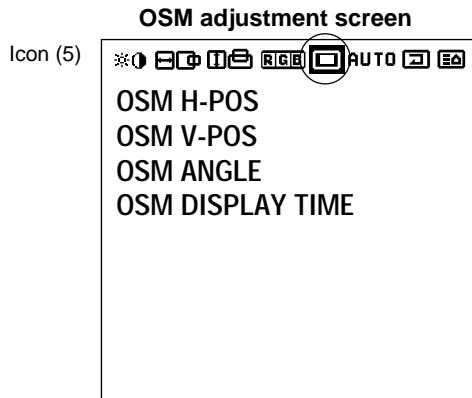

3. Exiting the adjustment

EXIT



The display will change to the main menu. Another press of the button will delete the main menu and exit the adjustment.

- * The change will be stored when the menu is deleted. To reset the adjustment value, press the RASTER NORMAL button before pressing the EXIT button.
- * To adjust another item, press the EXIT button.

2. Align the cursor with the desired item from the sub menu and adjust.

The cursor is moved up and down with the POSITION CONTROL ▲ / ▼ buttons.

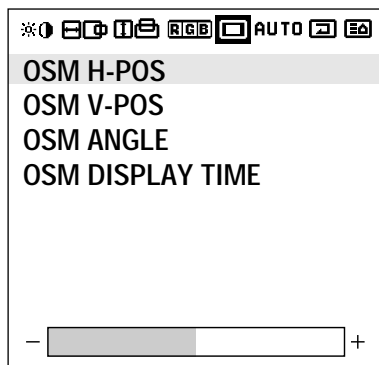
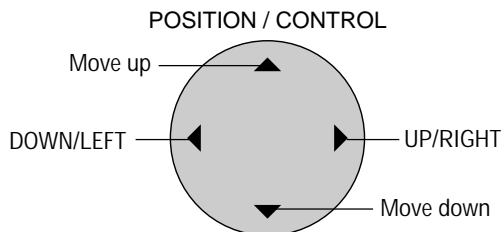

The OSM screen can be rotated 90° counterclockwise for easy viewing in portrait mode by changing the OSM ANGLE on the menu.

Setting the On-screen Display OFF Time

While using the on-screen display (OSM), the OFF time setting functions to automatically turn off the on-screen display when there is no input.

1. Align the cursor with icon (5)

The cursor is moved left and right with the POSITION CONTROL ◀/▶ buttons.

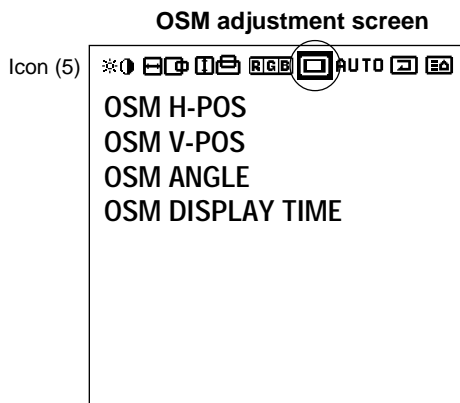

2. Align the cursor with OSM DISPLAY TIME of the sub menu and select the desired time

Align with the inverted characters.

The following can be selected: 5 seconds, 10 seconds, 30 seconds, 60 seconds, and 120 seconds.

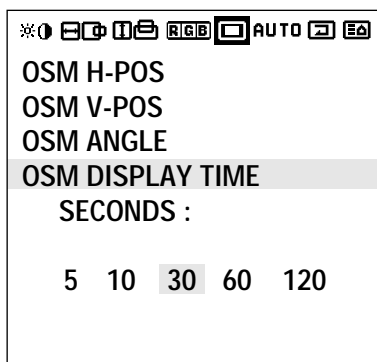
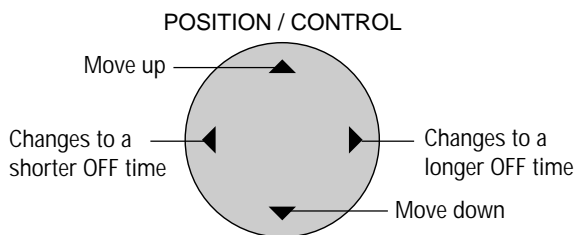

* The factory default setting is 30 seconds.

3. Return to the main menu

EXIT



* To delete the main menu, press the EXIT button once more.

Adjustment of the Clock Frequency/Clock Phase (AUTO PICTURE)

When AUTO PICTURE is set to ON, normally the clock frequency adjustment and the clock phase adjustment are not necessary, but this adjustment should be made when the automatic adjustment cannot be made correctly.

Make the adjustment when a new signal has been input, when vertical lines appear blurry, or if the image appears unclear.

H-POSITION 1,2 and V-POSITION 1,2 are not available at the time of RGB input when AUTO PICTURE is turned on.

To adjust H-POSITION 1,2 and V-POSITION 1,2 at the time of RGB input, turn off AUTO PICTURE.

1. Align the cursor with icon (6)

The cursor is moved left and right with the POSITION CONTROL ◀/▶ buttons.

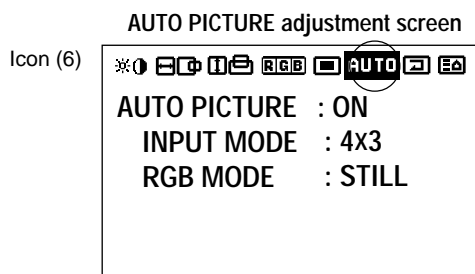

2. Align the cursor with AUTO PICTURE and set to OFF.

AUTO PICTURE: Automatically adjusts the screen position, clock frequency, and clock phase when ON.

* The cursor is moved up and down with the POSITION CONTROL ▲/▼ buttons.

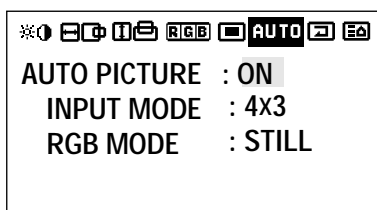

AUTO PICTURE: ON/OFF

Select with POSITION CONTROL ◀/▶ buttons.

There is a transition to the screen below only when OFF.

Note:

- The Picture ADJ and Fine Picture features are available only when the Auto Picture is off. The Picture ADJ and Fine Picture features are not available for Video or S-Video source.
- When the Auto Picture is on, the Picture ADJ and Fine Picture adjustments are made automatically.
- The Picture Adjustment control allows you to fine tune the computer image or to remove vertical banding that might appear. This function adjusts the clock frequencies that eliminate banding in the image.
- The Fine Picture adjusts the clock phase or reduces video noise, dot interference or cross talk. (This is evident when parts of the image appear to be shimmering.) The Fine Picture adjustment may be

necessary when you connect your computer for the first time and you have a blurred picture on the screen.

- If the displayed image is small with respect to the original number of horizontal pixels (including cases when the display area/lit area is small) when AUTO PICTURE is turned on, it may take up to 6 seconds for the image to be displayed.

3. Align the cursor with the desired item using the POSITION CONTROL ◀/▶ buttons.

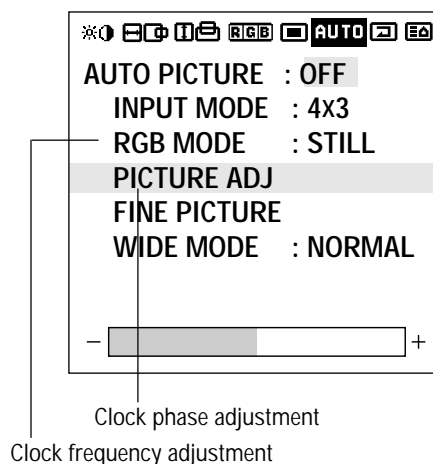

INPUT MODE: 4 x 3 / 16 x 9

Select with the POSITION CONTROL ◀/▶ buttons.

Selecting Native Resolutions for 848 x 480, 852 x 480 and 640 x 480 input signals

There are two controls in the plasma monitor OSM menus that allow you to set the monitor to display resolutions with 848, 852 and 640 horizontal dots in their true resolutions.

When inputting an 848 x 480 signal, align the cursor at the top of the OSM window. Move the cursor down to WIDE MODE and use the POSITION LEFT/RIGHT control to select 4 x 3. The monitor will display the signal at 848 x 480. If FULL is selected, the monitor will automatically expand the input signal to 853 x 480.

To choose between 640 x 480 and 852 x 480 resolutions align the cursor with icon 6 (auto) at the top of the OSM window, move the cursor down to INPUT MODE and...

Use the POSITION LEFT/RIGHT control to select 16 x 9 to display 852 x 480 in true resolution or to expand (stretch) 640 x 480 to fill the screen from left to right. Select 4 x 3 to display 640 x 480 resolution in its standard 4:3 aspect ratio with vertical letterbox bars to the right and left of the image.

After selecting the desired setting, go to the Auto menu, set auto picture to OFF and use the Picture Adjust and Fine Picture controls to adjust clock phase and frequency to sharpen the image, if necessary.

*** RGB MODE:**

RGB MODE is displayed at the time of RGB input, RGB MODE is not displayed at the time of video input.

Initial value : STILL

At time of RGB input

[MOTION]: Set when a scan converter or other moving picture has been connected

[STILL]: Set when displaying a personal computer screen

[DTV]: Set when using digital broadcast or other sources with an RGB input

This is used in signal discrimination at the time of RGB input.

Note: When a moving picture is displayed in still picture mode, the screen will appear blurry.

4. Make the various adjustments with the POSITION CONTROL ◀/▶ buttons.

*** Clock frequency adjustment (Picture ADJ)**

Adjust the clock frequency and adjust the width of the image with respect to the screen.

The adjustment is made with a dot unit signal. Adjust to the position at which vertical flickering disappears.

POSITION / CONTROL

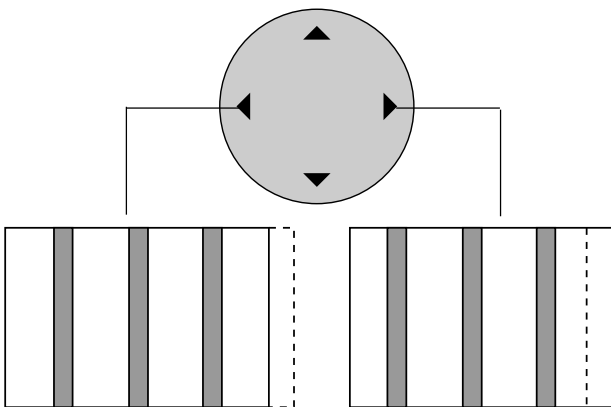

When image width is wide (i.e., clock frequency is high), narrow the width with the (-) button.

When image width is narrow (i.e., clock frequency is low), widen the width with the (+) button.

———— Screen display range
----- Image range width

Go to operation 2 when continuing the adjustment

*** Clock phase adjustment (Fine Picture)**

Adjust the phase of the clock and adjust the (+) and (-) buttons so that screen noise, flicker, and color infidelity are minimized. First adjust the clock frequency, then perform the clock phase adjustment.

Note: Neither the clock frequency adjustment nor the clock phase adjustment function are available at the time of VIDEO and S-VIDEO input.

*** WIDE MODE:**

NORMAL/FULL/STADIUM/ZOOM (Initial value: NORMAL)

Note that only NORMAL/FULL area available in RGB mode.

Selecting Native Resolutions for 848 x 480, 852 x 480 and 640 x 480 input signals

There are two controls in the Plasma monitor OSM menus that allow you to set the monitor to display resolutions with 848, 852 and 640 horizontal dots in their true resolutions.

When inputting an 848 x 480 signal, align the cursor at the Bottom of the OSM window. Move the cursor down to WIDE MODE and use the POSITION LEFT/RIGHT control to select NORMAL. The monitor will display the signal at 848 x 480. If FULL is selected, the monitor will automatically expand the input signal to 853 x 480.

To choose between 640 x 480 and 852 x 480 resolutions align the cursor with icon 6 (auto) at the top of the OSM window, move the cursor down to INPUT MODE and...

Use the POSITION LEFT/RIGHT control to select 16 x 9 to display 852 x 480 in true resolution or to expand (stretch) 640 x 480 to fill the screen from left to right. Select 4 x 3 to display 640 x 480 resolution in its standard 4:3 aspect ratio with vertical letterbox bars to the right and left of the image.

After selecting the desired setting, go to the Auto menu, set auto picture to OFF and use the Picture Adjust and Fine Picture controls to adjust clock phase and frequency to sharpen the image, if necessary.

5. Return to the main menu



* To reset the adjustment value, press the RASTER NORMAL button before pressing the EXIT button.

* To delete the main menu, press the EXIT button once more.

Normal Screen

Returns the user side image data of the mode currently being input to the standard condition.

1. Align the cursor with icon (7)

The cursor is moved left and right with the POSITION CONTROL ◀ / ▶ buttons.

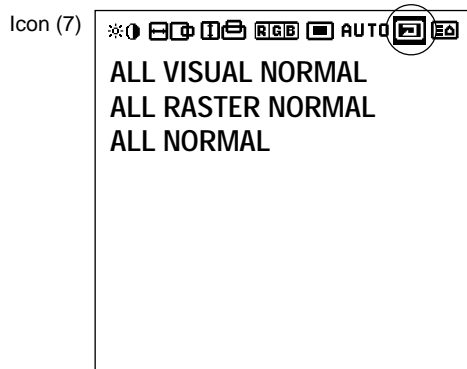

2. Align the cursor with the desired item and press the PROCEED button.

The cursor is moved up and down with the POSITION CONTROL ▲ / ▼ buttons.

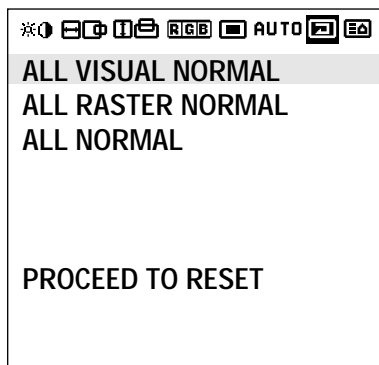

ALL RASTER NORMAL

- * Initialization items
H-POSI 1,2, V-POSI 1,2, AUTO PICTURE, OSM POSITION.
- * The following items are added in multi mode:
Screen switching position, horizontal/vertical enlargement ratio (H/V WIDTH)

ALL VISUAL NORMAL

Color, tint, sharpness, contrast, brightness, color temperature, gamma.

3. Return to the main menu

EXIT



- * To delete the main menu, press the EXIT button once more.

Next Page Screen

1. Moving the cursor to the next page icon (8) at the right edge of the screen will move the display to the second page.

The cursor is moved left and right with the POSITION CONTROL ◀ / ▶ buttons.

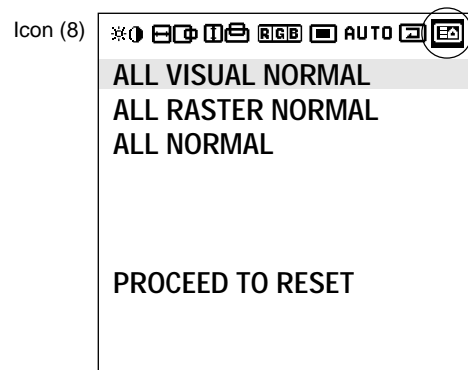

Previous Page Screen

1. Align the cursor with icon (9) at the very top to move to the first page menu screen.

The cursor is moved left and right with the POSITION CONTROL ◀ / ▶ buttons.

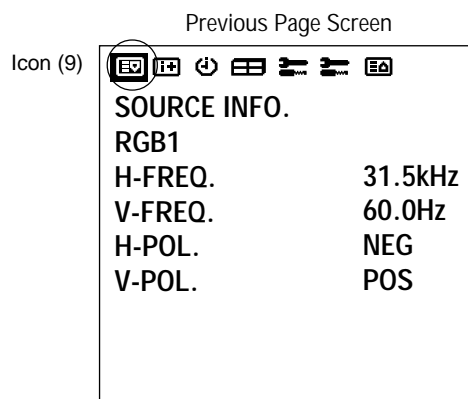

Information Screen

This permits a check on-screen of the resolution and data of the signal that is currently being input.

1. Align the cursor with icon (10) on the second page of the main menu and display the display mode.

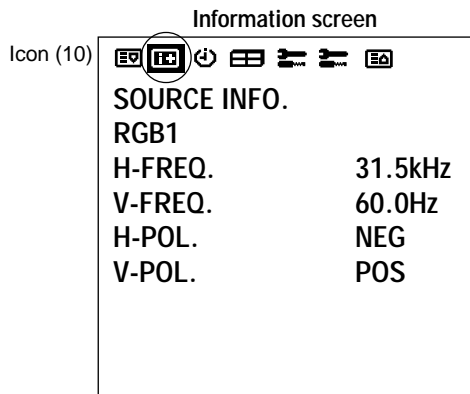

* When RGB input is selected

SOURCE: RGB1, RGB2, RGB3

“NO SIGNAL” is displayed when there is no signal.

H-FREQ: Horizontal frequency (kHz)

V-FREQ: Vertical frequency (Hz)

H-POL: Polarity of the horizontal sync signal

Neg./Pos. (Negative polarity/Positive polarity)

V-Pol.: Polarity of vertical sync

Neg./Pos. (Negative polarity/Positive polarity)

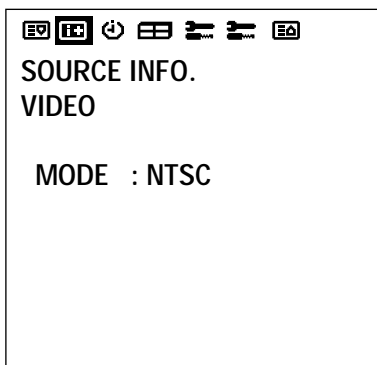

* When video input is selected

SOURCE: VIDEO

MODE: NTSC, PAL, SECAM

Note: NTSC is processed as 4.43 NTSC.

2. Return to the main menu

EXIT



- * Settings cannot be reset.
- * To delete the main menu, press the EXIT button once more.
- * The vertical frequency that is displayed in the display mode can have a slight difference with respect to the actual vertical frequency of the connected input signal. Vertical signals of between 60 Hz and 70 Hz have an error of plus/minus 3 Hz. Vertical signals of 70 Hz or greater have an error of plus/minus 5 Hz. The frequency display of the display mode via the OSM system should always be regarded as a guideline.

Timer Screen

This sets the date and time.

1. Align the cursor with icon (11) of the second page.

The cursor is moved left and right with the POSITION CONTROL ◀/▶ buttons.

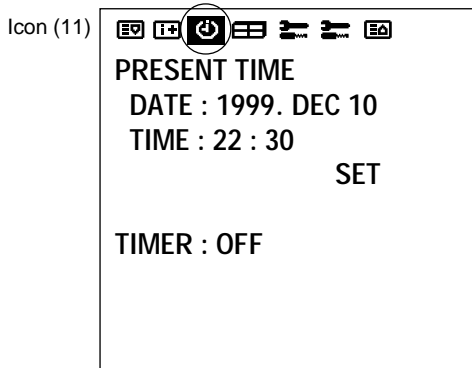

2. Use the ▲ / ▼ buttons to move to each of the year, month, day, hour, and minute positions, and the ◀ / ▶ buttons to set the numbers.

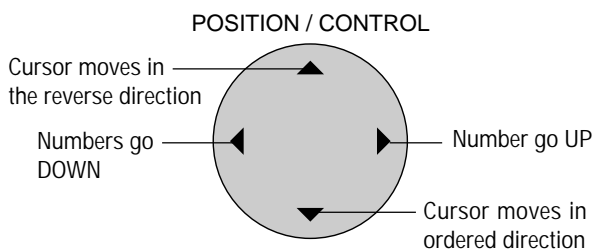
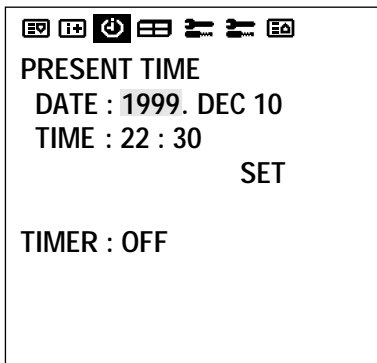

Setting range of date and time settings

Year: 1999 to 2099, Month: JAN to DEC, Day: 01 to 31

Hours: 00 to 24, Minutes: 00 to 59

3. Align the cursor with SET and press PROCEED

PROCEED



* When the timer has been set, the LED will flash orange every 3 seconds during remote control standby.

Note: Data can be maintained for about one month by the built-in lithium battery even when the AC cable is disconnected.

Auto Timer Screen

Used to turn the power ON/OFF, change inputs or enter the invert mode.

1. Align the cursor with icon (11) of the second page of the OSM.

The cursor is moved left and right with the POSITION CONTROL ◀ / ▶ buttons.

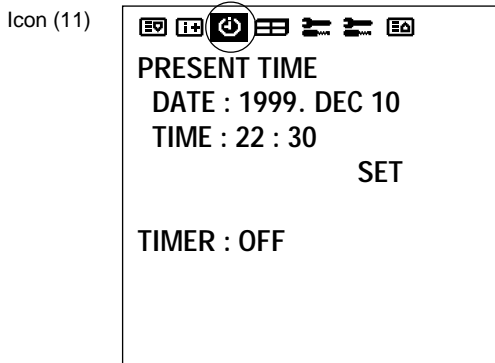

2. Use the ▲ / ▼ buttons, select TIMER and switch ON using the ◀ / ▶ buttons, then press the PROCEED button.

* The cursor is moved up and down with the POSITION CONTROL ▲ / ▼ buttons.



3. Press PROCEED to enter the PROGRAM MENU.

4. Use the ▲ / ▼ buttons to select a line item under DATE.

The sub menu is displayed.

Auto Timer Screen

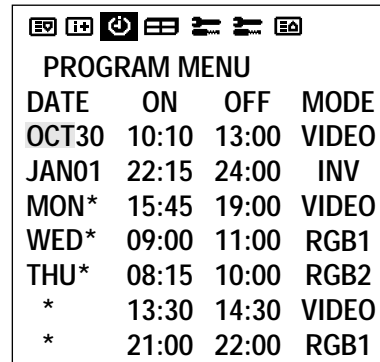

5. Press PROCEED to select either DIRECT, DAILY, and WEEKLY.

6. Use the ▲ / ▼ buttons to highlight DIRECT DAILY, and WEEKLY.

The cursor is moved up and down with the POSITION CONTROL ▲ / ▼ buttons.



7. Press EXIT to return to PROGRAM MENU.

EXIT



The DATE display is as follows:

DIRECTshows in the format of JAN-DEC**.

This relates to a given day that the function will be performed. The function will only happen on that day at that time.

DAILYshows in the format of *.

This relates to a function being performed everyday for a predetermined time.

WEEKLY ..shows in the format of MON, TUE, WED, THU, FRI, SAT, SUN.

This relates to a function being performed on that specific day and time every week.

8. Use the ▲ / ▼ buttons select the ON timer hour and set with the ◀ / ▶ buttons.

Next, use the ▲ / ▼ buttons to select the ON time minute and set with the ◀ / ▶ buttons.

Move onto the OFF time and perform the functions as with the ON time.

Auto Timer Screen

DATE	ON	OFF	MODE
OCT30	10:10	13:00	VIDEO
JAN01	22:15	24:00	INV
MON*	15:45	19:00	VIDEO
WED*	09:00	11:00	RGB1
THU*	08:15	10:00	RGB2
*	13:30	14:30	VIDEO
*	21:00	22:00	RGB1

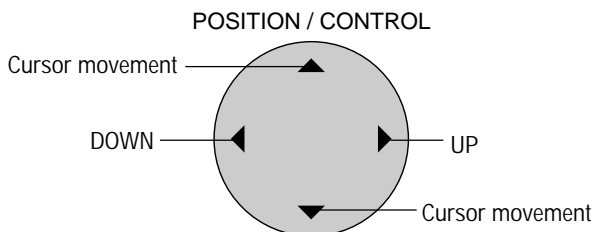

* The ON/OFF time is moved one digit at a time with the up and down cursors, and the left and right buttons change the number UP and DOWN.

9. Use the ▲ / ▼ buttons to select MODE and set to VIDEO, RGB1, RGB2, RGB3, INV or WT with the ◀ / ▶ buttons.

DATE	ON	OFF	MODE
OCT30	10:10	13:00	VIDEO
JAN01	22:15	24:00	INV
MON*	15:45	19:00	VIDEO
WED*	09:00	11:00	RGB1
THU*	08:15	10:00	RGB2
*	13:30	14:30	VIDEO
*	21:00	22:00	RGB1

* The left and right buttons change the following input modes: VIDEO, RGB1 through RGB3, INV, WT.

Note:

•INV provides an inverse image of the incoming signal to reduce burn-in. The INV will work for the last input selected.

Selecting "WT" displays the all white pattern to reduce image burn-in.

10. Return to the main menu

EXIT



* To delete the main menu, press the EXIT button once more.

* When the cursor is in the DATE position, a press of the remote control CLEAR button will clear only that program.

(The CLEAR button is valid only when the cursor is in the DATE position.)

* The function can be used in up to 7 programs and the program contents of a program will be deleted after exiting the program.

* When the Timer function is set, the POWER/STANDBY indicator is blinking orange at intervals of 3 seconds.

Multiple Screens

Select the screen mode from among 1 or 4 screens. (Normally 1 is selected.)

VIDEO WALL can be achieved from two or four screens with the sole use of the main unit.

For information about compatible signals, see the Signal Preset Table of factory setting values on Page 49.

1. Align the cursor with icon (12) on the second page

The cursor is moved left and right with the POSITION CONTROL ◀/▶ buttons.

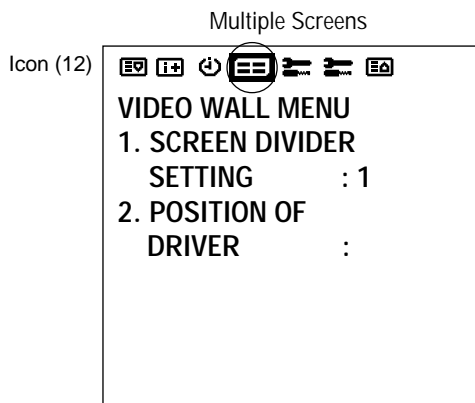

2. Align the cursor using ▲ / ▼ buttons with the SCREEN DIVIDER SETTING and use the ◀/▶ buttons to select 1 screen or 4 screens.

Use the left and right cursors to change the setting between 1 → 4 → in toggle fashion. (The initial value is 1.)

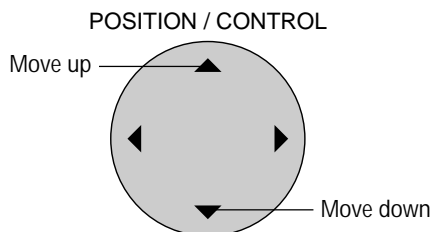

Screen selection:

4 Screens

No.1	No.2
No.4	No.3

3. Align the cursor with POSITION OF SETTING and set with the ◀/▶ buttons.

Nothing will be displayed when "1" is selected in the SCREEN WALL MENU.

When "4" is selected, the icon of the right screen is displayed.

Use the right cursor button to go clockwise and select screen 1 from among the 4 screens. Set the number to "1" at the upper left, and display "1 to 4" going clockwise.

There is no selection for the initial value.

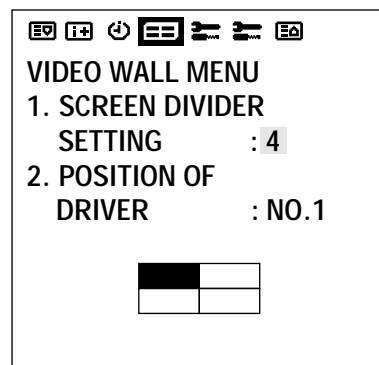

4. Return to the main menu



* To delete the main menu, press the EXIT button once more.

Other Setting Screens (1)

This allows the following settings: WIDE MODE, COLOR SYSTEM, RGB MODE, POWER ON MODE, POWER MANAGER, EXTERNAL CONTROL, HDTV SELECT, and ALL RESET.

1. Align the cursor with icon (13) of the second page.

The cursor is moved left and right with the POSITION CONTROL ◀/▶ buttons.

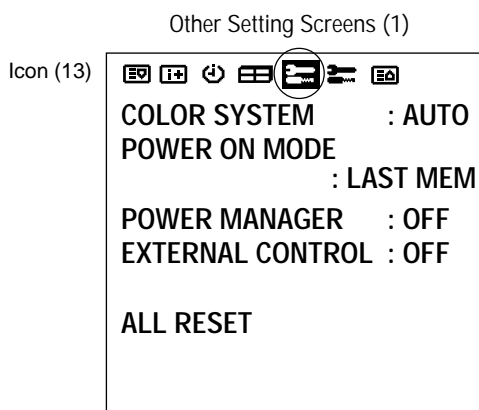

2. Align the cursor with the desired item

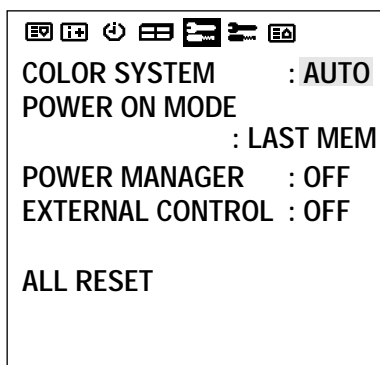
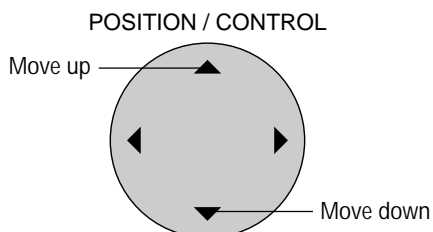

3. Press the ◀/▶ buttons and set

* The ◀/▶ buttons are used to switch the various items in toggle fashion as described below.

* COLOR SYSTEM:

AUTO/3.58 NTSC/PAL/SECAM/4.43 NTSC (Initial value: AUTO)

* POWER ON MODE:

LAST MEM/VIDEO/RGB1/RGB2/RGB3 (Initial value: LAST MEM (Last Memory))

* POWER MANAGER:

This means Power management of RGB input ON/OFF (Initial value is OFF)

* EXTERNAL CONTROL:

OFF/1/2 (Initial value is OFF)
RS-232C can be used when "1" selected.

Open/Short control can be used when "2" is selected.

4. Return to the main menu



* To delete the main menu, press the EXIT button once more.

Other Setting Screens (2)

This allows the following settings: LONG LIFE MODE 1/2/3 GRAY LEVEL, SET ID NO, and ALL RESET.

1. Align the cursor with icon (14) of the second page.

The cursor is moved left and right with the POSITION CONTROL ◀ / ▶ buttons.

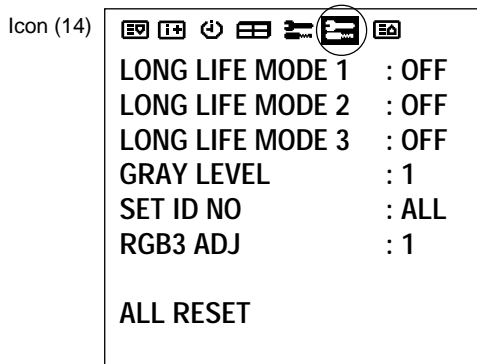

2. Align the cursor with the desired item

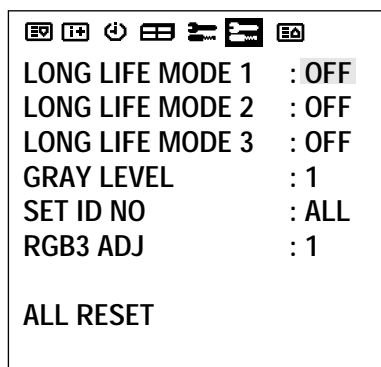
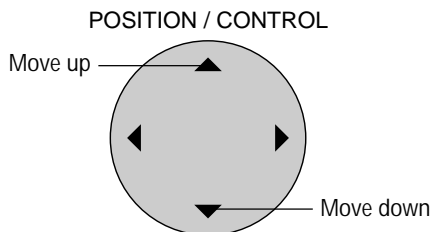

Notice - About RGB3 ADJ

If the image is not stable when in the RGB3 input mode, switch the "RGB3 ADJ" number to 2 or 3. (Select the mode at which the display is stable.)

The display position will change when the number is changed; therefore, when using the unit with "AUTO PICTURE" ON, switch it OFF and then back ON again to return the display position to its original location.

When using the unit with "AUTO PICTURE" OFF, please perform the display position adjustment again.

3. Press the ▲ / ▼ buttons and set

Select the various items with the left and right buttons

Burning reduction function

- * LONG LIFE MODE 1: Switched ON/OFF with the left and right buttons. (Initial value is OFF) → Holds down the brightness of the screen.
- * LONG LIFE MODE 2: Switched ON/OFF with the left and right buttons. (Initial value is OFF) → Moves the screen up, down, left, and right at fixed times.
- * LONG LIFE MODE 3: Switched INV/WT/OFF with the left and right buttons. (Initial value is OFF) → Selecting "INV" displays the inverse image of the incoming signal to reduce burn-in.
- * Selecting "WT" displays the all white pattern to reduce image burn-in.

Note: The long life mode is designed to extend the service life of the plasma panel and reduce ghost images. It is not meant to prevent ghost images.

LONG LIFE MODE 2 cannot be set with multiple screens operation.

Switching to GAMMA is not possible when LONG LIFE MODE3 is set

LONG LIFE MODE 3: When the plasma monitor is turned on or off, the INV. WT setting is set to OFF and the last data is not stored in memory.

- * GRAY LEVEL: Select 1 to 3 with the left and right buttons. (Initial value is 1) → Adjusts the brightness of the non-displayed portion of the screen.
- * SET ID No.: Select 1 to 256 with the left and right buttons. (Initial value is ALL) → Displays ALL with the remote control or CLEAR button.

Note: Selecting ALL RESET and pressing the PROCEED button will display a warning screen and pressing "PROCEED" further will change all the settings of this screen to the initial values.

4. Return to the main menu

EXIT



- * To delete the main menu, press the EXIT button once more.

- * Align the cursor with icon (15) at the very top to move to the first page menu screen.

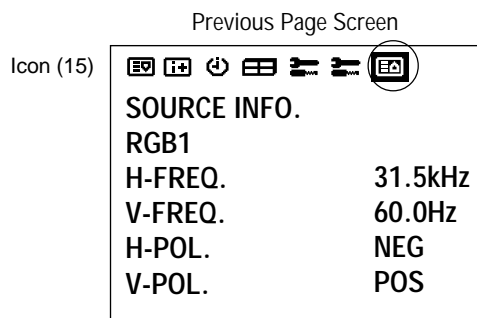

Set Selection Screen for Allotting ID Numbers to Multiple Screens/Each Set

This sets the VIDEO WALL NO. and SET ID NO.

ID Selection Screen

Press the EXIT button twice.

Press the EXIT button once to return to the main menu. To delete the main menu, press the button once more.

1. Press the ID SELECT button of the remote control

This displays the ID selection screen.



- * Selects the ID number for each monitor in a Multiple screen so that each monitor can be adjusted with the remote control one at a time.
- * Only monitors that have been set with the appropriate ID number can be controlled.

Note: The ID select button is valid regardless of the ID set for each monitor.

- * This function is also valid when this monitor is controlled via the RS232 connector.

2. Align the cursor with the desired item

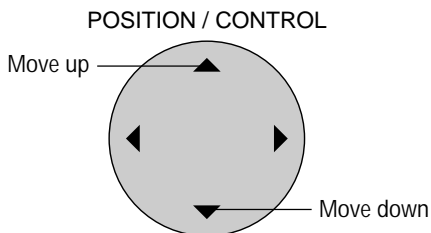

ID Selection Screen

ID SELECT MENU	
VIDEO WALL NO	: 1
SET NO	: 256

3. Set to the desired value

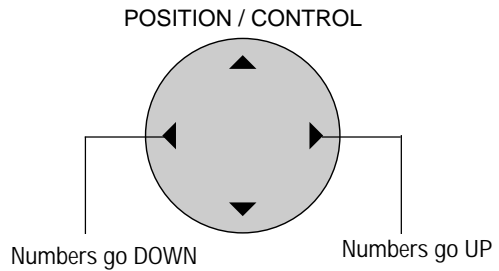

VIDEO WALL No.

- * The POSITION CONTROL ◀/▶ buttons are used to switch the numbers from 1 through 4.
- * A press of the remote control CLEAR button causes a reset. (Initial value is ALL)

SET ID No.

- * The POSITION CONTROL ◀/▶ buttons are used to enter numbers from 1 through 256. Note that entry of numbers higher than 256 is not possible.
- * A press of the remote control CLEAR button causes a reset. (Initial value is ALL)

Note: When both ID numbers have been set, the priority order will be as described below.

VIDEO WALL > SET ID

4. Return to the main menu



The display will go off when the EXIT button is pressed or when the DISPLAY TIME setting time has elapsed.

Troubleshooting

If the picture quality is poor or there is some other problem, check the adjustments, operations, etc., before requesting service.

Symptom	Checks	Remedy
Picture is disturbed. Remote control unit operates erroneously.	<ul style="list-style-type: none"> Is a connected component set directly in front or at the side of the display? 	<ul style="list-style-type: none"> Leave some space between the display and the connected components.
Monitor's power does not turn on when the remote controller's power button is pressed.	<ul style="list-style-type: none"> Is the monitor's power cord plugged into a power outlet? 	<ul style="list-style-type: none"> Plug the monitor's power cord into a power outlet.
	<ul style="list-style-type: none"> Are all the monitor's indicators off? 	<ul style="list-style-type: none"> Plug the monitor's power cord into a power outlet.
	<ul style="list-style-type: none"> Has an ID number been set for the main unit? 	<ul style="list-style-type: none"> Set an ID number with the ID SELECT button, or set the ID number to ALL.
Monitor does not operate when the remote controller's buttons are pressed.	<ul style="list-style-type: none"> Are the remote controller's batteries worn out? 	<ul style="list-style-type: none"> Replace both batteries with new ones.
	<ul style="list-style-type: none"> Is the remote controller pointed at the monitor, or is there an obstacle between the remote controller and the monitor? 	<ul style="list-style-type: none"> Point the remote controller at the monitor's remote control sensor when pressing buttons, or remove the obstacle.
	<ul style="list-style-type: none"> Is direct sunlight or strong artificial light shining on the monitor's remote control sensor? 	<ul style="list-style-type: none"> Eliminate the light by closing curtains, pointing the light in a different direction, etc.
	<ul style="list-style-type: none"> You are not within the effective operating range.(Wireless) 	<ul style="list-style-type: none"> Use the remote control unit within 30° left and right of center (at a distance of 22ft).
	<ul style="list-style-type: none"> Incorrect setting of DIP SW (Wireless) When in the EXT.CONTROL mode, the remote control unit will not operate the monitor. The remote cable is plugged into the REMOTE IN terminal (Wireless). 	<ul style="list-style-type: none"> Set Pin No.2 to ON. Unplug the remote cable from the monitor.
	<ul style="list-style-type: none"> Is the EXTERNAL CONTROL setting 1 or 2? 	<ul style="list-style-type: none"> Use the remote control to set the EXTERNAL CONTROL to OFF.
	<ul style="list-style-type: none"> Has an ID number been set for the main unit? 	<ul style="list-style-type: none"> Set an ID number with the ID SELECT button, or set the ID number to ALL.
	<ul style="list-style-type: none"> Are the remote controller's batteries worn out? 	<ul style="list-style-type: none"> Replace both batteries with new ones.
No Picture is produced.	<ul style="list-style-type: none"> The front panel buttons of the main unit do not function 	<ul style="list-style-type: none"> The front panel buttons do not function during Control Lock
	<ul style="list-style-type: none"> Is the monitor's power cord plugged into a power outlet? 	<ul style="list-style-type: none"> Plug the monitor's power cord into a power outlet.
Poor picture with VIDEO signal input.	<ul style="list-style-type: none"> Power outlet inactive. Power of external equipment is not ON. External equipment has been incorrectly connected. Incorrect input selection. 	<ul style="list-style-type: none"> Be sure wall switch is on and outlet has power. Switch to ON or connect to an active AC outlet. Correct all connections. Press correct RGB1, RGB2, RGB3, or VIDEO button.
	<ul style="list-style-type: none"> Improper control setting. Local interference. Cable interconnections. Input impedance is not correct level. 	<ul style="list-style-type: none"> Adjust picture controls as needed. Try another location for the monitor. Be sure all connections are secure.
Poor picture with RGB signal input.	<ul style="list-style-type: none"> Improper control setting. Incorrect 15 PIN connector pin connections. 	<ul style="list-style-type: none"> Adjust picture controls as needed. Check pin assignments and connections.
Tint is poor or colors are weak.	<ul style="list-style-type: none"> Are the tint and colors properly adjusted? 	<ul style="list-style-type: none"> Adjust the tint and color.
Nothing appears on screen.	<ul style="list-style-type: none"> Is the computer's power turned on? 	<ul style="list-style-type: none"> Turn on the computer's power.
	<ul style="list-style-type: none"> Is a source connected? 	<ul style="list-style-type: none"> Connect source to the monitor.
	<ul style="list-style-type: none"> Is the power manager function in the standby or off mode? 	<ul style="list-style-type: none"> Operate the computer (move the mouse, etc.)
Part of picture is cut off or picture is not centered.	<ul style="list-style-type: none"> Is the position adjustment appropriate? 	<ul style="list-style-type: none"> Adjust the "RGB ADJ." properly.
Image is too large or too small.	<ul style="list-style-type: none"> Is the screen size adjustment appropriate? 	<ul style="list-style-type: none"> Make the adjustment with the wide screen setting.
Picture is unstable.	<ul style="list-style-type: none"> Is the computer's resolution setting appropriate? 	<ul style="list-style-type: none"> Set to the proper resolution.
POWER/STANDBY indicator is lighted in orange or yellow.	<ul style="list-style-type: none"> Horizontal and/or vertical sync signal is not present when the Intelligent Power Manager control is on. 	<ul style="list-style-type: none"> Check the input signal.
	<ul style="list-style-type: none"> POWER/STANDBY indicator is flashing red 	<ul style="list-style-type: none"> The unit is OFF in the timer operation; this is not a malfunction.
POWER/STANDBY indicator is blinking in green.	<ul style="list-style-type: none"> The temperature inside the main unit has become too high and has activated the protector. 	<ul style="list-style-type: none"> Promptly switch off the power of the main unit and wait until the internal temperature drops.

In the following case, power off the monitor immediately and contact your dealer or authorized NEC Service Center.

The monitor turns off in 5 seconds after powering on and then the POWER/STANDBY indicator blinks. It indicates that the power supply circuit or, one more fans have been damaged.

Overheat protector

If the monitor becomes too hot, the overheat protector will be activated and the monitor will be turned off. If this happens., turn off the power to the monitor and unplug the power cord. If the room where the monitor is installed is particularly hot, move monitor to a cooler location, and wait for the monitor to cool for 60 minutes. If the problem persists, contact your NEC dealer for service.

Specifications

PlasmaSync 42PD2 (Model PX-42VP2A)

Plasma Screen	42 inch Visual size (Diagonal), AC Drive type Aspect ratio : 16:9 Optical filter coating Display color : 16,770,000 colors 256 levels
RGB Input Terminals	RGB 1 : mini D-SUB 15pin RGB 2 : BNC (R,G,B, H/CS and V) RGB 3 : Digital RGB (DVI 24+5pin: Not compatible with analog input. Complies with DVI Video : Analog 0.7Vp-p/75 Ohms (Positive) : Sync. : Separate Sync. TTL level, 0.7 - 4.0Vp-p/75 Ohms.....BNC only Horizontal Sync. (Positive/Negative) Vertical Sync. (Positive/Negative) : Composite Sync. TTL Level (Positive/Negative) : Composite Sync. On Green Video 0.3Vp-p (Negative)
RGB Output Terminals THROUGH OUT	BNC (R,G,B, H/CS and V) RGB THROUGHOUT (RGB2 only)
Video Input Terminals VIDEO S-VIDEO	1.0Vp-p, 75 Ohms unbalanced (BNC-Jack), Composite video signal, Sync-negative. Y : 1.0Vp-p, 75 Ohms unbalanced, Sync-negative. C : 0.28Vp-p, 75 Ohms unbalanced, Color burst level.
Video Output Terminals THROUGH OUT THROUGH OUT (S-VIDEO)	1.0Vp-p, 75 Ohms unbalanced (BNC Jack), Composite video signal, Sync-negative. Y : 1.0Vp-p, 75 Ohms unbalanced, Sync-negative. C : 0.28Vp-p, 75 Ohms unbalanced, Color burst level.
External Control (IN/THROUGH OUT)	mini D-SUB 15pin (IN/THROUGH OUT) Open/Short, RS-232C Control
Synchronization Range	Horizontal : 15.5 to 68.7 KHz (automatic : step scan) Vertical : 46.0 to 85.0 Hz (automatic : step scan)
Maximum Resolution	RGB : 853(H) x 480(V) pixels
Power Supply	100-120 VAC, 50/60 Hz
Current Rating	5.6A (maximum)
Power consumption	430W (typical)
Dimensions	39.3(W) x 23.4(H) x 4.5(D) inches / 998(W) X 595(H) X114(D) mm
Weight	72.7lbs/33kg
Environmental Considerations	Operating Temperature : 0 to 40 Humidity : 20 to 80% Altitude : 0 to 6233 feet(1900m) Storage Temperature : -10 to 50 Humidity : 10 to 90% Altitude : 0 to 9842 feet(3000m)
Regulations :	UL/C-ULApproved (UL 1950/CSA 950) DOC Canada requirements Meets FCC class A requirements

All specifications are subject to change without notice.

PlasmaSync 50PD1 (Model PX-50VP1A)

Plasma Screen	50 inch Visual size (Diagonal), AC Drive type Aspect ratio : 16:9 Optical filter coating Display color : 16,770,000 colors 256 levels
RGB Input Terminals	RGB 1 : mini D-SUB 15pin RGB 2 : BNC (R,G,B, H/CS and V) RGB 3 : Digital RGB (DVI 24+5pin: Not compatible with analog input. Complies with DVI Video : Analog 0.7Vp-p/75 Ohms (Positive) : Sync. : Separate Sync. TTL level, 0.7 - 4.0Vp-p/75 Ohms.....BNC only Horizontal Sync. (Positive/Negative) Vertical Sync. (Positive/Negative) : Composite Sync. TTL Level (Positive/Negative) : Composite Sync. On Green Video 0.3Vp-p (Negative)
RGB Output Terminals THROUGH OUT	BNC (R,G,B, H/CS and V) RGB THROUGHOUT (RGB2 only)
Video Input Terminals VIDEO S-VIDEO	1.0Vp-p, 75 Ohms unbalanced (BNC-Jack), Composite video signal, Sync-negative. Y : 1.0Vp-p, 75 Ohms unbalanced, Sync-negative. C : 0.28Vp-p, 75 Ohms unbalanced, Color burst level.
Video Output Terminals THROUGH OUT THROUGH OUT (S-VIDEO)	1.0Vp-p, 75 Ohms unbalanced (BNC Jack), Composite video signal, Sync-negative. Y : 1.0Vp-p, 75 Ohms unbalanced, Sync-negative. C : 0.28Vp-p, 75 Ohms unbalanced, Color burst level.
External Control (IN/THROUGH OUT)	mini D-SUB 15pin (IN/THROUGH OUT) Open/Short, RS-232C Control
Synchronization Range	Horizontal : 15.5 to 68.7 KHz (automatic : step scan) Vertical : 46.0 to 85.0 Hz (automatic : step scan)
Maximum Resolution	RGB : 853(H) x 480(V) pixels
Power Supply	100-120 VAC, 50/60 Hz
Current Rating	7.4A (maximum)
Power consumption	520W (typical)
Dimensions	47.8(W) x 28.6(H) x 5.1(D) inches / 1214(W) X 727(H) X129(D) mm
Weight	101.4lbs/46kg
Environmental Considerations	Operating Temperature : 0 to 40 Humidity : 20 to 80% Altitude : 0 to 6233 feet(1900m) Storage Temperature : -10 to 50 Humidity : 10 to 90% Altitude : 0 to 9842 feet(3000m)
Regulations :	UL/C-ULApproved (UL 1950/CSA 950) DOC Canada requirements Meets FCC class A requirements

All specifications are subject to change without notice.

Appendix

Signal Identification For Raster Preset

Resolution (horizontal frequency/vertical frequency)	Factory settings	User settings	Sync polarity		Presence/absence of sync		RGB MODE	INPUT MODE*7	
			Hor	Ver	Hor	Ver			
VIDEO NTSC*1	○	○	-	-			-	-	
VIDEO PAL*1 VIDEO SECAM*1	○	○	-	-			-	-	
640 X 240 (15.734kHz/59.94Hz)	VU-6010 NTSC*2	○	○	NEG	NEG	Y	Y	-	4 X 3
768 X 288 (15.557kHz/50.39Hz)	VU-6010 PAL*2	○	○	NEG	NEG	Y	Y	-	-
640 X 400 (31.469kHz/70.086Hz)	IBM 400@70Hz*3	○	○	NEG	NEG	Y	Y	-	-
640 X 480 (31.469kHz/59.94Hz)	VESA 480@60Hz	○	○	NEG	NEG	Y	Y	STILL	4 X 3
640 X 480 (35kHz/66.667Hz)	MAC @13**6	○	○	-	-	-	-	-	-
640 X 480 (37.861kHz/72.809Hz)	VESA 480@72Hz	○	○	NEG	NEG	Y	Y	-	-
640 X 480 (37.5kHz/75Hz)	VESA 480@75Hz	○	○	NEG	NEG	Y	Y	-	-
640 X 480 (43.269kHz/85.008Hz)	VESA 480@85Hz*4	○	○	POS	POS	Y	Y	-	-
640 X 480 (39.375kHz/75Hz)	XGA-2 480@75Hz	○	○	NEG	NEG	Y	Y	-	-
800 X 600 (35.156kHz/56.25Hz)	VESA 600@56Hz	○	○	POS	POS	Y	Y	-	-
800 X 600 (37.879kHz/60.31Hz)	VESA 600@60Hz	○	○	POS	POS	Y	Y	-	-
800 X 600 (48.077kHz/72.188Hz)	VESA 600@72Hz	○	○	POS	POS	Y	Y	-	-
800 X 600 (46.875kHz/75Hz)	VESA 600@75Hz	○	○	POS	POS	Y	Y	-	-
800 X 600 (53.674kHz/85.061Hz)	VESA 600@85Hz*4	○	○	POS	POS	Y	Y	-	-
832 X 624 (49.725kHz/74.55Hz)	MAC @16**6	○	○	-	-	-	-	-	-
852 X 480 (31.722kHz/59.966Hz)	I/O data wide*5	○	○	NEG	NEG	Y	Y	-	16 X 9
848 X 480 (31.02kHz/60Hz)	VGA WIDE (NEC1)	○	○	POS	POS	Y	Y	-	-
1024 X 768 (56.476kHz/70.069Hz)	VESA 768@70Hz	○	○	NEG	NEG	Y	Y	-	-
1024 X 768 (60.023kHz/75.029Hz)	VESA 768@75Hz	○	○	POS	POS	Y	Y	-	-
1024 X 768 (68.677kHz/84.997Hz)	VESA 768@85Hz*4	○	○	POS	POS	Y	Y	-	-
1024 X 768 (60.24kHz/74.93Hz)	MAC @19**6	○	○	-	-	-	-	-	-
768 X 576 (31.389kHz/50Hz)	IDC-3000G PAL625P	○	○	NEG	NEG	Y	Y	-	-
640 X 480 (31.47kHz/59.9Hz)	IDC-3000G NTSC 525P	○	○	NEG	NEG	Y	Y	MOTION	4 X 3

*1 Convert to 640 dots x 480 lines and display.

*2 These signals cannot be displayed in the RGB3 input mode.

*3 Display only 400 lines with the screen center of the vertical orientation located at the center.

*4 The picture will be shaky when the moving images of video games, etc., are input. (In this case set the refresh rate to 75 kHz or less.)

*5 Only when using an I/O DATA graphic accelerator board.

*6 Use a separately sold signal adapter (mini D-Sub 15-pin) when connecting to a Macintosh computer.

For some models, make the mini D-Sub 15-pin connection using the included RGB signal cable.

These signals are Sync On Green.

*7 Make the settings to display these signals. The signals will not be displayed properly unless the correct settings are made.

*The resolution deteriorates in comparison with the original image because the image of 640 dots x 480 lines is converted to 853 dots x 480 lines and displayed.

*At the time of video input, video signals derived from poor recording conditions may give rise to a disturbed screen image.

*The sync may be disturbed when non standard signals other than the aforementioned are input.

*Multiple screens (2 screens) can only display signals having an aspect ratio of 4:3. *3 Cannot be used with multiple screens.

*With digital inputs some signals are not accepted.

*852 dot by 480 line signals are displayed with this resolution.

*848 dot by 480 line signals are displayed at a resolution of 848 dots by 480 lines when "NORMAL" is selected, and converted to 853 dots by 480 lines when "FULL" is selected.

Pin Configuration and Signal Level of mini D-Sub 15-Pin (Analog) Input Connector

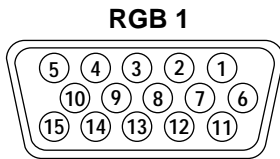

Signal level
 VIDEO signal : 0.7Vp-p (Analog)
 Sync signal : TTL level

Pin No.	Signal (Analog)
1	Red
2	Green or sync-on-green
3	Blue
4	Ground
5	Ground
6	Red ground
7	Green ground
8	Blue ground
9	No connection
10	Sync signal ground
11	Ground
12	Bi-directional DATA (SDA)
13	Horizontal or composite sync
14	Vertical sync
15	Data clock

Pin Configuration and Signal of the RGB 3 IN Connector (DVI Connector)

The unit is equipped with a type of connector commonly used for both analog and digital.
 (Functionally, this cannot be used for analog input.)
 (TMDS can be used for one link only)

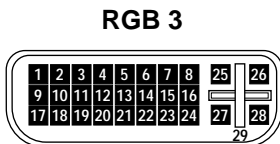

Pin No.	Signal (Digital)
1	T.M.D.S Data 2 -
2	T.M.D.S Data 2 +
3	T.M.D.S Data 2 Shield
4	No connection
5	No connection
6	DDC Clock
7	DDC Data
8	No connection
9	T.M.D.S Data 1 -
10	T.M.D.S Data 1 +
11	T.M.D.S Data 1 Shield
12	No connection
13	No connection
14	+5V Power
15	Ground
16	Hot Plug Detect
17	T.M.D.S Data 0 -
18	T.M.D.S Data 0 +
19	T.M.D.S Data 0 Shield
20	No connection
21	No connection
22	T.M.D.S Clock Shield
23	T.M.D.S Clock +
24	T.M.D.S Clock -
25	No connection
26	No connection
27	No connection
28	No connection
29	No connection

Function and Pin Configuration of the External Control Connector

Application

These specifications are applicable to NEC plasma monitors (including 42- and 50-inch types) and communications control from external equipment.

Connections

Connections should be made as described below.

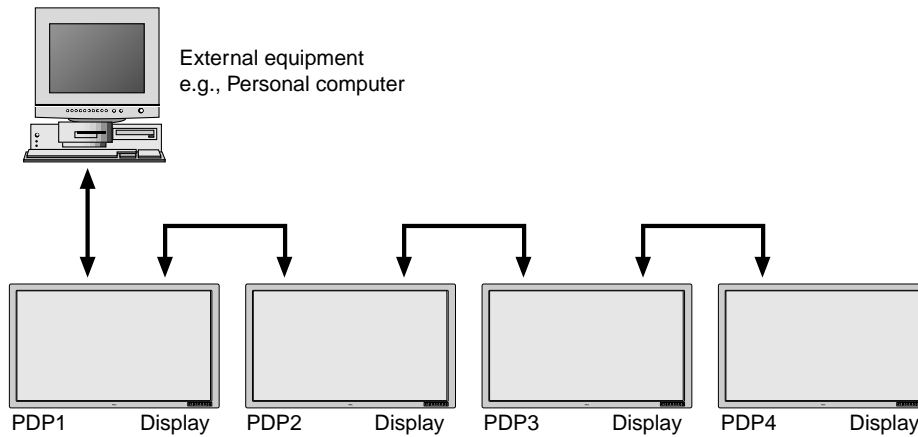

*A maximum of 4 units can be used with a cascade connection.

1) Display-side connector: EXTERNAL CONTROL connector

EXTERNAL CONTROL

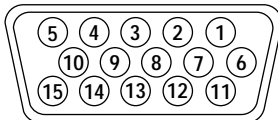

Pin No.	Function	Open	Established															
1 to 3	Not used																	
4	Power ON/OFF	ON	OFF															
5 and 14	Input switching The input mode is switched by the combination of pin numbers 5 and 14.																	
	<table border="1"> <thead> <tr> <th>Input</th> <th>Pin No. 5</th> <th>Pin No. 14</th> </tr> </thead> <tbody> <tr> <td>VIDEO</td> <td>Open</td> <td>Open</td> </tr> <tr> <td>RGB1</td> <td>Ground</td> <td>Open</td> </tr> <tr> <td>RGB2</td> <td>Open</td> <td>Ground</td> </tr> <tr> <td>RGB3</td> <td>Ground</td> <td>Ground</td> </tr> </tbody> </table>	Input	Pin No. 5	Pin No. 14	VIDEO	Open	Open	RGB1	Ground	Open	RGB2	Open	Ground	RGB3	Ground	Ground		
Input	Pin No. 5	Pin No. 14																
VIDEO	Open	Open																
RGB1	Ground	Open																
RGB2	Open	Ground																
RGB3	Ground	Ground																
6 to 8	Not used																	
9 and 10	Ground																	
11	TXD (RS-232C)																	
12	RTS																	
13	RXD (RS-232C)																	
15	CTS																	

2) External equipment side connector: Serial port (RS-232C) connector

See the specifications of the connected equipment for information about the type of connector and pin assignment.

Communication Parameters

- | | |
|--------------------------|--------------|
| (1) Communication system | Asynchronous |
| (2) Interface | RS-232C |
| (3) Baud rate | 9600 bps |
| (4) Data length | 8 bits |
| (5) Parity | Odd |
| (6) Stop bit | 1 bit |
| (7) Communication code | Hex |

Communication Format

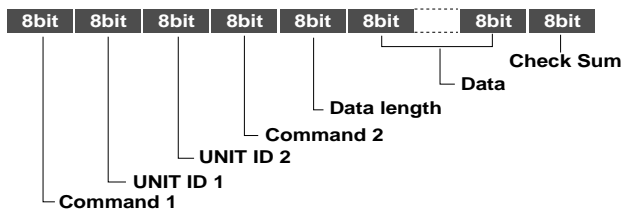

Command 1

Together with Command 2, this is a number that distinguishes the various commands.

For ACK, when bit 2 and bit 3 are both "1", reception of a supported command or data is indicated. When bit 2 is "0", reception of an unsupported command or data is indicated.

Bit 0 and bit 1 should be set as described below.

bit0	bit1	
0	0	When multiple screens are selected
0	1	Not used
1	0	At time of set ID selection
1	1	At time of regular use

Unit ID 1 and Unit ID 2

- Unit ID1: Sets a number corresponding to the various sets ID (1 through 4) when multiple screens are selected, and to 1 through 256 at the time of set ID selection. "00H" must be output when the ID is not set.
- Unit ID2: Makes settings on the occasion of simultaneously operating all sets connected in cascade at the time of multiple screen mode and at the time of set ID selection.

Selection of all sets: FFH

At time of regular setting: 00H

Command 2

Together with Command 1, this is a number that distinguishes the various commands.

Check Sum (CKS), Error Processing, and ACK

- Checks for receive data incorporate both the following checksum and RS-232C (odd) parity.

The checksum comprises the following aspects of one transmitted or received frame: Command 1, Unit 1 and 2, Command 2, data length, and the lower order 8 bits of the total data.

Check Sum Example

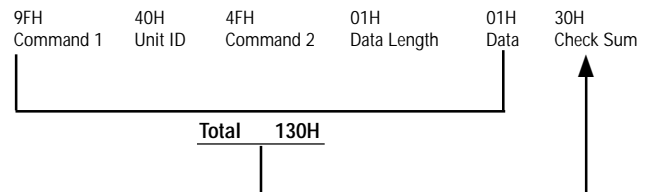

- Error Processing

- When the communications interval is 4 ms or greater, the arrival of a subsequent Command 1 will be recognized. If meaningful data cannot be discerned at this time, that data will not be recognized.

- When the receive data error, checksum error, and the receive data could not all be taken in, ACK is not returned.

- Returning an ACK

When command processing exceeds 0.5 seconds following command reception, an ACK1 for which bit 3 of Command 1 has been set to "0" (during command processing) is returned every 0.5 seconds until command processing is completed. When command processing is completed, an ACK2 for which bit 3 of Command 1 has been set to "1" (at the end of command processing) is returned every 0.5 seconds until command processing is completed. Bit 1 of Command 1 is set to 0; when the UA2 setting is FFH, it becomes possible to simultaneously operate all sets connected in cascade and as a result, ACK is not returned.

Communications Flow

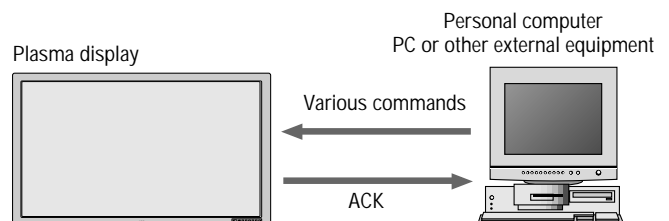

When various commands are sent from a personal computer (PC) or other external equipment, the display is always ready to receive them.

Note that resending of the command is recommended when an ACK is not returned from the display within 1.5 seconds.

Command Reference List

	CMD1	CMD2	LEN
01. Connect Request	4FH	39H	01H
02. Running Sense	4FH	88H	00H
03. Power ON	8FH	4EH	00H
04. Power OFF	8FH	4FH	00H
05. Input Switch Change	CFH	50H	01H
06. COLOR TEMP SELECT	CFH	00H	01H
07. RED Gain Data	CFH	10H	04H
08. GREEN Gain Data	CFH	11H	04H
09. BLUE Gain Data	CFH	12H	04H
10. GAMMA Gain Data	CFH	13H	03H
11. COLOR Gain Data	CFH	14H	03H
12. TINT Gain Data	CFH	15H	03H
13. SHARPNESS Gain Data	CFH	16H	03H
14. CONTRAST Gain Data	CFH	17H	03H
15. BRIGHT Gain Data	CFH	18H	03H
16. V.POS Gain Data	CFH	19H	03H
17. H.POS Gain Data	CFH	1AH	04H
18. PHASE Gain Data	CFH	1BH	03H
19. CLOCK Gain Data	CFH	1CH	03H
20. H POS2 GAIN DATA	CFH	1EH	03H
21. V POS2 GAIN DATA	CFH	1DH	03H
22. V-HEIGHT Gain Data	CFH	1FH	03H
23. H-WIDTH Gain Data	CFH	20H	03H
24. TIMER SWITCH	CFH	02H	01H
25. AUTO PICTURE Select	CFH	57H	02H
26. RESET	0FH	54H	01H
27. COLOR SYSTEM SELECT	CFH	5CH	01H
28. INPUT MODE Request	0FH	41H	00H
29. SCREEN MODE Request	0FH	42H	00H
30. VIDEO ADJ Request	0FH	45H	00H
31. SCREEN ADJ Request	0FH	47H	00H
32. COLOR SYSTEM Request	0FH	4CH	00H
33. FAILURE MODE Request	0FH	3FH	00H
34. SET CONDITION Info	0FH	40H	00H
35. SIGNAL Info	0FH	3EH	00H
36. SETTING MODE SELECT	CFH	04H	02H
37. SCREEN MODE Select	CFH	51H	01H
38. PICTURE Mute On	8FH	3CH	00H
49. PICTURE Mute Off	8FH	3DH	00H
40. MULTI MODE SETTING	CFH	03H	02H
41. MULTI MODE Request	0FH	3BH	00H
42. OSM SELECT	DFH	58H	01H

01. Connect Request

Function

The external control equipment requests a communications connection from the display.

When the display has received this command, it returns an ACK to the external control equipment and notifies that the connection is completed.

Transmission Data

4 FH UA1 UA2 39H 01H 00H CKS
CKS : Checksum

ACK

0 FH UA2 UA2 39H 00H CKS

02. Running Sense

Function

The external control equipment ascertains the power supply condition of the display and then causes the display to recognize the PC CONTROL connection.

Transmission Data

4 FH UA1 UA2 88H 00H CKS

ACK

0 FH UA1 UA2 88H 01H DATA CKS

DATA : Bit 0 : Connect Condition
0 : No connection
1 : Connected

Bit 1

0 : Fixed
1 : -

Bit 2 : Power Status

0 : POWER ON
1 : POWER OFF (STANBY)

Bit 3

0 : Fixed
1 : -

Bit 4

0 : Fixed
1 : -

Bit 5

0 : Fixed
1 : -

Bit 6

0 : Fixed
1 : -

Bit 7

0 : Fixed
1 : -

03. Power ON

Function

The external control equipment switches on the power of the display.

Transmission Data

8 FH UA1 UA2 4E 00H CKS

ACK

The display returns the following ACK when the power is switched on:

2 FH UA1 UA2 4E 00H CKS

04. Power OFF

Function

The external control equipment switches off the power of the display.

Transmission Data

8 FH UA1 UA2 4F 00H CKS

ACK

The display returns the following ACK when the power is switched off:

2 FH UA1 UA2 4F 00H CKS

05. Input Switch Change

Function

The external control equipment switches the input of the display.

Transmission Data

CFH UA1 UA2 50H 01H DATA CKS
DATA : Input Select
01H: Video
07H: RGB1
08H: RGB2
0CH: RGB3

ACK

The display returns the following ACK when the input is switched:
2FH UA1 UA2 50H 00H CKS

06. COLOR TEMP SELECT

Function

The external control equipment changes the COLOR TEMP of the display.

Transmission Data

CFH UA1 UA2 00H 01H DATA00 CKS
DATA00
00H: HIGHT
01H: LOW
02H: USER

ACK

6FH UA1 UA2 00H 01H DATA00 CKS
DATA00:
00H: HIGHT
01H: LOW
02H: USER

Notes When HIGHT or LOW is selected with COLOR TEMP, changes of the R/G/B GAIN data on the next page will not be received.

07. RED Gain Data

Function

The external control equipment changes the RED gain data of the display. (This command will be received only when COLOR TEMP is set by the USER.)

Transmission Data

CFH UA1 UA2 10H 04H DATA00~DATA03 CKS
DATA00 : USER PICTURE Gain Flag 01H

DATA01 : RED Gain Flag 01H

DATA02 : RED Gain E0H: -32
|
FFH: -1
00H: 0
|
20H: +32

DATA03 : RED Bias E0H: -32
|
FFH: -1
00H: 0
|
20H: +32

ACK

6FH UA1 UA2 10H 02H DATA00 DATA01 CKS
DATA00 : USER PICTURE Gain Flag 01H

DATA01 : RED Gain Flag 01H

08. GREEN Gain Data

Function

The external control equipment changes the GREEN gain data of the display. (This command will be received only when COLOR TEMP is set by the USER.)

Transmission Data

CFH UA1 UA2 11H 04H DATA00~DATA03 CKS

DATA00 : USER PICTURE Gain Flag 01H

DATA01 : GREEN Gain Flag 02H

DATA02 : GREEN Gain E0H: -32
|
FFH: -1
00H: 0

DATA03 : GREEN Bias E0H: -32
|
FFH: -1
00H: 0

|
20H: +32

ACK

6FH UA1 UA2 11H 02H DATA00 DATA01 CKS
DATA00 : USER PICTURE Gain Flag 01H

DATA01 : GREEN Gain Flag 02H

09. BLUE Gain Data

Function

The external control equipment changes the BLUE gain data of the display. (This command will be received only when COLOR TEMP is set by the USER.)

Transmission Data

CFH UA1 UA2 12H 04H DATA00~DATA03 CKS
DATA00 : USER PICTURE Gain Flag 01H

DATA01 : BLUE Gain Flag 03H

DATA02 : BLUE Gain E0H: -32
|
FFH: -1
00H: 0
|
20H: +32

DATA03 : BLUE Bias E0H: -32
|
FFH: -1
00H: 0
|
20H: +32

ACK

6FH UA1 UA2 12H 02H DATA00 DATA01 CKS
DATA00 : USER PICTURE Gain Flag 01H
DATA01 : BLUE Gain Flag 03H

10. GAMMA Gain Data

Function

The external control equipment changes the GAMMA gain data of the display.

Transmission Data

CFH UA1 UA2 13H 03H DATA00~DATA02 CKS
DATA00 : USER PICTURE Gain Flag 01H
DATA01 : Gamma Gain Flag 09H
DATA02 : Gamma Gain 00H : 1
01H : 2
02H : 3

ACK

6FH UA1 UA2 13H 02H DATA00 DATA01 CKS
DATA00 : USER PICTURE Gain Flag 01H
DATA01 : Gamma Gain Flag 09H

11. COLOR Gain Data

Function

The external control equipment changes the COLOR gain data of the display.

Transmission Data

CFH UA1 UA2 14H 03H DATA00~DATA02 CKS
 DATA00 : USER PICTURE Gain Flag 01H

 DATA01 : COLOR Gain Flag 04H

 DATA02 : COLOR Gain EAH: -22
 |
 FFH: -1
 00H: 0
 |
 16H: +22

ACK

6FH UA1 UA2 14H 02H DATA00 DATA01 CKS
 DATA00 : USER PICTURE Gain Flag 01H

 DATA01 : COLOR Gain Flag 04H

12. TINT Gain Data

Function

The external control equipment changes the TINT gain data of the display.

Transmission Data

CFH UA1 UA2 15H 03H DATA00~DATA02CKS
 DATA00 : USER PICTURE Gain Flag 01H

 DATA01 : TINT Gain Flag 05H

 DATA02 : TINT Gain EAH: -22
 |
 FFH: -1
 00H: 0
 |
 16H: +22

ACK

6FH UA1 UA2 15H 02H DATA00 DATA01 CKS
 DATA00 : USER PICTURE Gain Flag 01H

 DATA01 : TINT Gain Flag 05H

13. SHARPNESS Gain Data

Function

The external control equipment changes the SHARPNESS gain data of the display.

Transmission Data

CFH UA1 UA2 16H 03H DATA00~DATA02 CKS
 DATA00 : USER PICTURE Gain Flag 01H

 DATA01 : SHRPNESS Gain Flag 06H

 DATA02 : SHRPNESS Gain F0H: -16
 |
 FFH: -1
 00H: 0
 |
 10H: +16

ACK

6FH UA1 UA2 16H 02H DATA00 DATA01 CKS
 DATA00 : USER PICTURE Gain Flag 01H

 DATA01 : SHRPNESS Gain Flag 06H

14. CONTRAST Gain Data

Function

The external control equipment changes the CONTRAST gain data of the display.

Transmission Data

CFH UA1 UA2 17H 03H DATA00~DATA02 CKS
 DATA00 : USER PICTURE Gain Flag 01H

 DATA01 : CONTRAST Gain Flag 07H

 DATA02 : CONTRAST Gain 00H: 0
 |
 3FH: 63

ACK

6FH UA1 UA2 17H 02H DATA00 DATA01 CKS
 DATA00 : USER PICTURE Gain Flag 01H

 DATA01 : CONTRAST Gain Flag 07H

15. BRIGHT Gain Data

Function

The external control equipment changes the BRIGHT gain data of the display.

Transmission Data

CFH UA1 UA2 18H 03H DATA00~DATA02 CKS
 DATA00 : USER PICTURE Gain Flag 01H

 DATA01 : BRIGHT Gain Flag 08H

 DATA02 : BRIGHT Gain C0H: -64
 |
 FFH: -1
 00H: 0
 |
 40H: +64

ACK

6FH UA1 UA2 18H 02H DATA00 DATA01 CKS
 DATA00 : USER PICTURE Gain Flag 01H

 DATA01 : BRIGHT Gain Flag 08H

16. V.POSITION Gain Data

Function

The external control equipment changes the V. POSITION gain data of the display.

Transmission Data

CFH UA1 UA2 19H 03H DATA00~DATA02 CKS
 DATA00 : USER POSITION Gain Flag 03H
 DATA01 : V.POSITION Gain Flag 01H
 DATA02 : V.POSITION Gain C0H: -64
 |
 FFH: -1
 00H: 0
 |
 40H: +64

ACK

6FH UA1 UA2 19H 02H DATA00 DATA01 CKS
 DATA00 : USER POSITION Gain Flag 03H
 DATA01 : V.POSITION Gain Flag 01H

17. H.POSITION Gain Data

Function

The external control equipment changes the H. POSITION gain data of the display.

Transmission Data

CFH UA1 UA2 1AH 03H DATA00~DATA02~CKS
 DATA00 : USER POSITION Gain Flag 03H
 DATA01 : H.POSITION Gain Flag 02H
 DATA02 : H.POSITION Gain C0H : -64
 |
 FFH : -1
 00H : 0
 |
 40H : +64

ACK

6FH UA1 UA2 1AH 02H DATA00 DATA01 CKS
 DATA00 : USER POSITION Gain Flag 03H
 DATA01 : H.POSITION Gain Flag 02H

18. PHASE Gain Data

Function

The external control equipment changes the clock phase of the display. (This command will be received only when AUTO PICTURE is OFF.)

Transmission Data

CFH UA1 UA2 1BH 03H DATA00 DATA01
 DATA02 CKS
 DATA00 : USER POSITION Gain Flag 03H
 DATA01 : PHASE Gain Flag 03H
 DATA02 : PHASE Gain 00H : 0
 |
 1FH : 31

ACK

6FH UA1 UA2 1BH 02H DATA00 DATA01 CKS
 DATA00 : USER POSITION Gain Flag 03H
 DATA01 : PHASE Gain Flag 03H

19. CLOCK Gain Data

Function

The external control equipment changes the division ratio of the display. (This command will be received only when AUTO PICTURE is OFF.)

Transmission Data

CFH UA1 UA2 1CH 03H DATA00~DATA02 CKS
 DATA00 : USER POSITION Gain Flag 03H
 DATA01 : CLOCK Gain Flag 04H
 DATA02 : CLOCK Gain E0H : -32
 |
 FFH : -1
 00H : 0
 |
 20H : +32

ACK

6FH UA1 UA2 1CH 02H DATA00 DATA01 CKS
 DATA00 : USER POSITION Gain Flag 03H
 DATA01 : CLOCK Gain Flag 04H

20. H.POSITION 2 Gain Data

Function

The external control equipment changes the H. POSITION 2 (screen cut position) data of the display.

Transmission Data

CFH UA1 UA2 1EH 03H DATA00~DATA02 CKS
 DATA00 : USER POSITION Gain Flag 09
 DATA01 : H.POSITION Gain Flag 02H
 DATA02 : H.POSITION Gain C0H : -64
 |
 FFH : -1
 00H : 0
 |
 40H : +64

ACK

6FH UA1 UA2 1EH 02H DATA00 DATA01 CKS
 DATA00 : USER POSITION Gain Flag 09
 DATA01 : H.POSITION2 Gain Flag 02H

21. V.POSITION 2 Gain Data

Function

The external control equipment changes the V. POSITION 2 (screen cut position) data of the display.

Transmission Data

CFH UA1 UA2 1DH 03H DATA00~DATA02 CKS
 DATA00 : USER POSITION Gain Flag 09
 DATA01 : V.POSITION2 Gain Flag 01H
 DATA02 : V.POSITION2 Gain C0H : -64
 |
 FFH : -1
 00H : 0
 |
 40H : +64

ACK

6FH UA1 UA2 1DH 02H DATA00 DATA01 CKS
 DATA00 : USER POSITION Gain Flag 09
 DATA01 : V.POSITION2 Gain Flag 01H

22. V-HEIGHT Gain Data

Function

The external control equipment changes the V-HEIGHT (horizontal expansion ratio) of the display. (This command will be received only when multi screen is ON.)

Transmission Data

CFH UA1 UA2 1FH 03H DATA00~DATA02 CKS
 DATA00 : USER POSITION Gain Flag 09
 DATA01 : V-HEIGHT Gain Flag 03H
 DATA02 : V-HEIGHT Gain 80H : -128
 |
 FFH : -1
 0H : 0
 |
 7FH : +127

ACK

6FH UA1 UA2 1FH 02H DATA00 DATA01 CKS
 DATA00 : USER POSITION Gain Flag 09
 DATA01 : V-HEIGHT Gain Flag 03H

23. H-WIDTH Gain Data

Function

The external control equipment changes the H-WIDTH (vertical expansion ratio) of the display. (This command will be received only when multi screen is ON.)

Transmission Data

CFH UA1 UA2 20H 03H DATA00~DATA02 CKS
 DATA00 : USER POSITION Gain Flag 09
 DATA01 : H-WIDTH Gain Flag 04H
 DATA02 : H-WIDTH Gain 80H : -128
 |
 FFH : -1
 0H : 0
 |
 7FH : +127

ACK

6FH UA1 UA2 20H 02H DATA00 DATA01 CKS
 DATA00 : USER POSITION Gain Flag 09
 DATA01 : H-WIDTH Gain Flag 04H

24. TIMER SWITCH

Function

The external control equipment changes the timer on/off switching of the display.

Transmission Data

CFH UA1 UA2 02H 01H DATA00 CKS
DATA00: 0 RESERVE OFF
 1 RESERVE ON

ACK

6FH UA1 UA2 02H 01H DATA00 CKS
DATA00: 0 RESERVE OFF
 1 RESERVE ON

25. AUTO PICTURE Select

Function

The external control equipment switches the AUTO PICTURE of the display on and off.

Transmission Data

CFH UA1 UA2 57H 02H DATA00 DATA01 CKS
DATA00 01H: AUTO PICTURE ON
 02H: AUTO PICTURE OFF
DATA01 01H: MODE NORMAL
 02H: MODE WIDE

ACK

6FH UA1 UA2 57H 02H DATA00 DATA01 CKS
DATA00 01H: AUTO PICTURE ON
 02H: AUTO PICTURE OFF
DATA01 01H: MODE NORMAL
 02H: MODE WIDE

26. RESET

Function

The external control equipment resets the user adjustment items of the display.

Transmission Data

0FH UA1 UA2 54H 01H DATA00 CKS
DATA00 00H: ALL NORMAL
 01H: RASTER NORMAL
 02H: VISUAL NORMAL

ACK

2FH UA1 UA2 54H 01H DATA00 CKS
DATA00 00H: ALL NORMAL
 01H: RASTER NORMAL
 02H: VISUAL NORMAL

*The operation is the same as when the remote control key has been entered.

27. COLOR SYSTEM Select

Function

The external control equipment selects the color system settings of the display.

Transmission Data

CFH UA1 UA2 5CH 01H DATA00 CKS
DATA00 01H: NTSC3. 58
 02H: NTSC4. 43
 03H: PAL
 04H: SECAM
 96H: AUTO

ACK

6FH UA1 UA2 5CH 01H DATA00 CKS
DATA00 01H: NTSC3. 58
 02H: NTSC4. 43
 03H: PAL
 04H: SECAM
 96H: AUTO

28. INPUT MODE Request

Function

The display returns the current status for input mode requests of the external control equipment.

Transmission Data

0FH UA1 UA2 41H 00H CKS

ACK

6FH UA1 UA2 41H 01H DATA00 CKS
DATA00: Input Select
 01H: Video
 02H: RGB1
 03H: RGB2
 04H: RGB3

29. SCREEN MODE Request

Function

The display returns the current status for screen mode requests of the external control equipment.

Transmission Data

0FH UA1 UA2 42H 00H CKS

ACK

6FH UA1 UA2 42H 01H DATA00 CKS
DATA00 02H: STADIUM
 03H: ZOOM
 04H: NORMAL
 05H: FULL

30. VIDEO ADJ Request

Function

The display returns the current status for video adjustment information requests of the external control equipment.

Transmission Data

0FH UA1 UA2 45H 00H CKS

ACK

6FH UA1 UA2 45H 0CH DATA00~DATA0B CKS
DATA00: RED Gain E0H: -32
 |
 FFH: -1
 00H: 0
 |
 20H: +32
DATA01: GREEN Gain E0H: -32
 |
 FFH: -1
 00H: 0
 |
 20H: +32
DATA02: BLUE Gain E0H: -32
 |
 FFH: -1
 00H: 0
 |
 20H: +32
DATA03: COLOR Gain E0H: -22
 |
 FFH: -1
 01H: 0
 |
 16H: +22
DATA04: TINT Gain E0H: -22
 |
 FFH: -1
 01H: 0
 |

DATA 05 : SHRPNESS Gain
 FFH : -1
 01H : 0
 |
 16H : +22
 F0H : -16
 |
 FFH : -1
 01H : 0
 |
 10H : +16
 00H : 0
 |
 DATA 06 : CONTRAST Gain
 3FH : 63
 C0H : -64
 |
 DATA 07 : BRIGHT Gain
 FFH : -1
 00H : 0
 |
 40H : +64
 E0H : -32
 |
 DATA 08 : RED Bias
 FFH : -1
 00H : 0
 |
 20H : +32
 E0H : -32
 |
 DATA 09 : GREEN Bias
 FFH : -1
 00H : 0
 |
 20H : +32
 E0H : -32
 |
 DATA 0A : BLUE Bias
 FFH : -1
 00H : 0
 |
 20H : +32
 00H : 1
 01H : 2
 02H : 3

Notes In the currently displayed mode, 00H is output when the memory area of the various items does not exist.

31. SCREEN ADJ Request

Function

The display returns the current status for screen adjustment information requests of the external control equipment.

Transmission Data

0FH UA1 UA2 47H 00H CKS

ACK

6FH UA1 UA2 47H 08H DATA00~DATA07 CKS

DATA 00 : V.POSITION Gain
 C0H : -64
 |
 FFH : -1
 00H : 0
 |
 40H : +64
 C0H : -64
 |
 DATA 01 : H.POSITION Gain
 FFH : -1
 00H : 0
 |
 40H : +64
 00H : 0
 |
 DATA 02 : PHASE Gain
 1FH : 31

DATA 03 : CLOCK Gain
 C0H : -32
 |
 FFH : -1
 00H : 0
 |
 20H : +32
 |
 DATA 04 : V.POSITION2 Gain
 C0H : -64
 |
 FFH : -1
 00H : 0
 |
 40H : +64
 |
 DATA 05 : H.POSITION2 Gain
 C0H : -64
 |
 FFH : -1
 00H : 0
 |
 40H : +64
 |
 DATA 06 : V-HEIGHT Gain
 80H : -128
 |
 FFH : -1
 0H : 0
 |
 7FH : +127
 |
 DATA 07 : H-WIDTH Gain
 80H : -128
 |
 FFH : -1
 0H : 0
 |
 7FH : +127

Notes In the currently displayed mode, 00H is output when the memory area of the various items does not exist.

32. COLOR SYSTEM Request

Function

The display returns the current status for color system information requests of the external control equipment.

Transmission Data

0FH UA1 UA2 4CH 00H CKS

ACK

6FH UA1 UA2 4CH 01H DATA00 CKS
 DATA00

01H NTSC3.58
 02H NTSC4.43
 03H PAL
 04H SECAM

33. FAILURE MODE Inform

Function

The display informs the external control equipment of the failure mode for requests of failure detection information by the external control equipment.

Transmission Data

0 FH UA1 UA2 3 FH 00H CKS

ACK

6 FH UA1 UA2 3 FH 02H DATA00 DATA01 CKS
DATA 0 0

Bit0 (PDPmodule)	} 0 : Fault 1 : Normal
Bit1 (POWER SUPPLY)	
Bit2 (TEMPERATURE)	
Bit3 (FAN)	
Bit4 A12V	
Bit5 D5V	
Bit6 notused	
DATA 0 1	
Bit0 D3.3V	} 0 : Fault 1 : Normal
Bit1~7 : 0 Fixed	

34. SET CONDITION Inform

Function

The display informs the external control equipment of the set's condition information for requests of the set's condition information by the external control equipment.

Transmission Data

0 FH UA1 UA2 4 0H 00H CKS

ACK

6 FH UA1 UA2 4 0H 17H DATA00~DATA22 CKS

*Accumulated set usage time display

DATA 1 2	Bit 0 (LSB)	} The set's accumulative time in 5 digits is displayed with 4 bits per digit and the first digit is displayed from Bit 0 of DATA12.
	Bit 7	
DATA 1 3	Bit 0	
	Bit 7	
DATA 1 4	Bit 0	
	Bit 3 (MSB)	
	Bit4~7 : 0 fixed	

*Microprocessor version display

Display example VER 1. 0

DATA 1 5	Bit 0 (LSB)	} Microprocessor version decimal point and first right digit
	Bit 3 (MSB)	
	Bit 4 (LSB)	} Microprocessor version first digit
	Bit 7 (MSB)	

*Current time display

1 character is expressed in 4 bits.

DATA 1 6	Bit 0	} Seconds 1's digit
	Bit 3	
	Bit 4	} Seconds 10's digit
	Bit 7	

DATA 1 7	Bit 0	} Minutes 1's digit
	Bit 3	
	Bit 4	} Minutes 10's digit
	Bit 7	
DATA 1 8	Bit 0	} Hours 1's digit
	Bit 3	
	Bit 4	} Hours 10's digit
	Bit 7	
DATA 1 9	Bit 0	} Day 1's digit
	Bit 3	
	Bit 4	} Day 10's digit
	Bit 7	
DATA 2 0	Bit 0	} Month 1's digit
	Bit 3	
	Bit 4	} Month 10's digit
	Bit 7	
DATA 2 1	Bit 0	} Year 1's digit
	Bit 3	
	Bit 4	} Year 10's digit
	Bit 7	
DATA 2 2	Bit 0	0 : Power management OFF 1 : Power management ON
	Bit 1	0 : Wireless remote control OFF 1 : Wireless remote control ON
	Bit 2	0 : Timer OFF 1 : Timer ON
	Bit3~7	: "0" fixed

35. SIGNAL Inform

Function

The display informs the external control equipment of the input signal information for requests of input signal information by the external control equipment.

Transmission Data

0 FH UA1 UA2 3 EH 00H CKS

ACK

6 FH UA1 UA2 3 EH 04H DATA00~DATA03 CKS

DATA 0 0

Bit 7~4 : Displays the 10's digit of the horizontal frequency. (0 to 9)

Bit 3~0 : Displays the 1's digit of the horizontal frequency. (0 to 9)

DATA 0 1

Bit 7~4 : Displays the decimal point and the first right digit of the horizontal frequency. (0 to 9)

Bit 3 : Horizontal sync polarity display 1 : Negative

1 : Positive

Bit 2 : Vertical sync polarity display 0 : Negative

1 : Positive

Bit 1, 0 : "0" fixed

DATA 0 2

Bit 7~4 : Displays the 10's digit of the vertical frequency. (0 to 9)

Bit 3~0 : Displays the 1's digit of the vertical frequency. (0 to 9)

DATA 0 3

Bit 7~4 : Displays the decimal point and the first right digit of the vertical frequency. (0 to 9)

Bit 3~0 : "0" fixed

"00H" is output when there is no signal.

36. SETTING MODE SELECT

Function

The external control equipment changes the settings of the various items of the display.

Transmission Data

CFH UA1UA2 04H 02H DATA00 DATA01 CKS
DATA00

Bit 0 0 POWER ON MODE OFF (LAST MEMORY)
1 POWER ON MODE ON

Bit 2 Bit 1 (Available only when BIT0 is set to 1)

0 0 : POWER ON MODE VIDEO

0 1 : POWER ON MODE RGB1

1 0 : POWER ON MODE RGB2

1 1 : POWER ON MODE RGB3

Bit 3 0 : POWER MANEGER OFF

1 : POWER MANEGER ON

Bit 4 0 : LONG LIFE MODE 1 OFF

1 : LONG LIFE MODE 1 ON

Bit 5 0 : LONG LIFE MODE 2 OFF

1 : LONG LIFE MODE 2 ON

Bit 7 Bit 6

0 0 : GRAY LEVEL 1

0 1 : GRAY LEVEL 2

1 0 : GRAY LEVEL 3

DATA01

Bit 0 Bit 1

0 0 : RGB MODE STILL

1 0 : RGB MODE MOTION

0 1 : RGB MODE DTV

Bit2 Bit3

0 0 : LONG LIFE MODE 3 OFF

1 0 : LONG LIFE MODE 3 INV

0 1 : LONG LIFE MODE 3 ALL WHITE

1 1 : not used

Notes When the plasma monitor is turned ON or OFF, LONG LIFE MODE 3 setting is set to off and the last data is not stored in memory.

ACK

7FH UA1 UA2 04H 02H DATA00 DATA01 CKS

37. SCREEN MODE Select

Function

The external control equipment switches the screen mode of the display.

Transmission Data

CFH UA1 UA2 51H 01H DATA00 CKS
DATA00

02H : STADIUM

03H : ZOOM

04H : NORMAL

05H : FULL

ACK

6FH UA1 UA2 51H 01H DATA00 CKS
DATA00

02H : STADIUM

03H : ZOOM

04H : NORMAL

05H : FULL

38. PICTURE Mute On

Function

The external control equipment switches on PICTURE Mute of the display.

Transmission Data

8FH UA1 UA2 3CH 00H CKS

ACK

2FH UA1 UA2 3CH 00H CKS

39. PICTURE Mute Off

Function

The external control equipment switches off PICTURE Mute of the display.

Transmission Data

8FH UA1 UA2 3DH 00H CKS

ACK

2FH UA1 UA2 3DH 00H CKS

40. MULTI MODE Select

Function

The external control equipment changes the MULTI MODE of the display.

Transmission Data

CFH UA1 UA2 03H 02H DATA00 DATA01 CKS

DATA00 (SCREEN DIVIDER SETTING)

01H : Single mode

03H : Multiple screens mode 4 screens

DATA01 (POSITION OF DIVIDE)

01H : Screen upper left selection (4 screens)

02H : Screen upper right selection (4 screens)

03H : Screen lower right selection (4 screens)

04H : Screen lower left selection (4 screens)

When the single mode has been selected with DATA00, set this bit between 01 and 06H.

ACK

7FH UA1 UA2 03H 02H DATA00 DATA01 CKS

DATA00 (SCREEN DIVIDER SETTING)

01H : Single mode

03H : Multiple screens mode 4 screens

DATA01 (POSITION OF DIVIDE)

01H : Screen upper left selection (4 screens)

02H : Screen upper right selection (4 screens)

03H : Screen lower right selection (4 screens)

04H : Screen lower left selection (4 screens)

41. MULTI MODE Request

Function

The MULTI MODE status of the display is requested for MULTI MODE information requests of the external control equipment.

Transmission Data

0FH UA1 UA2 3BH 00H CKS

ACK

6FH UA1 UA2 3BH 02H DATA00 DATA01 CKS

DATA00 (SCREEN DIVIDER SETTING)

01H : Single mode

03H : Multiple screens mode 4 screens

DATA01 (POSITION OF DIVIDE)

01H : Screen upper left selection (4 screens)

02H : Screen upper right selection (4 screens)

03H : Screen lower right selection (4 screens)

04H : Screen lower left selection (4 screens)

42. OSM SELECT

Function

The external equipment switches the on-screen display (OSM) of the display unit ON and OFF.

Transmission Data

```
DFH 8 0H 6 0H 5 8H 0 1H DATA00 CKS
  DATA00
    0 1H : OSM ON(During normal operation)
    0 2H : OSM OFF
```

ACK

```
7FH 6 0H 8 0H 5 8H 0 1H DATA00 CKS
  DATA00
    0 1H : OSM ON
    0 2H : OSM OFF
```

* Use this command with the setting of bits 0 and 1 fixed as follows: bit 0 = 1, and bit 1 = 1.

* ACK should be ignored in the case of a cascade connection.

Cabinet dimensions Unit : inch(mm)

PlasmaSync 42PD2 (Model PX-42VP2A)

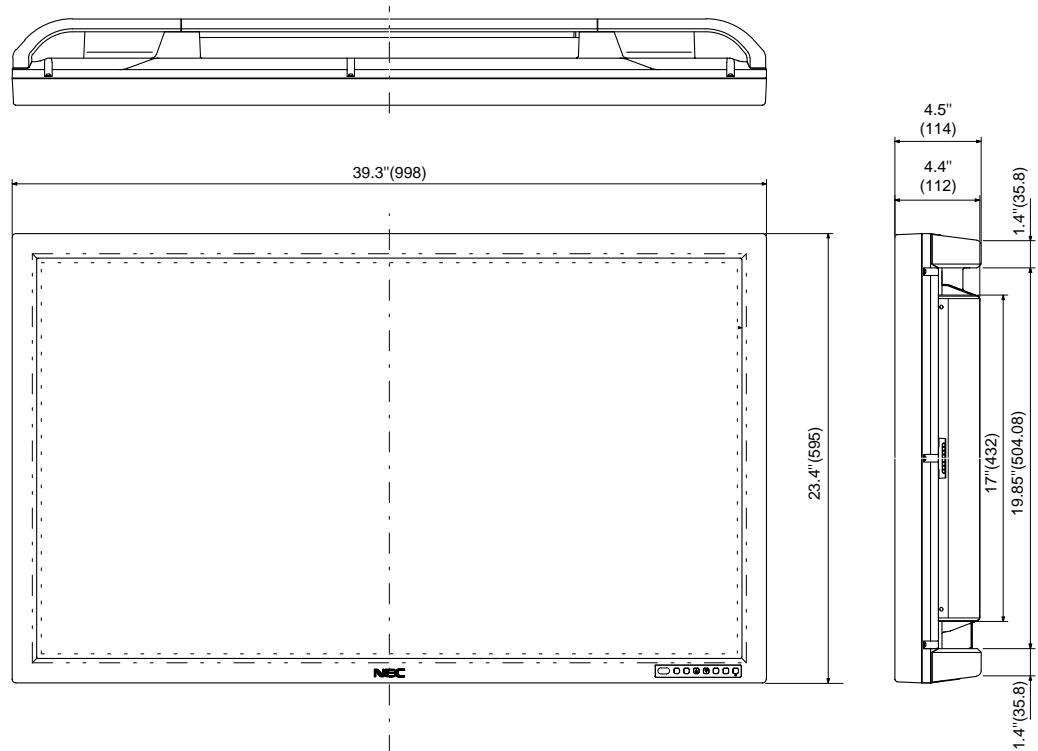

PlasmaSync 50PD1 (Model PX-50VP1A)

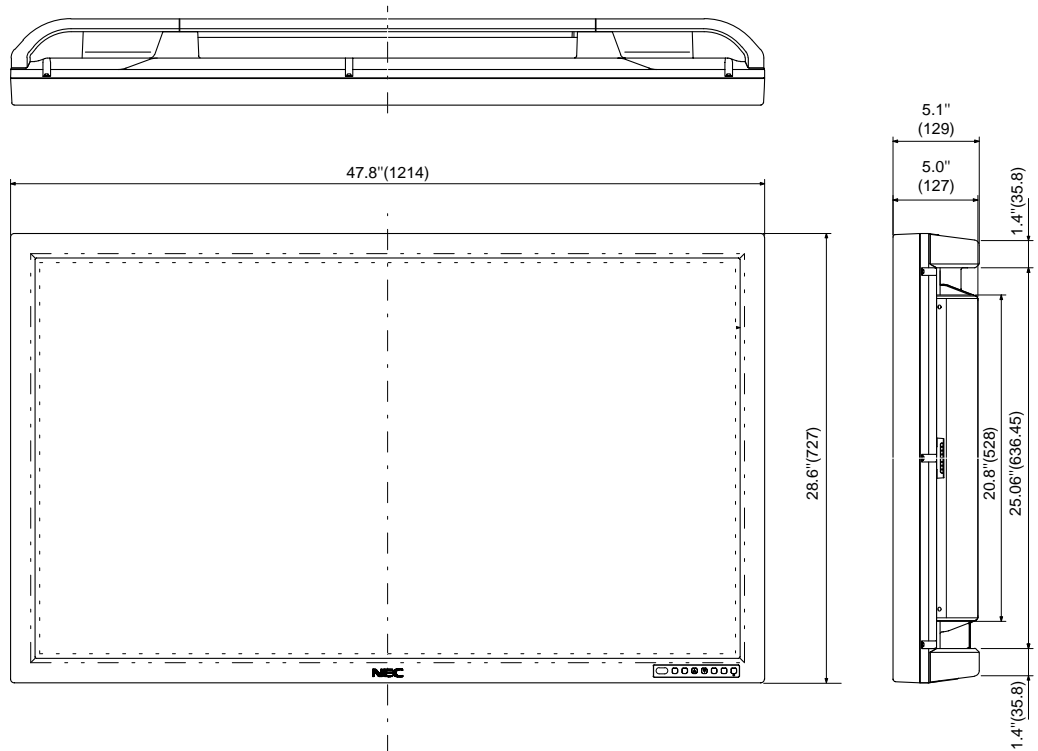

NEC

NEC Technologies, Inc.
1250 N. Arlington Heights Road, Suite 500
Itasca, Illinois 60143-1248

Free Manuals Download Website

<http://myh66.com>

<http://usermanuals.us>

<http://www.somanuals.com>

<http://www.4manuals.cc>

<http://www.manual-lib.com>

<http://www.404manual.com>

<http://www.luxmanual.com>

<http://aubethermostatmanual.com>

Golf course search by state

<http://golfingnear.com>

Email search by domain

<http://emailbydomain.com>

Auto manuals search

<http://auto.somanuals.com>

TV manuals search

<http://tv.somanuals.com>