

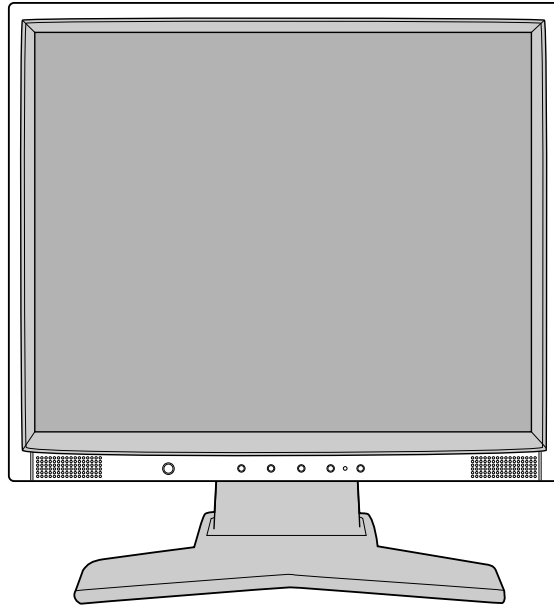

**NEC**



用户手册

**USER'S MANUAL**

**LCD1504M/LCD1704M/LCD1904M**

# Index

---

警告 .....	1
包装清单 .....	2
使用入门 .....	3
控制 .....	7
建议使用 .....	10
规格 .....	12
功能特点 .....	15
疑难解答 .....	16
TCO'99 .....	17

Warning .....	19
Contents .....	20
Quick Start .....	21
Controls .....	25
Recommended Use .....	28
Specifications .....	30
Features .....	33
Troubleshooting .....	34
TCO'99 .....	35



## 警告



为防止发生火灾或电击，请不要使本设备遭受雨淋或受潮。另外，如果接头没有完全插入，请勿配合延长线插座或其它插座使用本设备的极化插头。

内有高压，请勿打开机壳。设备维修只能由专业技术人员进行。



## 注意



注意：为避免电击危险，确保已经从墙上插座上按下电源线。要完全断开设备电源，请从交流电源插座上按下电源线。请勿卸下护盖（或后盖）。设备内部没有用户可维护的零件。设备维修只能由专业技术人员进行。



该符号警告用户，设备内有高压，可能会造成电击。因此，接触任何零件都是很危险的。



该符号提醒用户，有关本设备操作和维护的重要信息已经提供。因此，用户应仔细阅读，避免造成问题。

## 制造商声明

我们特此声明，液晶显示器

LCD1504M/LCD1704M/LCD1904M

符合

Council Directive 73/23/EEC:

- EN 60950-1

Council Directive 89/336/EEC:

- EN 55022

- EN 61000-3-2

- EN 61000-3-3

- EN 55024

标有



NEC DISPLAY SOLUTIONS

日本国东京都港区芝浦四丁目

13番23号

Windows 是 Microsoft Corporation 的注册商标。NEC 是 NEC Corporation 的注册商标。ENERGY STAR（能源之星）是一个美国注册商标。其它所有品牌和产品名称均是各自拥有人的商标或注册商标。

作为 ENERGY STAR® 合作伙伴，NEC DISPLAY SOLUTIONS of America 确认本产品符合 ENERGY STAR 能源效率方面的规范。ENERGY STAR 标志不代表 EPA 认可任何产品或服务。

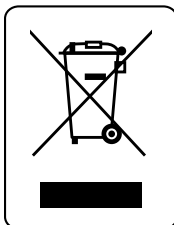

欧盟的私人住宅用户对垃圾设备的处理。

产品或其包装上的这个标记表示的是，该产品不得与您其他的家庭垃圾一起处理。相反，将您的垃圾设备交给指定的收集点，使废弃电器设备得以回收，是您的责任。您在处理垃圾设备时将其分类收集与回收，有助于保护天然资源，并在回收利用时，保护人体健康与环境。有关您可以将垃圾设备放在何处回收的更多信息，请联系您所在城市的办公室，您购买产品的家庭垃圾处理服务处或商店。

# 包装清单

这款新的 NEC 液晶显示器包装箱\* 应包括以下项目:

- LCD 显示器
- 音频线
- 电源线
- 用户手册
- 视频信号线
- 底座
- 电缆固定夹

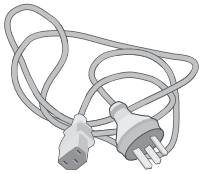

电源线



视频信号线

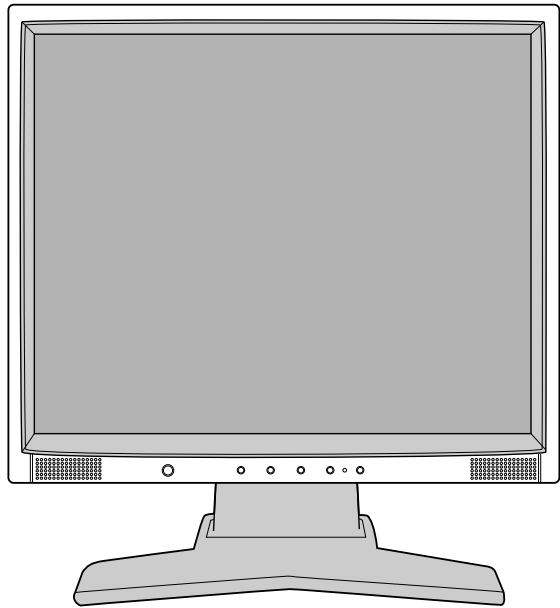
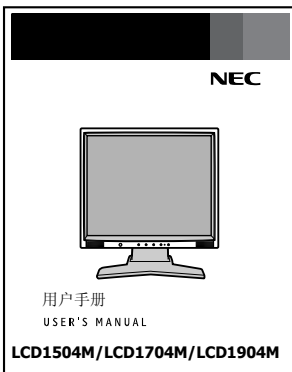

显示器  
(未装底座)



电缆固定夹



底座



音频线

\* 记住把原始包装箱和包装材料保存起来, 以备搬运显示器时使用。

# 使用入门

将底座装到**液晶显示器**支架上:

1. 将**液晶显示器**支架的前面插入到底座前面的槽孔内（图 1）。
2. 然后，调整**液晶显示器**支架后边的锁片与底座上槽孔的位置。  
按下支架，直到锁片卡紧。

要安装线卡:

1. 将线卡上的突出点插入支架颈部的小孔中（图 2）。请注意：请确定突出点要完全稳固下来。



图 1



图 2

要将 LCD 显示器安装到系统上，需遵照下列的指示说明:

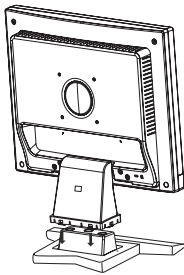
1. 关闭电脑电源。
2. **针对带有模拟输出的 PC:** 将 15-针迷你 D-SUB 信号线连接到系统中的显卡连接器上（图 A.1）。  
上紧所有螺丝。**针对 Mac:** 将 Macintosh 电缆适配器（未包括在内）连接到电脑上。  
将 15 针迷你 D-SUB 信号线连接到 Macintosh 电缆适配器上（图 A.2）。上紧所有螺丝。

**注释:** 有些 Macintosh 系统并不需要电缆适配器。

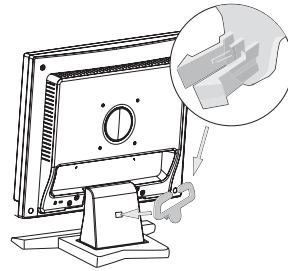
3. 将视频信号线和音频线的 15 针迷你 D-SUB 连接到本显示屏背后相应的连接器上（图 B.1）。
4. 将头戴式耳机（未包括在内）连接到本显示器正面上相应的连接器上（图 C.1）。
5. 将电源线的一端连接到显示器上，另一端连接到电源插座上。将视频信号线和电源电缆放在线卡上（图 B.1）。

**注释:** 调整放在线卡下面的电缆的位置以避免损害电缆或显示屏。

# 使用入门 — 续

图 A.1



电源线

图 A.2

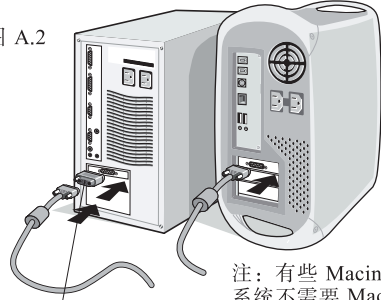

Macintosh 电缆适配器  
(未提供)

注: 有些 Macintosh  
系统不需要 Macintosh  
电缆适配器



图 B.1

连接至电脑音频输出

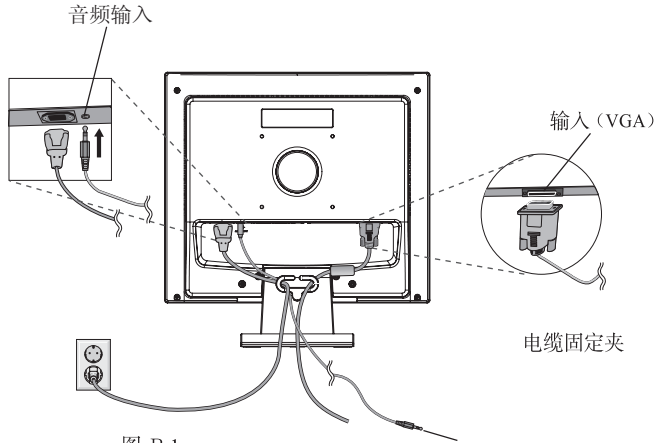
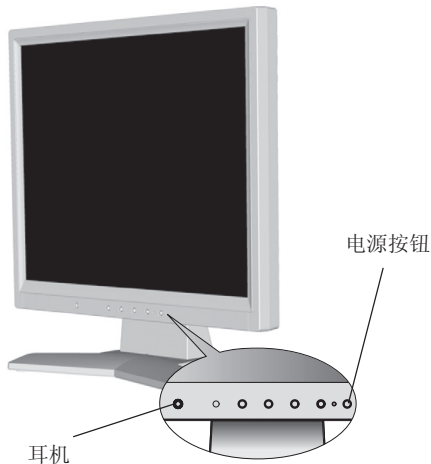

耳机

电源按钮

# 使用入门 - 续

## 倾斜

用双手抓住显示器屏幕的两边，根据需要调整其倾斜度（图 TS.1）。

注：倾斜显示器屏幕时要特别小心。

图 TS.1

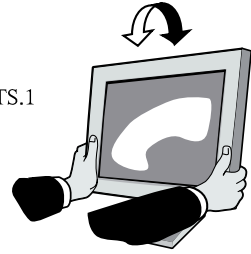

## 卸下显示器固定支架

用另外一种方式固定显示器：

1. 断开所有电缆。
2. 将显示器面朝下放在一个平整的表面上（图 R.1）。
3. 卸下用来把显示器固定到支架的 4 颗螺丝，从**液晶显示器**中拉出支架（图R.1）。

现在显示器可以用另外一种方式固定了。

4. 将交流电源线和信号线连接到显示器的背后（图 R.2）。
5. 以反向顺序执行此过程，重新装上支架。

注：只能使用符合 VESA 规范的备选固定方法。

注：卸下显示器支架时要特别小心。

图 R.1

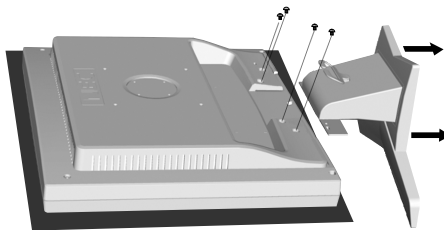

图R. 2

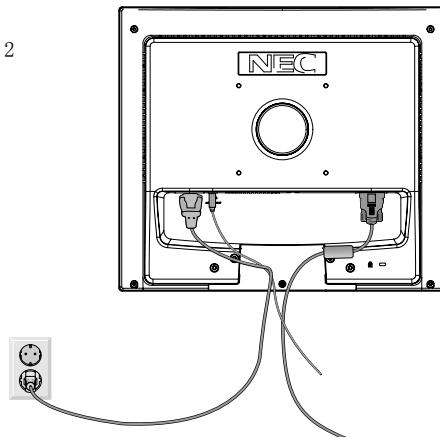

# 使用入门 - 续

## 卸下底座

注：搬运**液晶显示器**时一定要卸下底座。

1. 将显示器面朝下放在一个平整的表面上。
2. 使用拇指往箭头方向按锁片以解锁支架。
3. 从支架上取出松开的底座。

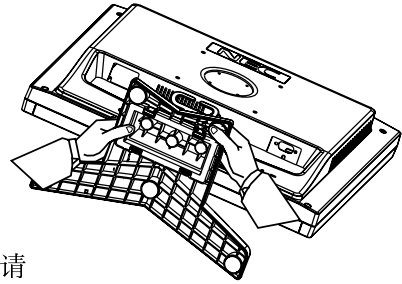

## 连接旋臂

设计的这款**液晶显示器**可以使用旋臂。安装时请使用图中所示的配件螺丝（4 颗）。

为符合安全方面的要求，必须将显示器装到一个即能支撑起整个显示器的重量，又能保证必要稳定性的旋臂上。**液晶显示器**只能安装认证的旋臂（如，带有 GS 标志）。

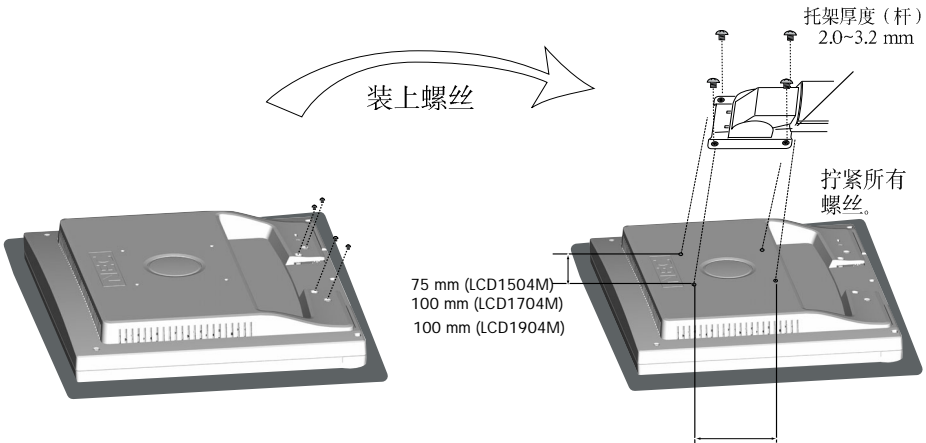

## 规格

4 颗螺丝 (M4)

(最大深度: 8.5 mm)

如果使用其它螺丝, 请检查一下槽孔的深度。

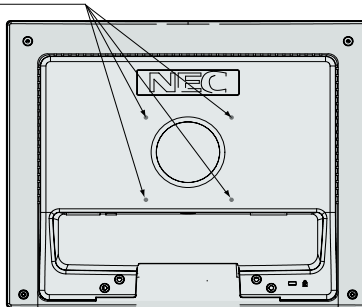

75 mm (LCD1504M)  
100 mm (LCD1704M)  
100 mm (LCD1904M)

## 液晶显示器 组件的重量:

2.9 kg - LCD1504M  
4.3 kg - LCD1704M  
5.5 kg - LCD1904M



# 控制

显示器前面的(On-Screen Manager) 控制按钮作用如下:

## 1. 本按钮功能

按钮	SELECT (选择)	-	+	AUTO/RESET (自动/重置)
OSM 关	显示 OSM	进入亮度调整窗口的快捷键	进入对比度调整窗口的快捷键	“自动调整”功能
OSM开 (图标选择阶段)	转到调整阶段	光标左移	光标右移	
OSM 关 (调整阶段)	转到图标选择阶段	调整减少数值或调整光标左移	调整增加数值或调整光标右移	

## 2. OSM 结构

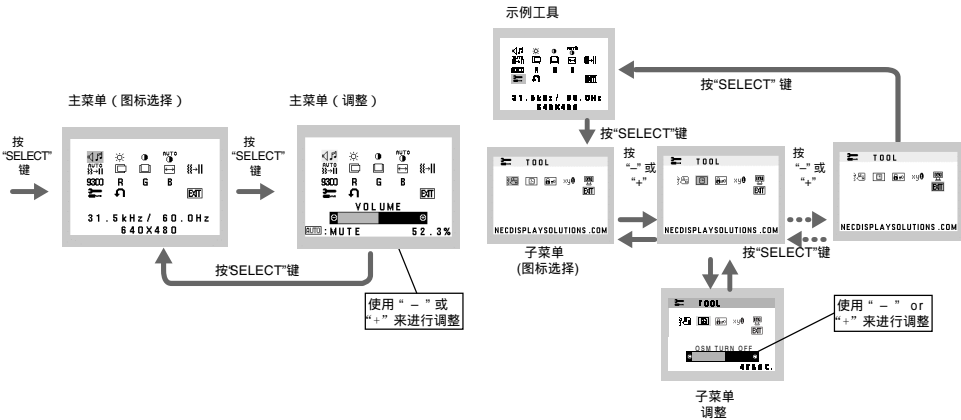

# 控制 — 续

## 音频

选定了音频音量图标，取决于音量条件（自动/重新设置）。

## 亮度

调整整个图像和背景屏幕的亮度。

## 对比度

调整相对于背景的图像亮度。

## 自动对比度

调整为非标准视频输入显示的图像。

## 自动调整

自动调整图像位置、水平宽度和微调设置。

## 左/右

控制**液晶显示器**显示区域内水平图像的位置。

## 下/上

控制**液晶显示器**显示区域内垂直图像的位置。

## 水平宽度

通过增加或减少此设置来调整水平宽度。

## 微调

通过增加或减少此设置来加强焦距、清晰度和图像稳定性。

## 颜色控制系统

四种颜色预设（9300/7500/6500/自定）选择想要的颜色设置。

## **R** 红色

增加或减少红色。改变会出现在屏幕上。

## **G** 绿色

增加或减少绿色。改变会出现在屏幕上。

## **B** 蓝色

增加或减少蓝色。改变会出现在屏幕上。

## 工具

选择工具可以让您进入到子菜单。

## 厂家预设值

选择厂家预设值可以让您把所有 OSM 控制设置重置回出厂设置。重置按钮需要按下几秒钟才会生效。通过突出显示要重置的控制，然后按重置按钮，可以重置单项设置。

# 控制 - 续



## 退出

选择退出可以让您退出 OSM 菜单/子菜单。



## 语言

OSM 控制菜单提供了几种语言。



## OSM 关闭

只要使用，OSM 控制菜单就会保持显示。在 OSM 关闭子菜单中，您可以选择最后一次按下按钮后，显示器等多长时间才关闭 OSM 控制菜单。预设选项为 10 - 120 秒（间隔时间为 5 秒）。



## OSM 锁住

这项控制会阻止您使用除亮度和对比度之外的其它所有 OSM 控制功能。当在锁住模式时尝试激活 OSM 控制时，会出现一个屏幕，提示 OSM 已被锁住。要激活 OSM 锁住功能，请同时按下“自动/重置”和 + 号键。要禁用 OSM 锁住功能，请再次同时按下“自动/重置”和 + 号键。



## 分辨率通知器

如果选择开，30 秒之后屏幕上会出现一条信息，告诉您当前分辨率不是最佳的分辨率。



## 显示器信息

显示显示器的型号和序列号。

**Warning (警告) :** OSM 警告菜单随着 SELECT (选择) 按钮消失。  
**NO SIGNAL (无信号) :** 当没有信号出现时，这项功能会给出警告。在打开电源之后，或当输入信号有改变，或视频不活动时，No Signal (无信息) 窗口会出现。

**分辨率通知器:** 这项功能会提示用户使用最佳的分辨率。在打开电源之后，或当输入信号有改变，或视频信号没有适当的分辨率时，分辨率通知器窗口会打开。这项功能可以在 TOOL (工具) 菜单中禁用。

**OUT OF RANGE (超出范围) :** 这项功能会推荐使用最佳的分辨率和刷新率。在打开电源之后，或当输入信号有改变，或视频信号没有适当的计时时，OUT OF RANGE (超出范围) 会出现。

# 建议使用

## 安全注意事项和维护



为获得最佳性能，请在安装和使用

**液晶**彩色显示器时注意以下事项:



- 请勿打开显示器机壳。内部没有用户可维修的零件，打开或卸下机壳可能会造成电击或其它危险。设备维修只能由专业技术人员进行。
- 请勿将任何液体溅入到机壳内，或在靠近水的位置使用显示器。
- 请勿将任何异物插到机壳的槽孔中，以免接触到内部高压，从而造成严重人身伤害，电击、火灾或设备故障。
- 不要在电源线上压重物。电源线损坏可能会造成电击或火灾。
- 不要将本产品放在斜的或不稳定的车辆、桌面上，以防显示器跌落，造成严重损坏。
- 如果在中国使用此LCD液晶显示器，请使用本机所带的电源线。
- 在中国以外的国家使用，请使用与所在国电压相匹配，经过验证符合所在国电器安全标准的电源线。(H05VVF-F型应在欧洲使用)
- 在英国，使用于这种显示器的装有黑色(5A)保险丝的带槽板插头符合BS标准的电源线。
- 不要将任何物件放到显示器上，不要在室外使用显示器。
- **液晶**显示器的荧光灯管内含汞元素。请遵照当地的法规适当处理这种荧光灯管。
- 不要弯曲电源线是。
- 不要在高温、潮湿、灰尘多或有油污的环境中使用显示器。
- 如果液晶玻璃破裂，应小心处理。
- 不要盖住显示器上的散热孔。

如果出现下列情况，请立即从墙上插座中拔下显示器电源线，并请专业技术人员进行维修:

- 电源线或插头损坏。
- 有液体或异物进入显示器内。
- 显示器遭到雨淋或进水。
- 如果显示器跌落或机壳损坏。
- 按照说明进行操作时，显示器工作不正常。
- 显示器或玻璃破裂时，不要接触液晶，并应小心处理。



**注意**

- 保持显示器周围的良好通风，以便尽快散热。切勿堵住通风孔，或将显示器放在散热器或其它散热装置附近。不要在显示器上面放任何东西。
- 电源线接头主要用来将系统与电源分离。显示器应安装在靠近电源插座的地方。
- 搬运时应小心处理。保存运输时使用的包装。

### 余像

当屏幕上看到前一个图像的暂停或“鬼影”图像时就会出现余像。与CRT显示器不同，**液晶**显示器的余像不是永久性的，但应避免长时间使它显示在屏幕上。为减轻余像，请在前一个图像一显示出来时，就关闭显示器。例如，一个图像显示在显示器上一个小时，余像保留着，则应将显示器关闭一个小时来消除此图像。

注：与所有个人显示设备一样，**NEC DISPLAY SOLUTIONS** 建议用户在屏幕闲置时，使用定时的屏幕保护程序，或在不使用时关掉显示器。

# 建议使用 — 续



正确地摆放和调整显示器可以降低眼睛、肩部和脖子的疲劳。



请在摆放显示器注意以下事项:

- 为获得最佳性能, 请经过 20 分钟的预热。
- 调整显示器高度, 使屏幕顶端与眼的视线齐平或略低。看屏幕中间时, 您的眼睛应略微俯视。
- 显示器到眼睛的距离应介于 40 厘米到 70 厘米之间。最佳距离为 60 厘米。
- 定时看一下 20 英尺之外的物体, 经常转动一下眼球。
- 使显示器与窗户及其它光源成 90 度角, 以最大限度降低反光。调整显示器的倾斜度, 使上面光线不会反射到屏幕上。
- 如果反光使屏幕看起来非常累, 请使用防炫光的保护屏。
- 使用不起球的软布清洁 **液晶**显示器表面。切勿使用任何清洁剂或玻璃清洁剂!
- 调整显示器的亮度和对比度控制以增强易读性。
- 在屏幕旁边使用文件夹。
- 将您大多数时间要看的所有对象 (屏幕或参考资料) 摆在自己的正前方, 以便在打字时不必经常转动脖子。
- 避免显示器上长时间显示固定的图像, 以免造成余像 (残像)。
- 定期做眼睛检查。

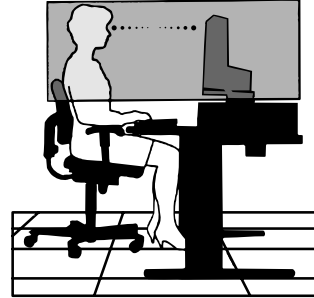

## 人机工程学

要实现最大的人机工程学利益, 我们建议:

- 标准信号使用预设的尺寸和位置控制
- 使用预设的颜色设置
- 60-75Hz 之间的垂直刷新率使用逐行信号
- 在黑色背景下不要使用主色蓝色, 因为对比度不够, 会看起来很累, 使眼睛感到疲劳

# 规格 — 续

Monitor 显示器		LCD 1504M 显示器	备注
液晶模块	对角线: 可视图像尺寸: 本机分辨率 (像素总数):	15.0 英寸 15.0 英寸 1024 x 768	有源矩阵, 薄膜晶体管 (TFT) 液晶显示屏 (LCD); 0.297 mm 点距;
输入信号	视频: 同步:	模拟 0.7 VP-P/75 Ohms 单独的同步 TTL 级别 (正/负) 水平同步 正/负 垂直同步 正/负	
显示颜色	模拟输入:	16,194,277	根据使用的显卡而定。
<b>最大 视角</b>	<b>左/右: 上/下:</b>	<b>60°/60° (CR&gt;10) 45°/45° (CR&gt;10)</b>	
同步范围	水平: 垂直:	31.5 kHz 至 61 kHz 55 Hz 至 76 Hz	自动 自动
支持的分辨率		720 x 400*1 ;VGA text 640 x 480*1, 60 Hz 至 75 Hz 800 x 600*1, 56 Hz 至 75 Hz 832 x 624*1, 75 Hz 1024 x 768, 60 Hz 至 75 Hz .....	所列的某些可能不支持有些系统。  NEC DISPLAY SOLUTIONS 采用建议的 75 Hz 下分辨率来获得最佳显示性能。
有效显示区域	水平: 垂直:	304.1 mm / 12.0 英寸 228.1 mm / 9.0 英寸	
电源		100-240 V~50/60 Hz	
额定电流		0.5 - 0.3 A / 100-240V	
尺寸		344.6 mm (宽) x 352.7 mm (高) x 165 mm (厚) 13.6 英寸 (宽) x 13.9 英寸 (高) x 6.5 英寸	
重量		3.2 千克 7.1 磅	
环境参数	操作温度: 湿度: 高度: 储存温度: 湿度: 高度:	5°C 至 35°C / 41°F 至 95°F 10% 至 80% 0 至 10,000 英尺 -10°C 至 60°C / 14°F 至 140°F 10% 至 85% 0 至 40,000 英尺	

\*1 内插分辨率: 当显示的分辨率低于液晶模块的像素总数时, 文字可能会显示的不一樣。这对于当前所有平板技术显示非本机分辨率全屏来说, 都是正常和必要的。在平板技术中, 屏幕上的每一个点实际是一个像素, 因此要将分辨率扩展到全屏, 必须完成分辨率内插。

注: 技术规格会随时变化, 不会另行通知。

# 规格 - 续

Monitor 显示器	LCD1704M 显示器		备注
液晶模块	对角线 可视图像尺寸: 本机分辨率 (像素总数):	17.0 英寸 17.0 英寸 1280 x 1024	有源矩阵, 薄膜晶体管 (TFT) 液晶显示屏 (LCD); 0.264 mm 点距;
输入信号	视频 同步	模拟 0.7 Vp-p/75 Ohms 单独的同步 TTL 级别 (正/负) 水平同步 正/负 垂直同步 正/负	
显示颜色	模拟输入:	16,194,277	根据使用的显卡而定。
最大 视角	左/右: 上/下:	<b>70°/70°</b> (CR>10) <b>65°/60°</b> (CR>10)	
同步范围	水平: 垂直:	<b>31.5 kHz 至 81.1 kHz</b> <b>55 Hz 至 76 Hz</b>	自动 自动
支持的分辨率		720 x 400*1 : VGA text 640 x 480*1, 60 Hz 至 75 Hz 800 x 600*1, 56 Hz 至 75 Hz 832 x 624*1, 75 Hz 1024 x 768*1, 60 Hz 至 75 Hz 1152 x 864*1, 70 Hz 1152 x 870*1, 75 Hz 1280 x 960*1, 60 Hz 至 75 Hz 1280 x 1024, 60 Hz 至 75 Hz.....	所列的某些可能不支持有些系统。  NEC DISPLAY SOLUTIONS 采用建议的 60 Hz 下分辨率来获得 最佳显示性能。
有效显示区域	水平: 垂直:	338 mm/13.3 英寸 270.3 mm/10.6 英寸	
电源		100-240 V ~ 50/60 Hz	
额定电流		0.6 - 0.4 A/100-240V	
尺寸		375.4 mm (宽) x 389 mm (高) x 180 mm (厚) 14.8 英寸 (宽) x 15.3 英寸 (高) x 7.1 英寸	
重量		4.6 千克 10.1 磅	
环境参数	操作温度: 湿度: 高度: 储存温度: 湿度: 高度:	5°C 至 35°C/41°F 至 95°F 30% 至 80% 0 至 10,000 英尺 -10°C 至 +60°C 4°F 至 140°F 10% 至 85% 0 至 40' 000英尺	

\*1 内插分辨率: 当显示的分辨率低于液晶模块的像素总数时, 文字可能会显示的不一樣。这对于当前所有平板技术显示非本机分辨率全屏来说, 都是正常和必要的。在平板技术中, 屏幕上的每一个点实际是一个像素, 因此要将分辨率扩展到全屏, 必须完成分辨率内插。

注: 技术规格会随时变化, 不会另行通知。

# 规格 - 续

Monitor 显示器	LCD 1904M 显示器	备注	
LCD 模块	模拟输入: 可见图像大小: 固有分辨率 (像素数):	19.0 英寸 19.0 英寸 1280 x 1024	主动矩阵; 薄膜晶体管 (TFT) 液晶显示器 (LCD); 0.294mm 点距; 270cd/m2白亮度(Typ); 550:1(Typ) 的对比度, 典型
输入信号	视频: 同步:	模拭 0.7 vp-p/75 Ohms 独立同步TTL层 (正/负) 水平同步正/负 垂直同步正/负	
显示颜色	模拟输入:	16,194,277	取决于所使用的显卡
最大 视角	左/右: 上/下:	70°/70° (CR>10) 75°/60° (CR>10)	
同步 范围	水平: 垂直:	31.5kHz 到 81.1kHz 55Hz 到 76Hz	自动 自动
支持分辨率		720 x 400*1:VGA 文本 60Hz 到 75Hz 为 640 x 480*1 56Hz 到 75Hz 为 800 x 600*1 75Hz 为 832 x 624*1 60Hz 到 75Hz 为 1024 x 768*1 70Hz 为 1152 x 864*1 75Hz 为 1152 x 870*1 75Hz 为 1280 x 960*1 60Hz 到 75Hz 为 1280 x 1024 .....	一些系统会不支持 列出的所有模式  为达最佳性能, NEC DISPLAY SOLUTIONS(NEC 显示分辨率)采用 了 60Hz 的推荐分辨率
活动显示区域	水平: 垂直:	376mm/14.8 英寸 301mm/11.9 英寸	
电源		100 - 240V~50/60Hz	
当前速率		0.8 - 0.5A/100 - 240V	
尺寸		418mm (W) x 427.8mm (H) x 199.5mm (D) 16.5英寸 (W) x 16.8英寸 (H) x 7.9英寸 (D)	
重量		6.5 千克 14.3 lbs	
所考虑的环境因素	操作温度: 湿度: 英尺: 保存温度: 湿度: 英尺:	5°C 到 35°C/41°F 到 95°F 10% 到 80% 0 到 10,000 英尺 -10°C 到 +60°C/14°F 到 140°F 10% 到 85% 0 到 40,000 英尺	

\*1 插值分辨率: 当所显示的分辨率低于 LCD 模版的象素数时, 文本看起来会不同。当全屏显示非固有的分辨率时, 这对于所有当前的平面技术来讲是正常的和必要的。在平面技术中, 在屏幕上的每个点实际上都是一个像素, 这样将分辨率扩展到整个屏幕, 必须完成分辨率的插补。

注意: 技术规格可随时更改而无需提前通知。

生产厂商: 福建捷联电子有限公司  
生产地址: 福建省福清市元洪路上部  
执行标准: Q/JLDZ300-2002  
出版日期: 2005 年 11 月



# 功能特点

---

**Reduced Footprint(减少所占位置):**为既要求卓越图像品质,又具有尺寸和重量限制的情况一个理想的解决方案。这款显示器体积较小,重量较轻,搬运和移动起来非常容易。

**Colour Control Systems (色彩控制系统):**可以让您调整屏幕上的颜色,将显示器的颜色准确度定制为各种不同的标准。

**OSM (On-Screen Manager)(屏幕管理器控件):**可以让您通过屏幕菜单即能快速方便地调整屏幕图像的各种设置。

**No-touch Auto Adjust (非接触式自动调整功能):**初始设置时,自动将显示器调整为最佳设置。

**ErgoDesign Features (ErgoDesign 功能):**增强了人机工程性,从而可以改善工作环境,保护用户的健康,以及节省成本。例如,OSM 控制可以快速方便地调整图像,转动底座可以让您调节到适合的视角,体积小及符合 MPRII 和 TCO 认证规格可以降低辐射。

**Plug and Play(即插即用):**Windows®95/98/Me/2000/XP 操作系统中采用的 Microsoft® 解决方案,可以让显示器将其功能(如所支持的屏幕尺寸和分辨率)直接发送到计算机来加速设置和安装过程,从而自动优化显示性能。

**IPM (Intelligent Power Manager (智能电源管理)系统):**提供了创新的节能方法,在显示器不使用时,可以让它显示器切换到低能耗模式,可以为显示器节省三分之二的电量成本,降低辐射,以及降低所有工作场所的空调成本。

**Multiple Frequency Technology(多频率技术):**自动将显示器调整到显卡的扫描频率,从而显示要求的分辨率。**FullScan 功能:**可以让您以大多数分辨率使用整个屏幕区域,从而极大地扩展了图像尺寸。

**VESA Standard Mounting Interface (VESA 标准安装接口):**可以让用户将其显示器安装到 VESA 标准第三方壁式旋臂或托架上。可以使用第三方兼容设备将显示器安装在墙上或旋臂上。

# 疑难解答

## 不出现图像

- 信号线应已完全连接到显卡/计算机。
- 显卡应已完全插入到插槽中。
- 前面电源开关和计算机电源开关应在“开”的位置。
- 检查一下，确定对于所使用的显卡或系统已选择了支持的模式。（请查阅显卡或系统手册来更改图形模式。）
- 检查显示器和显卡是否兼容，以及是否使用建议的设置。
- 检查一下信号线接头是否有弯曲的针脚。

## 电源按钮不起作用

- 从交流电源插座上拔下显示器的电源线，关闭和重置显示器。

## 余像

- 当屏幕上看到前一个图像的暂留或“鬼影”图像时就会出现余像。与 CRT 显示器不同，**液晶**显示器的余像不是永久性的，但应避免长时间使它显示在屏幕上。为减轻余像，请在前一个图像一显示出来时，就关闭显示器。例如，一个图像显示在显示器上一个小时，余像保留着，则应将显示器关闭一个小时来消除此图像。

注：与所有个人显示设备一样，NEC DISPLAY SOLUTIONS 建议用户在屏幕闲置时，使用定时的屏幕保护程序，或在不使用时关掉显示器。

## 图像不稳定、跳动明显

- 信号线应已完全连接到计算机。
- 通过增加或减小 FINE（微调）控制，使用 OSM 图像调整控制来聚焦和调整显示器。当显示模式改变时，可能需要重新调整 OSM 图像设置。
- 检查显示器和显卡是否兼容，以及是否使用建议的信号计时。
- 如果文字变形，请将视频模式更改为逐行扫描，并使用 60Hz 刷新率。

## 显示器上的指示灯不亮（看不到绿色或黄色）

- 电源开关应位于“开”位置，电源线应已连接。

## 显示图像尺寸不对

- 使用 OSM 图像调整控制增加或减小水平宽度。
- 检查一下，确定对于所使用的显卡或系统已选择了支持的模式。（请查阅显卡或系统手册来更改图形模式。）

## 无视频信号

- 如果屏幕上不出现视频信号，请关闭电源按钮后再打开。
- 确定计算机没有处在节能模式（动一下键盘或鼠标）。

# TCO'99

这是有关TCO'99 的译文。

恭喜！阁下购买了 TCO'99 认证和标示的产品！您选择了一款专为专业使用而设计的产品。购买本产品可以降低对环境的损害，也有助于推进环保型电子产品的开发。



## 为什么我们生产环保标志计算机。

在许多国家和地区，加贴环保标志已经成为鼓励使用环保型产品和服务的一种有效方法。对于计算机和其它电子产品来说，主要的问题是，在产品内和生产过程中会使用到对环境有害的物质。由于不可能对绝大多数电子产品进行有效的回收利用，因此，多数这些具有潜在危害的物质迟早都会进入在大自然。

计算机的其它一些特性，如耗电量，从工作（内部）和自然（外部）环境的角度来说，也是非常重要的。由于传统的所有发电方法都会对环境造成不良影响（酸雨及影响气候的辐射，放射性废物等），因此节能也是至关重要的。由于经常不停地运行，办公室里的电子设备会消耗大量的能源。

## 环保标志涉及哪些内容。

本产品符合 TCO'99 规范认证的要求，该规范为个人计算机提供国际和环境认证标志。环保认证规范由 TCO（The Swedish Confederation of Professional Employees, 瑞典专业人员协会）、Svenska Naturskyddsforeningen（The Swedish Society for Nature Conservation, 瑞典自然保护协会）和 Statens Energimyndighet（The Swedish National Energy Administration, 瑞典能源管理署）联合制订。

这些规范涵盖了许多问题：环境、人机工程学、可用性、电磁场辐射、能耗、电力及防火安全。

环保要求涉及到限制使用重金属、溴化和氯化的阻燃剂、CFC（氟里昂）和氯化溶剂，及其它物质。产品必须可以进行回收，制造商有责任制订一个环保计划，且在公司负责管理的各个国家和地区之机构均必须遵守。能量规定包括，要求计算机和（或）计算机在闲置一定时间之后，应进入低能耗的节能状态。重新激活计算机所需的时间对用户来说，应是合理的。标志产品必须遵守严格的环保要求，例如，在减少电磁场方面，在身体和视觉人机工程学及良好的可用性方面。

## 环保要求

### 阻燃剂

在印刷电路板、电缆、电线、包装和机壳中都含有阻燃剂。这些物质可以起到阻燃作用。计算机机箱内 30% 的塑料可能都含有阻燃剂。多数阻燃剂含有溴或氯成份，这些成份与另外一组有毒物质、PCB（印刷电路板）有关系，现在怀疑这些物质会对人的健康造成严重损害，其中也包括，由于生物性积聚\*，而对食鱼鸟类和哺乳动物造成的生殖损害。

# TCO'99 - 续

现在已经在人体内发现了阻燃剂成份，研究者担心它们可能会对胎发育造成不良影响。TCO'99 规范要求，重量超过 25 克的塑料部分不得使用含溴和氯成份的阻燃剂。由于没有替代物质，现在允许在印刷电路板中使用阻燃剂。

## 铅\*\*

在显像管、显示屏、焊料和电容器中都可能含有铅。铅会对神经系统造成损害，如果剂量大，而会造成铅中毒。

由于尚未开发出替代器，因此 TCO'99 规范允许使用铅。

## 镉\*\*

镉用在充电电池和某些计算机显示器的彩色成像层。镉会对神经系统造成损害，如果剂量大，而会造成镉中毒。

TCO'99 规范要求，电池、显示器屏幕的彩色成像层、电力或电子组件均不得含镉成份。

## 汞\*\*

有些电池、继电器和开关中含有汞。汞会对神经系统造成损害，如果剂量大，而会造成汞中毒。

TCO'99 规范要求，电池不得含有汞成份。也规定不得在与显示装置相关的电力或电子组件中使用汞。

## CFC (氟里昂)

CFC (氟里昂) 有时会用于清洗印刷电路板。氟里昂可以分解臭氧，对大气层中的臭氧层造成损害，从而使地球接收到更多的紫外线，进而对提高了人们患皮肤癌 (恶性肿瘤) 的危险。

根据相关的 TCO'99 规范，在制造和组装产品或其包装时，不得使用氟里昂或二氯氟甲烷。

\*生物性积聚是指物质在有机体内积聚。

\*\*铅、镉和汞都是生物性积聚的重金属。

要获得有关环境标准文件的详细信息，请通过以下地址订购：

TCO Development Unit

SE-114 94 Stockholm

SWEDEN

传真号码: +46 8 782 92 07

电子邮件 (Internet): [development@tco.se](mailto:development@tco.se)

通过访问其网站 <http://www.tcodevelopment.com/>，您也可以有关 TCO'99 认证和标志产品的最新信息。



## WARNING



TO PREVENT FIRE OR SHOCK HAZARDS, DO NOT EXPOSE THIS UNIT TO RAIN OR MOISTURE. ALSO, DO NOT USE THIS UNIT'S POLARIZED PLUG WITH AN EXTENSION CORD RECEPTACLE OR OTHER OUTLETS UNLESS THE PRONGS CAN BE FULLY INSERTED.

REFRAIN FROM OPENING THE CABINET AS THERE ARE HIGH VOLTAGE COMPONENTS INSIDE. REFER SERVICING TO QUALIFIED SERVICE PERSONNEL.



## CAUTION



CAUTION: TO REDUCE THE RISK OF ELECTRIC SHOCK, MAKE SURE POWER CORD IS UNPLUGGED FROM WALL SOCKET. TO FULLY DISENGAGE THE POWER TO THE UNIT, PLEASE DISCONNECT THE POWER CORD FROM THE AC OUTLET. DO NOT REMOVE COVER (OR BACK). NO USER SERVICEABLE PARTS INSIDE. REFER SERVICING TO QUALIFIED SERVICE PERSONNEL.



This symbol warns user that uninsulated voltage within the unit may have sufficient magnitude to cause electric shock. Therefore, it is dangerous to make any kind of contact with any part inside this unit.



This symbol alerts the user that important literature concerning the operation and maintenance of this unit has been included. Therefore, it should be read carefully in order to avoid any problems.

### Canadian Department of Communications Compliance Statement

DOC: This Class B digital apparatus meets all requirements of the Canadian Interference-Causing Equipment Regulations.

C-UL: Bears the C-UL Mark and is in compliance with Canadian Safety Regulations according to CAN/CSA C22.2 No. 60950-1.

### FCC Information

1. Use the attached specified cables with the LCD1504M (L154F0), LCD1704M (L174F1) or LCD1904M(L194F2) color monitor so as not to interfere with radio and television reception.

(2) Please use the supplied shielded video signal cable.

Use of other cables and adapters may cause interference with radio and television reception.

2. This equipment has been tested and found to comply with the limits for a Class B digital device, pursuant to part 15 of the FCC Rules. These limits are designed to provide reasonable protection against harmful interference in a residential installation. This equipment generates, uses, and can radiate radio frequency energy, and, if not installed and used in accordance with the instructions, may cause harmful interference to radio communications. However, there is no guarantee that interference will not occur in a particular installation. If this equipment does cause harmful interference to radio or television reception, which can be determined by turning the equipment off and on, the user is encouraged to try to correct the interference by one or more of the following measures:
- Reorient or relocate the receiving antenna.
  - Increase the separation between the equipment and receiver.
  - Connect the equipment into an outlet on a circuit different from that to which the receiver is connected.
  - Consult your dealer or an experienced radio/TV technician for help.

Changes or modifications not expressly approved by the party responsible for compliance could void the user's authority to operate the equipment.

If necessary, the user should contact the dealer or an experienced radio/television technician for additional suggestions. The user may find the following booklet, prepared by the Federal Communications Commission, helpful: "How to Identify and Resolve Radio-TV Interference Problems." This booklet is available from the U.S. Government Printing Office, Washington, D.C., 20402, Stock No. 004-000-00345-4.

# Contents

Your new NEC LCD monitor box\* should contain the following:

- LCD monitor
- Audio cable
- Power Cord
- User's Manual
- Video Signal Cable
- Base Stand
- Cable Holder

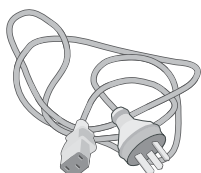

Power Cord



Video Signal Cable



User's Manual

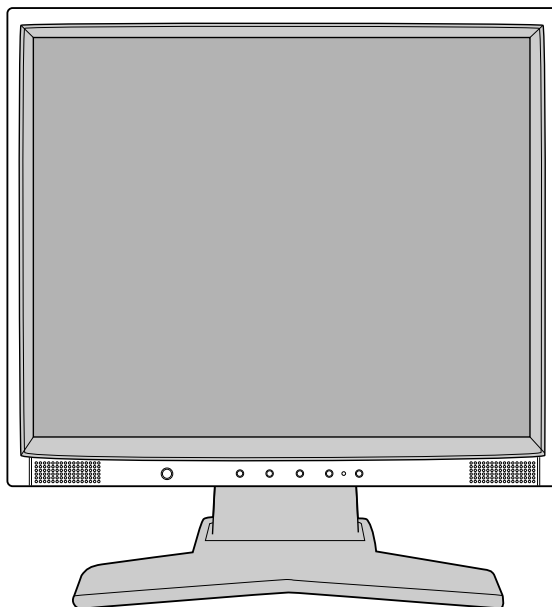

LCD Monitor  
(Stand not connected)



Cable Holder



Base stand



Audio cable

\* Remember to save your original box and packing material to transport or ship the monitor.

# Quick Start

To attach the Base to the LCD Stand:

1. Insert the front of the LCD Stand into the holes in the front of the Base (**Figure 1**).
2. Next, position the locking tabs on the back side of the LCD Stand with the holes on the Base. Lower the Stand until locking tabs are secure.

To attach the cable Holder :

1. Insert the tabs of Cable Holder into the hole of stand neck (**Figure 2**).

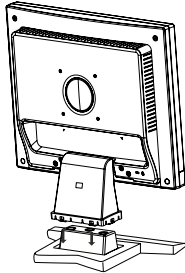

Figure 1

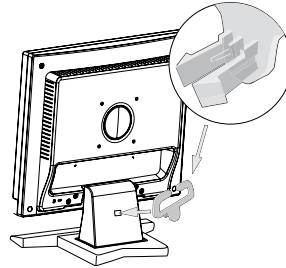

Figure 2

To attach the LCD monitor to your system, follow these instructions:

1. Turn off the power to your computer.
2. **For the PC with Analog output:** Connect the 15-pin mini D-SUB signal cable to the connector of the display card in your system (**Figure A.1**). Tighten all screws.  
**For the Mac:** Connect the Macintosh cable adapter (not included) to the computer. Attach the 15-pin mini D-SUB signal cable to the Macintosh cable adapter (**Figure A.2**). Tighten all screws.

**NOTE:** Some Macintosh systems do not require a Macintosh cable adapter.

3. Connect the 15-pin mini D-SUB of the video signal cable and Audio Cable to the appropriate connector on the back of the monitor (**Figure B.1**). Connect the Headphone (not included) to the appropriate connector at the front of the monitor (**Figure C.1**).
4. Connect one end of the power cord to the monitor and the other end to the power outlet. Place the Video Signal Cable and power cord to the Cable holder (**Figure B.1**).

**NOTE:** Adjust position of cable that place under the Cable holder to avoid damage for cable or monitor.

# Quick Start *-continued*

Figure A.1



Figure A.2

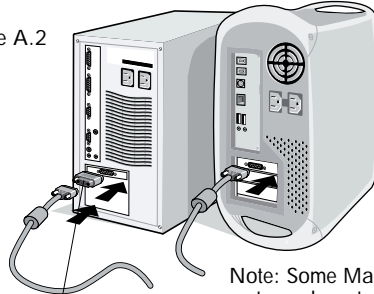

Macintosh Cable Adapter  
(not included)

Note: Some Macintosh systems do not require a Macintosh Cable Adapter

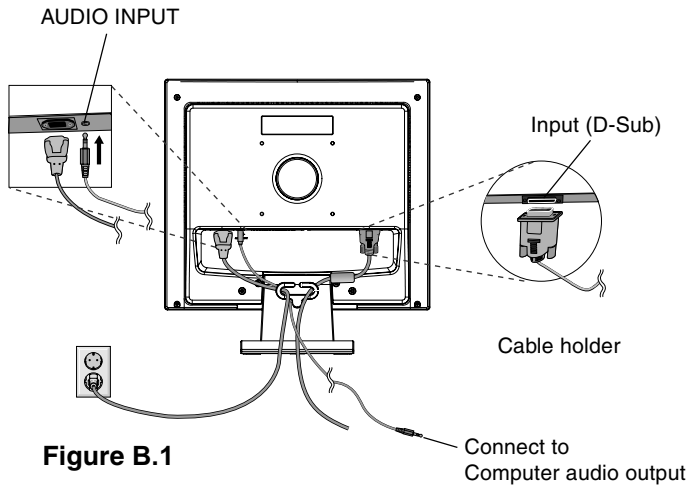
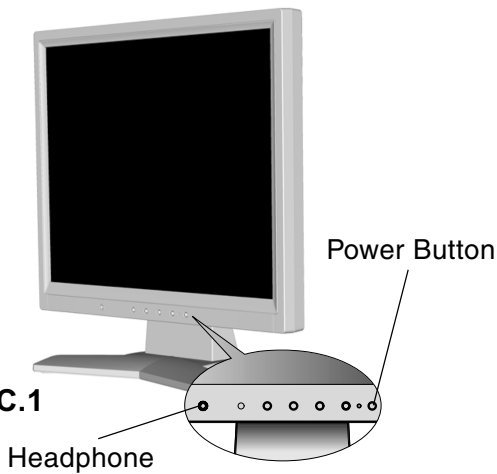

Figure B.1

Connect to  
Computer audio output

Figure C.1





# Quick Start *-continued*

## Tilt

Grasp both sides of the monitor screen with your hands and adjust the tilt as desired (**Figure TS.1**).

**NOTE:** Handle with care when tilting the monitor screen.

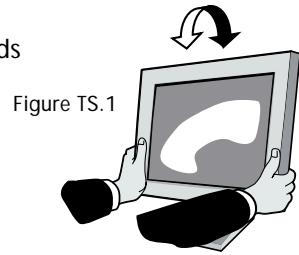

Figure TS.1

## Remove Monitor Stand for Mounting

To prepare the monitor for alternate mounting purposes:

1. Disconnect all cables.
2. Place monitor face down on a nonabrasive surface (**Figure R.1**).
3. Remove the 4 screws connecting the monitor to the stand and slide the stand off from the LCD (**Figure R.1**).

The monitor is now ready for mounting in an alternate manner.

4. Connect the AC cord and signal cable to the back of the monitor (**Figure R.2**).
5. Reverse this process to reattach stand.

**NOTE:** Use only VESA-compatible alternative mounting method.

**NOTE:** Handle with care when removing monitor stand.

Figure R.1

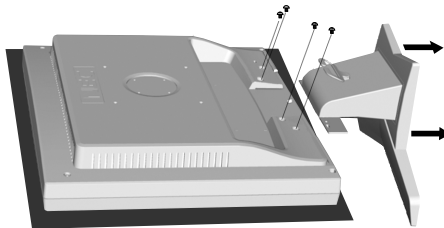
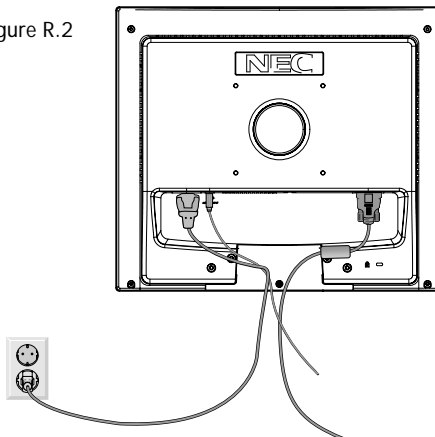

Figure R.2



# Quick Start *-continued*

## Removing the Base

**Note:** Always remove the Base when shipping the LCD.

1. Place monitor face down on a non-abrasive surface.
2. While using your thumbs, press the tabs in the direction of the arrows to unlock the stand.
3. Pull the unlocked base off the stand.

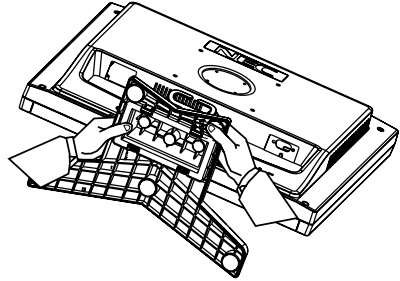

## Connecting a Flexible Arm

This LCD monitor is designed for use with a flexible arm. Please use the attached screws (4pcs) as shown in the picture when installing.

To meet the safety requirements, the monitor must be mounted to an arm which guaranties the necessary stability under consideration of the weight of the monitor. The LCD monitor should only be used with an approved arm (e.g. GS mark).

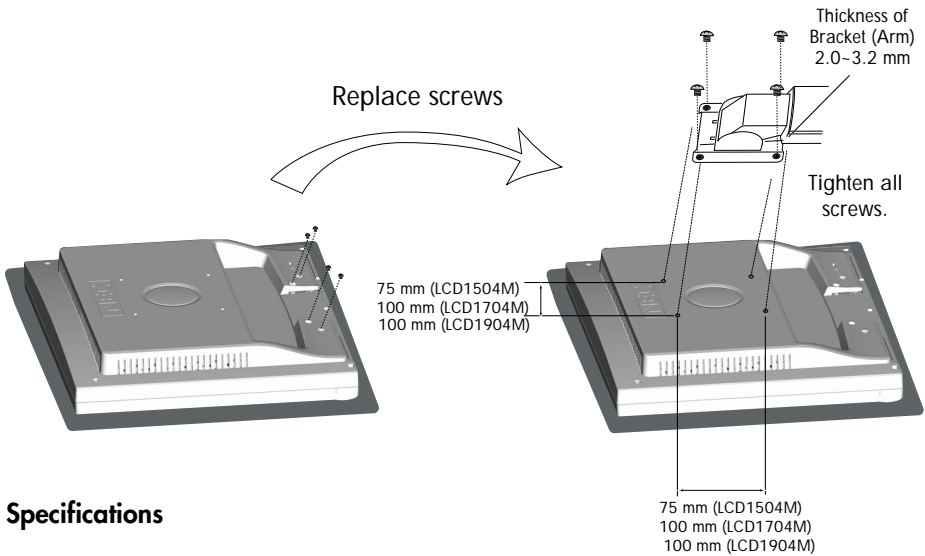

## Specifications

4-SCREWS (M4)  
(MAX depth: 8.5 mm)

If using other screws,  
check depth of holes.

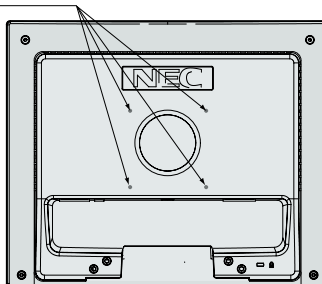

Weight of LCD assembly:  
2.9 kg - LCD1504M (MAX)  
4.3 kg -LCD1704M (MAX)  
5.5 kg -LCD1904M (MAX)

# Controls

**OSM (On-Screen Manager) control buttons on the front of the monitor function as follows:**

## 1. Basic key function

Button	SELECT	-	+	AUTO / RESET
<b>OSM Off</b>	OSM displayed	Shortcut to bright adjust window	Shortcut to contrast adjust window	"Auto adjust" function
<b>OSM On</b> (Icon selection stage)	Go to Adjustment stage	Cursor moves left	Cursor moves right	
<b>OSM On</b> (Adjustment stage)	Go to Icon selection stage	Adjust value decrease or Cursor for adjust moves left	Adjust value increase or Cursor for adjust moves right	Reset operation

## 2. OSM structure

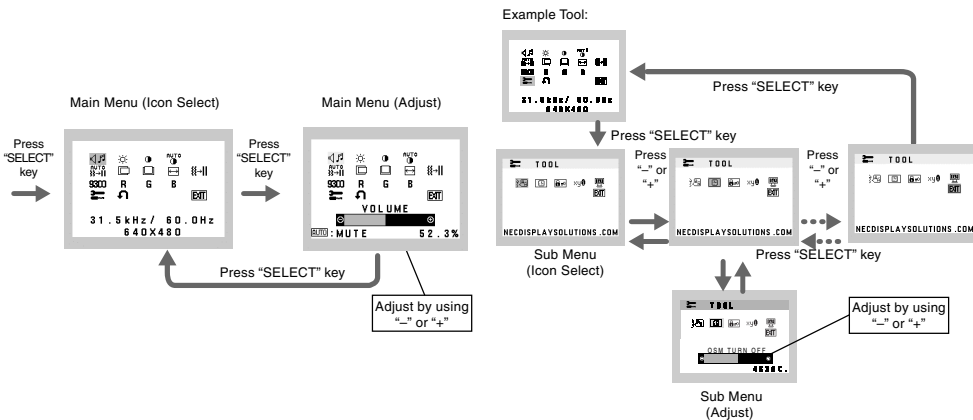

 **AUDIO**  
Audio volume icon is chosen, depending on the volume condition (AUTO/RESET).

 **BRIGHTNESS**  
Adjusts the overall image and background screen brightness.

 **CONTRAST**  
Adjusts the image brightness in relation to the background.

 **AUTO CONTRAST**  
Adjusts the image displayed for non-standard video inputs.

 **AUTO ADJUST**  
Automatically adjusts the Image Position, H. Size and Fine setting.

 **LEFT/RIGHT**  
Controls Horizontal Image Position within the display area of the LCD.

 **DOWN/UP**  
Controls Vertical Image Position within the display area of the LCD.

 **H. SIZE**  
Adjusts the horizontal size by increasing or decreasing this setting.

 **FINE**  
Improves focus, clarity and image stability by increasing or decreasing this setting.

 **COLOR CONTROL SYSTEMS**  
Four color presets (9300/7500/6500/USER) select the desired color setting.

 **COLOR RED**  
Increase or decreases Red. The change will appear on screen.

 **COLOR GREEN**  
Increase or decreases Green. The change will appear on screen.

 **COLOR BLUE**  
Increase or decreases Blue. The change will appear on screen.

 **TOOL**  
Selecting TOOL allows you to get into the sub menu.

 **FACTORY PRESET**  
Selecting Factory Preset allows you to reset all OSM control settings back to the factory settings. The RESET button will need to be held down for several seconds to take effect. Individual settings can be reset by highlighting the control to be reset and pressing the RESET button.

# Controls *-continued*

---



## EXIT

Selecting EXIT allows you exit OSM menu/sub menu.



## LANGUAGE

OSM control menus are available in seven languages.



## OSM TURN OFF

The OSM control menu will stay on as long as it is in use. In the OSM Turn OFF submenu, you can select how long the monitor waits after the last touch of a button to shut off the OSM control menu. The preset choices are 10 - 120 seconds in 5 second intervals.



## OSM LOCK OUT

This control completely locks out access to all OSM control functions without Brightness and Contrast. When attempting to activate OSM controls while in the Lock Out mode, a screen will appear indicating the OSM are locked out. To activate the OSM Lock Out function, press "AUTO/ RESET", then "+" key and hold down simultaneously. To deactivate the OSM Lock Out, press "AUTO/ RESET", then "+" key and hold down simultaneously.



## RESOLUTION NOTIFIER

If ON is selected, a message will appear on the screen after 30 seconds, notifying you that the resolution is not at optimal resolution.



## MONITOR INFO

Indicates the model and serial numbers of your monitor.

**Warning:** OSM Warning menus disappear with SELECT button.

**NO SIGNAL:** This function gives a warning when there is no signal present. After power is turned on or when there is a change of input signal or video is inactive, the **No Signal** window will appear.

**RESOLUTION NOTIFIER:** This function gives a warning of use with optimized resolution. After power is turned on or when there is a change of input signal or the video signal doesn't have proper resolution, the **Resolution Notifier** window will open. This function can be disabled in the TOOL menu.

**OUT OF RANGE:** This function gives a recommendation of the optimized resolution and refresh rate. After the power is turned on or there is a change of input signal or the video signal doesn't have proper timing, the **Out Of Range** menu will appear.

# Recommended Use

## Safety Precautions and Maintenance



FOR OPTIMUM PERFORMANCE, PLEASE NOTE THE FOLLOWING WHEN SETTING UP AND USING THE LCD COLOR MONITOR:



- **DO NOT OPEN THE MONITOR.** There are no user serviceable parts inside and opening or removing covers may expose you to dangerous shock hazards or other risks. Refer all servicing to qualified service personnel.
- Do not spill any liquids into the cabinet or use your monitor near water.
- Do not insert objects of any kind into the cabinet slots, as they may touch dangerous voltage points, which can be harmful or fatal or may cause electric shock, fire or equipment failure.
- Do not place any heavy objects on the power cord. Damage to the cord may cause shock or fire.
- Do not place this product on a sloping or unstable cart, stand or table, as the monitor may fall, causing serious damage to the monitor.
  
- When operating the LCD monitor in China, use the power cord provided with the monitor.
- For all other cases, use a power cord that matches the AC voltage of the power outlet and has been approved by and complies with the safety standard of your particular country. In the UK, a BS approved power cord with a moulded plug has a Black (five Amps) fuse installed for use with this equipment.
- Do not place any objects onto the monitor and do not use the monitor outdoors.
- The inside of the fluorescent tube located within the LCD monitor contains mercury. Please follow the bylaws or rules of your municipality to dispose of the tube properly.
- Do not bend power cord.
- Do not use monitor in high temperature, humid, dusty, or oily areas.
- If glass is broken, handle with care.
- Do not cover vent on monitor.

Immediately unplug your monitor from the wall outlet and refer servicing to qualified service personnel under the following conditions:

- When the power supply cord or plug is damaged.
- If liquid has been spilled, or objects have fallen into the monitor.
- If the monitor has been exposed to rain or water.
- If the monitor has been dropped or the cabinet damaged.
- If the monitor does not operate normally by following operating instructions.
- If monitor or glass is broken, do not come in contact with the liquid crystal and handle with care.



- Allow adequate ventilation around the monitor so that heat can properly dissipate. Do not block ventilated openings or place the monitor near a radiator or other heat sources. Do not put anything on top of monitor.
- The power cable connector is the primary means of detaching the system from the power supply. The monitor should be installed close to a power outlet which is easily accessible.
- Handle with care when transporting. Save packaging for transporting.

## Image Persistence

Image persistence is when a residual or "ghost" image of a previous image remains visible on the screen. Unlike CRT monitors, LCD monitors' image persistence is not permanent, but constant images being displayed for a long period of time should be avoided.

To alleviate image persistence, turn off the monitor for as long as the previous image was displayed. For example, if an image was on the monitor for one hour and a residual image remains, the monitor should be turned off for one hour to erase the image.

**NOTE:** As with all personal display devices, NEC DISPLAY SOLUTIONS recommends using a moving screen saver at regular intervals whenever the screen is idle or turning off the monitor when not in use.

# Recommended Use *–continued*



CORRECT PLACEMENT AND ADJUSTMENT OF THE MONITOR CAN REDUCE EYE, SHOULDER AND NECK FATIGUE. CHECK THE FOLLOWING WHEN YOU POSITION THE MONITOR:



- For optimum performance, allow 20 minutes for warm-up.
- Adjust the monitor height so that the top of the screen is at or slightly below eye level. Your eyes should look slightly downward when viewing the middle of the screen.
- Position your monitor no closer than 40 cm and no further away than 70 cm from your eyes. The optimal distance is 20 inches.
- Rest your eyes periodically by focusing on an object at least 20 feet away. Blink often.
- Position the monitor at a 90° angle to windows and other light sources to minimize glare and reflections. Adjust the monitor tilt so that ceiling lights do not reflect on your screen.
- If reflected light makes it hard for you to see your screen, use an antiglare filter.
- Clean the LCD monitor surface with a lint-free, nonabrasive cloth. Avoid using any cleaning solution or glass cleaner!
- Adjust the monitor's brightness and contrast controls to enhance readability.
- Use a document holder placed close to the screen.
- Position whatever you are looking at most of the time (the screen or reference material) directly in front of you to minimize turning your head while you are typing.
- Avoid displaying fixed patterns on the monitor for long periods of time to avoid image persistence (afterimage effects).
- Get regular eye checkups.

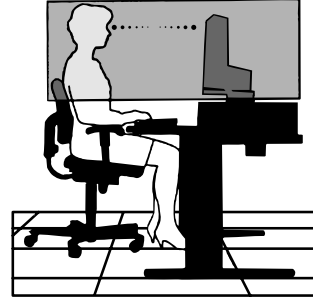

## **Ergonomics**

To realize the maximum ergonomics benefits, we recommend the following:

- Use the preset Size and Position controls with standard signals
- Use the preset Color Setting
- Use non-interlaced signals with a vertical refresh rate between 60-75Hz
- Do not use primary color blue on a dark background, as it is difficult to see and may produce eye fatigue to insufficient contrast

# Specifications –continued

Monitor Specifications		LCD 1504M Monitor	Notes
LCD Module	Diagonal: Viewable Image Size: Native Resolution (Pixel Count):	15.0 inch 15.0 inch 1024 x 768	Active matrix; thin film transistor (TFT) liquid crystal display (LCD); 0.297 mm dot pitch.
Input Signal	Video: Sync:	ANALOG 0.7 Vp-p/75 Ohms Separate sync TTL Level (Positive/Negative) Horizontal sync Positive/Negative Vertical sync Positive/Negative	
Display Colors	Analog input:	16,194,277	Depending on display card used.
Maximum Viewing Angles	Left/right: Up/Down:	60°/60° (CR>10) 45°/45° (CR>10)	
Synchronization Range	Horizontal: Vertical:	31.5 kHz to 61 kHz 55 Hz to 76 Hz	Automatically Automatically
Resolutions Supported		720 x 400*1 :VGA text 640 x 480*1 at 60 Hz to 75 Hz 800 x 600*1 at 56 Hz to 75 Hz 832 x 624*1 at 75 Hz 1024 x 768 at 60 Hz to 75 Hz .....	Some systems may not support all modes listed.  NEC DISPLAY SOLUTIONS recommended resolution at 75 Hz for optimal display performance.
Active Display Area	Horizontal : Vertical :	304.1 mm/12.0 inches 228.1 mm/9.0 inches	
Power Supply		100-240 V-50/60 Hz	
Current Rating		0.5 - 0.3 A/100-240V	
Dimensions		344.6 mm (W) x 352.7 mm (H) x 165 mm (D) 13.6 inches (W) x 13.9 inches (H) x 6.5 inches (D)	
Weight		3.2 kg 7.1 lbs	
Environmental Considerations	Operating Temperature: Humidity: Feet: Storage Temperature: Humidity: Feet:	5°C to 35°C/41°F to 95°F 10% to 80% 0 to 10,000 Feet -10°C to 60°C/14°F to 140°F 10% to 85% 0 to 40,000 Feet	

\*1 Interpolated Resolutions: When resolutions are shown that are lower than the pixel count of the LCD module, text may appear different. This is normal and necessary for all current flat panel technologies when displaying nonnative resolutions full screen. In flat panel technologies, each dot on the screen is actually one pixel, so to expand resolutions to full screen, an interpolation of the resolution must be done.

NOTE: Technical specifications are subject to change without notice.



# Specifications –continued

<b>Monitor Specifications</b>		<b>LCD 1704M Monitor</b>	<b>Notes</b>
LCD Module	Diagonal: Viewable Image Size: Native Resolution (Pixel Count):	17.0 inch 17.0 inch 1280 x 1024	Active matrix; thin film transistor (TFT) liquid crystal display (LCD); 0.264 mm dot pitch.
Input Signal	Video: Sync:	ANALOG 0.7 Vp-p/75 Ohms Separate sync TTL Level (Positive/Negative) Horizontal sync Positive/Negative Vertical sync Positive/Negative	
Display Colors	Analog input:	16,194,277	Depending on display card used.
Maximum Viewing Angles	Left/right: Up/Down:	70°/70° (CR>10) 65°/60° (CR>10)	
Synchronization Range	Horizontal: Vertical:	31.5 kHz to 81.1 kHz 55 Hz to 76 Hz	Automatically Automatically
Resolutions Supported		720 x 400*1 : VGA text 640 x 480*1 at 60 Hz to 75 Hz 800 x 600*1 at 56 Hz to 75 Hz 832 x 624*1 at 75 Hz 1024 x 768*1 at 60 Hz to 75 Hz 1152 x 864*1 at 70 Hz 1152 x 870*1 at 75 Hz 1280 x 960*1 at 60 Hz to 75 Hz 1280 x 1024 at 60 Hz to 75 Hz.....	Some systems may not support all modes listed.  <b>NEC DISPLAY SOLUTIONS</b> recommended resolution at 60 Hz for optimal display performance.
Active Display Area	Horizontal : Vertical :	338 mm/13.3 inches 270.3 mm/10.6 inches	
Power Supply		100-240 V - 50/60 Hz	
Current Rating		0.6 - 0.4 A/100-240V	
Dimensions		375.4 mm (W) x 389 mm (H) x 180 mm (D) 14.8 inches (W) x 15.3 inches (H) x 7.1 inches (D)	
Weight		4.6 kg 10.1 lbs	
Environmental Considerations	Operating Temperature: Humidity: Feet: Storage Temperature: Humidity: Feet:	5°C to 35°C/41°F to 95°F 10% to 80% 0 to 10,000 Feet -10°C to +60°C/14°F to 140°F 10% to 85% 0 to 40,000 Feet	

\*1 Interpolated Resolutions: When resolutions are shown that are lower than the pixel count of the LCD module, text may appear different. This is normal and necessary for all current flat panel technologies when displaying non-native resolutions full screen. In flat panel technologies, each dot on the screen is actually one pixel, so to expand resolutions to full screen, an interpolation of the resolution must be done.

NOTE: Technical specifications are subject to change without notice.

# Specifications –continued

Monitor Specifications		LCD 1904M Monitor	Notes
LCD Module	Diagonal: Viewable Image Size: Native Resolution (Pixel Count):	19.0 inch 19.0 inch 1280 x 1024	Active matrix; thin film transistor (TFT) liquid crystal display (LCD); 0.294 mm dot pitch; 270cd/m <sup>2</sup> white luminance; 550:1 contrast ratio, typical
Input Signal	Video: Sync:	ANALOG 0.7 Vp-p/75 Ohms Separate sync TTL Level (Positive/Negative) Horizontal sync Positive/Negative Vertical sync Positive/Negative	
Display Colors	Analog input:	16,194,277	Depending on display card used.
Maximum Viewing Angles	Left/right: Up/Down:	70°/70° (CR>10) 75°/60° (CR>10)	
Synchronization Range	Horizontal: Vertical:	31.5 kHz to 81.1 kHz 55 Hz to 76 Hz	Automatically Automatically
Resolutions Supported		720 x 400*1 : VGA text 640 x 480*1 at 60 Hz to 75 Hz 800 x 600*1 at 56 Hz to 75 Hz 832 x 624*1 at 75 Hz 1024 x 768*1 at 60 Hz to 75 Hz 1152 x 864*1 at 70 Hz 1152 x 870*1 at 75 Hz 1280 x 960*1 at 75 Hz 1280 x 1024 at 60 Hz to 75 Hz.....	Some systems may not support all modes listed.  NEC DISPLAY SOLUTIONS cites recommended resolution at 60 Hz for optimal display performance.
Active Display Area	Horizontal : Vertical :	376 mm/14.8 inches 301 mm/11.9 inches	
Power Supply		100-240 V ~ 50/60 Hz	
Current Rating		0.8 - 0.5A/100-240V	
Dimensions		418 mm (W) x 427.8 mm (H) x 199.5 mm (D) 16.5 inches (W) x 16.8 inches (H) x 7.9 inches (D)	
Weight		6.5 kg 14.3 lbs	
Environmental Considerations	Operating Temperature: Humidity: Feet: Storage Temperature: Humidity: Feet:	5°C to 35°C/41°F to 95°F 10% to 80% 0 to 10,000 Feet -10°C to +60°C/14°F to 140°F 10% to 85% 0 to 40,000 Feet	

\*1 Interpolated Resolutions: When resolutions are shown that are lower than the pixel count of the LCD module, text may appear different. This is normal and necessary for all current flat panel technologies when displaying non-native resolutions full screen. In flat panel technologies, each dot on the screen is actually one pixel, so to expand resolutions to full screen, an interpolation of the resolution must be done.

NOTE: Technical specifications are subject to change without notice.

# Features

---

**Reduced Footprint:** Provides the ideal solution for environments requiring superior image quality but with size and weight limitations. The monitor's small footprint and low weight allow it to be moved or transported easily from one location to another.

**COLOR Control Systems:** Allows you to adjust the colors on your screen and customize the color accuracy of your monitor to a variety of standards.

**OSM (On-Screen Manager) Controls:** Allow you to quickly and easily adjust all elements of your screen image via simple to use on-screen menus.

**No-touch Auto Adjust:** No-touch Auto Adjust automatically adjusts the monitor to optimal settings upon initial setup.

**ErgoDesign Features:** Enhance human ergonomics to improve the working environment, protect the health of the user and save money. Examples include OSM controls for quick and easy image adjustments, tilt base for preferred angle of vision, small footprint and compliance with MPRII and TCO guidelines for lower emissions.

**Plug and Play:** The Microsoft® solution with the Windows®95/98/Me/2000/XP operating system facilitates setup and installation by allowing the monitor to send its capabilities (such as screen size and resolutions supported) directly to your computer, automatically optimizing display performance.

**IPM (Intelligent Power Manager) System:** Provides innovative power-saving methods that allow the monitor to shift to a lower power consumption level when on but not in use, saving two-thirds of your monitor energy costs, reducing emissions and lowering the air conditioning costs of the workplace.

**Multiple Frequency Technology:** Automatically adjusts monitor to the display card's scanning frequency, thus displaying the resolution required.

**FullScan Capability:** Allows you to use the entire screen area in most resolutions, significantly expanding image size.

**VESA Standard Mounting Interface:** Allows users to connect their monitor to any VESA standard third party mounting arm or bracket. Allows for the monitor to be mounted on a wall or an arm using any third party compliant device.

# Troubleshooting

---

## **No picture**

- The signal cable should be completely connected to the display card/computer.
- The display card should be completely seated in its slot.
- Front Power Switch and computer power switch should be in the ON position.
- Check to make sure that a supported mode has been selected on the display card or system being used. (Please consult display card or system manual to change graphics mode.)
- Check the monitor and your display card with respect to compatibility and recommended settings.
- Check the signal cable connector for bent or pushed-in pins.

## **Power Button does not respond**

- Unplug the power cord of the monitor from the AC outlet to turn off and reset the monitor.

## **Image Persistence**

- Image persistence is when a residual or "ghost" image of a previous image remains visible on the screen. Unlike CRT monitors, LCD monitors' image persistence is not permanent, but constant images being displayed for a long period of time should be avoided.

To alleviate image persistence, turn off the monitor for as long as the previous image was displayed. For example, if an image was on the monitor for one hour and a residual image remains, the monitor should be turned off for one hour to erase the image.

**NOTE:** As with all personal display devices, NEC DISPLAY SOLUTIONS recommends using a moving screen saver at regular intervals whenever the screen is idle or turning off the monitor when not in use.

## **Image is unstable, unfocused or swimming is apparent**

- Signal cable should be completely attached to the computer.
- Use the OSM Image Adjust controls to focus and adjust display by increasing or decreasing the FINE control. When the display mode is changed, the OSM Image Adjust settings may need to be readjusted.
- Check the monitor and your display card with respect to compatibility and recommended signal timings.
- If your text is garbled, change the video mode to non-interlace and use 60Hz refresh rate.

## **LED on monitor is not lit** *(no green or amber color can be seen)*

- Power Switch should be in the ON position and power cord should be connected.

## **Display image is not sized properly**

- Use the OSM Image Adjust controls to increase or decrease the H.SIZE.
- Check to make sure that a supported mode has been selected on the display card or system being used. (Please consult display card or system manual to change graphics mode.)

## **No Video**

- If no video is present on the screen, turn the Power button off and on again.
- Make certain the computer is not in a power-saving mode (touch the keyboard or mouse).

## **No Sound**

- Check to see if speaker cable is properly connected.
- Check to see if mute is activated.
- Check to see if volume in OSM is set at minimum.

# TCO'99

Congratulations! You have just purchased a TCO'99 approved and labelled product! Your choice has provided you with a product developed for professional use. Your purchase has also contributed to reducing the burden on the environment and also to the further development of environmentally adapted electronics products.



## Why do we have environmentally labelled computers?

In many countries, environmental labelling has become an established method for encouraging the adaptation of goods and services to the environment. The main problem, as far as computers and other electronics equipment are concerned, is that environmentally harmful substances are used both in the products and during the manufacturing. Since it has not been possible for the majority of electronics equipment to be recycled in a satisfactory way, most of these potentially damaging substances sooner or later enter Nature.

There are also other characteristics of a computer, such as energy consumption levels, that are important from the viewpoints of both the work (Internal) and natural (external) environments. Since all methods of conventional electricity generation have a negative effect on the environment (acidic and climate-influencing emissions, radioactive waste, etc.), it is vital to conserve energy. Electronics equipment in offices consume an enormous amount of energy since they are often left running continuously.

## What does labelling involve?

This product meets the requirements for the TCO'99 scheme which provides for international and environmental labelling of personal computers. The labelling scheme was developed as a joint effort by the TCO (The Swedish Confederation of Professional Employees), Svenska Naturskyddsforeningen (The Swedish Society for Nature Conservation) and Statens Energimyndighet (The Swedish National Energy Administration).

The requirements cover a wide range of issues: environment, ergonomics, usability, emission of electrical and magnetic fields, energy consumption and electrical and fire safety.

The environmental demands concern restrictions on the presence and use of heavy metals, brominated and chlorinated flame retardants, CFCs (freons) and chlorinated solvents, among other things. The product must be prepared for recycling and the manufacturer is obliged to have an environmental plan which must be adhered to in each country where the company implements its operational policy. The energy requirements include a demand that the computer and/or display, after a certain period of inactivity, shall reduce its power consumption to a lower level in one or more stages. The length of time to reactivate the computer shall be reasonable for the user.

Labelled products must meet strict environmental demands, for example, in respect of the reduction of electric and magnetic fields, physical and visual ergonomics and good usability.

## Environmental Requirements

### Flame retardants

Flame retardants are present in printed circuit boards, cables, wires, casings and housings. In turn, they delay the spread of fire. Up to thirty percent of the plastic in a computer casing can consist of flame retardant substances. Most flame retardants contain bromine or chloride and these are related to another group of environmental toxins, PCBs, which are suspected to give rise to severe health effects, including reproductive damage in fish-eating birds and mammals, due to the bio-

# TCO'99 *–continued*

---

accumulative\* processes. Flame retardants have been found in human blood and researchers fear that disturbances in foetus development may occur.

TCO'99 demand requires that plastic components weighing more than 25 grams must not contain flame retardants with organically bound chlorine and bromine. Flame retardants are allowed in the printed circuit boards since no substitutes are available.

## **Lead\*\***

Lead can be found in picture tubes, display screens, solders and capacitors. Lead damages the nervous system and in higher doses, causes lead poisoning.

TCO'99 requirement permits the inclusion of lead since no replacement has yet been developed.

## **Cadmium\*\***

Cadmium is present in rechargeable batteries and in the color generating layers of certain computer displays. Cadmium damages the nervous system and is toxic in high doses.

TCO'99 requirement states that batteries, the color generating layers of display screens and the electrical or electronics components must not contain any cadmium.

## **Mercury\*\***

Mercury is sometimes found in batteries, relays and switches, Mercury damages the nervous system and is toxic in high doses.

TCO'99 requirement states that batteries may not contain any Mercury. It also demands that no mercury is present in any of the electrical or electronics components associated with the display unit.

## **CFCs (freons)**

CFCs (freons) are sometimes used for washing printed circuit boards. CFCs break down ozone and thereby damage the ozone layer in the stratosphere, causing increased reception on Earth of ultraviolet light with consequent increased risks of skin cancer (malignant melanoma).

The relevant TCO'99 requirement; Neither CFCs nor HCFCs may be used during the manufacturing and assembly of the product or its packaging.

\*Bio-accumulative is defined as substances which accumulate within living organisms.

\*\*Lead, Cadmium and Mercury are heavy metals which are Bio-accumulative.

To obtain complete information on the environmental criteria document, order from:

TCO Development Unit  
SE-114 94 Stockholm  
SWEDEN  
FAX Number: +46 8 782 92 07  
E-mail (Internet): [development@tco.se](mailto:development@tco.se)

You may also obtain current information on TCO'99 approved and labelled products by visiting their website at: <http://www.tcodevelopment.com/>

## Declaration of the Manufacturer

We hereby certify that the color monitor  
LCD1504M(L154F0), LCD1704M  
(174F1), or LCD1904M(L194F2)  
are in compliance with  
Council Directive 73/23/EEC:  
– EN 60950-1

Council Directive 89/336/EEC:  
– EN 55022  
– EN 61000-3-2  
– EN 61000-3-3  
– EN 55024

and marked with



NEC Display Solutions, Ltd.  
4-13-23, Shibaura,  
Minato-Ku  
Tokyo 108-0023, Japan

## Disposing of your old NEC Products

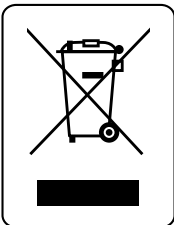

### Within the European Union

EU-wide legislation, as implemented in each Member State, requires that waste electrical and electronic products carrying the mark (left) must be disposed of separately from normal household waste. This includes monitors and electrical accessories, such as signal cables or power cords. When you need to dispose of your NEC display products, please follow the guidance of your local authority, or ask the shop where you purchased the product, or if applicable, follow any agreements made between yourself and NEC. The mark on electrical and electronic products only applies to the current European Union Member States.

### Outside the European Union

If you wish to dispose of used electrical and electronic products outside the European Union, please contact your local authority so as to comply with the correct disposal method.

---

---

## **DECLARATION OF CONFORMITY**

---

---

This device complies with Part 15 of FCC Rules. Operation is subject to the following two conditions. (1) This device may not cause harmful interference, and (2) this device must accept any interference received, including interference that may cause undesired operation.

Type of Product:                      Display Monitor  
Equipment Classification:          Class B Peripheral  
Model:                                    LCD1504M (L154F0) / LCD1704M (L174F1)/1904M(L194F2)

U. S. Responsible Party: NEC Display Solutions of America, Inc.  
Address: 500 Park Blvd, Suite 1100  
Itasca, Illinois 60143  
Tel. No.: (630)467-3000



*We hereby declare that the equipment specified above  
conforms to the technical standards as specified in the FCC Rules.*

---

---

Windows is a registered trademark of Microsoft Corporation. NEC is a registered trademark of NEC Corporation. ENERGY STAR is a U.S. registered trademark. All other brands and product names are trademarks or registered trademarks of their respective owners.

As an ENERGY STAR® Partner, NEC DISPLAY SOLUTIONS of America has determined that this product meets the ENERGY STAR guidelines for energy efficiency. The ENERGY STAR emblem does not represent EPA endorsement of any product or service.



**NEC**



41G7800842A236987

中国印刷

## Free Manuals Download Website

<http://myh66.com>

<http://usermanuals.us>

<http://www.somanuals.com>

<http://www.4manuals.cc>

<http://www.manual-lib.com>

<http://www.404manual.com>

<http://www.luxmanual.com>

<http://aubethermostatmanual.com>

Golf course search by state

<http://golfingnear.com>

Email search by domain

<http://emailbydomain.com>

Auto manuals search

<http://auto.somanuals.com>

TV manuals search

<http://tv.somanuals.com>