

PlasmaSync Plasma Monitor



PlasmaSync 50XM4
PX-50XM4G

Model Information

Modell-Informationen

Informations modèle

Información del modelo

Informazioni sul modello

Информация о модели

Specifications

For the operation of your plasma monitor, refer to "Operation Manual".

Screen Size	1106(H) × 622(V) mm 43.5"(H) × 24.5"(V) inches diagonal 50"
Aspect Ratio	16 : 9
Resolution	1365(H) × 768(V) pixels
Pixel Pitch	0.81(H) × 0.81(V) mm 0.032"(H) × 0.032"(V) inches
Color Processing	4,096 steps, 68.7 billion colors
Signals	
Synchronization Range	Horizontal : 15.5 to 110 kHz (automatic : step scan) Vertical : 50.0 to 120 Hz (automatic : step scan)
Input Signals	RGB, NTSC (3.58/4.43), PAL (B,G,M,N), PAL60, SECAM, HD* ¹ , DVD* ¹ , DTV* ¹
Input Terminals (VIDEO1 and RGB1 can also be used as OUTPUT terminals)	
RGB	
Visual 1 (Analog)	mini D-sub 15-pin × 1
Visual 2 (Analog)	BNC (R, G, B, H/CS, V) × 1* ²
Visual 3 (Digital)	DVI-D 24-pin × 1* ³
Video	
Visual 1	BNC × 1
Visual 2	RCA-pin × 1
Visual 3	S-Video: DIN 4-pin × 1
DVD/HD/DTV	
Visual 1	RCA-pin (Y, PB[CB], PR[CR]) × 1* ¹
Visual 2	BNC (Y, PB[CB], PR[CR]) × 1* ^{1, *2}
Visual 3	DVI-D 24-pin × 1* ³
Audio	Stereo RCA × 3 (Selectable)
External Control	D-sub 9-pin × 1 (RS-232C)
Sound output	9W+9W at 6 ohm
Power Supply	AC100-240V 50/60Hz
Current Rating	7.6 A (maximum)
Power Consumption	435W (typical)
Dimensions	1222 (W) × 736 (H) × 96(D) mm 48.1 (W) × 30 (H) × 3.8 (D) inches
Weight	44 kg / 97 lbs (without stand)
Environmental Considerations	
Operating Temperature	0°C to 40°C / 32°F to 104°F
Humidity	20 to 80% (no condensation)
Altitude	0 to 2800 m / 0 to 9180 feet
Storage Temperature	-10°C to 50°C / 14°F to 122°F
Humidity	10 to 90% (no condensation)
Altitude	0 to 3000 m / 0 to 9840 feet
Front Panel User Controls	Power on/off, Input source select, Volume up/down/ OSM control
Remote Control Functions	Power on/off, Input source select, OSM control, Volume up/down, Cursor (UP, DOWN, LEFT, RIGHT), Pointer, Zoom up/ down, Off timer, Wireless/Wired remote control, Split screen buttons
OSM Functions	Picture (Contrast/Brightness/Sharpness/ Color/Tint/ Picture mode/Noise reduction/Color temperature/ White balance/Gamma/Low tone/Color tune), Audio (Bass/Treble/Balance/Audio input), Image Adjust (Aspect mode/V-Position /H-Position/V-Height /H- Width/Auto Picture/Fine picture/Picture adjustment), Option1 (OSM/BNC Input/D-Sub Input/RGB Select/ HD Select/Input Skip/All Reset), Option2 (Power management/Cinema mode/Long life [PLE, Orbiter, Inverse, White, Screen wiper, Soft focus]/Gray level/ S1/S2/Picture size/DVI Set up), Option3 (Timer/ Power on mode/Control lock/IR Remote/Loop out/ ID number/Video wall [Divider, Position, Disp. mode, Auto ID, Image adjust, Power on delay, PLE link, Timer]), Option4 (Sub. P detect/Zoom nav/Pic freeze/ Seamless SW), Advanced OSM, Language*, Color system, Source information *English, German, French, Italian, Spanish, Swedish, Chinese, Russian

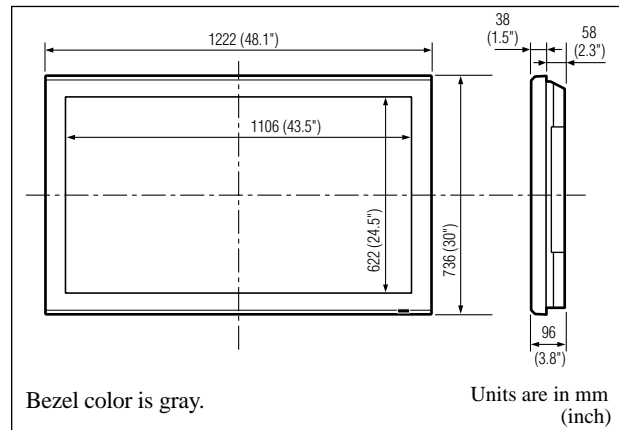

The features and specifications may be subject to change without notice.

*¹ HD/DVD/DTV input signals supported on this system

480P (60 Hz)	480I (60 Hz)
525P (60 Hz)	525I (60 Hz)
576P (50 Hz)	576I (50 Hz)
625P (50 Hz)	625I (50 Hz)
720P (60 Hz)	1035I (60 Hz)
1080I (50 Hz)	1080I (60 Hz)

*² The 5-BNC connectors are used as RGB/PC2 and HD/DVD2 input. Select one of them under "BNC INPUT".

*³ Compatible with HDCP.

Supported Signals

- 640 × 480P @ 59.94/60Hz
- 1280 × 720P @ 59.94/60Hz
- 1920 × 1080I @ 59.94/60Hz
- 720 × 480P @ 59.94/60Hz
- 1440 (720) × 576P @ 50Hz
- 1920 × 1080I @ 50Hz
- 1440 (720) × 576P @ 50Hz

Note: In some cases a signal on the plasma monitor may not be displayed properly. The problem may be an inconsistency with standards from the source equipment (DVD, Set-top box, etc...). If you do experience such a problem please contact your dealer and also the manufacturer of the source equipment.

Other Features	Motion compensated 3D Scan Converter (NTSC, PAL, 480I, 576I, 525I, 625I, 1035I, 1080I), 2-3 pull down Converter (NTSC, 480I, 525I, 1035I, 1080I (60Hz)), 2-2 pull down Converter (PAL, 576I, 625I, NTSC, 480I, 525I), Digital Zoom Function (100-900% Selectable), Video Wall 4-25 multi screen, Self Diagnosis, Image Burn reduction tools (PLE LOCK1~3, INVERSE, WHITE, ORBITER (Auto1,2/Manual), SCREEN WIPER), Color Temperature select (high/mid/low/low, user has 4 memories), Control lock (Except power SW), Auto Picture, Input Skip, Color Tune, Low Tone (3 mode), Auto ID, Programmable Timer, Gamma Correction (4 mode), Loop through interface, Plug and play (DDC1, DDC2b, RGB3: DDC2b only), Split screen operations
-----------------------	--

Accessories	Remote control with two AAA batteries, Power cord, Manuals, Safety metal fittings, Ferrite cores, Bands, Cable clamps
--------------------	---

Regulations	Meets EMC Directive (EN55022 Class A, EN55024, EN61000-3-2, EN61000-3-3) Meets Low Voltage Directive (EN60950-1, IEC60950-1, SEMKO Approved) Meets AS/NZS CISPR 22:2002 Class A
--------------------	---

Table of Signals Supported

Supported resolution

- When the screen mode is NORMAL, each signal is converted to a 1024 dots × 768 lines signal. (Except for *2,3,4)
- When the screen mode is TRUE, the picture is displayed in the original resolution.
- When the screen mode is FULL, each signal is converted to a 1365 dots × 768 lines signal. (Except for *3)

Computer input signals supported by this system

Model	Dots × lines	Vertical frequency (Hz)	Horizontal frequency (kHz)	Sync Polarity		Presence		Screen mode			RGB select*5	DVI	Memory	
				Horizontal	Vertical	Horizontal	Vertical	NORMAL (4:3)	TRUE	FULL (16:9)				
IBM PC/AT*8 compatible computers	640 × 400	70.1	31.5	NEG	NEG	YES	YES	YES*2	YES	YES	--	NO	4	
	640 × 480	59.9	31.5	NEG	NEG	YES	YES	YES	YES	YES	STILL	YES	5	
		72.8	37.9	NEG	NEG	YES	YES	YES	YES	YES	--	YES	7	
		75.0	37.5	NEG	NEG	YES	YES	YES	YES	YES	STILL	YES	8	
		85.0	43.3	NEG	NEG	YES	YES	YES	YES	YES	--	YES	9	
		100.4	51.1	NEG	NEG	YES	YES	YES	YES	YES	--	YES	41	
		120.4	61.3	NEG	NEG	YES	YES	YES	YES	YES	--	YES	42	
	848 × 480	60.0	31.0	POS	POS	YES	YES	--	YES	YES	WIDE2	YES	19	
	852 × 480*1	60.0	31.7	NEG	NEG	YES	YES	--	YES	YES	WIDE1	YES	17	
	800 × 600	56.3	35.2	POS	POS	YES	YES	YES	YES	YES	STILL	YES	11	
		60.3	37.9	POS	POS	YES	YES	YES	YES	YES	STILL	YES	12	
		72.2	48.1	POS	POS	YES	YES	YES	YES	YES	--	YES	13	
		75.0	46.9	POS	POS	YES	YES	YES	YES	YES	--	YES	14	
		85.1	53.7	POS	POS	YES	YES	YES	YES	YES	--	YES	15	
		99.8	63.0	POS	POS	YES	YES	YES	YES	YES	--	YES	43	
	1024 × 768	120.0	75.7	POS	POS	YES	YES	YES	YES	YES	--	YES	44	
		60.0	48.4	NEG	NEG	YES	YES	YES*3	--	YES	STILL	YES	24	
		70.1	56.5	NEG	NEG	YES	YES	YES*3	--	YES	--	YES	25	
		75.0	60.0	POS	POS	YES	YES	YES*3	--	YES	STILL	YES	26	
		85.0	68.7	POS	POS	YES	YES	YES*3	--	YES	--	YES	27	
	100.6	80.5	NEG	NEG	YES	YES	YES*3	--	YES	--	YES	YES	45	
		75.0	67.5	POS	POS	YES	YES	YES	--	YES	STILL	YES	51	
	1280 × 768	56.2	45.1	POS	POS	YES	YES	--	--	YES	WIDE1	NO	52	
		59.8	48.0	POS	NEG	YES	YES	--	--	YES	WIDE3	YES	80	
	1280 × 768*9	69.8	56.0	NEG	POS	YES	YES	--	--	YES	WIDE1	YES	66	
	1280 × 800*9	60.0	49.7	NEG	NEG	YES	YES	--	--	YES	WIDE1	YES	21	
	1280 × 854*9	60.0	53.1	NEG	NEG	YES	YES	--	--	YES	WIDE2	YES	37	
	1360 × 765	60.0	47.7	POS	POS	YES	YES	--	--	YES*3	WIDE1	NO	22	
	1360 × 768	60.0	47.7	POS	POS	YES	YES	--	--	YES*3	WIDE1	YES	22	
	1376 × 768	59.9	48.3	NEG	POS	YES	YES	--	--	YES	WIDE2	YES	53	
	1280 × 1024	60.0	64.0	POS	POS	YES	YES	YES*4	--	YES	STILL	YES	29	
		75.0	80.0	POS	POS	YES	YES	YES*4	--	YES	--	YES	30	
85.0		91.1	POS	POS	YES	YES	YES*4	--	YES	--	YES	40		
100.1		108.5	POS	POS	YES	YES	YES*4	--	YES	--	NO	47		
1680 × 1050*9	60.0	65.3	NEG	NEG	YES	YES	--	--	YES	WIDE4	YES	38		
1600 × 1200	60.0	75.0	POS	POS	YES	YES	YES	--	YES	--	YES	54		
	65.0	81.3	POS	POS	YES	YES	YES	--	YES	--	NO	55		
	70.0	87.5	POS	POS	YES	YES	YES	--	YES	--	NO	56		
	75.0	93.8	POS	POS	YES	YES	YES	--	YES	--	NO	57		
	85.0	106.3	POS	POS	YES	YES	YES	--	YES	--	NO	58		
1920 × 1200*9	60.0	74.6	NEG	NEG	YES	YES	--	--	YES	WIDE2	--	81		
1920 × 1200RB*9	60.0	74.0	NEG	NEG	YES	YES	--	--	YES	WIDE3	YES	88		
Apple Macintosh*6 *8	640 × 480	66.7	35.0	Sync on G	Sync on G	--	--	YES	YES	YES	--	NO	6	
	832 × 624	74.6	49.7	Sync on G	Sync on G	--	--	YES	YES	YES	--	NO	16	
	1024 × 768	74.9	60.2	Sync on G	Sync on G	--	--	YES*3	--	YES	WIDE1	NO	28	
	1152 × 870	75.1	68.7	Sync on G	Sync on G	--	--	YES	--	YES	WIDE1	NO	39	
	1440 × 900*9	60.0	56.0	NEG	NEG	YES	YES	--	--	YES	--	YES	89	
Work Station (EWS4800)*8	1280 × 1024	60.0	64.6	NEG	NEG	YES	YES	YES*4	--	YES	--	YES	29	
		71.2	75.1	NEG	NEG	YES	YES	YES*4	--	YES	--	YES	48	
Work Station (HP)*8	1280 × 1024	72.0	78.1	--	--	--	--	YES*4	--	YES	--	YES	59	
Work Station (SUN)*8	1152 × 900	66.0	61.8	C Sync	C Sync	--	--	YES	--	YES	--	YES	60	
		76.0	71.7	C Sync	C Sync	--	--	YES	--	YES	--	YES	61	
	1280 × 1024	76.1	81.1	C Sync	C Sync	--	--	YES*4	--	YES	--	YES	30	
Work Station (SGI)	1024 × 768	60.0	49.7	--	--	--	--	YES*3	--	YES	--	YES	62	
	1280 × 1024	60.0	63.9	--	--	--	--	YES*4	--	YES	--	YES	29	
IDC-3000G														
	PAL625P	768 × 576	50.0	31.4	NEG	NEG	YES	YES	YES*7	--	YES*7	--	NO	31
	NTSC525P	640 × 480	59.9	31.5	NEG	NEG	YES	YES	YES*7	--	YES*7	MOTION	NO	32

- *1 Only when using a graphic accelerator board that is capable of displaying 852 × 480.
- *2 This signal is converted to a 1024 dots × 640 lines signal.
- *3 The picture is displayed in the original resolution. The picture will be compressed for other signals.
- *4 Aspect ratio is 5:4. This signal is converted to a 960 dots × 768 lines signal.
- *5 Normally the RGB select mode suite for the input signals is set automatically. If the picture is not displayed properly, set the RGB mode prepared for the input signals listed in the table above.
- *6 To connect the monitor to Macintosh computer, use the monitor adapter (D-Sub 15-pin) to your computer's video port.
- *7 Other screen modes (ZOOM and STADIUM) are available as well.
- *8 When viewing a moving picture at a vertical frequency greater than 65Hz, the picture may sometimes be unstable (jumpy). If this occurs, please set the refresh rate of the external equipment to 60Hz.
To view 480I@60Hz (480 interlaced lines, 60Hz refresh rate) or 576I@50Hz (567 interlaced lines, 50Hz refresh rate) when sync polarity is "Sync on Green", set "RGB SELECT" to "MOTION".
- *9 CVT standard compliant.

NOTE:

- While the input signals comply with the resolution listed in the table above, you may have to adjust the position and size of the picture or the fine picture because of errors in synchronization of your computer.
 - When a 1280 dots × 1024 lines signal or 1600 dots × 1200 lines signal is input to the monitor, the picture will be compressed.
 - This monitor has a resolution of 1365 dots × 768 lines. It is recommended that the input signal should be XGA, wide XGA, or equivalent.
 - With digital input some signals are not accepted.
 - The sync may be disturbed when a nonstandard signal other than the aforementioned is input.
 - If you are connecting a composite sync signal, use the HD terminal.
-

What is HDCP/HDCP technology?

HDCP is an acronym for High-bandwidth Digital Content Protection. High bandwidth Digital Content Protection (HDCP) is a system for preventing illegal copying of video data sent over a Digital Visual Interface (DVI).

If you are unable to view material via the DVI input, this does not necessarily mean the PDP is not functioning properly. With the implementation of HDCP, there may be cases in which certain content is protected with HDCP and might not be displayed due to the decision/intention of the HDCP community (Digital Content Protection, LLC).

-
- "IBM PC/AT" and "XGA" are registered trademarks of International Business Machines, Inc. of the United States.
 - "Apple Macintosh" is a registered trademark of Apple Computer, Inc. of the United States.

Important Information

Warning

Apparatus shall not be exposed to dripping or splashing and that no objects filled with liquids, such as vases, shall be placed on apparatus.

To reduce the risk of fire or electric shock, do not expose this apparatus to rain or moisture.

This is a Class A product. In a domestic environment, this product may cause radio interference in which case the user may be required to take adequate measures.

NOTE:

When you connect a computer to this monitor, use an RGB cable including the ferrite core on both ends of the cable. And regarding DVI and power cable, attach the supplied ferrite cores. If you do not do this, this monitor will not conform to mandatory CE or C-Tick standards.

Set the ferrite cores on both ends of the DVI cable (not supplied), and both ends of the power cable (supplied). Close the lid tightly until the clamps click.

Use the band to fasten the ferrite core (supplied) to the DVI cable.

DVI cable (not supplied)



Power cable (supplied)

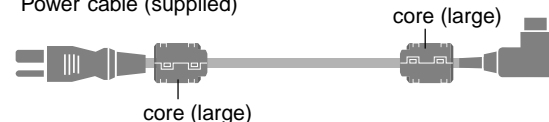

Operation Manual

(Enhanced split screen Model)

For the specifications of your plasma monitor, refer to "Model Information".

ENGLISH

DEUTSCH

FRANÇAIS

ESPAÑOL

ITALIANO

РУССКИЙ

Important Information

Precautions

Please read this manual carefully before using your plasma monitor and keep the manual handy for future reference.



CAUTION



**RISK OF ELECTRIC SHOCK
DO NOT OPEN**

CAUTION: TO REDUCE THE RISK OF ELECTRIC SHOCK, DO NOT REMOVE COVER. NO USER-SERVICEABLE PARTS INSIDE. REFER SERVICING TO QUALIFIED SERVICE PERSONNEL.

This symbol warns the user that uninsulated voltage within the unit may have sufficient magnitude to cause electric shock. Therefore, it is dangerous to make any kind of contact with any part inside of this unit.

This symbol alerts the user that important literature concerning the operation and maintenance of this unit has been included. Therefore, it should be read carefully in order to avoid any problems.

WARNING

TO PREVENT FIRE OR SHOCK HAZARDS, DO NOT EXPOSE THIS UNIT TO RAIN OR MOISTURE. ALSO DO NOT USE THIS UNIT'S POLARIZED PLUG WITH AN EXTENSION CORD RECEPTACLE OR OTHER OUTLETS, UNLESS THE PRONGS CAN BE FULLY INSERTED. REFRAIN FROM OPENING THE CABINET AS THERE ARE HIGH-VOLTAGE COMPONENTS INSIDE. REFER SERVICING TO QUALIFIED SERVICE PERSONNEL.

Warnings and Safety Precaution

This plasma monitor is designed and manufactured to provide long, trouble-free service. No maintenance other than cleaning is required. Please see the section "Plasma monitor cleaning procedure" on the next page.

The plasma display panel consists of fine picture elements (cells) with more than 99.99 percent active cells. There may be some cells that do not produce light or remain lit.

For operating safety and to avoid damage to the unit, read carefully and observe the following instructions.

To avoid shock and fire hazards:

1. Provide adequate space for ventilation to avoid internal heat build-up. Do not cover rear vents or install the unit in a closed cabinet or shelves.
If you install the unit in an enclosure, make sure there is adequate space at the top of the unit to allow hot air to rise and escape. If the monitor becomes too hot, the overheat protector will be activated and the monitor will be turned off. If this happens, turn off the power to the monitor and unplug the power cord. If the room where the monitor is installed is particularly hot, move the monitor to a cooler location, and wait for 60 minutes to cool the monitor. If the problem persists, contact your dealer for service.
2. Do not use this unit's polarized plug with extension cords or outlets unless the prongs can be completely inserted.
3. Do not expose the unit to water or moisture.
4. Avoid damage to the power cord, and do not attempt to modify the power cord.
5. Unplug the power cord during electrical storms or if the unit will not be used over a long period.
6. Do not open the cabinet which has potentially dangerous high voltage components inside. If the unit is damaged in this way the warranty will be void. Moreover, there is a serious risk of electric shock.

7. Do not attempt to service or repair the unit. The manufacturer is not liable for any bodily harm or damage caused if unqualified persons attempt service or open the back cover. Refer all service to authorized Service Centers.

To avoid damage and prolong operating life:

1. Use only with 100-240V 50/60Hz AC power supply. Continued operation at line voltages greater than 100-240 Volts AC will shorten the life of the unit, and might even cause a fire hazard.
2. Handle the unit carefully when installing it and do not drop.
3. Set the unit away from heat, excessive dust, and direct sunlight.
4. Protect the inside of the unit from liquids and small metal objects. In case of accident, unplug the power cord and have it serviced by an authorized Service Center.
5. Do not hit or scratch the panel surface as this causes flaws on the surface of the screen.
6. For correct installation and mounting it is strongly recommended to use a trained, authorized dealer.
7. As is the case with any phosphor-based display (like a CRT monitor, for example) light output will gradually decrease over the life of a Plasma Display Panel.
8. To avoid sulfurization it is strongly recommended not to place the unit in a dressing room in a public bath or hot spring bath.
9. Do not use in a moving vehicle, as the unit could drop or topple over and cause injuries.
10. Do not place the unit on its side, upside-down or with the screen facing up or down, to avoid combustion or electric shock.

Plasma monitor cleaning procedure:

1. Use a soft dry cloth to clean the front panel and bezel area. Never use solvents such as alcohol or thinner to clean these surfaces.
2. Clean plasma ventilation areas with a vacuum cleaner with a soft brush nozzle attachment.
3. To ensure proper ventilation, cleaning of the ventilation areas must be carried out monthly. More frequent cleaning may be necessary depending on the environment in which the plasma monitor is installed.

Recommendations to avoid or minimize phosphor burn-in:

Like all phosphor-based display devices and all other gas plasma displays, plasma monitors can be susceptible to phosphor burn under certain circumstances. Certain operating conditions, such as the continuous display of a static image over a prolonged period of time, can result in phosphor burn if proper precautions are not taken. To protect your investment in this plasma monitor, please adhere to the following guidelines and recommendations for minimizing the occurrence of image burn:

- * Always enable and use your computer's screen saver function during use with a computer input source.
- * Display a moving image whenever possible.
- * Change the position of the menu display from time to time.
- * Always power down the monitor when you are finished using it.

If the plasma monitor is in long term use or continuous operation take the following measures to reduce the likelihood of phosphor burn:

- * Lower the Brightness and Contrast levels as much as possible without impairing image readability.
- * Display an image with many colors and color gradations (i.e. photographic or photo-realistic images).
- * Create image content with minimal contrast between light and dark areas, for example white characters on black backgrounds. Use complementary or pastel color whenever possible.
- * Avoid displaying images with few colors and distinct, sharply defined borders between colors.

* Note: Burn-in is not covered by the warranty.

Contact your dealer for other recommended procedures that will best suit your particular application needs.

Contents

Installation	E-4	Setting the Input Skip	E-22
Ventilation Requirements for enclosure mounting	E-4	Resetting to the default values	E-22
How to use the safety metal fittings and the screws for safety metal fittings	E-4	Option2 Settings Menu	E-23
Creating a video wall	E-5	Setting the power management for computer images	E-23
Cable Management	E-5	POWER/STANDBY indicator	E-23
Caution on when the plasma monitor is installed vertically	E-6	Setting the picture to suit the movie	E-23
How to use the remote control	E-6	Reducing burn-in of the screen	E-23
Battery Installation and Replacement	E-6	Setting the gray level for the sides of the screen	E-25
Using the wired remote control mode	E-6	Setting the screen size for S1/S2 video input	E-25
Operating Range	E-6	Setting the picture size for RGB input signals	E-26
Handling the remote control	E-6	Setting the signal and black level for DVI signal	E-26
Part Names and Function	E-7	Option3 Settings Menu	E-26
Front View	E-7	Using the timer	E-26
Rear View/ Terminal Board	E-8	Setting the power on mode	E-28
Remote Control	E-9	Enabling/disabling the front panel controls	E-28
Basic Operations	E-10	Enabling/disabling remote control wireless transmission	E-28
POWER	E-10	Loop Out setting	E-28
To turn the unit ON and OFF:	E-10	ID number setting	E-29
VOLUME	E-10	Video Wall setting	E-29
To adjust the sound volume:	E-10	Option4 Settings Menu	E-32
MUTE	E-10	Erasing the sub screen image when there is no input signal	E-32
To mute the audio:	E-10	Displaying the entire image during DIGITAL ZOOM operations	E-32
DISPLAY	E-10	Displaying still images in the sub screen	E-32
To check the settings:	E-10	Switching the input source quickly	E-33
DIGITAL ZOOM	E-10	Advanced OSM Settings Menu	E-33
AUTO ADJUST	E-10	Setting the menu mode	E-33
To adjust the size or quality of the picture automatically:	E-10	Language Settings Menu	E-33
OFF TIMER	E-10	Setting the language for the menus	E-33
To set the off timer:	E-10	Color System Settings Menu	E-34
To check the remaining time:	E-10	Setting the video signal format	E-34
To cancel the off timer:	E-10	Source Information Menu	E-34
WIDE Operations	E-11	Checking the frequencies, polarities of input signals, and resolution	E-34
Wide Screen Operation (manual)	E-11	External Control	E-35
When viewing videos or digital video discs	E-11	Application	E-35
Wide Screen Operation with Computer Signals	E-12	Connections	E-35
When "PICTURE SIZE" is set to "OFF"	E-12	Type of connector: D-Sub 9-pin male	E-35
SPLIT SCREEN Operations	E-13	Communication Parameters	E-35
Showing a couple of pictures on the screen at the same time	E-13	External Control Codes (Reference)	E-35
Operations in the Side-by-side mode	E-13	Pin Assignments	E-35
Operations in the Picture-in-picture mode	E-14	mini D-Sub 15-pin connector (Analog)	E-35
Selecting the input signals to be displayed	E-14	DVI-D 24-pin connector (Digital)	E-35
Zooming up pictures	E-14	Troubleshooting	E-36
Adjusting the OSM controls	E-14	Contents of the Package	
OSM (On Screen Menu) Controls	E-15	<input type="checkbox"/> Plasma monitor	
Menu Operations	E-15	<input type="checkbox"/> Power cord	
Menu Tree	E-16	<input type="checkbox"/> Remote control with two AAA Batteries	
Picture Settings Menu	E-18	<input type="checkbox"/> Manuals (Model Information and Operation)	
Adjusting the picture	E-18	<input type="checkbox"/> Safety metal fittings*	
Setting the picture mode according to the brightness of the room	E-18	<input type="checkbox"/> Ferrite cores, bands	
Reducing noise in the picture	E-18	<input type="checkbox"/> Cable clamps	
Setting the color temperature	E-18	* Contents will differ according to the model.	
Adjusting the color to the desired level	E-19	* These are fittings for fastening the unit to a wall to prevent tipping due to external shock when using the stand (optional). Fasten the safety fittings to the holes in the back of the monitor using the safety fitting mount screws (see page E-4).	
Changing the Gamma Curve	E-19	Options	
Making the Low Tone adjustments	E-19	• Wall mount unit	
Adjusting the colors	E-19	• Ceiling mount unit	
Audio Settings Menu	E-20	• Tilt mount unit	
Adjusting the treble, bass and left/right balance and audio input select	E-20	• Stand	
Setting the allocation of the audio connectors	E-20	• Attachable speakers	
Image Adjust Settings Menu	E-20		
Adjusting the Position, Size, Fine Picture, Picture Adj	E-20		
Option1 Settings Menu	E-21		
Setting the on-screen menu	E-21		
Setting the BNC connectors	E-21		
Setting the RGB1 connector	E-21		
Setting a computer image to the correct RGB select screen	E-21		
Setting high definition image to the suitable screen size	E-22		

Installation

You can attach your optional mounts or stand to the plasma monitor in one of the following two ways:

- * While it is upright. (See Drawing A)
- * As it is laid down with the screen face down (See Drawing B). Lay the protective sheet, which was wrapped around the monitor when it was packaged, beneath the screen surface so as not to scratch the screen face.
- * Do not touch or hold the screen face when carrying the unit.

- **This device cannot be installed on its own. Be sure to use a stand or original mounting unit. (Wall mount unit, Stand, etc.)**
 - * See page E-3.
 - **For correct installation and mounting it is strongly recommended to use a trained, authorized dealer.**
- Failure to follow correct mounting procedures could result in damage to the equipment or injury to the installer.**
- Product warranty does not cover damage caused by improper installation.**

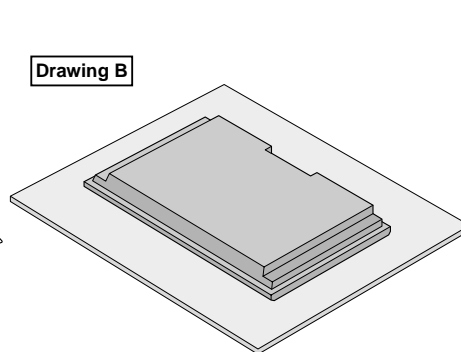
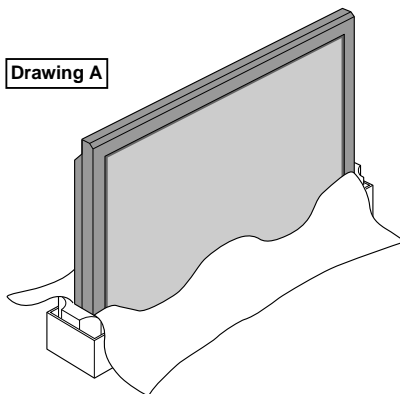

When installing or carrying, use the handles attached to the upper back of the display.



Ventilation Requirements for enclosure mounting

To allow heat to disperse, leave space between surrounding objects as shown on the diagram below when installing.

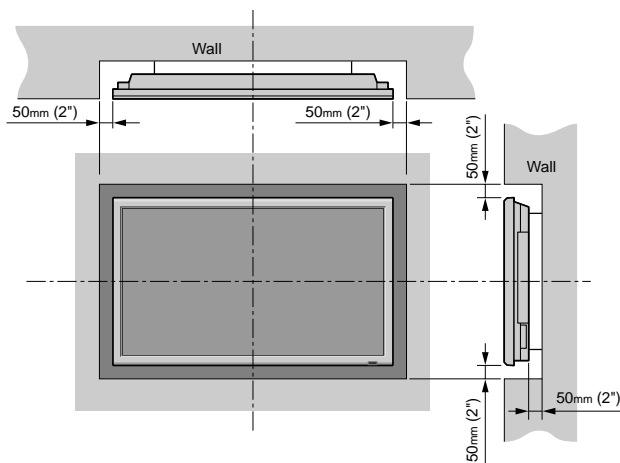

How to use the safety metal fittings and the screws for safety metal fittings

These are fittings for fastening the unit to a wall to prevent tipping due to external shock when using the stand (optional). Fasten the safety fittings to the holes in the back of the monitor using the safety fitting mount screws.

* Safety metal fittings will differ according to the model.

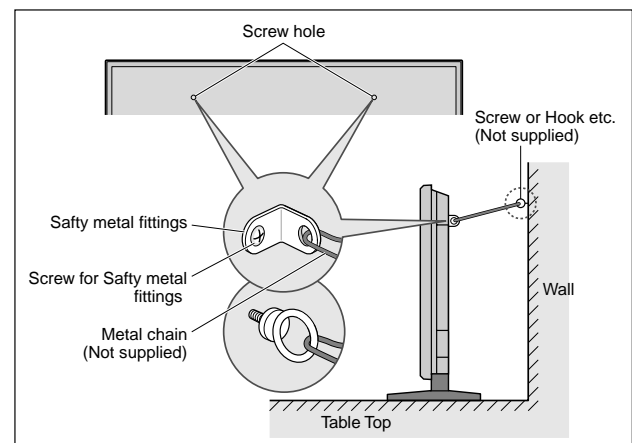

Creating a video wall

With built-in matrix display capability, you can create a 4-25 video wall.

- Connect signal cables and remote cables as shown below.

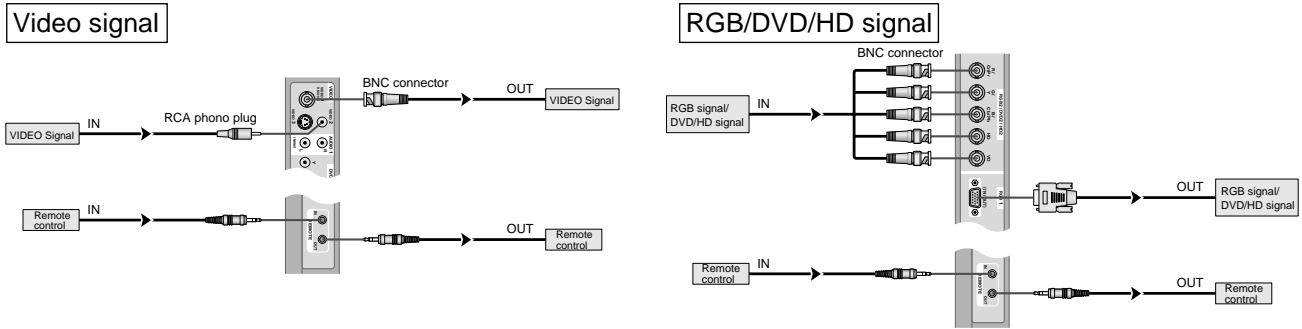

Note:

1. The VIDEO1 and RGB1 terminals can be used for either INPUT or OUTPUT.
When LOOP OUT is ON, do not connect an OUTPUT signal from another unit, that will place an extraordinary load on the other unit and may damage it.
2. LOOP OUT can not be turned ON while signals are input to the RGB1 terminal.
3. LOOP OUT can be turned ON while signals are input to the RGB1 terminal if the POWER is switched ON.

Information

- To loop signals out to another plasma display, set the LOOP OUT to ON.
- To create a video wall, set the VIDEO WALL menu items properly.
- To connect monitors, please use a 1~2m (3.3~6.6 feet) BNC cable (any commercially available cable).
- If the image quality is poor, do not use the monitor's out terminal. Use a distribution amplifier (any commercially available distribution amplifier) to connect the split signals to the respective monitor INPUT terminals.
- Being used as a video wall function, maximally 4-screen is rough-standard with lower than 1024×768, 60Hz signal.
- A distribution amplifier is particularly recommended when using 9-screen and over video wall.
- From the second monitor onward, connections require a BNC-RCA conversion cable or connector, a mini D-Sub 15 pin cable-BNC (×5) cable or a conversion connector.

Cable Management

Using the cable-clamps provided with the plasma display, bundle at the back of the unit the signal and audio cables connected to the display.

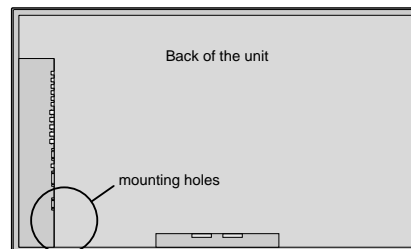

To attach

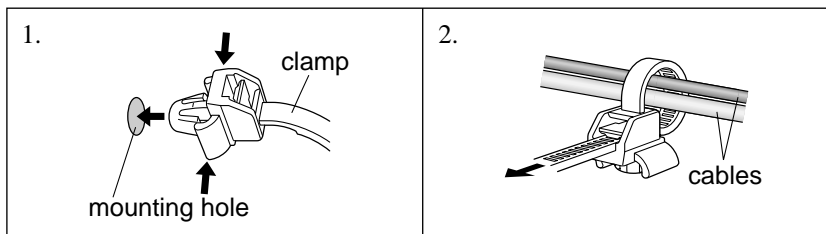

To detach

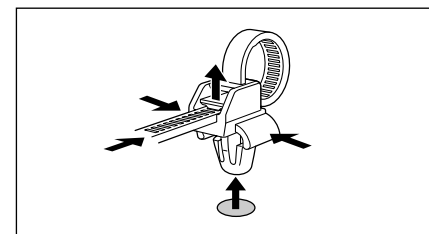

Caution on when the plasma monitor is installed vertically

- Use the optional unit. Contact your store of purchase when installing.
- Rotate 90° clockwise as seen from the front when installing.
- After installing, check with the NEC logo mark as seen from the front.
- Be sure to set "OSM ANGLE" to "V" when using.
- * Failure to heed the above cautions may lead to malfunction.

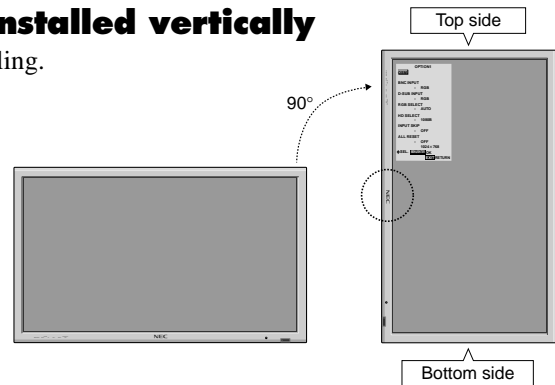

How to use the remote control

Battery Installation and Replacement

Insert the 2 "AAA" batteries, making sure to set them in with the proper polarity.

1. Press and open the cover.

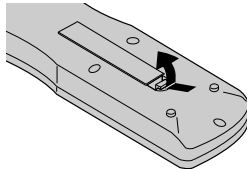

2. Align the batteries according to the (+) and (-) indication inside the case.

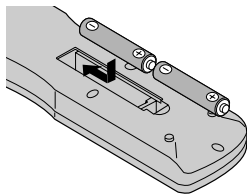

3. Replace the cover.

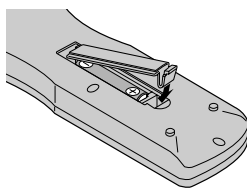

Using the wired remote control mode

Connect the remote cable* to the remote control's remote jack and the "REMOTE IN" terminal on the monitor.

When the cable is connected, the mode automatically switches to wired remote control. When the wired remote control mode is used, the remote control can be operated even if no batteries are loaded.

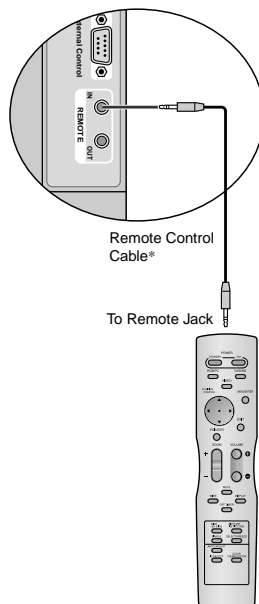

Operating Range

- * Use the remote control within a distance of about 7 m/23ft. from the front of the monitor's remote control sensor and at horizontal and vertical angles of up to approximately 30°.
- * The remote control operation may not function if the monitor's remote control sensor is exposed to direct sunlight or strong artificial light, or if there is an obstacle between the sensor and the remote control.

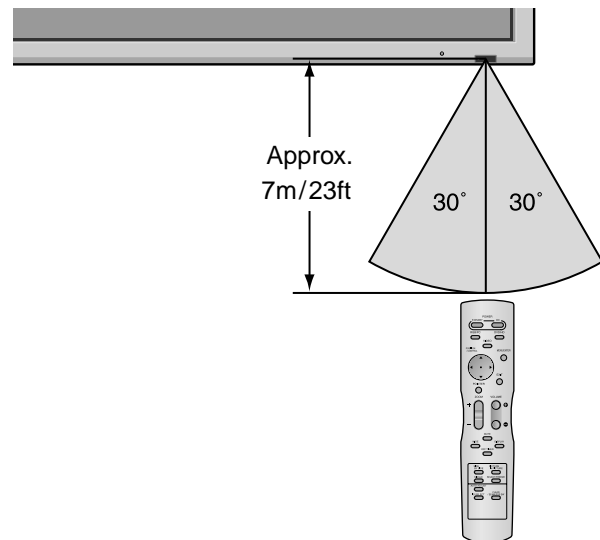

Handling the remote control

- Do not drop or mishandle the remote control.
- Do not get the remote control wet. If the remote control gets wet, wipe it dry immediately.
- Avoid heat and humidity.
- When not using the remote control for a long period, remove the batteries.
- Do not use new and old batteries together, or use different types together.
- Do not take apart the batteries, heat them, or throw them into a fire.
- When using the remote control in the wireless condition, be sure to unplug the remote cable from the REMOTE IN terminal on the monitor.

* The 1/8 Stereo Mini cable must be purchased separately.

Part Names and Function

Front View

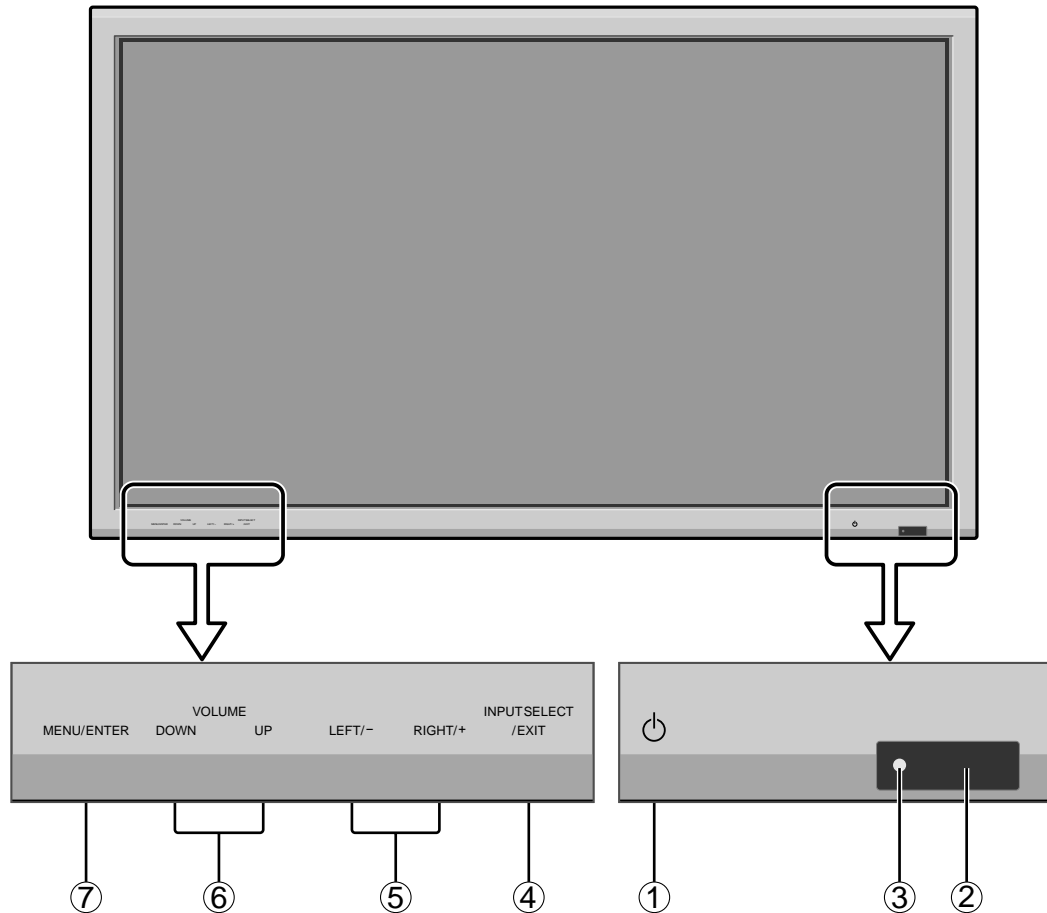

- ① **Power**
Turns the monitor's power on and off.
- ② **Remote sensor window**
Receives the signals from the remote control.
- ③ **POWER/STANDBY indicator**
When the power is on Lights green.
When the power is in the standby mode ... Lights red.
- ④ **INPUT SELECT / EXIT**
Switches the input.
The available inputs depend on the settings of "BNC INPUT", "D-SUB INPUT", "RGB SELECT" and "DVI SET UP".
Functions as the EXIT buttons in the On-Screen Menu (OSM) mode.
- ⑤ **LEFT/- and RIGHT/+**
Enlarges or reduces the image. Functions as the CURSOR (◀ / ▶) buttons in the On-Screen Menu (OSM) mode.
- ⑥ **VOLUME DOWN and UP**
Adjusts the volume. Functions as the CURSOR (▲ / ▼) buttons in the On-Screen Menu (OSM) mode.
- ⑦ **MENU/ENTER**
Sets the On-Screen Menu (OSM) mode and displays the main menu.

WARNING

The Power on/off switch does not disconnect the plasma display completely from the supply mains.

Note: This plasma monitor has the capacity to display images when connected to European DVD players with a SCART output signal, which is RGB with composite sync.

Your dealer can supply a special SCART cable, which will enable you to use the RGB with composite sync signal.

To obtain the special cable as well as for further information, please contact your dealer.

Please refer to page E-21 for selection of the correct mode in the on-screen manager.

Rear View/ Terminal Board

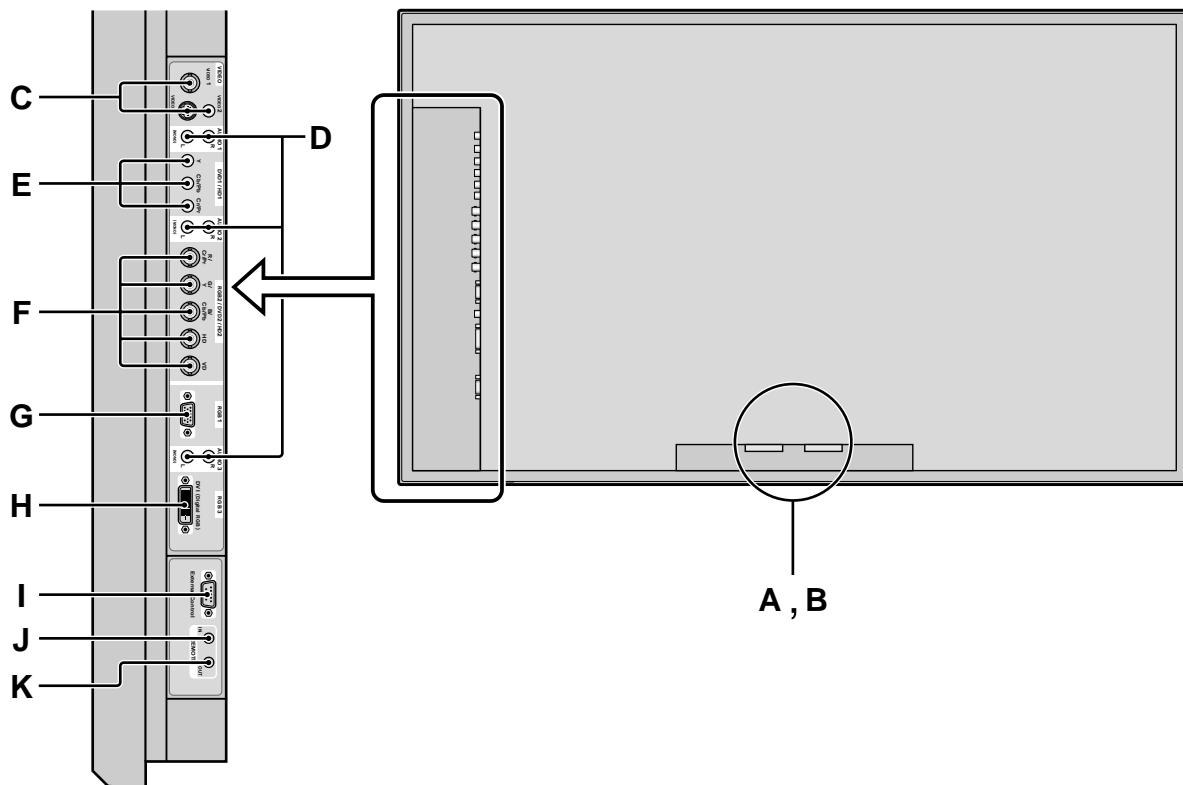

A AC IN

Connect the included power cord here.

B EXT SPEAKER L and R

Connect speakers (optional) here. Maintain the correct polarity. Connect the \oplus (positive) speaker wire to the \oplus EXT SPEAKER terminal and the \ominus (negative) speaker wire to the \ominus EXT SPEAKER terminal on both LEFT and RIGHT channels.

Please refer to your speaker's owner's manual.

C VIDEO1, 2, 3 (BNC, RCA, S-Video)

Connect VCR's, DVD's or Video Cameras, etc. here. VIDEO1 can be used for Input or Output (see page E-5).

D AUDIO1, AUDIO2, AUDIO3

These are audio input terminals.

The input is selectable. Set which video image to allot them from the audio menu screen.

E DVD1 / HD1

Connect DVD's, High Definition or Laser Discs, etc. here.

F RGB2/ DVD2/ HD2

RGB2: You can connect an analog RGB signal and the synchronization signal.

DVD2/ HD2: You can connect DVDs, High Definition sources, Laser Discs, etc. here.

This input can be set for use with an RGB or component source (see page E-21)

G RGB1 (mini D-Sub 15pin)

Connect an analog RGB signal from a computer, etc. here. This input can be used for Input or Output. (see

H RGB3 (DVI 24pin)

Connect a digital signal (TMDS) from a source with a DVI output.

This input can be set for use with an RGB/PC3 (see page E-26)

I EXTERNAL CONTROL

This terminal is used when operating and controlling the monitor externally (by RS-232C).

J REMOTE IN

Connect the remote cable* to the remote control's remote jack to obtain wired remote control.

K REMOTE OUT

Connect the remote cable* to the REMOTE IN jack of the other display monitor to obtain wired remote control.

* The 1/8 Stereo Mini cable must be purchased separately.

Information

- For Y/CB/Cr, connect to the DVD1 or DVD2 terminals.
- For SCART, this unit provides three ways to connect:
 - SCART1: Connect R/G/B to the DVD2 terminals and composite sync. to the HD terminal.
 - SCART2: Connect R/G/B to the DVD2 terminals and composite sync. to the VIDEO1 terminal.
 - SCART3: Connect R/G/B + composite sync. to the RGB1 terminal.

Remote Control

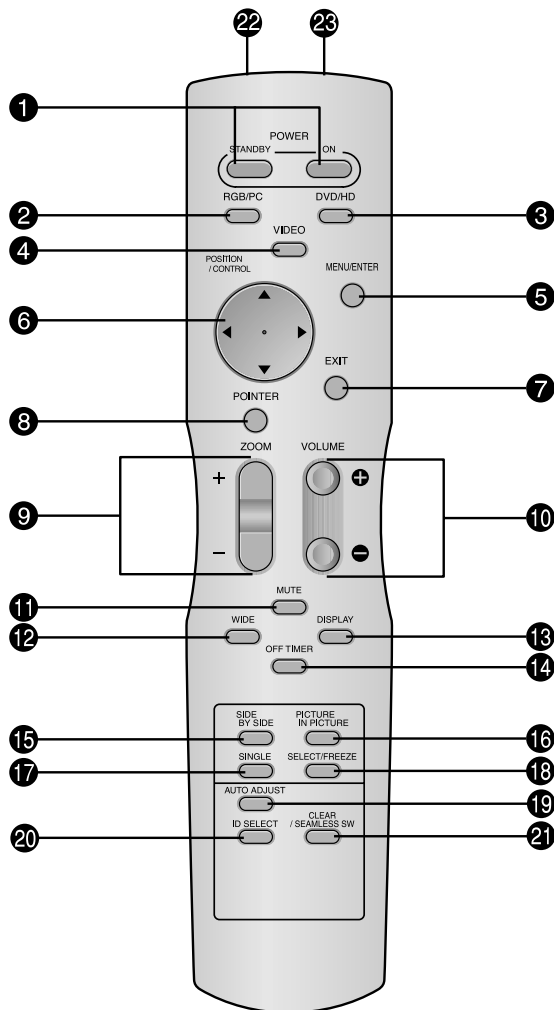

- 1 POWER ON/STANDBY**
Switches the power on/standby.
(This does not operate when POWER/STANDBY indicator of the main unit is off.)
- 2 RGB/PC**
Press this button to select RGB/PC as the source.
RGB/PC can also be selected using the INPUT SELECT button on the monitor.
- 3 DVD / HD**
Press this button to select DVD/HD as the source.
DVD/HD can also be selected using the INPUT SELECT button on the monitor.
- 4 VIDEO**
Press this button to select VIDEO as the source.
→ VIDEO1 → VIDEO2 → VIDEO3
VIDEO can also be selected using the INPUT SELECT button on the monitor.
- 5 MENU/ENTER**
Press this button to access the OSM controls.
Press this button during the display of the main menu to go to the sub menu.
- 6 CURSOR (▲ / ▼ / ◀ / ▶)**
Use these buttons to select items or settings and to adjust settings or switch the display patterns.

- 7 EXIT**
Press this button to exit the OSM controls in the main menu. Press this button during the display of the sub menu to return to the previous menu.
- 8 POINTER**
Press this button to display the pointer.
- 9 ZOOM (+ / -)**
Enlarges or reduces the image.
- 10 VOLUME (+ / -)**
Adjusts the audio volume.
- 11 MUTE**
Mutes the audio.
- 12 WIDE**
Automatically detects the signal and sets the aspect ratio.
Wide button is not active for all signals.
- 13 DISPLAY**
Displays the source settings on the screen.
- 14 OFF TIMER**
Activates the off timer for the unit.
- 15 SIDE BY SIDE**
Press this button to show a couple of pictures in the side-by-side mode.
- 16 PICTURE IN PICTURE**
Press this button to show a couple of pictures in the picture-in-picture mode.
- 17 SINGLE**
Cancels the split screen mode.
- 18 SELECT/FREEZE**
Press this button to select the active picture in a split screen mode.
When the PIC FREEZE function is operating, this button can be used to display still images on the sub screen.
- 19 AUTO ADJUST**
Press this button to adjust Fine Picture, Picture ADJ, Position, and Contrast automatically, or to switch the screen size to ZOOM mode automatically with the superimposed caption displayed fully only when the picture contains dark areas above and below the picture.
- 20 ID SELECT**
Set the ID number in the remote control. The remote control can then be used only for a display with the same ID number. When several displays are used together they can be controlled individually.
- 21 CLEAR/SEAMLESS SW**
Clears the number set by the ID SELECT button.
When the SEAMLESS SW function is operating, this button can be used to switch the input source quickly.
- 22 Remote control signal transmitter**
Transmits the remote control signals.
- 23 Remote Jack**
Insert the plug of the remote cable (The 1/8 Stereo Mini cable) here when using the supplied remote control in the wired condition.

Basic Operations

POWER

To turn the unit ON and OFF:

1. Plug the power cord into an active AC power outlet.
2. Press the Power button (on the unit).
The monitor's POWER/STANDBY indicator turns red and the standby mode is set.
3. Press the POWER ON button (on the remote control) to turn on the unit.
The monitor's POWER/STANDBY indicator will light up (green) when the unit is on.
4. Press the POWER STANDBY button (on the remote control) or the Power button (on the unit) to turn off the unit.
The monitor's POWER/STANDBY indicator turns red and the standby mode is set (only when turning off the unit with the remote control).

VOLUME

To adjust the sound volume:

1. Press and hold the VOLUME ⊕ button (on the remote control or the unit) to increase to the desired level.
2. Press and hold the VOLUME ⊖ button (on the remote control or the unit) to decrease to the desired level.

MUTE

To mute the audio:

Press the MUTE button on the remote control to mute the audio; press again to restore.

DISPLAY

To check the settings:

1. The screen changes each time the DISPLAY button is pressed.
2. If the button is not pressed for approximately three seconds, the menu turns off.

DIGITAL ZOOM

Digital zoom specifies the picture position and enlarges the picture.

1. (Be sure ZOOM NAV is off.)
Press the POINTER button to display the pointer. ()

To change the size of the picture:

Press the ZOOM+ button and enlarge the picture.
The pointer will change to resemble a magnifying glass. ()

A press of the ZOOM- button will reduce the picture and return it to its original size.

To change the picture position:

1. Select the position with the ▲▼◀▶ buttons.
2. Press the POINTER button to delete the pointer.

AUTO ADJUST

To adjust the size or quality of the picture automatically:

Press the AUTO ADJUST button.

Information

■ AUTO ADJUST ON setting

When RGB (still picture) input is selected:
Fine Picture, Picture ADJ, Position, and Contrast will be adjusted automatically.

When RGB (motion picture), VIDEO, or Y/Pb/Pr (component) input is selected: The screen size switches to ZOOM mode automatically with the superimposed caption displayed fully only when the picture contains dark areas above and below the picture.

OFF TIMER

To set the off timer:

The off timer can be set to turn the power off after 30, 60, 90 or 120 minutes.

1. Press the OFF TIMER button to start the timer at 30 minutes.
2. Press the OFF TIMER button to the desired time.
3. The timer starts when the menu turns off.

→ 30 → 60 → 90 → 120 → 0

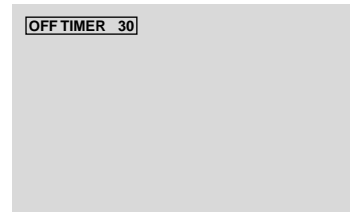

To check the remaining time:

1. Once the off timer has been set, press the OFF TIMER button once.
2. The remaining time is displayed, then turns off after a few seconds.
3. When five minutes remain the remaining time appears until it reaches zero.

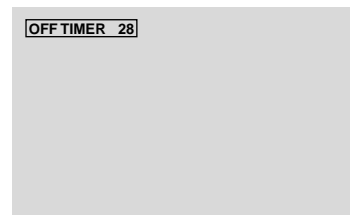

To cancel the off timer:

1. Press the OFF TIMER button twice in a row.
2. The off timer is canceled.



Note:

After the power is turned off with the off timer ...
A slight current is still supplied to the monitor. When you are leaving the room or do not plan to use the system for a long period of time, turn off the power of the monitor.

WIDE Operations

Wide Screen Operation (manual)

With this function, you can select one of six screen sizes.

When viewing videos or digital video discs

1. Press the WIDE button on the remote control.
2. *Within 3 seconds ...*

Press the WIDE button again.

The screen size switches as follows:

→ NORMAL → FULL → STADIUM → ZOOM → 2.35:1 → 14:9 →

When a 720P or 1080I signal is input:

FULL ↔ 2.35:1

When displaying enhanced split screen:

NORMAL ↔ FULL

NORMAL size screen (4:3)

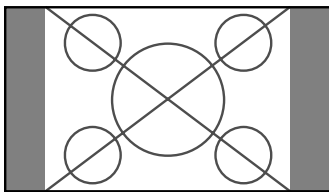

The normal size screen is displayed.

- * The picture has the same size as video pictures with a 4 : 3 aspect ratio.

FULL size screen

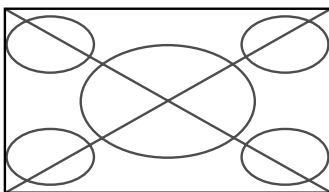

The image is expanded in the horizontal direction.

- * Images compressed in the horizontal direction ("squeezed images") are expanded in the horizontal direction and displayed on the entire screen with correct linearity. (Normal images are expanded in the horizontal direction.)

STADIUM size screen

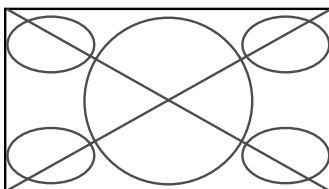

The picture is expanded in the horizontal and vertical directions at different ratios.

- * Use this for watching normal video programs (4:3) with a wide screen.

ZOOM size screen

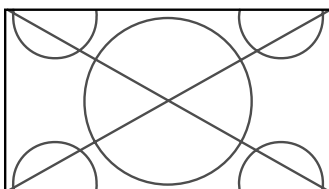

The picture is expanded in the horizontal and vertical direction, maintaining the original proportions.

- * Use this for theater size (wide) movies.

2.35:1 size screen

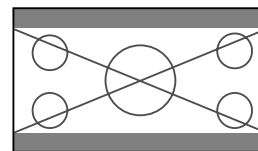

Original image

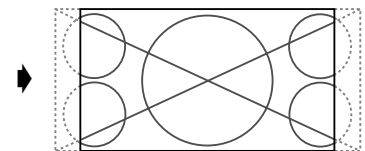

Information is lost on both sides.

The squeezed film image is expanded to fulfill the entire screen at a ratio of 2.35:1. Black bands do not appear at the top and bottom but information is lost on the left and right margins.

- * This feature is available when the input signal is video, component (480I, 480P, 576I, 576P, 720P, 1080I) or RGB (525P or 625P signal from a scan converter).

- * If black bands appear on the top and bottom in the full size screen, select the 2.35:1 size screen to avoid phosphor burn-in.

14:9 size screen

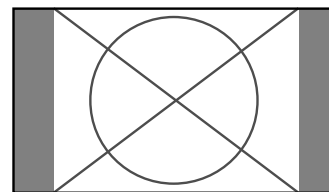

The image is displayed at a 14:9 aspect ratio.

- * This feature is available when the input signal is video, component (480I, 480P, 576I, 576P) or RGB (525P or 625P signal from a scan converter).

Note:

Do not allow the displayed in 4:3 mode for an extended period. This can cause a phosphor burn-in.

Wide Screen Operation with Computer Signals

Switch to the wide screen mode to expand the 4 : 3 image to fill the entire screen.

1. Press the WIDE button on the remote control.
2. *Within 3 seconds ...*

Press the WIDE button again.

The screen size switches as follows:

→ **NORMAL** → **FULL** → **ZOOM**

When displaying enhanced split screen:

NORMAL ↔ **FULL**

NORMAL size screen (4:3 or SXGA 5:4)

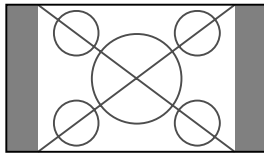

The picture has the same size as the normal computer image.

FULL size screen

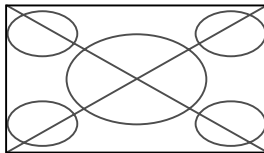

The image is expanded in the horizontal direction.

ZOOM size screen

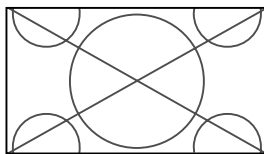

When wide signals are input.

FULL size screen

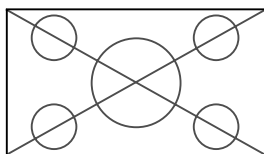

When **“PICTURE SIZE”** is set to **“OFF”**

The screen size switches as follows:

→ **TRUE** → **FULL** → **ZOOM**

TRUE size screen (VGA, SVGA 4:3)

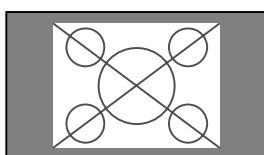

The image is true resolution.

FULL size screen

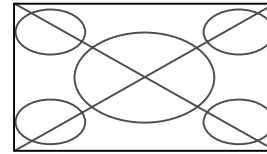

The image is expanded in the horizontal and vertical direction.

ZOOM size screen

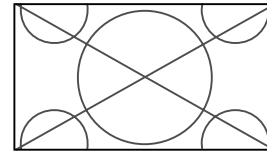

When wide signals are input.

TRUE

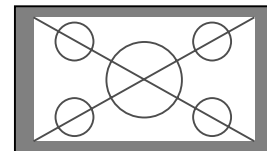

The image is true resolution.

FULL

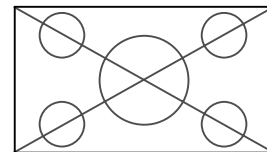

Information

■ Supported resolution

See page E-2 of Model Information for details on the display output of the various VESA signal standards supported by the monitor.

■ “PICTURE SIZE” setting

When the setting of “PICTURE SIZE” is OFF, the size of RGB-input pictures will be TRUE in place of NORMAL.

■ When 852 (848) dot × 480 line wide VGA* signals with a vertical frequency of 60 Hz and horizontal frequency of 31.7 (31.0) kHz are input

Select an appropriate setting for RGB SELECT mode referring to the “Table of Signals Supported” on page E-2 of Model Information.

* “VGA”, “SVGA” and “SXGA” are registered trademarks of IBM, Inc. of the United States.

Note:

Do not allow the displayed in 4:3 mode for an extended period. This can cause a phosphor burn-in.

SPLIT SCREEN Operations

Showing a couple of pictures on the screen at the same time

* An RGB-input picture may not be displayed in these modes, depending on the input signal specifications.

1. Press the button to select a screen mode from among single mode, side-by-side, and picture-in-picture.

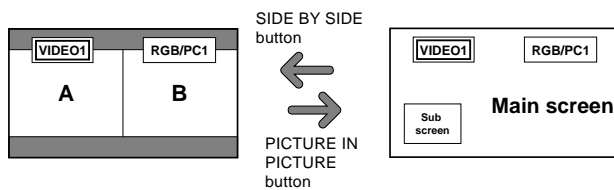
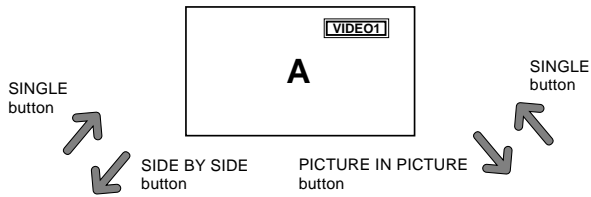

Note:

Picture A and B on the above screen are not always of the same height.

Information

Split screen operations may not function depending on the combination of input signals. In the table below, "○" means Yes, "×" means No.

	Pictures displayed on the right/main screen (Select1)							
	VIDEO1	VIDEO2	VIDEO3	HD/DVD1	HD/DVD2	RGB/PC1	RGB3	SCART1-3
Pictures displayed on the left/sub screen (Select2)	VIDEO1	×	×	×	○	○	○	×
	VIDEO2	×	×	×	○	○	○	×
	VIDEO3	×	×	×	○	○	○	×
	HD/DVD1	○	○	○	×	○	○	○
	HD/DVD2	○	○	○	○	×	○	1.2:×
	RGB2	○	○	○	○	○	×	3:○
	RGB/PC1	○	○	○	○	○	×	1.2:○
								3:×
	RGB3	○	○	○	○	○	○	×
	SCART1-3	×	×	×	○	1.2:×	1.2:○	○
					3:○	3:×		

■ Split screen operations may not function depending on the type of the RGB signals.

Operations in the Side-by-side mode

To change the picture size, press the cursor ◀▶ or ▼ button.

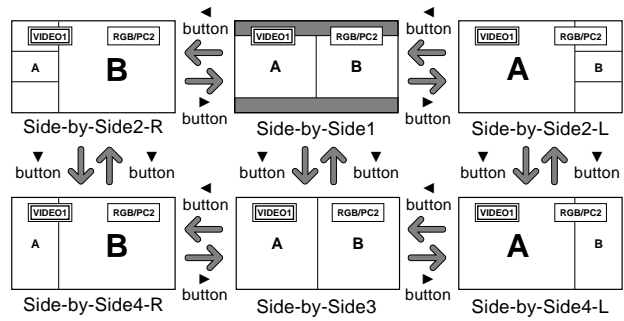

To swap the picture on the right and the left, press the cursor ▲ button.

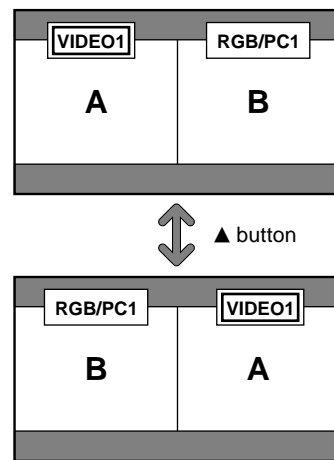

To make the desired picture active, press the SELECT/FREEZE button.

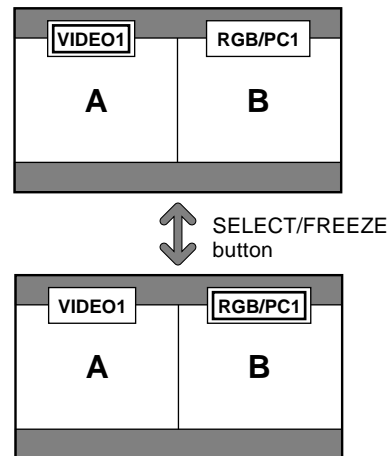

Operations in the Picture-in-picture mode

To move the position of the sub screen, press the cursor ◀ or ▶ button.

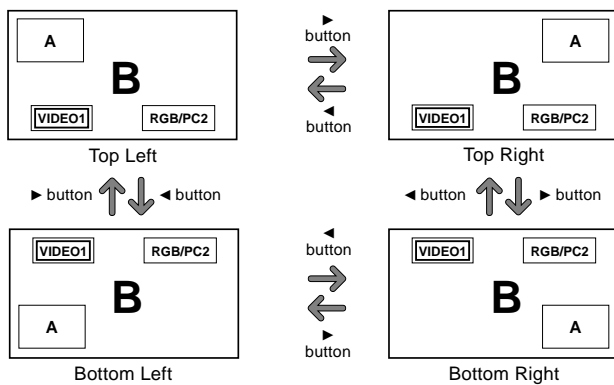

To change the size of the sub screen, press the ▼ button.

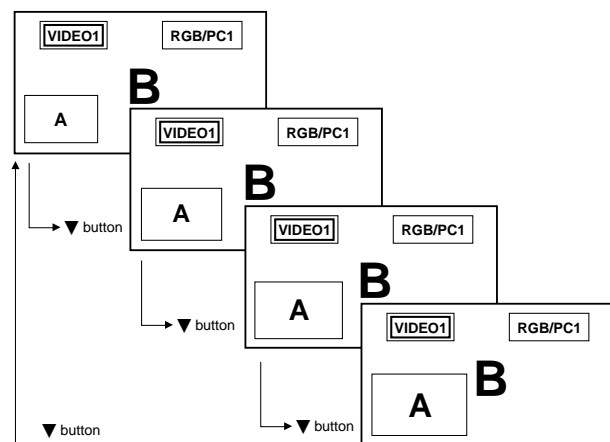

To make the desired picture active, press the SELECT/FREEZE button.

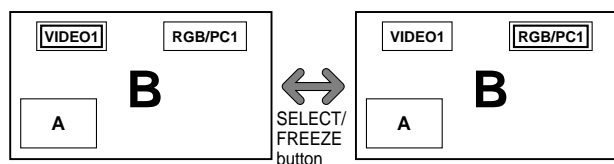

Selecting the input signals to be displayed

1. Press the SELECT/FREEZE button to make the desired picture active.
2. Press the RGB/PC, VIDEO, or DVD/HD button. Each press of the button changes the selection of the input signal. The INPUT SELECT button on the monitor can also be used to change the selection.

Zooming up pictures

1. Press the SELECT/FREEZE button to make the desired picture active.
2. Use the POINTER button and the ZOOM + / - button to enlarge the picture. For details, see “DIGITAL ZOOM” on page E-10.

Adjusting the OSM controls

1. Press the SELECT/FREEZE button to make the desired picture active.
2. Press the MENU/ENTER button to display the MAIN MENU.
3. Adjust the setting to your preference. For details, see “OSM (On Screen Menu) Controls” on page E-15.

Note:

During enhanced split screen mode, some functions of OSM controls are not available.

OSM(On Screen Menu) Controls

Menu Operations

The OSM window is displayed with respect to the screen as shown on the diagram.

* Depending on the screen's mode, the OSM may be displayed differently.

In the explanation, the OSM section is shown close up.

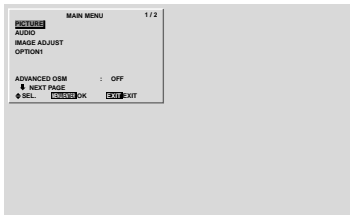

The following describes how to use the menus and the selected items.

1. Press the MENU/ENTER button on the remote control to display the MAIN MENU.

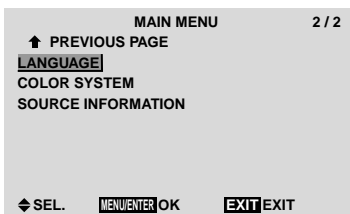
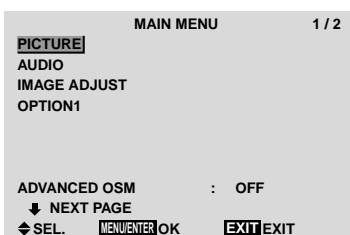

2. Press the cursor buttons ▲ ▼ on the remote control to highlight the menu you wish to enter.
3. Press the MENU/ENTER button on the remote control to select a sub menu or item.

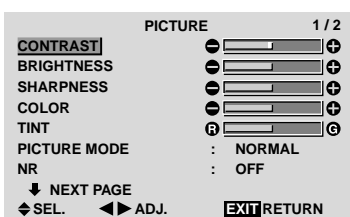

4. Adjust the level or change the setting of the selected item by using the cursor buttons ◀ ▶ on the remote control.
5. The adjustments or the settings that are stored in memory. The change is stored until you change it again.
6. Repeat steps 2 – 5 to adjust an additional item, or press the EXIT button on the remote control to return to the main menu.

* When adjusting using the bar at the bottom of the screen, press the ◀ or ▶ button within 5 seconds. If not, the current setting is set and the previous screen appears.

Note: The main menu disappears by pressing the EXIT button.

Information

■ Advanced menu mode

When “ADVANCED OSM” is set to “ON” in the main menu (1/2), full menu items will be shown.

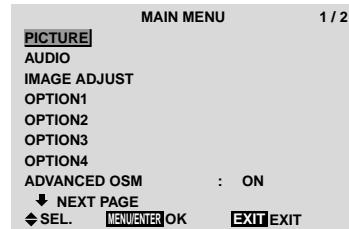

Menu Tree

▒: Shaded areas indicate the default value.

← → + : Press the ◀ or ▶ button to adjust. The default value is at the center.

▭: Menu items in a ruled box are available when the ADVANCED OSM is set to ON.

Main menu	Sub menu	Sub menu 2	Sub menu 3	Sub menu 4	RESET	REFERENCE
PICTURE	CONTRAST	← → + 0 ← 52 → 72			YES	E-18
	BRIGHTNESS	← → + 0 ← 32 → 64			YES	E-18
	SHARPNESS	← → + 0 ← 16 → 32			YES	E-18
	COLOR	← → + 0 ← 32 → 64			YES	E-18
	TINT	R ← → G 0 ← 32 → 64			YES	E-18
	PICTURE MODE	BRIGHT/NORMAL/THEAT.1/THEAT.2/DEFAULT			YES	E-18
	NR	OFF/NR-1/NR-2/NR-3			YES	E-18
	COLOR TEMP	LOW/MID LOW/MID/HIGH			YES	E-18
	WHITE BALANCE	GAIN RED	← → + 0 ← → 70		YES	E-19
		GAIN GREEN	← → + 0 ← → 70		YES	E-19
		GAIN BLUE	← → + 0 ← → 70		YES	E-19
		BIAS RED	← → + 0 ← → 70		YES	E-19
		BIAS GREEN	← → + 0 ← → 70		YES	E-19
		BIAS BLUE	← → + 0 ← → 70		YES	E-19
		RESET	OFF ← → ON		YES	E-19
		GAMMA	1 ← → 2 ← → 3 ← → 4		YES	E-19
		LOW TONE	AUTO ← → 1 ← → 3		YES	E-19
		COLOR TUNE	RED	Y ← → M 0 ← → 64	YES	E-19
			GREEN	C ← → Y 0 ← → 64	YES	E-19
			BLUE	M ← → C 0 ← → 64	YES	E-19
			YELLOW	G ← → R 0 ← → 64	YES	E-19
			MAGENTA	R ← → B 0 ← → 64	YES	E-19
			CYAN	B ← → G 0 ← → 64	YES	E-19
		RESET	OFF ← → ON		YES	E-19

Main menu	Sub menu	Sub menu 2	Sub menu 3	Sub menu 4	RESET	REFERENCE
AUDIO	BASS	← → + 0 ← 13 → 26			YES	E-20
	TREBLE	← → + 0 ← 13 → 26			YES	E-20
	BALANCE	L ← → R -22 ← 0 → 22			YES	E-20
	AUDIO INPUT1	VIDEO 1-3 / HD/DVD 1-2 / RGB 1-3			YES	E-20
	AUDIO INPUT2	VIDEO 1-3 / HD/DVD 1-2 / RGB 1-3			YES	E-20
	AUDIO INPUT3	VIDEO 1-3 / HD/DVD 1-2 / RGB 1-3			YES	E-20

Main menu	Sub menu	Sub menu 2	Sub menu 3	Sub menu 4	RESET	REFERENCE
IMAGE ADJUST	ASPECT MODE	NORMAL/FULL/STADIUM/ZOOM/2.35:1/14:9			—	E-20
	V-POSITION	← → + -64 ← 0 → 64			YES	E-20
	H-POSITION	← → + -128 ← 0 → 127			YES	E-20
	V-HEIGHT	← → + 0 ← → 64			YES	E-20
	H-WIDTH	← → + 0 ← → 64			YES	E-20
	AUTO PICTURE	OFF ← → ON*2			NO	E-20
	FINE PICTURE*1	← → + *2 0 ← → 64			YES	E-20
	PICTURE ADJ.*1	← → + *2 0 ← → 128			YES	E-20

Main menu	Sub menu	Sub menu 2	Sub menu 3	Sub menu 4	RESET	REFERENCE
OPTION1	OSM	DISPLAY OSM	OFF ← → ON		YES	E-21
		OSM ADJ.	1 ← → 6		YES	E-21
		OSM ANGLE	H ← → V		YES	E-21
		OSM ORBITER	OFF ← → ON		YES	E-21
		OSM CONTRAST	LOW ← → NORMAL		YES	E-21
		BNC INPUT	RGB ← → COMP. ← → SCART1 ← → SCART2		YES	E-21
		D-SUB INPUT	RGB ← → SCART3		—	E-21
	RGB SELECT	AUTO/STILL/MOTION/WIDE1/WIDE2/WIDE3/DTV			YES	E-21
	HD SELECT	1080B/1035I/1080A			NO	E-22
	INPUT SKIP	OFF ← → ON			YES	E-22
	ALL RESET	OFF ← → ON			—	E-22

Main menu	Sub menu	Sub menu 2	Sub menu 3	Sub menu 4	RESET	REFERENCE	
OPTION2	PWR. MGT.	OFF↔ON			YES	E-23	
	CINEMA MODE	OFF↔ON			YES	E-23	
	LONG LIFE	PLE		AUTO/LOCK 1/LOCK 2/LOCK 3		YES	E-23
		ORBITER		AUTO 1		YES	E-24
				AUTO 2		YES	E-24
				MANUAL	H-DOT/V-LINE/TIME	YES	E-24
				OFF		YES	E-24
		INVERSE	OFF			YES	E-24
			ON		WORKING TIME/WAITING TIME	YES	E-24
			WHITE			YES	E-24
		SCREEN WIPER	OFF			YES	E-25
			ON		WORKING TIME/WAITING TIME/SPEED	YES	E-25
		SOFT FOCUS	OFF/1/2/3/4			YES	E-25
	GRAY LEVEL		0↔3↔15			YES	E-25
	S1/S2		AUTO↔OFF			YES	E-25
	PICTURE SIZE		OFF↔ON			YES	E-26
	DVI SET UP	PLUG/PLAY		PC↔STB/DVD		NO	E-26
BLACK LEVEL			LOW↔HIGH		NO	E-26	

Main menu	Sub menu	Sub menu 2	Sub menu 3	Sub menu 4	RESET	REFERENCE		
OPTION3	TIMER	PRESENT TIME	SUMMER TIME	OFF↔ON	NO	E-26		
			DAY/HOUR/MINUTES		NO	E-26		
		PROGRAM	OFF		YES	E-27		
				DATE/ON/OFF(HOUR, MINUTE)/INPUT/FUNCTION	YES	E-27		
		MULTI REPEAT	OFF		YES	E-27		
			ON		MULTI MODE/WORK TIME/INPUT MODE	YES	E-27	
	PWR. ON MODE		LAST /MULTI/ VIDEO 1-3 / HD/DVD 1-2 / RGB 1-3			YES	E-28	
	CONTROL LOCK		OFF↔ON			YES	E-28	
	IR REMOTE		OFF↔ON			YES	E-28	
	LOOP OUT		OFF↔ON			YES	E-28	
	ID NUMBER		ALL↔1↔256			YES	E-29	
	VIDEO WALL	DIVIDER		OFF/1/4/9/16/25		YES	E-29	
		POSITION		No.1↔No.4/No.7↔No.15/No.16↔No.31/No.32↔No.56		—	E-29	
		DISP. MODE		SPLIT↔BLANK		YES	E-30	
		AUTO ID		OFF↔ON		YES	E-30	
		IMAGE ADJUST	ASPECT MODE		NORMAL/FULL/STADIUM/ZOOM/2.35:1/14:9		—	E-30
			V-POSITION		—↔+ -64↔+64		YES	E-30
			H-POSITION		—↔+ -128↔+127		YES	E-30
			V-HEIGHT		—↔+ 0↔+64		YES	E-30
			H-WIDTH		—↔+ 0↔+64		YES	E-30
			AUTO PICTURE		OFF↔ON*2		NO	E-30
			FINE PICTURE*1		—↔+ *2 0↔+64		YES	E-30
		PICTURE ADJ.*1		—↔+ *2 0↔+128		YES	E-30	
		P. ON DELAY		OFF/ON/MODE1/MODE2		YES	E-30	
	PLE LINK		OFF↔ON		YES	E-31		
	REPEAT TIMER		OFF			YES	E-31	
			ON		DIVIDER/SOURCE/WORK TIME	YES	E-31	

Main menu	Sub menu	Sub menu 2	Sub menu 3	Sub menu 4	RESET	REFERENCE
OPTION4	SUB P. DETECT	OFF↔AUTO			YES	E-32
	ZOOM NAV	OFF↔S BY S↔BTM LFT↔BTM RGT↔TOP RGT↔TOP LFT			YES	E-32
	PIC FREEZE	OFF↔S BY S1↔S BY S2↔BTM LFT↔BTM RGT↔TOP RGT↔TOP LFT			YES	E-32
	SEAMLESS SW		OFF			YES
		ON	SELECT1/SELECT2		YES	E-33

Main menu	Sub menu	Sub menu 2	Sub menu 3	Sub menu 4	RESET	REFERENCE
ADVANCED OSM		OFF↔ON			YES	E-33
LANGUAGE		ENGLISH/DEUTSCH/FRANÇAIS/ESPAÑOL/ITALIANO/SVENSKA/中文/РУССКИЙ			NO	E-33
COLOR SYSTEM		AUTO/3.58NTSC/4.43 NTSC/PAL/PAL 60/PAL-N/PAL-M/SECAM			NO	E-34
SOURCE INFORMATION		—			—	E-34

*1 Only when AUTO PICTURE is OFF

*2 RGB/PC only

Information

■ Restoring the factory default settings

Select "ALL RESET" under the OPTION1 menu. Note that this also restores other settings to the factory defaults.

Picture Settings Menu

Adjusting the picture

The contrast, brightness, sharpness, color and tint can be adjusted as desired.

Example: Adjusting the contrast

On "CONTRAST" of "PICTURE" menu, adjust the contrast.

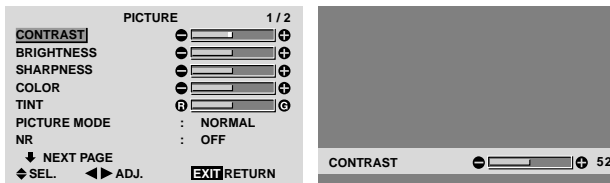

Note: If "CAN NOT ADJUST" appears ...
When trying to enter the PICTURE submenu, make sure PICTURE MODE is not set to DEFAULT.

Information

Picture adjustment screen

CONTRAST: Changes the picture's white level.
BRIGHTNESS: Changes the picture's black level.
SHARPNESS: Changes the picture's sharpness.
Adjusts picture detail of VIDEO display.
COLOR: Changes the color density.
TINT: Changes the picture's tint. Adjust for natural colored skin, background, etc.

Adjusting the computer image

Only the contrast and brightness can be adjusted when a computer signal is connected.

Restoring the factory default settings

Select "DEFAULT" under the "PICTURE MODE" settings.

Setting the picture mode according to the brightness of the room

There are four picture modes that can be used effectively according to the environment in which you are viewing the display.

Example: Setting the "THEAT. 1" mode

On "PICTURE MODE" of "PICTURE" menu, select "THEAT. 1".

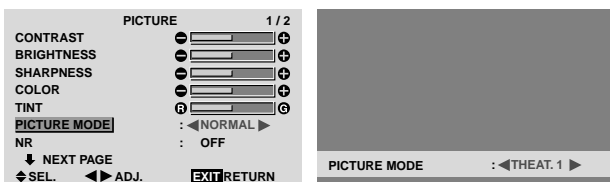

Information

Types of picture modes

THEAT. 1, 2: Set this mode when watching video in a dark room.

This mode provides darker, finer pictures, like the screen in movie theaters.

For a darker image, select THEAT. 2.

NORMAL: Set this mode when watching video in a bright room.

This mode provides dynamic pictures with distinct differences between light and dark sections.

BRIGHT: This mode provides brighter pictures than NORMAL.

DEFAULT: Use this to reset the picture to the factory default settings.

Reducing noise in the picture

Use these settings if the picture has noise due to poor reception or when playing video tapes on which the picture quality is poor.

Example: Setting "NR-3"

On "NR" of "PICTURE" menu, select "NR-3".

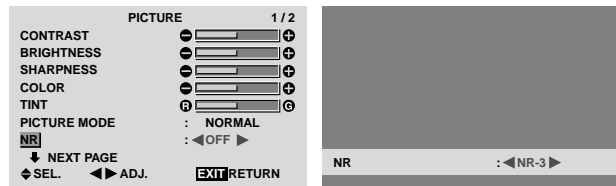

Information

NR

* "NR" stands for Noise Reduction.

* This function reduces noise in the picture.

Types of noise reduction

There are three types of noise reduction. Each has a different level of noise reduction.

The effect becomes stronger as the number increases (in the order NR-1 → NR-2 → NR-3).

OFF: Turns the noise reduction function off.

Setting the color temperature

Use this procedure to set color tone produced by the plasma display.

Example: Setting "HIGH"

On "COLOR TEMP." of "PICTURE" menu, select "HIGH".

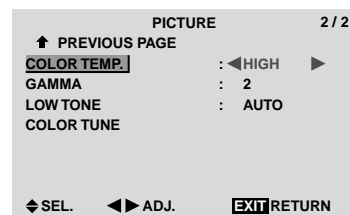

Information

Setting the color temperature

LOW: Redder

MID LOW: Slightly red

MID: Standard (slightly bluer)

HIGH: Bluer

Adjusting the color to the desired level

Use this procedure to adjust the white balance for each color temperature to achieve the desired color quality.

Example: Adjusting the "GAIN RED" of "HIGH" color temperature

Set "ADVANCED OSM" to "ON" in the main menu (1/2), then perform the following operations.

On "COLOR TEMP." of "PICTURE" menu, select "HIGH", then press the MENU/ENTER button.

The "WHITE BALANCE" screen appears.

On "GAIN RED", adjust the white balance.

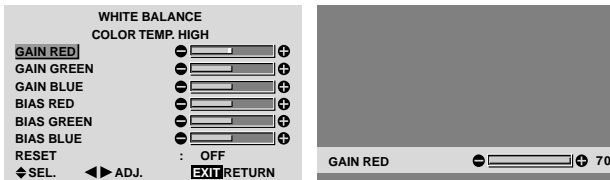

Information

■ Adjusting the white balance

GAIN R/G/B: White balance adjustment for white level

BIAS R/G/B: White balance adjustment for black level

RESET: Resets settings to the factory default values.

Use ◀ and ▶ buttons to select "ON", then press the MENU/ENTER button.

■ Restoring the factory default settings

Select "RESET" under the WHITE BALANCE menu.

Changing the Gamma Curve

This feature adjusts the brightness of the midtone areas while keeping shadows and highlights unchanged.

Example: Setting "3"

Set "ADVANCED OSM" to "ON" in the MAIN MENU (1/2), then perform the following operations.

On "GAMMA" of "PICTURE" menu, select "3".

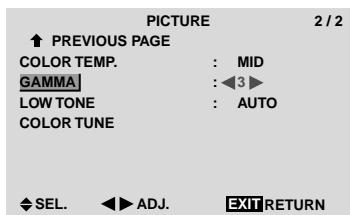

Information

■ GAMMA settings

The picture becomes darker as the number increases (in the sequence of 1, 2, 3, 4).

Making the Low Tone adjustments

This feature allows more detailed tone to be reproduced especially in the dark area.

Example: Setting "2"

Set "ADVANCED OSM" to "ON" in the MAIN MENU (1/2), then perform the following operations.

On "LOW TONE" of "PICTURE" menu, select "2".

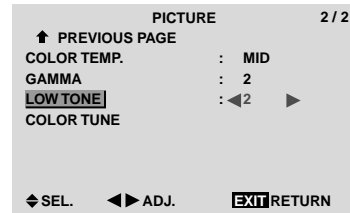

Information

■ LOW TONE settings

AUTO: Will automatically appraise the picture and make adjustments.

1: Will apply the dither method suitable for still pictures.

2: Will apply the dither method suitable for motion pictures.

3: Will apply the error diffusion method.

Adjusting the colors

Use this procedure to adjust hue and color density for red, green, blue, yellow, magenta and cyan.

Such adjustments will not affect the other colors.

You can accentuate the green color of trees, the blue of the sky, etc.

Example: Adjusting the color tune for blue

Set "ADVANCED OSM" to "ON" in the MAIN MENU (1/2), then perform the following operations.

On "PICTURE" menu, select "COLOR TUNE", then press the MENU/ENTER button.

The "COLOR TUNE" screen appears.

On "BLUE" of "COLOR TUNE", adjust the color tune.

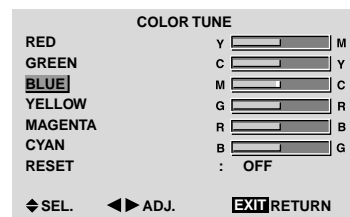

Information

■ COLOR TUNE settings

RED: Makes red's adjustment

GREEN: Makes green's adjustment

BLUE: Makes blue's adjustment

YELLOW: Makes yellow's adjustment

MAGENTA: Makes magenta's adjustment

CYAN: Makes cyan's adjustment

RESET: Resets settings to the factory default value.

Use ◀ and ▶ buttons to select "ON", then press the MENU/ENTER button.

Audio Settings Menu

Adjusting the treble, bass and left/right balance and audio input select

The treble, bass and left/right balance can be adjusted to suit your tastes.

Example: Adjusting the bass

On "BASS" of "AUDIO" menu, adjust the bass.

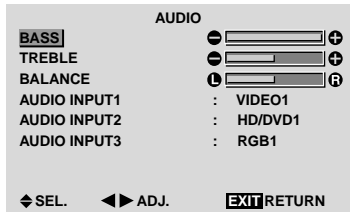

Note : If "CAN NOT ADJUST" appears...
Set "AUDIO INPUT" on the AUDIO menu correctly.

Information

■ Audio settings menu

BASS: Controls the level of low frequency sound.
TREBLE: Controls the level of high frequency sound.
BALANCE: Controls the balance of the left and right channels.

Setting the allocation of the audio connectors

Setting the AUDIO 1, 2, and 3 connectors to the desired input.

Example: Setting "AUDIO INPUT1" to "VIDEO 2"

On "AUDIO INPUT1" of "AUDIO" menu, select "VIDEO2".

The available sources depend on the settings of input.

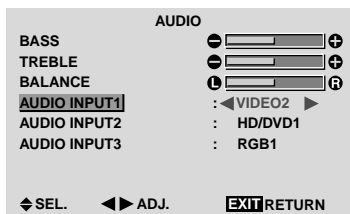

Information

■ AUDIO INPUT

A single audio input cannot be selected as the audio channel for more than one input terminal.

Image Adjust Settings Menu

Adjusting the Position, Size, Fine Picture, Picture Adj

The position of the image can be adjusted and flickering of the image can be corrected.

Example: Adjusting the vertical position in the normal mode

On "V-POSITION" of "IMAGE ADJUST" menu, adjust the position.

The mode switches as follows each time the ◀ or ▶ button is pressed:

NORMAL ↔ **FULL**

* The mode can also be switched by pressing the WIDE button on the remote control.

* The settings on the IMAGE ADJUST menu are not preset at the factory.

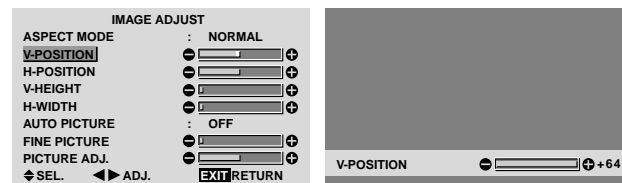

Information

■ When "AUTO PICTURE" is "OFF"

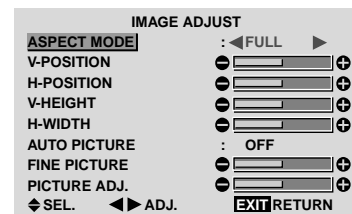

When Auto Picture is off, the Fine Picture and the Picture ADJ. items are displayed so that you can adjust them.

■ Adjusting the Auto Picture

ON: The Picture ADJ., Fine Picture and Position adjustments are made automatically.

Not available for digital ZOOM.

OFF: The Picture ADJ., Fine Picture and Position adjustments are made manually.

* If FINE PICTURE can't be adjusted, set Auto Picture to OFF and adjust manually.

■ Adjusting the position of the image

V-POSITION: Adjusts the vertical position of the image.

H-POSITION: Adjusts the horizontal position of the image.

V-HEIGHT: Adjusts the vertical size of the image. (Except for STADIUM mode)

H-WIDTH: Adjusts the horizontal size of the image. (Except for STADIUM mode)

FINE PICTURE*: Adjusts for flickering.

PICTURE ADJ.*: Adjusts for striped patterns on the image.

* The Picture ADJ. and Fine Picture features are available only when the "Auto Picture" is off.

* The AUTO PICTURE, FINE PICTURE and PICTURE ADJ. are available only for RGB signals.

But, these features are not available for moving pictures on VIDEO, HD/DVD or RGB.

Option 1 Settings Menu

Setting the on-screen menu

This sets the position of the menu, the display format (horizontal or vertical) etc.

Example: Turning the DISPLAY OSM off

On "OPTION1" menu, select "OSM", then press the MENU/ENTER button.

The "OSM" menu appears.

On "DISPLAY OSM" of "OSM" menu, select "OFF".

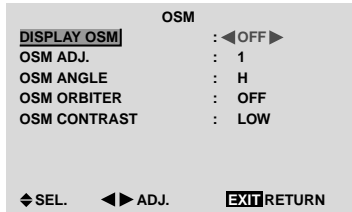

Information

■ DISPLAY OSM settings

ON: The on-screen menu appears.

OFF: The on-screen menu does not appear.

If you press the DISPLAY button on the remote control for more than 3 seconds the main menu will appear and can be set (although it is not ON).

■ OSM ADJUST settings

Adjusts the position of the menu when it appears on the screen.

The position can be set between 1 to 6.

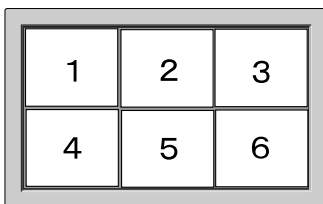

■ OSM ANGLE settings

Sets the display format (landscape "H" or portrait "V"). When the unit is installed vertically set the OSM ANGLE at "V".

"H"

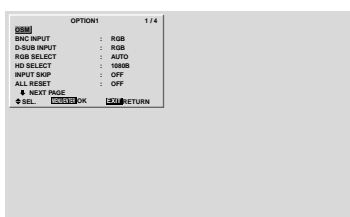

"V"

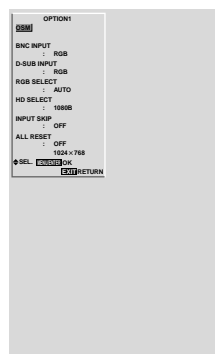

■ OSM ORBITER settings

ON: The position of the menu will be shifted by eight dots each time OSM is displayed.

OFF: OSM will be displayed at the same position.

■ OSM CONTRAST settings

NORMAL: OSM brightness is set to normal.

LOW: OSM brightness is set to lower.

Setting the BNC connectors

Select whether to set the input of the 5 BNC connectors to RGB, component or SCART1,2.

Example: Set the BNC INPUT mode to "COMP."

On "BNC INPUT" of "OPTION1" menu, select "COMP."

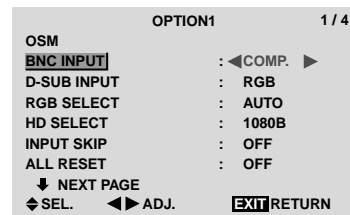

Information

■ BNC INPUT Settings

RGB: Use the 5BNC terminals for RGB input.

COMP.: Use the 3BNC terminals for component input.

SCART1: Use the 4BNC terminals for RGB with composite sync. See page E-8.

SCART2: Use the 3BNC terminals for RGB and the VIDEO1 terminal for composite sync. See page E-8.

Setting the RGB1 connector

Select one of the signals being transmitted to the RGB1 terminal.

Example: Set the D-SUB INPUT mode to "SCART3"

On "D-SUB INPUT" of "OPTION1" menu, select "SCART3".

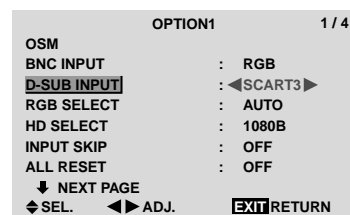

Information

■ D-SUB INPUT Settings

RGB: Use the D-SUB terminal for RGB input.

SCART3: Use the D-SUB terminal for RGB signal fed from SCART. See page E-8.

Setting a computer image to the correct RGB select screen

With the computer image, select the RGB Select mode for a moving image such as (video) mode, wide mode or digital broadcast.

Example: Setting the "RGB SELECT" mode to "MOTION"

On "RGB SELECT" of "OPTION1" menu, select "MOTION".

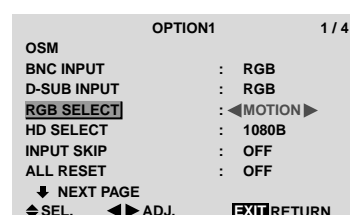

Information**■ RGB SELECT modes**

One of these 7 modes must be selected in order to display the following signals correctly.

AUTO: Select the suitable mode for the specifications of input signals as listed in the table “Computer input signals supported by this system” on page E-2 of Model Information.

STILL: To display VESA standard signals. (Use this mode for a still image from a computer.)

MOTION: The video signal (from a scan converter) will be converted to RGB signals to make the picture more easily viewable. (Use this mode for a motion image from a computer.)

WIDE1: When an 852 dot × 480 line signal with a horizontal frequency of 31.7kHz is input, the image may be compressed horizontally. To prevent this, set RGB SELECT to WIDE1.

WIDE2: When an 848 dot × 480 line signal with a horizontal frequency of 31.0 kHz is input, the image may be compressed horizontally. To prevent this, set RGB SELECT to WIDE2.

WIDE3: When an 1920 dot × 1200 line signal with a horizontal frequency of 74.0 kHz is input, the image may be compressed horizontally. To prevent this, set RGB SELECT to WIDE3.

DTV: Set this mode when watching digital broadcasting (480P).

See page E-2 of Model Information for the details of the above settings.

Setting high definition images to the suitable screen size

Use this procedure to set whether the number of vertical lines of the input high definition image is 1035 or 1080.

Example: Setting the “1080B” mode to “1035I”

On “HD SELECT” of “OPTION1” menu, select “1035I”.

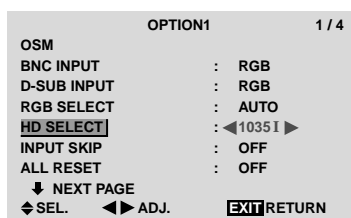
**Information****■ HD SELECT modes**

These 3 modes are not displayed in correct image automatically.

1080B: Standard digital broadcasts

1035I: Japanese “High Vision” signal format

1080A: Special Digital broadcasts (for example : DTC100)

Setting the Input Skip

When this is ON, signals which are not present will be skipped over and only pictures whose signals are being transmitted will be displayed.

This setting is valid only for the INPUT SELECT button on the unit.

Example: Set to “ON”

On “INPUT SKIP” of “OPTION1” menu, select “ON”.

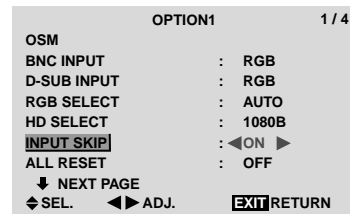
**Information****■ INPUT SKIP settings**

OFF: Regardless of the presence of the signal, scan and display all signals.

ON: If no input signal is present, skip that signal.

* “SETTING NOW” will appear during the input search.

Resetting to the default values

Use these operations to restore all the settings (PICTURE, AUDIO, IMAGE ADJUST, OPTION1~4, etc) to the factory default values.

Refer to page E-16 for items to be reset.

On “ALL RESET” of “OPTION1” menu, select “ON”, then press the MENU/ENTER button.

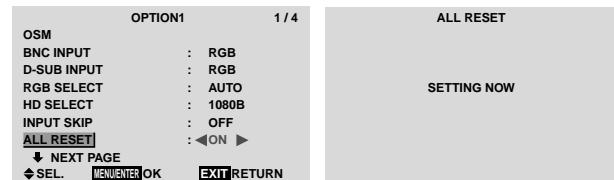

When the “SETTING NOW” screen disappears, then all the settings are restored to the default values.

Option2 Settings Menu

Setting the power management for computer images

This energy-saving (power management) function automatically reduces the monitor's power consumption if no operation is performed for a certain amount of time.

Example: Turning the power management function on
Set "ADVANCED OSM" to "ON" in the main menu (1/2), then perform the following operations.

On "PWR. MGT." of "OPTION2" menu, select "ON".

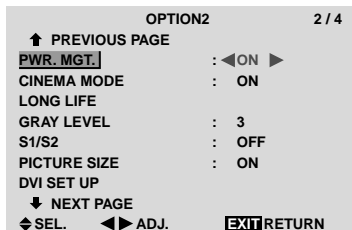

Information

■ Power management function

- * The power management function automatically reduces the monitor's power consumption if the computer's keyboard or mouse is not operated for a certain amount of time. This function can be used when using the monitor with a computer.
- * If the computer's power is not turned on or if the computer and selector tuner are not properly connected, the system is set to the off state.
- * For instructions on using the computer's power management function, refer to the computer's operating instructions.

■ Power management settings

ON: In this mode the power management function is turned on.

OFF: In this mode the power management function is turned off.

■ Power management function and POWER/STANDBY indicator

The POWER/STANDBY indicator indicates the status of the power management function. See below for indicator status and description.

POWER/STANDBY indicator

Power management mode	POWER/STANDBY indicator	Power management operating status	Description	Turning the picture back on
On	Green	Not activated.	Horizontal and vertical synchronizing signals are present from the computer.	Picture already on.
Off	Red	Activated.	Horizontal and/or vertical synchronizing signals are not sent from the computer.	Operate the keyboard or mouse. The picture reappears.

Setting the picture to suit the movie

The film image is automatically discriminated and projected in an image mode suited to the picture.

[NTSC, PAL, PAL60, 480I (60Hz), 525I (60Hz), 576I (50Hz), 625I (50Hz), 1035I (60Hz), 1080I (60Hz) only]

Example: Setting the "CINEMA MODE" to "OFF"

Set "ADVANCED OSM" to "ON" in the main menu (1/2), then perform the following operations.

On "CINEMA MODE" of "OPTION2" menu, select "OFF".

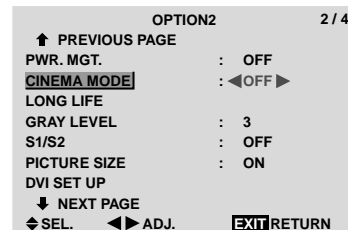

Information

■ CINEMA MODE

ON: Automatic discrimination of the image and projection in cinema mode.

OFF: Cinema mode does not function.

Reducing burn-in of the screen

The brightness of the screen, the position of the picture, positive/negative mode and screen wiper are adjusted to reduce burn-in of the screen.

Set "ADVANCED OSM" to "ON" in the main menu (1/2), then perform the following operations.

On "OPTION2" menu, select "LONG LIFE", then press the MENU/ENTER button.

The "LONG LIFE" screen appears.

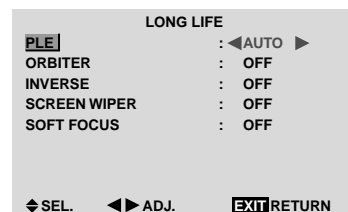

PLE (Peak Luminance Enhancement)

Use this to activate the brightness limiter.

Example: Setting "PLE" to "LOCK1"

On "PLE" of "LONG LIFE" menu, select "LOCK1".



Information

■ PLE settings

AUTO: The brightness of the screen is adjusted automatically to suit the picture quality.

LOCK1, 2, 3: Sets maximum brightness.

The brightness level decreases in the order of LOCK 1, 2, 3. LOCK 3 provides minimum brightness.

ORBITER

Use this to set the picture shift.

Example: Setting "ORBITER" to "AUTO1"

On "ORBITER" of "LONG LIFE" menu, select "AUTO1".

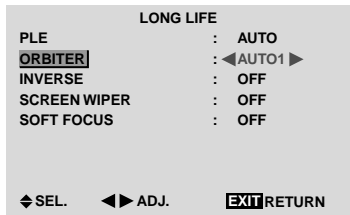
**Information****■ ORBITER settings**

OFF: Orbiter mode does not function.

This is the default setting when RGB is input.

AUTO1: The picture moves around the screen intermittently, making the picture smaller. This is the default setting when a Video or a DVD/HD/DTV signal is input. Set to "OFF" when these signals are not used.

AUTO2: The picture moves around the screen intermittently, making the picture bigger.

MANUAL: User can adjust the orbiter function (Horizontal Dot, Vertical Line and Time) manually.

See the following explanation.

* When a Video or a DVD/HD/DTV signal is input, the AUTO1 and 2 functions will affect only the moving picture and will not make the screen smaller or bigger.

Adjust the ORBITER function manually

Set the amount of shift and the time between movement.

Example: Setting so that the picture moves 2 dots horizontally and 3 lines vertically every 3 minutes.

On "ORBITER" of "LONG LIFE" menu, select "MANUAL", then press the MENU/ENTER button.

THE "ORBITER" screen appears.

Adjust the items.

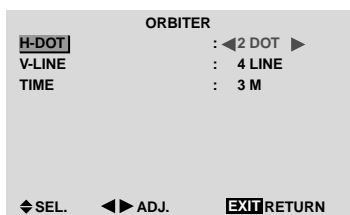
**Information****■ ORBITER Function settings**

H-DOT: Moves from 1 to 20 dots in the horizontal direction.

V-LINE: Moves from 1 to 20 lines in the vertical direction.

TIME: Interval of 1~5 minutes (1 horizontal dot or 1 vertical line per interval).

INVERSE

Use this to set the inverse mode or to display a white screen.

Example: Setting "INVERSE" to "WHITE"

On "INVERSE" of "LONG LIFE" menu, select "WHITE".

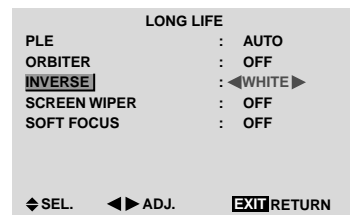
**Information****■ INVERSE Settings**

ON: The picture is displayed alternately between positive image and negative image.

You can set the time by pressing the MENU/ENTER button while "ON" is set.

OFF: Inverse mode does not function.

WHITE: The entire screen turns white.

You can set the time by pressing the MENU/ENTER button while "ON" is set.

Setting the time for INVERSE/WHITE

Set a time duration.

Example: Setting so that the INVERSE mode starts in 2 hours and proceeds for one hour and a half.

On "INVERSE" of "LONG LIFE" menu, select "ON", then press the MENU/ENTER button.

THE "INVERSE/WHITE" screen appears.

Adjust the times.

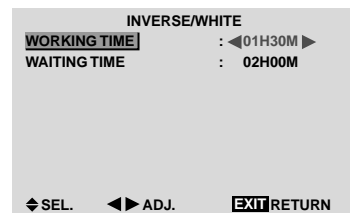
**Information****■ Setting the time**

WORKING TIME: Set the time duration for "INVERSE/WHITE".

When the WORKING TIME is set to "ON" the mode will stay on.

WAITING TIME: Set the standby time until the "INVERSE/WHITE" mode starts.

* The "WAITING TIME" can not be set when the "WORKING TIME" is ON.

* THE "WORKING TIME" and "WAITING TIME" can be set for up to 12 hours and 45 minutes in units of 3 minutes.

* Ending a WORKING TIME function, the monitor will be STAND BY.

[Example]

WORKING TIME: 01H30M

WAITING TIME: 02H00M

←----- 2 H -----*----- 1.5 H -----*-----
Start INVERSE/WHITE Start STAND BY

■ To select "ON" for the "WORKING TIME"...

Set the hours of the working time to 0H and the minutes to 0M. "ON" will be displayed.

SCREEN WIPER

When this is set to ON, a white vertical bar moves repeatedly from the left and of the screen to the right end at a constant speed.

Example: Setting "SCREEN WIPER" to "ON"

On "SCREEN WIPER" of "LONG LIFE" menu, select "ON".

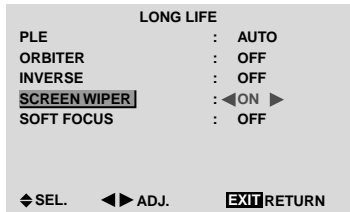

Information

■ SCREEN WIPER

ON: The white vertical bar appears.

You can set the time by pressing the MENU/ENTER button while "ON" is set.

OFF: Screen wiper mode does not function.

Setting the time for SCREEN WIPER

Set a time duration and the speed.

Example: Setting so that the SCREEN WIPER mode starts in 30 minutes and proceeds for one and a half hours.

On "SCREEN WIPER" of "LONG LIFE" menu, select "ON", then press the MENU/ENTER button.

THE "SCREEN WIPER" screen appears.

Adjust the times and speed.

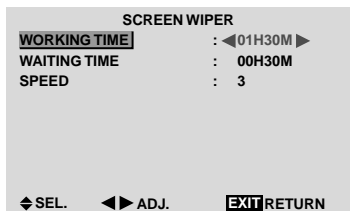

Information

■ Setting the time

WORKING TIME: Set the time duration for "SCREEN WIPER".

When the WORKING TIME is set to "ON" the mode will stay on.

WAITING TIME: Set the standby time until the "SCREEN WIPER" mode starts.

SPEED: Set the moving speed for the "SCREEN WIPER". The speed decreases as the number increases.

* The "WAITING TIME" can not be set when the "WORKING TIME" is ON.

* THE "WORKING TIME" and "WAITING TIME" can be set for up to 12 hours and 45 minutes in units of 3 minutes.

■ To select "ON" for the "WORKING TIME"...

Set the hours of the working time to 0H and the minutes to 0M. "ON" will be displayed.

SOFT FOCUS

Reduces edges and softens the image.

Example: Setting "SOFT FOCUS" to "2"

On "SOFT FOCUS" of "LONG LIFE" menu, select "2".

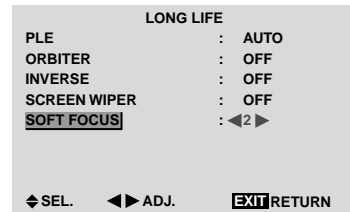

Information

■ SOFT FOCUS settings

OFF: Turns the SOFT FOCUS function off.

1, 2, 3, 4: Activates the SOFT FOCUS setting. The higher numbers create a softer image.

"SHARPNESS" can not be adjusted in the "PICTURE" menu.

Setting the gray level for the sides of the screen

Use this procedure to set the gray level for the parts on the screen on which nothing is displayed when the screen is set to the 4:3 size.

Example: Setting "GRAY LEVEL" to "5"

Set "ADVANCED OSM" to "ON" in the main menu (1/2), then perform the following operations.

On "GRAY LEVEL" of "OPTION2" menu, select "5".

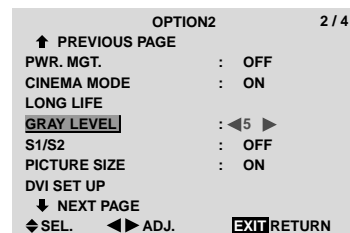

Information

■ GRAY LEVEL settings

This adjusts the brightness of the black (the gray level) for the sides of the screen.

The standard is 0 (black). The level can be adjusted from 0 to 15. The factory setting is 3 (dark gray).

Setting the screen size for S1/S2 video input

If the S-video signal contains screen size information, the image will be automatically adjusted to fit the screen when this S1/S2 is set to AUTO.

This feature is available only when an S-video signal is input via the VIDEO3 terminal.

Example: Setting the "S1/S2" to "AUTO"

Set "ADVANCED OSM" to "ON" in the main menu (1/2), then perform the following operations.

On "S1/S2" of "OPTION2" menu, select "AUTO".

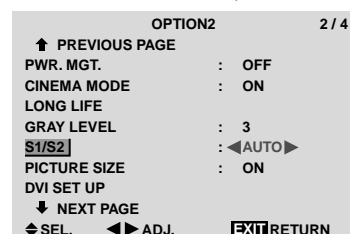

Information**■ S1/S2 settings**

AUTO: Adjusts the screen size automatically according to the S1/S2 video signal.

OFF: Turns the S1/S2 function off.

Setting the picture size for RGB input signals

Use this procedure to switch the setting to "ON" or "OFF".

Example: Setting the "PICTURE SIZE" mode to "OFF"

Set "ADVANCED OSM" to "ON" in the main menu (1/2), then perform the following operations.

On "PICTURE SIZE" of "OPTION2" menu, select "OFF".

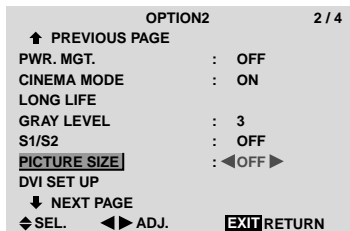
**Setting the signal and black level for DVI signal**

Choose the signal for the DVI connector (PC or STB/DVD) and set the black level.

Example: Setting the "PLUG/PLAY" mode to "STB/DVD"

Set "ADVANCED OSM" to "ON" in the main menu (1/2), then perform the following operations.

On "OPTION2" menu, select "DVI SET UP", then press the MENU/ENTER button.

The "DVI SET UP" screen appears.

On "PLUG/PLAY" of "DVI SET UP" menu, select "STB/DVD".

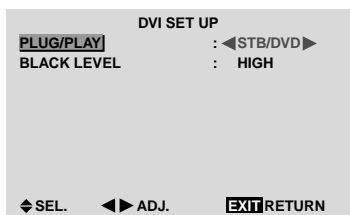
**Information****■ PLUG/PLAY settings**

PC: When connected to the PC signal.

BLACK LEVEL is set to "LOW" automatically.

STB/DVD: When connected to the SET TOP BOX, DVD etc.

BLACK LEVEL is set to "HIGH" automatically.

■ BLACK LEVEL settings

LOW: When connected to the PC signal.

HIGH: When connected to the SET TOP BOX, DVD etc. Change "HIGH" into "LOW" if the black level appears gray.

Option3 Settings Menu**Using the timer**

This function sets the monitor to turn ON/OFF automatically at a set time.

Set "ADVANCED OSM" to "ON" in the main menu (1/2), then perform the following operations.

On "OPTION3" menu, select "TIMER", then press the MENU/ENTER button.

The "TIMER" screen appears.

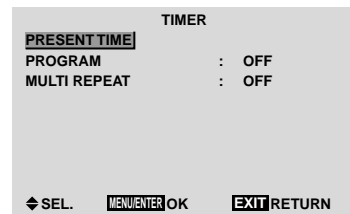
**PRESENT TIME**

This sets the day of the week and present time.

Example: Setting "WEDNESDAY", "22:05"

On "TIMER" menu, select "PRESENT TIME", then press the MENU/ENTER button.

The "PRESENT TIME" screen appears.

Adjust the items.



Select "SET", then press the MENU/ENTER button.

The adjustments are stored and return to the TIMER menu.

* If you press the EXIT button instead of the MENU/ENTER button, the settings can not be made.

**Information****■ PRESENT TIME settings**

SUMMER TIME: Use to set SUMMER TIME.

ON: The present time + 1 hour.

OFF: Cancelled

Day: Set the day of the week (e.g. Sunday).

Hour: Set the hour in the 24-hour format (range 00 to 23).

Minutes: Set the minutes (range 00 to 59).

PROGRAM TIMER

This sets the day and time at which the power will be switched ON/OFF as well as the input mode.

Example: Setting so that the power will be switched on at 8:30 A.M., Monday, displaying RGB2 source, and switched off at 10:30 A.M.

On "PROGRAM" of "TIMER" menu, select "ON", then press the MENU/ENTER button.

The "PROGRAM TIMER" screen appears.

Adjust the items.

Each mode switches each time the ZOOM +/- button is pressed.

DATE	ON	OFF	INPUT	FUNCTION
MON	08:30	10:30	RGB2	INVERSE
-	-:-:-	-:-:-	-	-
-	-:-:-	-:-:-	-	-
-	-:-:-	-:-:-	-	-
-	-:-:-	-:-:-	-	-
-	-:-:-	-:-:-	-	-
-	-:-:-	-:-:-	-	-
-	-:-:-	-:-:-	-	-
◀▶SEL. ZOOM ADJ. EXIT RETURN				

- Use the ▲ and ▼ buttons to select "MULTI MODE", then use the ◀ and ▶ buttons to choose from "SINGLE", "SIDE BY SIDE1~3" and "PICTURE IN PICTURE (BOTTOM LEFT~TOP LEFT)".
- Use the ▲ and ▼ buttons to select "MAIN"/"SUB" and "LEFT"/"RIGHT", then use the ◀ and ▶ buttons to choose from "VIDEO1~3", "HD/DVD1~2" and "RGB1~3".

DATE	ON	OFF	INPUT	FUNCTION
MON	08:30	10:30	MULTI	INVERSE
TUE	-:-:-	18:15	-	-
SAT	08:30	12:15	VIDEO1	WHITE
*FRI	08:30	10:00	HD/DVD1	-
-	-:-:-	-:-:-	-	-
SAT	08:30	12:15	VIDEO1	WHITE
*	15:30	16:00	RGB1	-
◀▶SEL. ZOOM ADJ. EXIT RETURN				

PICTURE IN PICTURE

PROGRAM TIMER	
MULTI SCREEN SETTING	
MULTI MODE	: BOTTOM LEFT
INPUT MODE	
MAIN	: RGB/PC1
SUB	: VIDEO1
◀▶SEL. ◀▶ADJ. EXIT RETURN	

SIDE BY SIDE

PROGRAM TIMER	
MULTI SCREEN SETTING	
MULTI MODE	: SIDE BY SIDE1
INPUT MODE	
LEFT	: RGB/PC1
RIGHT	: VIDEO1
◀▶SEL. ◀▶ADJ. EXIT RETURN	

Information

PROGRAM TIMER settings

- DATE: Set the day of the week (e.g. Sunday).
- ON (hour, minutes): Set the time at which the power will be turned on in the 24-hour format.
- OFF (hour, minutes): Set the time at which the power will be turned off in the 24-hour format.
- INPUT: Set the input mode that will be displayed when the timer is on.
- FUNCTION: Set the LONG LIFE function.

To reset the program

Align the cursor with the DATE field that you wish to reset, then press the CLEAR/SEAMLESS SW button.

To reset the data

Align the cursor with the field (ON/OFF/INPUT/FUNCTION) that you wish to reset, then press the CLEAR/SEAMLESS SW button.

Special characters in the PROGRAM TIMER screen

DATE	ON	OFF	INPUT	FUNCTION
MON	08:30	10:30	RGB2	INVERSE
TUE	-:-:-	18:15	-	-
SAT	08:30	12:15	VIDEO1	WHITE
*FRI	08:30	10:00	HD/DVD1	-
-	-:-:-	-:-:-	-	-
SAT	08:30	12:15	VIDEO1	WHITE
*	15:30	16:00	RGB1	-
◀▶SEL. ZOOM ADJ. EXIT RETURN				

- An asterisk "*" in the DATE field
An asterisk "*" means "every". For example, "*FRI" means every Friday and "*" means everyday.
- A hyphen "-" in the ON field or OFF field
If any hyphen remains in the ON field or OFF field, the FUNCTION can not be set.
- A hyphen "-" in the FUNCTION field
A hyphen "-" means last mode (the mode that was last selected at the time the power was switched off).

To set MULTI INPUT

- Set the INPUT button to "MULTI", then press the MENU/ENTER button.
The "MULTI SCREEN SETTING" will appear on the screen.

MULTI REPEAT

Two repeat timers are available. Each timer has MULTI MODE, WORK TIME and INPUT MODE functions.

Example:

TIMER1 is set to display RGB1 (MAIN) and VIDEO1 (SUB) for 4 hours in picture-in-picture mode. TIMER2 is set to display RGB3 (LEFT) and HD/DVD1 (RIGHT) for 2.5 hours in side-by-side mode.

On "MULTI REPEAT" of "TIMER", select "ON", then press the MENU/ENTER button.

The "MULTI REPEAT TIMER" screen appears.

Adjust the items.

TIMER	
PRESENT TIME	
PROGRAM	: OFF
MULTI REPEAT	: ◀OFF▶
◀▶SEL. ◀▶ADJ. EXIT RETURN	

MULTI REPEAT TIMER	
1 MULTI MODE	: ◀BTM LFT▶
WORK TIME	: 04H00M
INPUT MODE	
MAIN	: RGB/PC1
SUB	: VIDEO1
2 MULTI MODE	: S BY S1
WORK TIME	: 02H30M
INPUT MODE	
LEFT	: RGB/PC3
RIGHT	: HD/DVD1
◀▶SEL. ◀▶ADJ. EXIT RETURN	

Information

MULTI REPEAT settings

- MULTI MODE: Set the input mode to be displayed while the timer is on.
- WORK TIME: Set the time duration of the display. Time range is from 1 minutes to 4 hours and 15 minutes.
- INPUT MODE: Set the signal that will be displayed within the selected screen.
Select "MAIN" or "SUB" for "PICTURE IN PICTURE (BTM LFT~TOP LFT)" and "LEFT" or "RIGHT" for "S BY S1~3". Only one signal is selected for "SINGLE".
- * The two repeat timers run consecutively, i.e., Timer1-Timer2-Timer1-Timer2.
- * When both PROGRAM TIMER and MULTI REPEAT TIMER are set, priority is given to PROGRAM TIMER.

Setting the power on mode

This function sets the input mode at the time the power is switched on.

Example: Setting "VIDEO2"

Set "ADVANCED OSM" to "ON" in the main menu (1/2), then perform the following operations.

On "PWR. ON MODE" of "OPTION3" menu, select "VIDEO2".

The available sources depend on the settings of input.

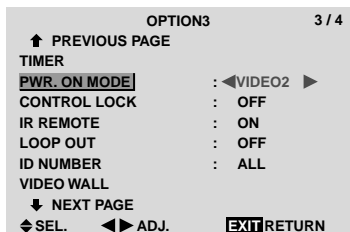

Information

■ PWR. ON MODE settings

LAST: Last mode (the input that was last selected at the time the power was switched off).

VIDEO1, 2, 3: VIDEO input mode.

RGB1, 2, 3: RGB input mode.

HD/DVD1, 2: HD/DVD input mode.

DVD2, 3: DVD input mode.

MULTI: Multi screen mode.

Follow the procedure used for PROGRAM TIMER. See page E-27.

Enabling/disabling the front panel controls

This function enables/disables the front panel controls.

Example: Setting "ON"

Set "ADVANCED OSM" to "ON" in the main menu (1/2), then perform the following operations.

On "CONTROL LOCK" of "OPTION3" menu, select "ON", then press the MENU/ENTER button.

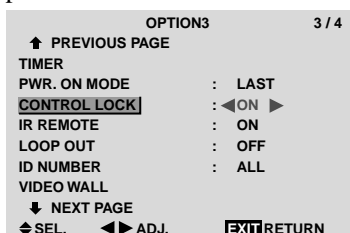

Information

■ CONTROL LOCK settings

ON: Disables the buttons on the front panel.

OFF: Enables the buttons on the front panel.

* Even when the CONTROL LOCK is set, the POWER switch will not be locked.

* This becomes effective when the on-screen menu goes out.

Enabling/disabling remote control wireless transmission

This function enables/disables remote control wireless transmission.

Example: Setting "OFF"

Set "ADVANCED OSM" to "ON" in the main menu (1/2), then perform the following operations.

On "IR REMOTE" of "OPTION3" menu, select "OFF", then press the MENU/ENTER button.

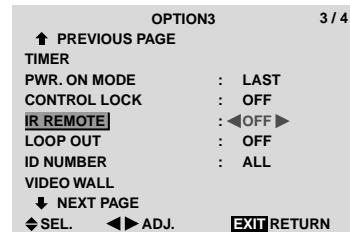

Information

■ IR REMOTE settings

ON: Enables remote control wireless transmission.

OFF: Disables remote control wireless transmission.

Set "OFF" to avoid unwanted control from other remote controls.

Loop Out setting

When this feature is set to ON, the received signal will be looped out.

Example: Setting "ON"

Set "ADVANCED OSM" to "ON" in the main menu (1/2), then perform the following operations.

On "LOOP OUT" of "OPTION3" menu, select "ON".

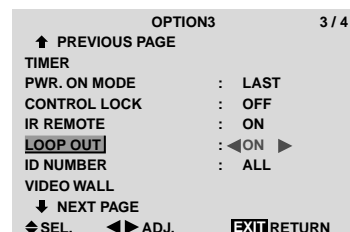

Information

■ LOOP OUT settings

ON: The received signal will be looped out via PC1 terminal or VIDEO1 terminal.

OFF: The received signal will not loop out.

* Even if LOOP OUT is ON, signals won't be sent out if POWER is being turned off.

■ To connect another display...

See page E-5.

■ If the RGB/PC1 signal is present at the time the power switched on...

The RGB/PC1 input will be displayed regardless of the setting of LOOP OUT.

ID number setting

When using more than one of these displays, this function sets ID numbers so that operation of the remote control does not cause multiple monitors to operate at the same time.

Example: Setting "2"

Set "ADVANCED OSM" to "ON" in the main menu (1/2), then perform the following operations.

On "ID NUMBER" of "OPTION3" menu, select "2".

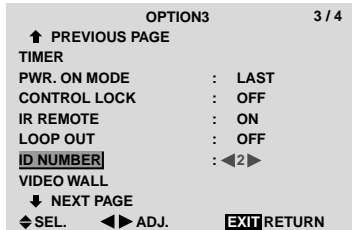

*** To reset back to ALL**

Press the CLEAR/SEAMLESS SW button

Information

■ ID NUMBER settings

ALL: ID NUMBER will not be set.

1 to 256: ID NUMBER will be set.

■ When the ID NUMBER have been set

You can also set ID NUMBER for each remote control to operate the plasma display individually. To do so, see the following explanation.

To set the ID number for the remote control

Example: Setting "2"

Press the ID SELECT button on the remote control.

The "ID SELECT" screen appears.

On "ID NUMBER" of "ID SELECT" menu, select "2".

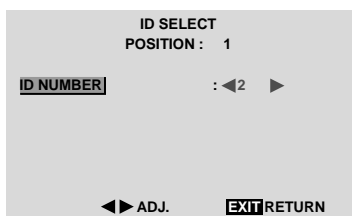

*** To reset back to ALL**

Press the CLEAR/SEAMLESS SW button

Video Wall setting

Use this feature to configure a 4-25 video wall.

Set "ADVANCED OSM" to "ON" in the main menu (1/2), then perform the following operations.

On "OPTION3" menu, select "VIDEO WALL", then press the MENU/ENTER button.

The "VIDEO WALL" screen appears.



DIVIDER

Set the 4-25 video wall.

Example: Setting "4"

On "DIVIDER" of "VIDEO WALL" menu, select "4".



Information

■ DIVIDER settings

OFF, 1: 1 Screen (Matrix display function does not work)

4: 4 Screens (2x2 video wall)

9: 9 Screens (3x3 video wall)

16: 16 Screens (4x4 video wall)

25: 25 Screens (5x5 video wall)

* When you select 4-25, set the VIDEO WALL POSITION.

VIDEO WALL POSITION

Set the position of each display.

Example: Setting "4"

On "VIDEO WALL" menu, select "POSITION", then press the MENU/ENTER button.

The "VIDEO WALL POSITION" screen appears.

Select "NO. 4" of "POSITION NO."

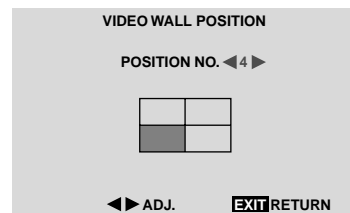

Information

■ VIDEO WALL POSITION settings

1 Screen: There is no need to set POSITION.

4 Screens

NO. 1	NO. 2
NO. 4	NO. 3

9 Screens

NO. 7	NO. 8	NO. 9
NO. 10	NO. 11	NO. 12
NO. 13	NO. 14	NO. 15

16 Screens

NO. 16	NO. 17	NO. 18	NO. 19
NO. 20	NO. 21	NO. 22	NO. 23
NO. 24	NO. 25	NO. 26	NO. 27
NO. 28	NO. 29	NO. 30	NO. 31

25 Screens

NO. 32	NO. 33	NO. 34	NO. 35	NO. 36
NO. 37	NO. 38	NO. 39	NO. 40	NO. 41
NO. 42	NO. 43	NO. 44	NO. 45	NO. 46
NO. 47	NO. 48	NO. 49	NO. 50	NO. 51
NO. 52	NO. 53	NO. 54	NO. 55	NO. 56

Note: A contingency method of shutting off the electric power should be used in cases of emergency during video wall setup.

DISP. MODE

Select the screen mode from between two options (Splitting, Blanking).

Example: Setting "BLANK"

On "DISP. MODE" of "VIDEO WALL" menu, select "BLANK".

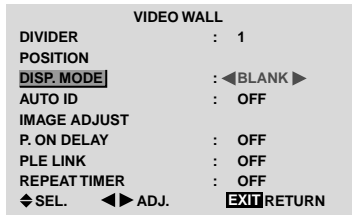

Information

■ DISP. MODE settings

SPLIT: Combines enlarged screens and creates multiple screens.

BLANK: Corrects misalignment of combined screen portions and creates multiple screens

AUTO ID

This feature automatically sets the ID numbers of multiple displays connected to each other.

Example: Setting "ON"

Set the ID number for the No. 1 display on ID NUMBER menu.

On "AUTO ID" of "VIDEO WALL" menu, select "ON", then press the MENU/ENTER button.

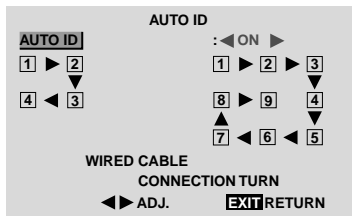

Information

■ AUTO ID settings

ON: Enables Auto ID function. In the case shown below, display 1 will be set as ID 1, display 2 as ID2, etc. This can be set only when a 2x2 or 3x3 video wall is selected.

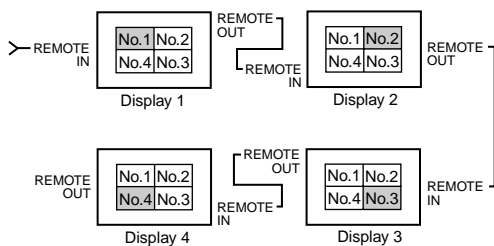

OFF: Disables Auto ID function.

IMAGE ADJUST

The position of the image can be adjusted and flickering of the image can be corrected.

Example: Adjusting the vertical position

On "VIDEO WALL" menu, select "IMAGE ADJUST", then press the MENU/ENTER button.

The "IMAGE ADJUST" screen appears.

On "V-POSITION" of "IMAGE ADJUST" menu, adjust the position.

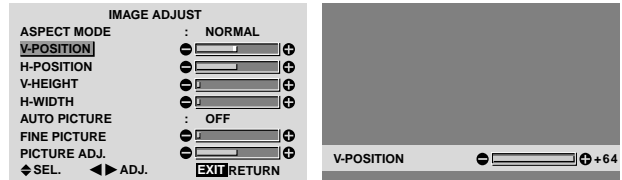

Information

■ IMAGE ADJUST settings

These are the same functions as the IMAGE ADJUST menu on page E-20.

P. ON DELAY (Power on delay)

Use this function to activate power-on delay.

Turn on the AUTO ID before the following operations.

Example: Setting "ON"

On "P. ON DELAY" of "VIDEO WALL" menu, select "ON".



Information

■ P. ON DELAY settings

ON: Turns on the main power of each display after a delay time.

OFF: Turns on the main power of all displays at the same time.

(Only for 16 and 25 screens)

MODE1: Turns on the main power of each display delayed.

MODE2: Turns on the main power of each display more delayed.

* Once this function has been set to "ON", POWER ON/OFF button on the remote control does not function except for the No.1 monitor.

By pressing the POWER ON button on the remote control the No.1 monitor will turn on and the others will be turned on one by one automatically.

* From the second monitor onward, neither the POWER button on the unit nor the POWER ON button on the remote control works. However, by pressing and holding the POWER ON button for more than 3 seconds, the monitor will be turned on.

PLE LINK

Use this function to set a uniform brightness for each display.

Turn on the AUTO ID and set the DIVIDER (at 1, 4 or 9) before the following operations.

Example: Setting "ON"

On "PLE LINK" of "VIDEO WALL" menu, select "ON", then press the MENU/ENTER button.

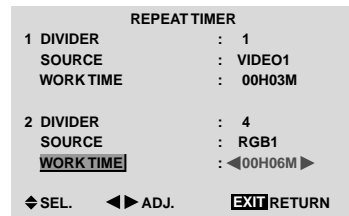
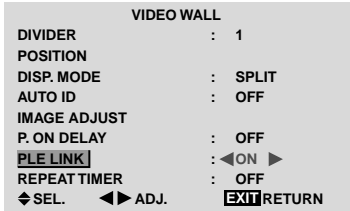

Information

■ PLE LINK settings

ON: Sets a uniform brightness for each screen in a video wall. This can be set only when a 2x2 or 3x3 video wall is selected.

OFF: Sets the individual screen brightness for each screen in a video wall.

* When this function is set "ON", connect your plasma displays with the remote cable (optional) in the order of the position numbers for the 2x2 video wall. See the drawing below.

* If there are changes in the DIVIDER or POSITION, the PLE LINK will automatically turn OFF.

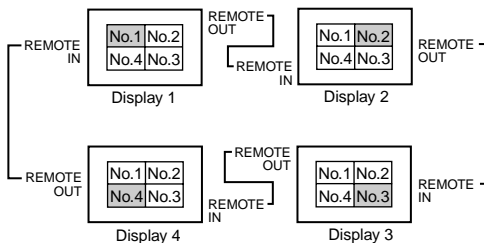

* With the 3x3 video wall, connect the final display to the first display the same way as with 2x2 video wall.

Note: The remote control can be operated unless the IR REMOTE is set to "OFF".

Information

■ REPEAT TIMER settings

DIVIDER: Divide the screen into 1, 4 or 9 sections.

SOURCE: Set the input mode to be displayed.

WORK TIME: Can be set to up to 4 hours 15 minutes in units of 1 minute.

If you set both timers, Timer 1 and Timer 2 run consecutively.

In the case of the Video wall, timer No.1 can be used to control all the displays simultaneously.

* This becomes effective when the on-screen menu goes out.

REPEAT TIMER

Use this to set two timers. Each timer can use the DIVIDER, SOURCE and WORK TIME.

Turn on the AUTO ID and set the DIVIDER (at 1, 4 or 9) before the following operations.

Example:

TIMER1...VIDEO1 will be displayed for 3 minutes.

TIMER2...RGB1 will be displayed for 6 minutes in a 2x2 video wall.

On "REPEAT TIMER" of "VIDEO WALL" menu, select "ON", then press the MENU/ENTER button.

The "REPEAT TIMER" screen appears.

Adjust the items.

Option4 Settings Menu

Erasing the sub screen image when there is no input signal

This function automatically erases the black frame of the sub screen when there is no sub screen input signal. This feature is available only when the picture-in-picture mode is selected.

Example: Set to "OFF"

Set "ADVANCED OSM" to "ON" in the main menu (1/2), then perform the following operations.

On "SUB. P DETECT" of "OPTION4" menu, select "OFF".

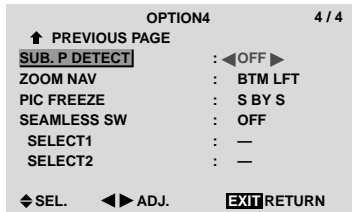

Information

■ SUB. P DETECT Function

- * The sub screen disappears when the input signal is lost.
- * Loss of the input signal means a condition in which the video signal and the sync signal are not present.
- * Under conditions in which the sub screen has disappeared, the ZOOM NAV, PIC FREEZE, and SEAMLESS SW functions will not work. The WIDE button will not function either.

■ SUB. P DETECT settings

AUTO: The black frame disappears 3 seconds after the input signal is lost.

OFF: Turns off the SUB. P DETECT function.

Displaying the entire image during DIGITAL ZOOM operations

Use this function to display the entire image within the sub screen together with an enlarged image on the main screen.

Example: Setting "ZOOM NAV" to "S BY S"

Set "ADVANCED OSM" to "ON" in the main menu (1/2), then perform the following operations.

On "ZOOM NAV" of "OPTION4" menu, select "S BY S".

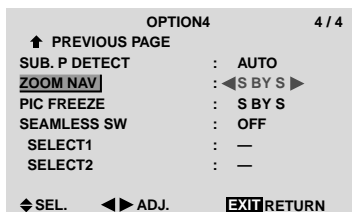

Information

■ ZOOM NAV Function

- * This feature is available only for RGB1 or RGB2 input signals.
- * This feature does not function during split screen mode.
- * This feature does not function while PIC FREEZE is operating.
- * Providing a 2-screen display will cancel this function.

■ ZOOM NAV settings

- OFF: Will not show the entire image on the sub screen.
- S BY S: Will show the entire image on the sub screen of side-by-side mode.
- BTM LFT~TOP LFT: Will show the entire image on the sub screen of picture-in-picture mode.

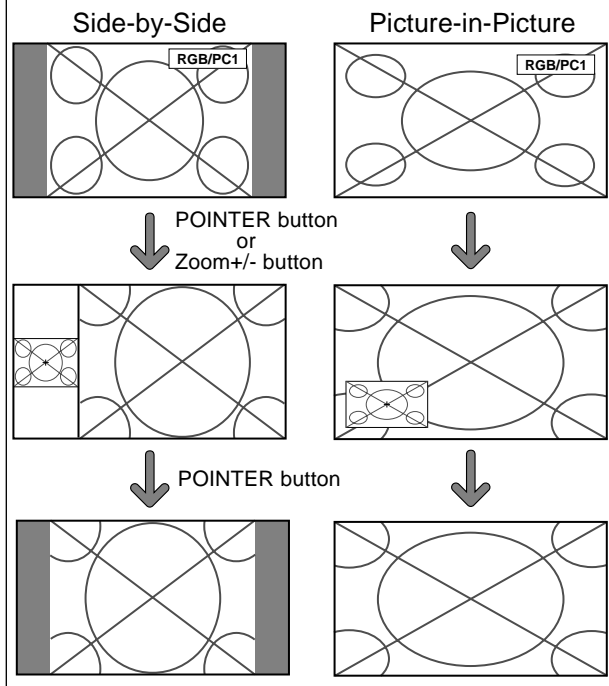

Displaying still images in the sub screen

This feature enables display in the sub screen of still images captured by pressing the SELECT/FREEZE button.

Example: Setting "PIC FREEZE" to "BTM LFT"

Set "ADVANCED OSM" to "ON" in the main menu (1/2), then perform the following operations.

On "PIC FREEZE" of "OPTION4" menu, select "BTM LFT".

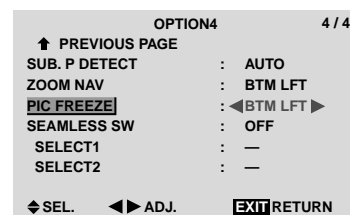

Information

■ PIC FREEZE Function

- * This feature is available only for RGB1 or RGB2 input signals.
- * This feature does not function during split screen mode.
- * Digital zoom is not available while this function is operating.
- * A further press of the SELECT/FREEZE button while this function is operating will cancel this function.
- * Providing a 2-screen display will cancel this function.

■ PIC FREEZE settings

OFF: Will not show the still image.

S BY S1, 2: The still images captured by pressing the SELECT/FREEZE button will be shown on the sub screen of side-by-side mode.

BTM LFT~TOP LFT: The still images captured by pressing the SELECT/FREEZE button will be shown on the sub screen of picture-in-picture mode.

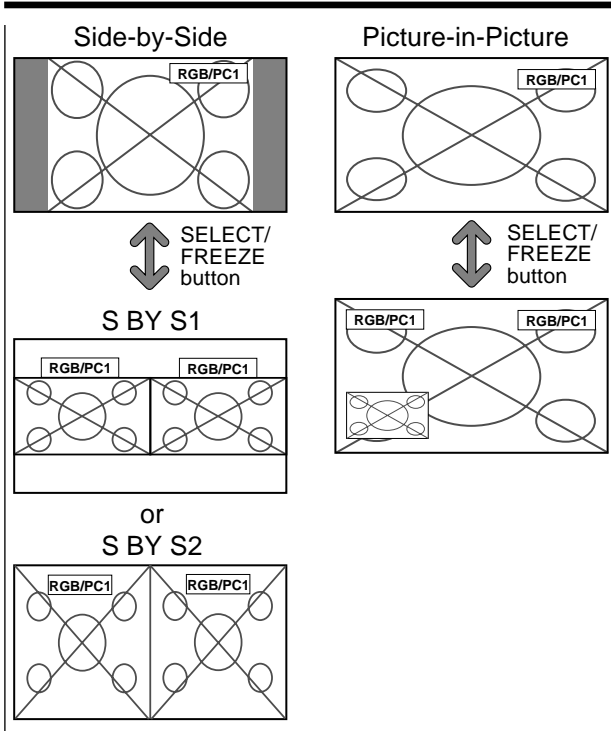

Switching the input source quickly

This feature enables quick input selection. After setting ON, press the CLEAR/SEAMLESS SW button for quick switching between the two selected input signals.

Example: Set to switch quickly between RGB1 and RGB2.

Set "ADVANCED OSM" to "ON" in the main menu (1/2), then perform the following operations.

On "SEAMLESS SW" of "OPTION4" menu, select "ON". Select "RGB1" and "RGB2".

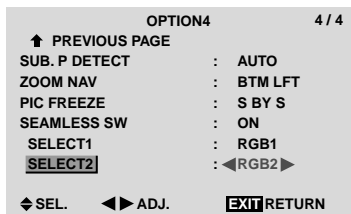

* The available sources depend on the settings of input.

Information

■ SEAMLESS SW Function

- * This feature will not function for certain input combinations. See the table on page E-13.
- * After switching to the selected input, please operate this function.
- * This feature will not function during split screen mode.
- * When SEAMLESS SW is first turned on, or when signals being transmitted are changed, there may be a slight delay due to signal analysis.

■ SEAMLESS SW settings

OFF: Turns off the SEAMLESS SW function.
 ON: When the CLEAR/SEAMLESS SW button is pressed, input signals will switch quickly according to the setting of SELECT1 and SELECT2.

Advanced OSM Settings Menu

Setting the menu mode

This allows you to access full menu items. When P. ON DELAY or PLE LINK is ON, this won't be turned OFF.

Example: Setting "ON"

On "ADVANCED OSM" of "MAIN MENU", select "ON".

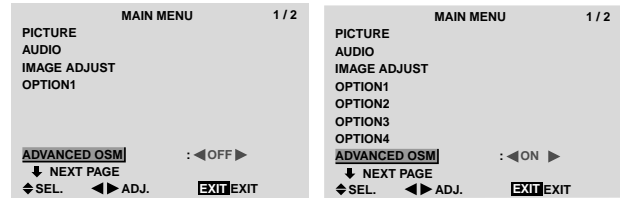

Information

■ ADVANCED OSM settings

ON: All of the main menu items are available for advanced users.
 OFF: Some of the main menu items are not available (e.g. OPTION2, OPTION3 and OPTION4).

Language Settings Menu

Setting the language for the menus

The menu display can be set to one of eight languages.

Example: Setting the menu display to "DEUTSCH"

On "MAIN MENU", select "LANGUAGE", then press the MENU/ENTER button.

The "LANGUAGE" screen appears.

On "LANGUAGE", select "DEUTSCH", then press the MENU/ENTER button.



The "LANGUAGE" is set to "DEUTSCH" and return to the main menu.

Information

■ Language settings

ENGLISH	English	ITALIANO	Italian
DEUTSCH	German	SVENSKA	Swedish
FRANÇAIS	French	中文	Chinese
ESPAÑOL	Spanish	РУССКИЙ	Russian

Color System Settings Menu

Setting the video signal format

Use these operations to set the color systems of composite video signals or Y/C input signals.

Example: Setting the color system to "3.58 NTSC"

On the MAIN MENU, select "COLOR SYSTEM", then press the MENU/ENTER button.

The "COLOR SYSTEM" screen appears.

On "COLOR SYSTEM", select "3.58NTSC".

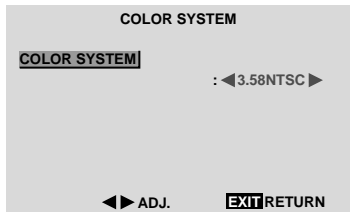

Information

■ Video signal formats

Different countries use different formats for video signals. Set to the color system used in your current country.

AUTO: The color systems are automatically identified and the format is set accordingly.

PAL: This is the standard format used mainly in the United Kingdom and Germany.

SECAM: This is the standard format used mainly in France and Russia.

4.43 NTSC, PAL60: This format is used for videos in countries using PAL and SECAM video signals.

3.58 NTSC: This is the standard format used mainly in the United States and Japan.

PAL-M: This is the standard format used mainly in Brazil.

PAL-N: This is the standard format used mainly in Argentina.

Source Information Menu

Checking the frequencies, polarities of input signals, and resolution

Use this function to check the frequencies and polarities of the signals currently being input from a computer, etc.

On "MAIN MENU", select "SOURCE INFORMATION", then press the MENU/ENTER button.

The "SOURCE INFORMATION" is displayed.

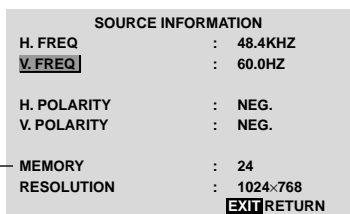

PC: MEMORY will be displayed.

Others: MODE will be displayed.

External Control Pin Assignments

Application

These specifications cover the communications control of the plasma monitor by external equipment.

Connections

Connections are made as described below.

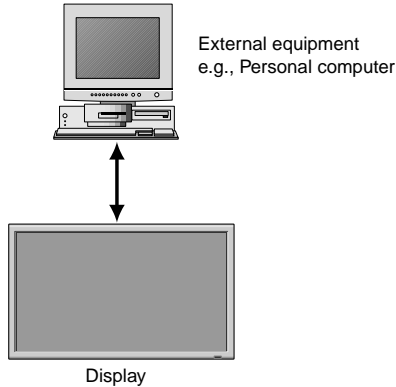

Connector on the plasma monitor side: EXTERNAL CONTROL connector.

Use a crossed (reverse) cable.

Type of connector: D-Sub 9-pin male

Pin No.	Pin Name	Pin No.	Pin Name
1	No Connection	6	DSR (DCE side ready)
2	RXD (Receive data)	7	RTS (Ready to send)
3	TXD (Transmit data)	8	CTS (Clear to send)
4	DTR (DTE side ready)	9	No connection
5	GND		

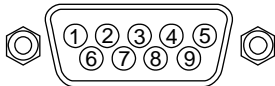

Communication Parameters

- | | |
|--------------------------|--------------|
| (1) Communication system | Asynchronous |
| (2) Interface | RS-232C |
| (3) Baud rate | 9600 bps |
| (4) Data length | 8 bits |
| (5) Parity | Odd |
| (6) Stop bit | 1 bit |
| (7) Communication code | Hex |

External Control Codes (Reference)

FUNCTION		CODE DATA							
Power ON		9FH	80H	60H	4EH	00H	CDH		
OFF		9FH	80H	60H	4FH	00H	CEH		
Input Switch	Video1 (BNC)	DFH	80H	60H	47H	01H	01H	08H	
	Video2 (RCA)	DFH	80H	60H	47H	01H	02H	09H	
	Video3 (S-Video)	DFH	80H	60H	47H	01H	03H	0AH	
	DVD1/HD1 (RCA)	DFH	80H	60H	47H	01H	05H	0CH	
	DVD2/HD2 (BNC)	DFH	80H	60H	47H	01H	06H	0DH	
	RGB1 (mini D-Sub 15-Pin)	DFH	80H	60H	47H	01H	07H	0EH	
	RGB2 (5BNC)	DFH	80H	60H	47H	01H	08H	0FH	
RGB3 (DVI)	DFH	80H	60H	47H	01H	0CH	13H		
Audio Mute	ON	9FH	80H	60H	3EH	00H	BDH		
	OFF	9FH	80H	60H	3FH	00H	BEH		
Picture Mode	NORMAL	DFH	80H	60H	0AH	01H	01H	CBH	
	THEAT. 1	DFH	80H	60H	0AH	01H	02H	CCH	
	THEAT. 2	DFH	80H	60H	0AH	01H	03H	CDH	
	DEFAULT	DFH	80H	60H	0AH	01H	04H	CEH	
	BRIGHT	DFH	80H	60H	0AH	01H	05H	CFH	
Screen Mode	STADIUM	DFH	80H	60H	51H	01H	02H	13H	
	ZOOM	DFH	80H	60H	51H	01H	03H	14H	
	NORMAL	DFH	80H	60H	51H	01H	04H	15H	
	FULL	DFH	80H	60H	51H	01H	05H	16H	
	14 : 9	DFH	80H	60H	51H	01H	09H	1AH	
	2.35 : 1	DFH	80H	60H	51H	01H	0AH	1BH	
Auto Picture	ON	DFH	80H	60H	7FH	03H	03H	09H	00H 4DH
	OFF	DFH	80H	60H	7FH	03H	03H	09H	01H 4EH
Cinema Mode	ON	DFH	80H	60H	C1H	01H	01H	82H	
	OFF	DFH	80H	60H	C1H	01H	02H	83H	

Note: Contact your local dealer for a full list of the External Control Codes if needed.

mini D-Sub 15-pin connector (Analog)

RGB 1

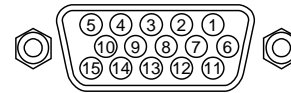

Pin No.	Signal (Analog)
1	Red
2	Green or sync-on-green
3	Blue
4	No connection
5	Ground
6	Red ground
7	Green ground
8	Blue ground
9	No connection
10	Sync signal ground
11	No connection
12	Bi-directional DATA (SDA)
13	Horizontal sync or Composite sync
14	Vertical sync
15	Data clock

DVI-D 24-pin connector (Digital)

The unit is equipped with a type of connector commonly used for digital.

(This cannot be used for an analog input.)

(TMDS can be used for one link only.)

RGB 3

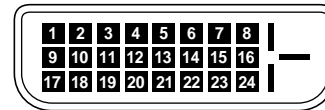

Pin No.	Signal (Digital)
1	T.M.D.S Data 2 -
2	T.M.D.S Data 2 +
3	T.M.D.S Data 2 Shield
4	No connection
5	No connection
6	DDC Clock
7	DDC Data
8	No connection
9	T.M.D.S Data 1 -
10	T.M.D.S Data 1 +
11	T.M.D.S Data 1 Shield
12	No connection
13	No connection
14	+5V Power
15	Ground
16	Hot Plug Detect
17	T.M.D.S Data 0 -
18	T.M.D.S Data 0 +
19	T.M.D.S Data 0 Shield
20	No connection
21	No connection
22	T.M.D.S Clock Shield
23	T.M.D.S Clock +
24	T.M.D.S Clock -

Troubleshooting

If the picture quality is poor or there is some other problem, check the adjustments, operations, etc., before requesting service.

Symptom	Checks	Remedy
Mechanical sound is heard.	<ul style="list-style-type: none"> • Maybe the sound from the cooling fans used to prevent over heating. 	
The unit emits a crackling sound.	<ul style="list-style-type: none"> • Are the image and sound normal? 	<ul style="list-style-type: none"> • If there are no abnormalities in the image and sound, the noise is caused by the cabinet reacting to changes in temperature. This will not affect performance.
Picture is disturbed. Sound is noisy. Remote control operates erroneously.	<ul style="list-style-type: none"> • Is a connected component set directly in front or at the side of the display? 	<ul style="list-style-type: none"> • Leave some space between the display and the connected components.
The remote control does not work.	<ul style="list-style-type: none"> • Are the remote control's batteries worn out? • Is IR REMOTE set to ON? • Has an ID number been set for the main unit? 	<ul style="list-style-type: none"> • Replace both batteries with new ones. • Set IR REMOTE OFF on OPTION3 menu. • Set an ID number with the ID SELECT button, or set the ID number to ALL.
Monitor's power does not turn on when the remote control's power button is pressed.	<ul style="list-style-type: none"> • Is the monitor's power cord plugged into a power outlet? • Are all the monitor's indicators off? • Are the remote control's batteries worn out? • Is IR REMOTE set to OFF? • Has an ID number been set for the main unit? 	<ul style="list-style-type: none"> • Plug the monitor's power cord into a power outlet. • Press the power button on the monitor to turn on the power. • Replace both batteries with new ones. • Set IR REMOTE ON. • Set an ID number with the ID SELECT button, or set the ID number to ALL.
Monitor does not operate when the remote control's buttons are pressed.	<ul style="list-style-type: none"> • Is the remote control pointed at the monitor, or is there an obstacle between the remote control and the monitor? • Is direct sunlight or strong artificial light shining on the monitor's remote control sensor? • Are the remote control's batteries worn out? • The remote cable is plugged into the REMOTE IN terminal (Wired). 	<ul style="list-style-type: none"> • Point the remote control at the monitor's remote control sensor when pressing buttons, or remove the obstacle. • Eliminate the light by closing curtains, pointing the light in a different direction, etc. • Replace both batteries with new ones. • Unplug the remote cable from the monitor.
The front panel buttons of the main unit do not function.	<ul style="list-style-type: none"> • The front panel buttons do not function during Control Lock. 	<ul style="list-style-type: none"> • Set the Control Lock to OFF.
No sound or picture is produced.	<ul style="list-style-type: none"> • Is the monitor's power cord plugged into a power outlet? 	<ul style="list-style-type: none"> • Plug the monitor's power cord into a power outlet.
Picture appears but no sound is produced.	<ul style="list-style-type: none"> • Is the volume set at the minimum? • Is the mute mode set? • Are the speakers properly connected? • Is AUDIO INPUT set correctly? 	<ul style="list-style-type: none"> • Increase the volume. • Press the remote control's MUTE button. • Connect the speakers properly. • Set AUDIO INPUT on the AUDIO menu correctly.
Poor picture with VIDEO signal input.	<ul style="list-style-type: none"> • Improper control setting. • Local interference. • Cable interconnections. • Input impedance is not correct level. 	<ul style="list-style-type: none"> • Adjust picture control as needed. • Try another location for the monitor. • Be sure all connections are secure.
Poor picture with RGB signal input.	<ul style="list-style-type: none"> • Improper control setting. • Incorrect 15 PIN connector pin connections. 	<ul style="list-style-type: none"> • Adjust picture controls as needed. • Check pin assignments and connections.
Tint is poor or colors are weak.	<ul style="list-style-type: none"> • Are the tint and colors properly adjusted? 	<ul style="list-style-type: none"> • Adjust the tint and color (under PICTURE).
Nothing appears on screen.	<ul style="list-style-type: none"> • Is the computer's power turned on? • Is a source connected? • Is the power management function in the standby or off mode? • Is LOOP OUT set to ON? 	<ul style="list-style-type: none"> • Turn on the computer's power. • Connect source to the monitor. • Operate the computer (move the mouse, etc.). • Set LOOP OUT OFF.
Part of picture is cut off or picture is not centered.	<ul style="list-style-type: none"> • Is the position adjustment appropriate? 	<ul style="list-style-type: none"> • Adjust the IMAGE ADJUST properly.
Image is too large or too small.	<ul style="list-style-type: none"> • Is the screen size adjustment appropriate? 	<ul style="list-style-type: none"> • Press the WIDE button on the remote control and adjust properly.
Picture is unstable.	<ul style="list-style-type: none"> • Is the computer's resolution setting appropriate? 	<ul style="list-style-type: none"> • Set to the proper resolution.
POWER/STANDBY indicator is lighted in red.	<ul style="list-style-type: none"> • Horizontal and / or vertical sync signal is not present when the Intelligent Power Manager control is on. 	<ul style="list-style-type: none"> • Check the input signal.
POWER/STANDBY indicator is blinking in red.	<ul style="list-style-type: none"> • The temperature inside the main unit has become too high and has activated the protector. 	<ul style="list-style-type: none"> • Promptly switch off the power of the main unit and wait until the internal temperature drops. See*1.
POWER/STANDBY indicator is blinking in green and red, or green.		<ul style="list-style-type: none"> • Promptly switch off the power of the main unit. See *2.

*1 Overheat protector

If the monitor becomes too hot, the overheat protector will be activated and the monitor will be turned off. If this happens, turn off the power to the monitor and unplug the power cord. If the room where the monitor is installed is particularly hot, move the monitor to a cooler location and wait for the monitor to cool for 60 minutes. If the problem persists, contact your dealer.

*2 In the following case, power off the monitor immediately and contact your dealer or authorized Service Center.

The monitor turns off 5 seconds after powering on and then the POWER/STANDBY indicator blinks. It indicates that the power supply circuit, plasma display panel, temperature sensor, or one or more fans have been damaged.

Free Manuals Download Website

<http://myh66.com>

<http://usermanuals.us>

<http://www.somanuals.com>

<http://www.4manuals.cc>

<http://www.manual-lib.com>

<http://www.404manual.com>

<http://www.luxmanual.com>

<http://aubethermostatmanual.com>

Golf course search by state

<http://golfingnear.com>

Email search by domain

<http://emailbydomain.com>

Auto manuals search

<http://auto.somanuals.com>

TV manuals search

<http://tv.somanuals.com>