

NEC



MultiSync® XP29 Plus / XM29 Plus

MultiSync® XP29 Plus / XM29 Plus

MultiSync®

Multimedia Monitor
User's Manual

NEC

	CAUTION	
	RISK OF ELECTRIC SHOCK DO NOT OPEN	

CAUTION: TO REDUCE THE RISK OF ELECTRIC SHOCK, DO NOT REMOVE COVER. NO USER-SERVICEABLE PARTS INSIDE. REFER SERVICING TO QUALIFIED SERVICE PERSONNEL.

 This symbol warns the user that uninsulated voltage within the unit may have sufficient magnitude to cause electric shock. Therefore, it is dangerous to make any kind of contact with any part inside of this unit.

 This symbol alerts the user that important literature concerning the operation and maintenance of this unit has been included. Therefore, it should be read carefully in order to avoid any problems.

WARNING

TO PREVENT FIRE OR SHOCK HAZARDS, DO NOT EXPOSE THIS UNIT TO RAIN OR MOISTURE. ALSO DO NOT USE THIS UNIT'S POLARIZED PLUG WITH AN EXTENSION CORD RECEPTACLE OR OTHER OUTLETS, UNLESS THE PRONGS CAN BE FULLY INSERTED. REFRAIN FROM OPENING THE CABINET AS THERE ARE HIGH-VOLTAGE COMPONENTS INSIDE. REFER SERVICING TO QUALIFIED SERVICE PERSONNEL.

Warnings and Safety Precaution

The NEC MultiSync Multimedia monitors XP29 Plus and XM29 Plus are designed and manufactured to provide long, trouble-free service. No maintenance other than cleaning is required. Use a soft cloth and if necessary, mild detergent. Do not use commercial spray cleaners which may damage the surface. In case of damage, arrange for repairs at an authorized NEC Service Center.

For operating safety and to avoid damage to the unit, read carefully and observe the following instructions.

To avoid shock and fire hazards:

1. Provide adequate space for ventilation to avoid internal heat build-up. Do not cover rear vents or install in a closed cabinet or shelves. The unit is equipped with cooling fans on the top. If you enclose the unit in a cabinet or rack, be sure there is adequate space at the top of the unit to allow heated air to rise and escape. A cabinet or shelves in which the unit is placed must be maintained below 40°C
2. Do not use the power cord polarized plug with extension cords or outlets unless the prongs can be completely inserted.
3. Do not expose unit to rain or moisture.
4. Avoid damage to the power cord, and do not attempt to modify the power cord.
5. Unplug unit during electrical storms or if unit will not be used over a long period.

DOC compliance Notice

This Class A digital apparatus meets all requirements of the Canadian Interference-Causing Equipment Regulations.

WARNING

This equipment has been tested and found to comply with the limits for a Class A digital device, pursuant to Part 15 of the FCC Rules. These limits are designed to provide reasonable protection against harmful interference when the equipment is operated in a commercial environment. This equipment generates, uses, and can radiate radio frequency energy and, if not installed and used in accordance with the instruction manual, may cause harmful interference to radio communications. Operation of this equipment in a residential area is likely to cause harmful interference in which case the user will be required to correct the interference at his own expense.

6. Do not open the cabinet which has potentially dangerous high voltage components inside. If the unit is damaged in this way the warranty will be void. Moreover, there is a serious risk of electric shock.
7. Do not attempt to service or repair the unit. NEC is not liable for any bodily harm or damage caused if unqualified persons attempt service or open the back cover. Refer all service to authorized NEC Service Centers.

To avoid damage and prolong operating life:

1. Use only with 100-120V/220-240V 50/60Hz AC power supply. Continued operation at line voltages other than 100-120V/220-240 Volts AC will shorten the life of the unit, and might even cause a fire hazard.
2. Handle the unit carefully when moving and do not drop.
3. Locate set away from heat, excessive dust, and direct sunlight.
4. Protect the inside of the unit from liquids and small metal objects. In case of accident, unplug the unit and have it serviced by an authorized NEC Service Center.
5. Unplug unit before cleaning. Use only a soft cloth and mild detergent. Commercial household sprays and cleaners may damage the CRT surface and cabinet.
6. Stacking of units, one top of another, may result in damage to the units. Stacking is not recommended.

ATTENTION



RISQUE D'ÉLECTROCUTION
NE PAS OUVRIR



MISE EN GARDE: AFIN DE REDUIRE LES RISQUES D'ÉLECTROCUTION, NE PAS DEPOSER LE COUVERCLE, IL N'Y A AUCUNE PIÈCE UTILISABLE À L'INTÉRIEUR DE CET APPAREIL. NE CONFIER LES TRAVAUX D'ENTRETIEN QU'À UN PERSONNEL QUALIFIÉ.



Ce symbole a pour but de prévenir l'utilisateur de la présence d'une tension dangereuse, non isolée se trouvant à l'intérieur de l'appareil. Elle est d'une intensité suffisante pour constituer un risque d'électrocution. Éviter le contact avec les pièces à l'intérieur de cet appareil.



Ce symbole a pour but de prévenir l'utilisateur de la présence d'importantes instructions concernant l'entretien et le fonctionnement de cet appareil. Par conséquent, elles doivent être lues attentivement afin d'éviter des problèmes.

AVERTISSEMENT

AFIN DE REDUIRE LES RISQUES D'INCENDIE OU D'ÉLECTROCUTION, NE PAS EXPOSER CET APPAREIL À LA PLUIE OU À L'HUMIDITÉ. AUSSI, NE PAS UTILISER LA FICHE POLARISÉE AVEC UN PROLONGATEUR OU UNE AUTRE PRISE DE COURANT SAUF SI CES LAMES PEUVENT ÊTRE INSÉRÉES À FOND. NE PAS OUVRIR LE COFFRET, DES COMPOSANTS HAUTE TENSION SE TROUVENT À L'INTÉRIEUR. LAISSER À UN PERSONNEL QUALIFIÉ LE SOIN DE RÉPARER CET APPAREIL.

DOC avis de conformation

Cet appareil numérique de la classe A respecte toutes les exigences du Règlement sur le Matériel Brouilleur du Canada.

Mises en garde et précautions de sécurité

Les moniteurs MultiSync Multimédia XP29 Plus et XM29 Plus de NEC ont été conçus et fabriqués pour assurer une longue durée de service sans problèmes. Aucun entretien à l'exception du nettoyage n'est nécessaire. Utiliser un chiffon doux et un détergent doux, si nécessaire. Ne pas utiliser des aérosols de nettoyage du commerce qui risquent d'endommager la surface de cet appareil. Si l'appareil est endommagé, confier les travaux de réparation à un centre de service agréé NEC.

Pour un fonctionnement sûr et afin d'éviter d'endommager l'appareil, lire attentivement et respecter les instructions suivantes.

Afin d'éviter tout risque d'électrocution et d'incendie:

1. Réserver un espace libre suffisant pour la ventilation afin d'éviter une accumulation de chaleur interne. Ne pas couvrir les trous d'aération arrière ou installer l'appareil dans un coffret fermé ou sur une étagère. L'appareil est équipé d'ailettes de refroidissement sur le dessus. Si l'appareil est logé dans un coffret ou sur une étagère, s'assurer qu'il y a un espace libre suffisant pour la dissipation de la chaleur. Si l'appareil est posé sur un coffret ou une étagère, la température doit être maintenue en dessous de 40°C.
2. Ne pas utiliser la fiche polarisée du cordon d'alimentation avec des prolongateurs ou des prises de courant, sauf si les lames peuvent être insérées à fond.
3. Ne pas exposer à la pluie ou à l'humidité.
4. Éviter d'endommager le cordon d'alimentation, et ne pas modifier le cordon d'alimentation.

5. Débrancher l'appareil pendant les tempêtes ou si l'appareil n'est pas utilisé pendant une longue période.
6. Ne pas ouvrir le coffret. Des composants de haute tension se trouvent à l'intérieur. Si l'appareil est endommagé de cette manière, la garantie devient caduque. De plus, il y a risque d'électrocution.
7. Ne pas essayer de réparer ou entretenir l'appareil soi-même. NEC ne saura être tenu pour responsable pour toute blessure ou dommage causé par des personnes non qualifiées qui essaient de réparer ou d'ouvrir le couvercle arrière. Confier toute réparation à un centre de service agréé NEC.

Pour éviter des dommages et prolonger la durée de service de l'appareil:

1. N'utiliser qu'une source d'alimentation de 100-120 V/220-240V 50/60 Hz CA. Le fait d'utiliser l'appareil en continu à des tensions de ligne supérieures à 100-120/220-240 Volts CA réduit sa durée de vie et risque de provoquer un incendie.
2. Manipuler l'appareil avec soin pendant son déplacement et ne pas le faire tomber.
3. Éloigner l'appareil des endroits chauds, très poussiéreux et exposés en plein soleil.
4. Éviter que des liquides et des petits objets métalliques pénètrent à l'intérieur de l'appareil. En cas d'accident, débrancher l'appareil et le confier à un centre de service agréé NEC.
5. Débrancher l'appareil avant le nettoyage. Utiliser seulement un chiffon doux et un détergent doux. Des aérosols et produits de nettoyage disponibles dans le commerce risquent d'endommager l'écran et le coffret.
6. Ne pas empiler les unités les unes sur les autres, afin d'éviter de les endommager.

LIMITED WARRANTY

NEC Multimedia Monitor Products

NEC Technologies, Inc.(hereafter NECTECH)warrants this product to be free from defects in material and workmanship under the following terms.

HOW LONG IS THE WARRANTY

Parts and labor are warranted for (1) One Year and CRT's for (1) One year from the date of the first customer purchase.

WHO IS PROTECTED

This warranty may be enforced only by the first purchaser.

WHAT IS COVERED AND WHAT IS NOT COVERED

Except as specified below, this warranty covers all defects in material or workmanship in this product. *The following are not covered by the warranty:*

1. Any product which is not distributed in the U.S.A. Canada, and Mexico by NECTECH or which is not purchased in the U.S.A. Canada, and Mexico from an authorized NECTECH dealer.

If you are uncertain as to whether a dealer is authorized, please contact NECTECH at 800-836-0655. Any questions or problems you have with our XP29Plus/XM29Plus, contact NECTECH at 800-836-0655.

2. Any product on which the serial number has been defaced, modified or removed.
3. Damage, deterioration or malfunction resulting from:
 - Accident, misuse, abuse, neglect, fire, water, lightning or other acts of nature,

of the problem(s). Failure to comply with NECTECH Service Procedures may cause a delay in repairing the unit.

3. For the name of the nearest NECTECH authorized service center, call NECTECH at 800-836-0655.

LIMITATION OF IMPLIED WARRANTIES

All implied warranties, including warranties of merchantability and fitness for a particular purpose, are limited in duration to the length of this warranty.

EXCLUSION OF DAMAGES

NECTECH's liability for any defective product is limited to the repair or replacement of the product at our option. NECTECH shall not be liable for:

1. Damage to other property caused by any defects in this product, damages based upon inconvenience, loss of use of the product, loss of time, commercial loss; or
2. Any other damages whether incidental, consequential or otherwise. Some states do not allow limitation on how long an implied warranty lasts and/or do not allow the exclusion or limitation of incidental or consequential damages, so the above limitations and exclusions may not apply to you.

unauthorized product modification, or failure to follow instructions supplied with the product.

- Repair or attempted repair by anyone not authorized by NECTECH.
 - Any shipment of the product (claims must be presented to the carrier).
 - Removal or installation of the product.
 - Any other cause which does not relate to a product defect.
 - Burns or residual images upon the phosphor of the tubes.
4. Cartons, carrying cases, batteries, external cabinets, magnetic tapes, or any accessories used in connection with the product.

WHAT WE WILL PAY FOR AND WHAT WE WILL NOT PAY FOR

We will pay labor and material expenses for covered items, but we will not pay for the following:

1. Removal or installation charges.
2. Costs of initial technical adjustments(set-up), including adjustment of user controls. These costs are the responsibility of the NECTECH dealer from whom the product was purchased.
3. Payment of shipping charges.

HOW YOU CAN GET WARRANTY SERVICE

1. To obtain service on your product, consult the dealer from whom you purchased the product, or ship it prepaid to any authorized NECTECH service center.
2. Whenever warranty service is required, the original dated invoice (or a copy) must be presented as proof of warranty coverage, and should be included in any shipment of the product. Please also include in any mailing, your name, address and a description

HOW STATE LAW RELATES TO THE WARRANTY

This warranty gives you specific legal rights, and you may also have other rights which vary from state to state.

FOR MORE INFORMATION, TELEPHONE 800-836-0655

NEC TECHNOLOGIES, INC.

1250 N. Arlington Heights Road, Suite 500

Itasca, Illinois 60143-1248

NOTE: All products returned to NECTECH for service MUST have prior approval. To get approval, call NEC Technologies at 800-836-0655.

CONTENTS

1. Introduction	
Introduction to the MultiSync XP29 Plus/XM29 Plus	1
Feature Highlights	1
2. Part Names and Functions	
Front View / Rear View	3
Terminal Board	5
Remote Control Unit	11
Battery Installation and Replacement / Remote Control Cautions / Operating Range	15
Functions of DIP SW	17
3. Installation	
Wiring Diagram	19
Connecting Your PC or Macintosh Computer	21
Connecting Your VCR or Laser Disc Player	22
Connecting Your Document Camera	22
Connecting Your NEC IDC Series Scan Converter	22
Daisy-chain Your monitors	23
D-Sub 15 Pin RGB Signal Composition	24
External Speaker Connections	25
4. Operation	
Power/General Controls/Degaussing	27
Using OSM Controls	28
Direct Control Screen	29
Accessing OSM	32
OSM Menus	32
Visual Controls Group	32
H-position/H-width/Pin-cushion Controls Group	33
V-position/V-height/V-linearity Controls Group	33
Keystone/Tilt/Rotation/Scan Select Controls Group	34
RGB Controls Group	35
OSM Location/OSM Turn Off Time Control	36
Source Information	36
Volume Control	37
Reset Control	37
OSM System Control Menu	39
PC/External Control Function	43
Command Reference	45
5. Troubleshooting	49
6. Specifications	51
7. Timing Charts	
Input Signal Reference Chart	57
Typical Input Signal Timing	61
Signal Identification for Raster Preset	65
8. Service and Support	67

This manual covers both the XP29 Plus and the XM29 Plus multimedia monitors. The operating procedures are common to both models.

OSM and IPM are trademarks of NEC Technologies, Inc.
IBM PC/AT, PS/2, VGA, S-VGA, 8514/A and XGA are registered trademarks of International Business Machines Corporation.
Apple and Macintosh are registered trademarks of Apple Computer, Inc.

Microsoft is a registered trademark of Microsoft Corporation. Windows is a trademark of Microsoft Corporation.

Introduction

Introduction to the MultiSync XP29 Plus/XM29 Plus Monitor

This section introduces you to your new MultiSync XP29 Plus/XM29 Plus monitor, provides a list of materials that comes with your monitor and describes the features and controls.

The features you'll enjoy include:

- Simple controls
Let you make all necessary adjustments and selections with one button simplicity from the remote control.
- 29" CRT(27" viewable image size)
- True displayable 1024 x768 resolution

Contents of the Package

The following lists all of the items included in your MultiSync multimedia monitor package. Please save the original box and packing materials for future transportation or shipment of this monitor.

1. MultiSync XP29 Plus (XP-2990)/XM29 Plus (XM-2960) multimedia monitor
2. Power cord
3. Wireless remote control unit and two AA batteries
4. PC/Macintosh MultiCable (15-Pin Mini D-Sub To 15-pin D-Sub Connector)
5. User's manual
6. Quick set up card
7. Registration card : Please fill out and return the registration card as soon as possible.

- On-screen menus
Plain English and clear instructions with graphic icons show you exactly how to adjust your screen image.
- Flexible inputs
Connect up to four different inputs at once and switch among them with a touch of a button to seamlessly integrate information from a computer and VCR into one presentation.
- Signal loop-through
Lets you run up to 2 monitors from one source, which can greatly simplify connections and reduce hardware requirements.
- Attractive cabinets
A sleek, sophisticated cabinet design complements your presentation environment and enhances the professionalism of your presentations.
- Microsoft Plug and Play compatibility
The only monitors in their class to include this standard that automatically optimizes display settings.
 - Supports most IBM VGA, S-VGA, XGA, Macintosh or any other RGB signals within a horizontal frequency range of 15.75 to 95 kHz (15.75 to 65 kHz for XM29 Plus) and a vertical frequency range of 40 to 120 Hz. This includes NTSC, PAL, SECAM, and M-NTSC standard video signals.
- MultiCable allows hook up to either Macintosh or IBM-PC compatible directly.
- Front bezel controls
- Universal power supply from 100 Vac thru 240 Vac

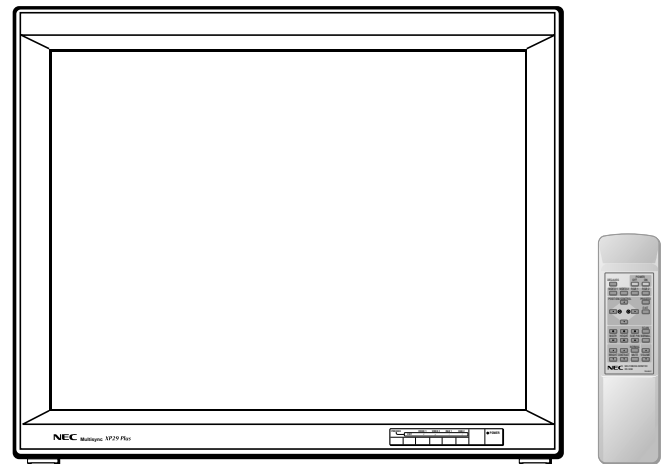

Part Names and Functions

Front View

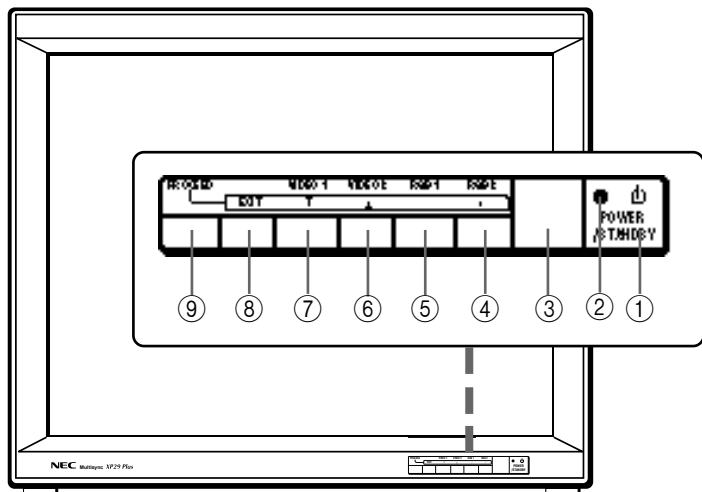

- ① **POWER** Press to turn the main power on and off when the AC power is supplied.
- ② **STANDBY/POWER**  When this indicator is green, the monitor is on; when the indicator is red, it is in standing by.
- ③ **Remote Sensor Window** ... Receives infrared signal from the handheld remote control.
- ④ **RGB 2/+** Press to select an RGB video source that is connected to the RGB 2 input terminals (BNC type). When you are in the OSM mode, this button works as the plus button.
- ⑤ **RGB 1/-** Press to select an RGB video source that is connected to the RGB 1 input terminal (D-SUB 15 pin type).
When you are in the OSM mode, this button works as the minus button.

Rear View

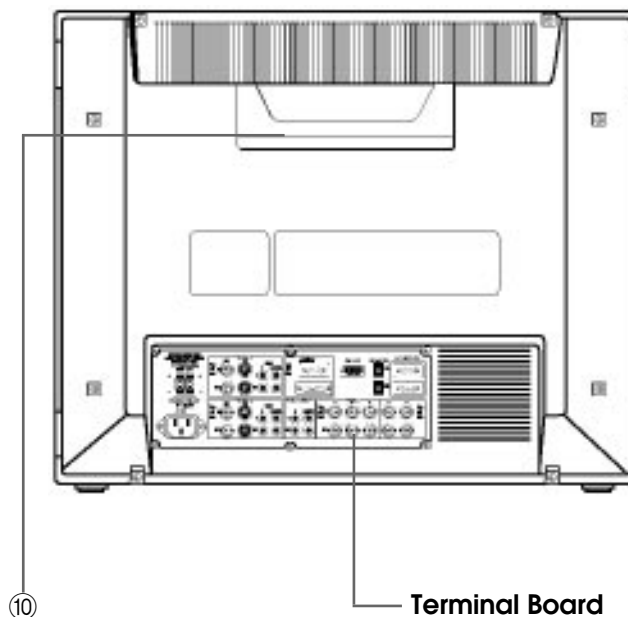

- ⑥ **VIDEO 2/▲** Press to select an NTSC, PAL, SECAM or M-NTSC compatible video source that is connected to the VIDEO 2 input terminal (BNC type or S-VIDEO 2 IN). When you are in the OSM mode, this button works as the up button.
NOTE: S-VIDEO IN terminals will take preference over VIDEO IN terminals when the video source is connected to each terminal and VIDEO 1 or 2 selected.
- ⑦ **VIDEO 1/▼** Press to select an NTSC, PAL, SECAM or M-NTSC compatible video source that is connected to the VIDEO 1 input terminal (BNC type or S-VIDEO 1 IN). When you are in the OSM mode, this button works as the down button.
- ⑧ **EXIT** Press to exit the OSM mode. The OSM screen disappears.
- ⑨ **PROCEED** Press to access OSM. The OSM screen is displayed.
- ⑩ **Remote Control Holder** Place remote control unit here when not in use.

Terminal Board

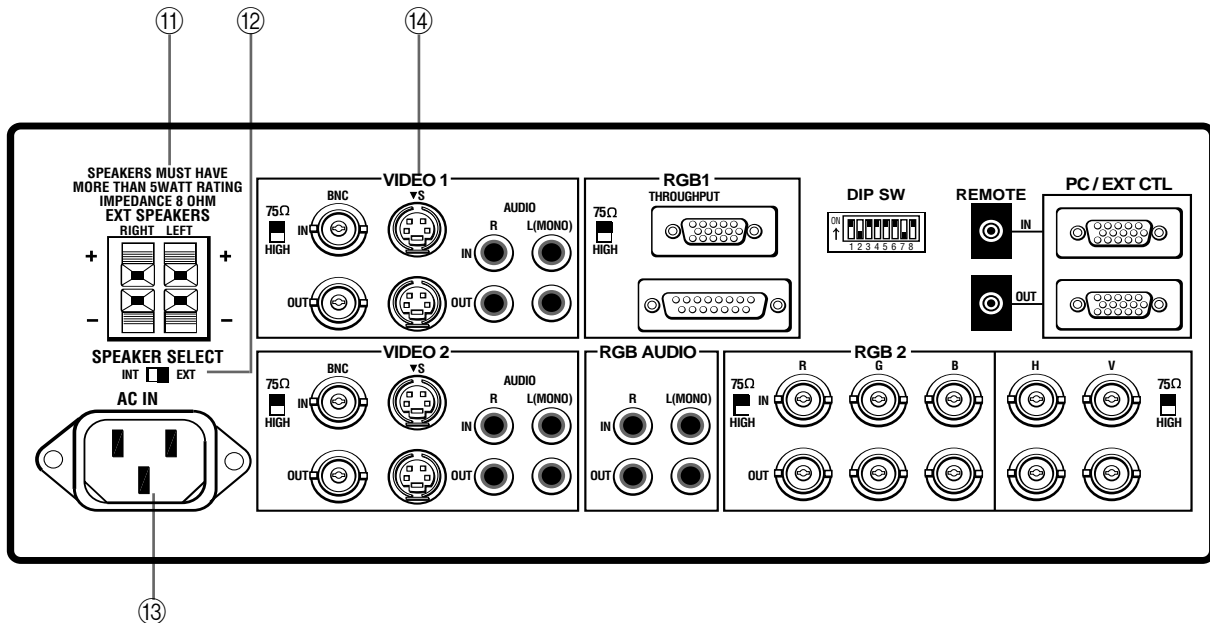

⑪ Speakers

RIGHT + Connect RIGHT speaker positive wire here.

RIGHT - Connect RIGHT speaker negative wire here.

LEFT - Connect LEFT speaker negative wire here.

LEFT + Connect LEFT speaker positive wire here.

⑫ SPEAKER SELECT INT/EXT Select Switch

Set to the INT position for built-in monitor speakers. Set to the EXT position for speakers connected to EXT SPEAKERS terminals.

⑬ AC Input

Connect the supplied power cord's three-pin plug here.

⑭ VIDEO 1

VIDEO 1 IN (BNC type) Connect a VCR or laser disk player here to display the video.

S-VIDEO 1 IN Here is where you connect S-Video input from an external source like a VCR.

THROUGH OUT (BNC type) Connect to a second monitor's video input to relay the video signal input at VIDEO 1 IN.

THROUGH OUT (S-VIDEO) Connect to a second monitor's S-connector input to relay the video signal input at S-VIDEO 1 IN.

75 Ω/HIGH Impedance Select Switch for BNC type ... Set to 75 Ω" during normal operation. In multiple connections using VIDEO 1 IN and THROUGH OUT (BNC type) terminals, set to "HIGH" on all but the last monitor. Set to "75 Ω" on the last monitor only.

AUDIO R IN This is your right channel audio input for stereo sound.

AUDIO L IN (MONO) This is your left channel audio input for stereo sound coming from video equipment or audio system. It also serves as the mono audio input.

AUDIO R THROUGH OUT Connect to a second monitor's right channel audio input.

AUDIO L THROUGH OUT Connect to a second monitor's left channel audio input.

Terminal Board

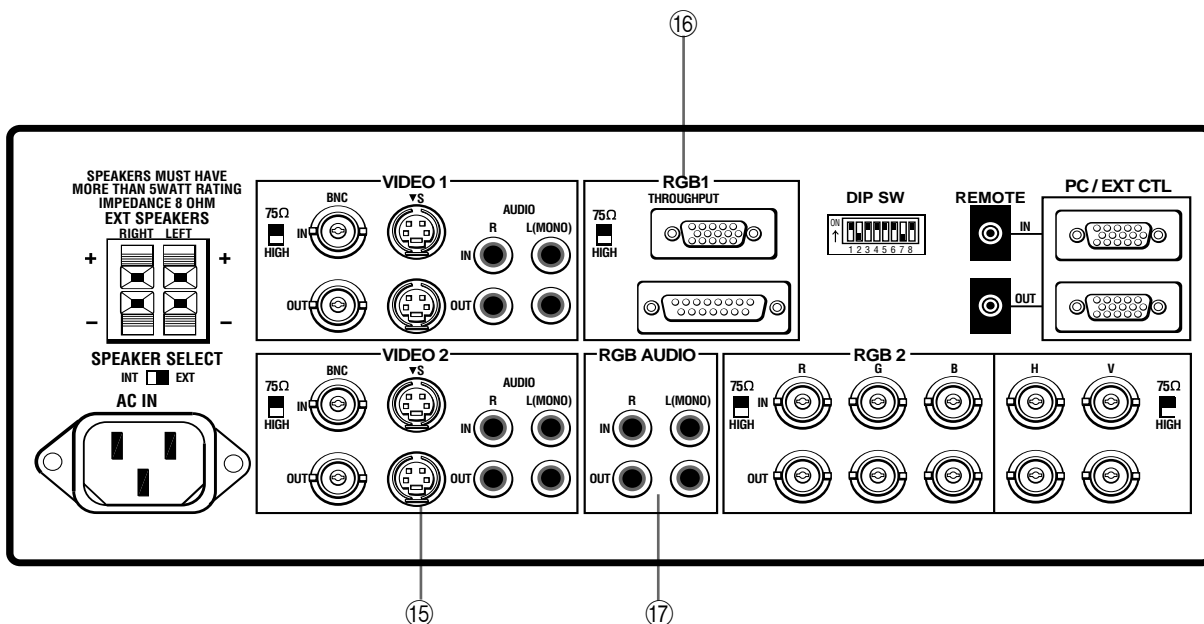

⑮ VIDEO 2

VIDEO 2 IN (BNC type) Connect another VCR or laser disk player here to display the video.

S-VIDEO 2 IN Connect S-Video input from another external source like a VCR.

THROUGH OUT (BNC type) Connect to a second monitor's video input to relay the video signal input at VIDEO 2 IN.

THROUGH OUT (S-VIDEO) Connect to a second monitor's S-connector input to relay the video signal input at S-VIDEO 2 IN.

75 Ω/HIGH Impedance Select Switch for BNC type Set to "75 Ω" during normal operation. In multiple connections using VIDEO 2 IN and THROUGH OUT (BNC type) terminals, set to "HIGH" on all but the last monitor. Set to "75 Ω" on the last monitor only.

AUDIO R IN This is your right channel audio input for stereo sound.

AUDIO L IN (MONO) This is your left channel audio input for stereo sound coming from video equipment or audio system. It also serves as the mono audio input.

AUDIO R THROUGH OUT Connect to a second monitor's right channel audio input.

AUDIO L THROUGH OUT Connect to a second monitor's left channel audio input.

⑯ RGB 1 (MultiCable)

RGB Input/Throughput Attach either end of the MultiCable to a computer, and then attach the other end to either of these two connectors. You can then use the remaining connector, if you wish, to output the computer signal to a monitor. (If you do use a second monitor, turn the monitor switch to "on.") Either connector can be used for input or output, however they cannot both be used for input simultaneously. It can damage your computer.

75 Ω/HIGH Impedance Select Switch This switch should be "75 Ω" for normal use without external termination or when your RGB signal should be terminated with 75Ω. Switch to the "HIGH" position when you have another monitor attached to your RGB through-put connector.

⑰ RGB AUDIO

AUDIO R IN This is where you connect RGB right audio output from a computer or another RGB source.

AUDIO L IN (MONO) ... This is where you connect RGB left audio output from a computer or another RGB source.

AUDIO R THROUGH OUT Connect to a second monitor's RGB right audio input.

AUDIO L THROUGH OUT Connect to a second monitor's RGB left audio input.

Terminal Board

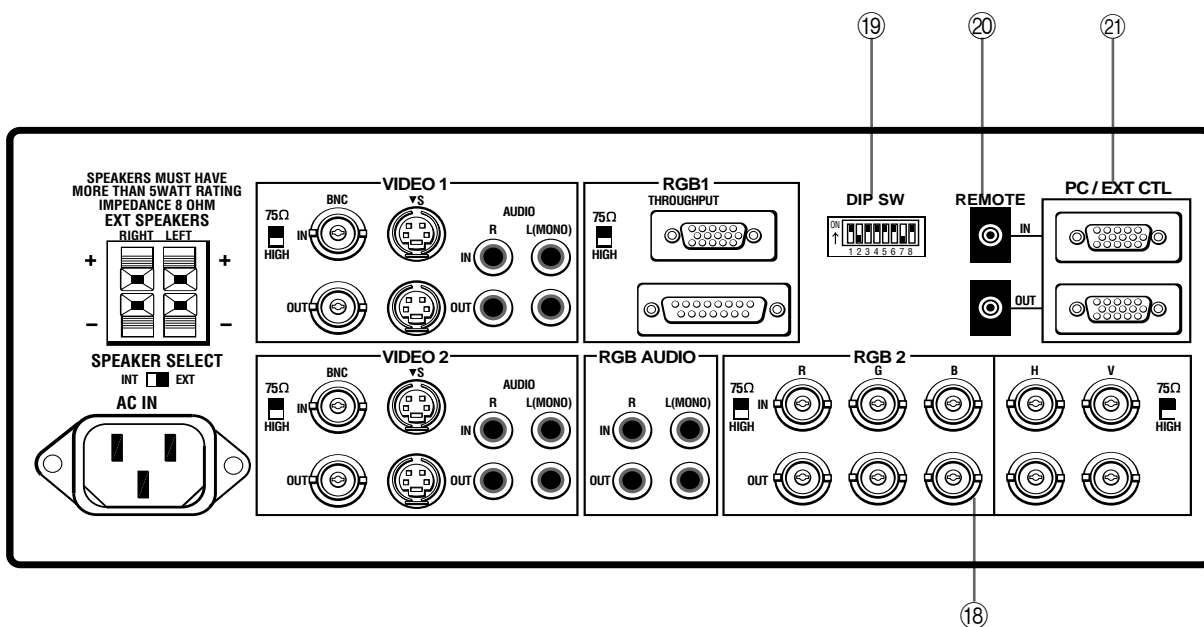

⑱ RGB 2

R, G, B, H and V IN (BNC) These are analog RGB input terminals. Connect external components with R, G, B, H, and V output terminals to these analog RGB input terminals. Be sure that the RGB connection cable is correctly attached to the corresponding terminals.

R, G, B, H and V THROUGH OUT (BNC) Connect to a second monitor's RGB inputs to relay the RGB signal inputs at R, G, B, H, and V IN.

75 Ω/HIGH Impedance Select Switches for RGB and HV Set to "75 Ω" during normal operation. In multiple connections using R, G, B, H and V IN and OUT terminals, set to "HIGH" on all but the last monitor. Set to "75 Ω" on the last monitor only.

⑲ DIP Switch

DIP SW This DIP switch sets Sync. Control, the Intelligent Power Manager, external control on/off, remote control on/off, and OSM system control on/off. See pages 17 and 18 for more details.

⑳ REMOTE IN/OUT

Connect the optional remote cable to the REMOTE IN terminal. The REMOTE OUT terminal is used to connect several monitors together and allows all of the monitors to be controlled by one remote control.

NOTE: Up to 50 monitors can be connected in the serial connection.

㉑ PC/EXT CTL IN(D-Sub 15-pin)

This terminal is used when power ON/OFF, input selection, AUDIO MUTE, PICTURE MUTE, and DEGAUSS are operated externally (by external control). See also page 43 for external control port pin assignments. You can also use this connector to connect your PC to control the MultiSync XP29 Plus/XM29 Plus monitor. This allows you to utilize your PC and serial communication protocol to control the monitor.

NOTE: Select EXT. CONTROL ON by setting pin No. 6 of DIP SW to the ON position when operating the monitor by external control.

NOTE: When in the EXT. CONTROL mode, the following operations of the supplied wireless remote control are not possible: Power control ON/OFF, Input selection, Audio mute ON/OFF, and Degauss switch ON/OFF.

PC/EXT CTL OUT (D-Sub 15-pin) Connect to a second monitor's PC/EXT CTL input to relay the signal input at the PC/EXT CTL IN. The PC/EXT CTL OUT terminal is used to connect several monitors together and allows all of the monitors to be controlled by one external control. No. 6 pin (EXT. CONTROL) of DIP SW must be set to the ON position on all of the monitors.

Remote Control Unit

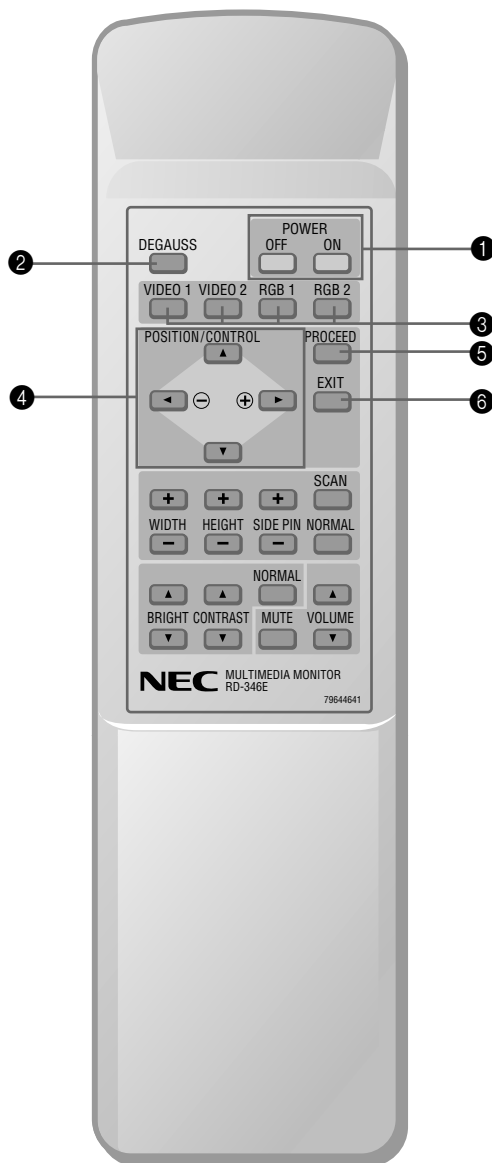

NOTE: When not in use the remote control unit is conveniently stowed in the holder on the rear panel.

1 POWER ON/OFF

Press POWER ON to turn the monitor on when the STANDBY/POWER indicator is lit red.

Press POWER OFF to turn the monitor off and the monitor will go into the standby condition.

2 DEGAUSS

Press to demagnetize the picture tube in the manual operation. See also page 27.

3 Input Select

VIDEO 1 Press to select an NTSC, PAL, SECAM or M-NTSC compatible video source from a VCR, laser disc player, document camera, or an S-Video source from a VCR connected to the VIDEO 1 IN terminal.

VIDEO 2 Press to select an NTSC, PAL, SECAM or M-NTSC compatible video source from a VCR, laser disc player, document camera, or an S-Video source from a VCR connected to the VIDEO 2 IN terminal.

RGB 1 Press to select an RGB video source from a computer connected to the RGB 1 IN terminal.

RGB 2 Press to select an RGB video source from a computer, NEC scan converter or document camera connected to the RGB 2 IN terminal.

OSM Control

4 POSITION/CONTROL

POSITION(▲▼◀▶) Adjusts the vertical position of the image up and down, and the horizontal position of the image from left to right.

CONTROL (+/-) Moves the bar in the + or - direction to increase or decrease the adjustment in an OSM menu.

CONTROL(▲/▼) .. Select one of the controls in an OSM menu. Press ▲ to select a higher item in the menu; press ▼ to select a lower item in the menu.

5 PROCEED

Press to access OSM. When an adjustment item is selected, a press of this button returns to its icon selection screen.

6 EXIT

Press to exit the OSM mode.

NOTE: The direct keys such as BRIGHT, CONTRAST, WIDTH, HEIGHT, SIDE PIN can access each control while in the OSM mode.

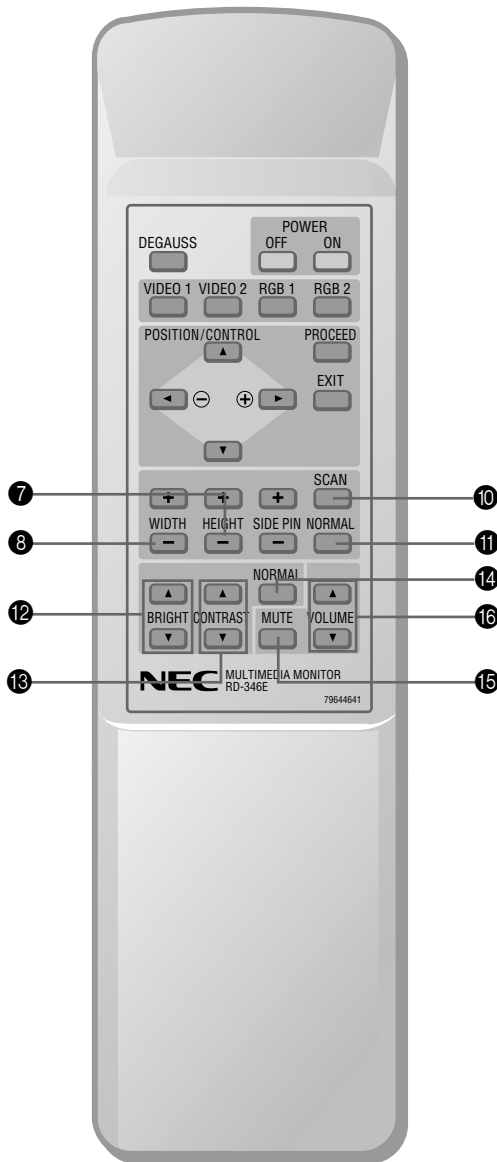

Raster Control

7 WIDTH (+ / -)

Adjusts the horizontal size of the image.

8 HEIGHT (+ / -)

Adjusts the vertical size of the image.

9 SIDE PIN (+ / -)

Adjusts the curvature of the edges of the left and right side of the display image either inward or outward. The image should be adjusted to attain a straight line on the left and right sides.

10 SCAN SELECT

Each time this key is pressed, the picture size switches from OVER SCAN for large size to UNDER SCAN for small size and vice versa. Normally select OVER SCAN for video display and UNDER SCAN for RGB display.

11 NORMAL

This key resets the raster adjustment settings of user changeable memory and recalls the factory preset data.

Visual Control

12 BRIGHT (▲ / ▼)

Adjusts the overall image and screen brightness.

Press and hold ▲ for a brighter picture.

Press and hold ▼ for a darker picture.

13 CONTRAST (▲ / ▼)

Adjusts the image brightness in relation to the background.

Press and hold ▲ for higher contrast.

Press and hold ▼ for lower contrast.

NOTE: The VISUAL CONTROL storing operation is effective only for one input (VIDEO1, VIDEO 2, RGB 1 or RGB 2).

14 NORMAL

This key resets the visual control settings and recalls the factory preset data.

NOTE: The brightness and contrast adjustment level are factory preset at the optimum position.

15 MUTE

Press to cancel sound ; press again to restore sound.

NOTE: The other ways to restore sound are to press POWER OFF, then ON or to press VOLUME keys on the remote control unit.

16 VOLUME (▲ / ▼)

Adjusts the volume.

Press and hold ▲ to increase sound.

Press and hold ▼ to decrease sound.

Battery Installation and Replacement

The remote control is powered by two 1.5V AA batteries.

1. Turn the remote control unit upside down. Press down on the battery compartment grip and slide the compartment in the direction of the arrow.

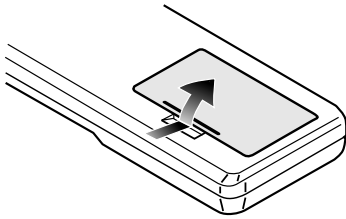

2. Install the two new batteries, making sure that their polarity matches the (+) (-) diagrams inside the battery compartment. Incorrect polarity could damage the remote control unit.

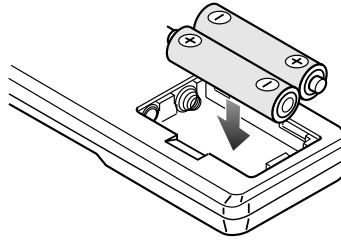

3. Close the battery compartment cover.

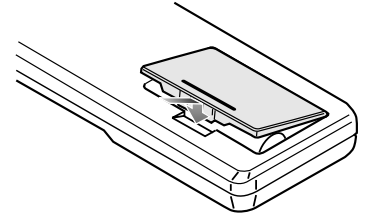

Remote Control Cautions

- Do not drop or mishandle the remote control unit.
- Do not get the remote control unit wet. If the remote gets wet, wipe it dry immediately.
- Avoid heat and humidity.
- When not using the remote control unit for a long period, remove the batteries.
- Do not use new and old batteries together, or use different types of batteries together.
- Do not take apart the batteries, heat them, or throw them into a fire.

Operating Range

- The infrared signal operates by line-of-sight up to a distance of approximately 22 feet/7 m and within a 60 degree angle of the remote sensor of the monitor.
- The monitor will not function if there are objects between the remote control and the sensor or if strong light falls on the sensor. Weak batteries will also prevent the remote control from properly operating the monitor.

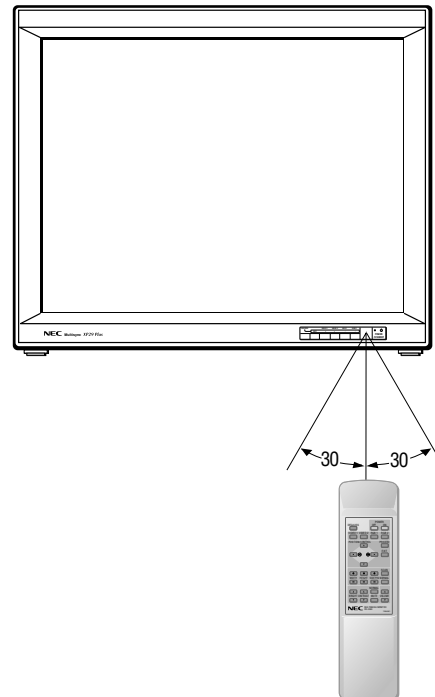

Functions of DIP SW

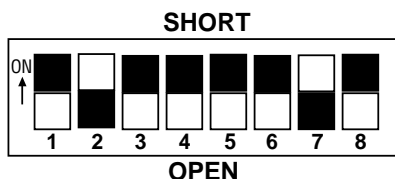

Functions and Settings of DIP SW

This DIP switch is used for Sync. Control, Intelligent Power Manager, External control, wireless control, and OSM control. To change a switch setting use a pointed object, such as a pen or pencil, to push the switch to the desired position.

Set all the pins except No. 2 and 7 to the OFF/OPEN position during normal operation.

The pins nos 3 and 5 are not used.

Pin No 1 and 2(Sync. Control)

The No. 1 and 2 pins set Sync. Control.

Set the No. 1 pin to the OFF/OPEN position and the No. 2 pin to the ON/SHORT position during normal operation. The monitor automatically determines if the input signal is separate sync, composite sync or sync on green signal in this order.

Pin No. 4 (Intelligent Power Manager)

This function saves power.

When Intelligent Power Manager control is on, by using the monitor' s horizontal and vertical SYNC signals, the monitor can be prompted into the different IPM modes. The following is the description of the LED indicator for the IPM power saving modes:

Mode	LED Indicator	Power Saving
On	Green	None
Standby	Red (Steady)	None
Standby	Amber(Blinking quickly)	Minimum (Quickest recovery)
Suspend	Amber(Blinking moderately)	Moderate (EPA<30 watts, Moderate recovery)
Off	Amber(Blinking slowly)	Maximum (EPA<30 watts, Slowest recovery)
Power Off	No Light	No Power Used (Fully Off)

NOTE: The Intelligent Power Manager works only for the RGB input. If selecting the VIDEO input, or when connecting to no signal source, the Intelligent Power Manager does not work.

Set the No. 1 pin to the ON/SHORT position when sync on green signals are necessary for synchronization with an external component.

When a composite signal is present, the picture may be distorted. If this happens, set the No.2 pin to the OFF/OPEN position.

Pin No. 6 (EXT. CONTROL)

When this switch is set to ON, the External Control function is activated. See page 43 for pin assignments. If you have some monitors you do not want to control by remote, set to OFF.

Pin No. 7 (REMOTE ON/OFF)

When this switch is set to ON/SHORT, the monitor can be controlled by the wireless remote control unit.

Pin No. 8 (OSM System Control Menu ON/OFF)

When this switch is set to ON/SHORT, the system control menu is displayed.

In this menu the following features are enabled:

- Power on mode set(POWER ON MODE)
- Front control key on/off(FRONT CONTROL)
- Language selection(LANGUAGE)
- Video mode(auto/manual) selection(VIDEO MODE)
- OSM on/off(OSM ON/OFF)
- PC-control on/off(PC-CONTROL)

For the setting procedures to set the items, see page 39.

Installation

Wiring Diagram

IBM XGA/SuperVGA/VGA or

Macintosh or
Compatibles

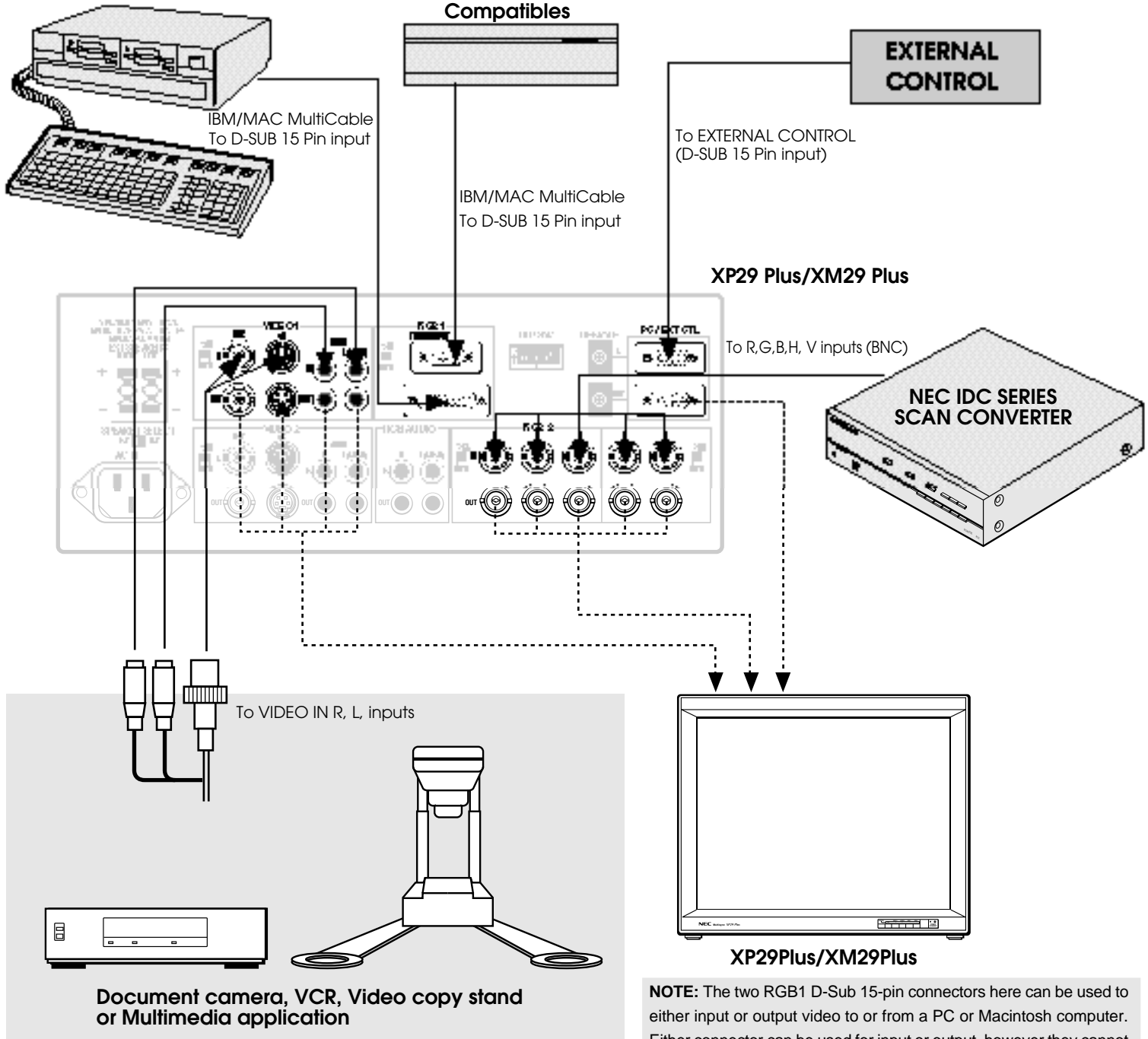

NOTE: The two RGB1 D-Sub 15-pin connectors here can be used to either input or output video to or from a PC or Macintosh computer. Either connector can be used for input or output, however they cannot both be used for input simultaneously. It can damage your computer.

Connecting Your PC or Macintosh Computer

Connecting your PC or Macintosh computer to your MultiSync XP29 Plus/XM29 Plus via the MultiCable connection system will enable you to display your computer's screen image. All of these following display standards are supported:

VGA 640 x 480 for graphics, VGA 640 x 400 for graphics, VGA 640 x 350 for graphics, VGA 720 x 400 for text, VGA 720 x 350 for text, SuperVGA 800 x 600, and XGA 1024 x 768, 1280x1024 standards above 60 Hz such as Sun, Silicon Graphics, HP, workstation standards; Macintosh at 640 x 480, 832 x 624, 1024 x 768, and 1152 x870(XP29 Plus only).

To connect to a PC, Macintosh or computer equipped with a XGA/SuperVGA/VGA adapter or compatible graphics adapter, simply:

1. Turn off the power to your monitor and computer.
2. If your PC does not support Super XGA/VGA/VGA you will need to install an XGA/SuperVGA/VGA graphics board. Consult your computer's owner's manual for your XGA/SuperVGA/VGA configuration. If you need to install a new board, see the manual that comes with your new graphics board for installation instructions.

Connecting Your VCR or Laser Disc Player

Using a common RCA cable and RCA audio cables (not provided) to connect your VCR or laser disc player to your MultiSync XP29 Plus/XM29 Plus monitor. To make these connections, simply:

1. Turn off the power to your monitor and VCR or laser disc player.
2. Connect one end of your RCA video cable to the video output connector on the back of your VCR or laser disc player, connect the other end to the VIDEO 1 or 2 input terminal(BNC-type) of the monitor. **NOTE:** You will need an RCA to BNC adaptor (not included) to convert to the XP29Plus/XM29Plus monitor. Use standard RCA audio patch cords to connect the audio from your VCR or laser disc player to your monitor (if your VCR or laser disc player has this capability). Be careful to keep your right and left channel connections correct for stereo sound.
3. Turn on the monitor and the VCR or laser disc player.

NOTE: Refer to your VCR or laser disc player owner's manual for more information about your equipment's video output requirements.

NOTE: S-VIDEO IN terminals will take preference over VIDEO IN terminals when a component is connected to each terminal and VIDEO 1 or 2 selected.

3. Use the supplied MultiCable to connect your computer to the monitor. For a PC, use the smaller 15-pin connector on the cable to connect to your computer's video port; use the larger 15-pin connector on the cable to connect to the monitor. For Macintosh, it's just the opposite. Use the larger 15-pin connector on the cable to connect to your computer's video port; use the smaller 15-pin connector on the cable to connect to the monitor. (You can also use your own video cable if you wish. For a PC cable, use the smaller 15-pin connector on the monitor. For a Macintosh cable, use the larger 15-pin connector on the monitor.)
4. Turn on the monitor and the computer.

NOTE: Refer to your computer's owner's manual for more information about your computer's video output requirements and any special identification or configuring your monitor's image and monitor may require.

Connecting Your Document Camera

You can connect your MultiSync XP29 Plus/XM29 Plus monitor to a document camera. To do so, simply:

1. Turn off the power to your monitor and document camera.
2. Use a standard video cable to connect your document camera to the VIDEO 1 or 2 input terminal(BNC-type) of the monitor.
3. Turn on the monitor and the document camera.

NOTE: Refer to your document camera's owner's manual for more information about your camera's video output requirements .

Connecting Your NEC IDC Series Scan Converter

You can connect an NEC IDC series scan converter to the monitor to improve the quality of your video images. To do so:

1. Turn off the power to your monitor and scan converter.
2. Use a cable (RGB HV 5 conductor BNC/BNC) supplied with the scan converter to connect the RGB 2 inputs of the monitor.
3. Turn on the monitor and the scan converter.

Daisy-chaining Your monitors

The REMOTE IN/OUT terminals allow you to control monitors by one remote control.

NOTE: The connection of three XP29 Plus/XM29 Plus monitors or more with THROUGH OUT (VIDEO 1 or 2) terminals may degrade image quality.

To do so:

When using the VIDEO inputs:

THROUGH OUT (VIDEO 1) Connections

1. Connect THROUGH OUT 1 BNC or S-VIDEO 1 OUT to external components to relay the signal input at VIDEO 1 IN(BNC-type), or S-VIDEO 1 IN.
2. Connect the external component mono audio or stereo left channel audio input to L AUDIO.
3. Connect the external component stereo right channel audio input to R AUDIO.
4. Set the 75Ω/HIGH impedance select switch of the corresponding input signal (BNC, S-VIDEO) on all but the last monitor to "HIGH" position. On only the last monitor is set to "75Ω" position.

THROUGH OUT (VIDEO 2) Connections

1. Connect THROUGH OUT 2 BNC or S-VIDEO 2 OUT to external component to relay the signal input at VIDEO 2 IN(BNC-type) or S-VIDEO 2 IN.
2. Connect the external component mono audio or stereo left channel audio input to L AUDIO.

3. Connect the external component stereo right channel audio input to R AUDIO.
4. Set the 75Ω/HIGH impedance select switch of the corresponding input signal (BNC, S-VIDEO) on all but the last monitor to "HIGH" position. On only the last monitor is set to the "75Ω" position.
5. Connect the REMOTE OUT of the monitor to the REMOTE IN of the next monitor using the optional remote cable.

When using the RGB inputs:

THROUGH OUT Connections

1. (RGB1): Connect D-Sub 15-pin THROUGH OUT to an RGB input connector of other monitors.
(RGB2): Connect the R.G.B.H and V THROUGH OUT terminals to relay the signal input at the R.G.B.H and V IN terminals.
2. Set all the 75Ω/HIGH impedance select switches on all but the last monitor to "HIGH" position. On only the last monitor is set to the "75Ω" position.
3. Connect the REMOTE IN of the monitor to the REMOTE OUT of the next monitor using the optional remote cable.

NOTE: "Plug and Play" is available only for the monitor connected directly to a personal computer with the D-Sub 15-pin RGB connector. Therefore, "Plug and Play" does not work for monitors connected with the THROUGH OUT terminal. This is because only the RGB video, the horizontal, and the vertical sync. signal is output from the THROUGH OUT terminals.

NOTE: "Plug and Play" is not available for the RGB 2 BNC terminals.

D-Sub 15 Pin RGB Signal Composition

Pin Assignments and Signal Levels for 15 pin RGB (Analog)

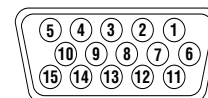
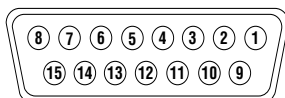

D-SUB 15pin RGB Input Connector (ANALOG ONLY)

Pin No.	Signal to be connected (D-SUB 15 pin)
1	RED
2	GREEN or Sync Green
3	BLUE
12	No Connection
13	H. or Composite sync
14	V.SYNC
15	No Connection
4	GND
5	GND
6	GND
7	GND
8	GND
11	GND
10	No Connection
9	No Connection

Pin No.	Through output (MAC 15 pin)
2	RED
5	GREEN or Sync Green
9	BLUE
7	SDA (PnP)
3	H. or Composite sync
12	V.SYNC
15	SCL (PnP)
1	GND
4	GND
6	GND
11	GND
13	GND
8	No Connection
10	No Connection
14	No Connection

External Speaker Connections

External speakers may be connected to the monitor to reproduce sound from VIDEO 1, VIDEO 2, RGB 1 or RGB 2 signal sources.

External speakers may be connected directly to the EXTERNAL SPEAKERS terminals or indirectly by connecting a stereo system amplifier to the audio outputs.

WARNING: Speakers that are installed next to the monitor must be shielded against electromagnetic field which can cause color distortion in the CRT and is not covered under the warranty.

If non-shielded speakers are used, they must be located a minimum of 4 feet away from the monitor.

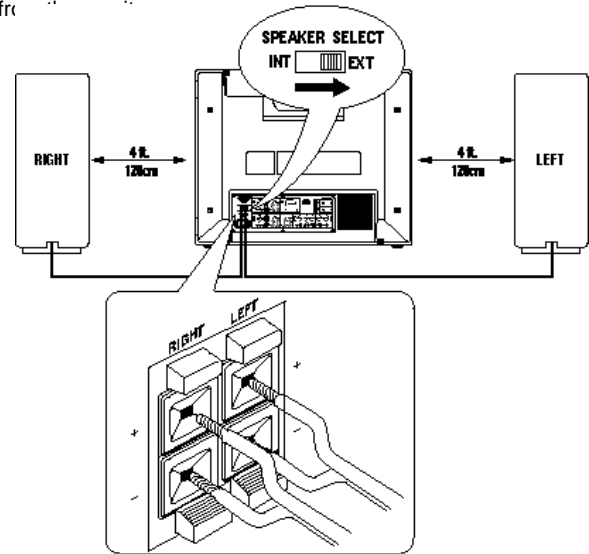

CAUTION: Unplug the monitor and all connected components before connecting external speakers. Use only speakers with 8-ohm impedance and a power output rating of 5 watts or more.

To connect external speakers directly to the monitor:

1. Strip the ends of the speaker wires.
2. Press down a button below the EXTERNAL SPEAKERS terminals, insert the speaker wire and release the button to secure a speaker wire connection:
 - [a] Connect the right speaker (located at right side of the monitor when viewed from the front) positive (+) wire to RIGHT +.
 - [b] Connect the right speaker negative (-) wire to RIGHT -.
 - [c] Connect the left speaker negative (-) wire to LEFT -.
 - [d] Connect the left speaker positive wire (+) to LEFT +.
3. Set SPEAKER SELECT switch at EXT.

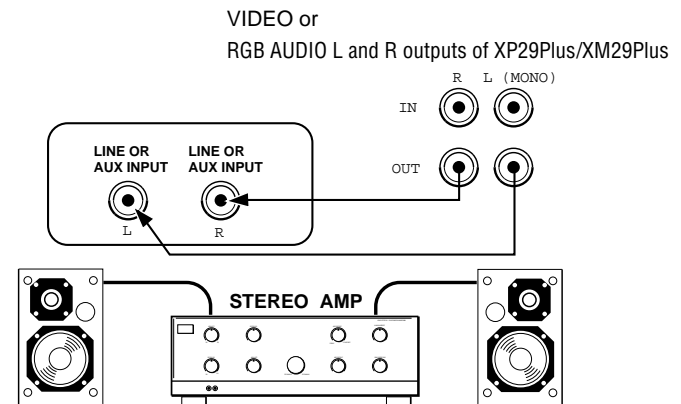

To connect the monitor to stereo system speakers:

1. Connect L AUDIO output to the stereo amplifier L AUX input.
2. Connect R AUDIO output to the stereo amplifier R AUX input.
3. Set SPEAKER SELECT switch at EXT to use external speakers only. For center channel audio fill, set SPEAKER SELECT at INT for sound from both monitor and external speakers.

IMPORTANT: Do not connect speakers to both the monitor EXTERNAL SPEAKERS terminals and to the stereo amplifier. This could damage both the monitor and the speakers.

Operation

Power

This section describes how to select a computer or video source and how to adjust the picture and sound.

General Controls

Before you turn on your MultiSync XP29 Plus/XM29 Plus monitor ensure that the computer or video source is turned on.

1)To adjust:

1. Turn On The Monitor

The power button is on the front panel of the monitor. By turning this switch on, the STANDBY/POWER indicator will turn to green and the monitor will become ready to use. OSM is also usable from the front bezel.

After you press the POWER OFF button on the remote control, the monitor will go into its standby mode and the STANDBY/POWER indicator will glow red.

2. Select The Computer Or Video Source

Press the "VIDEO 1" or "VIDEO 2" (VCR, document camera, or laser disc player), or "RGB 1" or "RGB 2"(computer) button on the remote control to display the image. Or press the button on the front panel to select your video source: "VIDEO 1", "VIDEO 2", "RGB 1", or "RGB 2".

NOTE 1: In the U.S.A. the standard video signal format is NTSC, therefore make sure that the AUTO or NTSC is selected on OSM system control menu. See page 40.

NOTE 2: Select the over scan mode for VIDEO display.

3. Adjust The Raster or The Picture Control.

You can adjust the raster such as the horizontal size, vertical size or side pincushion correction, and the brightness and contrast of the image with the remote control.

4. Turning Off The monitor.

Press the POWER OFF button on the remote control or press the POWER button on the front panel.

Degaussing

The earth's magnetic field and other magnetic sources can magnetize a color picture tube causing patches of impure colors. This monitor automatically demagnetizes the picture tube for 5 seconds each time the monitor is switched on. Sometimes during transportation a severe magnetic field can be encountered which may require demagnetizing to clear the problem. Also, if powered on for extended periods of time, magnetic fields can be produced by the CRT itself, causing color impurities. In these cases, use the DEGAUSS key once to demagnetize the picture tube. Pressing this key once demagnetizes the picture tube for 5 seconds.

CAUTION: Please allow a minimum of 30 minutes to elapse between uses of the DEGAUSS key, when not switching from mode to mode. Do not hold the key down continuously to avoid decreasing the life of the degauss circuitry.

Using OSM Controls

NEC's new OSM, or On-Screen Manager, System offers the ultimate form of monitor controls. Keys on the remote control unit or front bezel allow you to easily navigate through menus and adjust controls.

OSM controls include extended controls such as Brightness, Contrast, Size, Position, Pin cushion, Keystone, Vertical Linearity, Scan Select and other OSM utilities. Adjustments are saved instantly. The currently addressed control can be reset to factory settings by pressing the NORMAL key.

OSM keys on the remote control unit function as follows:

- PROCEED** : accesses the OSM controls. When an adjustment item is selected, a press of this button returns to its icon selection screen.
- in the color temperature: proceeds to the control for RGB gain and bias.
- EXIT** : exits the OSM controls.
- in the RGB gain and bias: return to the color temperature screen.
- POSITION CONTROL up/down** : selects one of the control items.
- POSITION CONTROL-/+** : increase or decrease the settings level.
- : selects a group icon at top of the OSM screen when any one of them is highlighted without any specific control selected.

NORMAL (RASTER/VISUAL) : resets the currently selected control to the factory setting.

- when a specific group icon is highlighted, this key resets all the specific controls settings or all the settings.

- when a specific control is selected: this key resets the selected adjustments.

NOTE: The NORMAL function is not valid in the OSM Turn Off Time, Language Select menus, and Volume Control.

Direct Control Screen

You can adjust the raster, visual and sound using the direct key on the remote control.

To switch to another control screen, press any one of the other keys.

*To end the OSM display, press EXIT.

*If no key operation is made within 3 seconds, the OSM display will disappear.

a. POSITION/CONTROL

Press ► to move the image right. Press ◀ to move the image left.

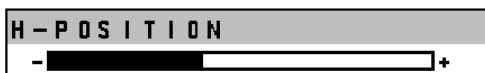

Press ▲ to move the image up. Press ▼ to move the image down.

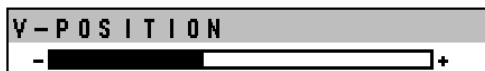

b. WIDTH

Press to adjust the horizontal size of the image.



f. NORMAL (raster)

Press to reset all the stored adjustment raster data and recall the factory preset data. When a specific control is selected, this key resets the selected raster adjustments.

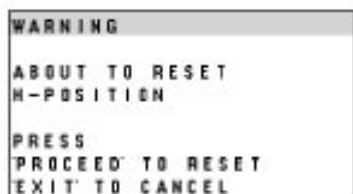
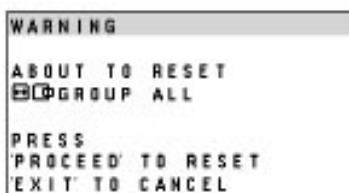
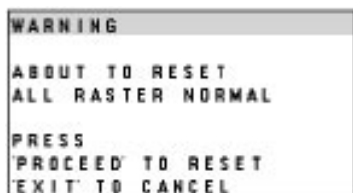

c. HEIGHT

Press to adjust the vertical size of the image.



d. SIDE PIN

Press to adjust the curvature of the edges of the left and right side of the display image either inward or outward. The image should be adjusted to attain a straight line on the left and right sides.



e. SCAN

Press to select the scan mode: over scan and under scan.



g. BRIGHT

Press to adjust the brightness of video display.



h. CONTRAST

Press to adjust the contrast of video display.



i. NORMAL(visual)

Press to reset all the stored adjustment visual data and recall the factory preset data. When a specific control is selected, this key resets the selected visual adjustments.

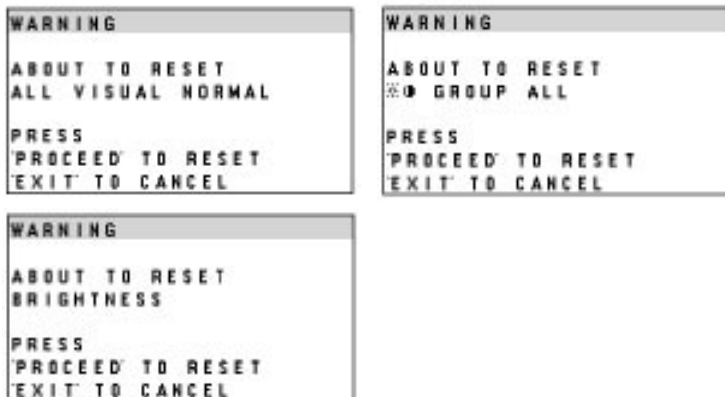

j. MUTE

Press to turn off the sound for a short period of time; press again to restore the sound.



k. VOLUME

Press ▲ to increase the sound; press ▼ to decrease the sound.



When pressing a key that does not correspond to the function currently use, the following message will be displayed on the monitor.

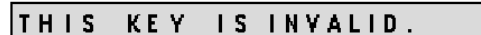

Accessing OSM

Press the PROCEED key on the remote control or front bezel.

To turn off OSM

Press the EXIT key on the remote control or front bezel.

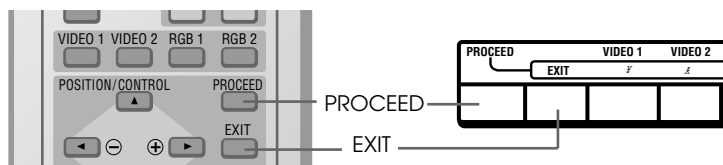

OSM Menus

On-Screen Manager's menu of Controls gives you an overview of the selection of controls available.

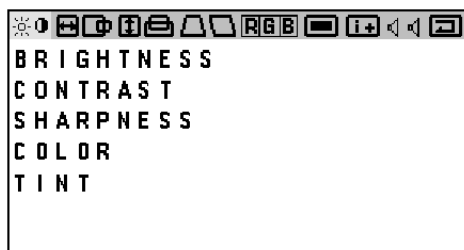

Visual Controls Group

The visual controls allow you to adjust the picture controls such as brightness, contrast, color, tint, and sharpness.

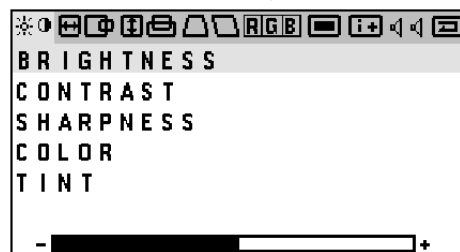

BRIGHTNESS : Pressing + or - increases or decreases the image brightness level.

CONTRAST : Pressing + or - increases or decreases the image contrast level.

SHARPNESS : Pressing + or - increases or decreases the image sharpness level.

COLOR : Pressing + or - increases or decreases the image color saturation level

TINT : Pressing + or - increases or decreases the green and red values.

NOTE: The color, tint and sharpness controls are not available for RGB input, and the tint is not available for PAL input.

NOTE: Pressing the visual NORMAL key resets all the visual controls to the factory settings when only the visual controls group icon is highlighted.

H-position/H-width/Pin-cushion Controls Group

The H-position/H-width/Pin-cushion Controls allow you to adjust the horizontal position, horizontal size and pin-cushion of the image.



- H-POSITION** : Pressing + or - moves the image horizontally right or left.
- H-WIDTH** : Pressing + or - decreases or increases the horizontal size of the image (wider or narrower).
- PIN-CUSHION** : Pressing + or - decreases or increases the curvature of the sides either inward or outward.
- PIN-BALANCE** : Pressing + or - decreases or increases the curvature of the sides to right or to left.
- PIN-CORNER** : Pressing + or - decreases or increases the curvature of the four corners inward outward.

NOTE: The V-LINEARITY controls allow you to adjust the spacing of the areas on the screen. The object of this control is to ensure that a one-inch circle is a true one-inch circle where ever it is drawn on the screen.

- draw equally spaced horizontal lines using a drawing application that has a ruler.
- use the V-LINEARITY 1 and 2 controls to adjust the spacing between the lines near the top and the bottom of your screen.

V-position/V-height/V-linearity Controls Group

The V-position/V-height/V-linearity Controls allow you to adjust the vertical position, vertical size and vertical linearity of the image.



- V-POSITION** : Pressing + or - moves the image vertically up or down.
- V-HEIGHT** : Pressing + or - increases or decreases the vertical size of the image (taller or shorter).
- V-LINEARITY 1** : Pressing + increases the spacing between the lines near the top and decreases the lines near the bottom at the same time; pressing - increases the spacing between the lines near the bottom and decreases the lines near the top at the same time.
- V-LINEARITY 2** : Pressing + or - increases or decreases the spacing between the lines near the top of your screen and near the bottom of your screen at the same time.

Keystone/Tilt/Rotation/Scan Select Controls Group

The Keystone/Tilt/Rotation/Scan Select Controls allow you to adjust the raster rotation or angle of the sides of your display and to select either Under Scan (for RGB display) or Over Scan (for VIDEO display).

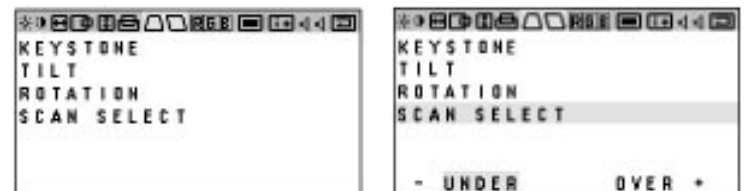

- Keystone (trapezoidal)** : Pressing + or - increases or decreases the bottom of the screen to be the same as the top.
- TILT** : Pressing + or - increases or decreases the tilt of your display.
- ROTATION (raster rotation)** : Pressing + or - rotates the entire display clockwise or counter clockwise.
- SCAN SELECT** : Pressing + or - selects the over scan mode or the under scan mode.

RGB Controls Group

The RGB Controls allow you to adjust the color temperature, high contrast and the white balance for RGB input.

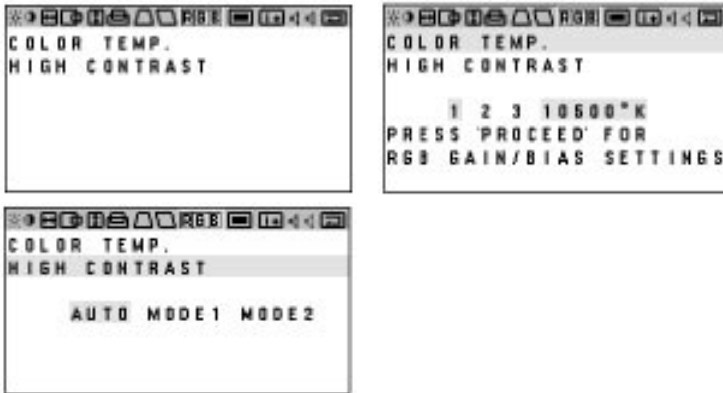

COLOR TEMP. : Pressing + selects the color temperature: 10500 K, 9300K, 6500K or custom.

HIGH CONTRAST : Pressing + or - selects one of the three modes: AUTO, MODE1, or MODE2.
Normally set to AUTO. MODE1 is used for the high contrast mode. This mode is recommended for graphics display.

MODE2 is used for the wide video band mode. This mode is recommended for text display.

AUTO automatically selects either the high contrast mode for horizontal frequencies of less than 40 kHz, or the wide band video mode for 40 kHz or over.

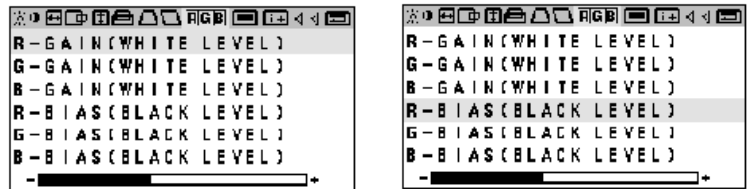

Pressing the PROCEED key proceeds to the RGB gain and bias adjustment. This adjustment allows you to adjust the white balance.

R, G, B-GAIN : Pressing + or - increases or decreases the gain level for each color.

R, G, B-BIAS : Pressing + or - increases or decreases the bias level for each color.

OSM Location/OSM Turn Off Time Control

You can choose where you would like OSM image to appear on your screen. Selecting OSM location allows you to manually adjust the OSM menu left, right, up, or down. The OSM menu will stay on as long as it is in use. In the OSM Turn Off Time submenu, you can select how long the monitor waits after the last touch of a key to shut off the OSM menu. The preset choices are 5, 10, 30, and 120 seconds. Note that 30 seconds is the factory preset.

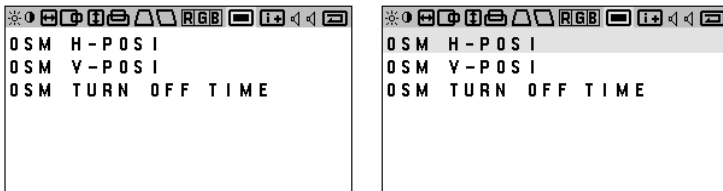

OSM H-POS I : Pressing + or - moves the OSM menu right or left.

OSM V-POS I : Pressing + or - moves menu up or down.

OSM TURN OFF TIME : Pressing + or - selects the preset time in increasing or decreasing order.

Source Information

Source Information provides you information about the current resolution display and technical data including the horizontal and vertical frequency.

NOTE: These adjustments are for RGB mode only.

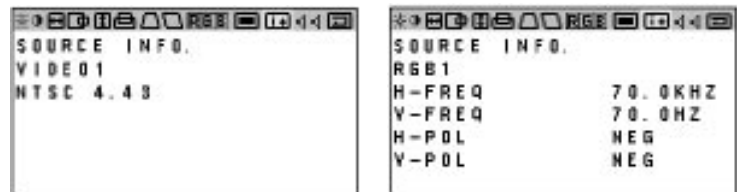

H-FREQ : indicates the horizontal frequency of the current input signal.

V-FREQ : indicates the vertical frequency of the current input signal.

H-POL : indicates the polarity of the horizontal sync. signal.

V-POL : indicates the polarity of the vertical sync. signal.

NEG : indicates the polarity is negative.

POS : indicates the polarity is positive.

Volume Control

The Volume control allows you to adjust the volume.



VOLUME : Pressing + or - increases or decreases the volume.

NOTE: When you mutes the sound, the MUTE display appears.

Reset Control

The Reset control allows you to return image parameters to factory presets.

All Raster Settings

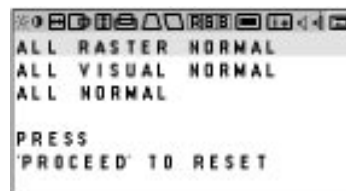

The above warning statement will appear to confirm that you do want to reset all raster settings. If you want to reset all raster settings, press PROCEED.

The following items can be reset:

H-POSI, H-WIDTH, PIN-CUSHION, PIN-BALANCE, PIN-CORNER, V-POSI, V-HEIGHT, V-LIN1, V-LIN2, KEYSTONE, TILT and ROTATION.

All Visual Settings

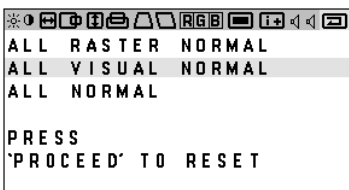

The above warning statement will appear to confirm that you do want to reset all visual settings. If you want to reset all visual settings, press PROCEED.

The following items can be reset:

BRIGHTNESS, CONTRAST, COLOR, TINT, SHARPNESS, COLOR TEMP., R-GAIN, G-GAIN, B-GAIN, R-BIAS, G-BIAS, and B-BIAS.

Specific Item Settings

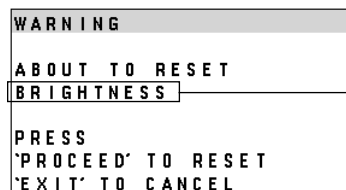

Specific adjustment item to be reset.

The above warning statement will appear to confirm that you do want to reset individual settings.

NOTE:

- In addition to OSM controls, adjustments can be directly accessed with the remote control keys. When adjusting with the remote control keys, the on-screen display for the related adjustment appears instead of the OSM menu.
- When OSM ON/OFF is set at OFF in the System Control menu(see below), OSM controls are not available while the remote control direct access is possible.

OSM System Control Menu

The OSM System control menu allows you to set a various conditions of the monitor.

NOTE: This control is available only when No. 8 pin of the DIP switch is set at the ON position. The DIP switch is located on the back cabinet.

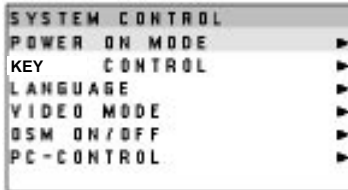

OSM keys on the remote control unit function as follows:

POSITION CONTROL up/down : highlights one of the control items in the System control menus.

POSITION CONTROL + : proceeds to the selected menu choice.

POSITION CONTROL - : exits the current control and returns to its original System control menus.

EXIT : exits the OSM controls.

POWER ON MODE

This control allows you to set the monitor to default to any one of its inputs each time the monitor is turned on.

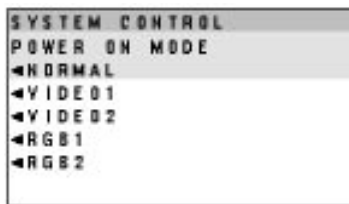

FRONT CONTROL

This control allows you to disable the keys on the front panel such as PROCEED, EXIT, VIDEO 1, VIDEO 2, RGB 1, RGB 2, down, up, -, and +. If you accidentally hit any one of the buttons, it does not affect the monitor.



OSM windows have the following elements:

Right-oriented delta symbol : indicates further choices are available. Use the up or down keys to highlight the item. Pressing ► proceeds to the selected control screen.

Left-oriented delta symbol : indicates that you can exit the current control. Pressing ◀ returns you to its original System control menus.

LANGUAGE

OSM menus are available in six languages: English, German, French, Spanish, Italian, and Swedish.



VIDEO MODE

This control allows you to select the NTSC, PAL, or SECAM video standard. Normally select AUTO.

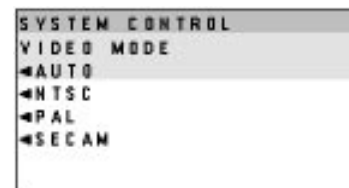

OSM ON/OFF

This control allows you to enable the OSM control.

The OSM control is available when ON is selected. When the OSM does not appear, the visual and raster controls are available with the remote control.

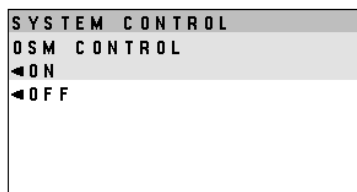

PC-CONTROL

This control allows you to activate the PC-control function.

For more information see the following pages.

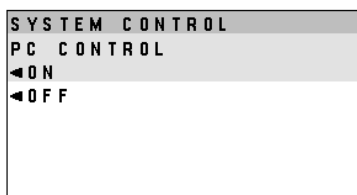

PC/External Control Function

PC/External Control Port Pin Assignments

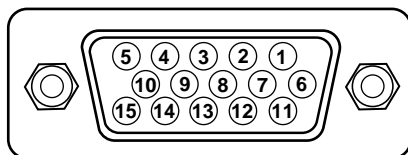

D-SUB 15pin (Input/Output)

Pin No.	Signal Name	
1	No Connection	
6	Receive Data	
2	No Connection	
7	Transmit Data	
11	No Connection	
12	Clear to Send	
3	No Connection	
8	Request to Send	
9	Ground	
4	Input Select	EXT-CTL
5	Input Select	EXT-CTL
10	Power ON/OFF	EXT-CTL
13	No Connection	
14	Degauss ON/OFF	EXT-CTL
15	Signal Ground	

NOTE: If EXT.CTL is set to ON, only EXT.CTL will be effective for the above functions.

If EXT.CTL is set to OFF, PC CTL will be effective. Pin No.8 is connected to pin No. 12.

External Control

Pin No.	4	5	10	14
VIDEO1	OPEN	OPEN	-	-
VIDEO2	GND	OPEN	-	-
RGB1	OPEN	GND	-	-
RGB2	GND	GND	-	-
POWER OFF	-	-	OPEN	-
POWER ON	-	-	GND	-
DEGAUSS OFF	-	-	-	OPEN
DEGAUSS ON	-	-	-	GND

Command reference

You can control the main functions from external equipment such as personal computer using the PC/EXT CTL terminals. The following sections explain the interface.

Interface Condition

- RS-232C
- Baud rate ----- 9600 bps
- Data length ----- 8 bits
- Parity ----- Odd parity
- Stop bit ----- 1 bit
- Communications mode ----- Full duplex

Control Data Format

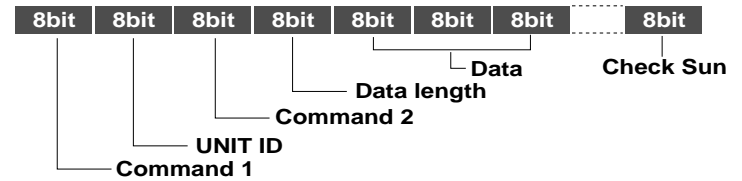

Command 1 Code based on the command system

UNIT ID Code allocated to each equipment (Allocate 80H to the XP29 Plus/XM29 Plus)

Command 2 Code allocated to the main functions of the XP29 Plus/XM29 Plus

Data Length Number of bytes of the data that is transmitted

Data Data transmitted

Check Sum Lower eight digits of sum total of the first byte to the byte immediately before the last.

Command Communication Sequence

When external equipment such as a personal computer gives the command to the XP29 Plus/XM29 Plus, the XP29 Plus/XM29 Plus returns an ACK. So make sure that the external equipment receives this ACK.

Command sending/receiving sequence

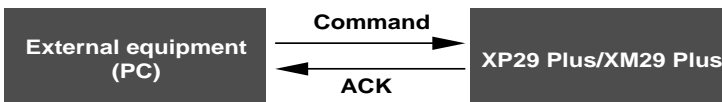

The XP29 Plus/XM29 Plus returns an ACK if it has received the command correctly.

If it has not received the command correctly due to data error, it will return nothing. Therefore, when the external equipment send a command, make sure that it received the ACK.

PC CONTROL COMMAND LIST FOR USE WITH THE XP29 Plus/XM29 Plus

PC → XP29 Plus/XM29 Plus

COM1	COM2	Contents	Length
9F	4E	Power On	00
	4F	Power Off	00
	A1	Degauss Control	00

XP29 Plus/XM29 Plus → PC

COM1	COM2	Contents	Length
3F	4E	Power On (ACK)	00
	4F	Power Off (ACK)	00
	B0	Input Switching (ACK)	00
7F	A1	Degauss Control(ACK)	01

Example: Input switching (VIDEO 1) from the PC to the XP29 Plus/XM29 Plus (when the address selector equals 0)

PC → XP29 Plus/XM29 Plus

COM1	UA	COM2	Length	Data 1	Data 2	Sum
DF	80	B0	02	00	VIDEO1 : 01	12
					VIDEO2 : 02	13
					RGB1 : 03	14
					RGB2 : 04	15

XP29 Plus/XM29 Plus → PC

COM1	UA	COM2	Length	Data 1
3F	80	B0	00	6F

Troubleshooting

Before arranging for service by the NEC Service Center, check the following to be sure repairs are needed.

Problem	Possible Cause	Correction
No Picture or Sound	Power cord unplugged. Power outlet inactive. Power of external equipment is not ON. External equipment has been incorrectly connected. Incorrect input selection.	Plug in power cord. Be sure wall switch is on and outlet has power. Switch to ON or connect to an active AC outlet. Correct all connections. Press correct RGB1, RGB 2, VIDEO 1 or VIDEO 2 button.
Sound OK; poor picture with VIDEO signal input.	Improper control setting. Local interference. Cable interconnections. Input impedance is not correct level.	Adjust picture controls as needed. Try another location for the monitor. Be sure all connections are secure. Check 75 ohm high impedance select switch.
Sound OK; poor picture with RGB signal input.	Improper control setting. Incorrect 15 PIN connector pin connections.	Adjust picture controls as needed. Check pin assignments and connections.
Picture OK; poor or no sound.	Cable interconnections. Volume is not adjusted. Poor audio connections from external source. Improper control settings. MUTE key is ON.	Be sure all connections are secure. Adjust volume. Correct audio connections. Adjust volume controls. Press again to restore sound.
Poor sound from external speakers or stereo system speakers	Cable interconnections. Improper volume setting.	Secure all cable connections. Check volume controls of all components.
Remote control does not work.	Weak batteries. Obstacle between Remote Control and Sensor Window. (Wireless) You are not within the effective operating range. (Wireless) Incorrect setting of No. 7 pin of the DIP SW. (Wireless) When in the EXT. CONTROL mode, the remote control unit will not operate the monitor.	Install new batteries. Point remote control directly at Sensor Window. Use the remote control unit within 30° left and right of center (at a distance of within 22ft). Set Pin no. 7 of DIP SW to ON/OPEN. Set Pin no.6 of DIP SW to OFF/SHORT.
STANDBY/POWER indicator is blinking	Horizontal and/or vertical sync signal is not present when the Intelligent Power Manager control is on.	Check the input signal.

In the following case, power off the monitor immediately and contact your dealer or authorized NEC Service Center.

The monitor turns off in 5 seconds after powering on and then the STANDBY/POWER indicator blinks in one second intervals. It indicates that the power supply circuit or, one or more fans have been damaged.

Specifications

Picture tube	27 inch Visual size; 29 inch CRT size (Diagonal), Type A68 108 degree deflection Stripe trio pitch Ph 0.60 mm at center, Ph 0.78 mm at corner/Pv 0.56 mm Invar mask, Medium-short persistence phosphor Anti-static electricity coating Optical filter coating Dynamic focus
RGB Input Terminals	RGB 1 : D-SUB 15pin/mini D-SUB 15pin RGB 2: (R, G, B, H and V) : Video : Analog 0.7Vp-p/75 Ohms (Positive) : Sync. : Separate Sync. TTL level, 0.7 - 4.0Vp-p/75 Ohms.....RGB 2 only Horizontal Sync. (Positive/Negative) Vertical Sync. (Positive/Negative) : Composite Sync. TTL Level (Positive/Negative) : Composite Sync. On Green Video 0.3Vp-p (Negative)
RGB Output Terminals THROUGH OUT	RGB 1 : D-SUB 15 pin/mini D-SUB 15 pin RGB 2 : BNC (R, G, B, H and V)
Video Input Terminals VIDEO 1/2 S-VIDEO (Video 1/2)	1.0Vp-p, 75 Ohms unbalanced (BNC-Jack), Composite video signal, Sync-negative. Y : 1.0Vp-p, 75 Ohms unbalanced, Sync-negative. C : 0.28Vp-p, 75 Ohms unbalanced, Color burst level.

Video Output Terminals THROUGH OUT (Video 1, 2) THROUGH OUT (S-VIDEO 1, 2)	1.0Vp-p, 75 Ohms unbalanced (BNC Jack), Composite video signal, Sync-negative. Y : 1.0Vp-p, 75 Ohms unbalanced, Sync-negative. C : 0.28Vp-p, 75 Ohms unbalanced, Color burst level.
Audio Input Terminals VIDEO 1, 2 / RGB	Left (Mono) : 0.5 Vrms, high impedance (Pin-Jack) Right : 0.5Vrms, high impedance (Pin-Jack)
Audio Output Terminals THROUGH OUT	Left : 0.5 ± 0.1 Vrms, less than 22 K Ohms (Pin-Jack) Right : 0.5 ± 0.1 Vrms, less than 22 K Ohms (Pin-Jack)
External Control (IN/THROUGH OUT)	mini D-SUB 15pin (IN/THROUGH OUT)
SOUND Output Internal External	2.5W+2.5W (THD 10%) at 16 Ohm 5W+5W (THD10%) at 8 Ohm
Speaker	Oval type 9 X 5.5 cm 16 Ohm, 2pcs.
Display Colors	Analog Input: Unlimited colors
Synchronization Range	Horizontal: XP29Plus; 15.7/31 KHz to 95 KH XM29Plus; 15.7/31 KHz to 65 KHz (Automatically) Vertical:40 Hz to 120 Hz (Automatically)

Maximum Resolution	RGB 1024(H) x 768(V) pixels VIDEO Horizontal: 500 lines /S-VIDEO Horizontal : 600 lines
Video Bandwidth	RGB: 60 MHz at-3dB (Note that source is RGB2 and in HIGH CONTRAST, MODE2 or AUTO at 40 kHz or over is selected.)
Display Area	VIDEO: 5 MHz at-3dB RGB : 95% Scan (Typically)
Retrace Time	VIDEO: 7% Overscan Horizontal: 15.75KHz; 10μsec, 31KHz<fH<66KHz; 3.6μsec, 66KHz<fH; 2.7μsec Vertical: 0.4 msec
Current Rating	AC 100-120 V/220-240 V, 50/60 Hz
Power Consumption	XP29 Plus(XP-2990): 3.5 A (maximum) / XM29 Plus(XM-2960): 3.5A (maximum)
Dimensions	645(W) x 533(H) x 518(D) mm / 25.4(W)X21(H)X20.4(D) inches
Weight	53.5 kg / 118.0 lbs
Environmental Considerations	Operating Temperature : 0 to 40 Humidity : 0 to 90% Altitude : 0 to 10,000 feet Storage Temperature : -10 to 50 Humidity : 0 to 95% Altitude : 0 to 45,000 feet

Regulations :	UL Approved (UL 1950) CSA certified Meets FCC class A requirements Meets DHHS requirements
----------------------	---

All specifications are subject to change without notice.

Dimensions

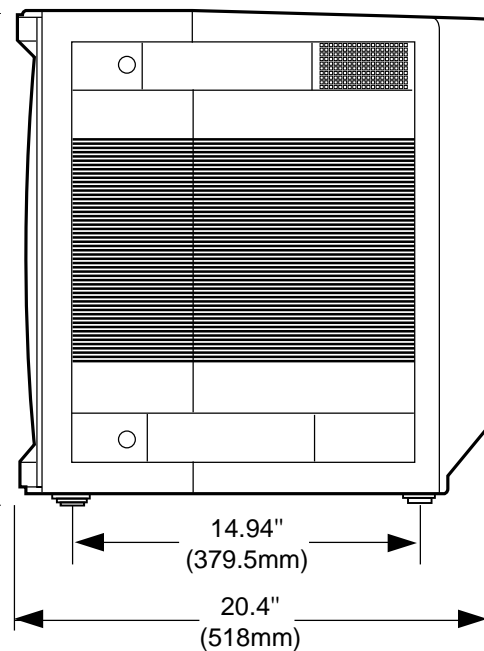
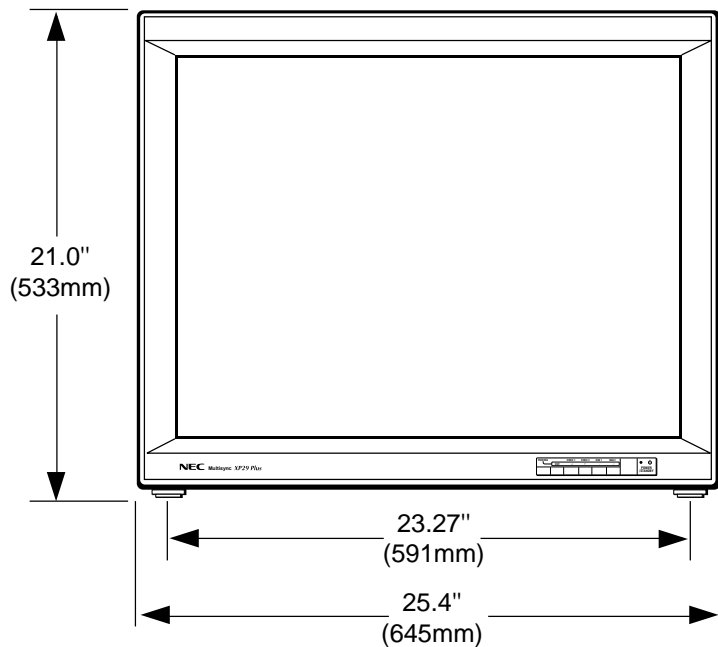
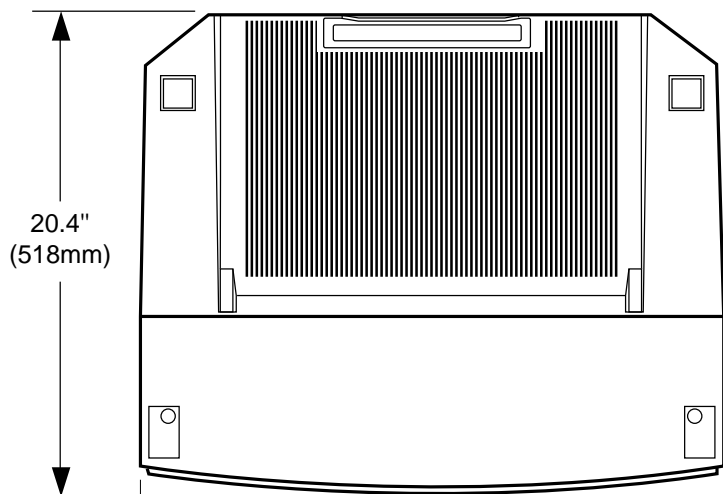

Timing Charts

Input Signal Reference Chart

Separate Sync.

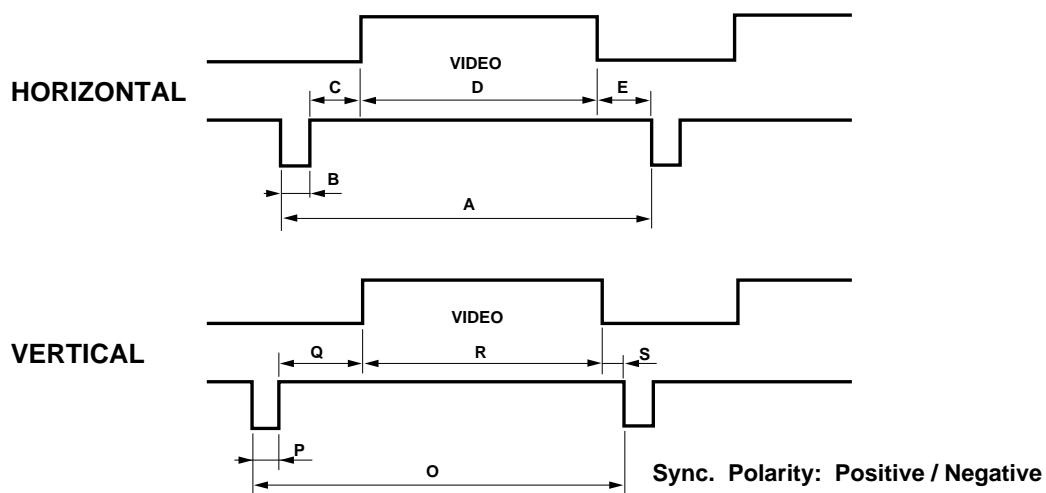

Composite Sync.

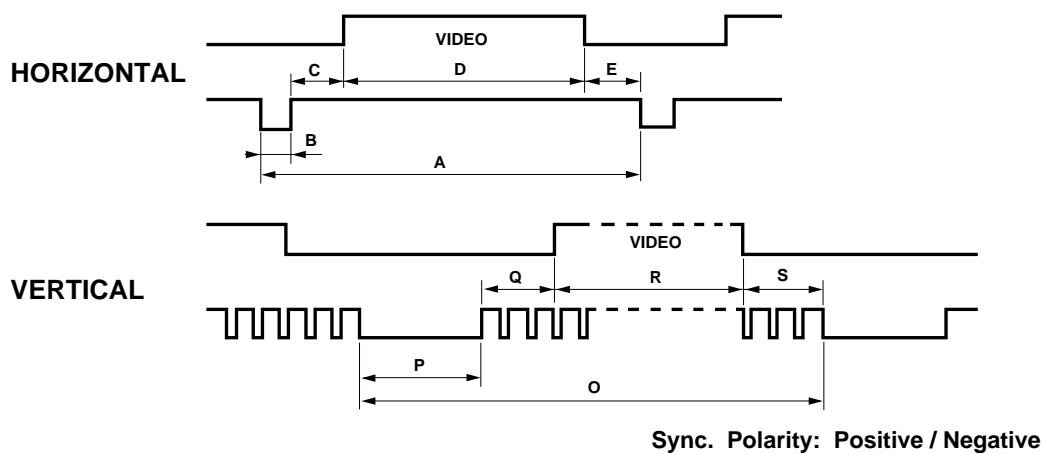

Composite Sync. & Video (Sync. on Green)

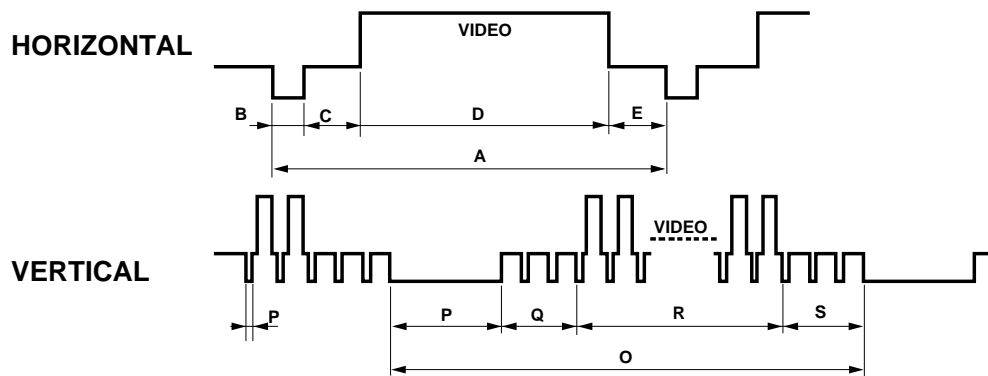

Recommended Sync Signal Timing

Sync. Polarity: Negative

Horizontal Duty should be 3 to 30%.

Horizontal sync width should exceed 0.9 μ sec.

Horizontal back porch should exceed 2.0 μ sec at sync on green and 1.2 μ sec at others except when at 15KHz.

Horizontal blanking should exceed: 15.75; 10 μ sec, 31KHz < fH < 66KHz: 3.6 μ sec, 66KHz < fH: 2.7 μ sec.

Vertical Duty should be 0.2 to 10%.

Vertical sync width should exceed 40 μ sec or 2 horizontal lines.

Vertical sync width plus back porch should exceed 0.4 msec.

Interlaced signals are not recommended.

Interlaced signals with composite sync may not be displayed.

Typical Input Signal Timing

	VGA Compatible			XGA-2 Compatible			Mac II Quadra, or LC Compatible
	640 -350	720 -400	640 -480	720 -350	720 -400	640 -480	640 -480
Resolution	640 -350	720 -400	640 -480	720 -350	720 -400	640 -480	640 -480
Horizontal Frequency	31.469KHz	31.469KHz	31.469KHz	39.444KHz	39.444KHz	39.375KHz	35.000KHz
(A) Horizontal Period	31.778μsec	31.778μsec	31.778μsec	25.352μsec	25.352μsec	25.397μsec	28.570μsec
(B) Horizontal Pulse Width	3.813μsec	3.813μsec	3.813μsec	3.042μsec	3.042μsec	3.048μsec	2.120μsec
(C) Horizontal Back Porch	1.589μsec	1.589μsec	1.589μsec	1.522μsec	1.522μsec	1.524μsec	3.170μsec
(D) Horizontal Active Area	26.058μsec	26.058μsec	26.058μsec	20.282μsec	20.282μsec	20.317μsec	22.810μsec
(E) Horizontal Front Porch	0.318μsec	0.318μsec	0.318μsec	0.508μsec	0.508μsec	0.508μsec	0.180μsec

	VESA 640 -480 at 72Hz	VESA 800 -600 at 56Hz	VESA 800 -600 at 60Hz	VESA 800 -600 at 72Hz	MAC II & Quadra	8514/A & XGA Interlaced Compatible	VESA 1024 -768 at 60Hz
Resolution	640 -480	800 -600	800 -600	800 -600	832 -624	1024 -768	1024 -768
Horizontal Frequency	37.860KHz	35.156KHz	37.879KHz	48.077KHz	49.725KHz	35.587KHz	48.363KHz
(A) Horizontal Period	26.413μsec	28.444μsec	26.400μsec	20.800μsec	20.111μsec	28.100μsec	20.677μsec
(B) Horizontal Pulse Width	1.270μsec	2.000μsec	3.200μsec	2.400μsec	1.117μsec	3.910μsec	2.092μsec
(C) Horizontal Back Porch	4.063μsec	3.556μsec	2.200μsec	1.280μsec	3.910μsec	1.247μsec	2.462μsec
(D) Horizontal Active Area	20.317μsec	22.222μsec	20.000μsec	16.000μsec	14.524μsec	22.760μsec	15.754μsec
(E) Horizontal Front Porch	0.762μsec	0.667μsec	1.000μsec	1.120μsec	0.559μsec	0.178μsec	0.369μsec

*VGA, XGA, XGA-2, and 8514/A are the trademarks of International Business Machines Corporation.

*Macintosh II, Quadra, and LC are the trademarks of Apple Computer Inc.

*VESA is the trademark of a non-profit organization, Video Electronics Standards Association.

	VGA Compatible			XGA-2 Compatible			Mac ı Quadra, or LC Compatible
	640 -350	720 -400	640 -480	720 -350	720 -400	640 -480	640 -480
Resolution	640 -350	720 -400	640 -480	720 -350	720 -400	640 -480	640 -480
Vertical Frequency	70.080Hz	70.080Hz	59.940Hz	87.850Hz	87.850Hz	75.000Hz	66.667Hz
(O) Vertical Period	14.268msec	14.268msec	16.683msec	11.383msec	11.383msec	13.333msec	15.000msec
(P) Vertical Pulse Width	0.064msec	0.064msec	0.064msec	0.051msec	0.051msec	0.051msec	0.090msec
(Q) Vertical Back Porch	1.716msec	0.890msec	0.793msec	1.496msec	0.862msec	0.813msec	1.110msec
(R) Vertical Active Area	11.504msec	13.156msec	15.762msec	8.873msec	10.141msec	12.190msec	13.710msec
(S) Vertical Front Porch	0.985msec	0.159msec	0.064msec	0.963msec	0.329msec	0.279msec	0.090msec

	VESA 640 -480 at 72Hz	VESA 800 -600 at 56Hz	VESA 800 -600 at 60Hz	VESA 800 -600 at 72Hz	MAC ı & Quadra	8514/A & XGA Interlaced Compatible	VESA 1024 -768 at 60Hz
Resolution	640 -480	800 -600	800 -600	800 -600	832 -624	1024 -768	1024 -768
Vertical Frequency	72.809Hz	56.250Hz	60.317Hz	72.187Hz	74.550Hz	86.960Hz	60.000Hz
(O) Vertical Period	13.735msec	17.778msec	16.579msec	13.853msec	13.414msec	11.499msec	16.667msec
(P) Vertical Pulse Width	0.079msec	0.057msec	0.106msec	0.125msec	0.060msec	0.112msec	0.124msec
(Q) Vertical Back Porch	0.740msec	0.626msec	0.607msec	0.478msec	0.784msec	0.577/0.563msec	0.600msec
(R) Vertical Active Area	12.678msec	17.067msec	15.840msec	12.480msec	12.549msec	10.824msec	15.880msec
(S) Vertical Front Porch	0.238msec	0.028msec	0.026msec	0.770msec	0.020msec	0.000/0.014msec	0.062msec

Signal Identification for Raster Preset

MODE	Polarity		State		Frequency		NEC	USER	REMARKS
	Hor	Ver	Hor	Ver	Hor	Ver	PRESET	PRESET	
MODE1 15.5-16.0KHz	-	-	-	-	-	-	YES-1	YES-1	NTSC
								YES-2	RGB 15kHz
							YES-2	YES-3	PAL/SECAM
MODE2 30-32.5KHz	NEG	NEG	-(H)	-(H)	-	-	YES-3	YES-4	VESA I-Standard 640x480(31.5KHz/60Hz)
	POS	POS	-(H)	-(H)	-	-	-	YES-4	-
	POS	NEG	H	H	-	-	-	YES-5	IBM 640x350(31.5KHz/71Hz)
	NEG	POS	H	H	-	-	-	YES-6	IBM 640x400(31.5KHz/71Hz)
MODE3 32.5-34.4KHz	(NEG)	(NEG)	-(H)	-(H)	-	-	-	YES-7	HDTV(33.75KHz/60Hz)
	-	-	-	-	-	-	-	-	-
MODE4 34.4-36.5KHz	(POS)	(POS)	H	H	-	80 or less	-	YES-8	VESA 800x600 (35.1KHz/56Hz)
						80 or greater	-	YES-9	VESA I-Standard 1024x768 (35.5KHz/87Hz)
	-	-	-	L	-	-	YES-4	YES-10	MAC 640x480(35KHz/67Hz)
MODE5 36.5-42KHz	NEG	(NEG)	H	H	-	-	YES-5	YES-11	VESA 640x480(37.5KHz/75Hz)
	POS	NEG	H	H	-	-	-	YES-11	-
	POS	POS	H	H	-	-	-	YES-12	VESA 800x600(37.9KHz/60Hz)
	-	-	-	L	-	-	-	YES-13	REUTER 640x480(38.4KHz/72Hz)
MODE6 42-45KHz	-	-	-	-	-	-	-	YES-14	VESA 640x480 (43.3kHz/85Hz)
MODE7 45-49KHz	NEG	(NEG)	H	H	-	-	YES-6	YES-14	VESA 1024x768 (48.4KHz/60Hz)
	POS	NEG	H	H	-	-	-	YES-14	-
	POS	POS	H	H	-	-	-	YES-15	VESA 800x600(46.9KHz/75Hz)
	-	-	-	L	-	-	-	YES-16	REUTER 800x600 (48.1KHz/72Hz)
MODE8 49-51kHz	(NEG)	(NEG)	H	H	-	-	-	YES-17	H-98 1120x750 (50.0KHz/60.1Hz)
	-	-	-	L	-	-	YES-7	YES-18	MAC 832x624 (49.7KHz/75Hz)
MODE9 51-57.5KHz	(NEG)	(NEG)	(H)	(H)	-	-	YES-8	YES-19	VESA 1024x768 (56.5KHz/70Hz)
MODE10 57.5-62KHz	(POS)	(POS)	H	H	-	-	YES-9	YES-20	VESA 1024x768 (60.0KHz/75Hz)
	-	-	-	L	-	-	-	YES-21	MAC 1024x768 (60.2KHz/75Hz)
MODE11 62-70KHz	(NEG)	(NEG)	(H)	H	-	-	-	YES-22	VESA 1280x1024 (64.6KHz/60Hz)
	-	-	-	-	-	-	-	YES-22	VESA 1024x768 (68.7kHz/85Hz)
	-	-	-	L	-	-	YES-10	YES-23	MAC 1152x870 (68.7KHz/75Hz)
MODE12 70-79KHz	-	-	-	-	-	-	-	YES-24	VESA 1600x1200 (75kHz/60Hz)
MODE13 79-83KHz	(POS)	(POS)	(H)	(H)	-	-	YES-11	YES-24	VESA 1280x1024 (80.0KHz/75Hz)
MODE14 83-89.5KHz	-	-	-	-	-	-	-	YES-25	VESA 1600x1200 (87.5kHz/70Hz)
MOE15 89.5-95KHz	(POS)	(POS)	(H)	(H)	-	-	YES-12	YES-25	VESA 1600x1200 (93.8KHz/75Hz)

NOTE:

L=NEG.SYNC

H=POS.SYNC

"-" or "()" =ignored

Factory:12 (9 preset for XM29 Plus)

User:25 (22 preset for XM29 Plus)

The modes 11(VESA 1024x768 and MAC 1152x870) and 12 to 15 apply to XP29 Plus only.

Service and Support Policies

NEC Technologies is committed to providing the highest quality service and support for your MultiSync presentation monitor. A customer service group that is dedicated to the support of this product line is available to provide a single point of contact for technical support, trouble shooting, service and repair issues.

Please address all questions concerning the following subjects to the phone number listed below:

- For technical support or any questions concerning the operation of this product.
- To arrange for on-site repair service during the warranty period or after its expiration.
- For the location of your nearest authorized NEC service center.
- To report a DOA product and verify its status for return authorization.

1-800-836-0655

Due to the size and weight of large screen presentation monitor products, it is preferable to solve problems on-site rather than to incur the expense and risk of damage in return shipping. NEC's service policies and procedures make it as effortless as possible for you to receive factory authorized and trained service at your location.

Eligibility/Return for Exchange Procedure

If a product is suspected of being DOA, customers must call NECTECH VSD Technical Support. A representative will assist in making the product fully functional or verify it as a DOA.

VSD Technical Support 1-800-836-0655
NEC technical support will provide a procedure for repair instead of exchange.

If the product is determined to be DOA, the Technical Support Representative will request the following information in order to issue a Material Return Authorization (MRA) number:

- Product model number
- Serial number
- A complete description of the problem

If approved, an MRA number and return address will be issued. All product to be returned must be shipped freight pre-paid in its original carton to a designated NECTECH facility. The customer assumes the risk of loss. The defective product must be received by NECTECH within 21 calendar days from the date the MRA was issued.

Any questions concerning service and repair policies or procedures can also be addressed in writing to:

NEC Technologies
 Visual Systems Division
 Customer Service
 1250 North Arlington Heights Road
 Itasca, Illinois 60143

On-site Service/Repair Policy

NEC offers on-site service and repair for all of our MultiSync presentation monitor products of 29" and larger screen size. Warranty repair is provided by our service-authorized Visual Systems Division Dealers and network of factory-trained independent service providers. If you are experiencing a problem with your monitor, please contact the authorized NEC Visual Systems Division dealer from which it was purchased. If this is a reseller who is unable to provide service, call NEC directly at **1-800-836-0655**.

DOA Policy

A product is considered DOA if it fails to function according to current published specifications because of defects in NECTECH factory materials and/or workmanship during the first 30 days from the date of purchase by the end user. After the 30 day period any defective product will be considered a warranty repair.

A product is NOT considered DOA if it is functional but the box is damaged or it is missing contents such as manuals, cables, etc.

NECTECH reserves the right to repair rather than replace any product.

Free Manuals Download Website

<http://myh66.com>

<http://usermanuals.us>

<http://www.somanuals.com>

<http://www.4manuals.cc>

<http://www.manual-lib.com>

<http://www.404manual.com>

<http://www.luxmanual.com>

<http://aubethermostatmanual.com>

Golf course search by state

<http://golfingnear.com>

Email search by domain

<http://emailbydomain.com>

Auto manuals search

<http://auto.somanuals.com>

TV manuals search

<http://tv.somanuals.com>