

PlasmaSync Plasma Monitor

PlasmaSyncTM 4210 W

User's Manual



NEC

NEC Technologies

Important Information

Precautions

Please read this manual carefully before using your NEC PlasmaSync - 42inch Plasma Monitor PX-42M5A and keep the manual handy for future reference.

CAUTION



**RISK OF ELECTRIC SHOCK
DO NOT OPEN**



CAUTION: TO REDUCE THE RISK OF ELECTRIC SHOCK, DO NOT REMOVE COVER. NO USER-SERVICEABLE PARTS INSIDE. REFER SERVICING TO QUALIFIED SERVICE PERSONNEL.

This symbol warns the user that uninsulated voltage within the unit may have sufficient magnitude to cause electric shock. Therefore, it is dangerous to make any kind of contact with any part inside of this unit.

This symbol alerts the user that important literature concerning the operation and maintenance of this unit has been included. Therefore, it should be read carefully in order to avoid any problems.

WARNING

TO PREVENT FIRE OR SHOCK HAZARDS, DO NOT EXPOSE THIS UNIT TO RAIN OR MOISTURE. ALSO DO NOT USE THIS UNIT'S POLARIZED PLUG WITH AN EXTENSION CORD RECEPTACLE OR OTHER OUTLETS, UNLESS THE PRONGS CAN BE FULLY INSERTED. REFRAIN FROM OPENING THE CABINET AS THERE ARE HIGH-VOLTAGE COMPONENTS INSIDE. REFER SERVICING TO QUALIFIED SERVICE PERSONNEL.

DOC compliance Notice

This Class A digital apparatus meets all requirements of the Canadian Interference-Causing Equipment Regulations.

WARNING

This equipment has been tested and found to comply with the limits for a Class A digital device, pursuant to Part 15 of the FCC Rules. These limits are designed to provide reasonable protection against harmful interference when the equipment is operated in a commercial environment. This equipment generates, uses, and can radiate radio frequency energy and, if not installed and used in accordance with the instruction manual, may cause harmful interference to radio communications. Operation of this equipment in a residential area is likely to cause harmful interference in which case the user will be required to correct the interference at his own expense.

Warnings and Safety Precaution

The NEC PlasmaSync 4210W is designed and manufactured to provide long, trouble-free service. No maintenance other than cleaning is required. Use a soft dry cloth to clean the panel. Never use solvents such as alcohol or thinner to clean the panel surface.

The plasma display panel consists of fine picture elements (cells). Although NEC produces the plasma display panels with more than 99.99 percent active cells, there may be some cells that do not produce light or remain lit.

For operating safety and to avoid damage to the unit, read carefully and observe the following instructions. To avoid shock and fire hazards:

1. Provide adequate space for ventilation to avoid internal heat build-up. Do not cover rear vents or install in a closed cabinet or shelves.
The unit is equipped with cooling fans. If you install the unit in an enclosure, be sure there is adequate space at the top of the unit to allow hot air to rise and escape. If the monitor becomes too hot, the overheat protector will be activated and the monitor will be turned off. If this happens, turn off the power to the monitor and unplug the power cord. If the room where the monitor is installed is particularly hot, move the monitor to a cooler location, and wait for the monitor to cool for 60 minutes. If the problem persists, contact your NEC dealer for service.
2. Do not use the power cord polarized plug with extension cords or outlets unless the prongs can be completely inserted.
3. Do not expose unit to water or moisture.
4. Avoid damage to the power cord, and do not attempt to modify the power cord.
5. Unplug unit during electrical storms or if unit will not be used over a long period.
6. Do not open the cabinet which has potentially dangerous high voltage components inside. If the unit is damaged in this way the warranty will be void. Moreover, there is a serious risk of electric shock.
7. Do not attempt to service or repair the unit. NEC is not liable for any bodily harm or damage caused if unqualified persons attempt service or open the back cover. Refer all service to authorized NEC Service Centers.

To avoid damage and prolong operating life:

1. Use only with 120V 50/60Hz AC power supply. Continued operation at line voltages greater than 120 Volts AC will shorten the life of the unit, and might even cause a fire hazard.
2. Handle the unit carefully when installing it and do not drop.
3. Locate set away from heat, excessive dust, and direct sunlight.
4. Protect the inside of the unit from liquids and small metal objects. In case of accident, unplug the unit and have it serviced by an authorized NEC Service Center.
5. Do not hit or scratch the panel surface as this causes flaws on the surface of the screen.
6. For correct installation and mounting it is strongly recommended to use a trained, authorized NEC dealer.
7. As is the case with any phosphor-based display (like a CRT monitor, for example) light output will gradually decrease over the life of a Plasma Display Panel.

Recommendations to avoid or minimize phosphor burn-in

Like all phosphor-based display devices and all other gas plasma displays, PlasmaSync monitors can be susceptible to phosphor burn under certain circumstances. Certain operating conditions, such as the continuous display of a static image over a prolonged period of time, can result in phosphor burn if proper precautions are not taken. To protect your investment in this NEC PlasmaSync monitor, please adhere to the following guidelines and recommendations for minimizing the occurrence of image burn:

- * Always enable and use your computer's screen saver function during use with a computer input source.
- * Display a moving image whenever possible.
- * Always power down the monitor when you are finished using it.

If the PlasmaSync monitor is in long term use or continuous operation take the following measures to reduce the likelihood of phosphor burn:

- * Lower the Brightness and Contrast levels as much as possible without impairing image readability.

- * Display an image with many colors and color gradations (ie. photographic or photo-realistic images).
- * Create image content with minimal contrast between light and dark areas, for example white characters on black backgrounds. Use complementary or pastel color whenever possible.
- * Avoid displaying images with few colors and distinct, sharply defined borders between colors.

Contact NEC Technologies at 1-800-836-0655 for other recommended procedures that will best suit your particular application needs.

Précautions

Veillez lire ce manuel avec attention avant d'utiliser votre PlasmaSync NEC - Moniteur Plasma 42 pouces PX-42M5A et conserver ce manuel à portée de la main pour une consultation ultérieure.

ATTENTION



**RISQUE D'ELECTROCUTION
NE PAS OUVRIR**



MISE EN GARDE: AFIN DE REDUIRE LES RISQUES D'ELECTROCUTION, NE PAS DEPOSER LE COUVERCLE, IL N'Y A AUCUNE PIECE UTILISABLE A L'INTERIEUR DE CET APPAREIL. NE CONFIER LES TRAVAUX D'ENTRETIEN QU'A UN PERSONNEL QUALIFIE.

 Ce symbole a pour but de prévenir l'utilisateur de la présence d'une tension dangereuse, non isolée se trouvant à l'intérieur de l'appareil. Elle est d'une intensité suffisante pour constituer un risque d'électrocution. Eviter le contact avec les pièces à l'intérieur de cet appareil.

 Ce symbole a pour but de prévenir l'utilisateur de la présence d'importantes instructions concernant l'entretien et le fonctionnement de cet appareil. Par conséquent, elles doivent être lues attentivement afin d'éviter des problèmes.

AVERTISSEMENT

AFIN DE REDUIRE LES RISQUES D'INCENDIE OU D'ELECTROCUTION, NE PAS EXPOSER CET APPAREIL A LA PLUIE OU A L'HUMIDITE. AUSSI, NE PAS UTILISER LA FICHE POLARISEE AVEC UN PROLONGATEUR OU UNE AUTRE PRISE DE COURANT SAUF SI CES LAMES PEUVENT ETRE INSEREES A FOND. NE PAS OUVRIR LE COFFRET, DES COMPOSANTS HAUTE TENSION SE TROUVENT A L'INTERIEUR. LAISSER A UN PERSONNEL QUALIFIE LE SOIN DE REPARER CET APPAREIL.

DOC avis de conformation

Cet appareil numérique de la classe A respecte toutes les exigences du Règlement sur le Matériel Brouilleur du Canada.

AVERTISSEMENT

Cet équipement a été testé et certifié conforme avec les limitations des équipements numériques de Classe A, conformément à l'article 8 (du règlement FCC. Ces limites sont conçues pour assurer une protection raisonnable contre les interférences nuisibles lorsque l'équipement est utilisé en milieu commercial. Cet équipement génère, utilise, et peut produire de l'énergie de fréquence radio et, s'il n'est pas installé et utilisé selon le manuel d'instruction, peut provoquer des interférences nuisibles aux communications radio. L'utilisation de cet équipement dans une zone résidentielle est susceptible de provoquer des interférences nuisibles, dans quel cas l'utilisateur est tenu de remédier à ces interférences à ses frais.

Mises en garde et précautions de sécurité

Le moniteur multimédia NEC PlasmaSync 4210W a été conçu et fabriqué pour une utilisation fiable et durable. Il ne nécessite aucun entretien en dehors du nettoyage. Utiliser un chiffon doux et sec pour nettoyer la surface de l'écran. Ne jamais utiliser de solvant comme l'alcool ou le diluant. Le panneau à affichage plasma est constitué de fines particules d'images ou pixels (cellules). Bien que NEC produise des panneaux à affichage plasma avec plus de 99,99 % de cellules actives, il peut y avoir des cellules qui ne produisent pas de lumière ou qui restent allumées. Pour des raisons de sécurité et pour éviter d'endommager l'appareil, lire attentivement les instructions suivantes.

Pour éviter les risques d'électrocution et d'incendie:

1. Laisser suffisamment d'espace autour de l'appareil pour la ventilation et éviter toute augmentation excessive de la température interne. Ne pas couvrir les événements ou l'installer dans un endroit trop exigü. L'appareil est équipé de ventilateurs de refroidissement. Si vous installez l'appareil dans un espace clos, assurez-vous qu'il y ait suffisamment d'espace au dessus pour permettre à l'air chaud de s'élever et de s'évacuer. Si la température du moniteur devient excessive, la protection contre les surchauffes entrera en action et coupera l'alimentation. Dans ce cas, éteindre l'appareil et débrancher le câble d'alimentation. Si la température de la pièce dans laquelle le moniteur est installé est particulièrement excessive, déplacer l'appareil dans un endroit plus frais et le laisser refroidir 60 minutes. Si le problème persiste, prendre contact avec le revendeur NEC pour le service après-vente.
2. Ne pas utiliser la fiche polarisée du cordon d'alimentation avec des prolongateurs ou des prises de courant, sauf si les lames peuvent être insérées à fond.
3. Ne pas exposer à l'eau ou à l'humidité.
4. Eviter d'endommager le cordon d'alimentation, et ne pas modifier le cordon d'alimentation.
5. Débrancher l'appareil pendant les tempêtes ou si l'appareil n'est pas utilisé pendant une longue période.
6. Ne pas ouvrir le coffret. Des composants de haute tension se trouvent à l'intérieur. Si l'appareil est endommagé de cette manière, la garantie devient caduque. De plus, il y a risque d'électrocution.
7. Ne pas essayer de réparer ou entretenir l'appareil soi-même. NEC ne saura être tenu pour responsable pour toute blessure ou dommage causé par des personnes non qualifiées qui essayent de réparer ou d'ouvrir le couvercle arrière. Confier toute réparation à un centre de service agréé NEC.

Pour éviter des dommages et prolonger la durée de service de l'appareil:

1. N'utiliser qu'une source d'alimentation de 120 V 50/60 Hz CA. Le fait d'utiliser l'appareil en continu à des tensions de ligne supérieures à 120 Volts CA réduit sa durée de vie et risque de provoquer un incendie.
2. Manipuler l'appareil avec soin pendant son déplacement et ne pas le faire tomber.
3. Eloigner l'appareil des endroits chauds, très poussiéreux et exposés en plein soleil.
4. Éviter que des liquides et des petits objets métalliques pénètrent à l'intérieur de l'appareil. En cas d'accident, débrancher l'appareil et le confier à un centre de service agréé NEC.
5. Ne pas frapper ou rayer la surface de la écran plasma, car des défauts risquent de se produire sur la surface de la écran plasma.
6. Pour effectuer une installation et un montage corrects, il est recommandé de faire appel au concessionnaire NEC autorisé et spécialisé.
7. Comme c'est le cas pour tout affichage à base de phosphore (comme un moniteur CRT, par exemple), la puissance de lumière baisse graduellement au cours de la vie du Panneau d'Affichage à Plasma.

Pour éviter le risque de combustion au phosphore, les mesures suivantes sont recommandées :

Comme tous les appareils d'affichage à base de phosphore et tous les autres affichages à gaz plasma, les moniteurs Plasmasync peuvent être sujets à la combustion au phosphore dans certaines circonstances. Certaines conditions d'utilisation, telles que l'affichage continu d'une image statique pour une durée prolongée, peuvent causer des brûlures au phosphore si aucune précaution n'est prise. Pour protéger votre investissement dans ce moniteur PlasmaSync NEC, veuillez suivre les directives et les recommandations suivantes pour minimiser l'occurrence de brûlure d'image :

- Assurez-vous de mettre en marche et d'utiliser l'économisateur d'écran chaque fois que c'est possible lorsque vous l'utilisez avec une source d'entrée d'ordinateur.
- Affichez une image en mouvement aussi souvent que possible.
- Coupez toujours l'alimentation lorsque vous avez terminé d'utiliser la moniteur.

Si le PlasmaSync 4210W est en usage continu ou longue durée, prenez les mesures suivantes afin d'éviter l'occurrence de combustion au phosphore :

- Abaissez le niveau de l'image (contraste, luminosité) autant que possible, sans faire perdre la lisibilité de l'image.
- Affichez une image avec de nombreuses couleurs et graduations de couleur (par ex. des images photographiques ou photo-réalistes).
- Créez un contenu d'image avec un contraste minimal entre les zones sombres et les zones claires, par exemple, des caractères blancs sur un fond noir. Utilisez des couleurs complémentaires ou pastels le plus souvent possible.
- Évitez d'afficher des images avec peu de couleurs et des limites nettes et clairement définies entre les couleurs.

Contactez NEC Technologies au 1-800-836-0655 pour d'autres procédures recommandées qui conviendront le mieux au besoin de votre appareil.

Limited Warranty Plasma Monitors

NEC Technologies, Inc. (hereinafter NECTECH) warrants this product to be free from defects in material and workmanship under the following terms and, subject to the conditions set forth below, agrees to repair or replace (at NECTECH's sole option) any part of the enclosed unit which proves defective. Replacement parts or products may be new or refurbished and will meet specifications of the original parts or product.

HOW LONG IS THE WARRANTY?

Parts and labor are warranted for (1) One Year from the date of the first customer purchase.

WHO IS PROTECTED?

This warranty may be enforced only by the first purchaser.

WHAT IS COVERED AND WHAT IS NOT COVERED

Except as specified below, this warranty covers all defects in material or workmanship in this product. The following are not covered by the warranty:

1. Any product which is not distributed in the U.S.A. or Canada and Mexico by NECTECH or which is not purchased in the U.S.A. or Canada or Mexico from an authorized NECTECH dealer.
2. Any product on which the serial number has been defaced, modified or removed.
3. Damage, deterioration or malfunction resulting from:
 - a. Accident, misuse, abuse, neglect, fire, water, lightning or other acts of nature, unauthorized product modification, or failure to follow instructions supplied with the product.
 - b. Repair or attempted repair by anyone not authorized by NECTECH.
 - c. Any shipment of the product (claims must be presented to the carrier).
 - d. Removal or installation of the product.
 - e. Any other cause which does not relate to a product defect.
 - f. Burns or residual images upon the phosphor of the panel.
4. Cartons, carrying cases, batteries, external cabinets, magnetic tapes, or any accessories used in connection with the product.
5. Service outside of the U.S.A. and Canada.

WHAT WE WILL PAY FOR AND WHAT WE WILL NOT PAY FOR

We will pay labor and material expenses for covered items, but we will not pay for the following:

1. Removal or installation charges.
2. Costs of initial technical adjustments (set-up), including adjustment of user controls. These costs are the responsibility of the NECTECH dealer from whom the product was purchased.
3. Payment of shipping charges.

HOW YOU CAN GET WARRANTY SERVICE

1. To obtain service on your product, consult the dealer from whom you purchased the product.
2. Whenever warranty service is required, the original dated invoice (or a copy) must be presented as proof of warranty coverage. Please also include in any mailing your name, address and a description of the problem(s).
3. For the name of the nearest NECTECH authorized service center, call NECTECH at 800-836-0655.

LIMITATIONS OF LIABILITY

Except for the obligations specifically set forth in this warranty statement, we will not be liable for any direct, indirect, special, incidental, consequential, or other types of damages, whether based on contract, tort, or any other legal theory, whether or not we have been advised of the possibility of such damages.

This warranty is in lieu of all other warranties express or implied, including, but not limited to, the implied warranties of merchantability or fitness for a particular purpose.

EXCLUSION OF DAMAGES

NECTECH's liability for any defective product is limited to the repair or replacement of the product at our option. NECTECH shall not be liable for:

1. Damage to other property caused by any defects in this product, damages based upon inconvenience, loss of use of the product, loss of time, commercial loss; or
2. Any other damages whether incidental, consequential or otherwise. Some states do not allow limitation on how long an implied warranty lasts and/or do not allow the exclusion or limitation of incidental or consequential damages, so the above limitations and exclusions may not apply to you.

HOW STATE LAW RELATES TO THE WARRANTY

This warranty gives you specific legal rights, and you may also have other rights which vary from state to state.

FOR MORE INFORMATION, TELEPHONE 800-836-0655

NEC TECHNOLOGIES, INC.

1250 N. Arlington Heights Road, Suite 500

Itasca, Illinois 60143-1248

Note: All products returned to NECTECH for service MUST have prior approval. To get approval, call NEC Technologies at 800-836-0655.

Contents

How to Attach Options to the Plasma Monitor	1		
Introduction	2		
Introduction to the PlasmaSync 42-inch Plasma Monitor	2		
The features you'll enjoy include:	2		
Contents of the Package	2		
Part Names and Function	3		
Front View	3		
Rear View / Terminal Board	4		
Remote Controller	5		
Battery Installation and Replacement	6		
Using the wired remote control mode	7		
Operating Range	7		
Handling the remote controller	7		
Installation	8		
Connecting Your PC Or Macintosh Computer	9		
Connecting Your Document Camera	9		
Connecting Your VCR Or Laser Disc Player	9		
Connecting Your DVD Player	9		
External Speaker Connections	10		
Mini D-Sub 15 Pin RGB Signal Composition	12		
Basic Operations	13		
POWER	13		
To turn the unit ON and OFF:	13		
VOLUME	13		
To adjust the volume:	13		
MUTE	13		
To cancel the sound:	13		
DISPLAY	13		
To check the settings:	13		
VISUAL CONTROL	13		
To adjust the picture's contrast:	13		
To adjust the picture's brightness:	13		
To adjust the picture's color:	13		
To adjust the picture's tint (NTSC only):	13		
To adjust the picture's sharpness:	13		
OFF TIMER	14		
To set the off timer:	14		
To check the remaining time:	14		
Canceling the off timer	14		
WIDE Operations	15		
Watching with a wide screen (manual)	15		
When watching videos or high definition laser discs	15		
Watching computer images with a wide screen	16		
OSM Controls	17		
Menu Operations	17		
Picture Settings Menu	19		
Setting the picture mode according to the brightness of the room	19		
Adjusting the picture	20		
Setting the color temperatuer	21		
Adjusting the color to the desired quality	22		
Reducting noise in the picture	23		
Sound settings menu	24		
Adjusting the treble, bass and left/right balance	24		
Screen Settings Menu	25		
Adjusting the position and size of the wide screen ...	25		
Adjusting the Position, Fine Picture, Picture Adj and Auto picture of the computer image	26		
Adjusting the position of the menu display	28		
Function Settings Menu	29		
Setting the power management for computer images	29		
POWER/STANDBY indicator	30		
Setting a computer image to the correct RGB select screen	31		
Setting high definition image to the suitable screen size	32		
Setting the on-screen display	33		
Setting the gray level for the sides of the screen	33		
Setting the brightness level to the minimum	34		
Resetting to the default values	34		
Information Menu	35		
Checking the frequencies and polarities of input signals	35		
Setting the language for the menus	36		
Setting the video signal format	37		
External Control	38		
Table for Signals Supported	50		
Supported resolutions	50		
Troubleshooting	51		
Specifications	52		

How to Attach Options to the Plasma Monitor

You can attach your optional mounts or stand to the plasma monitor in one of the following two ways:

- * As it is made upright. (See Drawing A)
- * As it is laid down with the screen face down (See Drawing B). Lay the protective sheet, which was wrapped around the monitor when it was packaged, beneath the screen surface so as not to scratch the screen face.

- **This device cannot be installed on its own. Be sure to use a stand or original mounting unit. (Wall mount unit, Stand, etc)**
 - * See page 2.
- **For correct installation and mounting it is strongly recommended to use a trained, authorized NEC dealer.**

Failure to follow correct mounting procedures could result in damage to the equipment or injury to the installer.

Product warranty does not cover damage caused by improper installation.

Drawing A

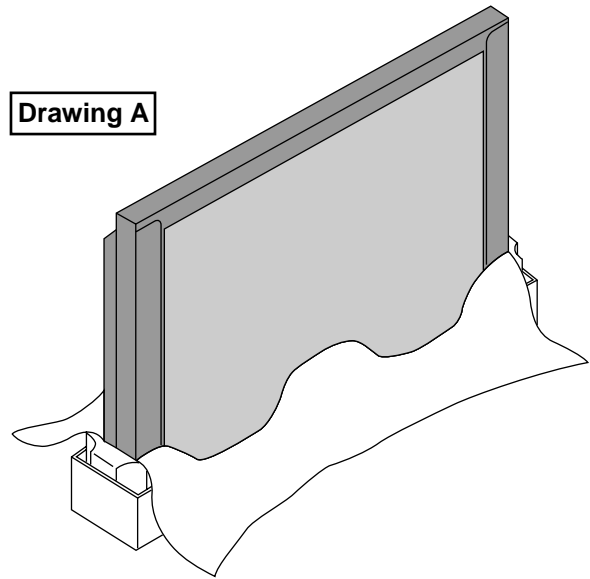

Drawing B

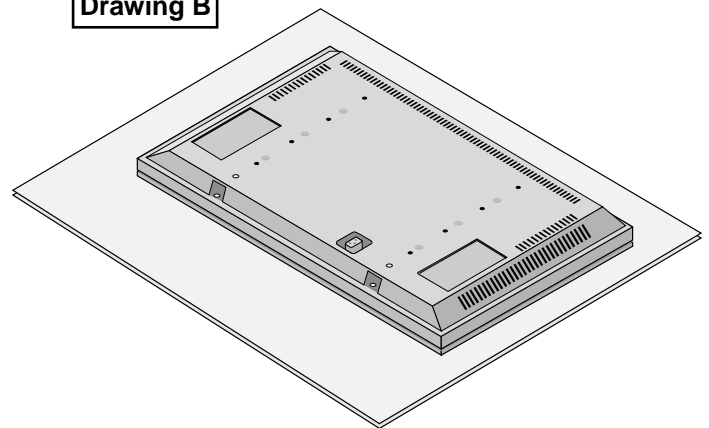

Ventilation Requirements for enclosure mounting

To allow heat to disperse, leave space between surrounding objects as shown on the diagram below when installing.

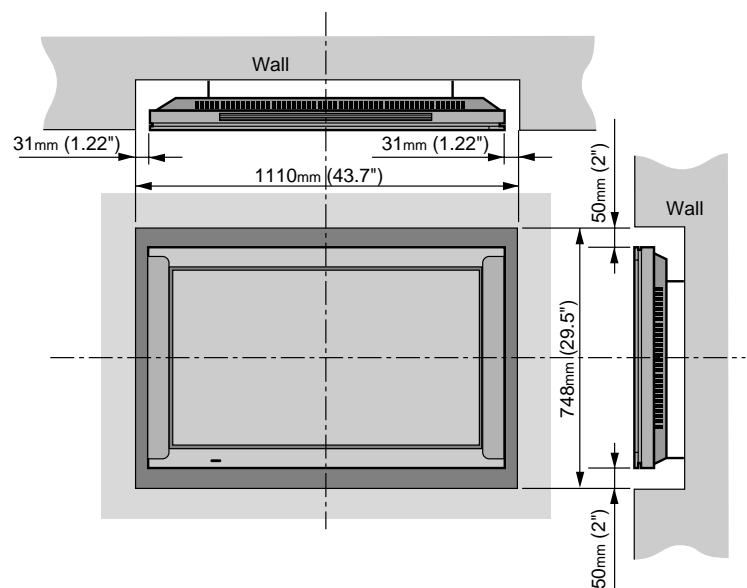

Introduction

Introduction to the PlasmaSync 42-inch Plasma Monitor

NEC's PlasmaSync™ is a seamless blend of cutting-edge visual technology and sophisticated design. At 42-inches, with a 16:9 aspect ratio, the PlasmaSync™ certainly makes a big impression. However, at a mere 3.6 inches/ 91mm thin, the monitor's sleek techno-art lines blend in well with your environment. PlasmaSync's crisp, vivid image quality will transform data from any graphic medium from PCs to DVD players- into art. And weighing only 87.1 lbs/ 39.5kg, it actually can be hung almost anywhere. NEC has made sure that a host of multimedia resources can be easily connected and displayed as brilliantly as intended on the PlasmaSync™ monitor.

The features you'll enjoy include:

- 42-inch screen
- 16:9 aspect ratio
- Capsulated Color Filter™ (CCF) and black matrix
- 3.6 in/ 91mm thin
- 87.1 lbs/ 39.5 kg light
- High-resolution screen:853 × 480 pixels
- 160-degrees of off-axis viewing, horizontally and vertically.
- Flicker - and warp - free display provides excellent image geometry even in screen corners
- Not affected by magnetic fields, no color drift or edge distortion.
- VGA, SVGA, XGA, SXGA (60Hz), computer signal compatibility
- NTSC, PAL, SECAM, composite and S-Video signal compatibility
- 480P, 1080I, 720P and HDTV signal compatibility
- PCs, VCRs, Laser Disc and DVD player source compatibility
- Softscaling automatically converts SVGA and XGA signals to the panel's native resolution
- RGB input(1), Video/S-Video input(1), DVD/ HD input(1), audio output(1), external control input(1)
- AccuColor control system provides user selectable on-screen color temperature settings
- New Drive Technology
- Component video input terminal for DVD, 15.75kHz (Y, CB, CR)
- NEC's OSM™ menu-driven on screen control system that makes image adjustments a snap
- Seven languages (English, German, French, Italian, Spanish, Swedish, and Japanese)

Note

These instructions are for both the standard (included) remote control unit and the optional LCD remote controller (PX-RC1E). For details on operating the LCD remote controller, refer to the operating instructions included with LCD remote controller.

Contents of the Package

- PlasmaSync 4210W plasma monitor
- Power cord
- RGB cable (Mini D-Sub 15-pin to Mini D-Sub 15-pin connector)
- Adapter for Macintosh
- Remote control unit with two AA Batteries
- User's manual
- Safety metal fitting (2 pieces)*
- Screw for safety metal fitting (2 pieces)*
- Wired remote cable

* These are fittings for fastening the unit to a wall to prevent tipping due to external shock when using the stand (option). Fasten the safety fittings to the holes in the back of the monitor using the safety fitting mount screws.

Options

- Wall mount unit
- Ceiling mount unit
- Tilt mount unit
- Tabletop stand
- LCD touch screen learning remote controller
(A multi function LCD Remote Control that makes operation of connected VCR, Laser Disc, and DVD possible from a single unit. It also has a "learning function" that turns it into a total remote control.)
- Others

Part Names and Function

Front View

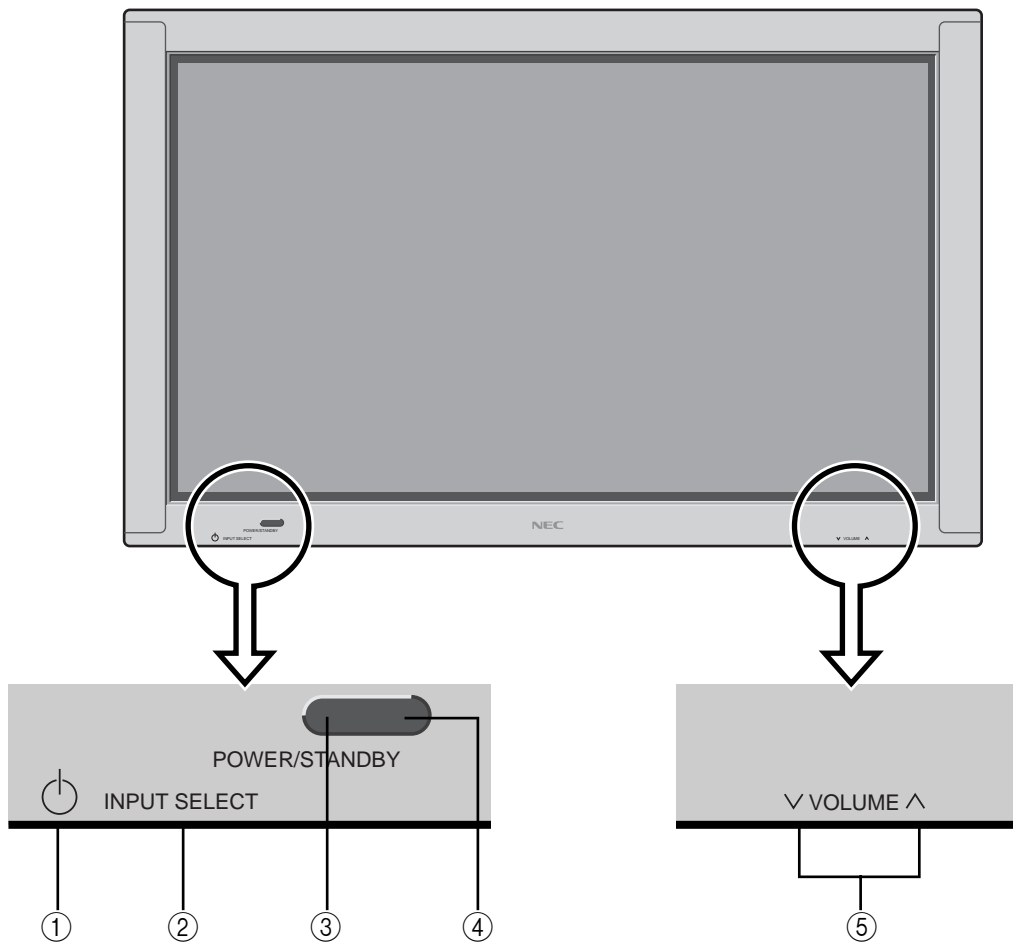

① **Power**

Turns the monitor's power on and off.

② **INPUT SELECT**

Switches the input, in the following order:



③ **POWER/STANDBY indicator**

When the power is on..... Lights green.
When the power is in the standby mode ... Lights red.

④ **Remote sensor window**

Receives the signals from the remote control unit.

⑤ **VOLUME ▲ and ▼**

Adjust the volume.

Rear View/ Terminal Board

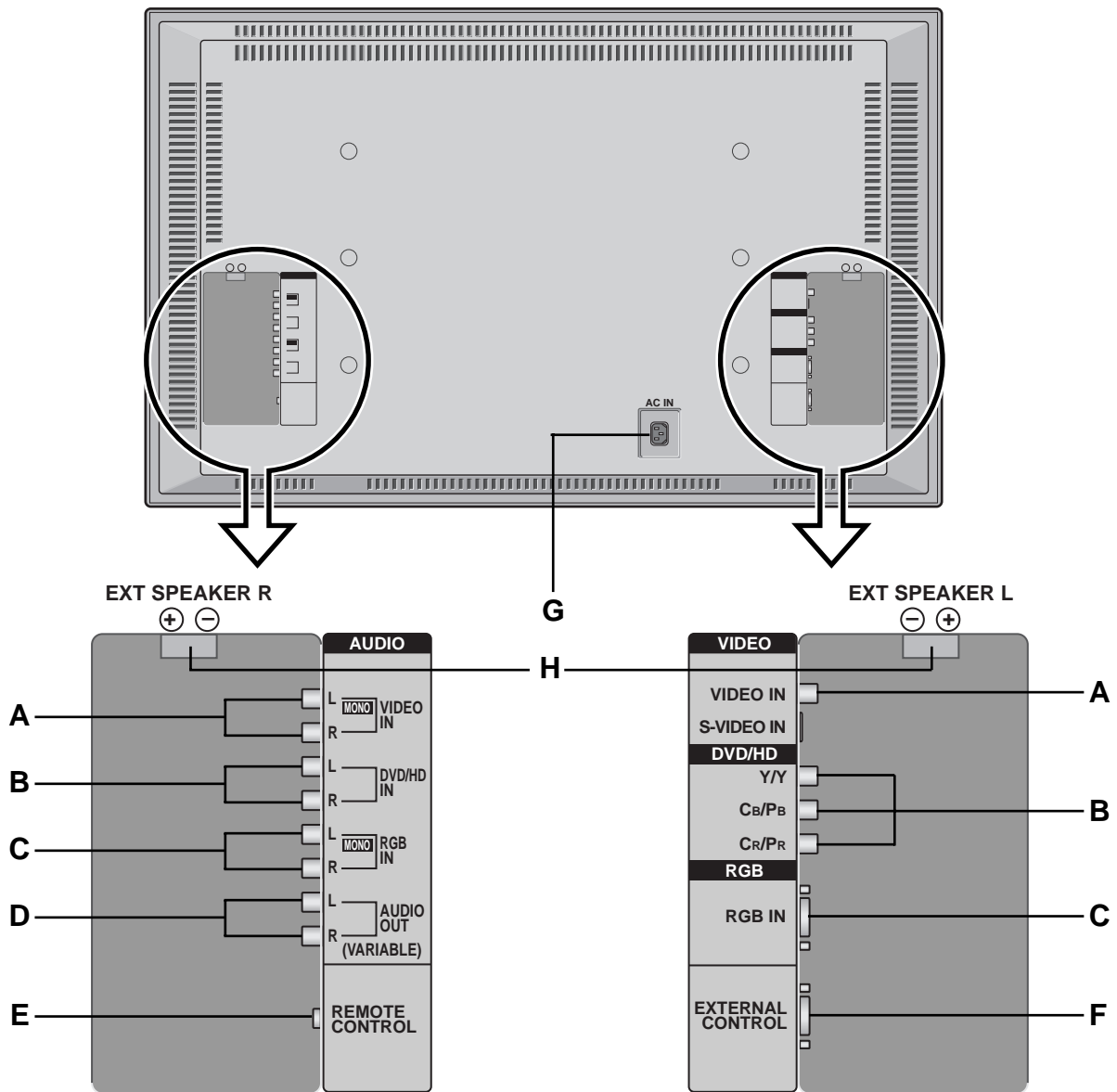

A VIDEO IN/AUDIO IN

Connect VCR's, DVD's or Laser Discs, etc. here.

B DVD/HD (Y/Y, Cb/Pb and Cr/Pr) IN/ AUDIO IN

Connect DVD's, high definition Laser Discs, etc. here.

C RGB IN/ AUDIO IN

Connect Computer Source here.

D AUDIO OUT

Connect the external amplifier only for woofer.
The output level depends on the volume setting.

E REMOTE CONTROL

Connect the supplied remote cable here.

F EXTERNAL CONTROL

This terminal is used when power ON/OFF, input selection and AUDIO MUTE and other controls are operated externally (by external control). See also page 38 for external control.

G AC IN

Connect the included power cord here.

H EXT SPEAKER L and R

Connect speakers here.

Remote Controller

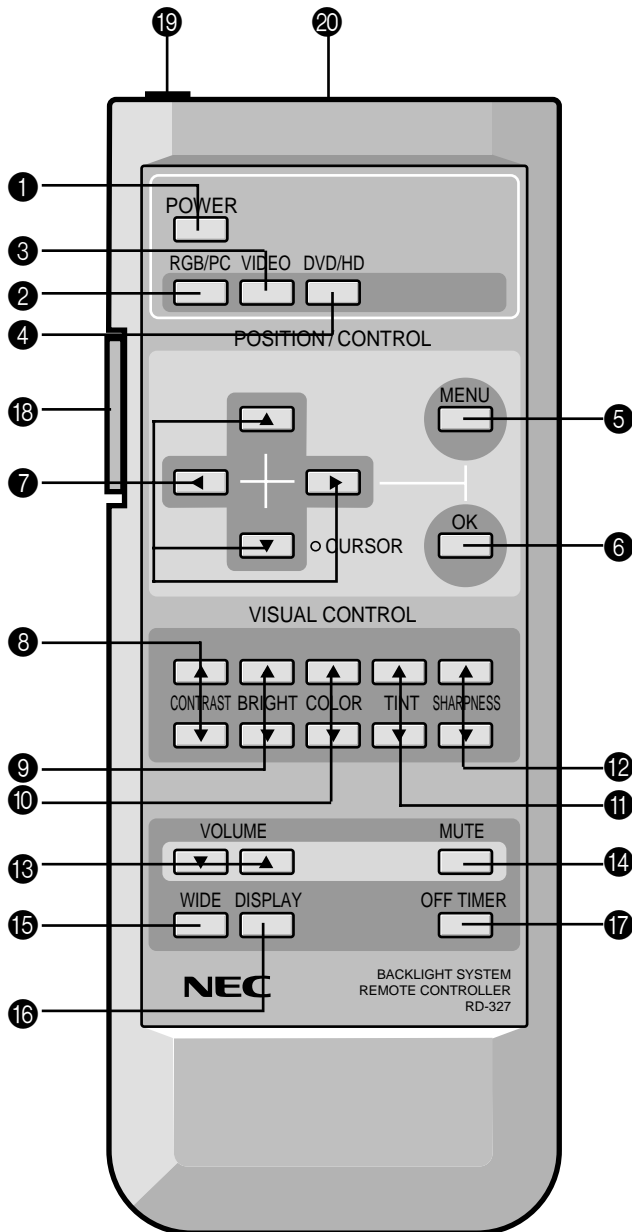

❶ POWER

Turns the monitor's power on and off.

❷ RGB/PC

Press this button to select RGB/PC as the source.

RGB/PC can also be selected using the INPUT SELECT button on the monitor. The input switches as follows each time the button is pressed:

→ VIDEO → DVD/HD → RGB/PC →

❸ VIDEO

Press this button to select VIDEO as the source.

VIDEO can also be selected using the INPUT SELECT button on the monitor. The input switches as follows each time the button is pressed:

→ VIDEO → DVD/HD → RGB/PC →

❹ DVD / HD

Press this button to select DVD/HD as the source.

DVD/HD can also be selected using the INPUT SELECT button on the monitor. The input switches as follows each time the button is pressed:

→ VIDEO → DVD/HD → RGB/PC →

❺ MENU

Use this button to turn the main menu on/off.

❻ OK

Use this button to approve selections and settings.

❼ CURSOR (▲ / ▼ / ◀ / ▶)

Use these buttons to select items or settings and to adjust settings.

❽ CONTRAST (▲ / ▼)

Adjusts the picture's contrast.

❾ BRIGHT (▲ / ▼)

Adjusts the picture's brightness.

❿ COLOR (▲ / ▼)

Adjusts the color density.

⓫ TINT (▲ / ▼)

Adjusts the picture's tint.(NTSC only)

⓬ SHARPNESS (▲ / ▼)

Adjusts the picture's sharpness.

13 VOLUME (▲ / ▼)

Adjust the volume.

14 MUTE

Mutes the sound.

15 WIDE

The type of broadcast is detected automatically, and the recommended wide screen mode is set.

16 DISPLAY

Displays the source settings on the screen.

17 OFF TIMER

Activates the off timer for the unit.

18 BACK LIGHT switch

Turns the back light on and off.

Turn on when using the remote control in dark rooms.

Note: The backlight key characters may not be visible in a bright-lit room. Make sure that the backlight switch is OFF when the remote control unit is not used. If no button operation is made within 30 seconds when the backlight is lit in the wireless condition, the backlight will go off automatically to conserve battery life. To turn the backlight on again, set the switch to the OFF position, then set it to the ON position.

19 Remote Jack

Insert the plug of the supplied remote cable when using the supplied remote control unit in the wired condition.

Note: Connecting the monitor and the remote control unit with the supplied remote cable turns on the backlight independent of the backlight switch setting when the monitor is powered on.

20 Remote control signal transmitter

Transmits the remote control signals.

Battery Installation and Replacement

Insert the 2 "AA" batteries, making sure to set them in with the proper polarity.

1. Press and pull.

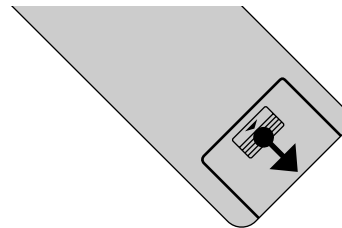

2. Load the batteries in the direction indicated by the "+" and "-" marks in the case.

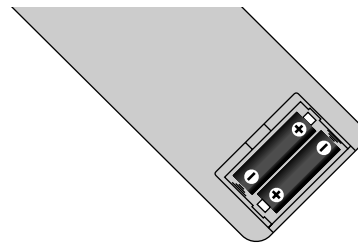

3. Put the lid back on.

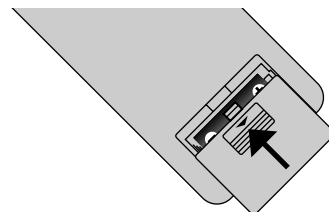

Using the wired remote control mode

Connect the included remote control cable to the remote control unit's "REMOTE CONTROL" terminal.

When the cable is connected, the mode automatically switches to wired remote control.

When the wired remote control mode is used, the remote control unit can be operated even if no batteries are loaded.

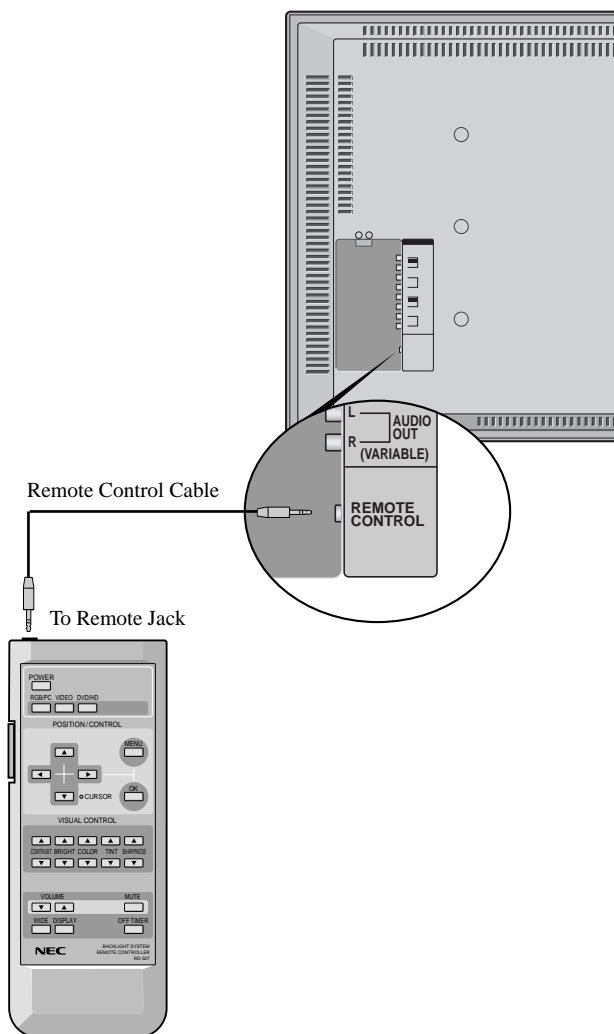

Operating Range

* Use the remote controller within a distance of about 7 m / 23ft. from the front of the monitor's remote control sensor and at a horizontal angle of within 30°.

* The remote control operation may not function if the monitor's remote control sensor is exposed to direct sunlight or strong artificial light, or if there is an obstacle between the sensor and the remote control unit.

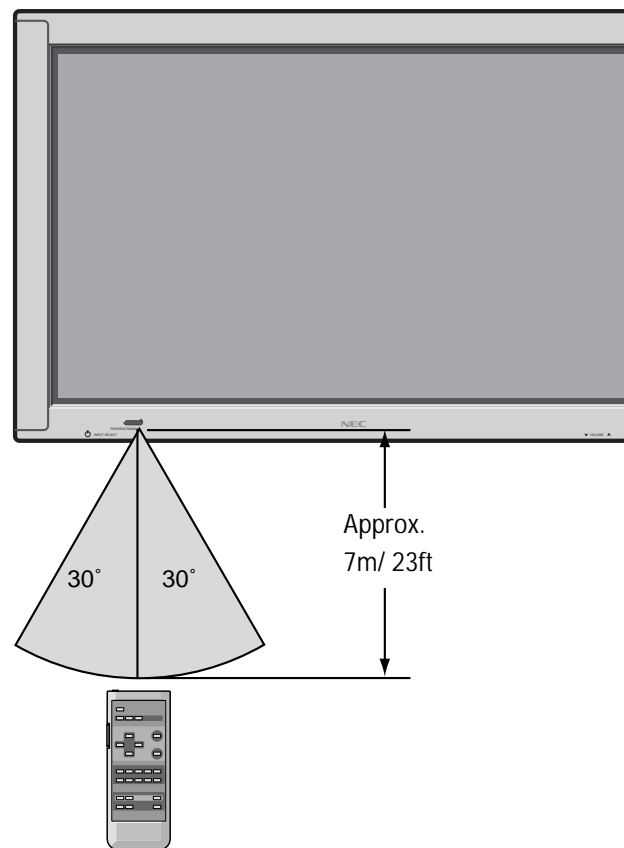

Handling the remote controller

- Do not drop or mishandle the remote control unit.
- Do not get the remote control unit wet. If the remote gets wet, wipe it dry immediately.
- Avoid heat and humidity.
- When not using the remote control unit for a long period, remove the batteries.
- Do not use new and old batteries together, or use different types together.
- Do not take apart the batteries, heat them, or throw them into a fire.
- When using the remote control unit in the wireless condition, be sure to unplug the remote cable from the REMOTE CONTROL terminal on the monitor.

Installation

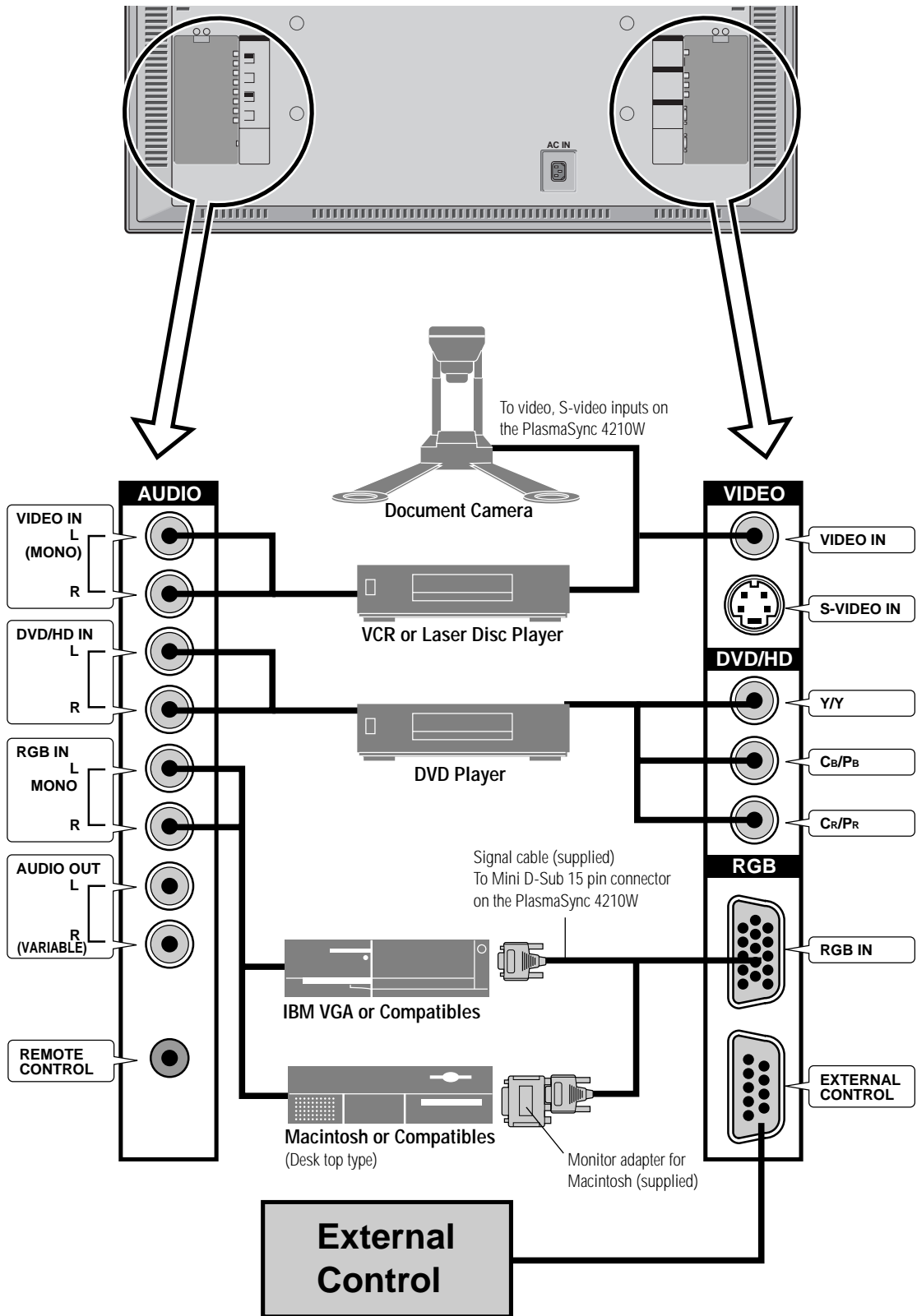

Connecting Your PC Or Macintosh Computer

Connecting your PC or Macintosh computer to your PlasmaSync 4210W will enable you to display your computer's screen image for an impressive presentation. The PlasmaSync 4210W supports the signals described on page 50.

To connect to a PC, Macintosh or compatible graphics adapter, simply:

1. Turn off the power to your PlasmaSync 4210W and computer.
2. If your PC does not support XGA/SVGA/VGA you will need to install an XGA/SVGA/VGA graphics board. Consult your computer's owner's manual for your SXGA/XGA/SVGA/VGA configuration. If you need to install a new board, see the manual that comes with your new graphics board for installation instructions.
3. The PlasmaSync 4210W provides signal compatibility with VESA 1280×1024@60MHz (SXGA). However, it is not recommended to use this resolution due to image readability on the monitors 853×480 native pixel resolution panel.
4. Use the signal cable that's supplied to connect your PC or Macintosh computer to the PlasmaSync 4210W. For Macintosh, use the supplied monitor adapter to connect to your computer's video port.
5. Turn on the PlasmaSync 4210W and the computer.
6. If the PlasmaSync 4210W goes blank after a period of inactivity, it may be caused by a screen saver installed on the computer you've connected to the PlasmaSync 4210W.

When using a Macintosh with the PlasmaSync 4210W, the following three display standards are supported using the included Macintosh adapter :

- 13" fixed mode
- 16" fixed mode
- 19" fixed mode

The 13" fixed mode is recommended for the PlasmaSync 4210W.

Connecting Your Document Camera

You can connect your PlasmaSync 4210W to a document camera. To do so, simply:

1. Turn off the power to your PlasmaSync 4210W and document camera.
2. Use a standard video cable to connect your document camera to the Video input on your PlasmaSync 4210W.
3. Turn on the PlasmaSync 4210W and the document camera.

Note: Refer to your document camera's owner's manual for more information about your camera's video output requirements.

Connecting Your VCR Or Laser Disc Player

Use common RCA cables (not provided) to connect your VCR or laser disc player to your PlasmaSync 4210W. To make these connections, simply:

1. Turn off the power to your PlasmaSync 4210W and VCR or laser disc player.
2. Connect one end of your RCA cable to the video output connector on the back of your VCR or laser disc player, connect the other end to the Video input on your PlasmaSync 4210W. Use standard RCA audio patch cords to connect the audio from your VCR or laser disc player to your PlasmaSync 4210W (if your VCR or laser disc player has this capability). Be careful to keep your right and left channel connections correct for stereo sound.
3. Turn on the PlasmaSync 4210W and the VCR or laser disc player.

Note: Refer to your VCR or laser disc player owner's manual for more information about your equipment's video output requirements.

Connecting Your DVD Player

You can connect your PlasmaSync 4210W to a DVD player. To do so, simply:

1. Turn off the power to your PlasmaSync 4210W and DVD player.
2. Use a standard video cable to connect your DVD player to the Y, Cb, and Cr inputs on your PlasmaSync 4210W. Or use the DVD-player's S-Video output. Use a standard S-Video cable to connect to the S-Video input on the PlasmaSync 4210W.
3. Turn on the PlasmaSync 4210W and the DVD player.

External Speaker Connections

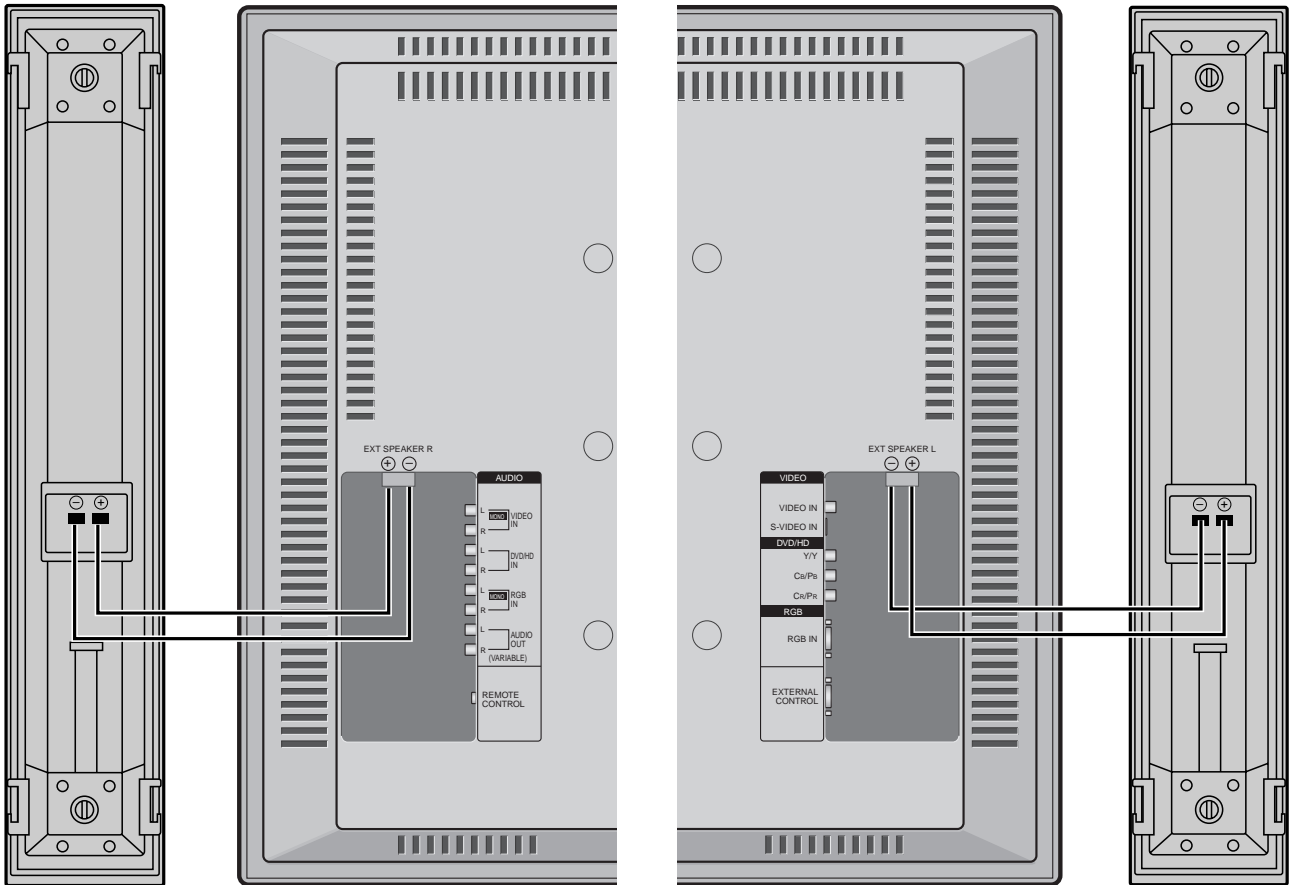

External speakers may be connected to the PlasmaSync 4210W to reproduce sound from VIDEO, DVD or RGB signal sources.

External speakers may be connected directly to the SPEAKERS terminals or indirectly by connecting a stereo system amplifier to the audio outputs.

CAUTION: *Unplug the PlasmaSync 4210W and all connected components before connecting external speakers. Use only speakers with 6-ohm impedance and a power output rating of 7 watts or more.*

To connect external speakers directly to the PlasmaSync 4210W:

1. Strip the ends of the speaker wires.
2. Press down the tabs below the SPEAKERS terminals, insert the speaker wire and release the tab to secure the speaker wire connection:
 - [a] Connect the right speaker (located at right side of the monitor when viewed from the front) positive (+) wire to RIGHT +.
 - [b] Connect the right speaker negative (-) wire to RIGHT -.
 - [c] Connect the left speaker negative (-) wire to LEFT-.
 - [d] Connect the left speaker positive wire (+) to LEFT+.

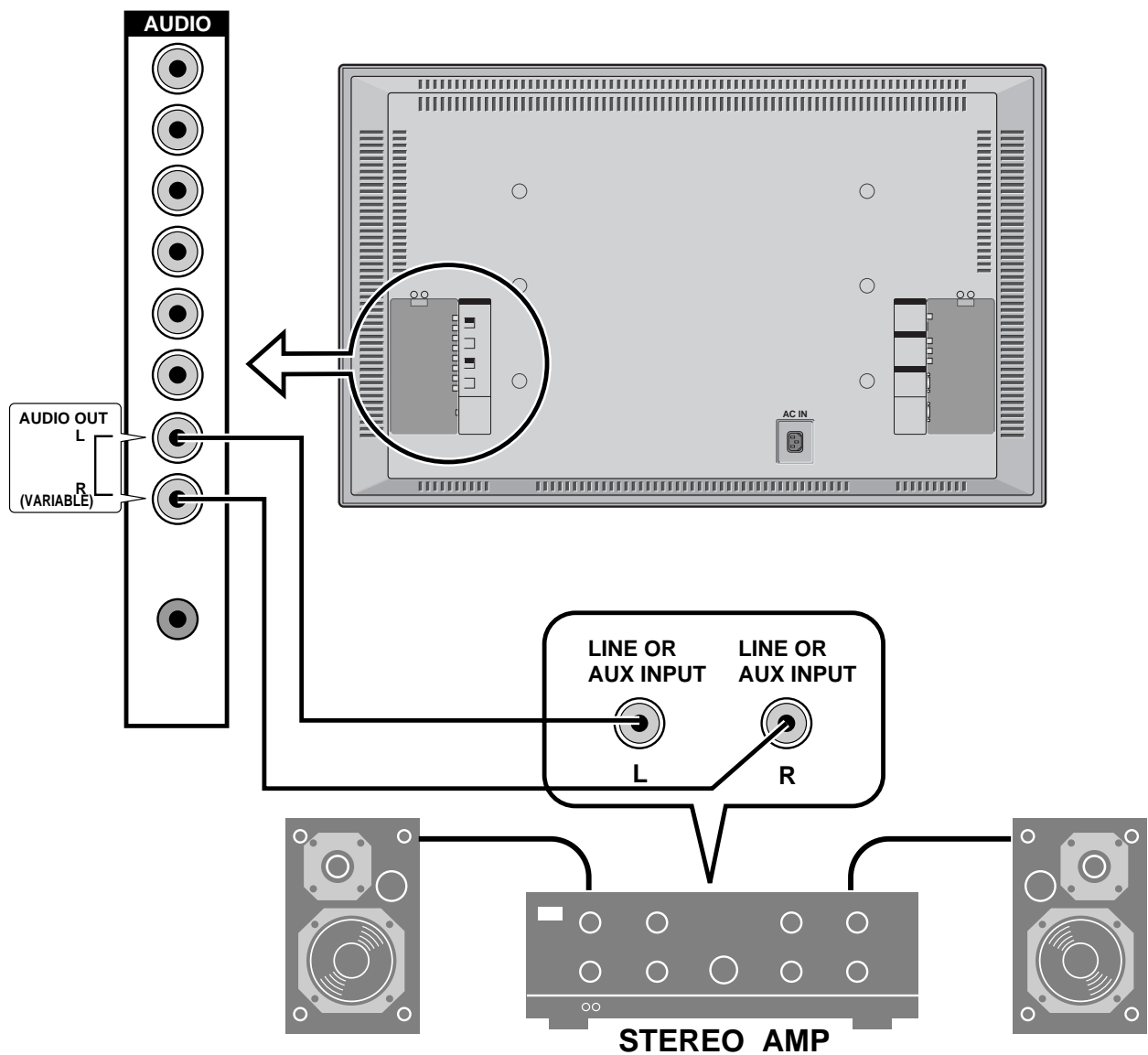

To connect the PlasmaSync 4210W to stereo system speakers:

1. Connect AUDIO OUT L to the stereo amplifier AUX INPUT L.
2. Connect AUDIO OUT R to the stereo amplifier AUX INPUT R.

Mini D-Sub 15 Pin RGB Signal Composition

Pin Assignments and Signal Levels for 15 pin RGB (Analog)

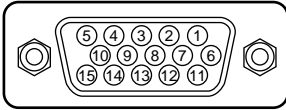

Pin No.	Signal to be connected
1	RED
2	GREEN or Sync. on Green
3	BLUE
4	No Connection
5	GND
6	RED (GND)
7	GREEN (GND)
8	BLUE (GND)
9	No Connection
10	SYNC (GND)
11	No Connection
12	SDA
13	H. sync
14	V. sync
15	SCL

Basic Operations

POWER

To turn the unit ON and OFF:

1. Plug the power cord into an active AC power outlet.
2. Press the POWER button (on the remote controller) to turn on.

The monitor's POWER/STANDBY indicator will light up (green) when the unit is on.

3. Press the POWER button (on the remote controller or the unit) to turn off.

The monitor's POWER/STANDBY indicator turns red and the standby mode is set (only when turning off the unit with the remote control).

VOLUME

To adjust the volume:

1. Press and hold the VOLUME ▲ button (on the remote controller or the unit) to increase to the desired level.
2. Press and hold the VOLUME ▼ button (on the remote controller or the unit) to decrease to the desired level.

MUTE

To cancel the sound:

Press the MUTE button on the remote controller to cancel sound; press again to restore.

DISPLAY

To check the settings:

1. The screen changes each time the DISPLAY button is pressed.
2. If the button is not pressed for approximately three seconds, the menu turns off.

VISUAL CONTROL

To adjust the picture's contrast:

1. Press and hold the CONTRAST ▲ button for higher contrast.
2. Press and hold the CONTRAST ▼ button for lower contrast.

To adjust the picture's brightness:

1. Press and hold the BRIGHT ▲ button for a brighter picture.
2. Press and hold the BRIGHT ▼ button for a darker picture.

To adjust the picture's color:

1. Press and hold the COLOR ▲ button for more color saturation.
2. Press and hold the COLOR ▼ button for less color saturation.

To adjust the picture's tint (NTSC only):

1. Press and hold the TINT ▲ button for a greener tint.
2. Press and hold the TINT ▼ button for a redder tint.

To adjust the picture's sharpness:

1. Press and hold the SHARPNESS ▲ button for a sharper picture.
2. Press and hold the SHARPNESS ▼ button for a softer picture.

*If no key operation is made within five seconds, the OSM display will disappear.

OFF TIMER

To set the off timer:

The off timer can be set to turn the power off after 30, 60, 90 or 120 minutes.

1. Press the OFF TIMER button to start the timer at 30 minutes.
2. Press the OFF TIMER button to the desired time.
3. The timer starts when the menu turns off.

→ 30 → 60 → 90 → 120 → 0



To check the remaining time:

1. Once the off timer has been set, press the OFF TIMER button once.
2. The remaining time is displayed, then turns off after a few seconds.
3. When five minutes remain the remaining time appears until it reaches zero.



Canceling the off timer

1. Press the OFF TIMER button twice in a row.
2. The off timer is canceled.



Note:

After the power is turned off with the off timer ... A slight current is still supplied to the monitor. When you are leaving the room or do not plan to use the system for a long period of time, turn off the power of the monitor.

WIDE Operations

Watching with a wide screen (manual)

With this function, you can select one of four screen sizes.

When watching videos or digital video discs

1. Press the "WIDE/AUTO WIDE" button on the remote controller.
2. *Within 3 seconds ...*

Press the "WIDE/AUTO WIDE" button again.
The screen size switches as follows:

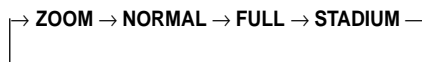

ZOOM size screen

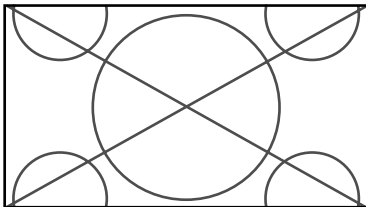

The picture is expanded in the horizontal and vertical direction, maintaining the original proportions.

* Use this for theater size (wide) movies, etc.

NORMAL size screen (4:3)

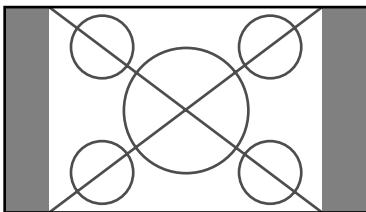

The normal size screen is displayed.

* The picture has the same size as video pictures with a 4 : 3 aspect ratio.

FULL size screen

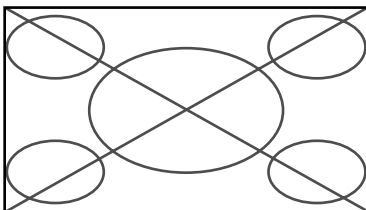

The image is expanded in the horizontal direction.

* Images compressed in the horizontal direction ("squeezed images") are expanded in the horizontal direction and displayed on the entire screen. (Normal images are expanded in the horizontal direction.)

STADIUM size screen

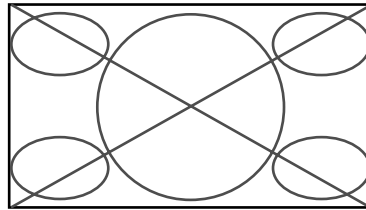

The picture is expanded in the horizontal and vertical directions at different ratios.

* Use this for watching normal video programs (4:3) with a wide screen.

When watching high definition video source

1. Press the "WIDE/AUTO WIDE" button on the remote controller.

FULL size screen (16 : 9)

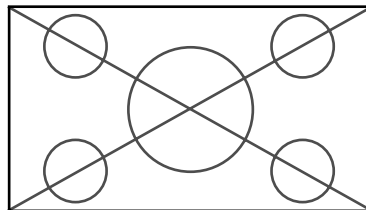

The full size screen is displayed.

* The picture has the same size as video pictures (16 : 9).

Watching computer images with a wide screen

Switch to the wide screen mode to expand the 4 : 3 image to fill the entire screen.

1. Press the "WIDE / AUTO WIDE" button on the remote controller.
2. *Within 3 seconds ...*

Press the "WIDE/AUTO WIDE" button again.
The screen size switches as follows:

→ NORMAL → FULL ←

NORMAL size screen (4:3)

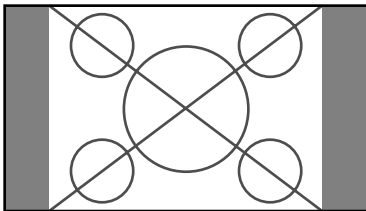

The picture has the same size as the normal computer image.

FULL size screen

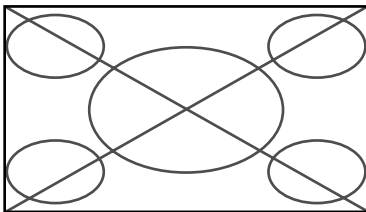

The image is expanded in the horizontal direction.

When using a graphic accelerator board that is capable of displaying 848 × 480.

FULL size screen

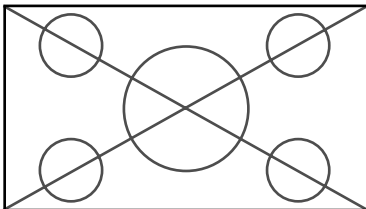

Information

■ Supported resolution

- When 800 dot × 600 line signals are input, they are converted to 640 dot × 480 line or 853 dot × 480 line signals.
- When 1024 dot × 768 line signals are input, they are converted to 640 dot × 480 line or 853 dot × 480 line signals.
- When 1280 dot × 1024 line signals are input, they are converted to 597 dot × 478 line.
See page 50 for details on the display output of the various vesa signal standards supported by the monitor.
- When 852 dot × 480 line wide VGA (*) signals with a vertical frequency of 60 Hz and horizontal frequency of 31.72 kHz are input, select "WIDE" for the "RGB SELECT" setting. Since selecting an 848 × 480 signal automatically displays the image in correct size, it is not necessary to change the RGB SELECT setting.

* "IBM PC/AT" and "VGA" are registered trademarks of IBM, Inc. of the United States.

OSM(On Screen Menu) Controls

Menu Operations

The OSM window is displayed with respect to the screen as shown on the diagram.

- * Depending on the screen's mode, the OSM may be displayed slightly differently. In the explanation, the OSM section is shown close up.

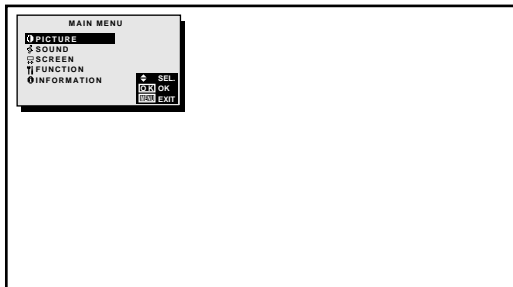

The following describes how to use the menus and the selected items.

1. Press the MENU button on the remote controller to display the MAIN MENU.

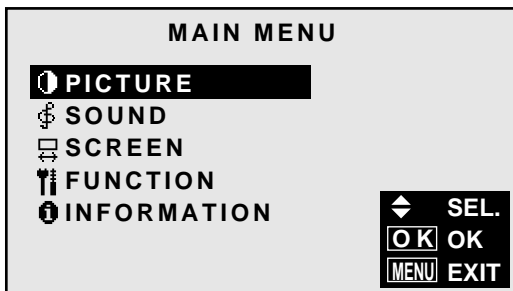

2. Press the cursor buttons ▲ ▼ on the remote controller to highlight the menu you wish to enter.
3. Press the OK button on the remote controller to select a submenu or item.

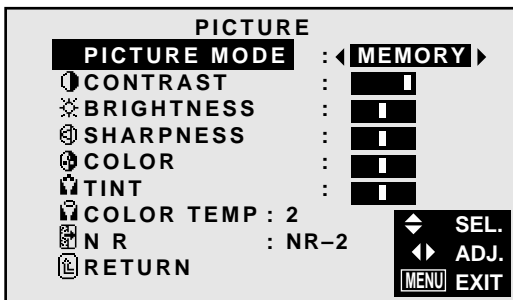

4. Adjust the level or change the setting of the selected item by using the cursor buttons ◀ ▶ on the remote controller.

5. The change is stored until you adjust it again.
6. Repeat steps 2 – 5 to adjust an additional item, or press the MENU button on the remote controller to exit the menu display.

Main menu	Sub menu	Functions
PICTURE	PICTURE MODE	Sets the picture mode according to the VIDEO environment and image software.
	CONTRAST	Adjust the contrast.
	BRIGHTNESS	Adjust the brightness.
	SHARPNESS	Adjust the sharpness.
	COLOR	Adjust the color.
	TINT	Adjust the tint.
	COLOR TEMP	Adjust the color temperature and white balance.
	NR	Reduces noise visible in image.

Main menu	Sub menu	Functions
SOUND	BASS	Sets the bass.
	TREBLE	Sets the treble.
	BALANCE	Sets the left/right balance.

Main menu	Sub menu	Functions
SCREEN	WIDE ADJ.	Adjusts the wide screen's vertical position and size.
	RGB ADJ.	Adjusts the computer image's vertical and horizontal positions, fine picture, picture adj, Auto picture.
	OSM ADJ.	Adjusts the vertical and horizontal positions of the menu display.

Main menu	Sub menu	Functions
FUNCTION	POWER MGT	Sets the monitor for use as an energy-saving display when used with a computer.
	RGB SELECT	Sets the appropriate mode for the computer image. RGB (VGA signals), VIDEO (Moving picture), WIDE (WIDE VGA) DTV.
	HD SELECT	Sets the digital broadcasting (1080I) or the High Vision (1035I).
	OSM	Turns the on-screen display (screen mode, etc.) off (when set to "OFF"). When set to "ON", the on-screen display is displayed.
	GRAY LEVEL	In case of 4 : 3, sets the luminance of both sides.
	PLE	Setting the brightness level to the minimum. Normally set to AUTO.
	RESET	Resets all the settings (PICTURE, SOUND, WIDE adjustments, RGB adjustments, OSM adjustments) to the factory default values.

Main menu	Sub menu	Functions
INFORMATION	FREQUENCY	Used to check the frequency and synchronizing polarities of the signal currently being inputted.
	COMMUNICATION	It is not necessary to change the setting on this system. Normally set to AUTO.
	LANGUAGE	Sets the language of the menus (Japanese, English, German, French, Swedish, Italian or Spanish).
	COLOR SYSTEM	Sets the VIDEO format (PAL, SECAM, 4.43 NTSC or 3.58 NTSC).

Picture Settings Menu

Setting the picture mode according to the brightness of the room

There are four picture modes that can be used effectively according to the environment in which you are viewing the display.

Example: Setting the "THEATER" mode

Press the **MENU** button on the remote controller to display the **MAIN MENU** on the screen, then...

1. Use the **▲** and **▼** buttons to select "PICTURE", then press the "OK" button.
The "PICTURE" screen appears.
2. Use the **▲** and **▼** buttons to select "PICTURE MODE".

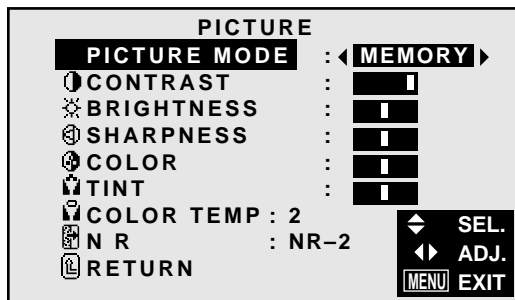

3. To set to "THEATER" ...
Use the **◀** and **▶** buttons to select "THEATER".
The mode switches as follows when the **◀** and **▶** buttons are pressed:

→ MEMORY ↔ THEATER ↔ NORMAL ↔ RESET ←



* If neither the **◀** or **▶** button is pressed within 5 seconds, the current selection is set and the previous screen reappears.

4. Press the "OK" button.
The picture mode is set to "THEATER".

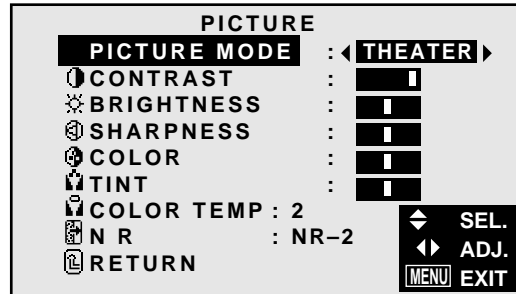

5. Once the adjustment is completed ...
Press the "MENU" button.
All menus disappear.

Information

Types of picture modes

MEMORY The last picture adjustments are stored here.

THEATER Set this mode when watching video in a dark room.

This mode provides darker, finer pictures, like the screen in movie theaters.
CONTRAST = 80% for RESET mode
BRIGHTNESS = 95% for RESET mode

NORMAL Set this mode when watching video in a bright room.

This mode provides dynamic pictures with distinct differences between light and dark sections.

CONTRAST = 96% for RESET mode

RESET Use this to reset the picture to the factory default settings.

Adjusting the picture

The contrast, brightness, sharpness, color and tint can be adjusted as desired.

Example: Adjusting the contrast

Press the MENU button on the remote controller to display the MAIN MENU on the screen, then...

1. Use the ▲ and ▼ buttons to select "PICTURE", then press the "OK" button.
The "PICTURE" screen appears.
2. Use the ▲ and ▼ buttons to select "CONTRAST".

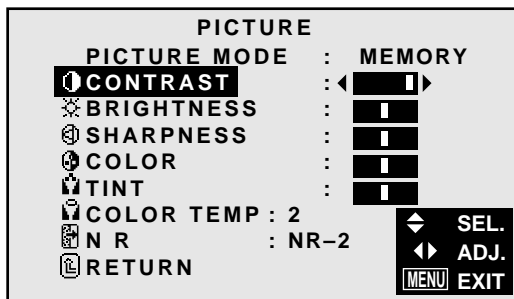

3. Use the ◀ and ▶ buttons to adjust the picture.

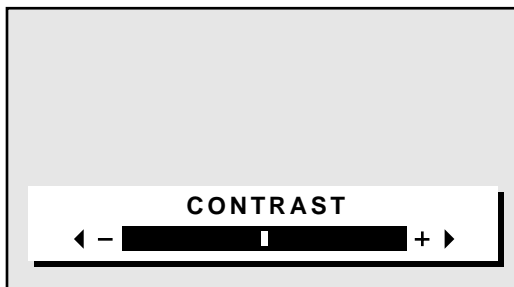

* If neither the ◀ or ▶ button is pressed within 5 seconds, the current setting is set and the previous screen reappears.

4. Press the "OK" button.
The contrast adjustment is completed.

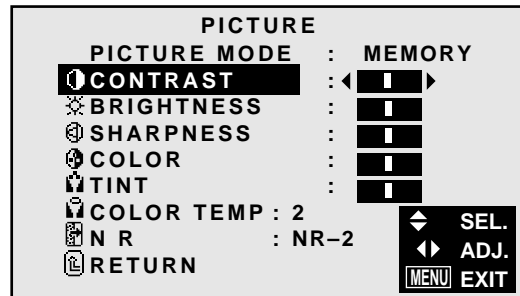

5. Once the adjustment is completed ...
Press the "MENU" button.
All menus disappear.

Note: If "CAN NOT ADJUST" appears ...
When trying to enter the PICTURE submenu, make sure PICTURE MODE is set to MEMORY.

Information

Picture adjustment screen

- CONTRAST Changes the picture's contrast.
- BRIGHTNESS Changes the picture's brightness.
- SHARPNESS Changes the picture's sharpness.
Adjusts picture detail of VIDEO display.
- COLOR Changes the color density.
- TINT Changes the picture's tint. (NTSC only)
Adjust for natural colored skin, background, etc.

Adjusting the computer image

Only the contrast and brightness can be adjusted when a computer signal is connected.

Restoring the factory default settings

Select "RESET" under the "PICTURE MODE" settings.

Setting the color temperature

Use this procedure to set color tone produced by the plasma display.

Example: Setting "1"

Press the MENU button on the remote controller to display the MAIN MENU on the screen, then...

1. Use the ▲ and ▼ buttons to select "PICTURE", then press the "OK" button.
The "PICTURE" screen appears.
2. Use the ▲ and ▼ buttons to select "COLOR TEMP".

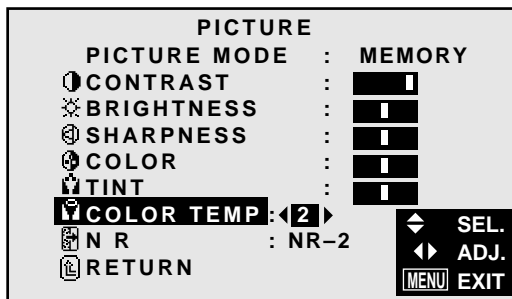

3. Use the ◀ and ▶ buttons to select "1".

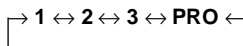

* See page 22 to set "PRO".

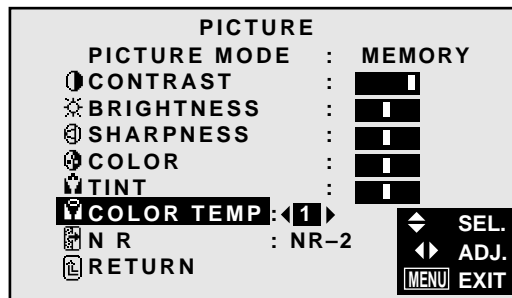

4. Once the setting is completed...
Press the "MENU" button.
All menus disappear.

Information

■ Setting the color temperature

- 1 High (bluer)
- 2 Middle (Standard)
- 3 Low (redder)

■ Restoring the factory default settings

Select "RESET" under the function menu. Note that this also restores other settings to the factory defaults.

Adjusting the color to the desired quality

Use this procedure to adjust the white balance for bright pictures and dark pictures to achieve the desired color quality.

Example: Adjusting the "WHITE BALANCE"

Press the MENU button on the remote controller to display the MAIN MENU on the screen, then...

- Use the ▲ and ▼ buttons to select "PICTURE", then press the "OK" button.
The "PICTURE" screen appears.
- Use the ▲ and ▼ buttons to select "COLOR TEMP".

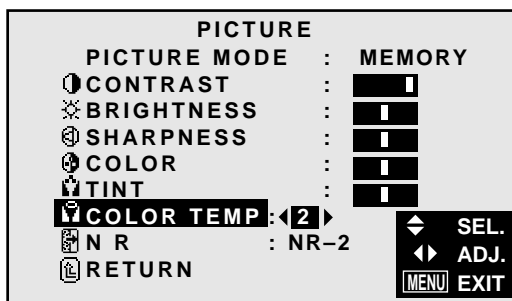

- Use the ◀ and ▶ buttons to select "PRO".

→ 1 ↔ 2 ↔ 3 ↔ PRO ◀

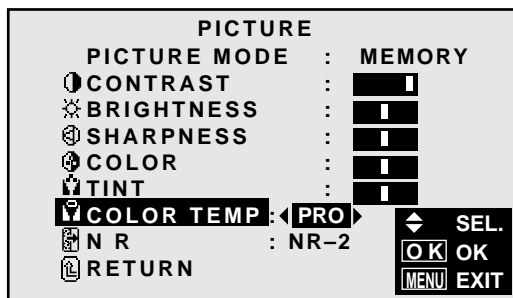

- Press the "OK" button.
The "WHITE BALANCE" screen appears.
- Use the ◀ and ▶ buttons to select "R-GAIN".

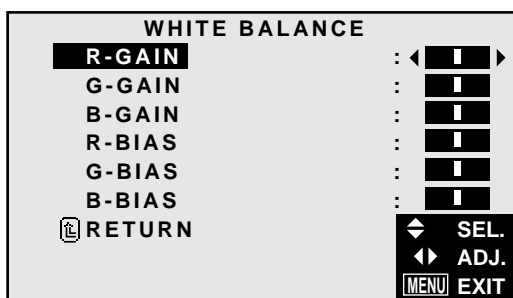

- Adjusts the white balance using the ◀ and ▶ buttons.

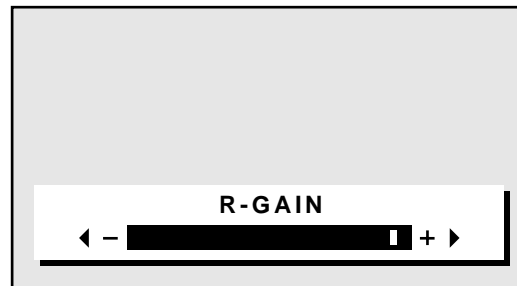

* If neither the ◀ or ▶ button is pressed within 5 seconds, the current setting is set and the previous screen reappears.

- Press the "OK" button.
The white balance has now been adjusted.

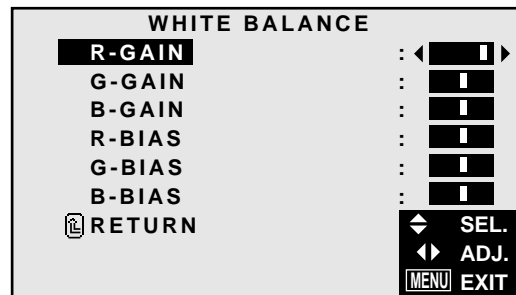

- Once the adjustment is completed...

Press the "MENU" button.
All menus disappear.

Information

■ Adjusting the white balance

RGB-GAIN White balance adjustment for signal level

RGB-BIAS White balance adjustment for black level

■ Restoring the factory default settings

Restoring the factory default settings

Select "RESET" under the function menu. Note that this also restores other settings to the factory defaults.

Reducing noise in the picture

Use these settings if the picture has noise due to poor reception or when playing video tapes on which the picture quality is poor.

Example: Setting "NR-3"

Press the **MENU** button on the remote controller to display the **MAIN MENU** on the screen, then...

1. Use the **▲** and **▼** buttons to select "PICTURE", then press the "OK" button.
The "PICTURE" screen appears.
2. Use the **▲** and **▼** buttons to select "NR".

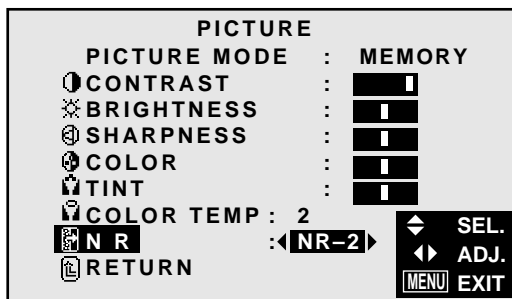

3. Use the **◀** and **▶** buttons to select "NR-3".
The mode switches as follows when the **◀** and **▶** buttons are pressed:

→ OFF ↔ NR-1 ↔ NR-2 ↔ NR-3 ←



* If neither the **◀** or **▶** button is pressed within 5 seconds, the current selection is set and the previous screen reappears.

4. Press the "OK" button.
The noise reduction mode is set to "NR-2".

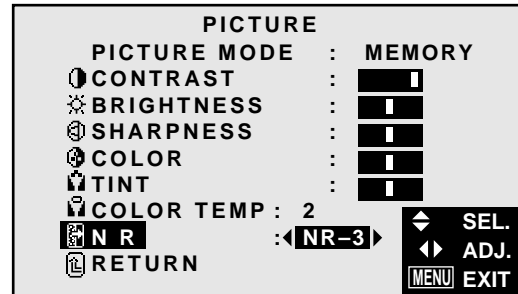

5. Once the setting is completed ...
Press the "MENU" button.
All menus disappear.

Information

■ NR

- * "NR" stands for Noise Reduction.
- * This function reduces noise in the picture.

■ Types of noise reduction

There are three types of noise reduction. Each has a different level of noise reduction.

The effect becomes stronger as the number increases (in the order NR-1 → NR-2 → NR-3).

OFF Turns the noise reduction function off.

Sound Settings Menu

Adjusting the treble, bass and left/right balance

The treble, bass and left/right balance can be adjusted to suit your tastes.

Example: Adjusting the bass

Press the **MENU** button on the remote controller to display the **MAIN MENU** on the screen, then...

1. Use the ▲ and ▼ buttons to select “**SOUND**”, then press the “**OK**” button.
The “**SOUND**” screen appears.
2. *To adjust the bass ...*
Use the ▲ and ▼ buttons to select “**BASS**”.

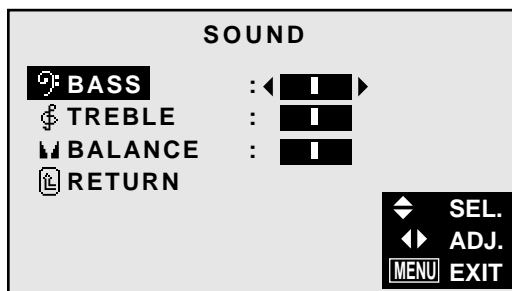

3. Adjust the bass using the ◀ and ▶ buttons.

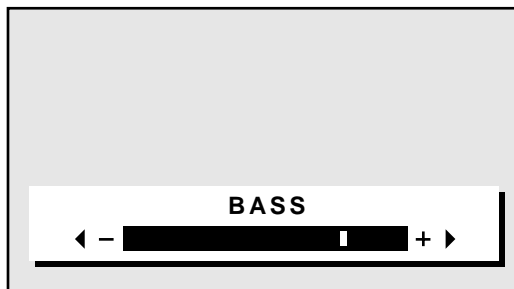

* If neither the ◀ or ▶ button is pressed within 5 seconds, the current selection is set and the previous screen reappears.

To continue adjusting the sound ...
Repeat from step 2.

4. Press the “**OK**” button.
The bass has now been adjusted.

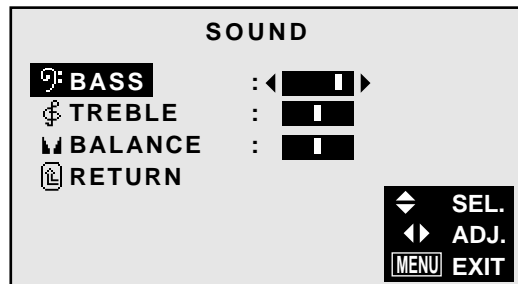

5. Once the adjustment is completed ...
Press the “**MENU**” button.
All menus disappear.

Information

■ Sound settings menu

- BASS** Changes the level of low frequency sound.
- TREBLE** Changes the level of high frequency sound.
- BALANCE** Changes the balance of the left and right channels.

■ Restoring the factory default settings

Select “**RESET**” under the function menu. Note that this also restores other settings to the factory defaults.

Screen Settings Menu

Adjusting the position and size of the wide screen

The position and size of the wide screen can be fine-adjusted.

Example: Adjusting the vertical position in the zoom mode

Press the **MENU** button on the remote controller to display the **MAIN MENU** on the screen, then...

- Use the **▲** and **▼** buttons to select "SCREEN", then press the "OK" button. The "SCREEN" screen appears.
- Use the **▲** and **▼** buttons to select "WIDE ADJ.", then press the "OK" button.

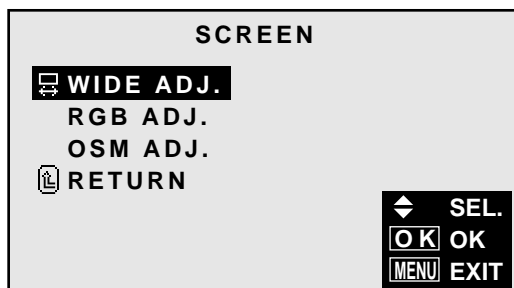

The "WIDE ADJ." screen appears.

- To adjust the zoom mode ... Use the **◀** and **▶** buttons to select "ZOOM". The mode switches as follows when the **◀** and **▶** buttons are pressed:

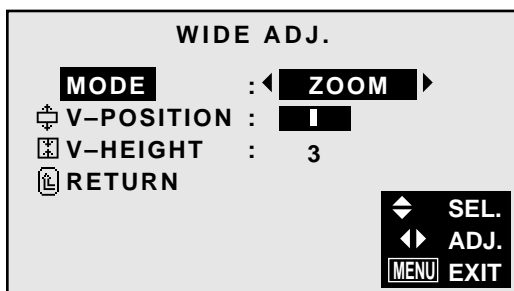
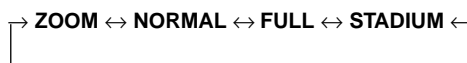

*The mode can also be switched by pressing the "WIDE/AUTO WIDE" button on the remote controller.

- To adjust the vertical position ... Use the **▲** and **▼** buttons to select "V-POSITION".
- Adjust using the **◀** and **▶** buttons.

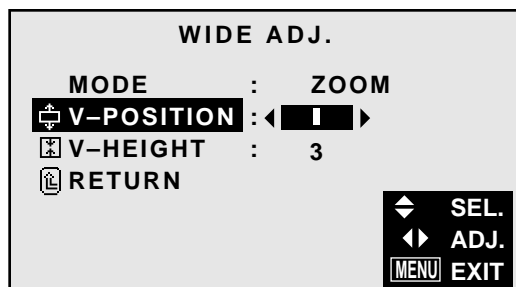

* If neither the **◀** or **▶** button is pressed within 5 sec-

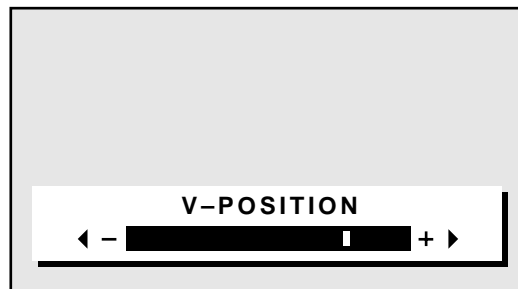

onds, the current adjustment is set and the previous screen reappears.

To continue making other wide screen adjustments ... Repeat from step 4.

- Press the "OK" button. The wide screen's vertical position has now been adjusted.
- Once the adjustment is completed ...

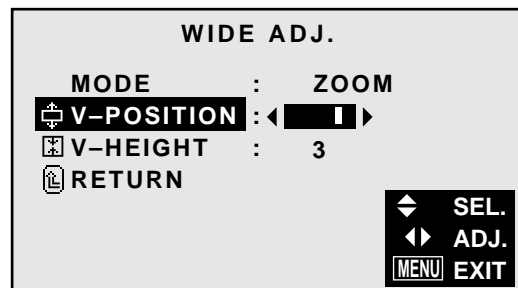

Press the "MENU" button. All menus disappear.

Information

■ Adjusting the wide screen

V-POSITION Adjusts the vertical position of the picture.

V-HEIGHT Adjusts the vertical size of the picture.

■ Restoring the factory default settings

Select "RESET" under the function menu. Note that this also restores other settings to the factory defaults.

Adjusting the Position, Fine Picture, Picture Adj and Auto Picture of a computer image

When a computer image is displayed, the position of the image can be adjusted and flickering of the image can be corrected.

Example: Adjusting the vertical position in the normal mode

Press the **MENU** button on the remote controller to display the **MAIN MENU** on the screen, then...

1. Use the **▲** and **▼** buttons to select "SCREEN", then press the "OK" button.
The "SCREEN" menu appears.

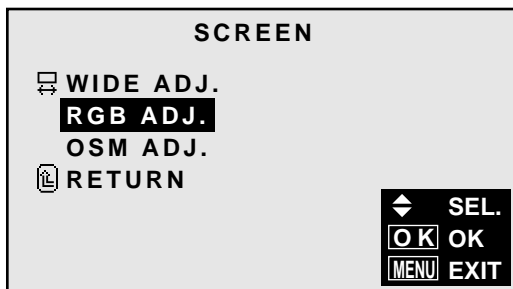

The "RGB ADJ." screen appears.

3. *To adjust the normal mode ...*
Use the **◀** and **▶** buttons to select "NORMAL".
The mode switches as follows when the **◀** and **▶** buttons are pressed:

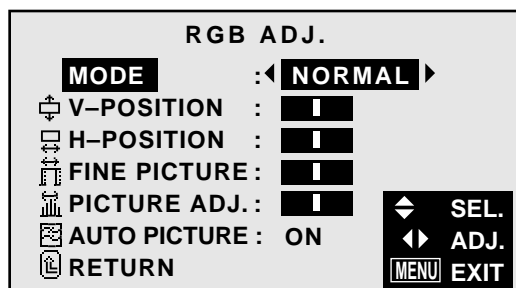
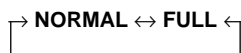

* The mode can also be switched by pressing the "WIDE/AUTO WIDE" button on the remote controller.

4. *To adjust the vertical position ...*
Use the **▲** and **▼** buttons to select "V-POSITION".

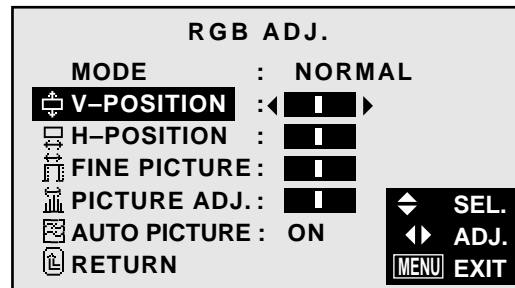

5. Adjust using the **◀** and **▶** buttons.

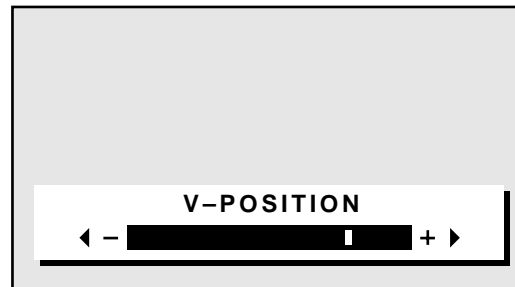

* If neither the **◀** or **▶** button is pressed within 5 seconds, the current adjustment is set and the previous screen reappears.

To continue making other computer image adjustments ...
Repeat from step 4.

6. Press the "OK" button.
The vertical position of the computer's image has now been adjusted.

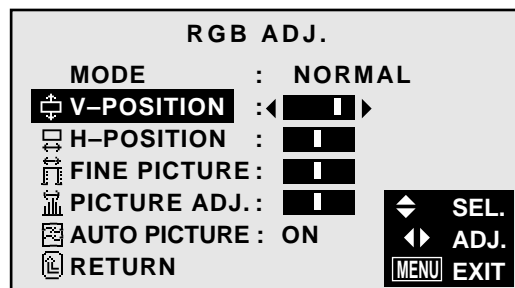

7. *Once all adjustments are completed ...*
Press the "MENU" button.
All menus disappear.

Information

■ Screen modes

FULL* The image is displayed over the entire screen. Set this mode for wide images. (16 : 9)

NORMAL* Set this mode for the same size as video pictures with a 4 : 3 aspect ratio.

An 800 × 600 input signal is converted to a 640 × 480 resolution image.

An 1024 × 768 input signal is converted to a 640 × 480 resolution image.

An 1280 × 1024 input signal is converted to a 597 × 478 resolution image.

* For compatibility set Table for Signals Supported on page 50.

Adjusting the position of the computer image

V-POSITION Adjusts the vertical position of the image.

H-POSITION Adjusts the horizontal position of the image.

FINE PICTURE .. Adjusts for flickering.

PICTURE ADJ. ... Adjusts for striped patterns on the image.

AUTO PICTURE .. Turn this on to have the monitor automatically adjust "FINE PICTURE"

■ Restoring the factory default settings

Select "RESET" under the function menu. Note that this also restores other settings to the factory defaults.

Adjusting the position of the menu display

Use these operations to adjust the position of the menus that appear on screen.

Example: Adjusting the vertical position of the menu display

Press the **MENU** button on the remote controller to display the **MAIN MENU** on the screen, then...

1. Use the ▲ and ▼ buttons to select “**SCREEN**”, then press the “**OK**” button.
The “**SCREEN**” menu appears.
2. Use the ▲ and ▼ buttons to select “**OSM ADJ.**”, then press the “**OK**” button.

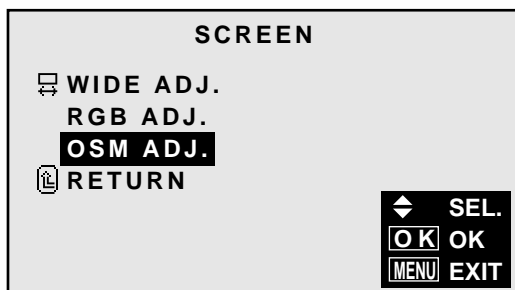

The “**OSM ADJ.**” screen appears.

3. To adjust the vertical position ...
Use the ▲ and ▼ buttons to select “**V-POSITION**”.

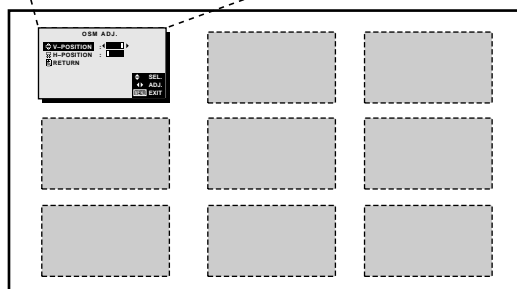
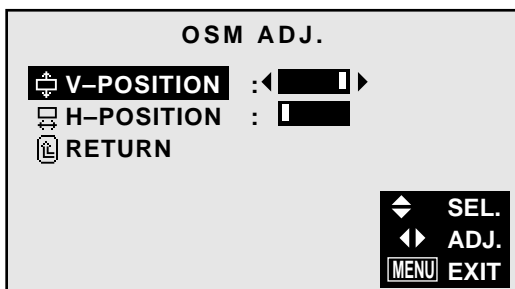

4. Adjust using the ◀ and ▶ buttons.

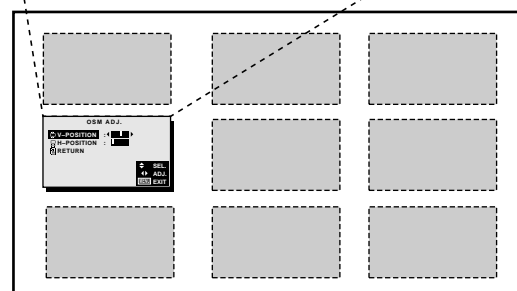
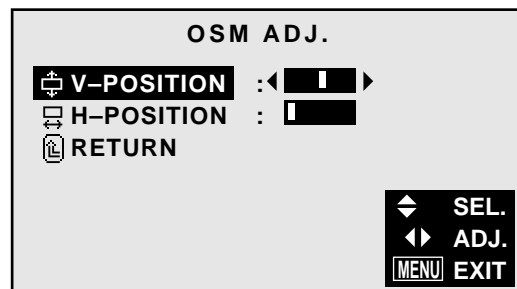

To continue making other menu position adjustments...
Repeat from step 3.

5. Once all adjustments are completed ...
Press the “**MENU**” button.
The menu disappears.

Information

■ Adjusting the position of the menu display

V-POSITION Adjusts the vertical position of the menu display.

H-POSITION Adjusts the horizontal position of the menu display.

■ Restoring the factory default settings

Select “**RESET**” under the function menu. Note that this also restores other settings to the factory defaults.

Function Settings Menu

Setting the power management for computer images

This energy-saving (power management) function automatically reduces the monitor's power consumption if no operation is performed for a certain amount of time.

Example: Turning the power management function on

Press the **MENU** button on the remote controller to display the **MAIN MENU** on the screen, then...

- Use the ▲ and ▼ buttons to select "FUNCTION", then press the "OK" button.
The "FUNCTION" screen appears.
- Use the ▲ and ▼ buttons to select "POWER MGT".

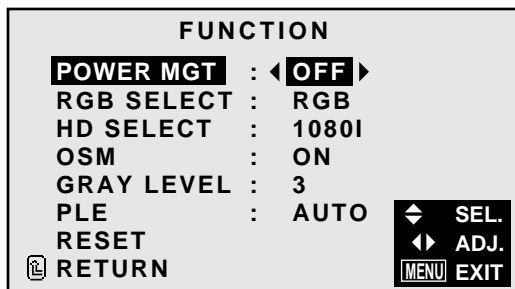

- To turn the power management function on ...
Use the ◀ and ▶ buttons to select "ON".
The mode switches as follows each time the ◀ or ▶ button is pressed:

ON ↔ OFF

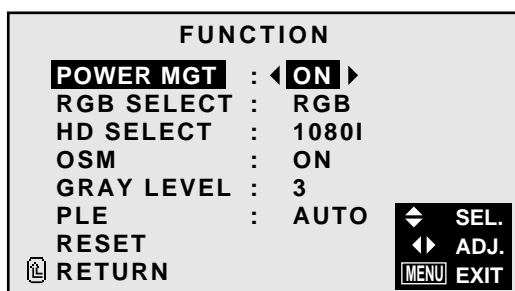

- Once the setting is completed ...
Press the "MENU" button.
The power management function is turned on, and the menu disappears.

Information

■ Power management function

- * The power management function automatically reduces the monitor's power consumption if the computer's keyboard or mouse is not operated for a certain amount of time. This function can be used when using the monitor with a computer conforming to the VESA DPMS format.
- * If the computer's power is not turned on or if the computer and selector tuner are not properly connected, the system is set to the off state.
- * For instructions on using the computer's power management function, refer to the computer's operating instructions.

■ Power management settings

- ON In this mode the power management function is turned on.
- OFF In this mode the power management function is turned off.

■ Power management function and POWER/STANDBY indicator

The POWER/STANDBY indicator indicates the status of the power management function. See page 30 for indicator status and description.

POWER/STANDBY indicator

Power management mode	POWER/STANDBY indicator	Power management operating status	Description	Turning the picture back on
On	Green	Not activated.	Horizontal and vertical synchronizing signals are present from the computer.	Picture already on.
Standby	Yellow	Activated.	No horizontal synchronizing signals are sent from the computer.	Operate the keyboard or mouse. The picture reappears immediately.
Suspend	Red	Activated.	No vertical synchronizing signals are sent from the computer.	Operate the keyboard or mouse. The picture reappears, but more time is required than from the standby mode.
Off	Red	Activated.	No horizontal or vertical synchronizing signals are sent from the computer.	Operate the keyboard or mouse. The picture reappears, but more time is required than from the standby mode or suspend mode.

Setting a computer image to the correct RGB select screen

On the computer image select the RGB mode, moving image (video) mode, wide mode or digital broadcast.

Example: Setting the RGB SELECT mode to "VIDEO"

Press the MENU button on the remote controller to display the MAIN MENU on the screen, then...

1. Use the ▲ and ▼ buttons to select "FUNCTION", then press the "OK" button.
The "FUNCTION" screen appears.
2. Use the ▲ and ▼ buttons to select "RGB SELECT".

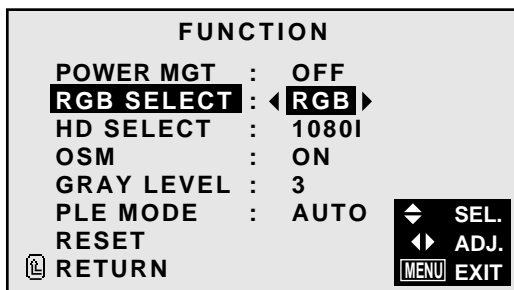

3. To set the RGB select mode to "VIDEO" ...
Use the ◀ and ▶ buttons to select "VIDEO".
The mode switches as follows each time the ◀ or ▶ button is pressed:

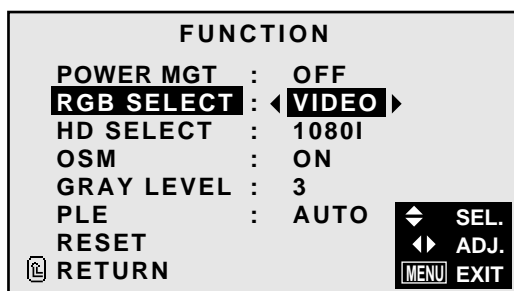

4. Once the setting is completed ...
Press the "MENU" button.
The RGB select mode is set to "VIDEO", and the menu disappears.

Information

■ RGB SELECT modes

These 4 mode are not displayed in correct image automatically.

RGB VESA 640×480@60Hz (Use this mode for normal computer images.)

VIDEO To display the video signal that is converted to the RGB signal, set this mode.

WIDE When an 852 dot× 480 line signal with a vertical frequency of 31.72 KHz is input, the image may be compressed horizontally. To prevent this, set RGB SELECT to WIDE.

DTV Set this model when watching digital broadcasting (480P).

■ Restoring the factory default settings

Select "RESET" under the function menu. Note that this also restores other settings to the factory defaults.

Setting high definition images to the suitable screen size

Use this procedure to set whether the number of vertical lines of the input high definition image is 1035 or 1080.

Example: Setting the "1080I" mode to "1035I"

Press the **MENU** button on the remote controller to display the **MAIN MENU** on the screen, then...

1. Use the **▲** and **▼** buttons to select "FUNCTION", then press the "OK" button.
The "FUNCTION" screen appears.
2. Use the **▲** and **▼** buttons to select "HD SELECT".

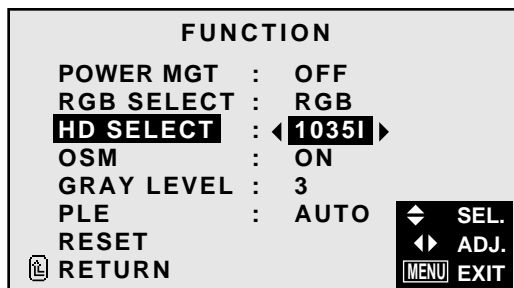

3. To set the HD select mode to "1080I" ...
Use the **◀** and **▶** buttons to select "1080I".
The mode switches as follows each time the **◀** or **▶** button is pressed:

1080I ↔ 1035I

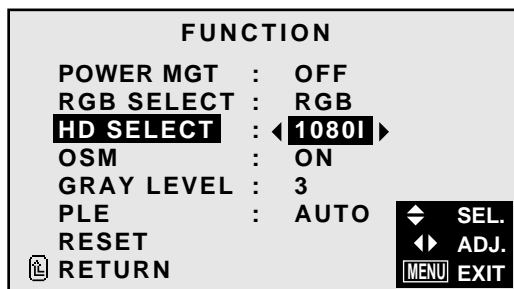

5. Once the setting is completed ...
Press the "MENU" button.
All menus disappear.

Information

■ HD SELECT modes

These 2 mode are not displayed in correct image automatically.

1080I..... Digital broadcasts

1035I..... Japanese "High Vision" signal format

Setting the on-screen display

When using the monitor for presentations, etc., the monitor can be set so that the input source, screen mode, etc., do not appear.

Example: Turning the on-screen display mode off

Press the **MENU** button on the remote controller to display the **MAIN MENU** on the screen, then...

1. Use the ▲ and ▼ buttons to select "FUNCTION", then press the "OK" button.
The "FUNCTION" screen appears.
2. Use the ▲ and ▼ buttons to select "OSM".

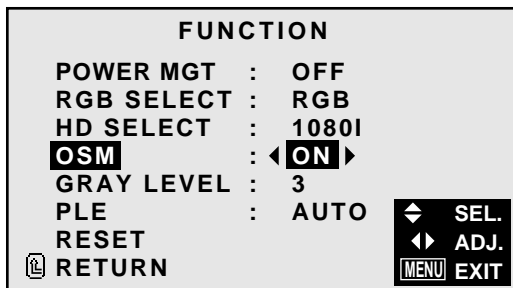

3. To turn the on-screen display mode off...
Use the ◀ and ▶ buttons to select "OFF".
The mode switches as follows each time the ◀ or ▶ button is pressed:
ON ↔ OFF

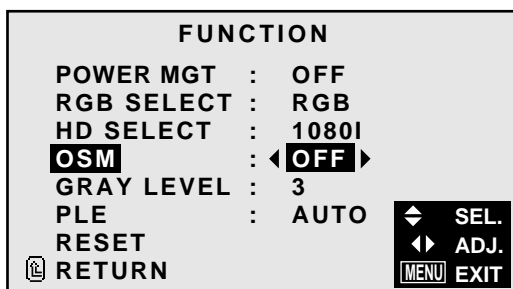

4. Once the setting is completed ...
Press the "MENU" button.
The on-screen display mode is turned off, and the menu disappears.

Information

■ OSM modes

ON The on-screen display appears.
OFF The on-screen display does not appear.

Setting the gray level for the sides of the screen

Use this procedure to set the gray level for the parts on the sides of the screen on which nothing is displayed when the screen is set to the 4:3 size.

Example: Adjusting the "GRAY LEVEL"

Press the **MENU** button on the remote controller to display the **MAIN MENU** on the screen, then...

1. Use the ▲ and ▼ buttons to select "FUNCTION", then press the "OK" button.
The "FUNCTION" screen appears.
2. Use the ▲ and ▼ buttons to select "GRAY LEVEL".

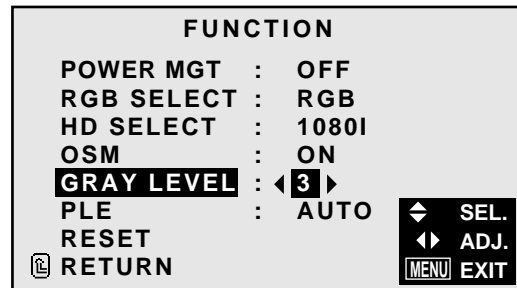

3. To adjust the "GRAY LEVEL"...
Adjust the GRAY LEVEL use the ◀ and ▶ buttons.

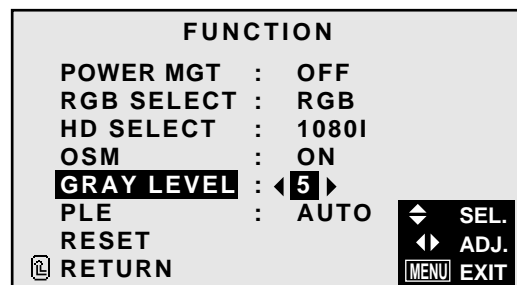

5. Once the setting is completed ...
Press the "MENU" button.
All menus disappear.

Information

■ GRAY LEVEL

This adjusts the brightness of the black (the gray level) for the sides of the screen.
The standard is 0 (black). The level can be adjusted from 1 to 15. The factory setting is 3 (dark gray).

■ Restoring the factory default settings

Select "RESET" under the function menu. Note that this also restores other settings to the factory defaults.

Setting the brightness level to the minimum

Locking this mode allows you to dim the picture.

Example: Setting the "PLE" to "LOCK"

Press the MENU button on the remote controller to display the MAIN MENU on the screen, then...

1. Use the ▲ and ▼ buttons to select "FUNCTION", then press the "OK" button.
The "FUNCTION" screen appears.
2. Use the ▲ and ▼ buttons to select "PLE".

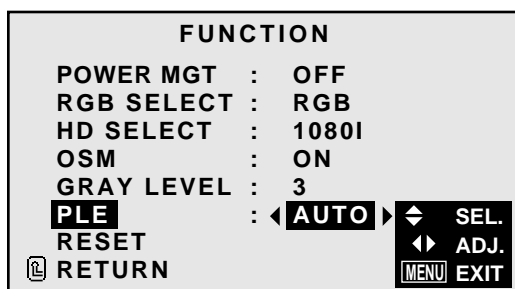

3. To set the PLE to "LOCK" ...
Use the ◀ and ▶ buttons to select "LOCK".
The mode switches as follows each time the ◀ or ▶ button is pressed:
AUTO ↔ LOCK

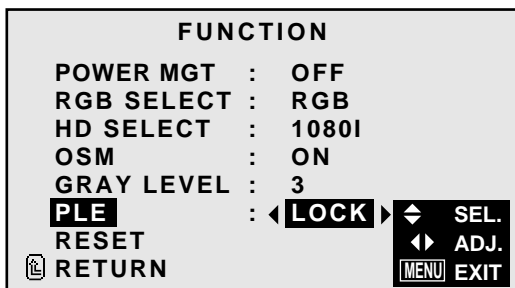

4. Once the setting is completed ...
Press the "MENU" button.
All menus disappear.

Information

■ PLE

AUTO Normally set to AUTO.
LOCK Sets the brightness level to the minimum.

Resetting to the default values

Use these operations to restore all the picture adjustments, audio settings, wide adjustments, RGB adjustments, OSM adjustments, etc., to the factory default values.

Press the MENU button on the remote controller to display the MAIN MENU on the screen, then...

1. Use the ▲ and ▼ buttons to select "FUNCTION", then press the "OK" button.
The "FUNCTION" screen appears.
2. Use the ▲ and ▼ buttons to select "RESET", then press the "OK" button.

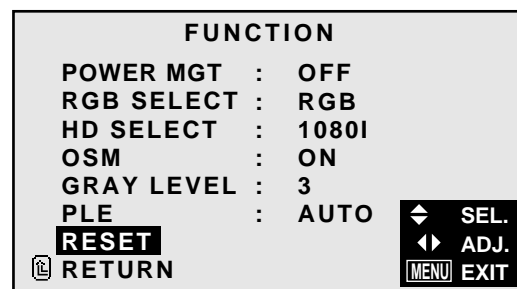

The "RESET" screen appears.

3. Use the ▲ and ▼ buttons to select "RESET", then press the "OK" button.

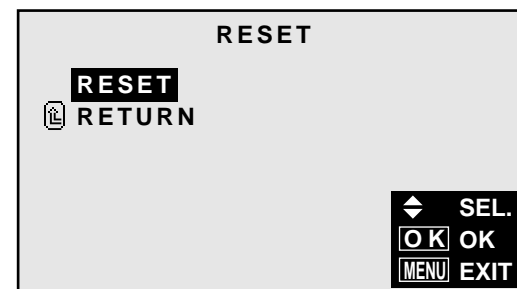

All the settings are restored to the default values.

4. Once the setting is completed ...
Press the "MENU" button.
The menu disappears.

Information Menu

Checking the frequencies and polarities of input signals

Use this function to check the frequencies and polarities of the signals currently being inputted from a computer, etc.

Press the MENU button on the remote controller to display the MAIN MENU on the screen, then...

1. Use the ▲ and ▼ buttons to select “INFORMATION”, then press the “OK” button.
The “INFORMATION” screen appears.
2. Use the ▲ and ▼ buttons to select “FREQUENCY”, then press the “OK” button.

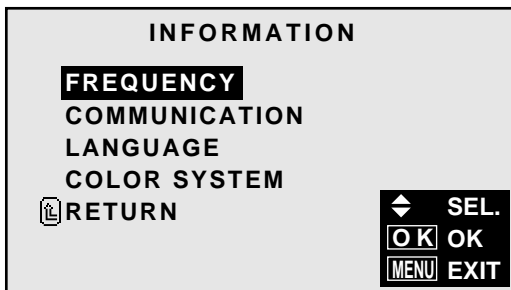

3. The frequency is displayed.

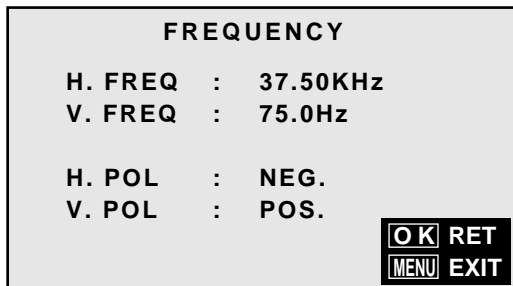

* Press the “OK” button to return to the previous screen.

4. Once you have checked the frequency ...
Press the “MENU” button.
The menu disappears.

Setting the language for the menus

The menu display can be set to one of seven languages: Japanese, English, German, French, Swedish, Italian or Spanish.

Example: Setting the menu display to "DEUTSCH"

Press the MENU button on the remote controller to display the MAIN MENU on the screen, then...

1. Use the ▲ and ▼ buttons to select "INFORMATION", then press the "OK" button.
The "INFORMATION" screen appears.
2. Use the ▲ and ▼ buttons to select "LANGUAGE", then press the "OK" button.

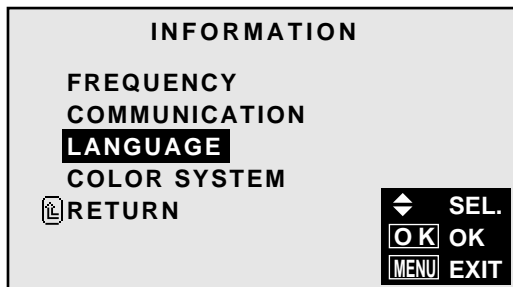

The "LANGUAGE" screen appears.

3. Use the ▲ and ▼ buttons to select "LANGUAGE".

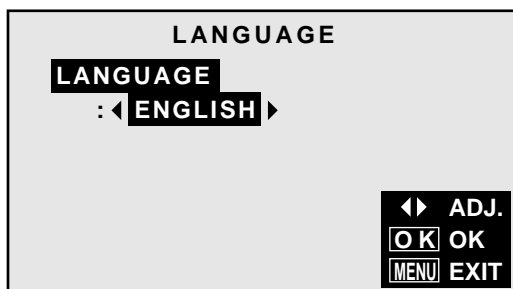

4. To select "DEUTSCH" ...
Use the ◀ and ▶ buttons to select "DEUTSCH".
The mode switches as follows when the ◀ and ▶ buttons are pressed:

→ ENGLISH ↔ DEUTSCH ↔ FRANÇAIS ←
→ 日本語 ↔ SVENSKA ↔ ITALIANO ↔ ESPAÑOL ←

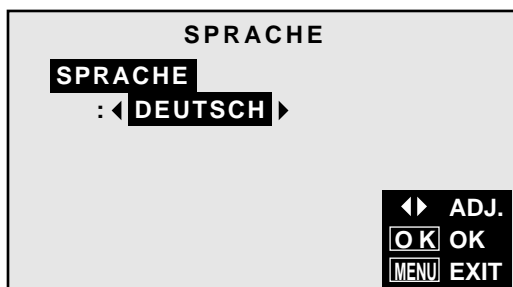

5. Press the "OK" button.
The display language is switched to Deutsch.
6. Once the setting is completed ...
Press the "MENU" button.
The menu disappears.

Information

■ Language settings

ENGLISH	English
DEUTSCH	German
FRANÇAIS	French
ESPAÑOL	Spanish
ITALIANO	Italian
SVENSKA	Swedish
日本語	Japanese

Setting the video signal format

Use these operations to set the video signal format (PAL, SECAM, 4.43 NTSC or 3.58 NTSC).

Example: Setting the video signal format to “3.58 NTSC”

Press the **MENU** button on the remote controller to display the **MAIN MENU** on the screen, then...

1. Use the ▲ and ▼ buttons to select “**INFORMATION**”, then press the “**OK**” button. The “**INFORMATION**” screen appears.
2. Use the ▲ and ▼ buttons to select “**COLOR SYSTEM**”, then press the “**OK**” button.

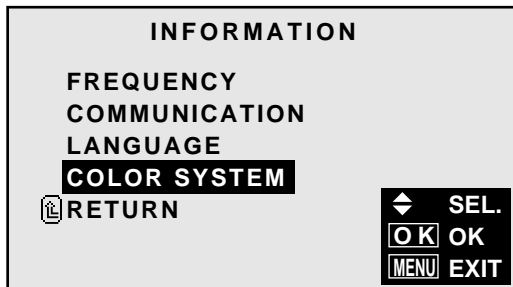

The “**COLOR SYSTEM**” screen appears.

3. Use the ▲ and ▼ buttons to select “**COLOR SYSTEM**”.

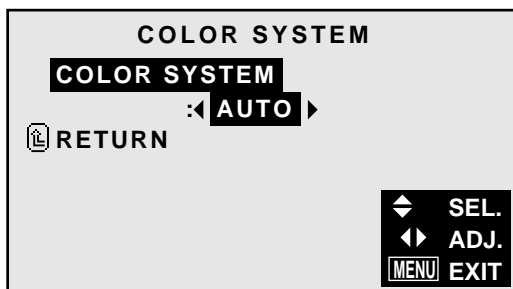

4. To select “**3.58 NTSC**” ...

Use the ◀ and ▶ buttons to select “**3.58 NTSC**”. The mode switches as follows when the ◀ and ▶ buttons are pressed:

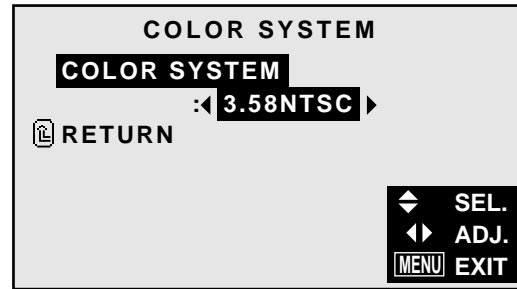

5. Once the setting is completed ...

Press the “**MENU**” button.

The color system is set to “**3.58 NTSC**”, and the menu disappears.

Information

■ Video signal formats

Different countries use different formats for video signals. Set to the format used in your current country.

AUTO The video signals are automatically detected and the format is set accordingly.

PAL This is the standard format used mainly in the United Kingdom and Germany.

SECAM This is the standard format used mainly in France and Russia.

4.43 NTSC This format is used for videos in countries using PAL and SECAM video signals.

3.58 NTSC This is the standard format used mainly in Japan and the United States.

External Control

Application

These specifications cover the communications control of the PlasmaSync 4210W by external equipment.

Connections

Connections are made as described below.

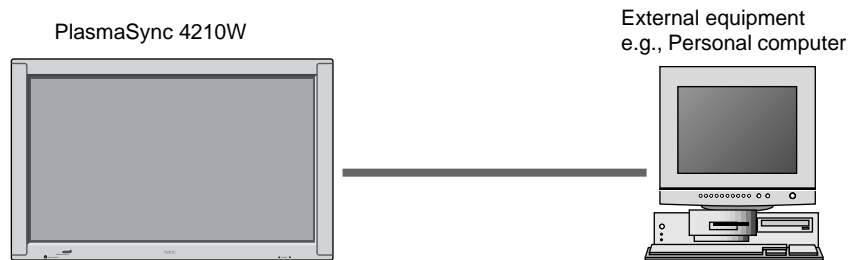

- 1) Connector on the PlasmaSync 4210W side: EXTERNAL CONTROL connector.

Type of connector: D-Sub 9-pin male

No.	Pin Name
1	No Connection
2	RXD (Receive data)
3	TXD (Transmit data)
4	DTR (DTE side ready)
5	GND
6	DSR (DCE side ready)
7	RTS (Ready to send)
8	CTS (Clear to send)
9	No Connection

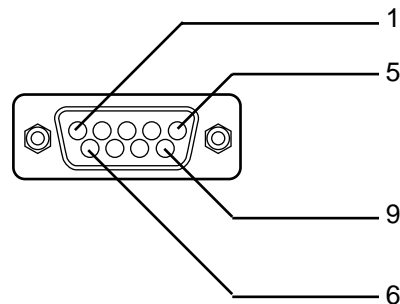

- 2) Connector on the external equipment side: Serial port (RS-232C) connector
See the specifications of the equipment that is to be connected for the type of connector and the pin assignment.

- 3) Wiring

Use a crossed (reverse) cable.

Wire the cable so that each pair of data lines cross between the two devices. These data line pairs are RXD (Receive data) and TXD (Transmit data), DTR (DTE side ready) and DSR (DCE side ready), and RTS (Ready to send) and CTS (Clear to send).

Communication Parameters

- | | |
|--------------------------|--------------|
| (1) Communication system | Asynchronous |
| (2) Interface | RS-232C |
| (3) Baud rate | 9600 bps |
| (4) Data length | 8 bits |
| (5) Parity | Odd |
| (6) Stop bit | 1 bit |
| (7) Communication code | Hex |

Communication Format

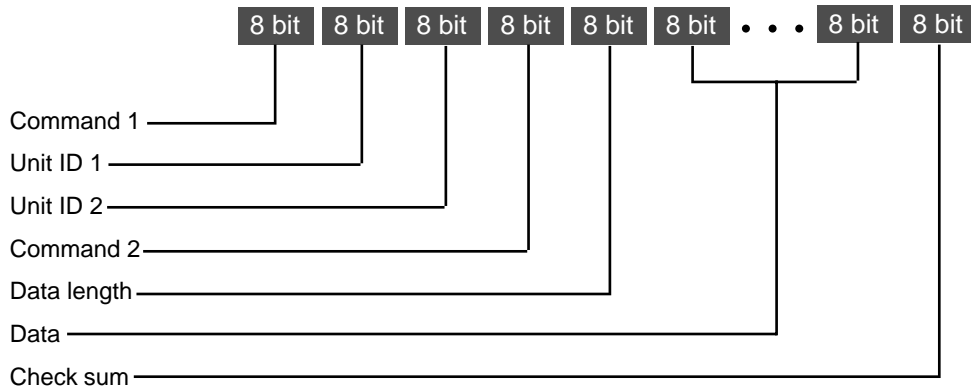

Command 1

Command 1, along with command 2, is a number used to distinguish each command.

In the case of ACK, when the lower order 4 bits is FH (as in 3FH and 7FH), this indicates that the commands and data of the supported equipment have been received. When the lower order 4 bits is BH (as in 3BH and 7BH), this indicates that unsupported commands and data have been received.

Unit ID 1 and Unit ID 2

Unit ID 1 and unit ID 2 are numbers used to identify the equipment that is to be connected.

60H is used for the PlasmaSync 4210W and 80H is used for external control equipment such as a personal computer.

- 1) Unit ID 1: Indicates the equipment sending the signal
- 2) Unit ID 2: Indicates the equipment receiving the signal

Command 2

Command 2, along with command 1, is a number used to distinguish each command.

Check Sum (CKS), Error Processing, and ACK

- 1) The check sum described below and RS-232C odd parity are used together for a check of the received data. The check sum is the lower order 8 bits of one frame of sent or received data comprising the sum total of Command 1, Unit ID 1 and 2, Command 2, Data Length, and Data.

Check Sum Example

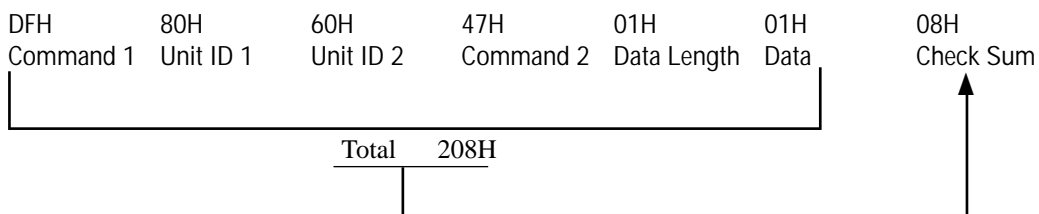

2) Error Processing

- When the communication interval is vacant for more than 4 ms, thereafter a received Command 1 will be recognized. If, at this time, meaningful data cannot be recognized, that data will not be recognized (as valid data).
- An ACK will not be returned unless the receive data error, the check sum error, and the receive data are all taken in.

Communications Flow

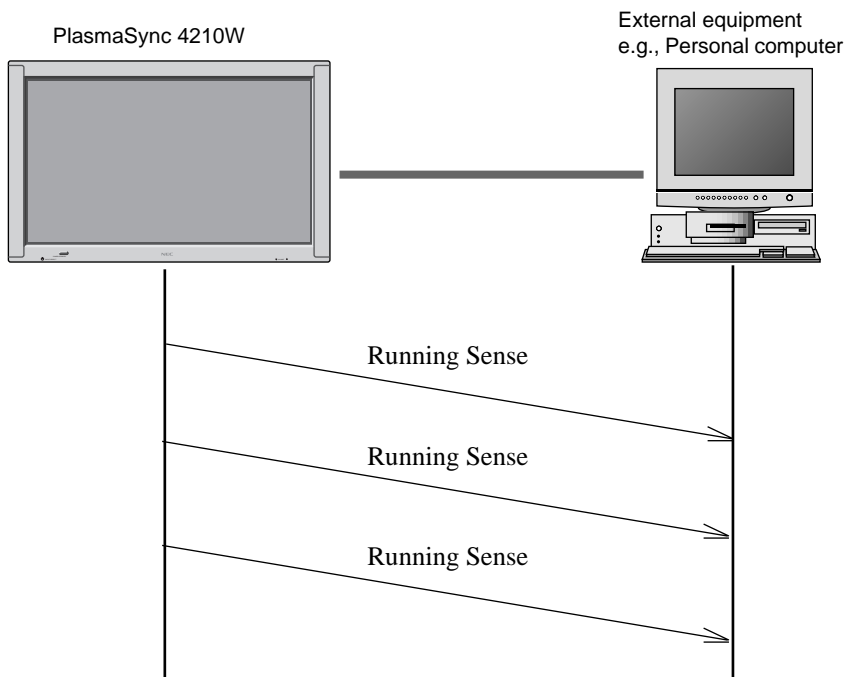

The PlasmaSync 4210W regularly transmits a Running Sense command at an interval of approximately 1 second.

(Running Sense command: 1FH 60H E0H 88H 00H E7H)

This command is used to recognize optional equipment. The return of an ACK is not required when external equipment such as a personal computer has been connected.

Note that destruction of this data is recommended when it is taken in.

When various commands are to be sent from external equipment such as a personal computer, the PlasmaSync 4210W is always receive enabled.

Note that when an ACK has not been returned from the PlasmaSync 4210W in 1.5 seconds, a resending of the command is recommended.

Command Reference List

		CMD1	CMD2	LEN
01.	Power ON	9FH	4EH	00H
02.	Power OFF	9FH	4FH	00H
03.	Input Switch Change	DFH	47H	01H
04.	VOLUME Gain Data	DFH	7FH	03H
05.	SCREEN MODE Select	DFH	51H	01H
06.	AUDIO Mute On	9FH	3EH	00H
07.	AUDIO Mute Off	9FH	3FH	00H
08.	OSM Select	DFH	58H	01H
09.	Color Gain Data	DFH	7FH	03H
10.	TINT Gain Data	DFH	7FH	03H
11.	SHARPNESS Gain Data	DFH	7FH	03H
12.	CONTRAST Gain Data	DFH	7FH	03H
13.	BRIGHT Gain Data	DFH	7FH	03H
14.	Input MODE Request	1FH	41H	00H
15.	RESET	1FH	54H	00H
16.	COLOR TEMP SELECT	DFH	00H	01H
17.	RED Gain Data	DFH	7FH	04H
18.	GREEN Gain Data	DFH	7FH	04H
19.	BLUE Gain Data	DFH	7FH	04H
20.	VIDEO ADJ Request	1FH	45H	00H

01. Power ON

Function

The external control equipment switches on the power of the PlasmaSync 4210W.

Transmission Data

9FH 80H 60H 4EH 00H CKS

ACK

The PlasmaSync 4210W returns the following ACK when the power is switched on.

3FH 60H 80H 4EH 00H CKS

02. Power OFF

Function

The external control equipment switches off the power of the PlasmaSync 4210W.

Transmission Data

9FH 80H 60H 4FH 00H CKS

ACK

The PlasmaSync 4210W returns the following ACK when the power is switched off.

3FH 60H 80H 4FH 00H CKS

03. Input Switch Change

Function

The external control equipment switches the input of the PlasmaSync 4210W.

Transmission Data

DFH 80H 60H 47H DATA00 CKS

DATA00 01H: Video
05H: HD (DVD, DTV)
07H: PC

ACK

The PlasmaSync 4210W returns the following ACK when the input is switched.

3FH 60H 80H 47H 00H CKS

04. VOLUME Gain Data

Function

The external control equipment changes the VOLUME gain data of the PlasmaSync 4210W.

Transmission Data

DFH 80H 60H 7FH 03H DATA00 DATA01 DATA02 CKS

DATA00: USER SOUND Gain Flag 05H

DATA01: VOLUME Gain Flag 01H

DATA02: VOLUME Gain

00H: Step 0

|

0AH: Step 10 (Default)

|

2AH: Step 42

ACK

7FH 60H 80H 7FH 02H DATA00 DATA01 CKS

DATA00: USER SOUND Gain Flag 05H

DATA01: VOLUME Gain Flag 01H

05. SCREEN MODE Select

Function

The external control equipment switches the screen mode of the PlasmaSync 4210W.

Transmission Data

DFH 80H 60H 51H 01H 01H DATA00 CKS

DATA00 02H : STADIUM

03H : ZOOM

04H : NORMAL

05H : FULL

ACK

7FH 60H 80H 51H 01H DATA00 CKS

DATA00 02H : STADIUM

03H : ZOOM

04H : NORMAL

05H : FULL

06. AUDIO Mute On

Function

The external control equipment switches on AUDIO Mute of the PlasmaSync 4210W.

Transmission Data

9FH 80H 60H 3EH 00H CKS

ACK

3FH 60H 80H 3EH 00H CKS

07. AUDIO Mute Off

Function

The external control equipment switches off AUDIO Mute of the PlasmaSync 4210W.

Transmission Data

9FH 80H 60H 3FH 00H CKS

ACK

3FH 60H 80H 3FH 00H CKS

08. OSD Select

Function

The external control equipment switches on or off the on-screen display (OSD) of the PlasmaSync 4210W.

Transmission Data

DFH 80H 60H 58H 01H DATA00 CKS

DATA00 01H : Screen display On
02H : Screen display Off

ACK

7FH 60H 80H 58H 01H DATA00 CKS

DATA00 01H : Screen display On
02H : Screen display Off

* Screen display On/Off is equivalent to the screen display On/Off function of the convenient function settings.

Operation is as described in the table below.

Operation	On-Screen Display (OSD)			
	Display of items and adjustments on the menu		Volume display, input display, and screen size display	
	When screen display is ON	When screen display is OFF	When screen display is ON	When screen display is OFF
Remote control operation	Yes	Yes	Yes	No
Personal computer control operation	No	No	Yes	No

09. COLOR Gain Data

Function

The external control equipment changes the COLOR gain data of the PlasmaSync 4210W.

Transmission Data

DFH 80H 60H 7FH 03H DATA00 DATA01 DATA02 CKS

DATA00: USER PICTURE Gain Flag 01H
DATA01: COLOR Gain Flag 04H
DATA02: COLOR Gain EAH: -22
|
FFH: -01
00H: 0
01H: +01
|
16H: +22

ACK

7FH 60H 80H 7FH 02H DATA00 DATA01 CKS

DATA00: USER PICTURE Gain Flag 01H
DATA01: COLOR Gain Flag 04H

10. TINT Gain Data

Function

The external control equipment changes the TINT gain data of the PlasmaSync 4210W.

Transmission Data

DFH 80H 60H 7FH 03H DATA00 DATA01 DATA02 CKS

DATA00: USER PICTURE Gain Flag 01H
DATA01: TINT Gain Flag 05H
DATA02: TINT Gain EAH: -22
|
FFH: -01
00H: 0
01H: +01
|
16H: +22

ACK

7FH 60H 80H 7FH 02H DATA00 DATA01 CKS

DATA00: USER PICTURE Gain Flag 01H
DATA01: TINT Gain Flag 05H

11. SHARPNESS Gain Data

Function

The external control equipment changes the SHARPNESS gain data of the PlasmaSync 4210W.

Transmission Data

DFH 80H 60H 7FH 03H DATA00 DATA01 DATA02 CKS

DATA00: USER PICTURE Gain Flag 01H
DATA01: SHARPNESS Gain Flag 06H
DATA02: SHARPNESS Gain F0H: -16
|
FFH: -01
00H: 0
01H: +01
|
10H: +16

ACK

7FH 60H 80H 7FH 02H DATA00 DATA01 CKS

DATA00: USER PICTURE Gain Flag 01H
DATA01: SHARPNESS Gain Flag 06H

12. CONTRAST Gain Data

Function

The external control equipment changes the CONTRAST gain data of the PlasmaSync 4210W.

Transmission Data

DFH 80H 60H 7FH 03H DATA00 DATA01 DATA02 CKS

DATA00: USER PICTURE Gain Flag 01H
DATA01: CONTRAST Gain Flag 07H
DATA02: CONTRAST Gain 00H : 0
|
34H: +52

ACK

7FH 60H 80H 7FH 02H DATA00 DATA01 CKS

DATA00: USER PICTURE Gain Flag 01H
DATA01: CONTRAST Gain Flag 07H

13. BRIGHT Gain Data

Function

The external control equipment changes the BRIGHT gain data of the PlasmaSync 4210W.

Transmission Data

DFH 80H 60H 7FH 03H DATA00 DATA01 DATA02 CKS

DATA00: USER PICTURE Gain Flag 01H
DATA01: BRIGHT Gain Flag 08H
DATA02: BRIGHT Gain EAH: -22
|
FFH: -01
00H: 0
01H: +01
|
16H: +22

ACK

7FH 60H 80H 7FH 02H DATA00 DATA01 CKS

DATA00: USER PICTURE Gain Flag 01H
DATA01: BRIGHT Gain Flag 08H

14. Input MODE Request

Function

The display returns the current input information by the external control equipment' s request.

Transmission Data

1FH 80H 60H 41H 00H CKS

ACK

7FH 60H 80H 41H 01H DATA00 CKS

DATA00: Input Select
01H: Video
04H: HD, DTV
05H: PC
0AH: DVD

15. RESET

Function

The external control equipment resets the user adjustment of the PlasmaSync 4210W.

Transmission Data

1FH 80H 60H 54H 00H CKS

ACK

3FH 60H 80H 54H 00H CKS

16. COLOR TEMP SELECT

Function

The external control equipment changes the COLOR TEMP of the PlasmaSync 4210W.

Transmission Data

DFH 80H 60H 00H 01H DATA00 CKS

DATA00

00H: 1

01H: 2

02H: 3

03H: PRO

ACK

7FH 60H 80H 00H 01H DATA00 CKS

DATA00:

00H: 1

01H: 2

02H: 3

03H: PRO

NOTE: Set so that at the selection of 1, 2, or 3 of COLOR TEMP change of the following R/G/B GAIN data cannot be accepted. (This must be operated in the same way as OSD menu.)

17. RED Gain Data

Function

The external control equipment changes the RED Gain Data of the PlasmaSync 4210W.

Transmission Data

DFH 80H 60H 7FH 04H DATA00 to DATA03 CKS

DATA00: USER PICTURE Gain Flag 01H

DATA01: RED Gain Flag 01H

DATA02: RED Gain 1 (Bias) F0H: -16
|
FFH: -1
00H: 0
|
10H: +16

DATA03: RED Gain 2 (Drive) F0H: -16
|
FFH: -1
00H: 0
|
10H: +16

ACK

7FH 60H 80H 7FH 02H DATA00 DATA01 CKS

DATA00: USER PICTURE Gain Flag 01H

DATA01: RED Gain Flag 01H

18. GREEN Gain Data

Function

The external control equipment changes the GREEN Gain Data of the PlasmaSync 4210W.

Transmission Data

DFH 80H 60H 7FH 04H DATA00 to DATA03 CKS

DATA00: USER PICTURE Gain Flag	01H
DATA01: GREEN Gain Flag	02H
DATA02: GREEN Gain 1 (Bias)	FOH: -16
	FFH: -1
	00H: 0
	10H: +16
DATA03: GREEN Gain2 (Drive)	FOH: -16
	FFH: -1
	00H: 0
	10H: +16

ACK

7FH 60H 80H 7FH 02H DATA00 DATA01 CKS

DATA00: USER PICTURE Gain Flag	01H
DATA01: GREEN Gain Flag	02H

19. BLUE Gain Data

Function

The external control equipment changes the BLUE Gain Data of the PlasmaSync 4210W.

Transmission Data

DFH 80H 60H 7FH 04H DATA00 to DATA03 CKS

DATA00: USER PICTURE Gain Flag	01H
DATA01: BLUE Gain Flag	03H
DATA02: BLUE Gain1(Bias)	FOH:-16
	FFH:-1
	00H: 0
	10H: +16
DATA03: BLUE Gain2(Drive)	FOH:-16
	FFH:-1
	00H: 0
	10H:+16

ACK

7FH 60H 80H 7FH 02H DATA00 DATA01 CKS

DATA00: USER PICTURE Gain Flag	01H
DATA01: BLUE Gain Flag	03H

20. VIDEO ADJ Request

Function

The display returns the video adjustments information by the external control equipment's request.

Transmission Data

1FH 80H 60H 45H 00H CKS

ACK

7FH 60H 80H 45H 0CH DATA00 to DATA0B CKS

DATA00: RED Gain(Bias)	F0H: -16 FFH: -1 00H: 0 10H: +16
DATA01: GREEN Gain(Bias)	F0H: -16 FFH: -1 00H: 0 10H: +16
DATA02: BLUE Gain(Bias)	F0H: -16 FFH: -1 00H: 0 10H: +16
DATA03: COLOR Gain	EAH: -22 FFH: -01 00H: 0 01H: +01 16H: +22
DATA04: TINT Gain	EAH: -22 FFH: -01 00H: 0 01H: +01 16H: +22
DATA05: SHARPNESS Gain	F0H: -16 FFH: -01 00H: 0 01H: +01 10H: +16

DATA06: CONTRAST Gain	00H: 0 34H: +52
DATA07: BRIGHT Gain	EAH: -22 FFH: -01 00H: 0 01H: +01 16H: +22
DATA08: RED Gain(Drive)	F0H: -16 FFH: -1 00H: 0 10H: +16
DATA09: GREEN Gain(Drive)	F0H: -16 FFH: -1 00H: 0 10H: +16
DATA0A: BLUE Gain(Drive)	F0H: -16 FFH: -1 00H: 0 10H: +16
DATA0B: COLOR TEMP	00H: 1 01H: 2 02H: 3 03H: PRO

Table for Signals Supported

Supported resolution

- When 800 dot × 600 line signals are input, they are converted to 640 dot × 480 line or 853 dot × 480 line signals.
- When 1024 dot × 768 line signals are input, they are converted to 640 dot × 480 line or 853 dot × 480 line signals.
- When 1280 dot × 1024 line signals are input, they are converted to 597 dot × 478 line.

Model	Dots × lines	Vertical frequency (Hz)	Horizontal frequency (kHz)	Screen mode	
				NORMAL	FULL
*IBM PC/AT compatible computers	640 × 400	70.1	31.5	YES	YES
	640 × 480	59.9	31.5	YES	YES
		72.8	37.9	YES	YES
		75.0	37.5	YES	YES
		75.0	39.4	YES	YES
		85.0	43.3	YES	YES
	848 × 480* ²	60.0	31.0	NO	YES
	800 × 600	56.3	35.2	YES* ³	YES
		60.3	37.9	YES* ³	YES
		72.2	48.1	YES* ³	YES
		75.0	46.9	YES* ³	YES
		85.0	53.7	YES* ³	YES* ⁴
	1024 × 768	60.0	48.4	YES* ³	YES
		* ¹ 70.0	56.5	YES* ³	NO
* ¹ 75.0		60.0	YES* ³	NO	
1280 × 1024* ¹	60.0	64.0	YES* ⁵	NO	
*Apple Macintosh	640 × 480	66.6	35.0	YES	YES
	832 × 624	74.6	49.7	YES* ⁶	YES* ⁷
	1024 × 768* ¹	74.6	60.2	YES* ³	NO

*1 Signals with these frequencies are only displayed in the normal mode (4:3).

*2 Only when using a graphic accelerator board that is capable of displaying 848 × 480.

*3 This signal is converted to a 640 × 480 signal.

*4 This signal is converted to a 800 × 480 signal.

*5 This signal is converted to a 597 × 478 signal.

*6 This signal is converted to a 624 × 468 signal.

*7 This signal is converted to a 853 × 468 signal.

* “IBM PC/AT” and “VGA” are a registered trademark of International Business Machines, Inc. of the United States.

* “Apple Macintosh” is a registered trademark of Apple Computer, Inc. of the United States.

Troubleshooting

If the picture quality is poor or there is some other problem, check the adjustments, operations, etc., before requesting service.

Symptom	Checks	Remedy
Picture is disturbed. Sound is noisy. Remote control unit operates erroneously.	<ul style="list-style-type: none"> Is a connected component set directly in front or at the side of the display? 	<ul style="list-style-type: none"> Leave some space between the display and the connected components.
The remote controller does not work.	<ul style="list-style-type: none"> Are the remote controller's batteries worn out? 	<ul style="list-style-type: none"> Replace both batteries with new ones.
Monitor's power does not turn on when the remote controller's power button is pressed.	<ul style="list-style-type: none"> Is the monitor's power cord plugged into a power outlet? 	<ul style="list-style-type: none"> Plug the monitor's power cord into a power outlet.
	<ul style="list-style-type: none"> Are all the monitor's indicators off? 	<ul style="list-style-type: none"> Press the power button on the monitor to turn on the power.
	<ul style="list-style-type: none"> Are the remote controller's batteries worn out? 	<ul style="list-style-type: none"> Replace both batteries with new ones.
Monitor does not operate when the remote controller's buttons are pressed.	<ul style="list-style-type: none"> Is the remote controller pointed at the monitor, or is there an obstacle between the remote controller and the monitor? 	<ul style="list-style-type: none"> Point the remote controller at the monitor's remote control sensor when pressing buttons, or remove the obstacle.
	<ul style="list-style-type: none"> Is direct sunlight or strong artificial light shining on the monitor's remote control sensor? 	<ul style="list-style-type: none"> Eliminate the light by closing curtains, pointing the light in a different direction, etc.
	<ul style="list-style-type: none"> Are the remote controller's batteries worn out? 	<ul style="list-style-type: none"> Replace both batteries with new ones.
No sound or picture is produced.	<ul style="list-style-type: none"> Is the monitor's power cord plugged into a power outlet? 	<ul style="list-style-type: none"> Plug the monitor's power cord into a power outlet.
Picture appears but no sound is produced.	<ul style="list-style-type: none"> Is the volume set at the minimum? 	<ul style="list-style-type: none"> Increase the volume.
	<ul style="list-style-type: none"> Is the mute mode set? 	<ul style="list-style-type: none"> Press the remote controller's mute button.
	<ul style="list-style-type: none"> Are the speakers properly connected? 	<ul style="list-style-type: none"> Connect the speakers properly.
Tint is poor or colors are weak.	<ul style="list-style-type: none"> Are the tint and colors properly adjusted? 	<ul style="list-style-type: none"> Adjust the tint and color (under "PICTURE").
Nothing appears on screen.	<ul style="list-style-type: none"> Is the computer's power turned on? 	<ul style="list-style-type: none"> Turn on the computer's power.
	<ul style="list-style-type: none"> Is a source connected? 	<ul style="list-style-type: none"> Connect source to the monitor.
	<ul style="list-style-type: none"> Is the power manager function in the standby or off mode? 	<ul style="list-style-type: none"> Operate the computer (move the mouse, etc.).
Part of picture is cut off or picture is not centered.	<ul style="list-style-type: none"> Is the position adjustment appropriate? 	<ul style="list-style-type: none"> Adjust the "RGB ADJ." properly.
Image is too large or too small.	<ul style="list-style-type: none"> Is the screen size adjustment appropriate? 	<ul style="list-style-type: none"> Press the "WIDE/AUTO WIDE" button on the remote controller and adjust properly.
Picture is unstable.	<ul style="list-style-type: none"> Is the computer's resolution setting appropriate? 	<ul style="list-style-type: none"> Set to the proper resolution.

Specifications

Product Name	PlasmaSync™ 4210W Plasma Monitor
Product Code	PX-42M5A
Screen Size	36.3"(H) × 20.4"(V) inches 921(H) × 518.4(V) mm diagonal 42"
Aspect Ratio	16 : 9
Resolution	853(H) × 480(V) pixels
Pixel Pitch	0.04"(H) × 0.04"(V) inches 1.08(H) × 1.08(V) mm
Color Reproduction	256 levels, 16,770,000 colors
Signals	
Synchronization Range	Horizontal : 15.5 to 64.0 kHz (automatic : step scan) Vertical : 50.0 to 85.0 Hz (automatic : step scan)
Input Signals	RGB, NTSC, PAL, SECAM, HD, DVD, DTV*
RGB Input terminals	
Visual	mini D-sub 15-pin × 1
Audio	Stereo RCA × 1
Video Input terminals	
Visual	RCA × 1 (S-Video: 4-pin DIN × 1)
Audio	Stereo RCA × 1
DVD/HD Input terminals	
Visual	RCA (Y/Y, Cb/Pb, Cr/Pr)
Audio	Stereo RCA × 1
External Control	D-sub 9-pin
Sound output	7W+7W at 6 ohm
Power Supply	AC120V 50/60Hz
Current Rating	4.8A (maximum)
Power Consumption	395W (typical)
Dimensions	41.3 (W) × 25.5 (H) × 3.6 (D) in 1048 (W) × 648 (H) × 91 (D) mm
Weight	87.1 lbs / 39.5 kg
Environmental Considerations	
Operating Temperature	0°C to 40°C / 32°F to 104°F
Humidity	20 to 80%
Altitude	0 to 1900m / 0 to 6230ft
Storage Temperature	-10°C to 50°C / 14°F to 122°F
Humidity	10 to 90%
Altitude	0 to 3000m / 0 to 9840ft
Front Panel User Controls	Power on/off, Input source select, Volume up/down
Remote Control Functions	Input select, OSM control, Visual control, Volume control, Wireless/ Wired remote control
OSM Functions	Picture (Contrast / Brightness / Sharpness / Color / Tint / Picture mode/ Color temperature / Noise reductions), Sound (Bass / Treble / Balance), Screen adjustment (Wide adjustment / RGB adjustment / OSM adjustment), Function (Power management / RGB select / HD select / OSM / Gray level / PLE / Reset), Information (Frequency / Communication / Language / Color system)

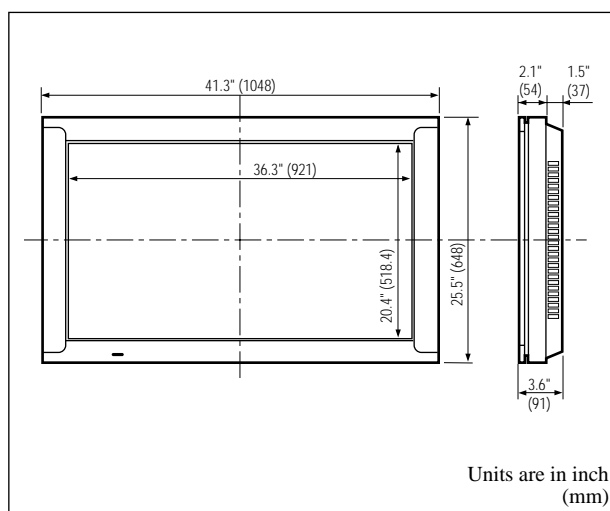

The features and specifications may be subject to change without notice.

* DTV input signals supported on this system

- 1080I (60 Hz)
- 480P (60 Hz)
- 480I (60 Hz)
- 720P (60 Hz)

Other Features	Power management, plug and play (DDC1, DDC2b)
Accessories	Remote controller with two AA batteries, Wired remote cable, Adapter for Macintosh, RGB cable (Mini D-Sub 15-pin to Mini D-Sub 15-pin connector), Power code, Safety metal fitting, Screw for safety metal fitting, User's Manual
Regulations	UL Approved (UL 1950, CSA 950) DOC Canada requirements Meets FCC class A requirements

NEC

NEC Technologies, Inc.
1250 N. Arlington Heights Road, Suite 500
Itasca, Illinois 60143-1248

Printed on recycled paper

Free Manuals Download Website

<http://myh66.com>

<http://usermanuals.us>

<http://www.somanuals.com>

<http://www.4manuals.cc>

<http://www.manual-lib.com>

<http://www.404manual.com>

<http://www.luxmanual.com>

<http://aubethermostatmanual.com>

Golf course search by state

<http://golfingnear.com>

Email search by domain

<http://emailbydomain.com>

Auto manuals search

<http://auto.somanuals.com>

TV manuals search

<http://tv.somanuals.com>