

User's Manual



PlasmaSync 42XC10
PlasmaSync 50XC10
PlasmaSync 60XC10

Package Contents

- Plasma Monitor
- Remote control and AA Batteries
- Power cord
- Users Manual (CD-ROM)
- Start Up Guide (Paper / CD-ROM)
- Main Power Switch cover and screw
- Cable clamps

Table of Contents

| | |
|--|------------|
| Important Safety Instructions..... | English-1 |
| Important Information | English-2 |
| Safety Precautions and Maintenance..... | English-3 |
| Recommended Use..... | English-4 |
| Installation | |
| Optional Stands/Mounts | English-6 |
| Mounting Location | English-6 |
| Mounting on Ceiling..... | English-7 |
| Maintenance, Orientation, Cable Management | English-7 |
| Using the Remote | English-8 |
| Part Names and Functions | |
| Control Panel | English-9 |
| Terminal Panel..... | English-10 |
| Remote Control..... | English-11 |
| Power, Display, Digital Zoom, Pointer, Main Power Switch Cover | English-12 |
| Remote Control ID..... | English-13 |
| On-Screen Display (OSD) | |
| Using the OSD..... | English-14 |
| OSD..... | English-15 |
| Operation | |
| Picture Size Using Video Signals..... | English-18 |
| Picture Size Using Computer Signals..... | English-19 |
| Split Screen Mode | English-20 |
| Picture-in-Picture Mode | English-21 |
| RS-232C | English-23 |
| Troubleshooting..... | English-27 |
| Specifications | |
| 42XC10..... | English-28 |
| 50XC10 | English-29 |
| 60XC10 | English-30 |
| Supported Resolutions | |
| 42XC10..... | English-31 |
| 50XC10 | English-33 |
| 60XC10 | English-35 |
| Pin Assignment..... | English-37 |

Important Safety Instructions

Read Before Operating Equipment.

1. Read these instructions.
2. Keep these instructions.
3. Heed all warnings.
4. Follow all instructions.
5. Do not use this apparatus near water.
6. Clean only with a dry cloth.
7. Do not block any of the ventilation openings. Install in accordance with the manufacturer's instructions.
8. Do not install near any heat sources such as radiators, heat registers, stoves, or other apparatus (including amplifiers) that produce heat.
9. Do not defeat the safety purpose of the polarized or grounding-type plug. A polarized plug has two blades with one wider than the other. A grounding type plug has two blades and third grounding prong. The wide blade or third prong are provided for your safety. If the provided plug does not fit into your outlet, consult an electrician for replacement of the obsolete outlet.
10. Protect the power cord from being walked on or pinched particularly at plugs, convenience receptacles, and the point where they exit from the apparatus.
11. Only use attachments/accessories specified by the manufacturer
12. Use only with the cart, stand, tripod, bracket, or table specified by the manufacturer, or sold with the apparatus. When a cart is used, use caution when moving the cart or apparatus combination to avoid injury from tip-over.



13. Unplug this apparatus during lightning storms or when unused for long periods of time
14. Refer all servicing to qualified service personnel. Servicing is required when the apparatus has been damaged in any way, such as when the power-supply cord or plug is damaged, liquid has been spilled or objects have fallen into the apparatus, the apparatus has been exposed to rain or moisture, does not operate normally, or has been dropped

Additional Safety Information

15. This product may contain lead. Disposal of these materials may be regulated due to environmental considerations.

For disposal or recycling information, please contact your local authorities or the Electronic Industries Alliance: www.eiae.org.

16. Damage Requiring Service -The appliance should be serviced by qualified service personnel when:
 - A. The power supply cord or the plug has been damaged; or
 - B. Objects have fallen, or liquid has been spilled into the appliance; or
 - C. The appliance has been exposed to rain; or
 - D. The appliance does not appear to operate normally or exhibits a marked change in performance; or
 - E. The appliance has been dropped, or the enclosure damaged.
17. Tilt/Stability - All monitors must comply with recommended international global safety standards for tilt and stability properties of its cabinet design. Do not compromise these design standards by applying excessive pull force to the front, or top, of the cabinet which could ultimately overturn the product. Also, do not endanger yourself, or children, by placing electronic equipment/toys on the top of the cabinet. Such items could unsuspectingly fall from the top of the set and cause product damage and/or personal injury.
18. Wall/Ceiling Mounting - The appliance should be mounted to a wall/ceiling only as recommended by the manufacturer.
19. Power Lines - An outdoor antenna should be located away from power lines.
20. Outdoor Antenna Grounding - If an outside antenna is connected to the receiver, be sure the antenna system is grounded so as to provide some protection against voltage surges and built up static charges. Section 810 of the National Electric code. ANSI/NFPA No.70-1984, provides information with respect to proper grounding of the mats and supporting structure, grounding of the lead-in wire to an antenna-discharge unit, size of grounding connectors, location of antenna discharge unit, connection to grounding electrodes and requirements for the grounding electrode.
21. Objects and Liquid Entry - Care should be taken so that objects do not fall and liquids are not spilled into the enclosure through openings. Apparatus shall not be exposed to dripping or splashing and no objects filled with liquids, such as vases, shall be placed on apparatus

WARNING

To reduce the risk of fire or electric shock, do not expose this apparatus to rain or moisture.

Important Information

WARNING



TO PREVENT FIRE OR SHOCK HAZARDS, DO NOT EXPOSE THIS UNIT TO RAIN OR MOISTURE. DO NOT USE THIS UNIT'S POLARIZED PLUG WITH AN EXTENSION CORD RECEPTACLE OR OTHER OUTLETS UNLESS THE PRONGS CAN BE FULLY INSERTED.



REFRAIN FROM OPENING THE CABINET AS THERE ARE HIGH VOLTAGE COMPONENTS INSIDE. REFER SERVICING TO QUALIFIED SERVICE PERSONNEL.

CAUTION

CAUTION: TO REDUCE THE RISK OF ELECTRIC SHOCK, MAKE SURE POWER CORD IS UNPLUGGED FROM WALL SOCKET. TO FULLY DISENGAGE THE POWER TO THE UNIT, PLEASE DISCONNECT THE POWER CORD FROM THE AC OUTLET. DO NOT REMOVE COVER (OR BACK). NO USER SERVICEABLE PARTS INSIDE. REFER SERVICING TO QUALIFIED SERVICE PERSONNEL.



This symbol warns user that uninsulated voltage within the unit may have sufficient magnitude to cause electric shock. Therefore, it is dangerous to make any kind of contact with any part inside this unit.



This symbol alerts the user that important literature concerning the operation and maintenance of this unit has been included. Therefore, it should be read carefully in order to avoid any problems.

CAUTION: Please use the power cord provided with this display in accordance with the table below. If a power cord is not supplied with this equipment, please contact your supplier. For all other cases, please use a power cord that matches the AC voltage of the power outlet and has been approved by and complies with the safety standard of your particular country.

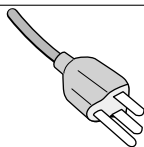
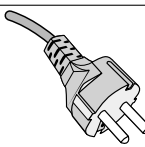
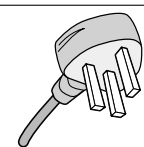
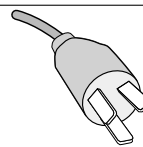
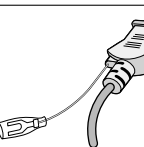
| Plug Type | North America | European Continental | U.K. | Chinese | Japanese |
|------------|---|---|---|---|---|
| Plug Shape |  |  |  |  |  |
| Country | U.S.A./Canada | EU (except U.K.) | U.K. | China | Japan |
| Voltage | 120* | 230 | 230 | 220 | 100 |

*When operating the PlasmaSync monitor with its AC 125-240V power supply, use a power supply cord that matches the power supply voltage of the AC power outlet being used.

Canadian Department of Communications Compliance Statement

DOC: This Class B digital apparatus meets all requirements of the Canadian Interference-Causing Equipment Regulations.

FCC Information

- Use the attached specified cables with the P426Y3(P42XC10), P506Y4(P50XC10) or P606Y5(P60XC10) color monitor so as not to interfere with radio and television reception.
 - Please use the supplied power cord or equivalent to ensure FCC compliance.
 - Please use shielded video signal cable, 15-pin mini D-SUB to 15-pin mini D-SUB with ferrite cores on both ends (not included).
- This equipment has been tested and found to comply with the limits for a Class B digital device, pursuant to part 15 of the FCC Rules. These limits are designed to provide reasonable protection against harmful interference in a residential installation. This equipment generates, uses, and can radiate radio frequency energy, and, if not installed and used in accordance with the instructions, may cause harmful interference to radio communications. However, there is no guarantee that interference will not occur in a particular installation. If this equipment does cause harmful interference to radio or television reception, which can be determined by turning the equipment off and on, the user is encouraged to try to correct the interference by one or more of the following

measures:

- Reorient or relocate the receiving antenna.
- Increase the distance between the equipment and receiver.
- Connect the equipment into an outlet on a circuit different from that to which the receiver is connected.
- Consult your dealer or an experienced radio/TV technician for help.

If necessary, the user should contact the dealer or an experienced radio/television technician for additional suggestions. The user may find the following booklet, prepared by the Federal Communications Commission, helpful: "How to Identify and Resolve Radio-TV Interference Problems." This booklet is available from the U.S. Government Printing Office, Washington, D.C., 20402, Stock No. 004-000-00345-4.

WARNING

This product equipped with a three-wire grounding (earthed) plug - a plug that has a third (grounding) pin. This plug only fits a grounding-type power outlet. If you are unable to insert the plug into an outlet, contact a licensed electrician to replace the outlet with a properly grounded one. Do not defeat the safety purpose of the grounding plug.

Safety Precautions and Maintenance

Safety Precautions and Maintenance

FOR OPTIMUM PERFORMANCE, PLEASE NOTE THE FOLLOWING WHEN SETTING UP AND USING THE MONITOR:

The plasma display's panel is made up of fine picture elements (cells), of which more than 99.99 percent are active cells. Some cells may not produce light or remain constantly lit. For safe operation and to avoid damaging the unit, read carefully and observe the following instructions.

- DO NOT OPEN THE MONITOR. There are no user-serviceable parts inside and opening or removing covers may expose you to dangerous shock hazards or other risks. The manufacturer is not liable for any bodily harm or damage caused if unqualified persons attempt service or open the back cover. Refer all servicing to qualified service personnel.
- Do not spill any liquids into the cabinet or use your monitor near water.
- Do not insert objects of any kind into the cabinet slots, as they may touch dangerous voltage points, which can be harmful or fatal or may cause electric shock, fire or equipment failure.
- Do not bend, crimp or otherwise damage the power cord. Do not place any heavy objects on the power cord. Damage to the cord may cause shock or fire.
- Do not place this product on a sloping or unstable cart, stand or table, as the monitor may fall, causing serious damage to the monitor.
- Do not use in a moving vehicle, as the unit could drop or topple over and cause injuries.
- The power cable connector is the primary means of detaching the system from the power supply. The monitor should be installed close to a power outlet that is easily accessible.
- This equipment shall be connected to a MAIN outlet with a protective earth-ground connection. Do not place any objects onto the monitor and do not use the monitor outdoors.
- Do not use this unit's polarized plug with an extension cord or with outlets unless the prongs can be inserted fully.
- The power supply cord you use must have been approved by and comply with the safety standards of your country. (Type H05VV-F 3G 1mm² should be used in Europe)
- In UK, use a BS-approved power cord with molded plug having a black (13A) fuse installed for use with this monitor.
- Use only with 100 V to 240 V 50 Hz/60 Hz AC power supply. Continued operation at line voltages greater than 100 V to 240 V AC will shorten the life of the unit, and might even cause a fire hazard.

- Unplug the power cord during electrical storms or when the unit will not be in use for a long period.
- Do not use monitor in high temperature, humid, dusty, or oily areas.
- Do not cover vent on monitor.
- Clean plasma ventilation areas using a vacuum cleaner with a soft brush nozzle attachment.
- To ensure proper ventilation, cleaning the ventilation areas must be carried out monthly. More frequent cleaning may be necessary depending on the environment in which the plasma monitor is installed.
- Allow adequate ventilation around the monitor so that heat can properly dissipate. Do not block ventilated openings or place the monitor near a radiator or other heat sources. Do not put anything on top of monitor.
- Handle with care when transporting. Save packaging for transporting.
- As is the case with any phosphor-based display (like a CRT monitor, for example) light output will gradually decrease over the life of a Plasma Display Panel.
- To avoid sulfurization it is strongly recommended not to place the unit in a dressing room in a public bath or hot spring bath.



CAUTION

Immediately unplug your monitor from the wall outlet and refer servicing to qualified service personnel under the following conditions:

- When the power supply cord or plug is damaged.
- If liquid has been spilled on, or objects have fallen into the monitor.
- If the monitor has been exposed to rain or water.
- If the monitor has been dropped or the cabinet damaged.
- If the monitor does not operate normally by following operating instructions.

Recommended Use

CAUTION

CORRECT PLACEMENT AND ADJUSTMENT OF THE MONITOR CAN REDUCE EYE, SHOULDER AND NECK FATIGUE. CHECK THE FOLLOWING WHEN POSITIONING THE MONITOR:

- For optimum performance, allow 20 minutes for warm-up.
- Rest your eyes periodically by focusing on an object at least 5 feet away. Blink often.
- Position the monitor at a 90 degree angle to windows and other light sources to minimize glare and reflections.
- Clean the monitor surface with a lint-free, nonabrasive cloth. Avoid using any cleaning solution or glass cleaner.
- Adjust the monitor's brightness and contrast controls to enhance readability.
- Get regular eye checkups.

Ergonomics

To realize the maximum ergonomic benefits, we recommend the following:

- Use the preset Size and Position controls with standard signals.
- Use the preset Color Setting.
- Do not use primary color blue on a dark background, as it is difficult to see and may produce eye fatigue due to insufficient contrast.
- This equipment is not for use at video display work station according to Bildscharb V.

For more detailed information on setting up a healthy work environment, refer to the following document:

*American National Standard for Human Factors
Engineering of Visual Display Terminal Workstations
ANSI-HFS Standard No. 100-1988*

Published by:

The Human Factors and Ergonomics Society
P.O. Box 1369, Santa Monica, California 90406.

Cleaning the Panel

- When the panel becomes dusty or dirty, wipe gently with soft cloth.
- Do not rub the panel with coarse material.
- Do not apply pressure to the surface.
- Do not use OA cleaner. OA cleaner will cause deterioration or discolor the surface.

Cleaning the Cabinet

- Unplug the power supply.
- Gently wipe the cabinet with a soft cloth.
- To clean the cabinet, dampen the cloth with a neutral detergent and water, wipe the cabinet and follow with a dry cloth.

NOTE: The surface of the cabinet is composed of many types of plastic. DO NOT clean with benzene thinner, alkaline detergent, alcoholic system detergent, glass cleaner, wax, polish cleaner, soap powder, or insecticide. Rubber or vinyl should not be in contact with the cabinet for an extended period of time. These types of fluids and materials can cause the paint to deteriorate, crack or peel.

CLEANING THE VENT HOLES

- Clean plasma ventilation areas using a vacuum cleaner with a soft brush nozzle attachment.
- To ensure proper ventilation, cleaning the ventilation areas must be carried out monthly. More frequent cleaning may be necessary depending on the environment in which the plasma monitor is installed.

To avoid or minimize image retention:

Like all phosphor-based display devices and all other gas plasma displays, plasma monitors can be susceptible to image retention under certain circumstances. Certain operating conditions, such as the continuous display of a static image over a prolonged period of time, can result in image retention if proper precautions are not taken. To protect your investment in this plasma monitor, please adhere to the following guidelines and recommendations for minimizing the occurrence of image retention:

- Always enable and use your computer's screen saver function during use with a computer input source.
- Display a moving image whenever possible.
- Change the position of the menu display from time to time.
- Always power down the monitor when you are finished using it.

To reduce the likelihood of image retention from long-term use:

- Lower the Brightness and Contrast levels as much as possible without impairing image readability.
- Display an image with many colors and color gradations (i.e. photographic or photo-realistic images).
- Create image content with minimal contrast between light and dark areas. Use complementary or pastel colors whenever possible.
- Avoid displaying images with few colors and distinct, sharply defined borders between colors.

Plasma monitor driving sound

- The panel of the Plasma monitor is composed of extremely fine pixels and these pixels emit light according to received video signals. This principle may cause you to hear a buzz or electrical hum coming from the Plasma monitor. Also note that the rotation speed of the cooling fan motor increases when the ambient temperature of the Plasma monitor becomes high. You may hear the sound of the motor at that time.

NOTE: The following items are not covered by the warranty.

- Image retention
- Panel generated sound. Examples: Fan motor and electrical noises circuit humming /glass panel buzzing.

OPERATING ENVIRONMENT

Operating environment temperature and humidity: 0 °C to +40 °C (+32 °F to +104 °F); less than 80%RH (cooling vents not blocked) Do not install this unit in a poorly ventilated area, or in locations exposed to high humidity or direct sunlight (or strong artificial light)

WARNING

Not for use in a computer room as defined in the Standard for the Protection of Electronic Computer/Data Processing Equipment ANSI/NFPA 75.

NOTE: Please use shielded video signal cable, 15-pin mini D-SUB to 15-pin mini D-SUB with ferrite cores on both ends (not included).

Installation

Using Optional Stand/Mounts

An optional stand or mounting apparatus can be installed either while the unit is in the upright position or while the unit is face-down.

To install the stand while in the upright position, lower the monitor onto to the feet as shown (Figure 1). Use the handles to support the display while lowering the support holes underneath the display onto the feet.

If stand or mounting apparatus is to be installed while the unit is face-down (Figure 2), be sure to lay the protective sheet (the foam sheet that the unit was wrapped in) underneath the unit on order to prevent damage to the screen.

This unit must be used with a stand or some type of mounting apparatus. This unit is not designed for use without additional support.

- For correct Installation and Mounting it is recommended to use a trained, authorized dealer.
- Failure to follow correct mounting procedures could result in damage to the unit or to the installer.
- Product warranty does not cover damage caused by improper installation.

CAUTION:

- To install, follow those instructions included with the stand or mounting apparatus. Use only those devices recommended by the manufacturer.
- Make sure to install stand or mounting apparatus to the unit while on a surface that is strong and stable enough to support the weight of the unit, such as a floor or sturdy table.
- Use the specified clasps for installation.
- Take necessary steps to prevent the unit from tipping or falling.

Mounting Location

The ceiling and wall must be strong enough to support the monitor and mounting accessories.

- DO NOT install in locations where a door or gate can hit the unit.
- DO NOT install in areas where the unit will be subjected to strong vibrations and dust.
- DO NOT install near where the main power supply enters the building.
- DO NOT install in where people can easily grab and hang onto the unit or the mounting apparatus.
- When mounting in an enclosure or in a recessed area, as in a wall, leave at least 2 inches (50mm) of space between the monitor and the wall for proper ventilation (Figure 3).

- Allow adequate ventilation or provide air conditioning around the monitor, so that heat can properly dissipate away from the unit and mounting apparatus.

Figure 1

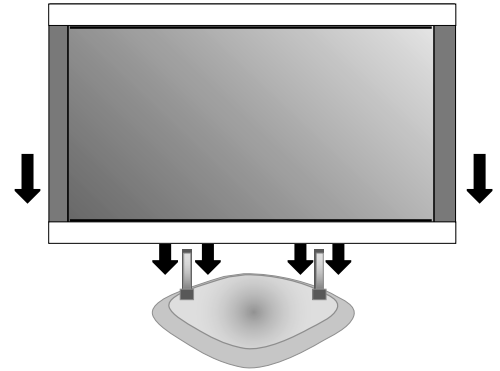

Figure 2

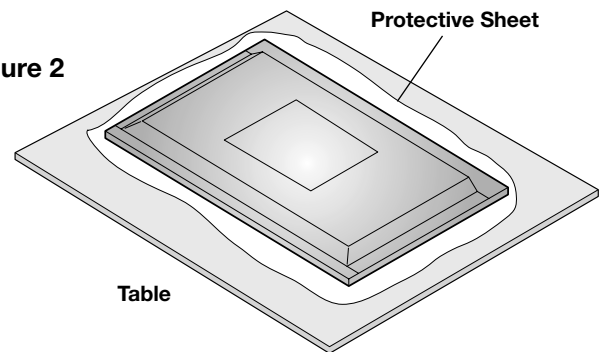
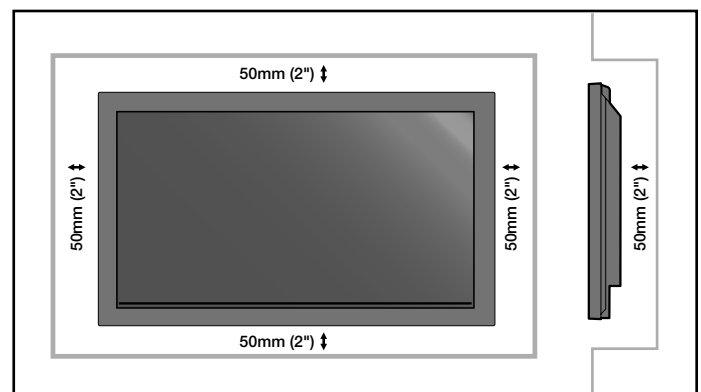

Figure 3



Mounting on Ceiling

- Ensure that the ceiling is sturdy enough to support the weight of the unit and the mounting apparatus over time, against earthquakes, unexpected vibrations, and other external forces.
- Be sure the unit is mounted to a solid structure within the ceiling, such as a support beam. Secure the monitor using bolts, spring lock washers, washer and nut.
- DO NOT mount to areas that have no supporting internal structure. DO NOT use wood screws or anchor screws for mounting. DO NOT mount the unit to trim or to hanging fixtures.

Maintenance

- Periodically check for loose screws, gaps, distortions, or other problems that may occur with the mounting apparatus. If a problem is detected, please refer to qualified personnel for service.
- Regularly check the mounting location for signs of damage or weakness that may occur over time.

Please note the following when mounting on wall or ceiling.

- When using mounting accessories other than those that are NEC approved, they must comply with the VESA-compatible (FDMLv1) mounting method.
- NEC strongly recommends using size M8 screws (16mm + thickness of bracket in length). If using screws longer than 16mm, check the depth of the hole. (Recommended Fasten Force: 1125 - 1375N•cm) NEC recommends mounting interfaces that comply with UL1678 standard in North America.

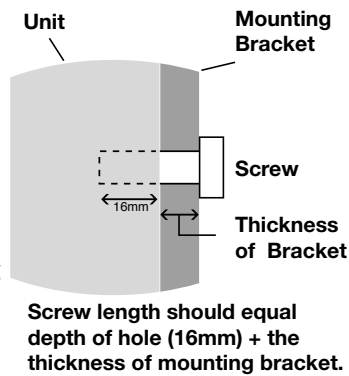

Cable Management

To conveniently manage cables, use the cable clamps provided to bundle the power cord together with the signal and audio cables at the back of the display.

To attach cable clamps:

1. Attach the cable clamps to the display. Insert the anchor of the clamp into the hole on the back of the display. There are 4 cable clamps and 4 clamp holes on the unit.
2. After the cable clamp is positioned on the display, wrap the end around the cables. Place the end of the clamp into the slot near the anchor. Pull until cables are snug.

Clamps are designed to stay in place. Once in position, they will be difficult to remove.

3. Cables can be routed to the right or left of the clamp. Use the beaded bands to secure the cables together along their length. Make sure the cables are fully supported.

To detach clamps:

Using pliers, twist the clamp 90 degrees and pull outward. It is possible that the clamp can weaken over time and removing it may cause damage to the clamp.

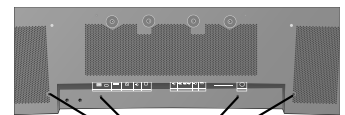

Orientation

DO NOT use this monitor in the portrait position. Doing so may cause failure and void the warranty.

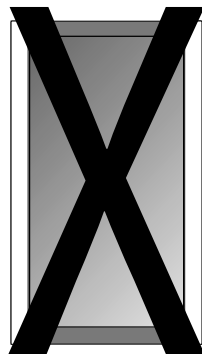

Installation - continued

Using the Remote:

Install the remote control batteries.

The remote control is powered by AA batteries. To install or replace batteries:

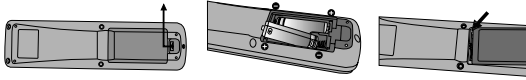

- A. Press and slide to open the cover.
- B. Align the batteries according to the (+) and (-) indications inside the case.
- C. Replace the cover.

CAUTION: Incorrect usage of batteries can result in leaks or bursting. NEC recommends the following battery use:

- Place "AA" size batteries matching the (+) and (-) signs on each battery to the (+) and (-) signs of the battery compartment.
- Do not mix battery brands.
- Do not combine new and old batteries, or mix brands. This can shorten battery life or cause liquid leakage of batteries.
- Remove dead batteries immediately to prevent battery acid from leaking into the battery compartment.
- Do not touch exposed battery acid, it may injure skin.
- Do not drop or mishandle the remote.
- Do not get the remote control wet. If the remote does get wet, wipe dry immediately.
- Avoid excessive heat and humidity.
- Do not dispose of batteries in fire.
- Please follow government regulations or public environmental rules that apply in your country/area when disposing of used batteries.
- When replacing, use only conventional non-rechargeable alkaline or manganese batteries.
- There is a risk of explosion if batteries are replaced incorrectly.

Operating Range for the Remote Control

Point the top of the remote control toward the monitor's remote sensor while pressing buttons. The remote control can be used from the front of the monitor at a maximum distance of 7 m/23 ft. from the front of the Plasma monitor's remote control sensor. The maximum horizontal and vertical angle for use of the remote is 30 degree within a distance of 3.5 m/11.5 ft.

CAUTION

The remote control may not function when direct sunlight or strong illumination strikes the remote control sensor of the Plasma monitor, or when there is an object in the path of the sensor.

Handling the Remote Control

Do not open the remote control other than to install batteries. Do not allow water or other liquid to splash onto the remote control. If the remote control gets wet, wipe it dry immediately.

Avoid exposure to heat and steam.

NOTE: If you do not intend to use the Remote Control for a long period of time, remove the batteries.

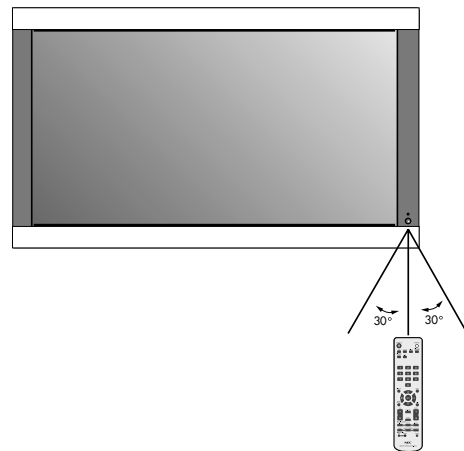

Control Panel

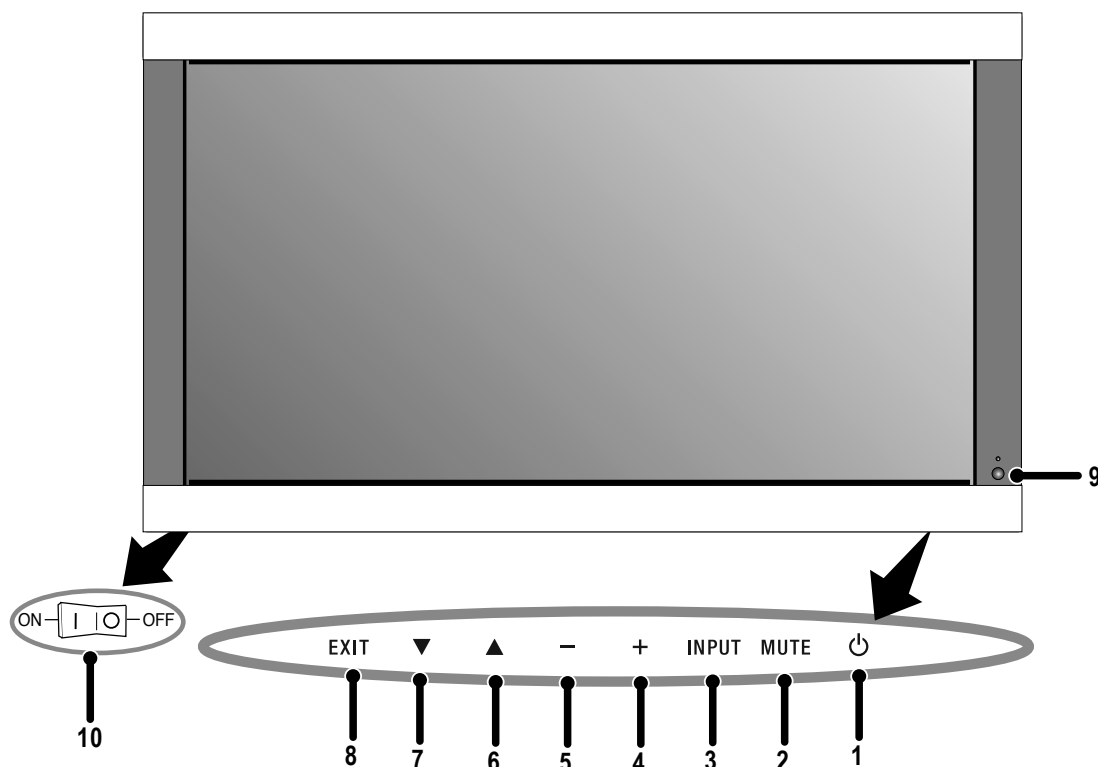

- 1) **POWER**
Switches the power on/standby.
- 2) **MUTE**
Switches the audio mute ON/OFF.
- 3) **INPUT**
Switches between input sources.
Acts as SET button within the OSD menu.
- 4) **PLUS (+)**
Increases the setting adjustment within OSD menu.
- 5) **MINUS (-)**
Decreases the setting adjustment within OSD menu.
- 6) **UP (▲)**
Increases the volume level when the OSD is off.
Moves area up to select which setting to is to be adjusted within OSD menu.
- 7) **DOWN (▼)**
Decreases the volume level when the OSD is off.
Moves down to select which setting is to be adjusted within OSD menu.
- 8) **EXIT**
Activates the OSD menu when the OSD menu is off.
Exits from the current menu being displayed to the previous menu within the OSD.
- 9) **Remote control sensor and Power indicator**
Receives the signal when using the wireless remote control.
Glows green when the monitor is active. Glows red when the monitor is in Standby mode. Glows Amber when the monitor is in POWER SAVE mode.

A red blinking Power indicator means that the monitor has detected a failure. Contact qualified personnel in case of failure.
- 10) **Main Power Switch**
Seesaw switch to turn the main power on/off.

| Mode | Status indicator light |
|-------------------------------|------------------------|
| Power On | Green |
| Standby | Red |
| Power save | Amber |
| Diagnosis (Detecting failure) | Red blinking |

NOTE:
The POWER button does not completely turn off the display. Use the Main Power Switch to completely turn off the display.

Part Names and Functions

Terminal Panel

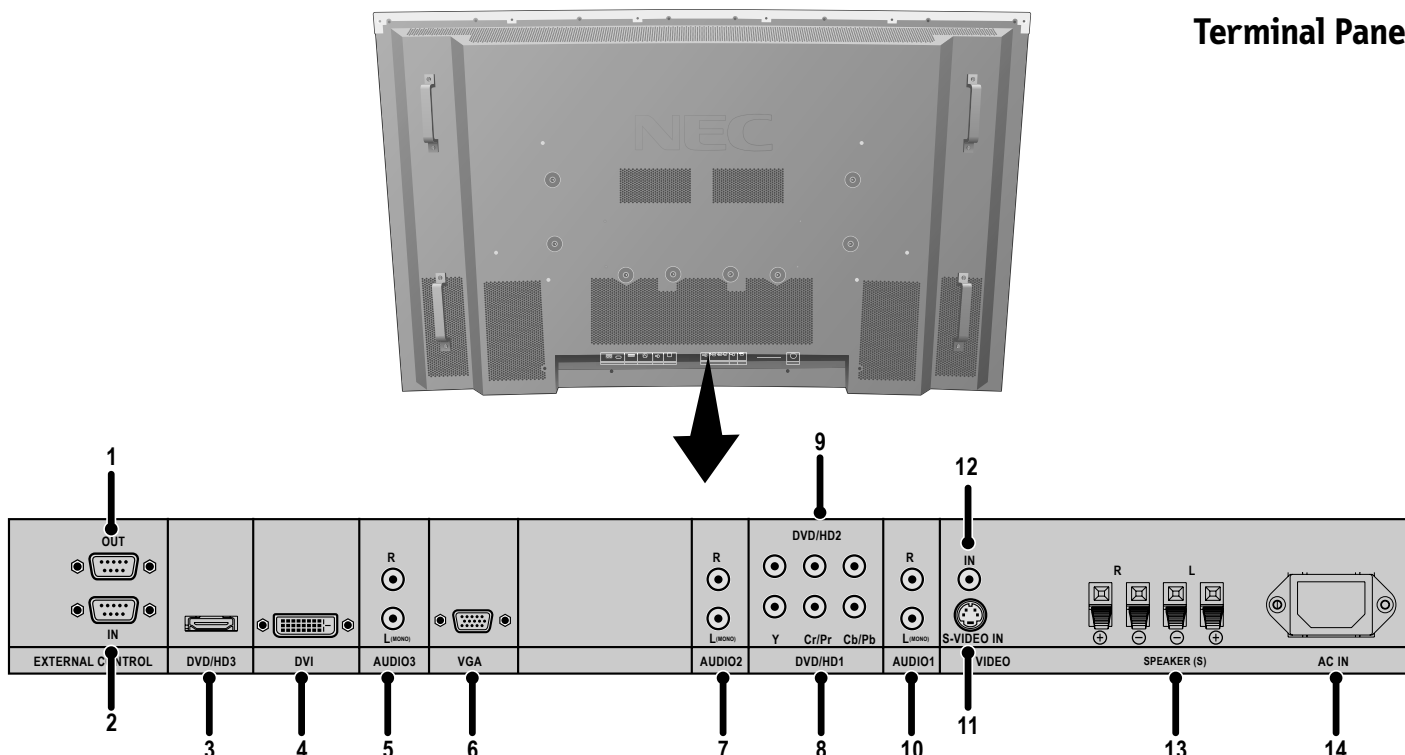

- 1) **EXTERNAL CONTROL OUT (D-Sub 9 pin)**
Connect RS-232C output to a second monitor.
- 2) **EXTERNAL CONTROL (D-Sub 9 pin)**
Connect RS-232C input to external equipment such as a PC in order to control RS-232C functions.
- 3) **DVD/HD3 (HDMI)**
Input digital HDMI signals.
- 4) **DVI**
Input digital RGB signals from a computer or HDTV device having a digital RGB output.
- 5) **AUDIO3**
Input the audio signal from external equipment such as a computer, VCR or DVD player.
- 6) **VGA (Mini D-Sub 15 pin)**
Analog computer input.
- 7) **AUDIO2**
Input the audio signal from external equipment such as a computer, VCR or DVD player.
- 8) **DVD/HD1**
Connect equipment such as a DVD player, HDTV device, or set-top box.
- 9) **DVD/HD2**
Connect equipment such as a DVD player, HDTV device or set-top.
- 10) **AUDIO1**
Input the audio signal from external equipment such as a computer, VCR or DVD player.
- 11) **S-VIDEO in**
Input S-video.
- 12) **VIDEO**
Composite video input.
- 13) **EXTERNAL SPEAKER (L and R) connector**
Connects to optional speakers. Output the audio signal from AUDIO 1, 2, and 3 to external speakers.
NOTE: Speaker Terminal is for 8W + 8W (8 ohm).
- 14) **AC IN**
Connects with the supplied power cord.

Information:

For SCART connections there are 2 ways to connect:

SCART1: Connect R/G/B to the DVD/HD1 terminals and composite sync. to the VIDEO1 terminal.

SCART2: Connect R/G/B + composite sync. to the VGA terminal.

Remote Control Functions

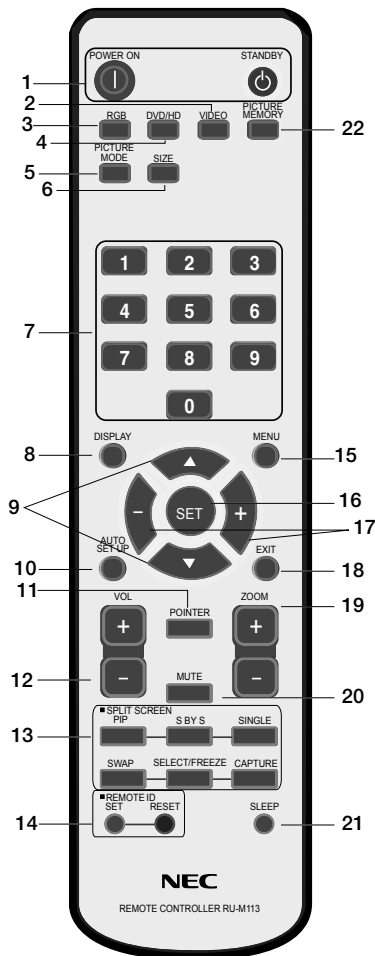

- 1) **POWER ON/STANDBY**
Switches the power on/standby.
*If the Power Indicator on the display is not glowing, then no controls will work.
- 2) **VIDEO**
Switches the input signal to the VIDEO source.
- 3) **RGB**
Switches the input signal to the RGB source.
- 4) **DVD/HD**
Switches the input signal to the DVD/HD source.
- 5) **PICTURE MODE**
Selects Picture Mode: [STANDARD], [BRIGHT], [CINEMA1], [CINEMA2], [DEFAULT].
STANDARD: for viewing in a bright room
BRIGHT: brighter picture than STANDARD
CINEMA1, 2: for viewing in a dark room, good for movies
DEFAULT: factory default settings

- 6) **SIZE**
Set the aspect ratio of the image.
- 7) **KEYPAD**
Set REMOTE ID.
- 8) **DISPLAY**
Turn on/off the Information OSD.
- 9) **▲ ▼**
Move selection up or down
- 10) **AUTO SETUP**
Adjusts the CLOCK PHASE, CLOCK, and POSITION settings automatically. (Analog RGB signal input only)
- 11) **POINTER**
Turn on/off the pointer.
- 12) **VOLUME**
Increases/Decreases sound level.
- 13) **SPLIT SCREEN**
PIP: Picture-in-Picture mode.
S BY S: Side-by-side mode.
SINGLE: Returns to normal mode.
SWAP: Swaps the Split Screen images.
SELECT/FREEZE: Selects which input is active when in split screen mode.

When the PICTURE FREEZE function (see OSD FUNCTION) is operating, SELECT/FREEZE can be used to display still pictures on the sub screen.

CAPTURE : Captures still picture.
- 14) **REMOTE ID**
Activates REMOTE ID function.
- 15) **MENU**
Turns ON/OFF menu mode.
- 16) **SET**
Makes selection.
- 17) **-, +**
Increases or decreases amount of adjustment.
- 18) **EXIT**
Goes to the previous menu.
- 19) **ZOOM**
Enlarges or reduces the picture.
- 20) **MUTE**
Mutes audio output.
- 21) **SLEEP**
Sleep timer.
- 22) **PICTURE MEMORY**
Switches memory settings from 1 to 6.

Part Names and Functions - *continued*

POWER

To turn the unit ON and OFF:

1. Plug the power cord into an AC outlet.
2. Press the Power button (on the unit).
The monitor's ON/STANDBY indicator turns red and the unit will be in STANDBY mode.
3. Press the POWER ON button on the remote control. The ON/STANDBY indicator will turn green when the unit is active.
4. Press the STANDBY button (on the remote) or the Power button (on the unit) to turn off the monitor.

DISPLAY

To check display settings press the DISPLAY button on the remote. The screen changes each time the DISPLAY button is pressed. Display information will disappear after 3 seconds.

DIGITAL ZOOM

Digital zoom can change the picture position or enlarge the image on the screen.

1. Be sure ZOOM NAV function is off. Press the ZOOM button (+ or -) to display the magnifying glass.
Press the ZOOM + button to enlarge the image.
Press the ZOOM - button to reduce the image.
Press the UP and DOWN or PLUS and MINUS buttons to reposition the picture.
2. Press the POINTER button to hide the pointer.

POINTER

Use the Pointer to point to a specific area on the screen.

Press the UP and DOWN or PLUS and MINUS buttons to reposition the Pointer.

Main Power Switch Cover

Included with the display is a cover for the Main Power Switch. Use this cover to prevent the unit from being inadvertently powered off.

Place the tab on the cable cover into the rectangular slot on the display.

Then using the screw provided, secure the cover to the display.

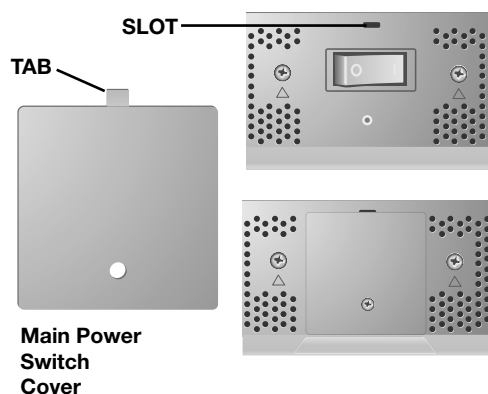
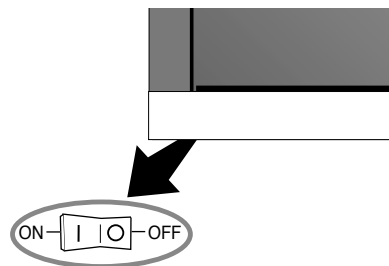

Remote Control ID Function

REMOTE CONTROL ID

The remote control included with the display can be used to control up to 26 individual monitors using what is called the REMOTE CONTROL ID mode. The REMOTE CONTROL ID mode works in conjunction with the Monitor ID, allowing control of up to 26 individual monitors. For example: if there are many monitors being used in the same area, a remote control in normal mode would send signals to every monitor at the same time Figure 1. Using the remote in REMOTE CONTROL ID mode will only operate one specific monitor within the group Figure 2.

TO SET REMOTE CONTROL ID:

While holding down the REMOTE ID SET button on the remote control, use the KEYPAD to input the Monitor ID (1-26) of the display to be controlled via remote. The remote can then be used to operate the monitor having that specific Monitor ID number.

When 0 is selected or when the remote control is in normal mode, all monitors will be operated.

TO USE REMOTE CONTROL ID MODE

ID Mode - To enter ID Mode press the REMOTE ID SET button and hold down for 2 seconds.

Normal Mode - To return to Normal Mode press the REMOTE ID RESET button and hold down for 2 seconds.

In order for this feature to work properly, the display must be assigned a Monitor ID number. The Monitor ID number can be assigned under the SETUP menu in the OSD (See page 17).

If Monitor ID is set to "ALL", monitor is controlled by remote control not depend on remote ID.

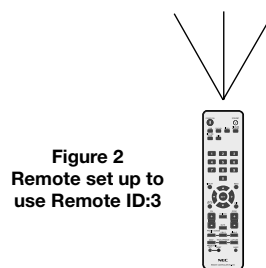
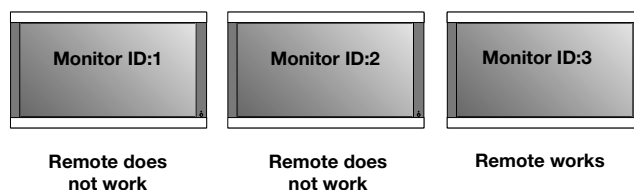
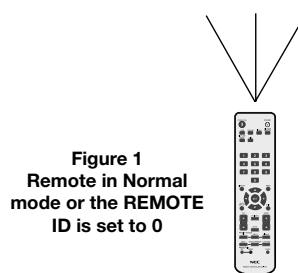
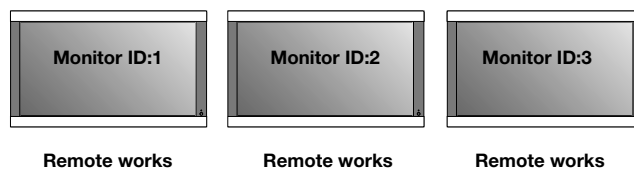

On-Screen Display (OSD)

Using the OSD

Use the Remote Control or the control panel on the front of the unit to enter the on-screen display menu to adjust settings.

1. Press the MENU button on the remote or the EXIT button on the Control Panel.
2. Use the up and down buttons to select the desired menu.
3. Press the SET button to select a sub-menu or item for adjustment.

4. Change the setting or adjustment by pressing the + and - buttons on the Control Panel or the Remote Control.
5. Press the EXIT button on the Remote Control, on the Control Panel to return to the previous menu.

NOTE: Not all menu functions may be available. To access all functions the Advanced OSD option must be turned on in the ADVANCED OSD menu.

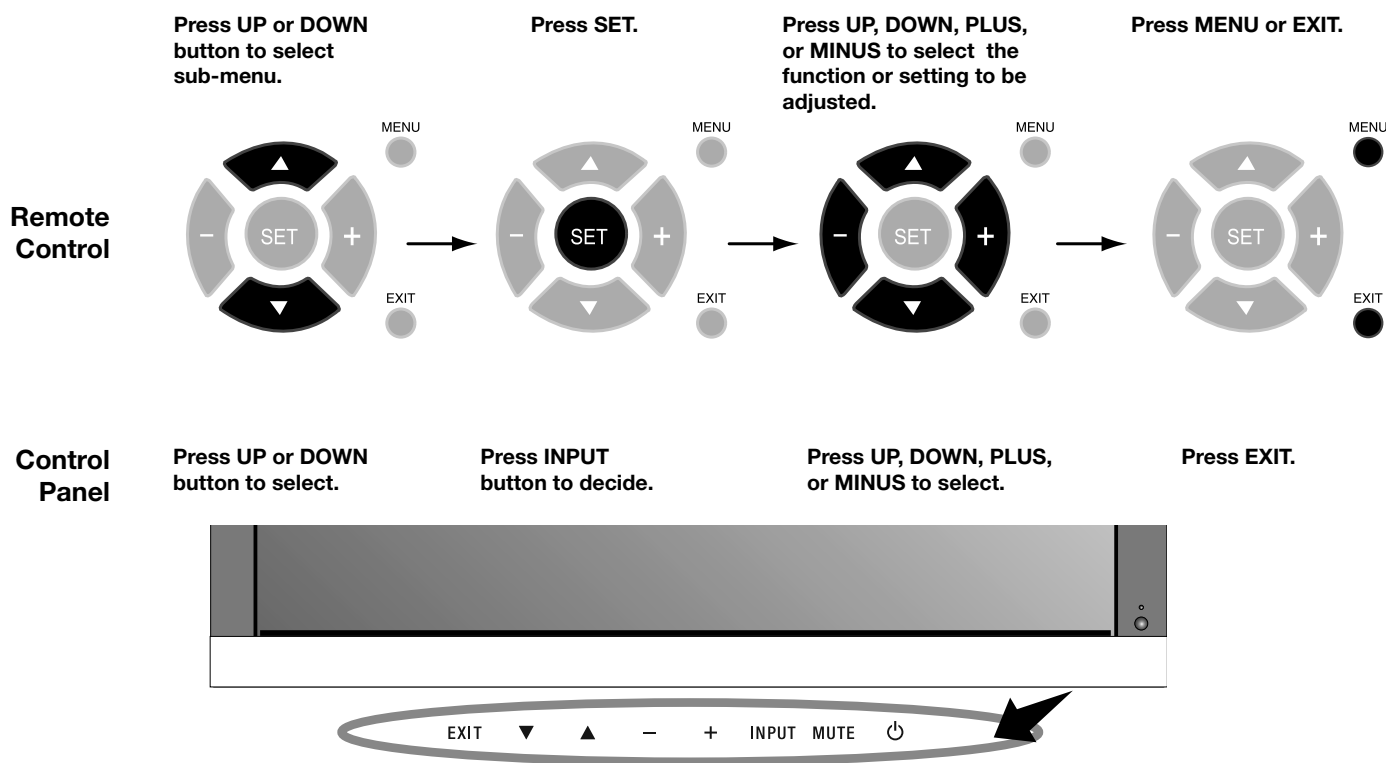

OSD Screen

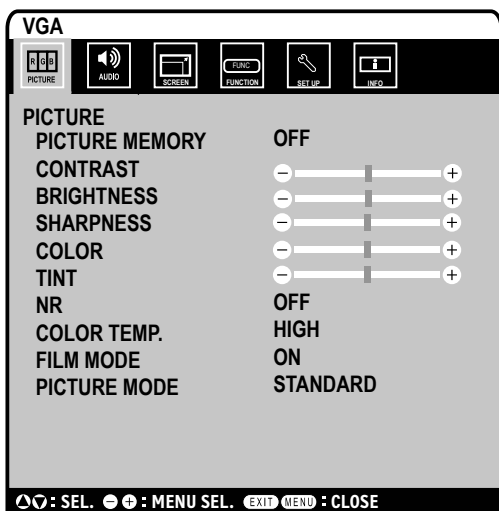

ADVANCED OSD is OFF. Not all OSD functions will be available when the ADVANCED OSD is off.

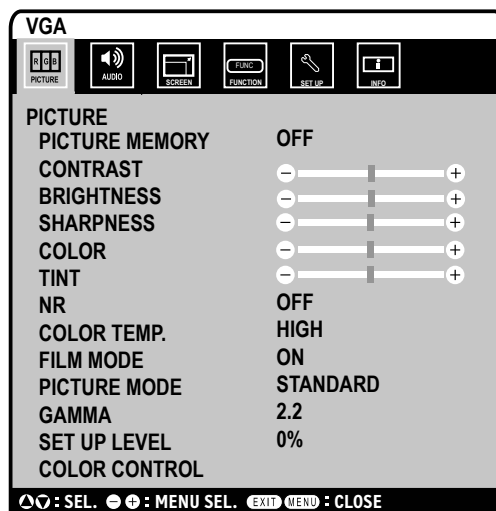

Advanced OSD is ON. All OSD functions are shown, but some OSD functions may not be available.

On-Screen Display (OSD)

| Main Menu | Sub Menu | Sub Menu2 | Explanation | Default | Reset |
|-----------|--|---|--|----------|-------|
| PICTURE | PICTURE MEMORY | | Store picture menu settings and input terminal information. The memory number is 1-6. The "PICTURE MEMORY" screen appears when the SET button is pressed on the "PICTURE MEMORY" MENU. | OFF | YES |
| | CONTRAST | | Adjusts the image brightness in relationship to the white level. Press + or - to adjust. | 50 | YES |
| | BRIGHTNESS | | Adjusts the image brightness in relationship to the background. Press + or - to adjust. | 50 | YES |
| | SHARPNESS | | Adjusts the crispness of the image. Press + or - to adjust. | 50 | YES |
| | COLOR | | Adjusts the color depth of the screen. Press + or - to adjust. | 50 | YES |
| | TINT | | Adjusts the tint of the screen. Press + or - to adjust. | 50 | YES |
| | NR | | Adjusts the amount of noise reduction. Press + or - to adjust. | OFF | YES |
| | COLOR TEMP. | | Adjusts the color temperature of the entire screen. A low color temperature will make the screen reddish. A high color temperature will make the screen bluish. | MIDDLE | YES |
| | WHITE BALANCE. | GAIN RED | The "WHITE BALANCE" appears when the SET button is pressed on the "COLOR TEMP." OSD menu. GAIN RED/GREEN/BLUE: Adjusts the white level of the white balance. | 50 | YES |
| | | GAIN GREEN | | 50 | YES |
| | | GAIN BLUE | | 50 | YES |
| | | RESET | Resets the factory default settings. Select "ON", then press the SET button to reset. | OFF | YES |
| | FILM MODE | | Selects Film mode. | ON | YES |
| | PICTURE MODE | | Selects picture mode, [BRIGHT], [STANDARD], [CINEMA1], [CINEMA2], [DEFAULT]. STANDARD: For watching in a bright room. CINEMA1, 2: For watching in a dark room, especially good for movies. BRIGHT: Brighter picture than STANDARD. DEFAULT: Restores factory default settings. | STANDARD | YES |
| | GAMMA <i>Available only when the Advanced OSD function in the FUNCTION menu is enabled.</i> | | Select a display gamma for best picture quality. 2.1, 2.2, 2.3, 2.4: The picture becomes darker as the number increases. S: Special gamma for certain types of movies. Raises the dark parts and lowers the light parts of the image. (S-Curve) These values are approximate. | 2.2 | YES |
| | SET UP LEVEL <i>Available only when the Advanced OSD function in the FUNCTION menu is enabled.</i> | | Adjusts the video black level. VIDEO signal input only. | 0% | YES |
| | COLOR CONTROL <i>Available only when the Advanced OSD function in the FUNCTION menu is enabled.</i> | RED | Adjusts the levels of the Red, Green, Blue, Yellow, Magenta and Cyan. VIDEO and DVD/HD 1/2 input only. | 50 | YES |
| | | GREEN | | 50 | YES |
| BLUE | | 50 | | YES | |
| YELLOW | | 50 | | YES | |
| MAGENTA | | 50 | | YES | |
| CYAN | | 50 | | YES | |
| RESET | | Resets the factory default settings. Select "ON", then press the SET button to reset. | OFF | YES | |

On-Screen Display (OSD)

| Main Menu | Sub Menu | Sub Menu2 | Explanation | Default | Reset |
|---|---|-------------|---|-----------|-------|
| AUDIO | BASS | | Adjusts the low frequency sound. Press + or - to adjust. | 0 | YES |
| | TREBLE | | Adjusts the high frequency sound. Press + or - to adjust. | 0 | YES |
| | BALANCE | | Adjusts the balance of L/R volume. Press + or - to adjust. | 0 | YES |
| | AUDIO INPUT1 | | Select which audio input to use with the video source. | VIDEO1 | YES |
| | AUDIO INPUT2 | | | DVD/HD1 | YES |
| | AUDIO INPUT3 | | | VGA | YES |
| | DVD/HD3 INPUT | | | HDMI | YES |
| SCREEN | ASPECT MODE | | Selects aspect ratio of the displayed image. Press + or - to select. | - | - |
| | V-POSITION | | Controls the vertical position of the image within the Display area of the PDP. Press + to move up. Press - to move down. | 0 | YES |
| | H-POSITION | | Controls the horizontal position of the image within the Display area of the PDP. Press + to move right. Press - to move left. | 0 | YES |
| | V-HEIGHT | | Adjusts the vertical size of the image. | 0 | YES |
| | H-WIDTH | | Adjusts the horizontal size of the image. | 0 | YES |
| | AUTO PICTURE | | ON: H-Position, V-Position, Clock and Clock Phase are adjusted automatically. OFF: H-Position, V-Position, Clock and Clock Phase are adjusted manually. <i>VGA input only.</i> | OFF | NO |
| | CLOCK PHASE | | Adjusts the visual "noise" on the image. <i>VGA input only.</i> | 0 | YES |
| | CLOCK | | Press + to expand the width of the image on the right of the screen. Press - to narrow the width of the image on the left. <i>VGA input only.</i> | 0 | YES |
| | UNDER SCAN <i>Available only when the Advanced OSD function in the FUNCTION menu is enabled.</i> | | ON: UNDERSCAN is selectable in the ASPECT MODE menu. OFF: UNDERSCAN item is not selectable in the ASPECT MODE menu. <i>Video signal input only.</i> | OFF | YES |
| SET UP <i>Some functions available only when the Advanced OSD function in the FUNCTION menu is enabled.</i> <i>The LANGUAGE and ALL RESET functions are always available.</i> | LANGUAGE | | Select the language used by the OSD. | ENGLISH | NO |
| | DVD/HD1 INPUT | | Selects whether to set the input of the DVD/HD1 connector. COMPONENT : for Component input. (3BNC connectors) SCART1 : for SCART input (3RCA connectors and VIDEO1 input) (SCART1 available for Europe and World-Wide models only) | COMPONENT | YES |
| | D-SUB INPUT | | Selects whether to set the input of the mini D-SUB connector. RGB : for RGB input SCART2 : for SCART input (SCART2 available for Europe and World-Wide models only) | RGB | YES |
| | HD SELECT | | Selects signal detection for similar 1080I signal manually. 1080I : Standard digital broadcasts 540P : Special digital broadcasts (ex. DTC100) | 1080I | NO |
| | RGB SELECT | | If there is a problem with signal detection, this function forces the monitor to display the signal at the desired resolution. If no problem is detected, the only available option will be "AUTO". <i>VGA input only.</i> | AUTO | YES |
| | HDMI MODE | | Choose the HDMI mode based on the input device connected via HDMI connector. When a DVD player or similar equipment is connected, sets to "HIGH". When a PC or similar equipment is connected, sets to "LOW". | HIGH | NO |
| | DVI MODE | PLUG/PLAY | Choose the DVI mode based on the input device connected via DVI connector and set the black level. When a PC or similar equipment is connected, PLUG/PLAY is "DVI-PC" and BLACK LEVEL is "LOW". When a DVD player or similar equipment is connected, PLUG/PLAY is "DVI-HD" and BLACK LEVEL is "HIGH". | DVI-PC | NO |
| | | BLACK LEVEL | | LOW | NO |
| | COLOR SYSTEM | | The selected Color System depends on the video format of the input signal. <i>VIDEO input only.</i> | AUTO | NO |

On-Screen Display (OSD)

| Main Menu | Sub Menu | Sub Menu2 | Explanation | Default | Reset | |
|---|-----------------------------------|---|---|---|----------|-----|
| SET UP (continued) | BACK GROUND | | Chooses the brightness of background when there is no input signal present. | GRAY | YES | |
| | SIDE MASK | | Adjusts the color of the side mask when a 4:3 image is displayed. Press + button, the bar will become lighter. Press - button, the bar will become darker. | 3 | YES | |
| | OSD | DISPLAY OSD | | ON: Information about inputs, screen size, etc. is shown. OFF: No information is shown. | ON | YES |
| | | OSD POSITION | | Change the position of the menu between TOP LEFT and BTM RIGHT. Press + or - to adjust. | TOP LEFT | YES |
| | | OSD ORBITER | | ON: The menu position intermittently shifts eight dots while the OSD is being displayed. OFF: The menu position does not shift. | ON | YES |
| | | OSD TRANSP. | | Adjusts the transparency level of the OSD. Press + or - to adjust. | 70% | YES |
| | MONITOR ID | | Sets the monitor ID number from 1-26 or "ALL". | ALL | YES | |
| ALL RESET | | Resets settings back to factory default values. | OFF | - | | |
| FUNCTION <i>Some functions available only when the Advanced OSD function in the FUNCTION menu is enabled.</i> <i>The ADVANCED OSD function is always available.</i> | ADVANCED OSD | | ON: All menu items are shown for advanced users. OFF: Some of the advanced menu items are not shown. | OFF | YES | |
| | POWER SAVE | | Sets how long the monitor waits to go into power save mode after a signal is lost. <i>VGA and DVI input and Separate HV sync. only.</i> | OFF | YES | |
| | INPUT SKIP | | Skips to next input if present input is no signal. This function is valid only for INPUT key on the display. | OFF | YES | |
| | SUB PICTURE | SUB P.DETECT | | This function automatically detects no input signal of sub screen. This feature is available only picture-in-picture mode. SUB P. DETECT: Sets availability of automatic detecting of sub screen. | AUTO | YES |
| | | DISPLAY | | DISPLAY: Sets the appearance method of the sub screen. SUB P. RATE: Sets the transparency of the sub screen. | NORMAL | YES |
| | | SUB P.RATE | | | 100% | YES |
| | ZOOM NAV | | Sets the position of the zoom navigation image. | BTM LFT | YES | |
| | PICTURE FREEZE | | Sets the position of the captured still picture. | S BY S1 | YES | |
| | SCREEN SAVER | | | Use the SCREEN SAVER function to reduce the risk of Image Persistence. | MANUAL | YES |
| | | PEAK BRIGHT | | PEAK BRIGHT : The brightness is decreased depending on setting. | 100% | YES |
| | | ORBITER | | ORBITER : The screen image moves slightly with squeezing or expanding. | AUTO1 | YES |
| | | INVERSE/WHITE | | INVERSE : The screen image is displayed alternately between positive image and negative image, or the screen image is displayed full white. | OFF | YES |
| | CLOSED CAPTION (U.S. models only) | | Chooses the closed caption setting. | OFF | YES | |
| | CAPTION CONT (U.S. models only) | | Chooses the brightness of the closed caption. | NORMAL | YES | |
| | INPUT DETECT | INPUT | | Sets the input mode and the sound volume when the power turn on. LAST : last mode (the input that was last selected when the power turn off.) MULTI to DVI : fixed input mode. | LAST | YES |
| | | VOLUME | | AUTO : Searches the input with the signal automatically PRIORITY : Sets the priority input for AUTO setting. | LAST | YES |
| | PROTOCOL SET | | Sets protocol setting of RS-232C. OFF : When NEC protocol is used (normal). ON : When special protocol is used. * Consult your dealer for details of protocol. | OFF | YES | |
| RS232C CONTROL | | Selects the mode of the monitor when using the RS-232C daisy chain. | NORMAL | YES | | |
| SIGNAL INFORMATION | | Display signal information such as frequencies, polarities, etc. | - | - | | |

Operation

Picture Size Using Video Signals

Select one of seven picture sizes manually.

While viewing videos or digital video discs, perform the following actions:

1. Press the SIZE button on the remote control.
2. To switch the screen sizes, press the SIZE button again within 3 seconds. The available sizes are **NORMAL**, **FULL**, **DYNAMIC**, **ZOOM**, **2.35:1**, **14:9**, and **UNDERSCAN**.

If a 720p, 1080i, or 1080p signal is displayed, the available sizes are **FULL**, **2.35:1**, **DYNAMIC**, and **UNDERSCAN**.

If displaying an enhanced split-screen, the available sizes are **NORMAL** and **FULL**.

NORMAL (4:3)

Images with a 4:3 (Normal) aspect ratio are displayed.

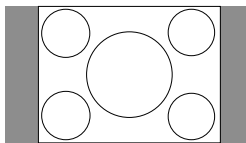

FULL

Horizontally expands anamorphic signals to display the correct linearity.

Normal (4:3) images are horizontally expanded to fill the entire screen.

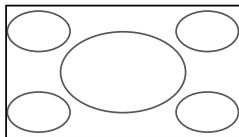

DYNAMIC

Vertically and horizontally expands the picture but at different aspect ratios.

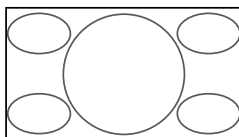

ZOOM

Vertically and horizontally expands the picture while maintaining the correct aspect ratio.

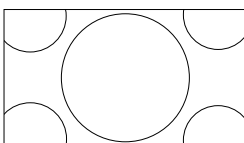

2.35:1

Image is expanded at a 2.35:1 ratio to fill the entire screen. The screen is filled vertically; however, some information will be lost on the left and right sides of the image.

Available for the following inputs:

Video, Component, or RGB input (480I, 480P, 576I, 576P, 720P, 1080I, 1080P)

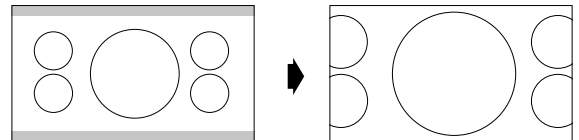

To avoid image retention, use the 2.35:1 image size if black bars are displayed at the top and bottom of the screen showing the displayed image.

14:9

Image is displayed at a 14:9 aspect ratio.

Available for the following inputs:

Video, Component, or RGB input (480I, 480P, 576I, 576P)

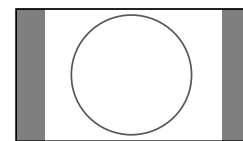

UNDERSCAN

Standard televisions crop (Underscan) images. Utilize the UNDERSCAN function in the SCREEN menu to display the entire image.

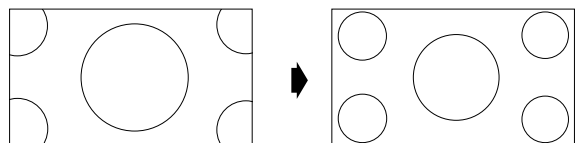

NOTE: Depending on the type of component used, black borders or signal noise may appear near the screen edges while in UNDERSCAN mode.

Over a period of time, image ghosting, shadowing, or burn-in may result from continuous display of underscanned images. While in UNDERSCAN mode, the brightness may change if a Macrovision signal is input.

NOTE: Do not display 4:3 content in NORMAL mode for extended periods of time to avoid image ghosting, shadowing, or burn-in.

Picture Size Using Computer Signals

To expand a 4:3 image to fill the entire screen, switch to the widescreen mode.

While viewing videos or digital video discs, perform the following actions:

1. Press the SIZE button on the remote control.
2. To switch the screen sizes, press the SIZE button again within 3 seconds. The available sizes are **NORMAL**, **FULL**, and **ZOOM**.

If an enhanced split-screen is displayed, the available sizes are **NORMAL** and **FULL**.

NORMAL (4:3 or SXGA 5:4)

Images are displayed normally.

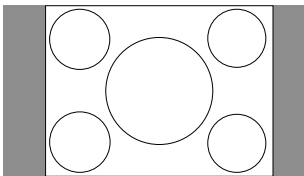

FULL

Horizontally expands anamorphic signals to display the correct linearity.

Normal (4:3) images are horizontally expanded to fill the entire screen.

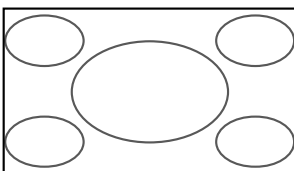

ZOOM

Vertically and horizontally expands the picture, while maintaining the correct aspect ratio.

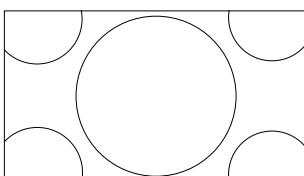

Information:

Supported resolutions: For further information on the display output of the various VESA signal standards supported by the unit, see pages 31 - 36.

When 1360 dot x 768 line wide XGA signals with a vertical frequency of 60 Hz and a horizontal frequency of 47.7 kHz are input:

1. Select an appropriate setting for the RGB SELECT mode.
2. Refer to the Resolutions Supported section of Model Information on pages 31 - 36.

NOTE: Do not display 4:3 content in NORMAL mode for extended periods of time to avoid image shadowing, ghosting, or burn-in.

Operation - continued

Split Screen Mode

To display multiple pictures on the screen, perform the following actions:

1. Press the desired SPLIT SCREEN function button on the remote (PIP, S BY S, SINGLE).

Only certain RGB signals are supported.

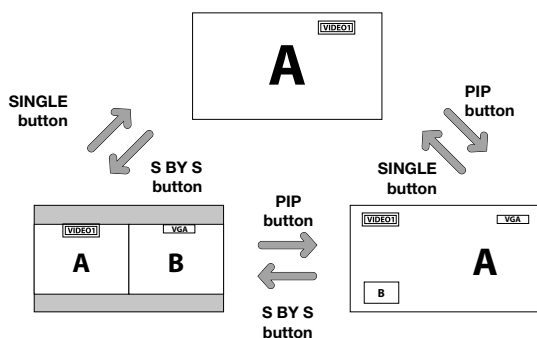

Split Screen mode works according to the table below.

Side by Side Mode

Press the -, +, ▲ or ▼ buttons to change the picture size.

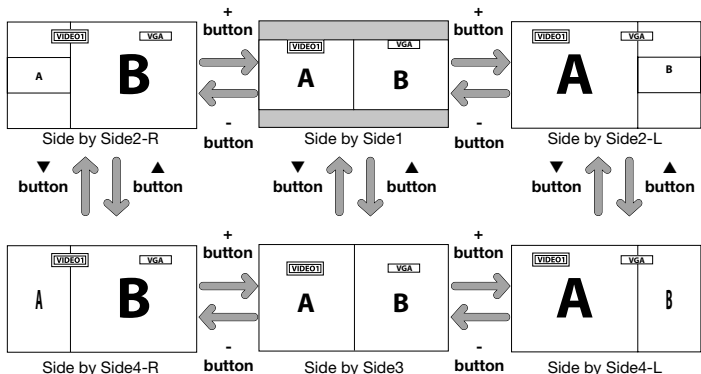

Press the SWAP button to swap pictures.

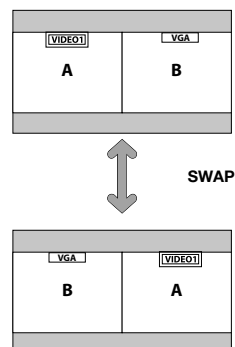

Press the SELECT/FREEZE button to change the active picture.

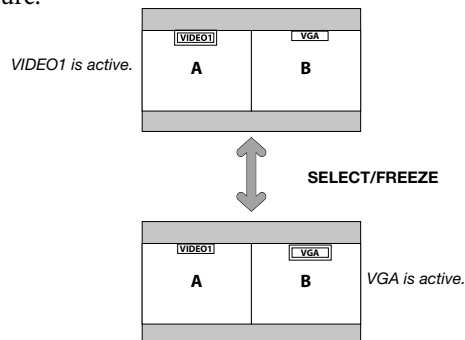

| PIP normal operation test | | | | | | | | | | |
|---------------------------|---------|------------|---------|---------|---------|---------|--------|--------|-----|-----|
| PIP available | | Sub source | | | | | | | | |
| | | VIDEO1 | S-VIDEO | DVD/HD1 | DVD/HD2 | DVD/HD3 | SCART1 | SCART2 | VGA | DVI |
| Main source | VIDEO1 | -- | YES | YES | YES | YES | -- | -- | YES | YES |
| | S-VIDEO | YES | -- | YES | YES | YES | -- | -- | YES | YES |
| | DVD/HD1 | YES | YES | -- | YES | YES | -- | -- | YES | YES |
| | DVD/HD2 | YES | YES | YES | -- | YES | -- | -- | YES | YES |
| | DVD/HD3 | YES | YES | YES | YES | -- | YES | YES | YES | -- |
| | SCART1 | -- | -- | -- | -- | YES | -- | -- | -- | YES |
| | SCART2 | -- | -- | -- | -- | YES | -- | -- | -- | YES |
| | VGA | YES | YES | YES | YES | YES | -- | -- | -- | YES |
| DVI | YES | YES | YES | YES | -- | YES | YES | YES | -- | |

Picture-in-Picture Mode

Press the + and - buttons to change the position of the sub-picture.

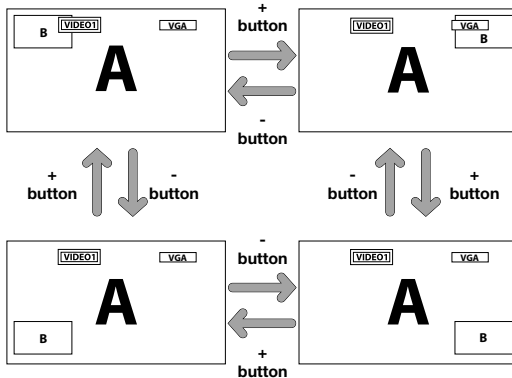

Press the ▲ and ▼ buttons to change the size of the sub-picture.

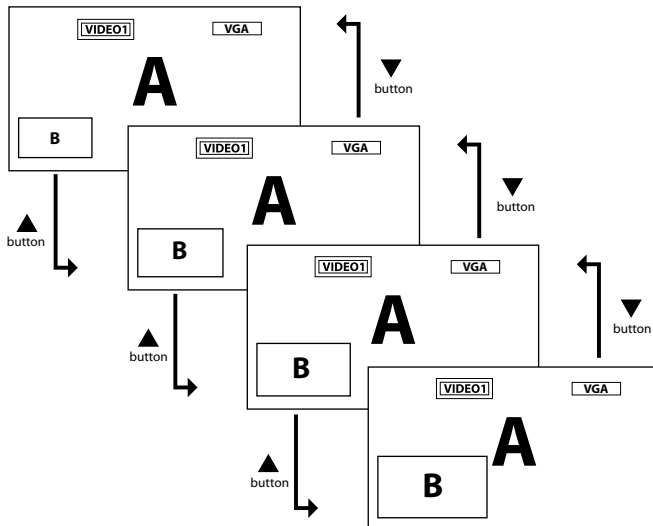

Press the SELECT/FREEZE button to change the active picture.

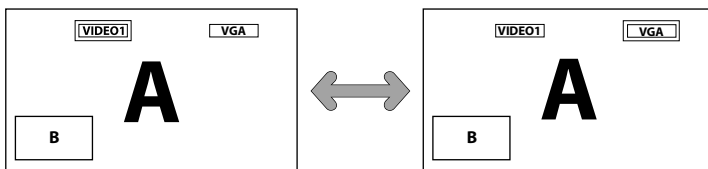

Displaying Input Signal

1. To make the desired picture active, press the SELECT/FREEZE button.
2. To change the active signal, press the VIDEO, DVD/HD, or RGB button.

The input selection may also be changed by pressing the INPUT button on the front of the unit.

Adjusting the OSD controls

1. To make the desired picture active, press the SELECT/FREEZE button.
2. To display the main menu, press the MENU button.
3. Adjust the settings as desired.

NOTE: Some OSD functions may not be available in Split-Screen mode.

Operation - *continued*

Picture Settings Menu

Storing picture settings

This function stores the current input signal and PICTURE menu settings in memory in order to recall these settings if necessary. Up to six different settings can be stored.

Notes of up to 15 characters long can also be stored along with each setting.

Example: Storing picture settings at MEMORY1

On the “PICTURE MEMORY” function under the “PICTURE” menu, select “MEMORY1” and press the SET button. The “PICTURE MEMORY” screen appears.

PICTURE MEMORY

OFF: Picture memory not used.

MEMORY1 TO 6: Choose the desired memory slot to set. There are 6 to choose from, independent of inputs.

SETTING THE MEMORY

Use the ▲ and ▼ buttons to select the desired memory slot, from MEMORY1 to MEMORY6.

Use the ◀ and ▶ buttons to select “SET”, then press the SET button.

If necessary, input a note.

RESETTING THE MEMORY

Use the ▲ and ▼ buttons to select the desired memory slot, from MEMORY1 to MEMORY6, then use the ◀ and ▶ buttons to select “RESET”, and press the SET button.

The memory is cleared, and “—” is displayed in the “INPUT”, “SIGNAL” and “NOTE” columns.

INPUTTING NOTES

Use the ◀ and ▶ buttons to select “NOTE”, then press the SET button.

Use the ▲ and ▼ button to select the character.

Use the ◀ and ▶ buttons to move the cursor.

Use the SET button to delete the character at the cursor position.

When you have finished inputting the note, press the EXIT button.

This Plasma monitor can be controlled via personal computer using an RS-232C connection.

MONITOR ID and RS-232C CONTROL

Up to 26 individual monitors can be controlled through a daisy chain via RS-232C connection.

1. Connect PC to the monitor.

Connect a PC's RS-232C control output to the monitor's RS-232C input. You can then connect the RS-232C output from this monitor to another monitor's RS-232C input. Up to 26 monitors can be connected using RS-232C.

2. Set Monitor ID and RS-232C Control mode.

For proper operation, the Monitor ID should be set in the OSD menu of each monitor that is in the chain. The Monitor ID can be set under the "SETUP" menu in the OSD. The Monitor ID number can be set within a range from 1 to 26 or set to "ALL". No two monitors should share the same Monitor ID number. It is recommended to number each monitor in a daisy chain sequentially from 1. The first monitor in the daisy chain is designated as the primary monitor. Subsequent monitors with the chain are secondary monitors.

In the "FUNCTION" menu on the first monitor in the RS-232C daisy chain set the "RS232C CONTROL" to "NORMAL". Set the "RS232C CONTROL" to "SECONDARY" on all other monitors.

Functions that can be controlled via RS-232C:

- Powering ON or OFF
- Switching input signals

NOTE: If your PC (IBM or IBM compatible) is equipped only with a 25-pin serial port connector, a 25-pin serial port adapter is required. Contact your dealer for details.

NOTE: In order to function, the RS-232C OUT terminal can only be connected to another monitor of the same model. Do not connect to other types of equipment.

This monitor uses RXD, TXD and GND lines for RS-232C control.

The reverse type cable (null modem cable) should be used for RS-232C control.

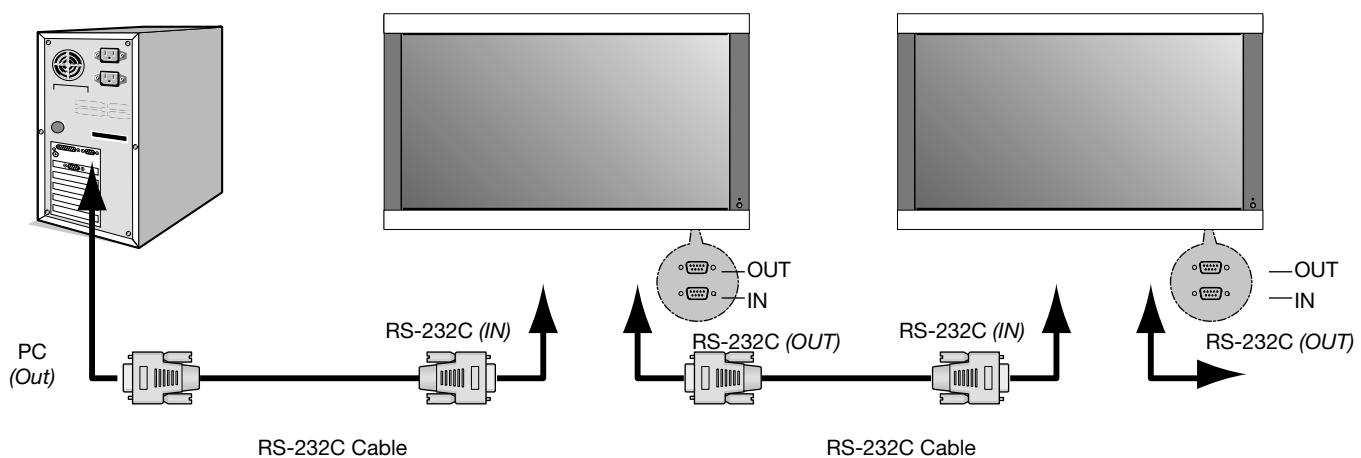

The following control sequence is used for a single monitor

When using the following control commands, all of the daisy-chained monitors can be controlled at the same time from the primary monitor. However, reply and status commands will only pertain to the primary monitor, and not to the secondary monitors.

1) Interface

| | |
|--------------|------------|
| PROTOCOL | RS-232C |
| BAUD RATE | 9600 [bps] |
| DATA LENGTH | 8 [bits] |
| PARITY BIT | NONE |
| STOP BIT | 1 [bit] |
| FLOW CONTROL | NONE |

2) Control command diagram

The command is structured by the address code, function code, data code and end code. The length of the command is different for each function.

| | Address Code | Function Code | Data Code | End Code |
|-------|--------------|---------------|-----------|----------|
| HEX | 30h 30h | Function | Data | 0Dh |
| ASCII | '0' '0' | Function | Data | ␣ |

[Address code] 30h 30h (In ASCII code, '0' '0') fixed.

[Function code] A code of each fixed control move.

[Data code] A code of each fixed control data (number) and not always indicated.

[End code] 0Dh (In ASCII code, '␣') fixed.

To control multiple monitors that are daisy-chained together please use the extended control command.

3) Control sequence

- 1) The command from a computer to the Plasma monitor will take 400ms.
- 2) The Plasma monitor will send a return command 400ms* after it has received an encode. If the command is not received correctly, the Plasma monitor will not send the return command.
- 3) The personal computer checks the command and confirms if the command which has been sent has been executed or not.
- 4) This Plasma monitor sends various codes other than the return code. When sending a control sequence via RS-232C, other codes from personal computers will be ignored.

**The sending time of the return command may be delayed depending on the monitor's current activity (changing of the input signal, etc.).*

[Example] Turn the power ON. (' ' is for ASCII code)

| Sending commands from the PC etc. | Status code from Plasma monitor | Meaning |
|-----------------------------------|---------------------------------|--------------------------------------|
| 30 30 21 0D '0' '0' '!' '␣' | | Command for POWER ON |
| | 30 30 21 0D '0' '0' '!' '␣' | Command received (Command echo back) |

4) Operation commands

Operation commands execute the basic operation setting of this Plasma monitor. It may not operate when changing the signal:

| Operation | ASCII | HEX |
|---------------|-------|-------------|
| POWER ON | ! | 21h |
| POWER OFF | " | 22h |
| INPUT VIDEO1 | _v1 | 5Fh 76h 31h |
| INPUT S-VIDEO | _v3 | 5Fh 76h 33h |
| INPUT DVD/HD1 | _v2 | 5Fh 76h 32h |
| INPUT DVD/HD2 | _v5 | 5Fh 76h 35h |
| INPUT DVD/HD3 | _h1 | 5Fh 68h 31h |
| INPUT SCART2 | _v6 | 5Fh 76h 36h |
| INPUT VGA | _r2 | 5Fh 72h 32h |
| INPUT DVI | _r1 | 5Fh 72h 31h |

- POWER OFF command should not be used less than 1 minute after the power is turned on.
- POWER ON command should not be used less than 1 minute after the power is turned off.

5) Read command

Host computer sends the command without Data-code to monitor.

After receiving this command, the monitor returns the command with Data-code of current status to host computer.

<ex> When the Host computer checks the Power status of monitor, the status of monitor is powered-on.

| Command from computer | Command from Monitor | Detail of command |
|------------------------------------|---|--|
| 30 30 76 50 0D '0"0"v"P'[enter] | | Ask about the power status of monitor. |
| | 30 30 76 50 31 0D '0"0"v"P"1'[enter] | Monitor is powered-on. |

Structure of the Read-command

| | ASCII | | HEX | |
|-----------------------|----------|------|----------|---------|
| | Function | Data | Function | Data |
| POWER ON | vP | 1 | 76h 50h | 31h |
| POWER OFF | vP | 0 | 76h 50h | 30h |
| INPUT VIDEO1 | vl | v1 | 76h 49h | 76h 31h |
| INPUT S-VIDEO | vl | v3 | 76h 49h | 76h 33h |
| INPUT DVD/HD1 | vl | v2 | 76h 49h | 76h 32h |
| INPUT DVD/HD2 | vl | v5 | 76h 49h | 76h 35h |
| INPUT DVD/HD3 | vl | h1 | 76h 49h | 68h 31h |
| INPUT SCART2 | vl | v6 | 76h 49h | 76h 36h |
| INPUT VGA | vl | r2 | 76h 49h | 72h 32h |
| INPUT DVI | vl | r1 | 76h 49h | 72h 31h |
| Picture Mode BRIGHT | vM | p1 | 76h 4Dh | 70h 31h |
| Picture Mode STANDARD | vM | p2 | 76h 4Dh | 70h 32h |
| Picture Mode CINEMA1 | vM | p3 | 76h 4Dh | 70h 33h |
| Picture Mode CINEMA2 | vM | p4 | 76h 4Dh | 70h 34h |
| Picture Mode DEFAULT | vM | p5 | 76h 4Dh | 70h 35h |

No picture

- The signal cable should be properly connected to the display card/computer.
- The display card should be properly seated in its slot.
- Front Power Switch and computer power switch should be in the ON position.
- Check to make sure that a supported mode has been selected on the display card or system being used. (Please consult display card or system manual to change graphics mode.)
- Check the monitor and your display card with respect to compatibility and recommended settings.
- Check the signal cable connector for bent or pushed-in pins.

Power Button does not respond

- Unplug the power cord of the monitor from the AC outlet to turn off and reset the monitor.

Image persistence

- Please be aware that Plasma Technology may experience a phenomena known as Image Persistence. Image Persistence occurs when a residual or “ghost” image of a previous image remains visible on the screen. Unlike CRT monitors, Plasma monitors’ image persistence is not permanent, but constant images being displayed for a long period of time should be avoided. To alleviate image persistence, turn off the monitor for as long as the previous image was displayed. For example, if an image was on the monitor for one hour and a residual image remains, the monitor should be turned off for one hour to erase the image.

NOTE: As with all personal display devices, NEC DISPLAY SOLUTIONS recommends displaying moving images and using a moving screen saver at regular intervals whenever the screen is idle or turning off the monitor when not in use.

Image is unstable, unfocused or swimming is apparent

- Signal cable should be properly attached to the Plasma monitor, computer, or other input device.
- Use the OSD screen controls to focus and adjust display by increasing or decreasing the clock phase total. When the display mode is changed, the OSD Image Adjust settings may need to be readjusted.
- Check the monitor and your display card with respect to compatibility and recommended signal timings.

Image of component signal is greenish

- Check to see if the DVD/HD input connector is selected.

LED on monitor is not lit

(no green or red color can be seen)

- Main Power Switch should be in the ON position and power cord should be connected.

Red LED on monitor is blinking

- A certain failure might have occurred, please contact your nearest authorized NEC DISPLAY SOLUTIONS service facility.

Display image is not sized properly

- Use the OSD screen controls to increase or decrease the clock total.
- Check to make sure that a supported mode has been selected on the display card or system being used. (Please consult display card or system manual to change graphics mode.)

Selected resolution is not displayed properly

- Use OSD information to enter Information menu and confirm that the appropriate resolution has been selected. If not, select appropriate resolution.

No Sound

- Check to see if speaker cable is properly connected.
 - Check to see if mute is activated.
 - Check to see if volume is set at minimum.
- NOTE:** It is possible to play audio from a source that is different from the video source.

RS-232C does not work

- Check the PROTOCOL SET in the FUNCTION menu.

Remote Control does not work

- Make sure the batteries are inserted properly.
- Test the batteries for strength/life.
- Make sure to point the remote directly at the sensor on the monitor.
- Check if the remote is in Remote ID mode.
- The remote control may not function when in direct sunlight or when there is strong illumination on the remote sensor of the monitor.

Specifications 42XC10

| | | | | | |
|--|---|--|-------------------|--|-----------------------------|
| PDP Module | Diagonal: 42"/1058 mm | | | | |
| | Pixel Pitch | 0.900 mm (W)/0.676 mm (H) | | | |
| | Resolution | 1024 x 768 | | | |
| Frequency | Horizontal | ANALOG: 15.625/15.734kHz, 31.0kHz - 108.5kHz | | | |
| | | DIGITAL: 15.625/15.734kHz, 31.0kHz - 91.1kHz | | | |
| | Vertical | 24Hz to 120.4Hz | | | |
| Panel Display Size | 922 mm (W) x 519 mm (H) 36.3 in (W) x 20.4 in (H) | | | | |
| Input Signals | DVI | DVI-D 24pin | Digital RGB | DVI (HDCP) VGA60, SVGA60, XGA60, WXGA60, SXGA60, UXGA60*, 1920X1080* | |
| | | | Analog RGB | 0.7V p-p, Input Impedance 75 ohm VGA60, SVGA60, XGA60, WXGA60, SXGA60, UXGA60* | |
| | VGA | 15pin Mini D-sub | Sync | Separate: TTL level (Pos./Neg.) Composite sync on Green Video: 0.3Vp-p Neg | |
| | | | Component | Y : 1.0Vp-p/75ohm, Cb/Cr (Pb/Pr) : 0.7Vp-p/75 ohm HDTV/DVD:1080p*, 1080i*, 720p@50Hz/60Hz, 576p@50Hz, 480p@60Hz, 576i@50Hz, 480i@60Hz | |
| | DVD/HD1,2 | RCA (Y, Cb/Pb, Cr/Pr) | Component | HDMI | |
| | DVD/HD3 (HDMI) | HDMI Type-A | Digital Component | 1080p*,1080i*,720p@ 50Hz/60Hz, 576p@ 50Hz, 480p@ 60Hz, 576i@50Hz, 480i@60Hz | |
| | VIDEO1 | RCA | Composite | 1.0V p-p Input Impedance 75 ohm NTSC/PAL(B, G, M, N)/SECAM/4.43NTSC/PAL60 | |
| | S-VIDEO | mini DIN 4 pin | S-VIDEO | Y: 1.0Vp-p/75ohm C: 0.286Vp-p/75 ohm(NTSC), 0.3Vp-p/75ohm(PAL/SECAM) NTSC/PAL(B, G, M, N)/SECAM/4.43NTSC/PAL60 | |
| | Audio | AUDIO Input | RCA (L/R) X3 | Analog Audio | Stereo L/R 0.5Vrms |
| | | | HDMI Type-A | DIGITAL Audio | PCM 32, 44.1, 48Khz (16bit) |
| Speaker Output | External Speaker Jack 8W + 8W (8 ohm) | | | | |
| External Control | RS-232C: IN | 9 Pin D-sub | | | |
| | RS-232C: OUT | 9 Pin D-sub (daisy chain) | | | |
| Power Supply | 4.4-1.8A@100-240V AC, 50/60Hz | | | | |
| Operational Environment | Temperature | 0° to 40°C / 32° F to 104° F | | | |
| | Humidity | 20% to 80% (without condensation) | | | |
| Storage Environment | Temperature | -10°C to 50°C / 14° F to 122° F | | | |
| | Humidity | 10 - 90% (without condensation) / 90% - 2% x (Temp - 40°C) regarding over 40°C | | | |
| Dimensions (WxHxD) | Net | 1036mm(W) x 649mm(H) x 130mm(D) / 40.8"(W) x 25.6"(H) x 5.1"(D) | | | |
| | Gross | 1220mm(W) x 900mm(H) x 360mm(D) / 48.0"(W) x 35.4"(H) x 14.2"(D) | | | |
| Weight (without speaker and stand) | Net | 34.5 kg / 76.1 lbs | | | |
| | Gross | 42.5 kg / 93.7 lbs | | | |
| VESA compatible arm mounting interface | 700mm x 300mm 4 Holes (screw M8 Depth 16mm) | | | | |
| Complied Regulatory and Guidelines | UL 60065/CSA C22.2 No.60065/EN60065/IEC60065 FCC-B/DOC-B/EN55022-B/EN55024/EN61000-3-2/EN61000-3-3/CE/C-Tick | | | | |
| Power Management | VESA DPM (Separate HV Sync. only) | | | | |
| Plug & Play | VESA DDC2B | | | | |
| Accessories | Remote control, AA Batteries, Power cord, Users Manual (CD-ROM), Start Up Guide (Paper / CD-ROM), Main Power Switch cover and screw, Cable clamps | | | | |
| *Compressed Image | | | | | |

Specifications 50XC10

| | | | | | |
|--|---|---|-------------------|--|-----------------------------|
| PDP Module | Diagonal: 50"/1269 mm | | | | |
| | Pixel Pitch | 0.81 mm (W)/0.81 mm (H) | | | |
| | Resolution | 1365 x 768 | | | |
| Frequency | Horizontal | ANALOG: 15.625/15.734kHz, 31.0kHz - 108.5kHz | | | |
| | | DIGITAL: 15.625/15.734kHz, 31.0kHz - 91.1kHz | | | |
| | Vertical | 24Hz to 120.4Hz | | | |
| Panel Display Size | 1106 mm (W) x 622 mm (H) 43.5 in (W) x 24.5 in (H) | | | | |
| Input Signals | DVI | DVI-D 24pin | Digital RGB | DVI (HDCP) VGA60, SVGA60, XGA60, WXGA60, SXGA60, UXGA60*, 1920X1080* | |
| | | | Analog RGB | 0.7V p-p, Input Impedance 75 ohm VGA60, SVGA60, XGA60, WXGA60, SXGA60, UXGA60* | |
| | VGA | 15pin Mini D-sub | Sync | Separate: TTL level (Pos./Neg.) Composite sync on Green Video: 0.3Vp-p Neg | |
| | | | Component | Y : 1.0Vp-p/75ohm, Cb/Cr (Pb/Pr) : 0.7Vp-p/75 ohm HDTV/DVD:1080p*, 1080i*, 720p@50Hz/60Hz, 576p@50Hz, 480p@60Hz, 576i@50Hz, 480i@60Hz | |
| | DVD/HD1,2 | RCA (Y, Cb/Pb, Cr/Pr) | Component | HDMI 1080p*,1080i*,720p@ 50Hz/60Hz, 576p@ 50Hz, 480p@ 60Hz, 576i@50Hz, 480i@60Hz | |
| | DVD/HD3 (HDMI) | HDMI Type-A | Digital Component | 1.0V p-p Input Impedance 75 ohm NTSC/PAL(B, G, M, N)/SECAM/4.43NTSC/PAL60 | |
| | VIDEO1 | RCA | Composite | Y: 1.0Vp-p/75ohm C: 0.286Vp-p/75 ohm(NTSC), 0.3Vp-p/75ohm(PAL/SECAM) NTSC/PAL(B, G, M, N)/SECAM/4.43NTSC/PAL60 | |
| | S-VIDEO | mini DIN 4 pin | S-VIDEO | | |
| | Audio | AUDIO Input | RCA (L/R) X3 | Analog Audio | Stereo L/R 0.5Vrms |
| | | | HDMI Type-A | DIGITAL Audio | PCM 32, 44.1, 48Khz (16bit) |
| Speaker Output | External Speaker Jack 8W + 8W (8 ohm) | | | | |
| External Control | RS-232C: IN | 9 Pin D-sub | | | |
| | RS-232C: OUT | 9 Pin D-sub (daisy chain) | | | |
| Power Supply | 6.0-2.6A@100-240V AC, 50/60Hz | | | | |
| Operational Environment | Temperature | 0° to 40° C / 32° F to 104° F | | | |
| | Humidity | 20% to 80% (without condensation) | | | |
| Storage Environment | Temperature | -10° C to 50° C / 14° F to 122° F | | | |
| | Humidity | 10 - 90% (without condensation)/ 90% - 2% x (Temp - 40°C) regarding over 40°C | | | |
| Dimensions (WxHxD) | Net | 1221mm(W) x 748mm(H) x 130mm(D) / 48.1"(W) x 29.4"(H) x 5.1"(D) | | | |
| | Gross | 1400mm(W) x 980mm(H) x 360mm(D) / 55.1"(W) x 38.6"(H) x 14.2"(D) | | | |
| Weight (without speaker and stand) | Net | 49.0 kg / 108.0 lbs | | | |
| | Gross | 59.0 kg / 130.1 lbs | | | |
| VESA compatible arm mounting interface | 700mm x 300mm 4 Holes (screw M8 Depth 16mm) | | | | |
| Complied Regulatory and Guidelines | UL 60065/CSA C22.2 No.60065/EN60065/IEC60065 FCC-B/DOC-B/EN55022-B/EN55024/EN61000-3-2/EN61000-3-3/CE/C-Tick | | | | |
| Power Management | VESA DPM (Separate HV Sync. only) | | | | |
| Plug & Play | VESA DDC2B | | | | |
| Accessories | Remote control, AA Batteries, Power cord, Users Manual (CD-ROM), Start Up Guide (Paper / CD-ROM), Main Power Switch cover and screw, Cable clamps | | | | |
| *Compressed Image | | | | | |

Specifications 60XC10

| | | | | | |
|--|---|---|-------------------|--|-----------------------------|
| PDP Module | Diagonal: 60"/1514 mm | | | | |
| | Pixel Pitch | 0.966 mm (W)/0.966 mm (H) | | | |
| | Resolution | 1366 x 768 | | | |
| Frequency | Horizontal | ANALOG: 15.625/15.734kHz, 31.0kHz - 108.5kHz | | | |
| | | DIGITAL: 15.625/15.734kHz, 31.0kHz - 91.1kHz | | | |
| | Vertical | 24Hz to 120.4Hz | | | |
| Panel Display Size | 1320 mm (W) x 742 mm (H) 51.9 in (W) x 29.2 in (H) | | | | |
| Input Signals | DVI | DVI-D 24pin | Digital RGB | DVI (HDCP) VGA60, SVGA60, XGA60, WXGA60, SXGA60, UXGA60*, 1920X1080* | |
| | | | Analog RGB | 0.7V p-p, Input Impedance 75 ohm VGA60, SVGA60, XGA60, WXGA60, SXGA60, UXGA60* | |
| | VGA | 15pin Mini D-sub | Sync | Separate: TTL level (Pos./Neg.) Composite sync on Green Video: 0.3Vp-p Neg | |
| | | | Component | Y : 1.0Vp-p/75ohm, Cb/Cr (Pb/Pr) : 0.7Vp-p/75 ohm HDTV/DVD:1080p*, 1080i*, 720p@50Hz/60Hz, 576p@50Hz, 480p@60Hz, 576i@50Hz, 480i@60Hz | |
| | DVD/HD1,2 | RCA (Y, Cb/Pb, Cr/Pr) | Component | HDMI | |
| | DVD/HD3 (HDMI) | HDMI Type-A | Digital Component | 1080p*, 1080i*, 720p@ 50Hz/60Hz, 576p@ 50Hz, 480p@ 60Hz, 576i@50Hz, 480i@60Hz | |
| | VIDEO1 | RCA | Composite | 1.0V p-p Input Impedance 75 ohm NTSC/PAL(B, G, M, N)/SECAM/4.43NTSC/PAL60 | |
| | S-VIDEO | DIN 4 pin | S-VIDEO | Y: 1.0Vp-p/75ohm C: 0.286Vp-p/75 ohm(NTSC), 0.3Vp-p/75ohm(PAL/SECAM) NTSC/PAL(B, G, M, N)/SECAM/4.43NTSC/PAL60 | |
| | Audio | AUDIO Input | RCA (L/R) X3 | Analog Audio | Stereo L/R 0.5Vrms |
| | | | HDMI Type-A | DIGITAL Audio | PCM 32, 44.1, 48KHz (16bit) |
| Speaker Output | External Speaker Jack 8W + 8W (8 ohm) | | | | |
| External Control | RS-232C: IN | 9 Pin D-sub | | | |
| | RS-232C: OUT | 9 Pin D-sub (daisy chain) | | | |
| Power Supply | 7.8-3.2A@100-240V AC, 50/60Hz | | | | |
| Operational Environment | Temperature | 0° to 40° C / 32° F to 104° F | | | |
| | Humidity | 20% to 80% (without condensation) | | | |
| Storage Environment | Temperature | -10° C to 50° C / 14° F to 122° F | | | |
| | Humidity | 10 - 90% (without condensation)/ 90% - 2% x (Temp - 40°C) regarding over 40°C | | | |
| Dimensions (WxHxD) | Net | 1447mm(W) x 876mm(H) x 130mm(D) / 57.0"(W) x 34.5"(H) x 5.1"(D) | | | |
| | Gross | 1620mm(W) x 1100mm(H) x 360mm(D) / 63.8"(W) x 43.3"(H) x 14.2"(D) | | | |
| Weight (without speaker and stand) | Net | 70.0 kg / 154.3 lbs | | | |
| | Gross | 83.0 kg / 183.0 lbs | | | |
| VESA compatible arm mounting interface | 700mm x 300mm 4 Holes (screw M8 Depth 16mm) | | | | |
| Complied Regulatory and Guidelines | UL 60065/CSA C22.2 No.60065/EN60065/IEC60065 FCC-B/DOC-B/EN55022-B/EN55024/EN61000-3-2/EN61000-3-3/CE/C-Tick | | | | |
| Power Management | VESA DPM (Separate HV Sync. only) | | | | |
| Plug & Play | VESA DDC2B | | | | |
| Accessories | Remote control, AA Batteries, Power cord, Users Manual (CD-ROM), Start Up Guide (Paper / CD-ROM), Main Power Switch cover and screw, Cable clamps | | | | |
| *Compressed Image | | | | | |

50XC10 Supported Resolutions (PC)

| Sig. no. | Resolution H X V | Signal Type | Specification of the signal | | Analog | | | Digital | | | Sync presence | Gr. No. | RGB select Item |
|----------|------------------|-------------|-----------------------------|---------------|--------------------|--------------|-------------|---------|-------------------------|--------------|---------------|---------|-----------------|
| | | | V freq. (kHz) | H freq. (kHz) | INPUT terminal VGA | NORMAL (4:3) | FULL (16:9) | ZOOM | INPUT terminal (DVI-PC) | NORMAL (4:3) | | | |
| 1 | 640 X 400 | 400line | 70.1 | 31.5 | | | | | | | | | 640X400 |
| 2 | 720 X 400 | 400line | 70.1 | 31.5 | | | | | | | | | 720X400 |
| 3 | 720 X 350 | 350line | 85 | 37.9 | | | | | | | | | |
| 4 | 640 X 480 | VGA | 70.1 | 31.5 | | | | | | | | | 720X350 |
| 5 | 640 X 480 | VGA | 59.9 | 31.5 | | | | | | | | | 640X480 |
| 6 | | | 72.8 | 37.9 | | | | | | | | | |
| 7 | | | 75 | 37.5 | | | | | | | | | |
| 8 | | | 85 | 43.3 | | | | | | | | | |
| 9 | | | 100.4 | 51.1 | | | | | | | | | |
| 10 | | | 120.4 | 61.3 | | | | | | | | | |
| 11 | 848 X 480 | Wide-VGA | 60 | 31 | | | | | | | | | 848X480 |
| 12 | 852 X 480 | Wide-VGA | 60 | 31.7 | | | | | | | | | 852X480 |
| 13 | 800 X 600 | SVGA | 56.3 | 35.2 | | | | | | | | | |
| 14 | | | 60.3 | 37.9 | | | | | | | | | |
| 15 | | | 72.2 | 48.1 | | | | | | | | | |
| 16 | | | 75 | 46.9 | | | | | | | | | |
| 17 | | | 85.1 | 53.7 | | | | | | | | | |
| 18 | | | 99.8 | 63 | | | | | | | | | |
| 19 | | | 120 | 75.7 | | | | | | | | | |
| 20 | 1024 X 768 | XGA | 60 | 48.4 | | | | | | | | | 1024X768 |
| 21 | | | 70.1 | 56.5 | | | | | | | | | 1024X768 |
| 22 | | | 71.9 | 57.9 | | | | | | | | | 1024X768 |
| 23 | | | 85 | 66.7 | | | | | | | | | |
| 24 | | | 100.6 | 80.5 | | | | | | | | | |
| 25 | | | 119.4 | 95.5 | | | | | | | | | |
| 26 | | | 120 | 106.5 | | | | | | | | | |
| 27 | 1152 X 864 | XGA | 60 | 53.7 | | | | | | | | | |
| 28 | | | 72 | 64.9 | | | | | | | | | |
| 29 | | | 75 | 67.5 | | | | | | | | | |
| 30 | 1280 X 768 | Wide-XGA | 56.2 | 45.1 | | | | | | | | | 1280X768-1 |
| 31 | | | 59.8 | 48 | | | | | | | | | 1280X768-2 |
| 32 | | | 59.9 | 47.8 | | | | | | | | | 1280X768 |
| 33 | | | 69.8 | 58 | | | | | | | | | 1280X768 |
| 34 | | | 72 | 57.8 | | | | | | | | | 1280X900 |
| 35 | 1280 X 900 | Wide-XGA | 59.8 | 49.7 | | | | | | | | | |
| 36 | 1280 X 854 | Wide-XGA | 60 | 53.1 | | | | | | | | | |
| 37 | 1280 X 960 | Wide-XGA | 60 | 60 | | | | | | | | | |
| 38 | | | 85 | 85.9 | | | | | | | | | |
| 39 | 1360 X 768 | Wide-XGA | 60 | 47.7 | | | | | | | | | 1360X768 |
| 40 | 1376 X 768 | Wide-XGA | 59.9 | 48.3 | | | | | | | | | 1376X768 |
| 41 | 1280 X 1024 | SXGA | 60 | 64 | | | | | | | | | 1280X1024 |
| 42 | | | 75 | 80 | | | | | | | | | |
| 43 | | | 85 | 91.1 | | | | | | | | | |
| 44 | | | 100.1 | 109.5 | | | | | | | | | |
| 45 | 1400 X 1050 | SXGA+ | 60 | 64 | | | | | | | | | 1400X1050 |
| 46 | | | 60 | 64 | | | | | | | | | 1400X1050 |
| 47 | | | 74.9 | 82.3 | | | | | | | | | |
| 48 | | | 85 | 93.9 | | | | | | | | | |
| 49 | 1680 X 1050 | Wide-SXGA | 60 | 65.3 | | | | | | | | | 1680X1050 |
| 50 | 1600 X 1200 | UXGA | 60 | 75 | | | | | | | | | 1600X1200 |
| 51 | | | 65 | 81.3 | | | | | | | | | |
| 52 | | | 70 | 87.5 | | | | | | | | | |
| 53 | | | 75 | 93.8 | | | | | | | | | |
| 54 | | | 85 | 108.3 | | | | | | | | | |
| 55 | 1920 X 1080 | | 50 | 56.2 | | | | | | | | | |
| 56 | | | 60 | 67.5 | | | | | | | | | |
| 57 | 1920 X 1200 | Wide-UXGA | 59.9 | 74.6 | | | | | | | | | 1920X1200 |
| 58 | 1920 X 1200RB | Wide-UXGA | 60 | 74 | | | | | | | | | |
| 59 | 640 X 480 | Mac13" | 66.7 | 35 | | | | | | | | | |
| 82 | 832 X 624 | Mac16" | 74.6 | 48.7 | | | | | | | | | |
| 83 | 1024 X 768 | Mac19" | 74.9 | 60.2 | | | | | | | | | |
| 84 | 1152 X 870 | Mac21" | 75.1 | 66.7 | | | | | | | | | |
| 85 | 1440 X 900 | Apple17 | 59.9 | 55.9 | | | | | | | | | |
| 91 | Work Station | EWS4800 | 60 | 64.6 | | | | | | | | | |
| 92 | 1280 X 1024 | HP | 71.2 | 75.1 | | | | | | | | | |
| 93 | 1280 X 1024 | SUN | 72 | 76.1 | | | | | | | | | |
| 94 | 1152 X 900 | | 66 | 61.8 | | | | | | | | | |
| 95 | 1280 X 900 | | 76 | 71.7 | | | | | | | | | |
| 96 | 1280 X 1024 | | 76.1 | 81.1 | | | | | | | | | |
| 97 | 1024 X 768 | SGI | 60 | 49.7 | | | | | | | | | 1024X768 |
| 98 | 1280 X 1024 | | 60 | 63.9 | | | | | | | | | |

| | | | | |
|---------------|-------------------------|-------------------------|-------------------------------|----------------|
| --- | NORMAL (4:3) | FULL (16:9) | (*) | (*) |
| Not Supported | 1024 pixels x 768 lines | 1365 pixels x 768 lines | Aspect ratio is 5:4 (960x768) | Rough Sampling |

Supported Resolutions (PC) 60XC10

| Sig. no. | Resolution H X V | Signal Type | Specification of the signal | | Analog | | Digital | | Sync presence | Gr. No. | RGB select item | |
|---------------------------------------|------------------|---------------|-----------------------------|---------------|----------------|-------------|----------------|-------------|---------------|------------|-----------------|----|
| | | | V freq. (Hz) | H freq. (kHz) | INPUT terminal | SIZE (16:9) | INPUT terminal | SIZE (16:9) | | | | H |
| IBM PC/AT Compatible Computers | 1 | 640 X 400 | 70.1 | 31.5 | -- | -- | DVI | -- | Neg. | 1 | 640X400 | |
| | 2 | 720 X 400 | 70.1 | 31.5 | -- | -- | (DVI+PC) | -- | Neg. | 1 | 720X400 | |
| | 3 | 720 X 350 | 85 | 37.9 | -- | -- | | -- | Neg. | 1 | 720X350 | |
| | 4 | 720 X 350 | 70.1 | 31.5 | -- | -- | | -- | Neg. | 1 | 720X350 | |
| | 5 | 640 X 480 | 59.9 | 31.5 | Yes | Yes | | Yes | Neg. | 2 | 640X480 | |
| | 6 | | 72.8 | 37.9 | Yes | Yes | | Yes | Neg. | -- | -- | |
| | 7 | | 75 | 37.5 | Yes | Yes | | Yes | Neg. | -- | -- | |
| | 8 | | 85 | 43.3 | Yes | Yes | | Yes | Neg. | -- | -- | |
| | 9 | | 100.4 | 51.1 | Yes | Yes | | Yes | Neg. | -- | -- | |
| | 10 | | 120.4 | 61.3 | Yes | Yes | | Yes | Neg. | -- | -- | |
| Apple Macintosh® | 11 | 848 X 480 | 60 | 31 | -- | -- | | -- | Pos. | 2 | 848X480 | |
| | 12 | 852 X 480 | 60 | 31.7 | -- | -- | | -- | Neg. | 2 | 852X480 | |
| | 13 | 800 X 600 | 56.3 | 35.2 | Yes | Yes | | Yes | Pos. | -- | -- | |
| | 14 | | 60.3 | 37.9 | Yes | Yes | | Yes | Pos. | -- | -- | |
| | 15 | | 72.2 | 46.1 | Yes | Yes | | Yes | Pos. | -- | -- | |
| | 16 | | 75 | 46.9 | Yes | Yes | | Yes | Pos. | -- | -- | |
| | 17 | | 85.1 | 53.7 | Yes | Yes | | Yes | Pos. | -- | -- | |
| | 18 | | 99.8 | 63 | Yes | Yes | | Yes | Pos. | -- | -- | |
| | 19 | | 120 | 75.7 | Yes | Yes | | Yes | Pos. | -- | -- | |
| | 20 | 1024 X 768 | XGA | 60 | 48.4 | Yes | Yes | | Neg. | 3 | 1024X768 | |
| EWS Series | 21 | | 70.1 | 56.5 | Yes | Yes | | Neg. | 5 | 1024X768 | | |
| | 22 | | 71.9 | 57.9 | Yes | Yes | | Neg. | 6 | 1024X768 | | |
| | 23 | | 75 | 60 | Yes | Yes | | Pos. | Yes | -- | -- | |
| | 24 | | 85 | 68.7 | Yes | Yes | | Pos. | Yes | -- | -- | |
| | 25 | | 100.6 | 80.5 | Yes | Yes | | Pos. | Yes | -- | -- | |
| | 26 | | 119.4 | 95.5 | Yes | Yes | | Neg. | Yes | -- | -- | |
| | 27 | 1152 X 864 | XGA | 60 | 53.7 | Yes | Yes | | Neg. | Yes | -- | -- |
| | 28 | | 72 | 64.9 | Yes | Yes | | Pos. | Yes | -- | -- | |
| | 29 | | 75 | 67.5 | Yes | Yes | | Pos. | Yes | -- | -- | |
| | 30 | 1280 X 768 | Wide-XGA | 56.2 | 45.1 | Yes | Yes | | Pos. | 3 | 1280X768-1 | |
| Not Supported | 31 | | 59.8 | 48 | -- | -- | | Neg. | 3 | 1280X768-2 | | |
| | 32 | | 59.9 | 47.8 | -- | -- | | Pos. | 5 | 1280X768 | | |
| | 33 | | 69.8 | 56 | -- | -- | | Pos. | 6 | 1280X768 | | |
| | 34 | | 72 | 57.8 | -- | -- | | Neg. | 4 | 1280X800 | | |
| | 35 | 1280 X 800 | Wide-XGA | 59.8 | 49.7 | -- | -- | | Pos. | Yes | -- | |
| | 36 | 1280 X 854 | Wide-XGA | 60 | 53.1 | -- | -- | | Neg. | Yes | -- | |
| | 37 | 1280 X 960 | Wide-XGA | 60 | 60 | Yes | Yes | | Pos. | Yes | -- | |
| | 38 | | 85 | 85.9 | Yes | Yes | | Pos. | Yes | -- | -- | |
| | 39 | 1360 X 768 | Wide-XGA | 60 | 47.7 | -- | -- | | Pos. | 3 | 1360X768 | |
| | 40 | 1376 X 768 | Wide-XGA | 59.9 | 48.3 | -- | -- | | Pos. | 3 | 1376X768 | |
| Downloaded From TV-Manual.com Manuals | 41 | 1280 X 1024 | SXGA | 60 | 64 | Yes | Yes | | Pos. | 9 | 1280X1024 | |
| | 42 | | 75 | 80 | Yes | Yes | | Pos. | Yes | -- | -- | |
| | 43 | | 85 | 91.1 | Yes | Yes | | Pos. | Yes | -- | -- | |
| | 44 | | 100.1 | 106.5 | Yes | Yes | | Pos. | Yes | -- | -- | |
| | 45 | 1400 X 1050 | SXGA+ | 60 | 64 | Yes | Yes | | Neg. | 7 | 1400X1050 | |
| | 46 | | 60 | 65.3 | Yes | Yes | | Neg. | 9 | 1400X1050 | | |
| | 47 | | 74.9 | 82.3 | Yes | Yes | | Pos. | Yes | -- | -- | |
| | 48 | | 85 | 93.9 | Yes | Yes | | Neg. | Yes | -- | -- | |
| | 49 | 1680 X 1050 | Wide-SXGA | 60 | 65.3 | -- | -- | | Pos. | Yes | -- | |
| | 50 | 1600 X 1200 | UXGA | 60 | 75 | Yes | Yes | | Pos. | 8 | 1600X1200 | |
| Downloaded From TV-Manual.com Manuals | 51 | | 65 | 81.3 | Yes | Yes | | Pos. | Yes | -- | -- | |
| | 52 | | 70 | 87.5 | Yes | Yes | | Pos. | Yes | -- | -- | |
| | 53 | | 75 | 93.8 | Yes | Yes | | Pos. | Yes | -- | -- | |
| | 54 | | 85 | 106.3 | Yes | Yes | | Pos. | Yes | -- | -- | |
| | 55 | 1920 X 1080 | | 50 | 56.2 | -- | -- | | Pos. | Yes | -- | |
| | 56 | | 60 | 67.5 | -- | -- | | Pos. | Yes | -- | -- | |
| | 57 | 1920 X 1200 | Wide-UXGA | 59.9 | 74.6 | Yes | Yes | | Neg. | 8 | 1920X1200 | |
| | 58 | 1920 X 1200RB | Wide-UXGA | 60 | 74 | -- | -- | | Neg. | Yes | -- | |
| | 59 | 640 X 480 | Mac13" | 66.7 | 35 | Yes | Yes | | Sync on G | -- | -- | |
| | 60 | 832 X 624 | Mac16" | 74.6 | 49.7 | Yes | Yes | | Sync on G | -- | -- | |
| 61 | 1024 X 768 | Mac19" | 74.9 | 60.2 | Yes | Yes | | Sync on G | -- | -- | | |
| 62 | 1152 X 870 | Mac21" | 75.1 | 66.7 | Yes | Yes | | Sync on G | -- | -- | | |
| 63 | 1440 X 900 | Apple17 | 59.9 | 55.9 | -- | -- | | Sync on G | -- | -- | | |
| 64 | Word Station | EWS4800 | 60 | 64.6 | Yes | Yes | | Neg. | Pos. | Yes | | |
| 65 | 1280 X 1024 | HP | 71.2 | 75.1 | Yes | Yes | | Neg. | Neg. | Yes | | |
| 66 | 1152 X 900 | SUN | 66 | 61.8 | Yes | Yes | | Neg. | Neg. | Yes | | |
| 67 | 1152 X 900 | SUN | 76 | 71.7 | Yes | Yes | | C Sync | C Sync | Yes | | |
| 68 | 1280 X 1024 | SUN | 76 | 71.7 | Yes | Yes | | C Sync | C Sync | Yes | | |
| 69 | 1024 X 768 | SUN | 60 | 48.7 | Yes | Yes | | C Sync | C Sync | Yes | | |
| 70 | 1280 X 1024 | SUN | 60 | 63.9 | Yes | Yes | | C Sync | C Sync | Yes | | |

| | | | | |
|---------------|-------------------------|-------------------------|-------------------------------|----------------|
| ... | NORMAL (4:3) | FULL (16:9) | (*) | (*) |
| Not Supported | 1024 pixels x 768 lines | 1386 pixels x 768 lines | Aspect ratio is 5:4 (800x768) | Rough Sampling |

Pin Assignment

1) Analog RGB Input (Mini D-SUB 15P) VGA

| Pin No. | Name |
|---------|--------------------|
| 1 | Video Signal Red |
| 2 | Video Signal Green |
| 3 | Video Signal Blue |
| 4 | GND |
| 5 | DDC-GND |
| 6 | Red-GND |
| 7 | Green-GND |
| 8 | Blue-GND |
| 9 | +5V (DDC) |
| 10 | SYNC-GND |
| 11 | GND |
| 12 | DDC-SDA |
| 13 | H-SYNC |
| 14 | V-SYNC |
| 15 | DDC-SCL |

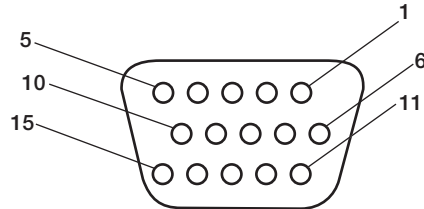

Mini D-SUB 15P

3) RS-232C Input (D-SUB 9P)

| Pin No. | Name |
|---------|--------------------|
| 1 | Connected to 7 & 8 |
| 2 | RXD |
| 3 | TXD |
| 4 | Connected to 6 |
| 5 | GND |
| 6 | Connected to 4 |
| 7 | Connected to 1 & 8 |
| 8 | Connected to 1 & 7 |
| 9 | NC |

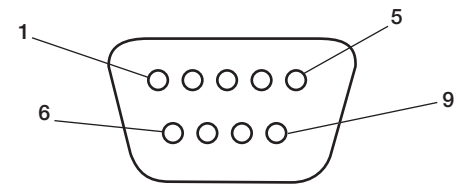

D-SUB 9P

2) Digital RGB Input (DVI-D) DVI

| | | | | | |
|---|------------------|----|------------------|----|------------------|
| 1 | TX2- | 9 | TX1- | 17 | TX0- |
| 2 | TX2+ | 10 | TX1+ | 18 | TX0+ |
| 3 | Shield (TX2/TX4) | 11 | Shield (TX1/TX3) | 19 | Shield (TXP/TX5) |
| 4 | NC | 12 | NC | 20 | NC |
| 5 | NC | 13 | NC | 21 | NC |
| 6 | DDC-Serial Clock | 14 | +5 power | 22 | Shield (TXC) |
| 7 | DDC-Serial Data | 15 | Ground (+5V) | 23 | TXC+ |
| 8 | NC | 16 | Hot Plug Detect | 24 | TXC- |

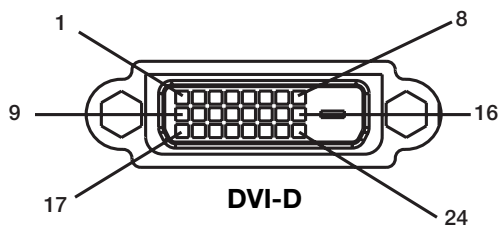

DVI-D

WEEE Mark (European Directive 2002/96/EC)

Within the European Union

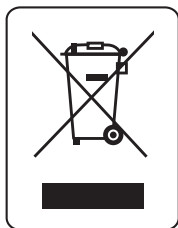

EU-wide legislation, as implemented in each Member State, requires that waste electrical and electronic products carrying the mark (left) must be disposed of separately from normal household waste. This includes monitors and electrical accessories, such as signal cables or power cords. When you need to dispose of your NEC display products, please follow the guidance of your local authority, or ask the shop where you purchased the product, or if applicable, follow any agreements made between yourself and NEC. The mark on electrical and electronic products only applies to the current European Union Member States.

The mark on electrical and electronic products only applies to the current European Union Member States.

Outside the European Union

If you wish to dispose of used electrical and electronic products outside the European Union, please contact your local authority so as to comply with the correct disposal method.

Declaration of the Manufacturer

We hereby certify that the color monitor
P426Y3, P506Y4 or P606Y5 is in compliance
with Council Directive 73/23/EEC:
— EN 60065

and marked with



Council Directive 89/336/EEC:
— EN 55022
— EN 61000-3-2
— EN 61000-3-3
— EN 55024

NEC Display Solutions Ltd.
4-13-23, Shibaura,
Minato-Ku
Tokyo 108-0023, Japan

DECLARATION OF CONFORMITY

This device complies with Part 15 of FCC Rules. Operation is subject to the following two conditions. (1) This device may not cause harmful interference, and (2) this device must accept any interference received, including interference that may cause undesired operation.

| | |
|--------------------------------|---|
| U.S. Responsible Party: | NEC Display Solutions of America, Inc. |
| Address: | 500 Park Blvd. Suite 1100 Itasca, IL 60143 |
| Tel. No.: | (630)467-3000 |

| | |
|---------------------------|--|
| Type of Product: | Computer Monitor |
| Equipment Classification: | Class B Peripheral |
| Model: | PlasmaSync 42XC10 (P426Y3) PlasmaSync 50XC10 (P506Y4) PlasmaSync 60XC10 (P606Y5) |



*We hereby declare that the equipment specified above
conforms to the technical standards as specified in the FCC Rules.*

HDMI, the HDMI logo and High-Definition Multimedia Interface are trademarks or registered trademarks of HDMI Licensing LLC.

Windows is a registered trademark of Microsoft Corporation. NEC is a registered trademark of NEC Corporation. All other brands and product names are trademarks or registered trademarks of their respective owners.

Free Manuals Download Website

<http://myh66.com>

<http://usermanuals.us>

<http://www.somanuals.com>

<http://www.4manuals.cc>

<http://www.manual-lib.com>

<http://www.404manual.com>

<http://www.luxmanual.com>

<http://aubethermostatmanual.com>

Golf course search by state

<http://golfingnear.com>

Email search by domain

<http://emailbydomain.com>

Auto manuals search

<http://auto.somanuals.com>

TV manuals search

<http://tv.somanuals.com>