

PlasmaSync Plasma Monitor

PlasmaSyncTM 50MP1

User's Manual



NEC

NEC Technologies

Important Information

Precautions

Please read this manual carefully before using your NEC plasma monitor and keep the manual handy for future reference.

CAUTION



**RISK OF ELECTRIC SHOCK
DO NOT OPEN**



CAUTION: TO REDUCE THE RISK OF ELECTRIC SHOCK, DO NOT REMOVE COVER. NO USER-SERVICEABLE PARTS INSIDE. REFER SERVICING TO QUALIFIED SERVICE PERSONNEL.



This symbol warns the user that uninsulated voltage within the unit may have sufficient magnitude to cause electric shock. Therefore, it is dangerous to make any kind of contact with any part inside of this unit.



This symbol alerts the user that important literature concerning the operation and maintenance of this unit has been included. Therefore, it should be read carefully in order to avoid any problems.

WARNING

TO PREVENT FIRE OR SHOCK HAZARDS, DO NOT EXPOSE THIS UNIT TO RAIN OR MOISTURE. ALSO DO NOT USE THIS UNIT'S POLARIZED PLUG WITH AN EXTENSION CORD RECEPTACLE OR OTHER OUTLETS, UNLESS THE PRONGS CAN BE FULLY INSERTED. REFRAIN FROM OPENING THE CABINET AS THERE ARE HIGH-VOLTAGE COMPONENTS INSIDE. REFER SERVICING TO QUALIFIED SERVICE PERSONNEL.

WARNING

This equipment has been tested and found to comply with the limits for a Class A digital device, pursuant to Part 15 of the FCC Rules. These limits are designed to provide reasonable protection against harmful interference when the equipment is operated in a commercial environment. This equipment generates, uses, and can radiate radio frequency energy and, if not installed and used in accordance with the instruction manual, may cause harmful interference to radio communications. Operation of this equipment in a residential area is likely to cause harmful interference in which case the user will be required to correct the interference at his own expense.

Warnings and Safety Precaution

The NEC plasma monitor is designed and manufactured to provide long, trouble-free service. No maintenance other than cleaning is required. Use a soft dry cloth to clean the panel. Never use solvents such as alcohol or thinner to clean the panel surface.

The plasma display panel consists of fine picture elements (cells). Although NEC produces the plasma display panels with more than 99.99 percent active cells, there may be some cells that do not produce light or remain lit.

For operating safety and to avoid damage to the unit, read carefully and observe the following instructions. To avoid shock and fire hazards:

1. Provide adequate space for ventilation to avoid internal heat build-up. Do not cover rear vents or install the unit in a closed cabinet or shelves.
The unit is equipped with cooling fans. If you install the unit in an enclosure, make sure there is adequate space at the top of the unit to allow hot air to rise and escape. If the monitor becomes too hot, the overheat protector will be activated and the monitor will be turned off. If this happens, turn off the power to the monitor and unplug the power cord. If the room where the monitor is installed is particularly hot, move the monitor to a cooler location, and wait for the monitor to cool for 60 minutes. If the problem persists, contact your NEC dealer for service.
2. Do not use the power cord polarized plug with extension cords or outlets unless the prongs can be completely inserted.
3. Do not expose the unit to water or moisture.
4. Avoid damage to the power cord, and do not attempt to modify the power cord.
5. Unplug the unit during electrical storms or if the unit will not be used over a long period.
6. Do not open the cabinet which has potentially dangerous high voltage components inside. If the unit is damaged in this way the warranty will be void. Moreover, there is a serious risk of electric shock.
7. Do not attempt to service or repair the unit. NEC is not liable for any bodily harm or damage caused if unqualified persons attempt service or open the back cover. Refer all service to authorized NEC Service Centers.

NOTE:

When you connect a computer to this monitor, attach the supplied ferrite cores. If you do not do this, this monitor will not conform to mandatory FCC standards.

Attaching the ferrite cores:

Set the ferrite cores on both ends of the DVI cable (not supplied), and one end of the power cable (supplied).

Close the lid tightly until the clamps click.

Use the band to secure the ferrite core (supplied).

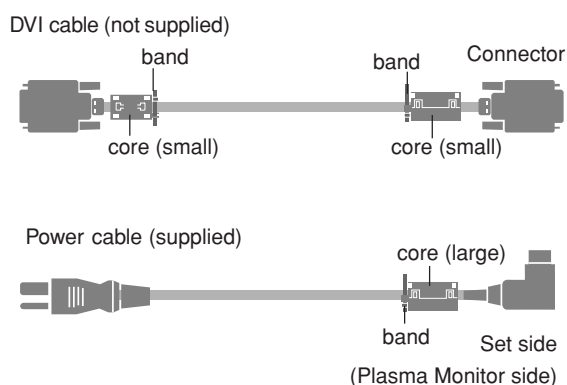

To avoid damage and prolong operating life:

1. Use only with 120V 50/60Hz AC power supply. Continued operation at line voltages greater than 120 Volts AC will shorten the life of the unit, and might even cause a fire hazard.
2. Handle the unit carefully when installing it and do not drop.
3. Set the unit away from heat, excessive dust, and direct sunlight.
4. Protect the inside of the unit from liquids and small metal objects. In case of accident, unplug the unit and have it serviced by an authorized NEC Service Center.
5. Do not hit or scratch the panel surface as this causes flaws on the surface of the screen.
6. For correct installation and mounting it is strongly recommended to use a trained, authorized NEC dealer.
7. As is the case with any phosphor-based display (like a CRT monitor, for example) light output will gradually decrease over the life of a Plasma Display Panel.

Recommendations to avoid or minimize phosphor burn-in

Like all phosphor-based display devices and all other gas plasma displays, plasma monitors can be susceptible to phosphor burn under certain circumstances. Certain operating conditions, such as the continuous display of a static image over a prolonged period of time, can result in phosphor burn if proper precautions are not taken. To protect your investment in this NEC plasma monitor, please adhere to the following guidelines and recommendations for minimizing the occurrence of image burn:

- * Always enable and use your computer's screen saver function during use with a computer input source.
- * Display a moving image whenever possible.
- * Change the position of the menu display from time to time.
- * Always power down the monitor when you are finished using it.

If the plasma monitor is in long term use or continuous operation take the following measures to reduce the likelihood of phosphor burn:

- * Lower the Brightness and Contrast levels as much as possible without impairing image readability.
- * Display an image with many colors and color gradations (i.e. photographic or photo-realistic images).
- * Create image content with minimal contrast between light and dark areas, for example white characters on black backgrounds. Use complementary or pastel color whenever possible.
- * Avoid displaying images with few colors and distinct, sharply defined borders between colors.

Contact NEC Technologies at 1-800-836-0655 for other recommended procedures that will best suit your particular application needs.

Précautions

Veillez lire ce manuel avec attention avant d'utiliser votre moniteur PlasmaSync NEC et conserver ce manuel à portée de la main pour une consultation ultérieure.

ATTENTION



**RISQUE D'ELECTROCUTION
NE PAS OUVRIR**



MISE EN GARDE: AFIN DE REDUIRE LES RISQUES D'ELECTROCUTION, NE PAS DEPOSER LE COUVERCLE, IL N'Y A AUCUNE PIECE UTILISABLE A L'INTERIEUR DE CET APPAREIL. NE CONFIER LES TRAVAUX D'ENTRETIEN QU'A UN PERSONNEL QUALIFIE.

Ce symbole a pour but de prévenir l'utilisateur de la présence d'une tension dangereuse, non isolée se trouvant à l'intérieur de l'appareil. Elle est d'une intensité suffisante pour constituer un risque d'électrocution. Eviter le contact avec les pièces à l'intérieur de cet appareil.

Ce symbole a pour but de prévenir l'utilisateur de la présence d'importantes instructions concernant l'entretien et le fonctionnement de cet appareil. Par conséquent, elles doivent être lues attentivement afin d'éviter des problèmes.

AVERTISSEMENT

AFIN DE REDUIRE LES RISQUES D'INCENDIE OU D'ELECTROCUTION, NE PAS EXPOSER CET APPAREIL A LA PLUIE OU A L'HUMIDITE. AUSSI, NE PAS UTILISER LA FICHE POLARISEE AVEC UN PROLONGATEUR OU UNE AUTRE PRISE DE COURANT SAUF SI CES LAMES PEUVENT ETRE INSEREES A FOND. NE PAS OUVRIR LE COFFRET, DES COMPOSANTS HAUTE TENSION SE TROUVENT A L'INTERIEUR. LAISSER A UN PERSONNEL QUALIFIE LE SOIN DE REPARER CET APPAREIL.

DOC avis de conformation

Cet appareil numérique de la classe A respecte toutes les exigences du Règlement sur le Matériel Brouilleur du Canada.

Mises en garde et précautions de sécurité

Le moniteur PlasmaSync NEC a été conçu et fabriqué pour une utilisation fiable et durable. Il ne nécessite aucun entretien en dehors du nettoyage. Utiliser un chiffon doux et sec pour nettoyer la surface de l'écran. Ne jamais utiliser de solvant comme l'alcool ou le diluant. Le panneau à affichage plasma est constitué de fines particules d'images ou pixels (cellules). Bien que NEC produise des panneaux à affichage plasma avec plus de 99,99 % de cellules actives, il peut y avoir des cellules qui ne produisent pas de lumière ou qui restent allumées.

Pour des raisons de sécurité et pour éviter d'endommager l'appareil, lire attentivement les instructions suivantes.

Pour éviter les risques d'électrocution et d'incendie:

1. Laisser suffisamment d'espace autour de l'appareil pour la ventilation et éviter toute augmentation excessive de la température interne. Ne pas couvrir les événements ou l'installer dans un endroit trop exigü. L'appareil est équipé de ventilateurs de refroidissement. Si vous installez l'appareil dans un espace clos, assurez-vous qu'il y ait suffisamment d'espace au dessus pour permettre à l'air chaud de s'élever et de s'évacuer. Si la température du moniteur devient excessive, la protection contre les surchauffes entrera en action et coupera l'alimentation. Dans ce cas, éteindre l'appareil et débrancher le câble d'alimentation. Si la température de la pièce dans laquelle le moniteur est installé est particulièrement excessive, déplacer l'appareil dans un endroit plus frais et le laisser refroidir 60 minutes. Si le problème persiste, prendre contact avec le revendeur NEC pour le service après-vente.
2. Ne pas utiliser la fiche polarisée du cordon d'alimentation avec des prolongateurs ou des prises de courant, sauf si les lames peuvent être insérées à fond.
3. Ne pas exposer à l'eau ou à l'humidité.
4. Eviter d'endommager le cordon d'alimentation, et ne pas modifier le cordon d'alimentation.
5. Débrancher l'appareil pendant les tempêtes ou si l'appareil n'est pas utilisé pendant une longue période.
6. Ne pas ouvrir le coffret. Des composants de haute tension se trouvent à l'intérieur. Si l'appareil est endommagé de cette manière, la garantie devient caduque. De plus, il y a risque d'électrocution.
7. Ne pas essayer de réparer ou entretenir l'appareil soi-même. NEC ne saura être tenu pour responsable pour toute blessure ou dommage causé par des personnes non qualifiées qui essaient de réparer ou d'ouvrir le couvercle arrière. Confier toute réparation à un centre de service agréé NEC.

REMARQUE:

Lorsque vous branchez un micro-ordinateur sur ce moniteur, fixez les noyaux en ferrites fournis. Si vous ne le faites, le moniteur ne sera pas en conformité avec les exigences des standards FCC.

Fixation des noyaux en ferrite.

Installez les noyaux en ferrite sur chaque bout du câble DVI (non fourni), ainsi que sur un côté du câble d'alimentation électrique (fourni).

Fermez doucement le couvercle jusqu'à ce que les crans se clipent.

Utiliser les colliers pour fixer la tore en ferrite (fourni)

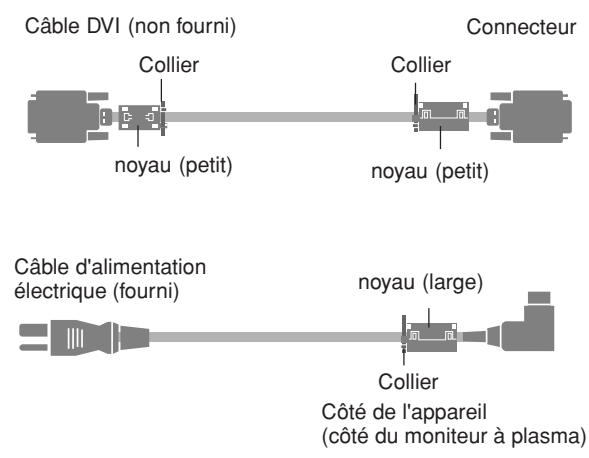

Pour éviter des dommages et prolonger la durée de service de l'appareil:

1. N'utiliser qu'une source d'alimentation de 120 V 50/60 Hz CA. Le fait d'utiliser l'appareil en continu à des tensions de ligne supérieures à 120 Volts CA réduit sa durée de vie et risque de provoquer un incendie.
2. Manipuler l'appareil avec soin pendant son déplacement et ne pas le faire tomber.
3. Eloigner l'appareil des endroits chauds, très poussiéreux et exposés en plein soleil.
4. Éviter que des liquides et des petits objets métalliques pénètrent à l'intérieur de l'appareil. En cas d'accident, débrancher l'appareil et le confier à un centre de service agréé NEC.
5. Ne pas frapper ou rayer la surface de la écran plasma, car des défauts risquent de se produire sur la surface de la écran plasma.
6. Pour effectuer une installation et un montage corrects, il est recommandé de faire appel au concessionnaire NEC autorisé et spécialisé.
7. Comme c'est le cas pour tout affichage à base de phosphore (comme un moniteur CRT, par exemple), la puissance de lumière baisse graduellement au cours de la vie du Panneau d'Affichage à Plasma.

Pour éviter le risque de combustion au phosphore, les mesures suivantes sont recommandées :

Comme tous les appareils d'affichage à base de phosphore et tous les autres affichages à gaz plasma, les moniteurs Plasmasync peuvent être sujets à la combustion au phosphore dans certaines circonstances. Certaines conditions d'utilisation, telles que l'affichage continu d'une image statique pour une durée prolongée, peuvent causer des brûlures au phosphore si aucune précaution n'est prise. Pour protéger votre investissement dans ce moniteur PlasmaSync NEC, veuillez suivre les directives et les recommandations suivantes pour minimiser l'occurrence de brûlure d'image :

- Assurez-vous de mettre en marche et d'utiliser l'économisateur d'écran chaque fois que c'est possible lorsque vous l'utilisez avec une source d'entrée d'ordinateur.
- Affichez une image en mouvement aussi souvent que possible.
- Changez la position de l'affichage de menu de temps à autre.
- Coupez toujours l'alimentation lorsque vous avez terminé d'utiliser le moniteur.

Si le moniteur est en usage continu ou longue durée, prenez les mesures suivantes afin d'éviter l'occurrence de combustion au phosphore :

- Abaissez le niveau de l'image (contraste, luminosité) autant que possible, sans faire perdre la lisibilité de l'image.
- Affichez une image avec de nombreuses couleurs et graduations de couleur (par ex. des images photographiques ou photo-réalistes).
- Créez un contenu d'image avec un contraste minimal entre les zones sombres et les zones claires, par exemple, des caractères blancs sur un fond noir. Utilisez des couleurs complémentaires ou pastels le plus souvent possible.
- Évitez d'afficher des images avec peu de couleurs et des limites nettes et clairement définies entre les couleurs.

Contactez NEC Technologies au 1-800-836-0655 pour d'autres procédures recommandées qui conviendront le mieux au besoin de votre appareil.

Limited Warranty Plasma Monitors

NEC Technologies, Inc. (hereinafter NECTECH) warrants this product to be free from defects in material and workmanship under the following terms and, subject to the conditions set forth below, agrees to repair or replace (at NECTECH's sole option) any part of the enclosed unit which proves defective. Replacement parts or products may be new or refurbished and will meet specifications of the original parts or products.

HOW LONG IS THE WARRANTY?

Parts and labor are warranted for (1) one year from the date of the first customer purchase.

WHO IS PROTECTED?

This warranty may be enforced only by the first purchaser.

WHAT IS COVERED AND WHAT IS NOT COVERED

Except as specified below, this warranty covers all defects in material or workmanship in this product. The following are not covered by the warranty:

1. Any product which is not distributed in the U.S.A., Canada or Mexico by NECTECH or which is not purchased in the U.S.A., Canada or Mexico from an authorized NECTECH dealer.
2. Any product of which the serial number has been defaced, modified or removed.
3. Damage, deterioration or malfunction resulting from:
 - a. Accident, misuse, abuse, neglect, fire, water, lightning or other acts of nature, unauthorized product modification, or failure to follow instructions supplied with the product.
 - b. Repair or attempted repair by anyone not authorized by NECTECH.
 - c. Any shipment of the product (claims must be presented to the carrier).
 - d. Removal or installation of the product.
 - e. Any other cause which does not relate to a product defect.
 - f. Burns or residual images upon the phosphor of the panel.
4. Cartons, carrying cases, batteries, external cabinets, magnetic tapes, or any accessories used in connection with the product.
5. Service outside of the U.S.A. and Canada.

WHAT WE WILL PAY FOR AND WHAT WE WILL NOT PAY FOR

We will pay labor and material expenses for covered items, but we will not pay for the following:

1. Removal or installation charges.
2. Costs of initial technical adjustments (set-up), including adjustment of user controls. These costs are the responsibility of the NECTECH dealer from whom the product was purchased.
3. Shipping charges.

HOW YOU CAN GET WARRANTY SERVICE

1. To obtain service on your product, consult the dealer from whom you purchased the product.
2. Whenever warranty service is required, the original dated invoice (or a copy) must be presented as proof of warranty coverage. Please also include in any mailing your name, address and a description of the problem(s).
3. For the name of the nearest NECTECH authorized service center, call NECTECH at 800-836-0655.

LIMITATIONS OF LIABILITY

Except for the obligations specifically set forth in this warranty statement, we will not be liable for any direct, indirect, special, incidental, consequential, or other types of damages, whether based on contract, tort, or any other legal theory, whether or not we have been advised of the possibility of such damages. This warranty is in lieu of all other warranties expressed or implied, including, but not limited to, the implied warranties of merchantability or fitness for a particular purpose.

EXCLUSION OF DAMAGES

NECTECH's liability for any defective product is limited to the repair or replacement of the product at our option. NECTECH shall not be liable for:

1. Damage to other property caused by any defects in this product, damages based upon inconvenience, loss of use of the product, loss of time, commercial loss; or
2. Any other damages whether incidental, consequential or otherwise. Some states do not allow limitation on how long an implied warranty lasts and/or do not allow the exclusion or limitation of incidental or consequential damages, so the above limitations and exclusions may not apply to you.

HOW STATE LAW RELATES TO THE WARRANTY

This warranty gives you specific legal rights, and you may also have other rights which vary from state to state.

FOR MORE INFORMATION,
TELEPHONE 800-836-0655
NEC TECHNOLOGIES, INC.
1250 N. Arlington Heights Road, Suite 500
Itasca, Illinois 60143-1248

Note: All products returned to NECTECH for service MUST have prior approval. To get approval, call NEC Technologies at 800-836-0655.

Contents

How to Attach Options to the Plasma Monitor 1	OSM Controls 17
Introduction 2	Menu Operations 17
Introduction to the PlasmaSync 50MP1	Picture Settings Menu 19
Plasma Monitor 2	Adjusting the picture 19
The features you'll enjoy include: 2	Setting the picture mode according to the
Contents of the Package 2	brightness of the room 20
Options 2	Setting the color temperature 21
Part Names and Function 3	Adjusting the color to the desired quality 22
Front View 3	Reducing noise in the picture 23
Rear View / Terminal Board 4	Sound Settings Menu 24
Remote Control Unit 5	Adjusting the treble, bass and left/right balance 24
Battery Installation and Replacement 6	Screen Settings Menu 25
Using the wired remote control mode 7	Adjusting the Position, Size, Fine Picture,
Operating Range 7	Picture Adj 25
Handling the remote control unit 7	Function Settings Menu 26
Installation 8	Setting the on-screen display 26
Connecting Your PC or Macintosh Computer 9	Adjusting the position of the menu display 27
Connections with Equipment that has a Digital Interface ... 9	Setting the power management for computer images . 28
Connecting Your Document Camera 9	POWER/STANDBY indicator 29
Connecting Your VCR or Laser Disc Player 9	Setting the gray level for the sides of the screen 30
Connecting Your DVD Player 9	Setting the picture to suit the movie 30
External Speaker Connections 10	Setting RGB3 ADJ 31
Pin Assignments and Signal Levels	Reducing burn-in of the screen 31
for 15 pin RGB (Analog) 11	Resetting to the default values 32
Pin Configuration and Signal	Option Settings Menu 33
of the RGB 3 IN Connector (DVI Connector) 11	Setting the allocation of the audio connectors 33
Basic Operations 12	Setting the BNC connectors 33
POWER 12	Setting a computer image to the correct RGB
To turn the unit ON and OFF: 12	select screen 34
VOLUME 12	Setting high definition images to the suitable
To adjust the volume: 12	screen size 35
MUTE 12	Setting the picture size for RGB input signals 36
To cancel the sound: 12	Information Menu 36
DISPLAY 12	Checking the frequencies, polarities of input signals,
To check the settings: 12	and resolution 36
DIGITAL ZOOM 12	Setting the language for the menus 37
AUTO ADJUST 12	Setting the video signal format 37
To adjust the size or quality of the picture	External Control 39
automatically: 12	Table of Signals Supported 47
OFF TIMER 13	Supported resolution 47
To set the off timer: 13	Troubleshooting 49
To check the remaining time: 13	Specifications 50
To cancel the off timer 13	
WIDE Operations 14	
Watching with a wide screen (manual) 14	
When watching videos or digital video discs 14	
When watching high definition video source 14	
Watching computer images with a wide screen 15	
When "PICTURE SIZE" is set to "OFF" 15	
MULTI SCREEN Operations 16	
Showing a couple of pictures on the screen	
at the same time 16	
Selecting the input signals to be displayed 16	
Adjusting the OSM controls 16	

How to Attach Options to the Plasma Monitor

You can attach your optional mounts or stand to the plasma monitor in one of the following two ways:

- * While it is upright. (See Drawing A)
- * As it is laid down with the screen face down (See Drawing B). Lay the protective sheet, which was wrapped around the monitor when it was packaged, beneath the screen surface so as not to scratch the screen face.

- **This device cannot be installed on its own. Be sure to use a stand or original mounting unit. (Wall mount unit, Stand, etc.)**
 - * See page 2.
 - **For correct installation and mounting it is strongly recommended to use a trained, authorized NEC dealer.**
- Failure to follow correct mounting procedures could result in damage to the equipment or injury to the installer.**
- Product warranty does not cover damage caused by improper installation.**

Drawing A

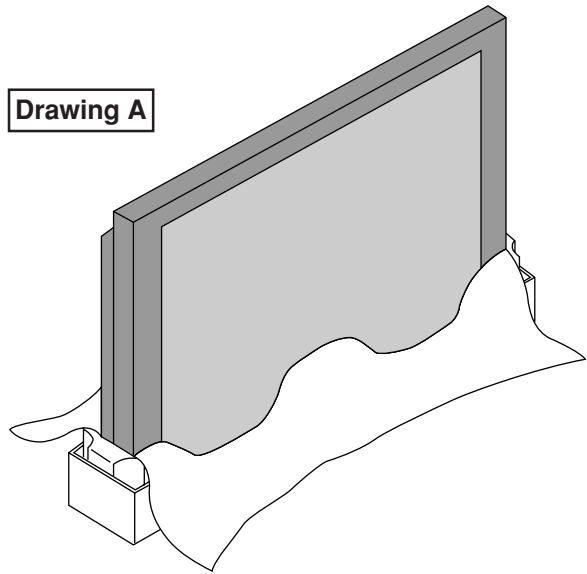

Drawing B

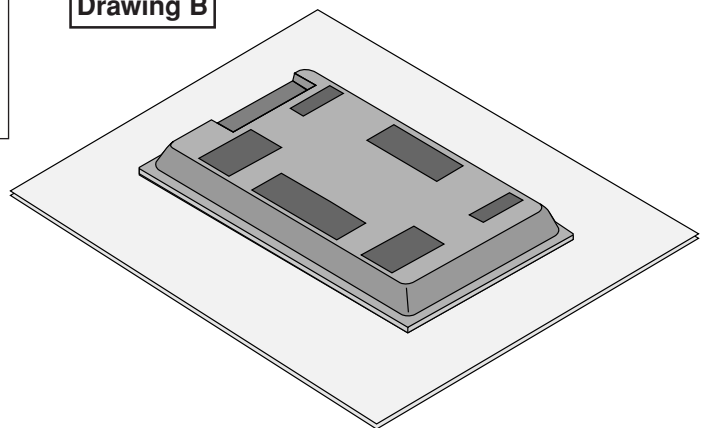

Ventilation Requirements for enclosure mounting

To allow heat to disperse, leave space between surrounding objects as shown on the diagram below when installing.

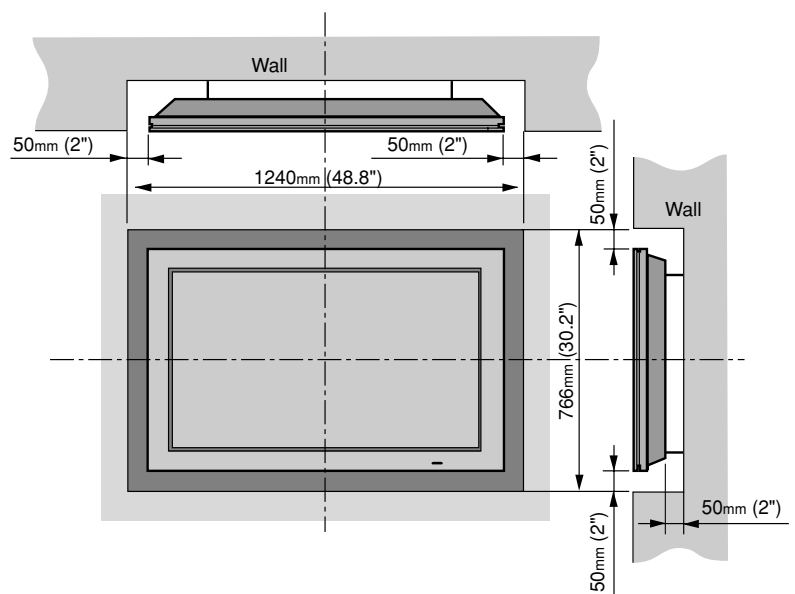

Introduction

Introduction to the PlasmaSync 50MP1 Plasma Monitor

NEC's PlasmaSync™ is a seamless blend of cutting-edge visual technology and sophisticated design. At 50-inches, with a 16:9 aspect ratio, the PlasmaSync 50MP1 certainly makes a big impression. However, at a mere 4.2 inches/ 107 mm thin, the monitor's sleek techno-art lines blend in well with your environment. PlasmaSync's crisp, vivid image quality will transform data from any graphic medium from PCs to DVD players- into art. And weighing only 101.3 lbs/ 46 kg, it actually can be hung almost anywhere. NEC has made sure that a host of multimedia resources can be easily connected and displayed as brilliantly as intended on the PlasmaSync™ monitor.

The features you'll enjoy include:

- 50-inch screen
- 16:9 aspect ratio
- Capsulated Color Filter (CCF) and black matrix
- 4.2 inch / 107 mm thin
- 101.3 lbs/ 46 kg light
- High-resolution screen: 1365 × 768 pixels
- 160-degrees of off-axis viewing, horizontally and vertically.
- Flicker - and warp - free display provides excellent image geometry even in screen corners
- Not affected by magnetic fields, no color drift or edge distortion.
- VGA, SVGA, XGA, SXGA, computer signal compatibility
- NTSC, PAL, SECAM, composite and S-Video signal compatibility
- 480P, 1080I, 720P and HDTV signal compatibility
- PCs, VCRs, Laser Disc and DVD player source compatibility
- AccuBlend™ scan conversion automatically converts VGA, SVGA and SXGA signals to the panel's native resolution
- RGB input (3*), Video input (3), DVD/HD input (2*), Audio input (3), External Control input (1)
- AccuColor control system provides user selectable on-screen color temperature settings
- New Drive Technology
- Component video input terminal for DVD, 15.75kHz (Y, CB, CR)
- Digital broadcasting source compatibly
- NEC's OSM™ menu-driven on screen control system that makes image adjustments a snap
- Seven languages (English, German, French, Italian, Spanish, Swedish, and Japanese)

* You can select RGB source or Component source for the 5BNC terminal. When selecting an RGB input, the source is switched to the RGB input (3); when selecting a component input, the source is switched to the DVD/ HD input (2).

Contents of the Package

- PlasmaSync™ 50MP1 plasma monitor
- Power cord
- RGB cable (Mini D-Sub 15-pin to Mini D-Sub 15-pin connector)
- Adapter for Macintosh
- Remote control unit with two AAA Batteries
- User's manual
- Remote cable
- Safety metal fittings*
- Screws for safety metal fitting*
- Ferrite core (small × 2, large × 1), band

* These are fittings for fastening the unit to a wall to prevent tipping due to external shock when using the stand (option). Fasten the safety fittings to the holes in the back of the monitor using the safety fitting mount screws.

Options

- Wall mount unit
- Ceiling mount unit
- Tilt mount unit
- Tabletop stand
- Speakers
- Others

Part Names and Function

Front View

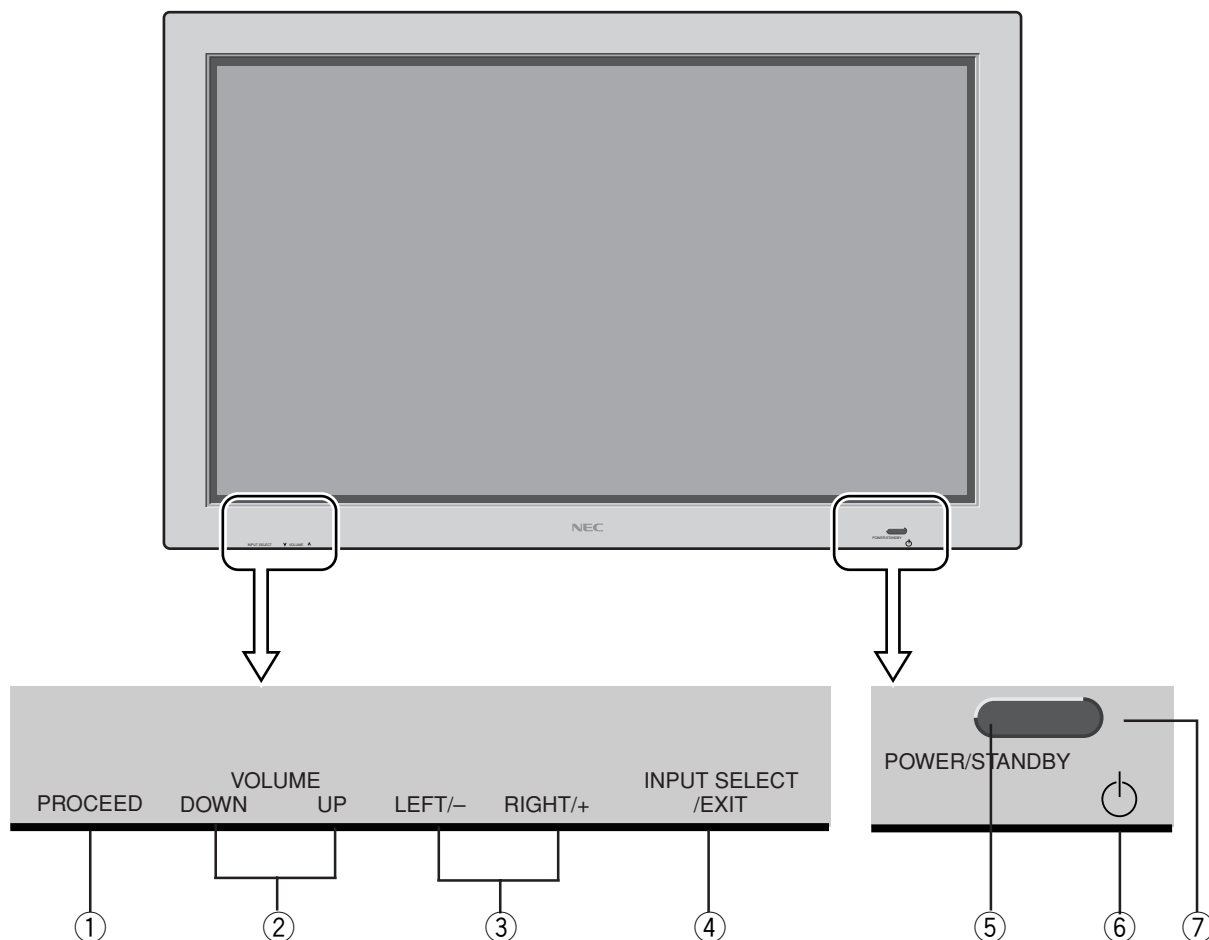

- ① **PROCEED**
Sets the On-Screen Menu (OSM) mode and displays the main menu.
- ② **VOLUME DOWN and UP**
Adjusts the volume. Functions as the CURSOR (▲/▼) buttons in the On-Screen Menu (OSM) mode.
- ③ **LEFT/- and RIGHT/+**
Enlarges or reduces the image. Functions as the CURSOR (◀/▶) buttons in the On-Screen Menu (OSM) mode.
- ④ **INPUT SELECT / EXIT**
Switches the input, in the following order:

→ VIDEO1 → VIDEO2 → VIDEO3 → DVD/HD
 RGB/PC3 ← RGB/PC2 ← RGB/PC1 ←

 Functions as the EXIT buttons in the On-Screen Menu (OSM) mode.
- ⑤ **POWER/STANDBY indicator**
When the power is on Lights green.
When the power is in the standby mode ... Lights red.
- ⑥ **Power**
Turns the monitor's power on and off.
- ⑦ **Remote sensor window**
Receives the signals from the remote control unit.

Rear View/ Terminal Board

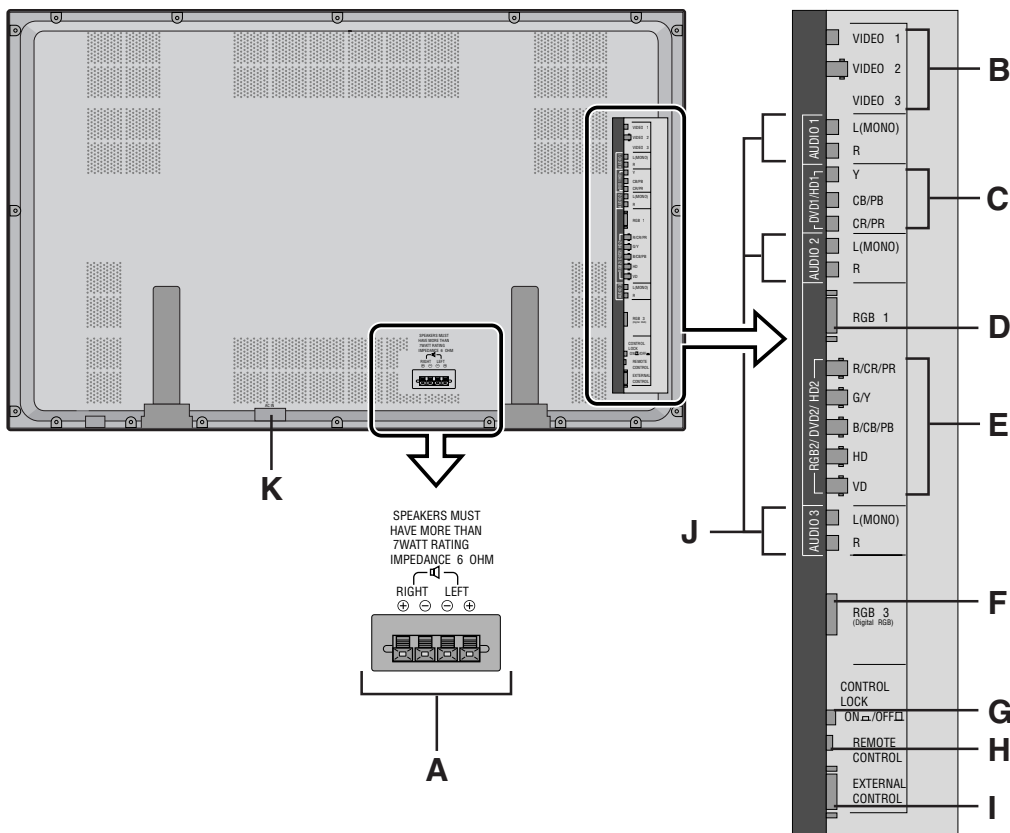

A EXT SPEAKER L and R

Connect speakers here.

B VIDEO1, 2, 3

Connect VCR's, DVD's or Laser Discs, etc. here.

C DVD1 / HD1

Connect DVD's, High Definition or Laser Discs, etc. here.

D RGB1

Inputs the analog RGB signal of personal computer, etc.

E RGB2/ DVD2/ HD2

RGB2: Inputs the analog RGB signal.
DVD2/ HD2: Connect DVD's, High Definition or Laser Discs, etc. here.

F RGB3 (DVI 29pin)

Inputs a digital RGB signal (TMDS).

G CONTROL LOCK

When "CONTROL LOCK" is set "ON", the buttons on the set's control panel do not function.

H REMOTE CONTROL

Connect the supplied remote cable here.

I EXTERNAL CONTROL

This terminal is used when power ON/OFF, input selection and AUDIO MUTE and other controls are operated externally (by external control). See also page 39 for external control.

J AUDIO1, AUDIO2, AUDIO3

These are audio input terminals.
The input is selectable. Set which video image to allot them to on the menu screen.

K AC IN

Connect the included power cord here.

Remote Control Unit

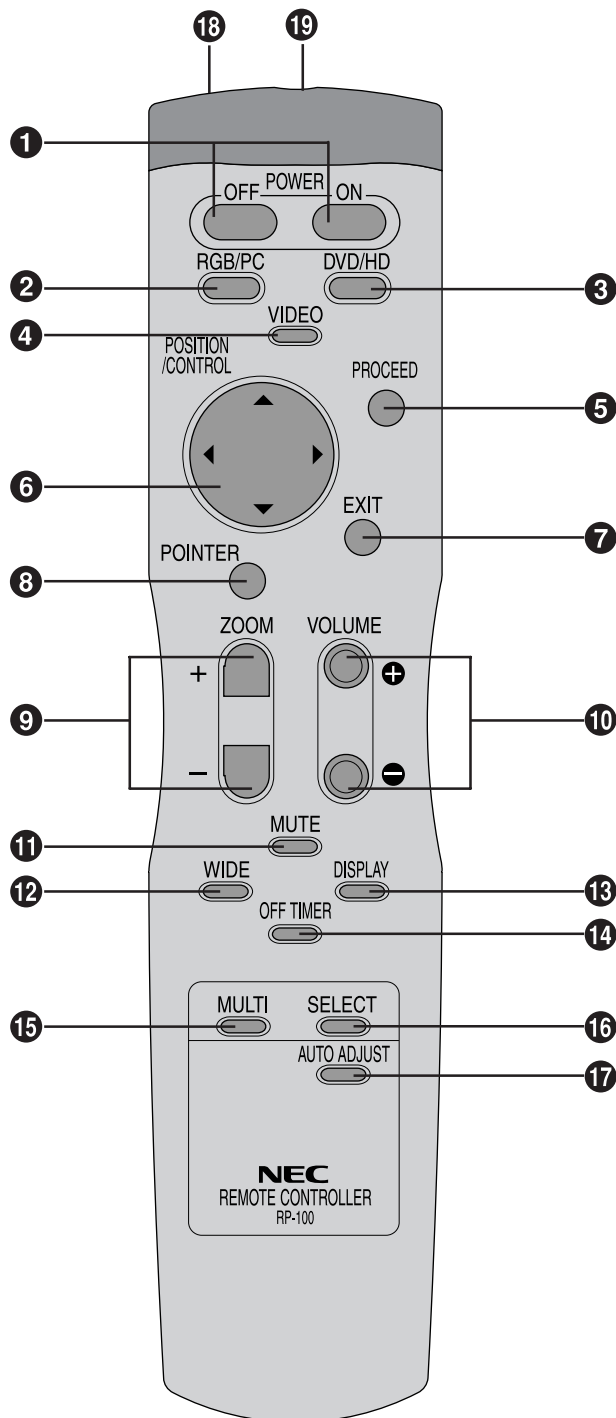

1 POWER ON/OFF

Switches Power ON/OFF.
(This does not operate when POWER/STANDBY indicator of the main unit is off.)

2 RGB/PC

Press this button to select RGB/PC as the source.

→ RGB/PC1 → RGB/PC2 → RGB/PC3 ←

RGB/PC can also be selected using the INPUT SELECT button on the monitor. The input switches as follows each time the button is pressed:

→ VIDEO1 → VIDEO2 → VIDEO3 → DVD/HD ←
← RGB/PC3 ← RGB/PC2 ← RGB/PC1 ←

3 DVD / HD

Press this button to select DVD/HD as the source.
DVD/HD can also be selected using the INPUT SELECT button on the monitor. The input switches as follows each time the button is pressed:

→ VIDEO1 → VIDEO2 → VIDEO3 → DVD/HD ←
← RGB/PC3 ← RGB/PC2 ← RGB/PC1 ←

4 VIDEO

Press this button to select VIDEO as the source.

→ VIDEO1 → VIDEO2 → VIDEO3 ←

VIDEO can also be selected using the INPUT SELECT button on the monitor. The input switches as follows each time the button is pressed:

→ VIDEO1 → VIDEO2 → VIDEO3 → DVD/HD ←
← RGB/PC3 ← RGB/PC2 ← RGB/PC1 ←

5 PROCEED

Press this button to access the OSM controls.
Press this button during the display of the main menu to go to the sub menu.

6 CURSOR (▲ / ▼ / ◀ / ▶)

Use these buttons to select items or settings and to adjust settings or switch the display patterns.

7 EXIT

Press this button to exit the OSM controls in the main menu. Press this button during the display of the sub menu to return to the main menu.

8 POINTER

Press this button to display the pointer.

9 ZOOM (+ /-)

Enlarges or reduces the image.

10 VOLUME (+ /-)

Adjusts the volume.

11 MUTE

Mutes the sound.

12 WIDE

The type of broadcast is detected automatically, and the recommended wide screen is set.

13 DISPLAY

Displays the source settings on the screen.

14 OFF TIMER

Activates the off timer for the unit.

15 MULTI

Press this button to select a screen mode from among single mode, side by side, and picture in picture.

16 SELECT

Press this button to select the active picture in a multi screen mode.

17 AUTO ADJUST

Press this button to adjust Fine Picture, Picture ADJ, Position, and Contrast automatically, or to switch the screen size to ZOOM mode automatically with the superimposed caption displayed fully only when the picture contains dark areas above and below the picture.

18 Remote control signal transmitter

Transmits the remote control signals.

19 Remote Jack

Insert the plug of the supplied remote cable here when using the supplied remote control unit in the wired condition.

Battery Installation and Replacement

Insert the 2 “AAA” batteries, making sure to set them in with the proper polarity.

1. Press and open the cover.

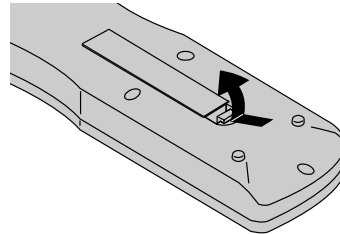

2. Align the batteries according to the (+) and (-) indication inside the case.

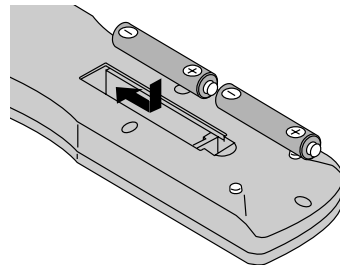

3. Replace the cover.

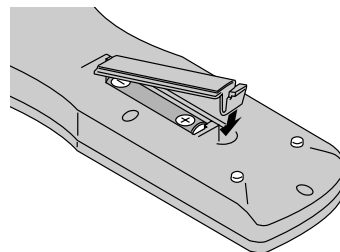

Using the wired remote control mode

Connect the supplied remote cable to the remote control unit's remote jack and the "REMOTE CONTROL" terminal on the monitor.

When the cable is connected, the mode automatically switches to wired remote control. When the wired remote control mode is used, the remote control unit can be operated even if no batteries are loaded.

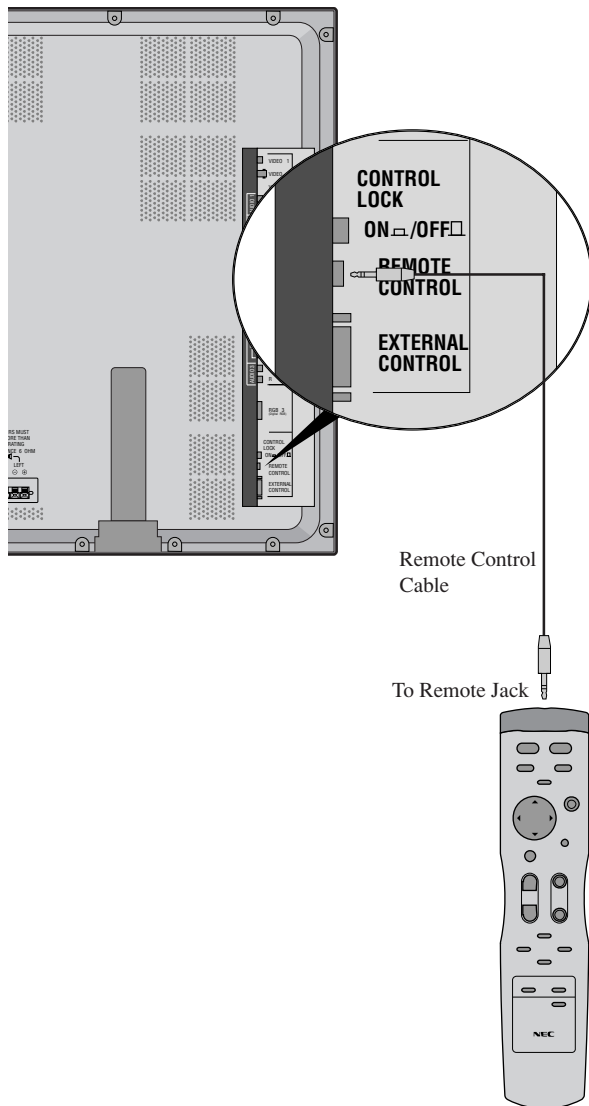

Operating Range

- * Use the remote control unit within a distance of about 7 m/ 23ft. from the front of the monitor's remote control sensor and at a horizontal angle of within 30°.
- * The remote control operation may not function if the monitor's remote control sensor is exposed to direct sunlight or strong artificial light, or if there is an obstacle between the sensor and the remote control unit.

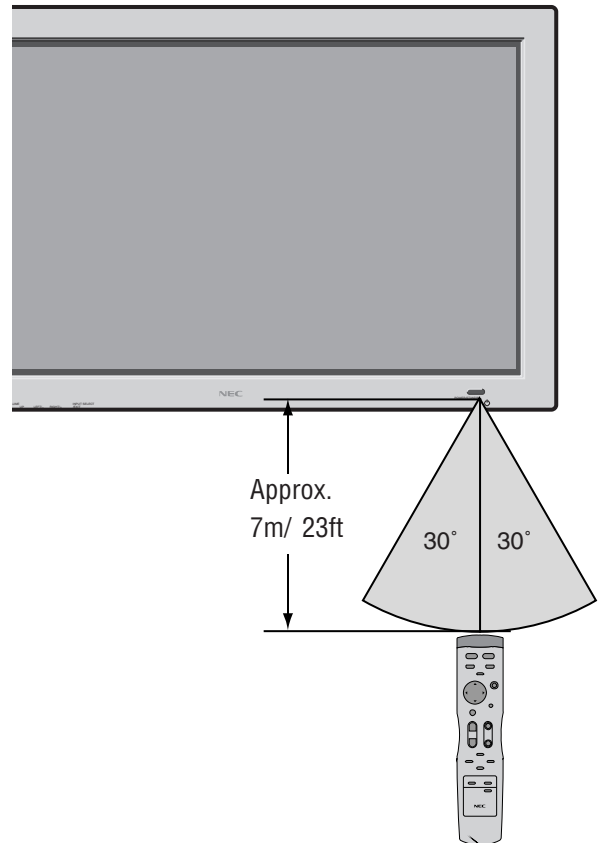

Handling the remote control unit

- Do not drop or mishandle the remote control unit.
- Do not get the remote control unit wet. If the remote control unit gets wet, wipe it dry immediately.
- Avoid heat and humidity.
- When not using the remote control unit for a long period, remove the batteries.
- Do not use new and old batteries together, or use different types together.
- Do not take apart the batteries, heat them, or throw them into a fire.
- When using the remote control unit in the wireless condition, be sure to unplug the remote cable from the REMOTE CONTROL terminal on the monitor.

Installation

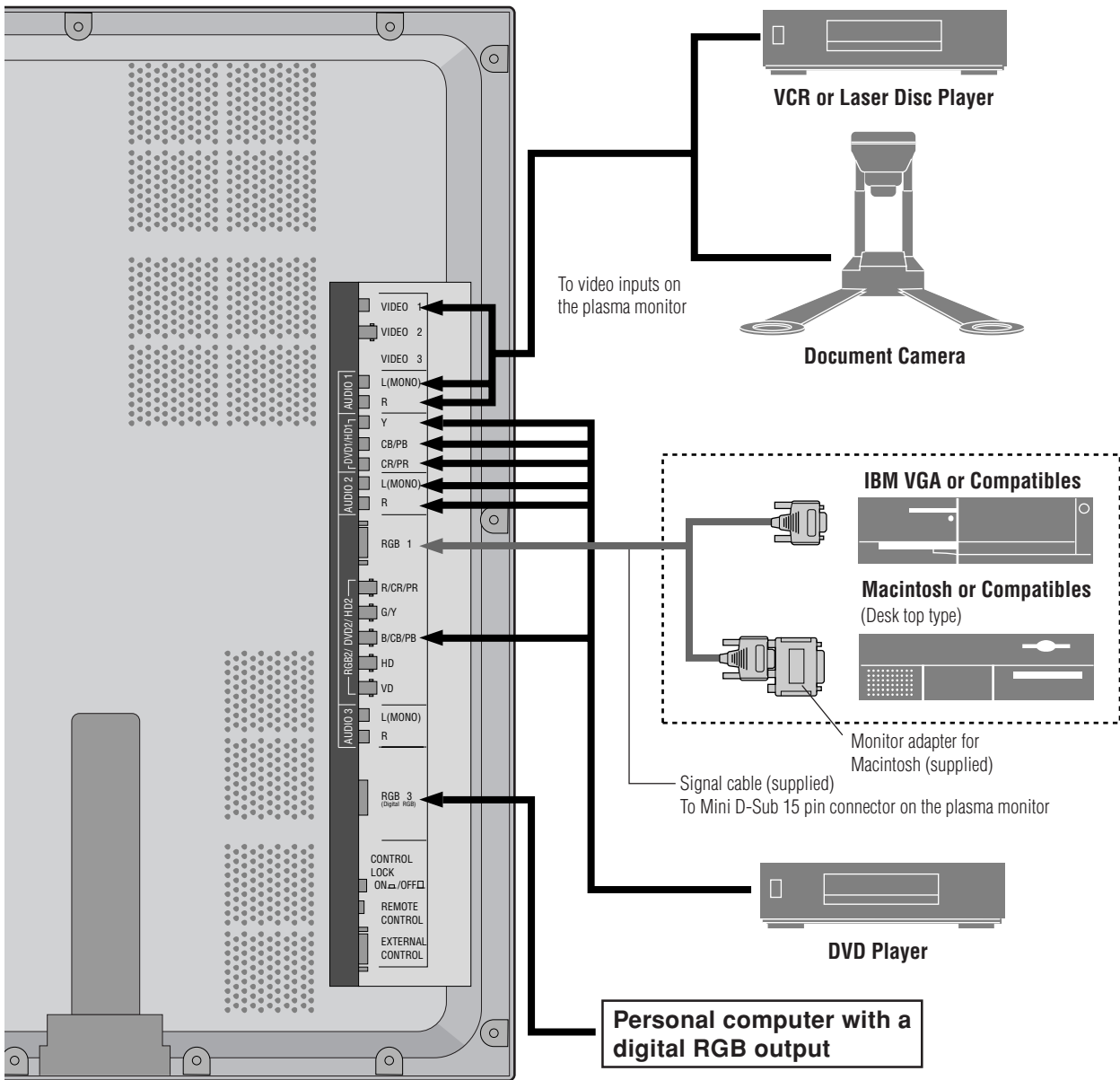

Connecting Your PC or Macintosh Computer

Connecting your PC or Macintosh computer to your plasma monitor will enable you to display your computer's screen image for an impressive presentation. The plasma monitor supports the signals described on page 47.

To connect a PC, Macintosh or compatible graphics adapter, simply:

1. Turn off the power to your plasma monitor and computer.
2. If your PC does not support XGA/SVGA/VGA you will need to install an XGA/SVGA/VGA graphics board. Consult your computer's owner's manual for your XGA/SVGA/VGA configuration. If you need to install a new board, see the manual that comes with your new graphics board for installation instructions.
3. The plasma monitor provides signal compatibility up to VESA 1600 × 1200 (UXGA). However, it is not recommended to use this resolution due to image readability on the monitors 1365 × 768 native pixel resolution panel.
4. Use the signal cable that's supplied to connect your PC or Macintosh computer to the plasma monitor. For Macintosh, use the supplied monitor adapter to connect to your computer's video port.
5. Turn on the plasma monitor and the computer.
6. If the plasma monitor goes blank after a period of inactivity, it may be caused by a screen saver installed on the computer you've connected to the plasma monitor.

When using a Macintosh with the plasma monitor, the following four display standards are supported using the included Macintosh adapter :

- 13" fixed mode
- 16" fixed mode
- 19" fixed mode
- 21" fixed mode

The 19" fixed mode is recommended for the plasma monitor.

Connections with Equipment that has a Digital Interface

Connections can be made with equipment that is equipped with a digital interface compliant with the DVI (Digital Visual Interface) standard.

* Use a DVI 29-pin signal cable and the ferrite cores (supplied) when making connections to the RGB3 IN (DVI) connector of the main unit.

Note that the RGB3 IN(DVI) terminal does not support analog RGB input source.

Note:

1. Input TMDS signals conforming to DVI standards. The TMDS input corresponds to 1 link.
2. To maintain display quality, use a cable with a quality prescribed by DVI standards that is within 5 meters in length.

Connecting Your Document Camera

You can connect your plasma monitor to a document camera. To do so, simply:

1. Turn off the power to your plasma monitor and document camera.
2. Use a standard video cable to connect your document camera to the Video input on your plasma monitor.
3. Turn on the plasma monitor and the document camera.

Note: Refer to your document camera owner's manual for more information about your camera's video output requirements.

Connecting Your VCR or Laser Disc Player

Use common RCA cables (not provided) to connect your VCR or laser disc player to your plasma monitor. To make these connections, simply:

1. Turn off the power to your plasma monitor and VCR or laser disc player.
2. Connect one end of your RCA cable to the video output connector on the back of your VCR or laser disc player, connect the other end to the Video input on your plasma monitor. Use standard RCA audio patch cords to connect the audio from your VCR or laser disc player to your plasma monitor (if your VCR or laser disc player has this capability). Be careful to keep your right and left channel connections correct for stereo sound.
3. Turn on the plasma monitor and the VCR or laser disc player.

Note: Refer to your VCR or laser disc player owner's manual for more information about your equipment's video output requirements.

Connecting Your DVD Player

You can connect your plasma monitor to a DVD player. To do so, simply:

1. Turn off the power to your plasma monitor and DVD player.
2. Use a standard video cable to connect your DVD player to the Y, Cb, and Cr inputs on your plasma monitor. Or use the DVD-player's S-Video output. Use a standard S-Video cable to connect to the S-Video input on the plasma monitor.
3. Turn on the plasma monitor and the DVD player.

External Speaker Connections

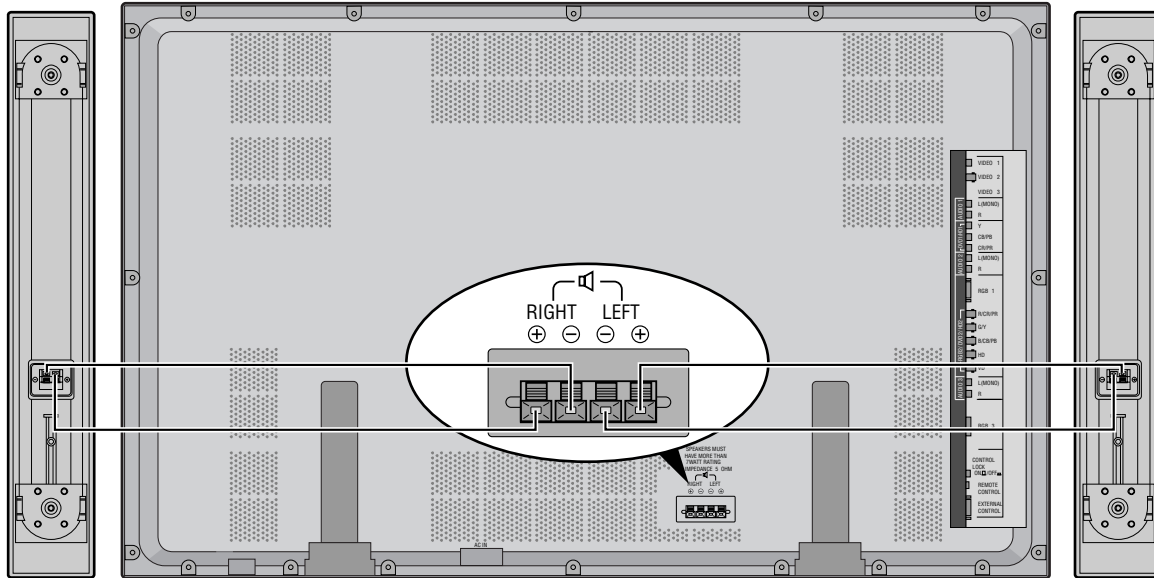

External speakers may be connected to the plasma monitor to reproduce sound from VIDEO, DVD or RGB signal sources.

External speakers may be connected directly to the SPEAKERS terminals or indirectly by connecting a stereo system amplifier to the audio outputs.

CAUTION: *Unplug the plasma monitor and all connected components before connecting external speakers. Use only speakers with 6-ohm impedance and a power input rating of 7 watts or more.*

To connect external speakers directly to the plasma monitor:

1. Strip the ends of the speaker wires.
2. Press down the tabs below the SPEAKERS terminals, insert the speaker wire and release the tab to secure the speaker wire connection:
 - [a] Connect the right speaker (located at right side of the monitor when viewed from the front) positive (+) wire to RIGHT +.
 - [b] Connect the right speaker negative (-) wire to RIGHT -.
 - [c] Connect the left speaker negative (-) wire to LEFT-.
 - [d] Connect the left speaker positive (+) wire to LEFT+.

Pin Assignments and Signal Levels for 15 pin RGB (Analog)

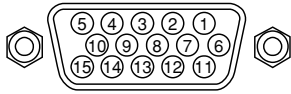

Pin No.	Signal (Analog)
1	Red
2	Green or sync-on-green
3	Blue
4	No connection
5	Ground
6	Red ground
7	Green ground
8	Blue ground
9	No connection
10	Sync signal ground
11	No connection
12	Bi-directional DATA (SDA)
13	Horizontal sync or Composite sync
14	Vertical sync
15	Data clock

Pin Configuration and Signal of the RGB 3 IN Connector (DVI Connector)

The unit is equipped with a type of connector commonly used for both analog and digital.

(Functionally, this cannot be used for an analog input.)

(TMDS can be used for one link only.)

RGB 3

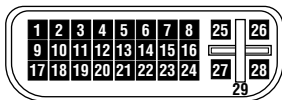

Pin No.	Signal (Digital)
1	T.M.D.S Data 2 -
2	T.M.D.S Data 2 +
3	T.M.D.S Data 2 Shield
4	No connection
5	No connection
6	DDC Clock
7	DDC Data
8	No connection
9	T.M.D.S Data 1 -
10	T.M.D.S Data 1 +
11	T.M.D.S Data 1 Shield
12	No connection
13	No connection
14	+5V Power
15	Ground
16	Hot Plug Detect
17	T.M.D.S Data 0 -
18	T.M.D.S Data 0 +
19	T.M.D.S Data 0 Shield
20	No connection
21	No connection
22	T.M.D.S Clock Shield
23	T.M.D.S Clock +
24	T.M.D.S Clock -
25	No connection
26	No connection
27	No connection
28	No connection
29	No connection

Basic Operations

POWER

To turn the unit ON and OFF:

1. Plug the power cord into an active AC power outlet.
2. Press the POWER ON button (on the remote control unit) to turn on the unit.

The monitor's POWER/STANDBY indicator will light up (green) when the unit is on.

3. Press the POWER OFF button (on the remote control unit or the unit) to turn off the unit.

The monitor's POWER/STANDBY indicator turns red and the standby mode is set (only when turning off the unit with the remote control unit).

VOLUME

To adjust the volume:

1. Press and hold the VOLUME ⊕ button (on the remote control unit or the unit) to increase to the desired level.
2. Press and hold the VOLUME ⊖ button (on the remote control unit or the unit) to decrease to the desired level.

MUTE

To cancel the sound:

Press the MUTE button on the remote control unit to cancel the sound; press again to restore.

DISPLAY

To check the settings:

1. The screen changes each time the DISPLAY button is pressed.
2. If the button is not pressed for approximately three seconds, the menu turns off.

DIGITAL ZOOM

Digital zoom specifies the picture position and enlarges the picture.

1. Press the POINTER button to display the pointer. ()

To change the size of the picture:

Press the ZOOM+ button and enlarge the picture.

The pointer will change to resemble a magnifying glass. ()

A press of the ZOOM- button will reduce the picture and return it to its original size.

To change the picture position:

Select the position with the ▲▼◀▶ buttons.

2. Press the POINTER button to delete the pointer.

AUTO ADJUST

To adjust the size or quality of the picture automatically:

Press the AUTO ADJUST button.

Information

■ AUTO ADJUST ON setting

When RGB (still picture) input is selected Fine Picture, Picture ADJ, Position, and Contrast will be adjusted automatically.

When RGB (motion picture), VIDEO, or Y/Pb/Pr (component) input is selected The screen size switches to ZOOM mode automatically with the superimposed caption displayed fully only when the picture contains dark areas above and below the picture.

OFF TIMER

To set the off timer:

The off timer can be set to turn the power off after 30, 60, 90 or 120 minutes.

1. Press the OFF TIMER button to start the timer at 30 minutes.
2. Press the OFF TIMER button to the desired time.
3. The timer starts when the menu turns off.

→ 30 → 60 → 90 → 120 → 0



OFF TIMER30

To check the remaining time:

1. Once the off timer has been set, press the OFF TIMER button once.
2. The remaining time is displayed, then turns off after a few seconds.
3. When five minutes remain the remaining time appears until it reaches zero.



OFF TIMER28

To cancel the off timer:

1. Press the OFF TIMER button twice in a row.
2. The off timer is canceled.



OFF TIMER0

Note:

After the power is turned off with the off timer ... A slight current is still supplied to the monitor. When you are leaving the room or do not plan to use the system for a long period of time, turn off the power of the monitor.

WIDE Operations

Watching with a wide screen (manual)

With this function, you can select one of four screen sizes.

When watching videos or digital video discs

1. Press the WIDE button on the remote control unit.
2. *Within 3 seconds ...*

Press the WIDE button again.

The screen size switches as follows:

→ ZOOM → NORMAL → FULL → STADIUM ←

ZOOM size screen

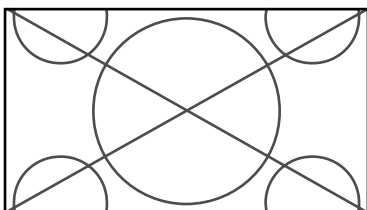

The picture is expanded in the horizontal and vertical direction, maintaining the original proportions.

* Use this for theater size (wide) movies, etc.

NORMAL size screen (4:3)

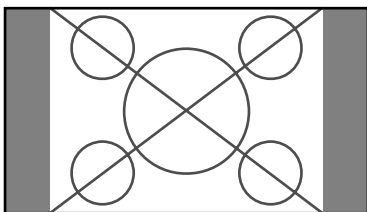

The normal size screen is displayed.

* The picture has the same size as video pictures with a 4 : 3 aspect ratio.

FULL size screen

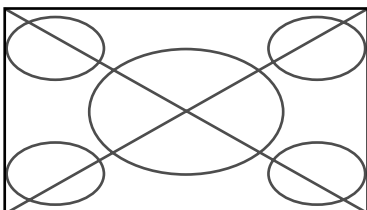

The image is expanded in the horizontal direction.

* Images compressed in the horizontal direction (“squeezed images”) are expanded in the horizontal direction and displayed on the entire screen. (Normal images are expanded in the horizontal direction.)

STADIUM size screen

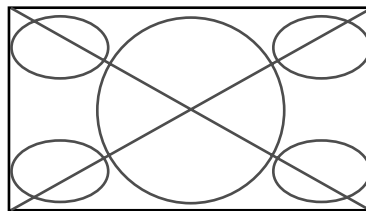

The picture is expanded in the horizontal and vertical directions at different ratios.

* Use this for watching normal video programs (4:3) with a wide screen.

When watching high definition video source

1. Press the WIDE button on the remote control unit.

FULL size screen (16 : 9)

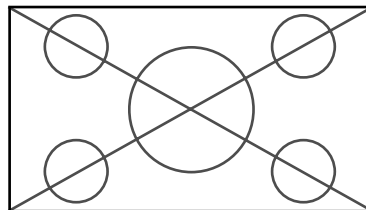

The full size screen is displayed.

* The picture has the same size as video pictures (16 : 9).

Watching computer images with a wide screen

Switch to the wide screen mode to expand the 4 : 3 image to fill the entire screen.

1. Press the WIDE button on the remote control unit.
2. *Within 3 seconds ...*

Press the WIDE button again.

The screen size switches as follows:

→ NORMAL → FULL ←

NORMAL size screen (4:3 or SXGA 5:4)

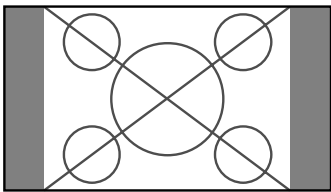

The picture has the same size as the normal computer image.

FULL size screen

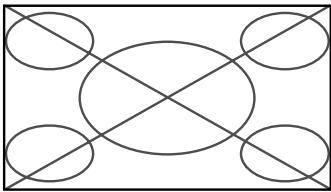

The image is expanded in the horizontal direction.

When wide signals are input.

FULL size screen

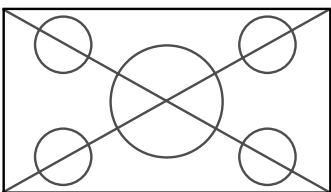

When "PICTURE SIZE" is set to "OFF"

The screen size switches as follows:

→ TRUE → FULL ←

TRUE size screen (VGA, SVGA 4:3)

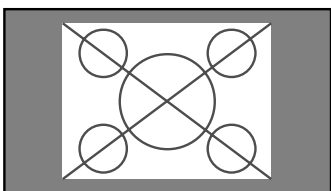

The image is true resolution.

FULL size screen

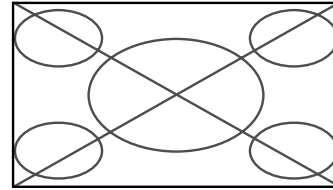

The image is expanded in the horizontal and vertical direction.

When wide signals are input.

TRUE

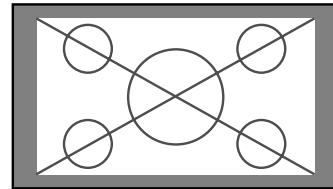

The image is true resolution.

FULL

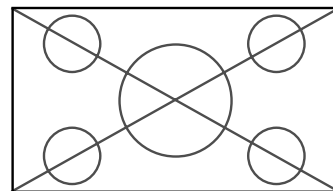

Information

■ Supported resolution

See page 47 for details on the display output of the various VESA signal standards supported by the monitor.

■ "PICTURE SIZE" setting

When the setting of "PICTURE SIZE" is OFF, the size of RGB-input pictures will be TRUE in place of NORMAL.

■ When 852 (848) dot × 480 line wide VGA* signals with a vertical frequency of 60 Hz and horizontal frequency of 31.7 (31.0) kHz are input

Select an appropriate setting for RGB SELECT mode referring to the "Table for Signals Supported" on page 47.

* "IBM PC/AT" and "VGA" are registered trademarks of IBM, Inc. of the United States.

MULTI SCREEN Operations

Showing a couple of pictures on the screen at the same time

* An RGB-input picture may not be displayed in these modes, depending on the input signal specifications.

1. Press the MULTI button to select a screen mode from among single mode, side by side, and picture in picture.

Side by side 1

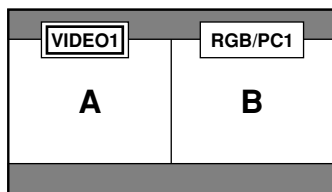

Press the cursor buttons ◀▶ on the remote control unit to switch either side by side 1 (with ▶) or side by side 2 (with ◀).

Note:

Picture A and B on the above screen are not always of the same height.

Side by side 2

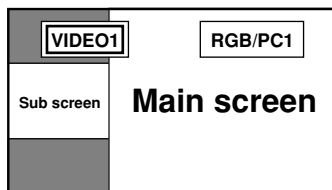

Picture in picture

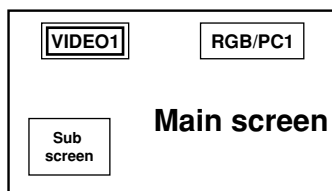

Press the cursor buttons ◀▶ on the remote control unit to switch the position of the sub screen.

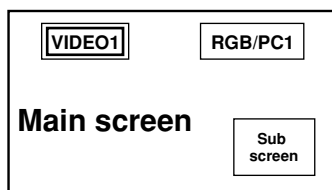

2. If you wish to switch the setting of the picture, press the SELECT button to make the desired picture active. Each press of the SELECT button changes the selection of the active picture.

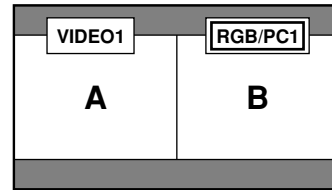
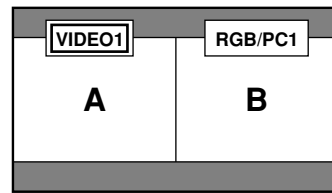

Selecting the input signals to be displayed

1. Press the SELECT button to make the desired picture active.
2. Press the RGB/PC, VIDEO, or DVD/HD button. Each press of the button changes the selection of the input signal. The INPUT SELECT button on the monitor can also be used to change the selection.

Adjusting the OSM controls

1. Press the PROCEED button to display the MAIN MENU.
2. Adjust the setting to your preference. For details, see "OSM (On Screen Menu) Controls" on page 17.

Note:

During multi mode, Auto Adjust does not affect the screen.

Information

■ Positioning on the screen (for side by side)

Depending on the input-signal selection, positioning of the picture is settled as follows.

Pictures displayed

on the left VIDEO1, VIDEO2, VIDEO3, HD1/ DVD1/DTV1, or HD2/DVD2/ DTV2

Pictures displayed

on the right RGB/PC1, RGB/PC2, RGB/PC3

■ Positioning on the screen (for picture in picture)

Pictures displayed

Main screen RGB/PC1, RGB/PC2, RGB/PC3

Sub screen VIDEO1, VIDEO 2, VIDEO 3, HD 1/DVD 1/DTV 1, or HD 2/ DVD 2/DTV 2

■ Multi screen operations may not function depending on the type of the RGB signals.

OSM(On Screen Menu) Controls

Menu Operations

The OSM window is displayed with respect to the screen as shown on the diagram.

* Depending on the screen's mode, the OSM may be displayed slightly differently.
In the explanation, the OSM section is shown close up.



The following describes how to use the menus and the selected items.

1. Press the PROCEED button on the remote control unit to display the MAIN MENU.

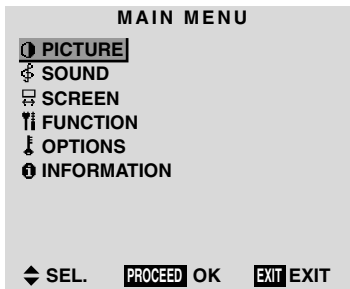

2. Press the cursor buttons ▲ ▼ on the remote control unit to highlight the menu you wish to enter.
3. Press the PROCEED button on the remote control unit to select a submenu or item.

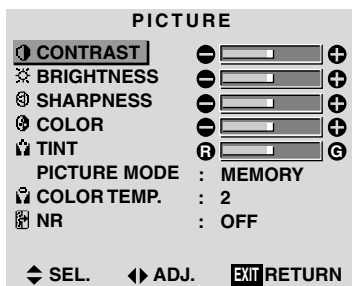

4. Adjust the level or change the setting of the selected item by using the cursor buttons ◀ ▶ on the remote control unit.

5. The change is stored until you adjust it again.
6. Repeat steps 2 – 5 to adjust an additional item, or press the EXIT button on the remote control unit to return to the main menu.

Note: The main menu disappears by pressing the EXIT button.

Main menu	Sub menu	Functions	Default	Reset
PICTURE	CONTRAST	Adjusts the contrast.	Center	Yes
	BRIGHTNESS	Adjusts the brightness.	Center	Yes
	SHARPNESS	Adjusts the sharpness.	Center	Yes
	COLOR	Adjusts the color.	Center	Yes
	TINT	Adjusts the tint.	Center	Yes
	PICTURE MODE	Sets the picture mode according to the VIDEO environment and image software.	MEMORY	Yes
	COLOR TEMP NR	Adjusts the color temperature and white balance. Reduces noise visible in image.	2*1 OFF	Yes Yes

Main menu	Sub menu	Functions	Default	Reset
SOUND	BASS	Sets the bass.	Center	Yes
	TREBLE	Sets the treble.	Center	Yes
	BALANCE	Sets the left/right balance.	Center	Yes

Main menu	Sub menu	Functions	Default	Reset
SCREEN	V-POSITION	Adjusts the vertical position.	Center	Yes
	H-POSITION	Adjusts the horizontal position.	Center	Yes
	V-HEIGHT	Adjusts the vertical size.	Min	Yes
	H-WIDTH	Adjusts the horizontal size.	Min	Yes
	AUTO PICTURE	Turn this on to have the monitor automatically adjust "FINE PICTURE" and "PICTURE ADJ".	OFF*1	No
	FINE PICTURE PICTURE ADJ.	Adjusts for flickering on the computer image. Adjusts for striped patterns on the computer image.	Min*1 Center*1	Yes Yes

Main menu	Sub menu	Functions	Default	Reset
FUNCTION	OSM	Turns the on-screen display (screen mode, etc.) off (when set to "OFF"). When set to "ON", the on-screen display is displayed.	ON	Yes
	OSM ADJ.	Adjusts the vertical and horizontal positions of the menu display.	1	Yes
	POWER MGT	Sets the monitor for use as an energy-saving display when used with a computer.	OFF	Yes
	GRAY LEVEL	In case of 4 : 3, sets the luminance of both sides.	3	Yes
	CINEMA MODE	Sets the picture to suit the movie.	ON	Yes
	RGB3 ADJ.	Adjusts the picture when the picture input from the RGB3 input terminal is distorted.	1	Yes
	LONG LIFE RESET	Sets the picture to reduce burn-in of the display. Resets all the settings (PICTURE, SOUND, SCREEN, FUNCTION, etc.) to the factory default values.	*2 —	Yes —

Main menu	Sub menu	Functions	Default	Reset
OPTION	AUDIO INPUT	Sets the allocation of the audio connectors.	*3	Yes
	BNC SELECT	Sets the BNC connectors.	RGB	Yes
	RGB SELECT	Sets the appropriate mode for the computer image. RGB (VGA signals), VIDEO (Moving picture), WIDE (WIDE VGA) DTV.	AUTO	Yes
	HD SELECT	Sets the digital broadcasting (1080A,1080B) or the High Vision (1035I).	1080B	No
	PICTURE SIZE	Sets the picture size for RGB input.	ON	Yes

Main menu	Sub menu	Functions	Default	Reset
INFORMATION	FREQUENCY	Used to check the frequency and synchronizing polarities of the signal currently being inputted.	—	—
	LANGUAGE	Sets the language of the menus (Japanese, English, German, French, Swedish, Italian or Spanish).	English	No
	COLOR SYSTEM	Sets the VIDEO format (AUTO1, AUTO2, PAL, PAL-M, PAL-N, PAL60, SECAM, 4.43 NTSC or 3.58 NTSC).	AUTO1	No

*1 RGB/PC only.

*2 PLE: AUTO ORBITER: OFF INVERSE: OFF

*3 AUDIO1: VIDEO1 AUDIO2: HD/DVD1 AUDIO3: RGB1

Picture Settings Menu

Adjusting the picture

The contrast, brightness, sharpness, color and tint can be adjusted as desired.

Example: Adjusting the contrast

Press the **PROCEED** button on the remote control unit to display the **MAIN MENU** on the screen, then...

1. Use the ▲ and ▼ buttons to select “**PICTURE**”, then press the **PROCEED** button. The “**PICTURE**” screen appears.
2. Use the ▲ and ▼ buttons to select “**CONTRAST**”.

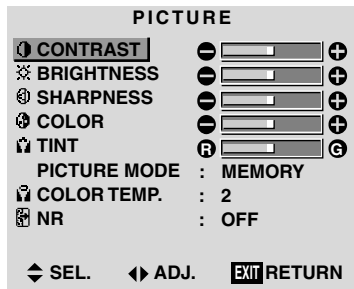

3. Use the ◀ and ▶ buttons to adjust the contrast.

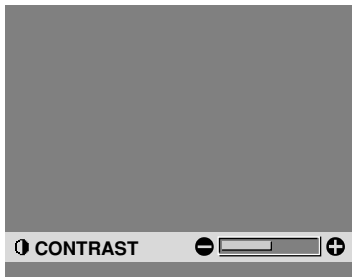

* If neither the ◀ or ▶ button is pressed within 5 seconds, the current setting is set and the previous screen reappears.

4. Once the adjustment is completed ...

Press the **EXIT** button to return to the main menu.

To delete the main menu, press the **EXIT** button once more.

Note: If “**CAN NOT ADJUST**” appears ...
When trying to enter the **PICTURE** submenu, make sure **PICTURE MODE** is set to **MEMORY**.

Information

Picture adjustment screen

CONTRAST Changes the picture’s contrast.
BRIGHTNESS .. Changes the picture’s brightness.
SHARPNESS .. Changes the picture’s sharpness.
Adjusts picture detail of VIDEO display.
COLOR Changes the color density.
TINT Changes the picture’s tint. Adjust for natural colored skin, background, etc.

Adjusting the computer image

Only the contrast and brightness can be adjusted when a computer signal is connected.

Restoring the factory default settings

Select “**RESET**” under the “**PICTURE MODE**” settings.

Setting the picture mode according to the brightness of the room

There are four picture modes that can be used effectively according to the environment in which you are viewing the display.

Example: Setting the "THEATER" mode

Press the *PROCEED* button on the remote control unit to display the *MAIN MENU* on the screen, then...

1. Use the ▲ and ▼ buttons to select "PICTURE", then press the *PROCEED* button.

The "PICTURE" screen appears.

2. Use the ▲ and ▼ buttons to select "PICTURE MODE".

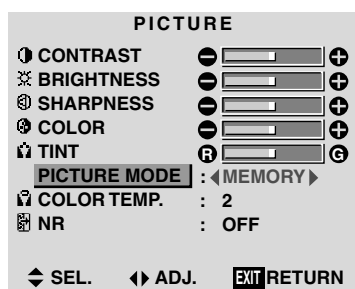

3. To set to "THEATER" ...

Use the ◀ and ▶ buttons to select "THEATER".

The mode switches as follows when the ◀ and ▶ buttons are pressed:

→ MEMORY ↔ THEATER ↔ NORMAL ↔ RESET ←



* If neither the ◀ or ▶ button is pressed within 5 seconds, the current selection is set and the previous screen reappears.

4. Once the adjustment is completed ...

Press the *EXIT* button to return to the main menu. To delete the main menu, press the *EXIT* button once more.

Information

Types of picture modes

MEMORY The last picture adjustments are stored here.

THEATER Set this mode when watching video in a dark room.

This mode provides darker, finer pictures, like the screen in movie theaters.

CONTRAST = 80% for RESET mode
BRIGHTNESS = 95% for RESET mode

NORMAL Set this mode when watching video in a bright room.

This mode provides dynamic pictures with distinct differences between light and dark sections.

CONTRAST = 96% for RESET mode

RESET Use this to reset the picture to the factory default settings.

Setting the color temperature

Use this procedure to set color tone produced by the plasma display.

Example: Setting "1"

Press the *PROCEED* button on the remote control unit to display the *MAIN MENU* on the screen, then...

1. Use the ▲ and ▼ buttons to select "PICTURE", then press the *PROCEED* button.
The "PICTURE" screen appears.
2. Use the ▲ and ▼ buttons to select "COLOR TEMP.":

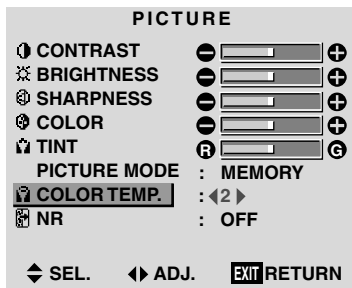

3. Use the ◀ and ▶ buttons to select "1".
The mode switches as follows when the ◀ and ▶ buttons are pressed:

→ 1 ↔ 2 ↔ 3 ↔ PRO ←

* See page 22 to set "PRO".

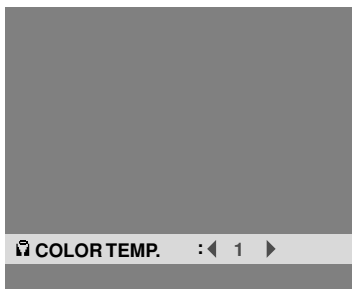

* If neither the ◀ or ▶ button is pressed within 5 seconds, the current selection is set and the previous screen reappears.

4. Once the setting is completed...

Press the *EXIT* button to return to the main menu.

To delete the main menu, press the *EXIT* button once more.

Information

■ Setting the color temperature

- 1 High (bluer)
- 2 Middle (Standard)
- 3 Low (redder)

■ Restoring the factory default settings

Select "RESET" under the function menu. Note that this also restores other settings to the factory defaults.

Adjusting the color to the desired quality

Use this procedure to adjust the white balance for bright pictures and dark pictures to achieve the desired color quality.

Example: Adjusting the “WHITE BALANCE”

Press the *PROCEED* button on the remote control unit to display the *MAIN MENU* on the screen, then...

1. Use the ▲ and ▼ buttons to select “PICTURE”, then press the *PROCEED* button.
The “PICTURE” screen appears.

2. Use the ▲ and ▼ buttons to select “COLOR TEMP.”.

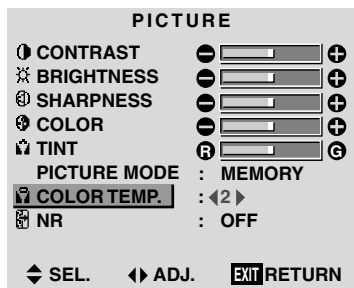

3. Use the ◀ and ▶ buttons to select “PRO”.

The mode switches as follows when the ◀ and ▶ buttons are pressed:

→ 1 ↔ 2 ↔ 3 ↔ PRO ←

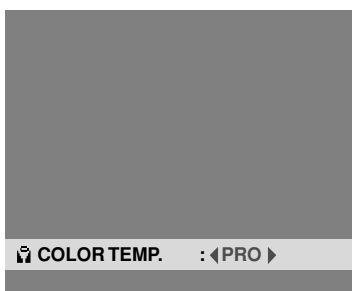

- * If neither the ◀ or ▶ button is pressed within 5 seconds, the current selection is set and the previous screen reappears.

4. Press the *PROCEED* button.

The “WHITE BALANCE” screen appears.

5. Use the ▲ and ▼ buttons to select “RED-GAIN”.

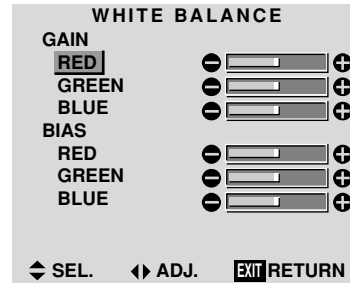

6. Adjust the white balance using the ◀ and ▶ buttons.



- * If neither the ◀ or ▶ button is pressed within 5 seconds, the current setting is set and the previous screen reappears.

7. Once the adjustment is completed...

Press the *EXIT* button to return to the main menu. To delete the main menu, press the *EXIT* button once more.

Information

■ Adjusting the white balance

RGB-GAIN White balance adjustment for signal level

RGB-BIAS White balance adjustment for black level

■ Restoring the factory default settings

Select “RESET” under the function menu. Note that this also restores other settings to the factory defaults.

Reducing noise in the picture

Use these settings if the picture has noise due to poor reception or when playing video tapes on which the picture quality is poor.

Example: Setting "NR-3"

Press the **PROCEED** button on the remote control unit to display the **MAIN MENU** on the screen, then...

1. Use the ▲ and ▼ buttons to select "PICTURE", then press the **PROCEED** button.
The "PICTURE" screen appears.
2. Use the ▲ and ▼ buttons to select "NR".

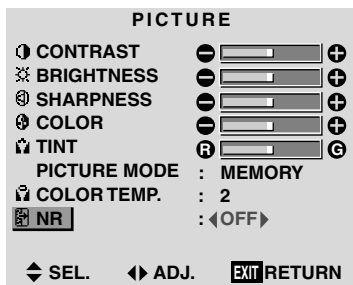

3. Use the ◀ and ▶ buttons to select "NR-3".
The mode switches as follows when the ◀ and ▶ buttons are pressed:

→ OFF ↔ NR-1 ↔ NR-2 ↔ NR-3 ←



* If neither the ◀ or ▶ button is pressed within 5 seconds, the current selection is set and the previous screen reappears.

4. *Once the setting is completed ...*

Press the **EXIT** button to return to the main menu.

To delete the main menu, press the **EXIT** button once more.

Information

■ NR

* "NR" stands for Noise Reduction.

* This function reduces noise in the picture.

■ Types of noise reduction

There are three types of noise reduction. Each has a different level of noise reduction.

The effect becomes stronger as the number increases (in the order NR-1 → NR-2 → NR-3).

OFF Turns the noise reduction function off.

Sound Settings Menu

Adjusting the treble, bass and left/right balance

The treble, bass and left/right balance can be adjusted to suit your tastes.

Example: Adjusting the bass

Press the **PROCEED** button on the remote control unit to display the **MAIN MENU** on the screen, then...

1. Use the ▲ and ▼ buttons to select “**SOUND**”, then press the **PROCEED** button.
The “**SOUND**” screen appears.
2. To adjust the bass ...
Use the ▲ and ▼ buttons to select “**BASS**”.

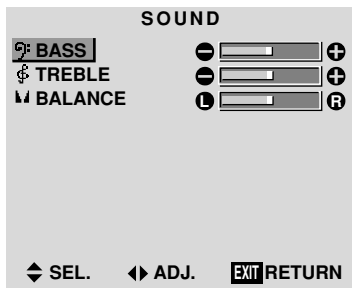

3. Adjust the bass using the ◀ and ▶ buttons.

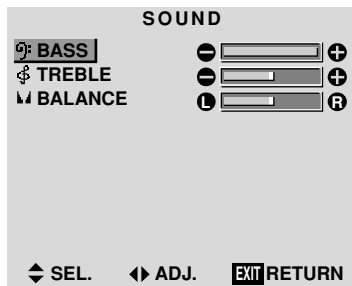

* If neither the ◀ or ▶ button is pressed within 5 seconds, the current selection is set and the previous screen reappears.

To continue adjusting the sound ...

Repeat from step 2.

4. Once the adjustment is completed ...

Press the **EXIT** button to return to the main menu. To delete the main menu, press the **EXIT** button once more.

Note : If “**CAN NOT ADJUST**” appears...
Set “**AUDIO INPUT**” on the **OPTION** menu correctly.

Information

■ Sound settings menu

BASS Changes the level of low frequency sound.

TREBLE Changes the level of high frequency sound.

BALANCE Changes the balance of the left and right channels.

■ Restoring the factory default settings

Select “**RESET**” under the function menu. Note that this also restores other settings to the factory defaults.

Screen Settings Menu

Adjusting the Position, Size, Fine Picture, Picture Adj

The position of the image can be adjusted and flickering of the image can be corrected.

Example: Adjusting the vertical position in the normal mode

Press the *PROCEED* button on the remote control unit to display the *MAIN MENU* on the screen, then...

1. Use the ▲ and ▼ buttons to select “SCREEN”, then press the *PROCEED* button. The “SCREEN” menu appears.

Default settings (when RGB/PC is selected)

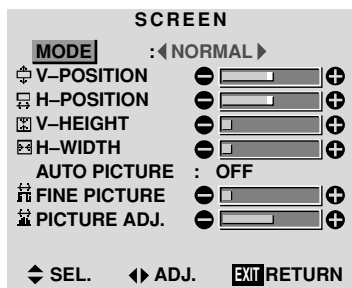

* The settings on the SCREEN menu are not preset at the factory.

To select a mode ...

Use the ◀ and ▶ buttons to select a mode.

The mode switches as follows when the ◀ and ▶ buttons are pressed:

→ NORMAL ↔ FULL ←

* The mode can also be switched by pressing the “WIDE” button on the remote control unit.

2. To adjust the vertical position ...

Use the ▲ and ▼ buttons to select “V-POSITION”.

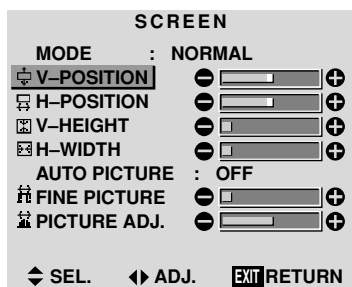

3. Adjust using the ◀ and ▶ buttons.

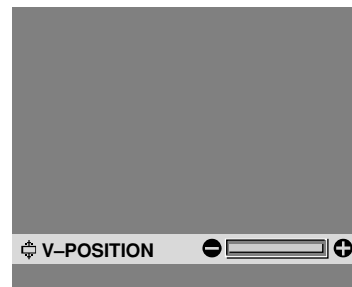

* If neither the ◀ or ▶ button is pressed within 5 seconds, the current setting is set and the previous screen reappears.

To continue making other computer image adjustments ...

Repeat from step 2.

4. Once all adjustments are completed ...

Press the *EXIT* button to return to the main menu.

To delete the main menu, press the *EXIT* button once more.

Information

■ When “AUTO PICTURE” is “OFF”

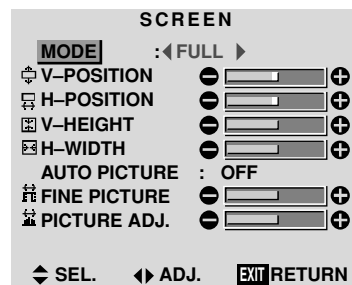

When Auto Picture is off, the Fine Picture and the Picture ADJ items are displayed so that you can adjust them.

Information

■ Adjusting the Auto Picture

ON The Picture ADJ and Fine Picture adjustments are made automatically.

OFF The Picture ADJ and Fine Picture adjustments are made manually.

■ Adjusting the position of the image

V-POSITION ... Adjusts the vertical position of the image.

H-POSITION ... Adjusts the horizontal position of the image.

V-HEIGHT Adjusts the vertical size of the image. (Except for STADIUM mode)

H-WIDTH Adjusts the horizontal size of the image. (Except for STADIUM mode)

FINE PICTURE* .. Adjusts for flickering.

PICTURE ADJ* Adjusts for striped patterns on the image.

* The Picture ADJ and Fine Picture features are available only when the "Auto Picture" is off.

* The AUTO PICTURE, FINE PICTURE and PICTURE ADJ. are not available for VIDEO and HD/DVD source.

■ Restoring the factory default settings

Select "RESET" under the function menu. Note that this also restores other settings to the factory defaults except for Auto Picture.

Function Settings Menu

Setting the on-screen display

When using the monitor for presentations, etc., the monitor can be set so that the input source, screen mode, etc., do not appear.

Example: Turning the on-screen display mode off

Press the *PROCEED* button on the remote control unit to display the *MAIN MENU* on the screen, then...

1. Use the ▲ and ▼ buttons to select "FUNCTION", then press the *PROCEED* button. The "FUNCTION" screen appears.
2. Use the ▲ and ▼ buttons to select "OSM".

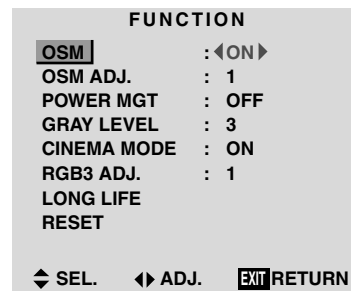

3. To turn the on-screen display mode off ... Use the ◀ and ▶ buttons to select "OFF". The mode switches as follows each time the ◀ or ▶ button is pressed:
ON ↔ OFF

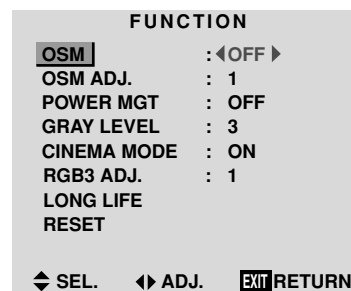

4. Once the setting is completed ... Press the *EXIT* button to return to the main menu. To delete the main menu, press the *EXIT* button once more.

Information

■ OSM modes

ON The on-screen display appears.

OFF The on-screen display does not appear.

■ Restoring the factory default settings

Select "RESET" under the function menu. Note that this also restores other settings to the factory defaults.

Adjusting the position of the menu display

Use these operations to adjust the position of the menus that appear on the screen.

Example: Adjusting the position of the menu display

Press the *PROCEED* button on the remote control unit to display the *MAIN MENU* on the screen, then...

1. Use the ▲ and ▼ buttons to select “FUNCTION”, then press the *PROCEED* button. The “FUNCTION” menu appears.
2. Use the ▲ and ▼ buttons to select “OSM ADJ.”

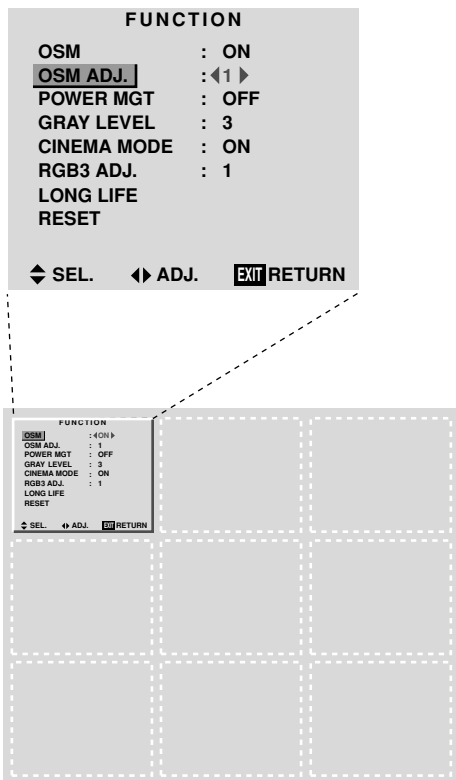

3. To adjust the position...
Adjust using the ◀ and ▶ buttons.

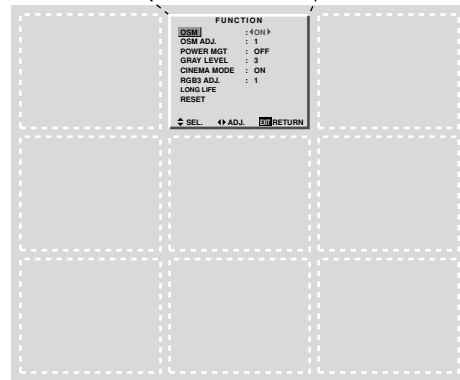
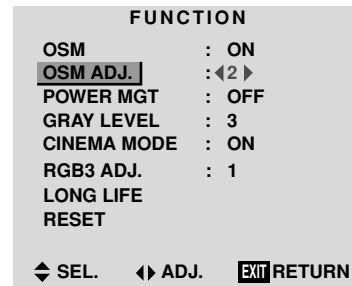

4. Once all adjustments are completed ...
Press the *EXIT* button to return to the main menu.
To delete the main menu, press the *EXIT* button once more.

Information

■ Adjusting the position of the menu display

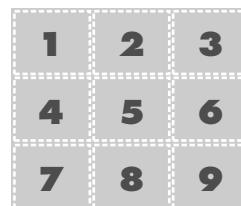

The position can be set between 1 and 9.

■ Restoring the factory default settings

Select “RESET” under the function menu. Note that this also restores other settings to the factory defaults.

Setting the power management for computer images

This energy-saving (power management) function automatically reduces the monitor's power consumption if no operation is performed for a certain amount of time.

Example: Turning the power management function on

Press the **PROCEED** button on the remote control unit to display the **MAIN MENU** on the screen, then...

1. Use the ▲ and ▼ buttons to select "FUNCTION", then press the **PROCEED** button.
The "FUNCTION" screen appears.
2. Use the ▲ and ▼ buttons to select "POWER MGT".

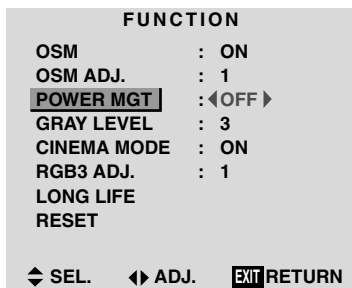

3. To turn the power management function on ...
Use the ◀ and ▶ buttons to select "ON".
The mode switches as follows each time the ◀ or ▶ button is pressed:
ON ↔ OFF

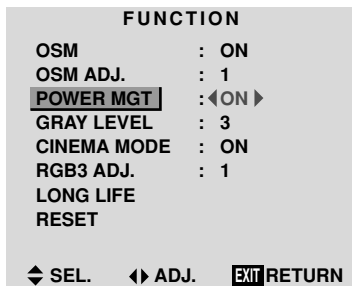

4. Once the setting is completed ...
Press the **EXIT** button to return to the main menu.
To delete the main menu, press the **EXIT** button once more.

Information

■ Power management function

- * The power management function automatically reduces the monitor's power consumption if the computer's keyboard or mouse is not operated for a certain amount of time. This function can be used when using the monitor with a computer conforming to the VESA DPMS format.
- * If the computer's power is not turned on or if the computer and selector tuner are not properly connected, the system is set to the off state.
- * For instructions on using the computer's power management function, refer to the computer's operating instructions.

■ Power management settings

- ON In this mode the power management function is turned on.
- OFF In this mode the power management function is turned off.

■ Power management function and POWER/STANDBY indicator

The POWER/STANDBY indicator indicates the status of the power management function. See page 29 for indicator status and description.

■ Restoring the factory default settings

Select "RESET" under the function menu. Note that this also restores other settings to the factory defaults.

POWER/STANDBY indicator

Power management mode	POWER/STANDBY indicator	Power management operating status	Description	Turning the picture back on
On	Green	Not activated.	Horizontal and vertical synchronizing signals are present from the computer.	Picture already on.
Standby	Orange	Activated.	No horizontal synchronizing signals are sent from the computer.	Operate the keyboard or mouse. The picture reappears immediately.
Suspend	Red	Activated.	No vertical synchronizing signals are sent from the computer.	Operate the keyboard or mouse. The picture reappears, but more time is required than from the standby mode.
Off	Red	Activated.	No horizontal or vertical synchronizing signals are sent from the computer.	Operate the keyboard or mouse. The picture reappears, but more time is required than from the standby mode or suspend mode.

Setting the gray level for the sides of the screen

Use this procedure to set the gray level for the parts on the screen on which nothing is displayed when the screen is set to the 4:3 size.

Example: Adjusting the “GRAY LEVEL”

Press the *PROCEED* button on the remote control unit to display the *MAIN MENU* on the screen, then...

1. Use the ▲ and ▼ buttons to select “FUNCTION”, then press the *PROCEED* button.
The “FUNCTION” screen appears.
2. Use the ▲ and ▼ buttons to select “GRAY LEVEL”.

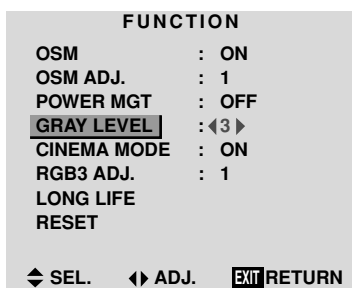

3. To adjust the “GRAY LEVEL”...
Use the ◀ and ▶ buttons to adjust the GRAY LEVEL.

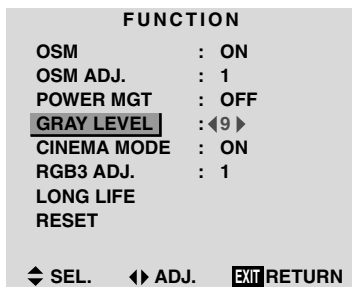

5. Once the setting is completed ...
Press the *EXIT* button to return to the main menu.
To delete the main menu, press the *EXIT* button once more.

Information

■ GRAY LEVEL

This adjusts the brightness of the black (the gray level) for the sides of the screen.
The standard is 0 (black). The level can be adjusted from 0 to 15. The factory setting is 3 (dark gray).

■ Restoring the factory default settings

Select “RESET” under the function menu. Note that this also restores other settings to the factory defaults.

Setting the picture to suit the movie

The film image is automatically discriminated and projected in an image mode suited to the picture.
[NTSC, PAL60, 480I(60Hz) only]

Example: Setting the “CINEMA MODE” to “OFF”

Press the *PROCEED* button on the remote control unit to display the *MAIN MENU* on the screen, then...

1. Use the ▲ and ▼ buttons to select “FUNCTION”, then press the *PROCEED* button.
The “FUNCTION” screen appears.
2. Use the ▲ and ▼ buttons to select “CINEMA MODE”.

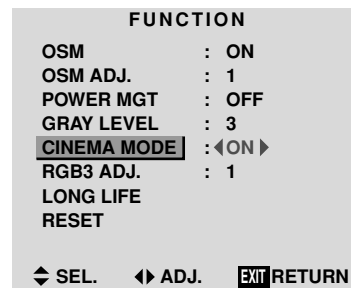

3. To set the *CINEMA MODE* to “OFF” ...
Use the ◀ and ▶ buttons to select “OFF”.
The mode switches as follows each time the ◀ or ▶ button is pressed:

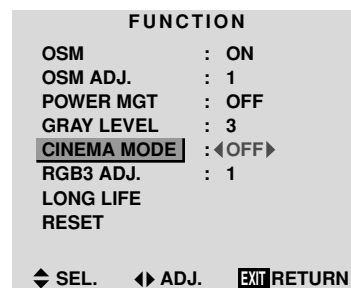
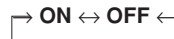

4. Once the setting is completed ...
Press the *EXIT* button to return to the main menu.
To delete the main menu, press the *EXIT* button once more.

Information

■ CINEMA MODE

ON Automatic discrimination of the image and projection in cinema mode.
OFF Cinema mode does not function.

■ Restoring the factory default settings

Select “RESET” under the function menu. Note that this also restores other settings to the factory defaults.

Setting RGB3 ADJ.

When the picture input from the RGB3 input terminal is distorted, select the most appropriate setting from among “1”, “2”, and “3”.

Example: Setting “2”

Press the **PROCEED** button on the remote control unit to display **MAIN MENU** on the screen, then...

1. Use the ▲ and ▼ buttons to select “FUNCTION”, then press the **PROCEED** button.
The “FUNCTION” screen appears.
2. Use the ▲ and ▼ buttons to select “RGB3 ADJ.”.

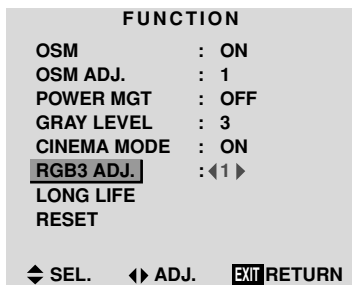

3. To select “2”...

Use the ◀ and ▶ buttons to select “2”.
The mode switches as follows each time the ◀ or ▶ button is pressed:

→ 1 ↔ 2 ↔ 3 ←

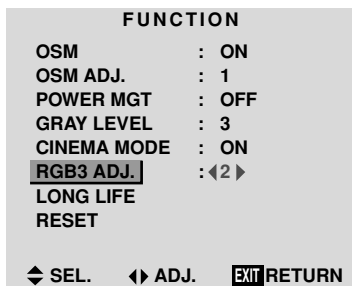

4. Once the setting is completed...

Press the **EXIT** button to return to the main menu.
To delete the main menu, press the **EXIT** button once more.

Information

■ When you adjust the RGB3 ADJ.

The position of the menu display will change. In such a case, be sure to adjust the position.

■ Restoring the factory default settings

Select “RESET” under the function menu. Note that this also restores other settings to the factory defaults.

Reducing burn-in of the screen

The brightness of the screen, the position of the picture, and positive/negative mode are adjusted to reduce burn-in of the screen.

Example: Setting “PLE” to “LOCK”

Press the **PROCEED** button on the remote control unit to display the **MAIN MENU** on the screen, then proceed as follows.

1. Use the ▲ and ▼ buttons to select “FUNCTION”, then press the **PROCEED** button.
The “FUNCTION” screen appears.
2. Use the ▲ and ▼ buttons to select “LONG LIFE”, then press the **PROCEED** button.

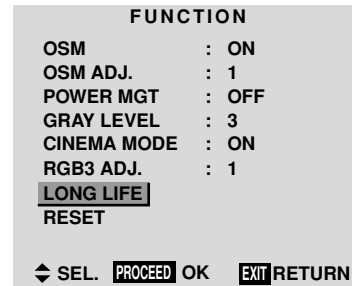

The “LONG LIFE” screen appears.

3. Use the ▲ and ▼ buttons to select “PLE”, then use the ◀ and ▶ buttons to select “LOCK”.
The mode switch changes as follows each time the ◀ or ▶ button is pressed:

AUTO ↔ LOCK

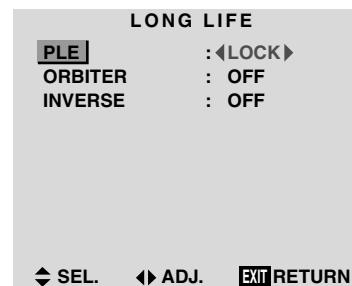

4. Once the setting is completed...

Press the **EXIT** button to return to the **FUNCTION** menu.

To exit the main menu, press the **EXIT** button twice.

Information

■ PLE

AUTO The brightness of the screen is adjusted automatically to suit the picture quality.

LOCK The brightness level is set to minimum.

■ ORBITER

ON The picture moves around the screen intermittently.

OFF Orbiter mode does not function.

■ INVERSE

ON The picture is displayed alternately between positive image and negative image.

OFF Inverse mode does not function.

WT The entire screen turns white.

■ Restoring the factory default settings

Select "RESET" from the function menu. Note that this also restores other settings to the factory defaults.

Resetting to the default values

Use these operations to restore all the picture adjustments, audio settings, to the factory default values. Refer to page 18 for items to be reset.

Press the PROCEED button on the remote control unit to display the MAIN MENU on the screen, then...

1. Use the ▲ and ▼ buttons to select "FUNCTION", then press the PROCEED button. The "FUNCTION" screen appears.
2. Use the ▲ and ▼ buttons to select "RESET", then press the PROCEED button.

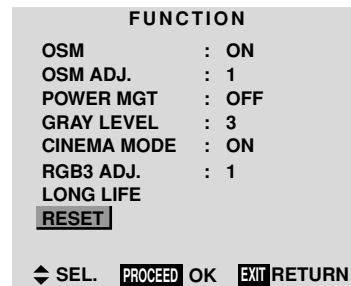

The "RESET" screen appears.

3. Use the ▲ and ▼ buttons to select "RESET", then press the PROCEED button.

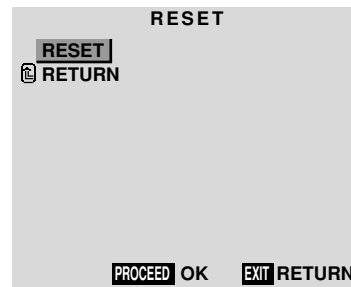

When the "SETTING NOW" screen disappears, the screen will be restored to the previous "RESET" mode, then all the settings are restored to the default values.

4. *Once the setting is completed ...*
Press the EXIT button.
To delete the main menu, press the EXIT button once more.

Option Settings Menu

Setting the allocation of the audio connectors

Setting the AUDIO 1, 2, and 3 connectors to the desired input.

Example: Setting "AUDIO 1" to "VIDEO 2"

Press the **PROCEED** button on the remote control unit to display the **MAIN MENU** on the screen, then...

1. Use the ▲ and ▼ buttons to select "OPTION", then press the **PROCEED** button.
The "OPTION" screen appears.
2. Use the ▲ and ▼ buttons to select "AUDIO 1".



3. To set the **AUDIO1** to "VIDEO2"...
Use the ◀ and ▶ buttons to select "VIDEO2".
The mode switches as follows each time the ◀ or ▶ button is pressed:

→ VIDEO1 ↔ VIDEO2 ↔ VIDEO3 ↔ HD/DVD1 ↔ RGB/PC1 ↔ RGB/PC2 ↔ RGB/PC3 ←



4. Once the setting is completed...
Press the **EXIT** button to return to the main menu.
To delete the main menu, press the **EXIT** button once more.

Information

■ AUDIO INPUT

A single audio input cannot be selected as the audio channel for more than one input terminal.

■ Restoring the factory default settings

Select "RESET" under the function menu. Note that this also restores other settings to the factory defaults.

Setting the BNC connectors

Select whether to set the input of the 5 BNC connectors to RGB or component.

Example: Set the BNC SELECT mode to "COMP."

Press the **PROCEED** button on the remote control unit to display the **MAIN MENU** on the screen, then...

1. Use the ▲ and ▼ buttons to select "OPTION", then press the **PROCEED** button.
The "OPTION" screen appears.
2. Use the ▲ and ▼ buttons to select "BNC SELECT".



3. To set the **BNC SELECT** mode to "COMP."...
Use the ◀ and ▶ buttons to select "COMP."
The mode switches as follows each time the ◀ or ▶ button is pressed:

RGB ↔ COMP.



4. Once the setting is completed...
Press the **EXIT** button to return to the main menu.
To delete the main menu, press the **EXIT** button once more.

Information

■ BNC SELECT

RGB Uses the 5BNC terminal for RGB input.

COMP. Use the 3BNC terminal for component input.

■ Restoring the factory default settings

Select "RESET" under the function menu. Note that this also restores other settings to the factory defaults.

Setting a computer image to the correct RGB select screen

With the computer image, select the RGB Select mode for a moving image such as (video) mode, wide mode or digital broadcast.

Example: Setting the "RGB SELECT" mode to "MOTION"

Press the *PROCEED* button on the remote control unit to display the *MAIN MENU* on the screen, then...

1. Use the ▲ and ▼ buttons to select "OPTION", then press the *PROCEED* button.
The "OPTION" screen appears.
2. Use the ▲ and ▼ buttons to select "RGB SELECT".



3. To set the RGB select mode to "MOTION" ...
Use the ◀ and ▶ buttons to select "MOTION".
The mode switches as follows each time the ◀ or ▶ button is pressed:

→ AUTO ↔ STILL ↔ MOTION ↔ WIDE1 ↔ WIDE2 ↔ DTV ←



4. Once the setting is completed ...
Press the *EXIT* button to return to the main menu.
To delete the main menu, press the *EXIT* button once more.

Information

■ RGB SELECT modes

One of these 6 modes must be selected in order to display the following signals correctly.

AUTO Select the suitable mode for the specifications of input signals as listed in the table "Computer input signals supported by this system" on page 47.

STILL To display VESA standard signals. (Use this mode for a still image from a computer.)

MOTION The video signal (from a scan converter) will be converted to RGB signals to make the picture more easily viewable. (Use this mode for a motion image from a computer.)

WIDE1 When an 852 dot × 480 line signal with a horizontal frequency of 31.7kHz is input, the image may be compressed horizontally. To prevent this, set RGB SELECT to WIDE1.

WIDE2 When an 848 dot × 480 line signal with a horizontal frequency of 31.0 kHz is input, the image may be compressed horizontally. To prevent this, set RGB SELECT to WIDE2.

DTV Set this mode when watching digital broadcasting (480P).

See page 47 for the details of the above settings.

■ Restoring the factory default settings

Select "RESET" under the function menu. Note that this also restores other settings to the factory defaults.

Setting high definition images to the suitable screen size

Use this procedure to set whether the number of vertical lines of the input high definition image is 1035 or 1080.

Example: Setting the "1080B" mode to "1035I"

Press the **PROCEED** button on the remote control unit to display the **MAIN MENU** on the screen, then...

1. Use the **▲** and **▼** buttons to select "OPTION", then press the **PROCEED** button.
The "OPTION" screen appears.
2. Use the **▲** and **▼** buttons to select "HD SELECT".



3. To set the **HD SELECT** mode to "1035I" ...
Use the **◀** and **▶** buttons to select "1035I".
The mode switches as follows each time the **◀** or **▶** button is pressed:

→1080A ↔ 1080B ↔ 1035I ←



4. Once the setting is completed ...
Press the **EXIT** button to return to the main menu.
To delete the main menu, press the **EXIT** button once more.

Information

■ HD SELECT modes

These 3 modes are not displayed in correct image automatically.

1080A Special Digital broadcasts (for example : DTC100)

1080B Standard digital broadcasts

1035I Japanese "High Vision" signal format

Setting the picture size for RGB input signals

Use this procedure to switch the setting to “ON” or “OFF”.

Example: Setting the “ON” mode to “OFF”

Press the *PROCEED* button on the remote control unit to display the *MAIN MENU* on the screen, then...

1. Use the ▲ and ▼ buttons to select “OPTION”, then press the *PROCEED* button.
The “OPTION” screen appears.
2. Use the ▲ and ▼ buttons to select “PICTURE SIZE”.



3. To set *PICTURE SIZE* mode to “OFF”...
Use the ◀ and ▶ buttons to select “OFF”.
The mode switches as follows when the ◀ or ▶ buttons are pressed:
ON ↔ OFF



4. Once the setting is completed ...
Press the *EXIT* button to return to the main menu.
To delete the main menu, press the *EXIT* button once more.

Information

■ PICTURE SIZE

ON For RGB Input: “NORMAL” and “FULL” can be selected for Wide-Screen switching.

OFF For RGB Input: “TRUE” and “FULL” can be selected for Wide-Screen switching.

■ Restoring the factory default settings

Select “RESET” under the function menu. Note that this also restores other settings to the factory defaults.

Information Menu

Checking the frequencies, polarities of input signals, and resolution

Use this function to check the frequencies and polarities of the signals currently being input from a computer, etc.

Press the *PROCEED* button on the remote control unit to display the *MAIN MENU* on the screen, then...

1. Use the ▲ and ▼ buttons to select “INFORMATION”, then press the *PROCEED* button.
The “INFORMATION” screen appears.
2. Use the ▲ and ▼ buttons to select “FREQUENCY”, then press the *PROCEED* button.

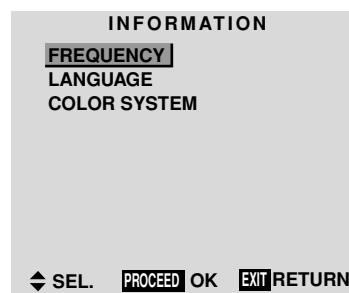

3. The frequency is displayed.

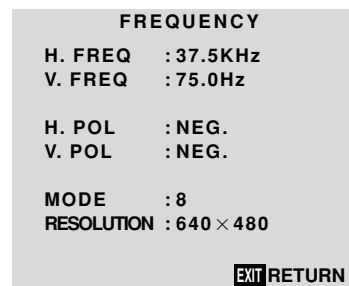

* Press the *EXIT* button to return to the previous screen.

4. Once you have checked the frequency ...
Press the *EXIT* button to return to the main menu.
To delete the main menu, press the *EXIT* button once more.

Setting the language for the menus

The menu display can be set to one of seven languages: Japanese, English, German, French, Swedish, Italian or Spanish.

Example: Setting the menu display to “DEUTSCH”

Press the **PROCEED** button on the remote control unit to display the **MAIN MENU** on the screen, then...

1. Use the ▲ and ▼ buttons to select “**INFORMATION**”, then press the **PROCEED** button. The “**INFORMATION**” screen appears.
2. Use the ▲ and ▼ buttons to select “**LANGUAGE**”, then press the **PROCEED** button.

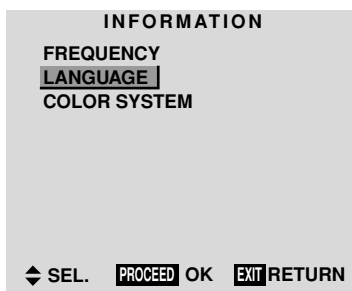

The “**LANGUAGE**” screen appears.

3. To select “**DEUTSCH**” ...
Use the ◀ and ▶ buttons to select “**DEUTSCH**”.
The mode switches as follows when the ◀ and ▶ buttons are pressed:

→ ENGLISH ↔ DEUTSCH ↔ FRANÇAIS ←
 → 日本語 ↔ SVENSKA ↔ ITALIANO ↔ ESPAÑOL ←



4. Press the **PROCEED** button.
The display language is switched to Deutsch.
5. Once the setting is completed ...
Press the **EXIT** button to return to the main menu.
To delete the main menu, press the **EXIT** button once more.

Information

■ Language settings

ENGLISH English
 DEUTSCH German
 FRANÇAIS French
 ESPAÑOL Spanish
 ITALIANO Italian
 SVENSKA Swedish
 日本語 Japanese

Setting the video signal format

Use these operations to set the video signal format.

Example: Setting the video signal format to “3.58 NTSC”

Press the **PROCEED** button on the remote control unit to display the **MAIN MENU** on the screen, then...

1. Use the ▲ and ▼ buttons to select “**INFORMATION**”, then press the **PROCEED** button.
The “**INFORMATION**” screen appears.
2. Use the ▲ and ▼ buttons to select “**COLOR SYSTEM**”, then press the **PROCEED** button.

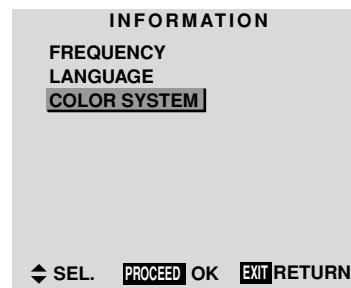

The “**COLOR SYSTEM**” screen appears.

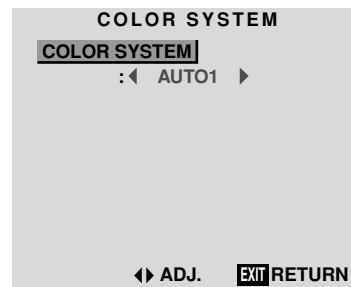

3. To select “**3.58 NTSC**” ...
Use the ◀ and ▶ buttons to select “**3.58 NTSC**”.
The mode switches as follows when the ◀ and ▶ buttons are pressed:

→ AUTO1 ↔ AUTO2 ↔ 3.58NTSC ↔ 4.43NTSC ←
 → SECAM ↔ PAL-M ↔ PAL-N ↔ PAL60 ↔ PAL ←



4. *Once the setting is completed ...*

Press the EXIT button to return to the main menu.
To delete the main menu, press the EXIT button once more.

The color system is set to “3.58 NTSC”.

Information

■ **Video signal formats**

Different countries use different formats for video signals. Set to the format used in your current country.

AUTO1/2 The video signals are automatically detected and the format is set accordingly.

AUTO1: 3.58NTSC, 4.43NTSC, PAL, SECAM, PAL60

AUTO2: PAL-M, PAL-N, 3.58NTSC

PAL (B, G) This is the standard format used mainly in the United Kingdom and Germany.

SECAM..... This is the standard format used mainly in France and Russia.

4.43 NTSC,

PAL60 This format is used for videos in countries using PAL and SECAM video signals.

3.58 NTSC This is the standard format used mainly in Japan and the United States.

PAL-M This is the standard format used mainly in Brazil.

PAL-N This is the standard format used mainly in Argentina.

External Control

Application

These specifications cover the communications control of the plasma monitor by external equipment.

Connections

Connections are made as described below.

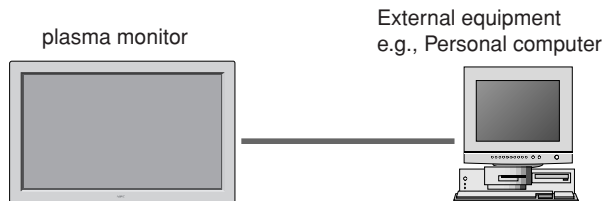

- 1) Connector on the plasma monitor side: EXTERNAL CONTROL connector.

Type of connector: D-Sub 9-pin male

No.	Pin Name
1	No Connection
2	RXD (Receive data)
3	TXD (Transmit data)
4	DTR (DTE side ready)
5	GND
6	DSR (DCE side ready)
7	RTS (Ready to send)
8	CTS (Clear to send)
9	No Connection

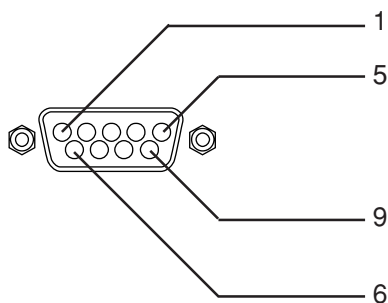

- 2) Connector on the external equipment side: Serial port (RS-232C) connector.

See the specifications of the equipment that is to be connected for the type of connector and the pin assignment.

- 3) Wiring

Use a crossed (reverse) cable.

Wire the cable so that each pair of data lines cross between the two devices. These data line pairs are RXD (Receive data) and TXD (Transmit data), DTR (DTE side ready) and DSR (DCE side ready), and RTS (Ready to send) and CTS (Clear to send).

Communication Parameters

- | | |
|--------------------------|--------------|
| (1) Communication system | Asynchronous |
| (2) Interface | RS-232C |
| (3) Baud rate | 9600 bps |
| (4) Data length | 8 bits |
| (5) Parity | Odd |
| (6) Stop bit | 1 bit |
| (7) Communication code | Hex |

Communication Format

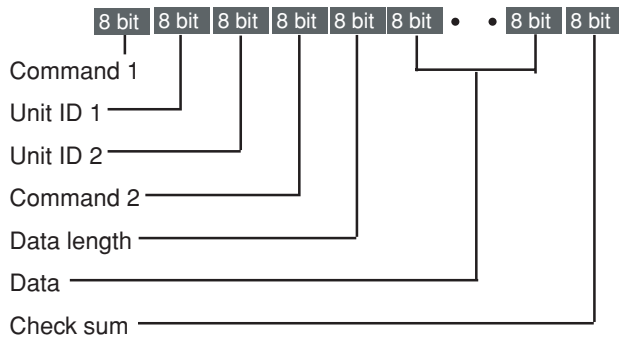

Command 1

Command 1, along with command 2, is a number used to distinguish each command.

In the case of ACK, when the lower order 4 bits is FH (as in 3FH and 7FH), this indicates that the commands and data of the supported equipment have been received. When the lower order 4 bits is BH (as in 3BH and 7BH), this indicates that unsupported commands and data have been received.

Unit ID 1 and Unit ID 2

Unit ID 1 and unit ID 2 are numbers used to identify the equipment that is to be connected.

60H is used for the plasma monitor and 80H is used for external control equipment such as a personal computer.

- 1) Unit ID 1: Indicates the equipment sending the signal
- 2) Unit ID 2: Indicates the equipment receiving the signal

Command 2

Command 2, along with command 1, is a number used to distinguish each command.

Check Sum (CKS), Error Processing, and ACK

- 1) The check sum described below and RS-232C odd parity are used together for a check of the received data. The check sum is the lower order 8 bits of one frame of sent or received data comprising the sum total of Command 1, Unit ID 1 and 2, Command 2, Data Length, and Data.

Check Sum Example

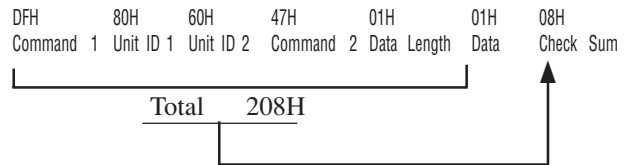

2) Error Processing

- When the communication interval is vacant for more than 4 ms, thereafter a received Command 1 will be recognized. If, at this time, meaningful data cannot be recognized, that data will not be recognized (as valid data).
- An ACK will not be returned unless the receive data error, the check sum error, and the receive data are all taken in.

Command Reference List

	CMD1	CMD2	LEN
01. Power ON	9FH	4EH	00H
02. Power OFF	9FH	4FH	00H
03. Input Switch Change	DFH	47H	01H
04. VOLUME Gain Data	DFH	7FH	03H
05. SCREEN MODE Select	DFH	51H	01H
06. AUDIO Mute On	9FH	3EH	00H
07. AUDIO Mute Off	9FH	3FH	00H
08. OSM Select	DFH	58H	01H
09. Color Gain Data	DFH	7FH	03H
10. TINT Gain Data	DFH	7FH	03H
11. SHARPNESS Gain Data	DFH	7FH	03H
12. CONTRAST Gain Data	DFH	7FH	03H
13. BRIGHT Gain Data	DFH	7FH	03H
14. Input MODE Request	1FH	41H	00H
15. RESET	1FH	54H	00H
16. COLOR TEMP SELECT	DFH	00H	01H
17. RED Gain Data	DFH	7FH	04H
18. GREEN Gain Data	DFH	7FH	04H
19. BLUE Gain Data	DFH	7FH	04H
20. Multi Screen Select	DFH	07H	01H
21. VIDEO ADJ Request	1FH	45H	00H
22. Audio Select Set	DFH	70H	02H
23. Audio Select Request	1FH	6FH	00H
24. LONG LIFE Set	DFH	6BH	03H
25. Failure Mode Request	1FH	3FH	00H

01. Power ON

Function

The external control equipment switches on the power of the plasma monitor.

Transmission Data

9FH 80H 60H 4EH 00H CKS

ACK

The plasma monitor returns the following ACK when the power is switched on.

3FH 60H 80H 4EH 00H CKS

NOTE: Do not set the Power ON or Power OFF command continuously.

02. Power OFF

Function

The external control equipment switches off the power of the plasma monitor.

Transmission Data

9FH 80H 60H 4FH 00H CKS

ACK

The plasma monitor returns the following ACK when the power is switched off.

3FH 60H 80H 4FH 00H CKS

NOTE: Do not set the Power ON or Power OFF command continuously.

03. Input Switch Change

Function

The external control equipment switches the input of the plasma monitor.

Transmission Data

DFH 80H 60H 47H 01H DATA00 CKS

DATA00 : Input Select

01H: Video1
02H: Video2
03H: Video3
05H: HD (HD1 or DTV or DTV1)
06H: HD2 (DTV2)
07H: RGB1/PC1
08H: RGB2/PC2
0CH: RGB3/PC3

ACK

The plasma monitor returns the following ACK when the input is switched.

3FH 60H 80H 47H 00H CKS

04. VOLUME Gain Data

Function

The external control equipment changes the VOLUME gain data of the plasma monitor.

Transmission Data

DFH 80H 60H 7FH 03H DATA00 DATA01 DATA02 CKS

DATA00 USER SOUND Gain Flag 05H
DATA01 VOLUME Gain Flag 01H
DATA02 VOLUME Gain 00H: Step 0
|
0AH: Step 10 (Default)
|
2AH: Step 42

ACK

7FH 60H 80H 7FH 02H DATA00 DATA01 CKS

DATA00 USER SOUND Gain Flag 05H
DATA01 VOLUME Gain Flag 01H

05. SCREEN MODE Select

Function

The external control equipment switches the screen mode of the plasma monitor.

Transmission Data

DFH 80H 60H 51H 01H DATA00 CKS

DATA00 02H : STADIUM
03H : ZOOM
04H : NORMAL
05H : FULL
06H : TRUE (REAL)

ACK

7FH 60H 80H 51H 01H DATA00 CKS

DATA00 02H : STADIUM
03H : ZOOM
04H : NORMAL
05H : FULL
06H : TRUE (REAL)

06. AUDIO Mute On

Function

The external control equipment switches on AUDIO Mute of the plasma monitor.

Transmission Data

9FH 80H 60H 3EH 00H CKS

ACK

3FH 60H 80H 3EH 00H CKS

07. AUDIO Mute Off

Function

The external control equipment switches off AUDIO Mute of the plasma monitor.

Transmission Data

9FH 80H 60H 3FH 00H CKS

ACK

3FH 60H 80H 3FH 00H CKS

08. OSM Select

Function

The external control equipment switches on or off the on-screen display (OSM) of the plasma monitor.

Transmission Data

DFH 80H 60H 58H 01H DATA00 CKS

DATA00 01H : Screen display On
02H : Screen display Off

ACK

7FH 60H 80H 58H 01H DATA00 CKS

DATA00 01H : Screen display On
02H : Screen display Off

Screen display On/Off is equivalent to the screen display On/Off function of the convenient function settings.

*Operation is as described in the table below.

09. COLOR Gain Data

Function

The external control equipment changes the COLOR gain data of the plasma monitor.

Transmission Data

DFH 80H 60H 7FH 03H DATA00 DATA01 DATA02 CKS

DATA00: USER PICTURE Gain Flag 01H
DATA01: COLOR Gain Flag 04H
DATA02: COLOR Gain E0H: -32
* COLOR Gain is from -22 (EAH) to
+22 (16H) only during video. FFH: -01
00H: 0
01H: +01
20H: +32

ACK

7FH 60H 80H 7FH 02H DATA00 DATA01 CKS

DATA00: USER PICTURE Gain Flag 01H
DATA01: COLOR Gain Flag 04H

10. TINT Gain Data

Function

The external control equipment changes the TINT gain data of the plasma monitor.

Transmission Data

DFH 80H 60H 7FH 03H DATA00 DATA01 DATA02 CKS

DATA00: USER PICTURE Gain Flag 01H
DATA01: TINT Gain Flag 05H
DATA02: TINT Gain E0H: -32
* TINT Gain is from -22 (EAH) to
+22 (16H) only during video. FFH: -01
00H: 0
01H: +01
20H: +32

ACK

7FH 60H 80H 7FH 02H DATA00 DATA01 CKS

DATA00: USER PICTURE Gain Flag 01H
DATA01: TINT Gain Flag 05H

Operation	On-Screen Display (OSD)			
	Display of items and adjustments on the menu		Volume display, input display, and screen size display	
	When screen display is ON	When screen display is OFF	When screen display is ON	When screen display is OFF
Remote control operation	Yes	Yes	Yes	No
Personal computer control operation	No	No	Yes	No

11. SHARPNESS Gain Data

Function

The external control equipment changes the SHARPNESS gain data of the plasma monitor.

Transmission Data

DFH	80H	60H	7FH	03H	DATA00	DATA01	DATA02	CKS
DATA00:	USER PICTURE	Gain Flag			01H			
DATA01:	SHARPNESS	Gain Flag			06H			
DATA02:	SHARPNESS	Gain			FOH: -16			
					FFH: -01			
					00H: 0			
					01H: +01			
					10H: +16			

ACK

7FH	60H	80H	7FH	02H	DATA00	DATA01	CKS
DATA00:	USER PICTURE	Gain Flag			01H		
DATA01:	SHARPNESS	Gain Flag			06H		

12. CONTRAST Gain Data

Function

The external control equipment changes the CONTRAST gain data of the plasma monitor.

Transmission Data

DFH	80H	60H	7FH	03H	DATA00	DATA01	DATA02	CKS
DATA00:	USER PICTURE	Gain Flag			01H			
DATA01:	CONTRAST	Gain Flag			07H			
DATA02:	CONTRAST	Gain			CCH: -52			
					FFH: -01			
					00H: 0			
					01H: +01			
					14H: +20			

ACK

7FH	60H	80H	7FH	02H	DATA00	DATA01	CKS
DATA00:	USER PICTURE	Gain Flag			01H		
DATA01:	CONTRAST	Gain Flag			07H		

13. BRIGHT Gain Data

Function

The external control equipment changes the BRIGHT gain data of the plasma monitor.

Transmission Data

DFH	80H	60H	7FH	03H	DATA00	DATA01	DATA02	CKS
DATA00:	USER PICTURE	Gain Flag			01H			
DATA01:	BRIGHT	Gain Flag			08H			
DATA02:	BRIGHT	Gain			EOH: -32			
					FFH: -01			
					00H: 0			
					01H: +01			
					20H: +32			

ACK

7FH	60H	80H	7FH	02H	DATA00	DATA01	CKS
DATA00:	USER PICTURE	Gain Flag			01H		
DATA01:	BRIGHT	Gain Flag			08H		

14. Input MODE Request

Function

The display returns the current input information by the external control equipment's request.

Transmission Data

1FH	80H	60H	41H	00H	CKS
-----	-----	-----	-----	-----	-----

ACK

7FH	60H	80H	41H	01H	DATA00	CKS
DATA00:	Input Select					
	01H: Video1				02H: Video2	
	03H: Video3				04H: HD (HD1 or DTV or DTV1)	
	05H: RGB1/PC1				06H: RGB2/PC2	
	0AH: DVD (DVD1)				0CH: HD2 (DTV2)	
	0DH: DVD2				0EH: RGB3/PC3	

15. RESET

Function

The external control equipment resets the user adjustment of the plasma monitor.

Transmission Data

1FH	80H	60H	54H	00H	CKS
-----	-----	-----	-----	-----	-----

ACK

3FH	60H	80H	54H	00H	CKS
-----	-----	-----	-----	-----	-----

16. COLOR TEMP SELECT

Function

The external control equipment changes the COLOR TEMP of the plasma monitor.

Transmission Data

DFH	80H	60H	00H	01H	DATA00	CKS
DATA00:						
					00H: 1	
					01H: 2	
					02H: 3	
					03H: PRO	

ACK

7FH	60H	80H	00H	01H	DATA00	CKS
DATA00:						
					00H: 1	
					01H: 2	
					02H: 3	
					03H: PRO	

NOTE: Set so that at the selection of 1, 2, or 3 of COLOR TEMP change of the following R/G/B GAIN data cannot be accepted.

17. RED Gain Data

Function

The external control equipment changes the RED Gain Data of the plasma monitor.

Transmission Data

DFH	80H	60H	7FH	04H	DATA00 to DATA03	CKS
DATA00:	USER PICTURE	Gain Flag			01H	
DATA01:	RED Gain Flag				01H	
DATA02:	RED Gain 1 (Bias)				D8H: -40	
					FFH: -1	
					00H: 0	
					IEH: +30	
DATA03:	RED Gain 2 (Drive)				D8H: -40	
					FFH: -1	
					00H: 0	
					IEH: +30	

ACK

7FH	60H	80H	7FH	02H	DATA00	DATA01	CKS
DATA00:	USER PICTURE	Gain Flag			01H		
DATA01:	RED Gain Flag				01H		

18. GREEN Gain Data

Function

The external control equipment changes the GREEN Gain Data of the plasma monitor.

Transmission Data

DFH	80H	60H	7FH	04H	DATA00 to DATA03	CKS
DATA00:	USER PICTURE	Gain Flag			01H	
DATA01:	GREEN Gain Flag				02H	
DATA02:	GREEN Gain 1 (Bias)				D8H: -40	
					FFH: -1	
					00H: 0	
					IEH: +30	
DATA03:	GREEN Gain2 (Drive)				D8H: -40	
					FFH: -1	
					00H: 0	
					IEH: +30	

ACK

7FH	60H	80H	7FH	02H	DATA00	DATA01	CKS
DATA00:	USER PICTURE	Gain Flag			01H		
DATA01:	GREEN Gain Flag				02H		

19. BLUE Gain Data

Function

The external control equipment changes the BLUE Gain Data of the plasma monitor.

Transmission Data

DFH	80H	60H	7FH	04H	DATA00 to DATA03	CKS
DATA00:	USER PICTURE	Gain Flag			01H	
DATA01:	BLUE Gain Flag				03H	
DATA02:	BLUE Gain1(Bias)				D8H:-40	
					FFH:-1	
					00H: 0	
					IEH: +30	
DATA03:	BLUE Gain2(Drive)				D8H: -40	
					FFH:-1	
					00H: 0	
					IEH:+30	

ACK

7FH	60H	80H	7FH	02H	DATA00	DATA01	CKS
DATA00:	USER PICTURE	Gain Flag			01H		
DATA01:	BLUE Gain Flag				03H		

20. Multi Screen Select

Function

The external control equipment selects single screen mode or multi screen mode of the display.

Transmission Data

DFH	80H	60H	07H	01H	DATA00	CKS
DATA00:	Multi Screen					
	00: Single screen					
	01: Side by side 1 (Left screen bigger)					
	02: Side by side 2 (Left screen smaller)					
	03: Picture in Picture sub screen L					
	04: Picture in Picture sub screen R					

ACK

The display returns the following ACK.

7FH	60H	80H	07H	01H	DATA00	CKS
DATA00:	Multi Screen					
	00: Single screen					
	01: Side by side 1 (Left screen bigger)					
	02: Side by side 2 (Left screen smaller)					
	03: Picture in Picture sub screen L					
	04: Picture in Picture sub screen R					

When other commands (except POWER OFF) are sent while the screens are switching with this command, the other command will be returned as "Not Available" until screen switching is finished.

21. VIDEO ADJ Request

Function

The display returns the video adjustments information by the external control equipment's request.

Transmission Data

1FH 80H 60H 45H 00H CKS

ACK

7FH 60H 80H 45H 0CH DATA00 to DATA0B CKS

DATA00: RED Gain(Bias)

D8H: -40

FFH: -1
00H: 0
IEH: +30

DATA01: GREEN Gain(Bias)

D8H: -40

FFH: -1
00H: 0
IEH: +30

DATA02: BLUE Gain(Bias)

D8H: -40

FFH: -1
00H: 0
IEH: +30

DATA03: COLOR Gain

E0H: -32

* COLOR Gain is from -22 (EAH) to +22 (16H) only during video.

FFH: -01
00H: 0
01H: +01
20H: +32

DATA04: TINT Gain

E0H: -32

* TINT Gain is from -22 (EAH) to +22 (16H) only during video.

FFH: -01
00H: 0
01H: +01
20H: +32

DATA05: SHARPNES Gain

F0H: -16

FFH: -01
00H: 0
01H: +01
10H: +16

DATA06: CONTRAST Gain

CCH: -52

FFH: -01
00H: 0
01H: +01
14H: +20

DATA07: BRIGHT Gain

E0H: -32

FFH: -01
00H: 0
01H: +01
20H: +32

DATA08: RED Gain(Drive)

D8H: -40

FFH: -1
00H: 0
IEH: +30

DATA09: GREEN Gain(Drive)

D8H: -40

FFH: -1
00H: 0
IEH: +30

DATA0A: BLUE Gain(Drive)

D8H: -40

FFH: -1
00H: 0
IEH: +30

DATA0B: COLOR TEMP

00H: 1
01H: 2
02H: 3
03H: PRO

22. Audio Select Set

Function

The external control equipment sets combinations of audio and video inputs for the plasma monitor.

Transmission Data

DFH	80H	60H	70H	02H	DATA00	DATA01	CKS
DATA00:	AUDIO INPUT						
	01H:	AUDIO 1					
	02H:	AUDIO 2					
	03H:	AUDIO 3					
DATA01:	VISUAL INPUT						
	01H:	Video 1					
	02H:	Video 2					
	03H:	Video 3					
	05H:	HD (HD1 or DTV or DTV1)					
	06H:	HD2 (DTV2)					
	07H:	RGB 1/ PC 1					
	08H:	RGB 2/ PC 2					
	0CH:	RGB 3/ PC 3					

ACK

The plasma monitor returns the following ACK when the input is switched.

3FH	60H	80H	70H	00H	CKS
-----	-----	-----	-----	-----	-----

* The plasma monitor returns "Not Available" when selecting the video input same as the one set at one of the AUDIO 01 to 3.

Example:

The plasma monitor returns "Not Available" when selecting the VIDEO1 for AUDIO2 or VIDEO3 after VIDEO1 has been set to AUDIO1.

23. Audio Select Request

Function

The external control equipment inquires the current combinations of audio and video inputs for the plasma monitor.

Transmission Data

1FH	80H	60H	6FH	00H	CKS
-----	-----	-----	-----	-----	-----

ACK

The plasma monitor returns the following ACK:

7FH	60H	80H	6FH	03H	DATA00	DATA01	DATA02	CKS
-----	-----	-----	-----	-----	--------	--------	--------	-----

DATA00:	AUDIO 1							
	01H - 0CH:	VISUAL INPUT DATA						
DATA01:	AUDIO 2							
	01H - 0CH:	VISUAL INPUT DATA						
DATA02:	AUDIO 3							
	01H - 0CH:	VISUAL INPUT DATA						
	VISUAL INPUT DATA							
	01H:	Video 1						
	02H:	Video 2						
	03H:	Video 3						
	05H:	HD (HD1 or DTV or DTV 1)						
	06H:	HD2 (DTV2)						
	07H:	RGB 1/PC 1						
	08H:	RGB 2/PC 2						
	0CH:	RGB 3/PC 3						

24. LONG LIFE Set

Function

The external control equipment sets the PLE, ORBITER, and INVERSE (inverse of image brightness) of the plasma monitor.

Transmission Data

DFH	80H	60H	6BH	03H	DATA00	DATA01	DATA02	CKS
DATA00 :	PLE							
	01H:	AUTO						
	02H:	LOCK						
DATA01 :	INVERSE							
	01H:	ON						
	02H:	OFF						
	03H:	WHITE						
DATA02 :	ORBITER (PICTURE SHIFT)							
	01H:	ON						
	02H:	OFF						

ACK

The plasma monitor returns the following ACK when setting the PLE, ORBITER, and INVERSE (inverse of image brightness):

3FH	60H	80H	6BH	00H	CKS
-----	-----	-----	-----	-----	-----

25. Failure Mode Request

Function

The external control equipment inquires the detection of failures of the plasma monitor.

Transmission Data

1FH	80H	60H	3FH	00H	CKS
-----	-----	-----	-----	-----	-----

ACK

The plasma monitor returns the following ACK:

7FH	60H	80H	3FH	02H	DATA00	DATA01	CKS
-----	-----	-----	-----	-----	--------	--------	-----

DATA00:	FAILURE MODE 1							
	Bit 0 :	PDP MODULE						
		0: Abnormal						
		1: Normal						
	Bit 1 :	1: fixed (backup)						
	Bit 2 :	TEMPERATURE						
		0: Abnormal						
		1: Normal						
	Bit 3 :	FAN						
		0: Abnormal						
		1: Normal						
	Bit 4 :	1: fixed (backup)						
	Bit 5 :	1: fixed (backup)						
	Bit 6 :	1: fixed (backup)						
	Bit 7 :	1: fixed (backup)						
DATA01:	FAILURE MODE 2							
	Bit 0-7 :	1: fixed (backup)						

Table of Signals Supported

Supported resolution

- When the screen mode is NORMAL, each signal is converted to a 1024 dots × 768 lines signal. (Except for *^{2,3,4})
- When the screen mode is TRUE, the picture is displayed in the original resolution.
- When the screen mode is FULL, each signal is converted to a 1364 dots × 768 lines signal. (Except for *³)

Computer input signals supported by this system

Model Signal Type	Dots × lines	Vertical frequency (Hz)	Horizontal frequency (kHz)	Sync Polarity		Presence		Screen mode			RGB select* ⁵
				Horizontal	Vertical	Horizontal	Vertical	NORMAL (4:3)	TRUE	FULL (16:9)	
	640 × 400	70.1	31.5	NEG	NEG	YES	YES	YES* ²	YES	YES	--
*IBM PC/AT compatible computers	640 × 480	59.9	31.5	NEG	NEG	YES	YES	YES	YES	YES	STILL
		72.8	37.9	NEG	NEG	YES	YES	YES	YES	YES	--
		75.0	37.5	NEG	NEG	YES	YES	YES	YES	YES	STILL
		85.0	43.3	NEG	NEG	YES	YES	YES	YES	YES	--
		100.4	51.1	NEG	NEG	YES	YES	YES	YES	YES	--
		120.4	61.3	NEG	NEG	YES	YES	YES	YES	YES	--
	848 × 480	60.0	31.0	POS	POS	YES	YES	--	YES	YES	WIDE2
	852 × 480* ¹	60.0	31.7	NEG	NEG	YES	YES	--	YES	YES	WIDE1
	800 × 600	56.3	35.2	POS	POS	YES	YES	YES	YES	YES	STILL
		60.3	37.9	POS	POS	YES	YES	YES	YES	YES	STILL
		72.2	48.1	POS	POS	YES	YES	YES	YES	YES	--
		75.0	46.9	POS	POS	YES	YES	YES	YES	YES	--
		85.1	53.7	POS	POS	YES	YES	YES	YES	YES	--
		99.8	63.0	POS	POS	YES	YES	YES	YES	YES	--
		120.0	75.7	POS	POS	YES	YES	YES	YES	YES	--
		1024 × 768	60.0	48.4	NEG	NEG	YES	YES	YES* ³	--	YES
	70.1		56.5	NEG	NEG	YES	YES	YES* ³	--	YES	--
	75.0		60.0	POS	POS	YES	YES	YES* ³	--	YES	STILL
	85.0		68.7	POS	POS	YES	YES	YES* ³	--	YES	--
	100.6		80.5	NEG	NEG	YES	YES	YES* ³	--	YES	--
	1152 × 864	75.0	67.5	POS	POS	YES	YES	YES	--	YES	STILL
	1280 × 768	56.2	45.1	POS	POS	YES	YES	--	--	YES	WIDE1
	1360 × 765	60.0	47.7	POS	POS	YES	YES	--	--	YES* ³	WIDE1
	1360 × 768	60.0	47.7	POS	POS	YES	YES	--	--	YES* ³	WIDE1
	1376 × 768	59.9	48.3	NEG	POS	YES	YES	--	--	YES	WIDE2
	1280 × 1024	60.0	64.0	POS	POS	YES	YES	YES* ⁴	--	YES	STILL
		75.0	80.0	POS	POS	YES	YES	YES* ⁴	--	YES	--
		85.0	91.1	POS	POS	YES	YES	YES* ⁴	--	YES	--
1600 × 1200	60.0	75.0	POS	POS	YES	YES	YES	--	YES	--	
	65.0	81.3	POS	POS	YES	YES	YES	--	YES	--	
	70.0	87.5	POS	POS	YES	YES	YES	--	YES	--	
	75.0	93.8	POS	POS	YES	YES	YES	--	YES	--	
Apple Macintosh ⁶	640 × 480	66.7	35.0	Sync on G	Sync on G	--	--	YES	YES	YES	--
	832 × 624	74.6	49.7	Sync on G	Sync on G	--	--	YES	YES	YES	--
	1024 × 768	74.9	60.2	Sync on G	Sync on G	--	--	YES* ³	--	YES	--
	1152 × 870	75.1	68.7	Sync on G	Sync on G	--	--	YES	--	YES	--
Work Station (EWS4800)	1280 × 1024	60.0	64.6	NEG	NEG	YES	YES	YES* ⁴	--	YES	--
		71.2	75.1	NEG	NEG	YES	YES	YES* ⁴	--	YES	--
Work Station (HP)	1280 × 1024	72.0	78.1	--	--	--	--	YES* ⁴	--	YES	--
Work Station (SUN)	1152 × 900	66.0	61.8	C Sync	C Sync	--	--	YES	--	YES	--
		76.0	71.7	C Sync	C Sync	--	--	YES	--	YES	--
	1280 × 1024	76.1	81.1	C Sync	C Sync	--	--	YES* ⁴	--	YES	--
Work Station (SGI)	1024 × 768	60.0	49.7	--	--	--	--	YES* ³	--	YES	--
	1280 × 1024	60.0	63.9	--	--	--	--	YES* ⁴	--	YES	--
IDC-3000G											
PAL625P	768 × 576	50.0	31.4	NEG	NEG	YES	YES	YES* ⁷	--	YES* ⁷	--
		59.9	31.5	NEG	NEG	YES	YES	YES* ⁷	--	YES* ⁷	MOTION

-
- *1 Only when using a graphic accelerator board that is capable of displaying 852×480 .
 - *2 This signal is converted to a $1228 \text{ dots} \times 768 \text{ lines}$ signal.
 - *3 The picture is displayed in the original resolution.
 - *4 The aspect ratio is 5:4. This signal is converted to a $960 \text{ dot} \times 768 \text{ line}$ signal.
 - *5 Normally the RGB select mode suite for the input signals is set automatically. If the picture is not displayed properly, set the RGB mode prepared for the input signals listed in the table above.
 - *6 To connect the monitor to Macintosh computer, use the supplied monitor adapter (D-Sub 15-pin) to your computer's video port. If your computer has a mini D-Sub 15-pin connector, you may have to use the supplied RGB cable.
 - *7 Other screen modes (ZOOM and STADIUM) are available as well.

NOTE:

- *While the input signals comply with the resolution listed in the table above, you may have to adjust the position and size of the picture or the fine picture because of errors in synchronization of your computer.*
 - *When a $1280 \text{ dot} \times 1024 \text{ line}$ signal or $1600 \text{ dot} \times 1200 \text{ line}$ signal is input to the monitor, the picture will be compressed.*
 - *This monitor has a resolution of $1365 \text{ dot} \times 768 \text{ line}$. It is recommended that the input signal should be XGA, wide XGA, or equivalent.*
 - *With digital input some signals are not accepted.*
 - *The sync may be disturbed when a nonstandard signal other than the aforementioned is input.*
 - *If you are connecting a composite sync signal, use the HD terminal.*
-

- * "IBM PC/AT" and "VGA" are registered trademarks of IBM, Inc. of the United States.
- * "Apple Macintosh" is a registered trademark of Apple Computer, Inc. of the United States.

Troubleshooting

If the picture quality is poor or there is some other problem, check the adjustments, operations, etc., before requesting service.

Symptom	Checks	Remedy
Picture is disturbed. Sound is noisy. Remote control unit operates erroneously.	<ul style="list-style-type: none"> Is a connected component set directly in front or at the side of the display? 	<ul style="list-style-type: none"> Leave some space between the display and the connected components.
The remote control unit does not work.	<ul style="list-style-type: none"> Are the remote control unit's batteries worn out? 	<ul style="list-style-type: none"> Replace both batteries with new ones.
Monitor's power does not turn on when the remote control unit's power button is pressed.	<ul style="list-style-type: none"> Is the monitor's power cord plugged into a power outlet? 	<ul style="list-style-type: none"> Plug the monitor's power cord into a power outlet.
	<ul style="list-style-type: none"> Are all the monitor's indicators off? 	<ul style="list-style-type: none"> Press the power button on the monitor to turn on the power.
	<ul style="list-style-type: none"> Are the remote control unit's batteries worn out? 	<ul style="list-style-type: none"> Replace both batteries with new ones.
Monitor does not operate when the remote control unit's buttons are pressed.	<ul style="list-style-type: none"> Is the remote control unit pointed at the monitor, or is there an obstacle between the remote control unit and the monitor? 	<ul style="list-style-type: none"> Point the remote control unit at the monitor's remote control sensor when pressing buttons, or remove the obstacle.
	<ul style="list-style-type: none"> Is direct sunlight or strong artificial light shining on the monitor's remote control sensor? 	<ul style="list-style-type: none"> Eliminate the light by closing curtains, pointing the light in a different direction, etc.
	<ul style="list-style-type: none"> Are the remote control unit's batteries worn out? 	<ul style="list-style-type: none"> Replace both batteries with new ones.
	<ul style="list-style-type: none"> The remote cable is plugged into the REMOTE IN terminal (Wired). 	<ul style="list-style-type: none"> Unplug the remote cable from the monitor.
	<ul style="list-style-type: none"> The front panel buttons of the main unit do not function. 	<ul style="list-style-type: none"> The front panel buttons do not function during Control Lock.
No sound or picture is produced.	<ul style="list-style-type: none"> Is the monitor's power cord plugged into a power outlet? 	<ul style="list-style-type: none"> Plug the monitor's power cord into a power outlet.
Picture appears but no sound is produced.	<ul style="list-style-type: none"> Is the volume set at the minimum? 	<ul style="list-style-type: none"> Increase the volume.
	<ul style="list-style-type: none"> Is the mute mode set? 	<ul style="list-style-type: none"> Press the remote control unit's MUTE button.
	<ul style="list-style-type: none"> Are the speakers properly connected? 	<ul style="list-style-type: none"> Connect the speakers properly.
	<ul style="list-style-type: none"> Is AUDIO INPUT set correctly? 	<ul style="list-style-type: none"> Set AUDIO INPUT on the OPTION menu correctly.
Poor picture with VIDEO signal input.	<ul style="list-style-type: none"> Improper control setting. Local interference. Cable interconnections. Input impedance is not correct level. 	<ul style="list-style-type: none"> Adjust picture control as needed. Try another location for the monitor. Be sure all connections are secure.
Poor picture with RGB signal input.	<ul style="list-style-type: none"> Improper control setting. Incorrect 15 PIN connector pin connections. 	<ul style="list-style-type: none"> Adjust picture controls as needed. Check pin assignments and connections.
Tint is poor or colors are weak.	<ul style="list-style-type: none"> Are the tint and colors properly adjusted? 	<ul style="list-style-type: none"> Adjust the tint and color (under "PICTURE").
Nothing appears on screen.	<ul style="list-style-type: none"> Is the computer's power turned on? 	<ul style="list-style-type: none"> Turn on the computer's power.
	<ul style="list-style-type: none"> Is a source connected? 	<ul style="list-style-type: none"> Connect source to the monitor.
	<ul style="list-style-type: none"> Is the power management function in the standby or off mode? 	<ul style="list-style-type: none"> Operate the computer (move the mouse, etc.).
Part of picture is cut off or picture is not centered.	<ul style="list-style-type: none"> Is the position adjustment appropriate? 	<ul style="list-style-type: none"> Adjust the "SCREEN" properly.
Image is too large or too small.	<ul style="list-style-type: none"> Is the screen size adjustment appropriate? 	<ul style="list-style-type: none"> Press the "WIDE" button on the remote control unit and adjust properly.
Picture is unstable.	<ul style="list-style-type: none"> Is the computer's resolution setting appropriate? 	<ul style="list-style-type: none"> Set to the proper resolution.
POWER/STANDBY indicator is lighted in orange or red.	<ul style="list-style-type: none"> Horizontal and / or vertical sync signal is not present when the Intelligent Power Manager control is on. 	<ul style="list-style-type: none"> Check the input signal.
POWER/STANDBY indicator is blinking in red.	<ul style="list-style-type: none"> The temperature inside the main unit has become too high and has activated the protector. 	<ul style="list-style-type: none"> Promptly switch off the power of the main unit and wait until the internal temperature drops. See*1.
POWER/STANDBY indicator is blinking in green.	_____	<ul style="list-style-type: none"> Promptly switch off the power of the main unit. See *2.

*1 Overheat protector

If the monitor becomes too hot, the overheat protector will be activated and the monitor will be turned off. If this happens., turn off the power to the monitor and unplug the power cord. If the room where the monitor is installed is particularly hot, move the monitor to a cooler location and wait for the monitor to cool for 60 minutes. If the problem persists, contact your NEC dealer for service.

*2 In the following case, power off the monitor immediately and contact your dealer or authorized NEC Center.

The monitor turns off 5 seconds after powering on and then the POWER/STANDBY indicator blinks. It indicates that the power supply circuit or, one or more fans have been damaged.

Specifications

Product Name	PlasmaSync™ 50MP1 Plasma Monitor
Product Code	PX- 50XM1A
Screen Size	43.5"(H) × 24.5"(V) inches 1106(H) × 622(V) mm diagonal 50"
Aspect Ratio	16 : 9
Resolution	1365(H) × 768(V) pixels
Pixel Pitch	0.032"(H) × 0.032"(V) inches 0.81(H) × 0.81(V) mm
Color Reproduction	256 levels, 16,770,000 colors
Signals	
Synchronization Range	Horizontal : 15.5 to 93.8 kHz (automatic : step scan) Vertical : 50.0 to 120 Hz (automatic : step scan)
Input Signals	RGB, NTSC (3.58/4.43), PAL (B,G,M,N), PAL60, SECAM, HD*1 , DVD*1 , DTV*1
Input Terminals	
RGB	
Visual 1 (Analog)	mini D-sub 15-pin × 1
Visual 2 (Analog)	BNC (R, G, B, H/CS, V) × 1
Visual 3 (Digital)	DVI-I 29-pin × 1*2 (Not compatible with analog input)
Video	
Visual 1	RCA-pin × 1
Visual 2	BNC × 1
Visual 3	S ₂ -Video: DIN 4-pin × 1
DVD/HD/DTV	
Visual	RCA-pin (Y, PB[CB], PR[CR])
Audio	
	Stereo RCA × 3
External Control	
	D-sub 9-pin × 1(RS-232C)
Sound output	7W+7W at 6 ohm
Power Supply	AC120V 50/60Hz
Current Rating	5.9A (maximum)
Power Consumption	595W (typical)
Dimensions	48.8 (W) × 30.2 (H) × 4.2 (D) inches 1240 (W) × 766 (H) × 107(D) mm
Weight	101.3 lbs / 46.0 kg
Environmental Considerations	
Operating Temperature	0°C to 35°C / 32°F to 95°F
Humidity	20 to 80%
Storage Temperature	-10°C to 50°C / 14°F to 122°F
Humidity	10 to 90%
Front Panel User Controls	Power on/off, Input source select, Volume up/down/ OSM control
Remote Control Functions	Power on/off, Input source select, OSM control, Volume up/down, Cursor (UP, DOWN, LEFT, RIGHT), Pointer, Zoom up/down, Off timer, Wireless/ Wired remote control
OSM Functions	Picture (Contrast / Brightness / Sharpness/ Color / Tint / Picture mode / Color temperature/ Noise reductions), Sound (Bass / Treble/ Balance), Screen (V-Position / H-Position/ V-Height / H-Width / Auto Picture / Fine picture/ Picture adjustment), Function (OSM/ OSM adjustment/ Power management/ Gray level/ Cinema mode/ RGB3 Adjustment, Long Life (PLE, Orbiter, Inverse)/ Reset)/ Option (Audio input/ BNC select/ RGBselect/ HD select/ Picture Size), Information (Frequency / Language / Color system)

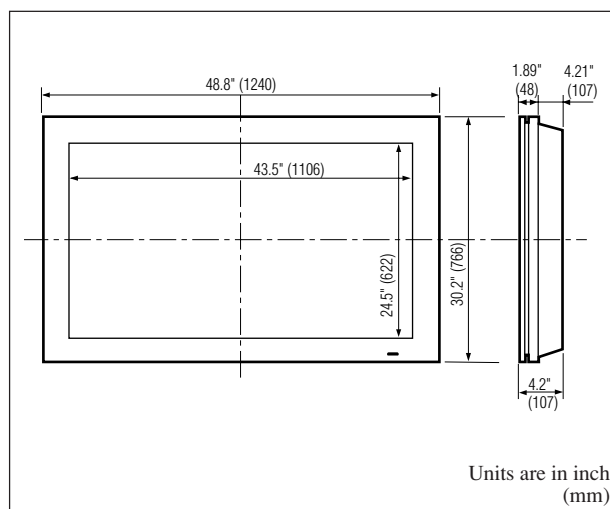

The features and specifications may be subject to change without notice.

*1 HD/DVD/DTV input signals supported on this system

480P (60 Hz)	480I (60 Hz)
525P (60 Hz)	525I (60 Hz)
625P (50 Hz)	625I (50 Hz)
720P (60 Hz)	1035I (60 Hz)
	1080I (60 Hz)

*2 It doesn't cope with copy protection.

Other Features	Power management, plug and play (DDC1, DDC2b, RGB3: DDC2b only), Control lock, MULTI SCREEN operations
Accessories	Remote control unit with two AAA batteries, Remote cable, Adapter for Macintosh, RGB cable (Mini D-Sub 15-pin to Mini D-Sub 15-pin connector), Power cord, User's Manual, Safety metal fittings, Screws for safety metal fittings, Ferrite cores, Bands
Regulations	UL Approved (UL 1950/ CSA 950) DOC Canada requirements Meets FCC class A requirements



NEC

NEC Technologies, Inc.
1250 N. Arlington Heights Road, Suite 500
Itasca, Illinois 60143-1248

Printed on recycled paper

Printed in Japan
7S800062

Free Manuals Download Website

<http://myh66.com>

<http://usermanuals.us>

<http://www.somanuals.com>

<http://www.4manuals.cc>

<http://www.manual-lib.com>

<http://www.404manual.com>

<http://www.luxmanual.com>

<http://aubethermostatmanual.com>

Golf course search by state

<http://golfingnear.com>

Email search by domain

<http://emailbydomain.com>

Auto manuals search

<http://auto.somanuals.com>

TV manuals search

<http://tv.somanuals.com>