

NEC LCD2180WG-LED

Technical Background and Feature Overview



SpectraView[™] II

NEC NEC Display Solutions

Unparalleled display performance for your

COLOR-CRITICAL

applications.

Designed from the ground up with more than 3 years of research and development, and featuring many ground-breaking technologies never before available on a consumer display, the 21.3" LCD2180WG-LED represents NEC's flagship color reference display. This display is aimed directly at the professional color market where screen brightness, color gamut, uniformity, stability and repeatability are of the utmost importance.

The LCD2180WG-LED is the first commercial display to feature individual high power red, green and blue LEDs (Light Emitting Diodes) as a backlight source for the LCD, instead of the typical CCFL (Cold Cathode Fluorescent Lamp). This significant change, made possible by the recent advances in LED light output and efficiency, pro-

vides remarkable increases to the output color gamut, as well as to the fidelity to which screen colors can be adjusted.

This increase in displayable color gamut opens up an entirely new era of color workflow in which the display screen can be trusted to accurately represent the colors that were captured, edited and will be output, be it on print, film or other media.

Recent advances in digital image capturing devices, such as digital cameras, are now capable of offering expanded color gamuts, such as AdobeRGB, as a standard color space. At the same time, ink jet printers are now capable of reproducing colors from very large color gamuts. As this technology gets better and becomes more

accessible, the need for accuracy in viewing and soft-proofing color is increasing as well.

Whereas traditional displays were typically limited to a color gamut of sRGB, the color gamut of the LCD2180WG-LED exceeds that of even the AdobeRGB colorspace. This means that the display is no longer the limiting factor for color gamut within a typical color workflow. The color workflow can be simplified by reducing or even eliminating the need to make color output proofs, as is typically needed with a traditional display in order to accurately check colors that are outside the display's color gamut. This represents a significant benefit in time and cost savings.

The need for enhanced color gamut displays

These images were captured on a standard digital camera in AdobeRGB colorspace. The gray areas in the photographs show the out of gamut colors when the images are viewed on a typical sRGB display monitor. It is impossible to display these colors on such a monitor.

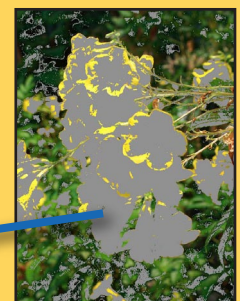
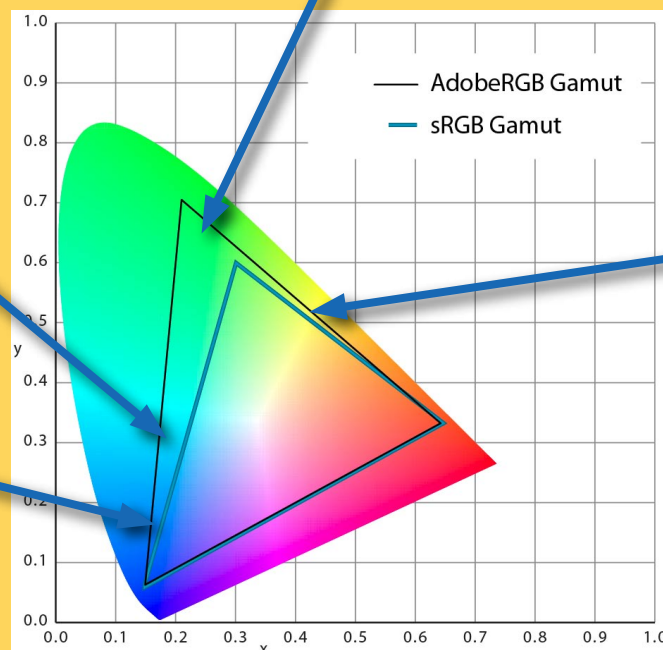
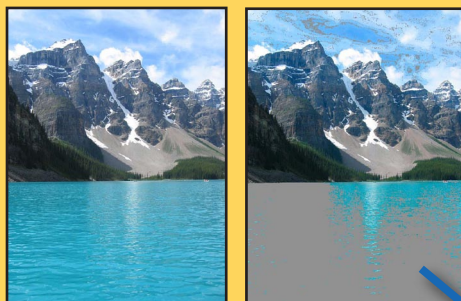

Color Gamut of a Display

Color displays are additive color devices. Color is formed by adding different proportions of red, green and blue light. These primary colors are formed by the glow of different types of phosphors in the case of a CRT display, or by filtering white light into red, green and blue on an LCD.

- Red + Green = Yellow
- Green + Blue = Cyan
- Blue + Red = Magenta
- Red + Green + Blue = White

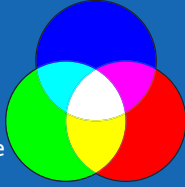

The color gamut of a display is limited by how pure in color the red, green and blue primaries are.

When viewed on a CIE xy color chart (a 2 dimensional plot of all colors visible to the human eye), the red, green, and blue primary colors together form a triangle. Colors outside of this triangle are outside of the displayable color gamut.

The size and position of the triangle are determined by the purity of the primary colors. The purer the color, the closer it is to the edge of the CIE horseshoe. Colors along the edge of the horseshoe are made up of pure monochromatic light.

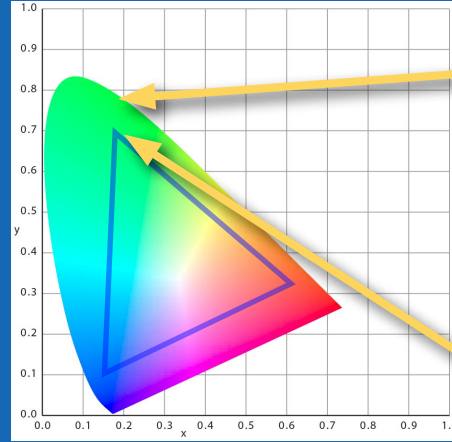

The largest possible color gamut using 3 colors would be obtained by using 3 monochromatic light sources such as LASERS.

When a light source is viewed as a spectrum, it is possible to see the relationship between its spectrum and position on the CIE color chart.

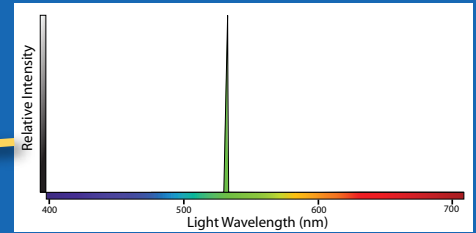

Monochromatic Light lies along the edge of the CIE horseshoe

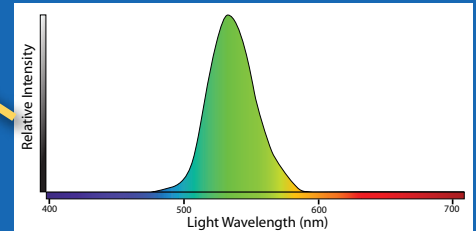

Light made up of a broader spectrum lies inside the CIE horseshoe.

LCD Operation and Color Gamut

With an LCD display, the color gamut is determined by a combination of the light source used to illuminate the LCD panel (known as the backlight) and of the LCD panel itself.

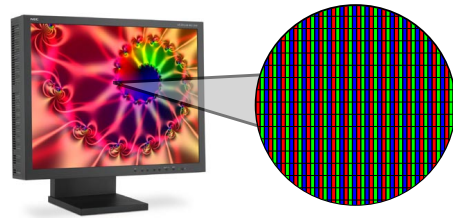

LCD Screen Sub-Pixel Structure

Each pixel on the screen is made up of red, green and blue sub-pixels. The colors of these sub-pixels are made by passing the backlight through a color filter array. The characteristics of these color filters in part determine the gamut of the display.

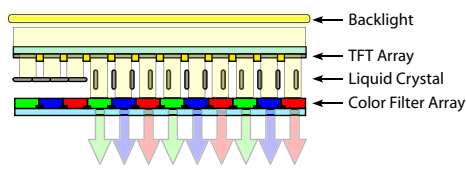

LCD Color Filter Array

Typical LCD monitors use a broad-band light source such as CCFLs, which radiate a wide spectrum of colors, including unwanted colors such as oranges, yellows, cyans. Only the pure red, green and blue parts of the backlight spectrum are wanted in order to maximize the color gamut of the display.

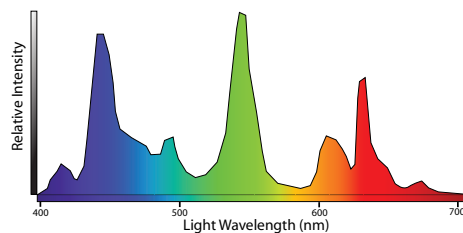

Typical CCFL Backlight Spectrum

In order to achieve a larger color gamut, it would be necessary to filter the backlight into a narrower spectrum of colors thus producing purer red, green and blue. However, filtering into a narrower spectrum is a technological challenge and doing so also reduces the total amount of light that is transmitted through the filter. This means that the overall screen luminance is reduced or must be compensated for by using more CCFL backlights.

The LCD2180WG-LED avoids the need for narrower spectrum color filters by fundamentally changing the spectrum of the backlight source. By using red, green and blue power LEDs, which output a very narrow spectrum of light, a huge gain in displayable color gamut can be achieved without the need for using narrower color filters on each sub-pixel.

It is important to understand that the backlight for the LED based display is still "white" light, but it is made up of very narrow-band red, green and blue light, which when combined together, is perceived by the human eye as white light. If this light were to be shown as a rainbow spectrum using a prism, only the red, green and blue portions of the rainbow would be seen.

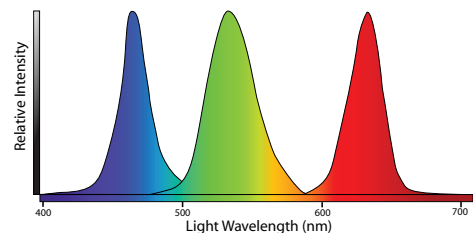

Combined LED Backlight Spectrum

The LCD2180WG-LED display further increases the displayable color gamut by using a custom modified color filter on the blue sub-pixels reducing the amount of cyan that passes through. This has the effect of increasing the blue gamut beyond that which is achievable using a blue LED and standard blue filter.

See diagram on page 9 for a more detailed explanation of how the wide color gamut is achieved and how it compares to a typical CCFL display.

LED Backlight

The backlight source for the display is a linear array of 48 individual red (18), green (20) and blue (10) power LEDs. The light from these LEDs is combined together to form white light, which is the backlight source for the LCD panel.

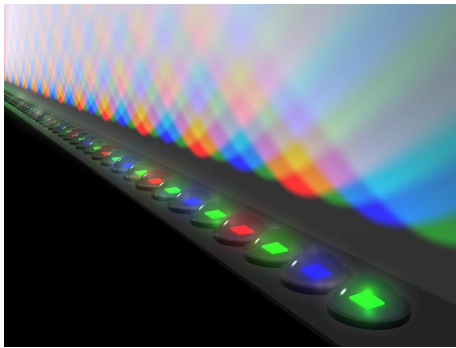

Red, Green and Blue LED Array

Each LED that is used in the LCD2180WG-LED display is individually chosen using a rigorous screening process for color spectrum and luminance output in order to achieve the maximum possible color gamut and color uniformity across the display screen. Only a very small fraction of the LEDs produced by the manufacturer are deemed acceptable and chosen for use in the display.

Folded Light Guide Design

In order to allow the light from the individual red, green and blue LEDs to mix together and appear as a single white light source, the display features a folded light guide design. Light from the row of alternating colored LEDs is fed through a light guide and curved mirrors at the rear of the display.

This allows the light from the individual LEDs a greater distance in which to mix together, thus giving a much more uniform light source without significantly increasing the depth of the display.

AdobeRGB and beyond

Many mainstream output devices such as ink jet printers can now produce colors that lie outside of even the AdobeRGB colorspace.

The gamut of LCD2180WG-LED exceeds AdobeRGB in the red and magenta areas, making it possible to view colors beyond AdobeRGB.

The LCD2180WG-LED display complies with the new AdobeRGB (1998) Reference Viewing Environment specification. A preset for matching the AdobeRGB color gamut is available via the On Screen Display menu.

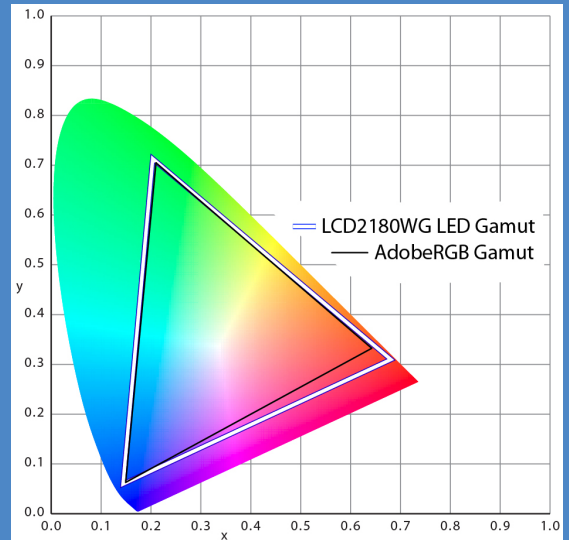

Folded Light Guide and LED Array

increased intensity of the display makes direct comparisons a reality.

Display Lifetime

Commercial LEDs have been around since the early 1960s, however it is only within the last 10 years that blue LEDs have become available, and only within the last couple of years that ultra high brightness LEDs capable of replacing CCFLs have become available with a comparable power consumption. One of the major benefits of LEDs, besides the narrow output spectrum, is the long lifetime of typically 50,000 hours. This compares to a typical CCFL based display lifetime of 25,000 hours.

Display White Point

The intensity of the red, green and blue LEDs can be individually controlled, allowing the white point or color temperature of the resulting white light to be adjusted. This represents a major advantage over traditional LCD displays that utilize a CCFL backlight with a fixed color temperature.

In a traditional LCD display, the only way to adjust the white point of the screen is by using a look-up-table, which resides either in the host computer's video graphics adapter or internally to the display itself.

Changing the white point from the display's native white point means that one or two colors have to be reduced in luminance using the look-up-table. This means that fewer displayable colors

Luminance

When compared to CRT monitors, the high brightness of the power LED backlight allows for a much higher screen intensity (brightness) to be used. A typical intensity of 160 cd/m², regardless of the white point setting, allows the display to be used where traditionally a darkened room was necessary. Also where direct side-by-side comparisons with print samples in a light box were previously difficult due to the difference in luminance, the

are possible due to the look-up-table being used to compensate for the white point. Depending on the display's native white point and the desired white point, a significant number of displayable colors may be lost leading to color banding issues. This is especially true for displays that do not feature programmable internal look-up-tables with a depth of 10 bits or more.

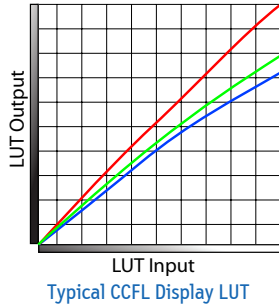

However with the LCD2180WG-LED display, the white point is adjusted by directly varying the brightness of the red, green and blue LEDs. This means that the full range of the internal 10 bit look-up-tables is available for performing response curve and gamma adjustments.

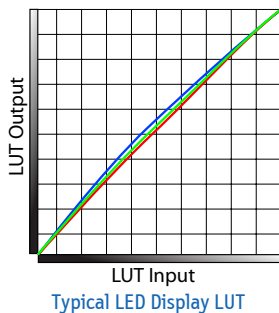

Additionally, with traditional LCD displays, the native white point of the backlight source is fixed, and the white point is adjusted using look-up-tables. Therefore, the greyscale color tracking of the display is often poor, especially for very dark colors. This is because for very dark colors including black, no color corrections are possible using the look-up-table. The color of black on the screen will be the color of the backlight source that leaks through the LCD panel, which may differ from the desired white point.

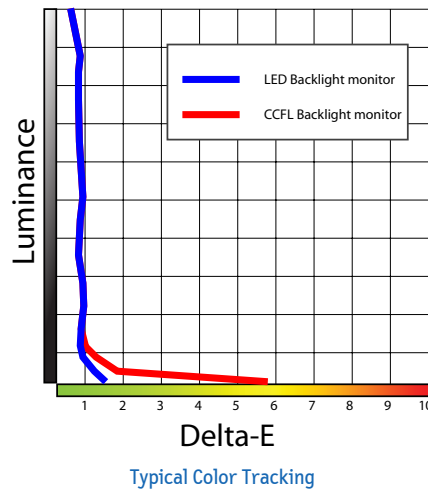

With the LED backlight, the white point of the entire backlight source is changed by varying the intensity of the red, green and blue LEDs. So the color of absolute black on the screen will be much closer to the intended white point. This provides vastly improved greyscale color tracking.

Another advantage of the LED Backlight is that the contrast ratio of the display remains almost constant as the white point is changed in intensity and color. This is because the intensity and color of black will also change due to the entire backlight source being adjusted, rather than having a fixed backlight and LUT adjustment with a typical LCD display.

Gamut Mapping/Emulation

While the native color gamut of the display exceeds that of even AdobeRGB, it is sometimes necessary to preview images as they would be seen on a display with a smaller colorspace. The LCD2180WG-LED has presets for emulating displays with both sRGB and AdobeRGB gamuts by using internal color gamut mapping. These presets can be selected with the touch of a button and will transform the displayed image into either sRGB or AdobeRGB gamuts.

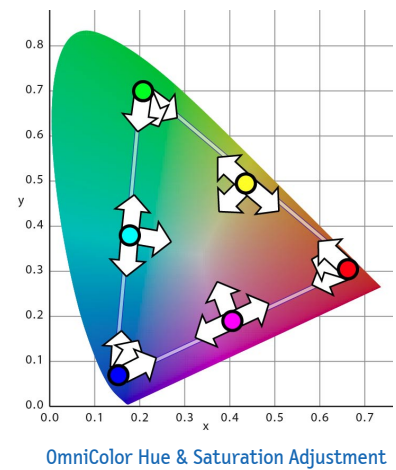

10 Bit Look Up Tables

Since the LCD2180WG-LED has internal 10 bit Look Up Tables (LUTs), that can be programmed by the calibration software, the 8x8 bit LUT on the Host Computer can be set to linear. This means that no steps are lost in an 8x8 LUT and subsequent 8 bit DVI bottleneck (assuming 10 bit DVI functionality is not used).

Also, since the white point of the display is controlled directly by varying the intensity of the Red, Green and Blue LEDs, the 10 bit LUTs in the display are only used for gamma/ tone response curve corrections. This preserves the maximum number of discrete color levels.

On a traditional CCFL display monitor, the 8x8 LUT on the host computer is used for both white point and gamma/ tone response curve corrections. This means a loss in the total number of discrete color levels which can lead to color banding issues.

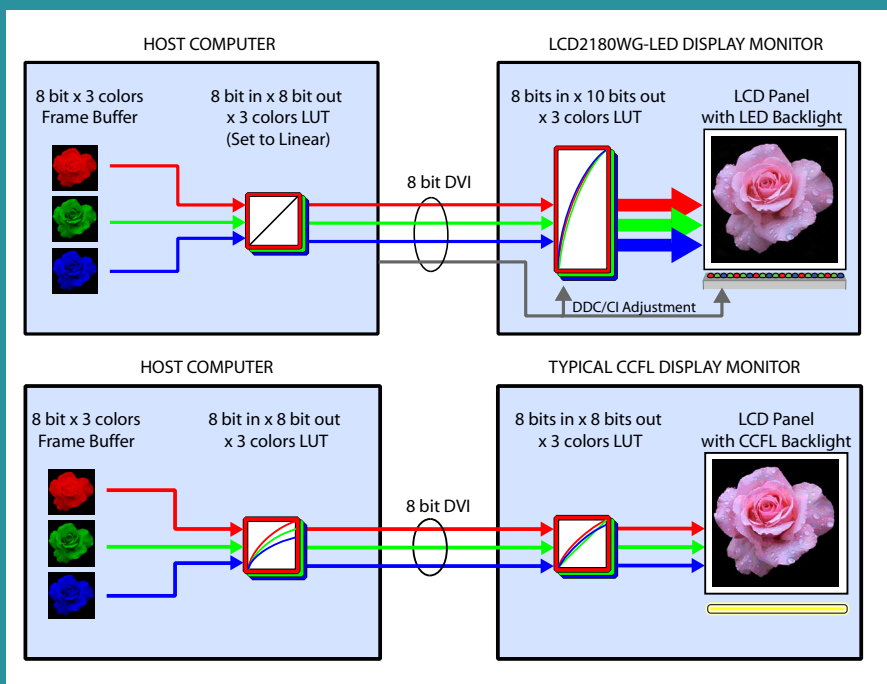

If necessary, custom gamuts can be achieved by manual adjustment of the display using its advanced 6-axis color hue and saturation controls.

These controls allow the hue and saturation of red, yellow, green, cyan, blue and magenta areas of the color gamut to be manipulated independently.

Color Stability

While LEDs have excellent light output and lifetime characteristics, they are inherently unstable devices and have very strong temperature and supply current dependencies. This would normally make LEDs unsuitable for color critical applications where a change in luminance of just a fraction of a percentage would produce an unacceptable color or luminance shift.

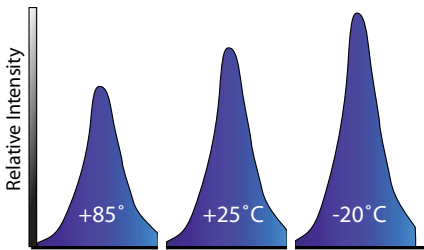

Uncompensated Light Output vs Temperature

Therefore the LCD2180WG-LED display employs a unique internal optical feedback system which constantly measures both the luminance and color of the LED backlight source and automatically corrects for any short or long term changes. This means that the backlight source is constant and the screen can be used for critical color work within a couple of minutes of powering on the display. Short term changes such as the display warming up, and longer term changes such as aging decreasing the efficiency of the LED, are automatically compensated for.

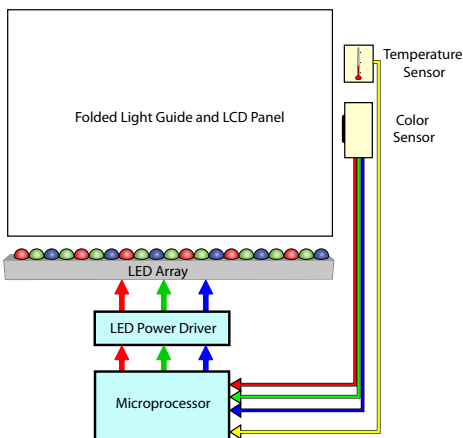

Optical Feedback System

While other CCFL based LCD displays may claim to have similar optical feedback systems, they typically only monitor the luminance of the backlight source and not its true white point. CCFLs have an operating temperature vs output color spectrum dependency which can produce a change in the white point of the display as it warms up to operating temperature; even if the overall luminance is compensated using a luminance based optical feedback system.

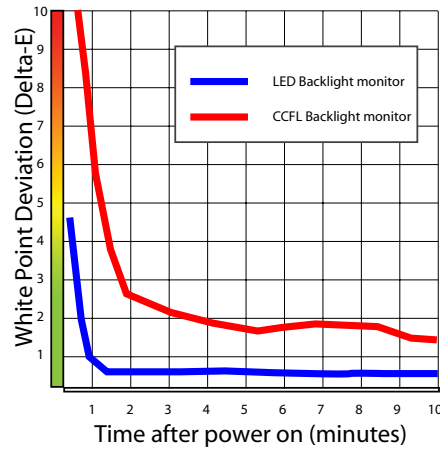

Color Stability Comparison

Temperature Compensation

The LCD2180WG-LED features a unique temperature compensation system that constantly monitors the internal temperature of the display and corrects for changes in the LCD panel color characteristics due to temperature shifts as well as changes in the sensitivity of the internal optical feedback sensor. This compensation allows the display to achieve an unparalleled level of color stability even as it warms up to full operating temperature. This means that the display can then be used for color critical work within a couple of minutes of turning on, compared to up to 30-60 minutes for conventional displays.

Mura Compensation

All display monitors have some form of screen uniformity errors, or mura, across the display area due to a combination of non-uniformities in the LCD panel itself, and the LCD backlight system. This non-uniformity can be seen as combination of shifts in color and/or luminance, which, depending on the severity, may be very noticeable and appear as uneven areas of color across the display.

The LCD2180WG-LED introduces a new screen uniformity compensation and correction system

called ColorComp which aims to reduce any screen uniformity errors to almost unnoticeable levels. This system works by applying a digital correction to each pixel on the screen to compensate for differences in color and luminance.

Each display is individually characterized during production using a fully automated system which measures hundreds of points across the screen at different grey levels. These measurements are used to build a three dimensional correction matrix for the display screen which is then stored inside the display. This data is used to compensate for the screen uniformity, not only as a function of position on the display screen, but also as a function of grey level.

If desired, the ColorComp correction can be turned off in order to maximize the screen brightness.

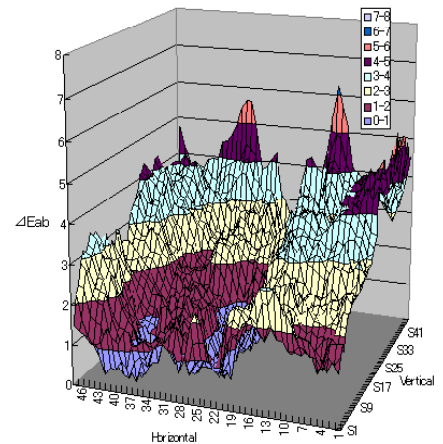

Example Uniformity Without Correction

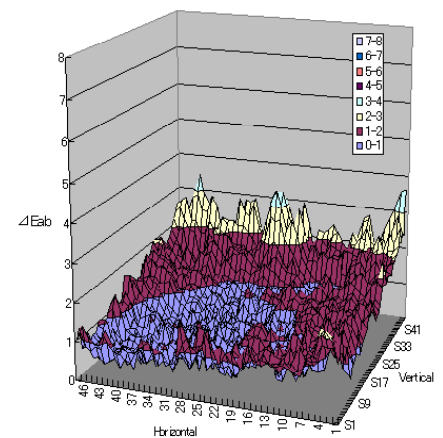

Uniformity With ColorComp Correction

Dual Video Inputs

The LCD2180WG-LED has two DVI video inputs for connecting to two different host computers. The input can be switched with the touch of a button.

The need for 10 bit color depth

The increased color gamut of the display means that the overall color “volume” of displayable colors has increased significantly. However the number of discrete color levels from the host system has not changed from the standard 16+ million colors, unless video graphics adapters, applications and Operating Systems, that all support 10 bit graphic processing are used.

This means that there are fewer discrete displayable color levels per unit of color volume on a wide gamut display than on a standard gamut display, which can lead to color banding issues.

Due to the LCD2180WG-LED being able to use the red, green and blue LED intensity to adjust the white point, rather than sacrificing displayable color levels using look-up-tables, this loss does not present a significant problem. However the display will be able to take advantage of future generations of video graphics adapters, applications and Operating Systems that are capable of outputting video with the full 10 bit digital video depth that the display is capable of accepting, thus providing an end-to-end color palette of up to more than 1,000,000,000 displayable colors.

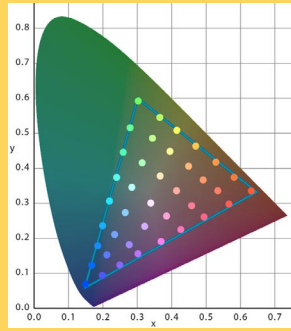

Normal color gamut display showing available discrete colors with 8 bit video (number of colors reduced for purposes of explanation)

The same number of discrete colors on a wide color gamut display occupy a larger volume.

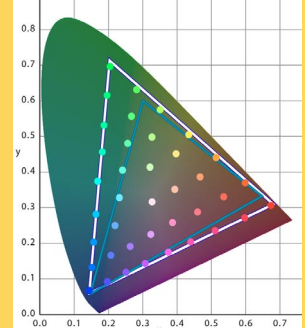

When 10 bit video is used instead of 8 bit, up to 64 times as many discrete colors are available.

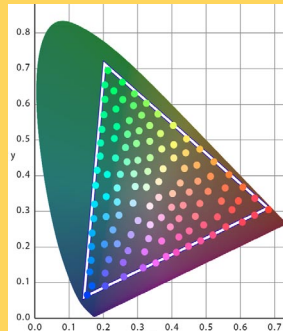

10 Bit Interface

The LCD2180WG-LED features a video input that supports 10 bit digital video using a single Dual-Link DVI cable. This means that the full capabilities of the 10 bit display can be realized without being restricted to an 8 bit video input source.

While there are not currently any mainstream video graphics adapters or operating systems that support full 10 bit video processing and output, the LCD2180WG-LED display is designed for future compatibility and leads the way to the time when 10 bit video will become mainstream.

Advanced FRC

The LCD panel on the LCD2180WG-LED display achieves an effective output of 10 bits per color by using an advanced Frame Rate Control dithering algorithm. As with other 10 bit color displays, the panel supports the most significant 8 bits of video directly and the 2 least significant bits are displayed by using a time-domain dithering method known as Frame Rate Control, in which pixels are changed in intensity according to the level of the 2 lower bits at a rate that is faster than the human eye can perceive. This time-domain dithering is further enhanced by

using a special spatial algorithm that ensures that adjacent pixels operate at different parts of the Frame Rate Control cycle thus making any artifacts of the Frame Rate Control process imperceptible.

Passive Cooling

The power LEDs used in the display dissipate heat during operation. The display uses a combination of a large heat sink with convection cooling to maintain the temperature of the display. This eliminates the need for a cooling fan which would introduce acoustic noise.

Mercury Free Design

Unlike CCFL backlight based displays, which contain mercury vapor inside the florescent lamps, thereby restricting the usage in certain operating environments, the LCD2180WG-LED display is mercury free and RoHS compliant.

Color Calibration

The optional SpectraView_{II} color calibration package offers further enhancements by providing a wide array of functions and features for calibrating, profiling and monitoring the status of the display.

The SpectraView_{II} software communicates with the display directly using Display Data Channel - Command Interface (DDC/CI), which is a two-way communications link between the video graphics adapter and display monitor that uses the standard video signal cable. No extra cables are necessary. All adjustments to monitor settings are performed automatically using this communications link.

The LCD2180WG-LED features three internal 10 bit LUTs (one for each color) that are programmed directly by SpectraView_{II} via DDC/CI. These tables allow very precise adjustments to be made to the display's Tone Response Curve without significantly reducing the number of displayable colors. Because all of the Tone Response Curve adjustments are done in a 10 bit domain within the display itself, the host computer's video graphics adapter's LUTs are set to linear, thus maximizing the use of the 16+ million color palette in an 8 bit color system.

The software allows custom target calibrations to be created with preset or user definable white points, intensity levels and tone response curves (gamma curves). Advanced tone response curves

such as DICOM, used for medical imaging, are also available.

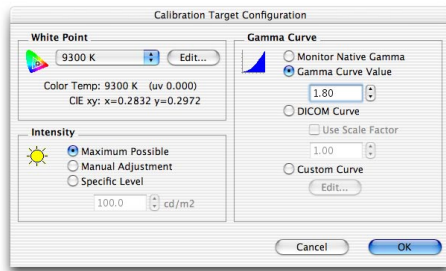

Calibration Target Configuration

At the end of each monitor calibration procedure, the display is automatically profiled and highly accurate ICC/ColorSync color profiles are generated and automatically registered with the Color Management System. These profiles use the Bradford Chromaticity Adaptation matrix.

Target and actual measured results are analyzed and displayed, showing a wealth of information about the display such as the measured color gamut, greyscale color tracking, Delta-E, and luminance values. Additional information about the display monitor such as the model name, serial number and the total number of hours that it has been in use are also displayed.

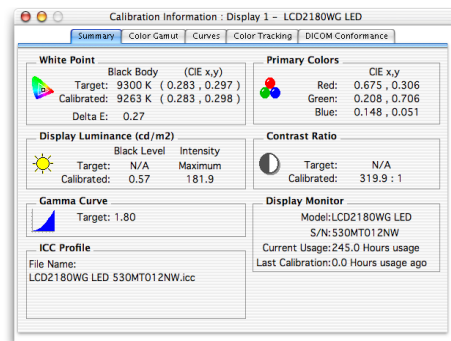

Calibration Results Summary

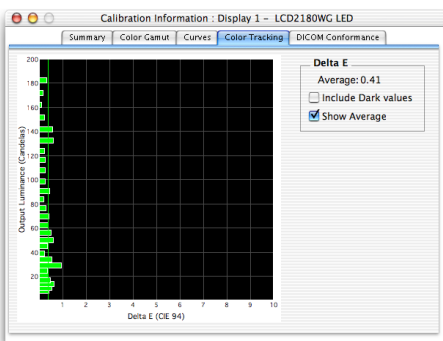

Color Tracking Report

Once SpectraView_{II} has calibrated the display, the OSD (On Screen Display) controls can be locked to prevent accidental or unauthorized adjustment which may invalidate the calibrated state of the monitor.

The software features a Colorimeter function which allows direct measurements to be taken by the color sensor and the results displayed in a variety of different formats.

The SpectraView_{II} software integrates with the NEC NaViSet Administrator network software (Available separately from your NEC representative. Windows platform only) to provide remote network access and monitoring of display monitors. NaViSet Administrator is able to read, display, and log the current calibration settings and status of displays on a LAN. This feature is particularly useful for large installations where central monitoring and asset management is needed.

Workflow Challenges With Wide Color Gamut Displays

The use of a wide color gamut display is not without its challenges. Many people who have used a wide gamut display have come to realize that while it is now possible to display colors that were otherwise unable to be previewed on-screen, challenges in other areas emerge.

For example, with being able to see colors on the screen that were never before possible to display, it is now easy to see problem areas in other parts of the color workflow such as deficiencies in printer or separation profiles.

The issue of having to continue to use some legacy standard color gamut displays and un-tagged source images in a color workflow is another challenge.

Also it now becomes essential to utilize a color management system with the display, by the correct use of ICC/ColorSync display profiles. Without the use of a color management system, all colors are mapped to the larger color gamut of the display. This results in images that appear to be super-saturated and distorted in color.

Accurate color profiles of the display allow the color management system to correctly map the source image gamut into the color gamut of the display.

Color Measurement

The output color spectrum of the LCD2180WG-LED display presents a unique challenge to the current generation of colorimeter devices which were never designed to be used on such a display, just as LCD displays were a challenge to colorimeters that were only designed for CRT displays.

To overcome this, the optional SpectraView_{II} color calibration package for the LCD2180WG-LED display includes a custom calibrated Gretag iOne Display V2 colorimeter that has been specifically calibrated for accurate measurement of the display. The device can continue to be used to measure standard LCD displays as well, if a multi-monitor configuration is used.

NEC is actively working with manufacturers of colorimeter devices to ensure that their future standard products are able to accurately measure the color characteristics of wide color gamut displays.

While the LCD2180WG-LED ships with color profiles for the factory preset color settings, the use of a color calibration package is normally essential for accurate custom calibration and profiling of the display.

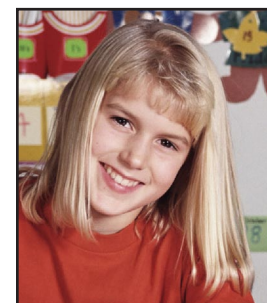

Sample Image

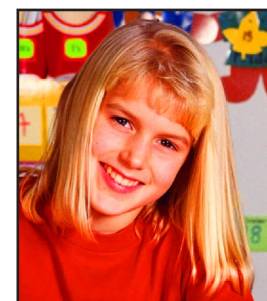
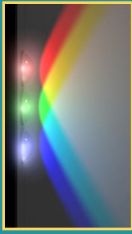

Image Displayed Without Color Management

Comparison of LED and CCFL Backlight Color Gamuts

LED Backlight



Light from Red, Green and Blue LEDs is combined in the folded light guide.

White light is filtered back into Red, Green and Blue sub-pixels. The modified blue filter further enhances blue spectrum.

Resulting spectrums are very pure which gives a very wide color gamut.

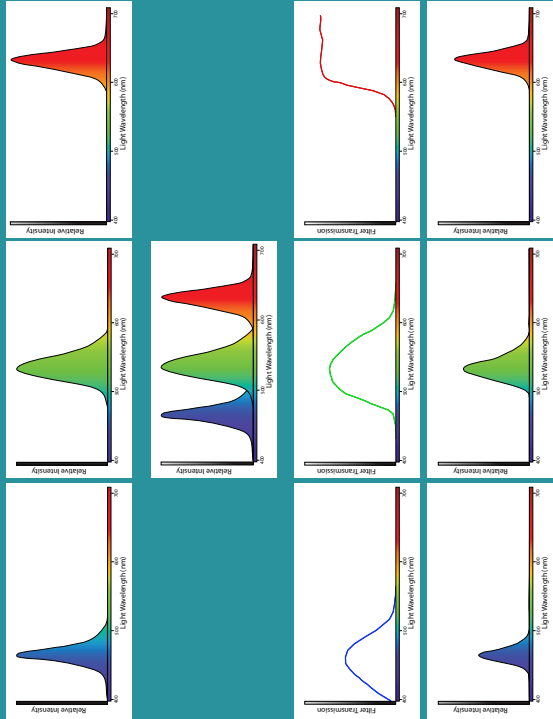

Typical CCFL Backlight

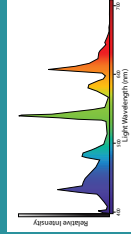

White light from CCFL is filtered back into Red, Green and Blue sub-pixels.

Resulting spectrums contain unwanted colors such as yellow, cyan and orange which reduces the color gamut.

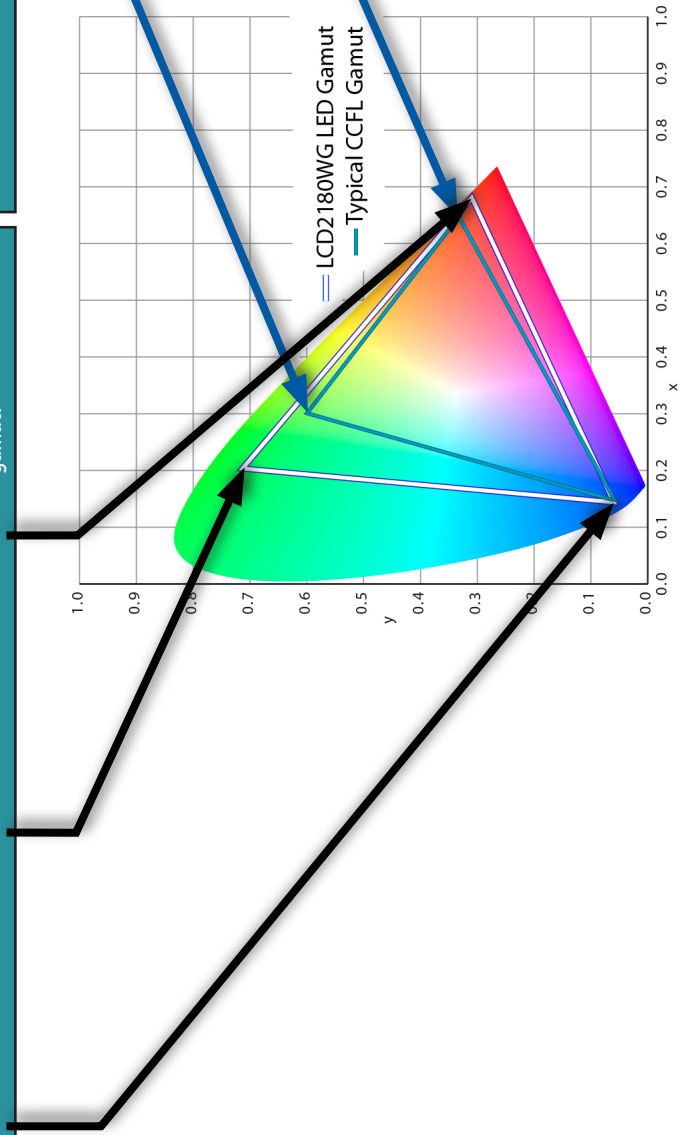
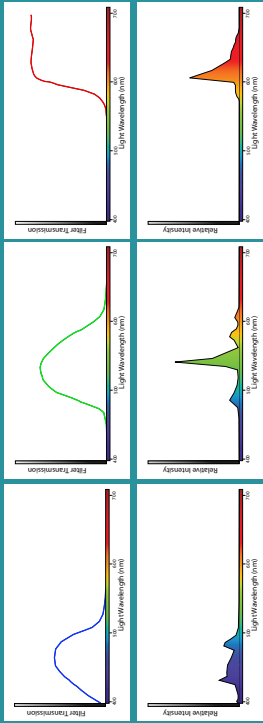

Why not use white LEDs?

White LEDs typically emit white light by using either a blue LED with a yellow phosphor coating, or an ultra-violet LED with a mix of red, green and blue phosphor coatings. The spectrum of the white light has many of the drawbacks of using a CCFL backlight and does not produce a wide color gamut.

Additionally, the white point, or color temperature, of the white LED output is fixed. Therefore the advantage of being able to adjust the white point by varying the individual red, green and blue LED intensities would be lost.

Model	LCD2180WG LED (LCD2180WG-LED-BK-SV)
Display	Viewable Size Image Pixel Pitch Pixels Per Inch Brightness (typical) Contrast Ratio (typical) Viewing Angle (typical) Response Time (typical) Display Colors
Color Chromaticities CIE x,y (typical)	Red Green Blue
Color Scale Achievement	NTSC Adobe RGB
Video Input	DVI-D (2), 10 bit video supported on Input 2.
Synchronization Range	Horizontal Vertical
Resolutions Supported	DIGITAL 1600 x 1200 @ 60 Hz
Recommended Resolution	1600 x 1200
Additional Features	Ultra-thin frame (bezel), tilt base, XtraView+ wide-angle viewing technology, cable management, ColorComp screen uniformity correction, 0mniColor 6-axis color control, 10-bit video input (using DualLink DVI), sRGB and Adobe RGB color-space emulation, digital controls, vacation switch, power-off timer, color temperature mode, serial number display, Rapid Response, ISO 13406-2
Touch-Capable	No
Voltage Rating	100-240V @ 50-60 Hz
Power Consumption (typical)	On Power Savings Mode
Dimensions (WxHxD)	Net (with stand) Net (without stand)
Net Weight	(with stand) (without stand)
VESA Hole Configuration Specifications	100 x 100mm
Environmental Conditions	Operating Temperature Operating Humidity Operating Altitude Storage Temperature Storage Humidity Storage Altitude
Regulatory Approvals	UL/C-UL or CSA, FCC Class B/Canadian DOC, TUV GS, TUV Ergonomie, CE
RoHS Compliant	Yes
Optional Accessories	SpectraView _{ii} Color Calibration Kit (custom-calibrated colorimeter and software)*, hood
Limited Warranty	3 years parts and labor, including backlight
Technical Support	24 hours/7 days

SpectraView _{ii} Requirements	Mac OS	Microsoft Windows
Operating System	Apple Mac OS X v10.2 or higher.	Microsoft Windows 2000, XP, or Server 2003, 64 bit versions of Windows XP are not currently supported.
Video Graphics Card	All Apple standard video graphics cards, including most newer PowerBooks with a DVI-D output connector.	ATI Radeon, Nvidia, Matrox, 3DLabs and others. Check website for further information.
Video color depth	At least 24 bit color (Millions of colors).	At least 24 bit color.
Supported Color Sensors	GretagMacbeth Eye-One display V1 and V2, Eye-One Monitor, Eye-One Pro, Monaco Optix [®] (X-Rite DTP 94).	GretagMacbeth Eye-One display V1 and V2, Eye-One Monitor, Eye-One Pro, and Spectrolino, Monaco Optix [®] (X-Rite DTP 94).
USB	At least one available USB port for Color Sensor.	At least one available USB port for Color Sensor, or one RS232 port if using the Spectrolino.

* Monitor available as bundled solution with SpectraView_{ii} Color Calibration Kit, which includes custom calibrated Gretag iOne Display V2.

Advanced No Touch Auto Adjust, Ambix+, AutoBright, GammaComp, NaViSet, Rapid Response, SpectraView_{ii}, TileMatrix and TileComp are trademarks of NEC Display Solutions. All other brand or product names are trademarks or registered trademarks of their respective holders. Product specifications subject to change. 12/05 ver. 2.

©2005 NEC Display Solutions of America, Inc.
All rights reserved.

NEC Display Solutions

500 Park Boulevard, Suite 1100
Itasca, IL 60143
866-NEC-MORE
www.necdisplay.com

Empowered by Innovation

NEC

Free Manuals Download Website

<http://myh66.com>

<http://usermanuals.us>

<http://www.somanuals.com>

<http://www.4manuals.cc>

<http://www.manual-lib.com>

<http://www.404manual.com>

<http://www.luxmanual.com>

<http://aubethermostatmanual.com>

Golf course search by state

<http://golfingnear.com>

Email search by domain

<http://emailbydomain.com>

Auto manuals search

<http://auto.somanuals.com>

TV manuals search

<http://tv.somanuals.com>