

User's Manual

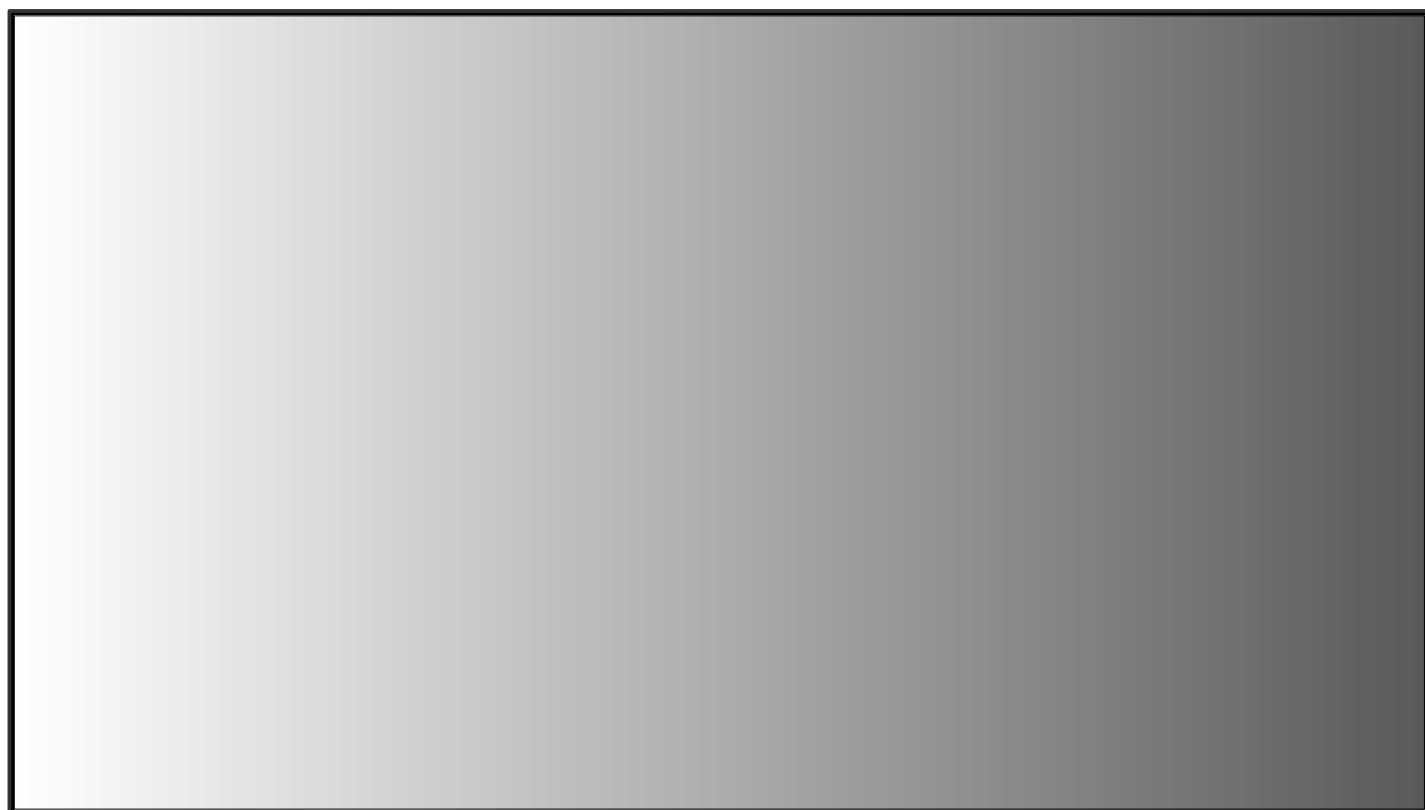

MultiSync X461UN

Index

Declaration of conformity	English-1
Important Information	English-2
WARNING, CAUTION	English-2
Declaration	English-2
Safety Precautions, Maintenance & Recommended Use	English-3
Contents	English-4
Installation	English-5
Parts Name and Functions	English-7
Control Panel	English-7
Terminal Panel	English-8
Wireless Remote Control (Optional)	English-10
Operating Range for the Option Remote Control	English-11
Handling the remote control	English-11
Setup	English-12
Connections	English-14
Wiring Diagram	English-14
Connecting a Personal Computer	English-15
Connecting a DVD Player with HDMI out	English-15
Basic Operation	English-16
Power ON and OFF Modes	English-16
Power Indicator	English-17
Using Power Management	English-17
Selecting a video source	English-17
Picture Aspect	English-17
Information OSD	English-17
Picture Mode	English-18
OSD (On-Screen-Display) Controls	English-19
PICTURE	English-20
ADJUST	English-20
AUDIO	English-21
SCHEDULE	English-21
PIP	English-22
OSD	English-22
MULTI DISPLAY	English-23
DISPLAY PROTECTION	English-24
ADVANCED OPTION	English-24
Remote Control Function	English-27
Controlling the LCD monitor via RS-232C Remote Control	English-29
Controlling the LCD monitor via LAN Control	English-30
Features	English-33
Troubleshooting	English-34
Specifications	English-35
Pin Assignment	English-36
Manufacturer's Recycling and Energy Information	English-37

Declaration of conformity

For USA

FCC Information

1. Use the attached specified cables with the MultiSync X461UN (L468TP) color display so as not to interfere with radio and television reception.
 - (1) Please use the supplied power cord or equivalent to ensure FCC compliance.
 - (2) Please use a good quality shielded video signal cable.Use of other cables and adapters may cause interference with radio and television reception.
2. This equipment has been tested and found to comply with the limits for a class A digital device, pursuant to Part 15 of the FCC Rules. These limits are designed to provide reasonable protection against harmful interference when the equipment is operated in a commercial environment. This equipment generates, uses, and can radiate radio frequency energy and, if not installed and used in accordance with the instruction manual, may cause harmful interference to radio communications. Operation of this equipment in a residential area is likely to cause harmful interference in which case the user will be required to correct the interference at his own expense.

If necessary, the user should contact the dealer or an experienced radio/television technician for additional suggestions. The user may find the following booklet, prepared by the Federal Communications Commission, helpful: "How to Identify and Resolve Radio-TV Interference Problems." This booklet is available from the U.S. Government Printing Office, Washington, D.C., 20402, Stock No. 004-000-00345-4.

For Canada

Canadian Department of Communications Compliance Statement

DOC: This Class A digital apparatus meets all requirements of the Canadian Interference-Causing Equipment Regulations.

C-UL: Bears the C-UL Mark and is in compliance with Canadian Safety Regulations according to CAN/CSA C22.2 No. 60950-1.

Windows is a registered trademark of Microsoft Corporation. NEC is a registered trademark of NEC Corporation. OmniColor is a registered trademark of NEC Display Solutions Europe GmbH in the countries of EU and Switzerland. All other brands and product names are trademarks or registered trademarks of their respective owners.



HDMI, the HDMI logo and High-Definition Multimedia Interface are trademarks or registered trademarks of HDMI Licensing LLC.

Important Information



WARNING



TO PREVENT FIRE OR SHOCK HAZARDS, DO NOT EXPOSE THIS UNIT TO RAIN OR MOISTURE. ALSO, DO NOT USE THIS UNIT'S POLARIZED PLUG WITH AN EXTENSION CORD RECEPTACLE OR OTHER OUTLETS UNLESS THE PRONGS CAN BE FULLY INSERTED.

REFRAIN FROM OPENING THE CABINET AS THERE ARE HIGH VOLTAGE COMPONENTS INSIDE. REFER SERVICING TO QUALIFIED SERVICE PERSONNEL.



CAUTION



CAUTION: TO REDUCE THE RISK OF ELECTRIC SHOCK, MAKE SURE POWER CORD IS UNPLUGGED FROM WALL SOCKET. TO FULLY DISENGAGE THE POWER TO THE UNIT, PLEASE DISCONNECT THE POWER CORD FROM THE AC OUTLET. DO NOT REMOVE COVER (OR BACK). NO USER SERVICEABLE PARTS INSIDE. REFER SERVICING TO QUALIFIED SERVICE PERSONNEL.



This symbol warns user that uninsulated voltage within the unit may have sufficient magnitude to cause electric shock. Therefore, it is dangerous to make any kind of contact with any part inside this unit.



This symbol alerts the user that important literature concerning the operation and maintenance of this unit has been included. Therefore, it should be read carefully in order to avoid any problems.

CAUTION: Please use the power cord provided with this display in accordance with the table below. If a power cord is not supplied with this equipment, please contact your supplier. For all other cases, please use a power cord that matches the AC voltage of the power outlet and has been approved by and complies with the safety standard of your particular country.

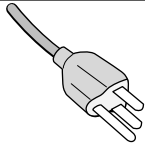
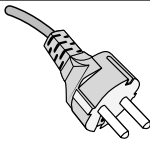
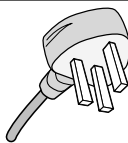
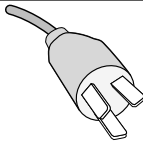
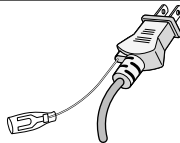
Plug Type	North America	European Continental	U.K.	Chinese	Japanese
Plug Shape					
Region	U.S.A./Canada	EU (except U.K.)	U.K.	China	Japan
Voltage	120*	230	230	220	100

*When operating the MultiSync X461UN (L468TP) monitor with its AC 125-240V power supply, use a power supply cord that matches the power supply voltage of the AC power outlet being used.

NOTE: This product can only be serviced in the country where it was purchased.

Declaration

Declaration of the Manufacturer

We hereby certify that the color monitor MultiSync X461UN (L468TP) is in compliance with

Council Directive 2006/95/EC:
– EN 60950-1

Council Directive 2004/108/EC:
– EN 55022
– EN 61000-3-2
– EN 61000-3-3
– EN 55024

and marked with



NEC Display Solutions, Ltd.
4-13-23, Shibaura,
Minato-Ku
Tokyo 108-0023, Japan

Warning

This is a class A product. In a domestic environment this product may cause radio interference in which case the user may be required to take adequate measures.

Safety Precautions, Maintenance & Recommended Use

FOR OPTIMUM PERFORMANCE, PLEASE NOTE THE FOLLOWING WHEN SETTING UP AND USING THE MULTI-FUNCTION MONITOR:

- **DO NOT OPEN THE MONITOR.** There are no user serviceable parts inside and opening or removing covers may expose you to dangerous shock hazards or other risks. Refer all servicing to qualified service personnel.
- Do not spill any liquids into the cabinet or use your monitor near water.
- Do not insert objects of any kind into the cabinet slots, as they may touch dangerous voltage points, which can be harmful or fatal or may cause electric shock, fire or equipment failure.
- Do not place any heavy objects on the power cord. Damage to the cord may cause shock or fire.
- Do not place this product on a sloping or unstable cart, stand or table, as the monitor may fall, causing serious damage to the monitor.
- The power supply cord you use must have been approved by and comply with the safety standards of your country. (Type H05VV-F 3G 1mm² should be used in Europe)
- In UK, use a BS-approved power cord with molded plug having a black (13A) fuse installed for use with this monitor.
- Do not place any objects onto the monitor and do not use the monitor outdoors.
- The lamps in this product contain mercury. Please dispose according to state, local or federal law.
- Do not bend, crimp or otherwise damage the power cord.
- If glass is broken, handle with care.
- Do not cover vent on monitor.
- Do not use monitor in high temperature, humid, dusty, or oily areas.
- If monitor or glass is broken, do not come in contact with the liquid crystal and handle with care.
- Allow adequate ventilation around the monitor, so that heat can properly dissipate. Do not block ventilated openings or place the monitor near a radiator or other heat sources. Do not put anything on top of the monitor.
- The power cable connector is the primary means of detaching the system from the power supply. The monitor should be installed close to a power outlet, which is easily accessible.
- Handle with care when transporting. Save packaging for transporting.
- Please clean the holes of back cabinet to reject dirt and dust at least once a year because of set reliability.
- If using the cooling fan continuously, it's recommended to wipe holes a minimum of once a month.
- When using a LAN cable, do not connect to a peripheral device with wiring that might have excessive voltage.

Immediately unplug your monitor from the wall outlet and refer servicing to qualified service personnel under the following conditions:

- If the monitor stand has been cracked or peeled.
- If the monitor has been wobbled.
- If the monitor has an unusual odor.
- When the power supply cord or plug is damaged.
- If liquid has been spilled, or objects have fallen into the monitor.
- If the monitor has been exposed to rain or water.
- If the monitor has been dropped or the cabinet damaged.
- If the monitor does not operate normally by following operating instructions.

Recommended Use

- For optimum performance, allow 20 minutes for warm-up.
- Rest your eyes periodically by focusing on an object at least 5 feet away. Blink often.
- Position the monitor at a 90° angle to windows and other light sources to minimize glare and reflections.
- Clean the LCD monitor surface with a lint-free, non-abrasive cloth. Avoid using any cleaning solution or glass cleaner!
- Adjust the monitor's brightness, contrast and sharpness controls to enhance readability.
- Avoid displaying fixed patterns on the monitor for long periods of time to avoid image persistence (after image effects).
- Get regular eye checkups.

Ergonomics

To realize the maximum ergonomic benefits, we recommend the following:

- Use the preset Size and Position controls with standard signals.
- Use the preset Color Setting.
- Use non-interlaced signals.
- Do not use primary color blue on a dark background, as it is difficult to see and may produce eye fatigue due to insufficient contrast.

Cleaning the LCD Panel

- When the liquid crystal panel is stained with dust or dirt, please wipe with soft cloth gently.
- Please do not rub the LCD panel with hard material.
- Please do not apply pressure to the LCD surface.
- Please do not use OA cleaner it will cause deterioration or discolor on the LCD surface.

Cleaning the Cabinet

- Unplug the power supply
- Gently wipe the cabinet with a soft cloth
- To clean the cabinet, dampen the cloth with a neutral detergent and water, wipe the cabinet and follow with a dry cloth.

NOTE: DO NOT clean with benzene thinner, alkaline detergent, alcoholic system detergent, glass cleaner, wax, polish cleaner, soap powder, or insecticide. Rubber or vinyl should not be in contact with the cabinet for an extended period of time. These types of fluids and materials can cause the paint to deteriorate, crack or peel.

Contents

Your new MultiSync monitor box* should contain the following:

- LCD monitor
- Power cord*¹
- Video Signal Cable
- Remote control cable
- Setup Manual
- Cable cover
- Clamp x 3
- Screw (black) for cable cover (M4 x 8) x 6
- Screw (silver) for clamp (M4 x 10) x 3
- CD-ROM
- Thumbscrew for stand x 2

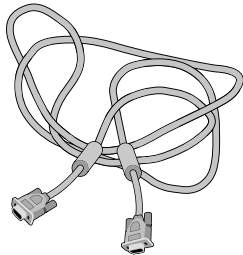

Video Signal Cable
(Mini D-SUB 15 pin to
Mini D-SUB 15 pin)

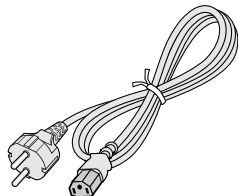

Power Cord*¹



Remote control cable

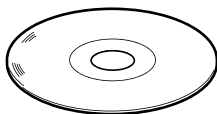

CD-ROM

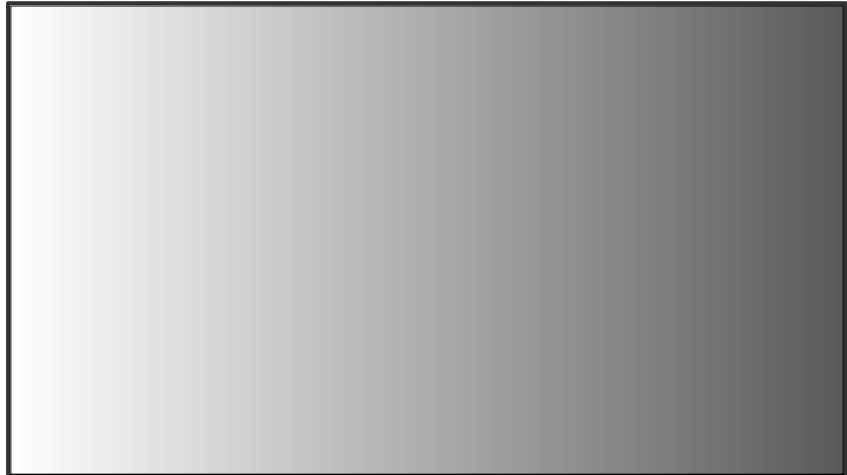

Screw (black) for cable
cover (M4 x 8) x 6



Screw (silver) for
clamp (M4 x 10) x 3



Thumbscrew for stand x 2

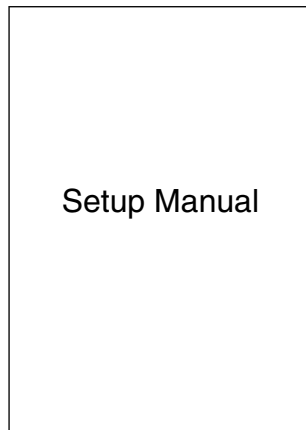

Setup Manual

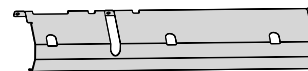

Cable cover



Clamp x 3

*¹ Type and number of power cords included will depend on where the LCD monitor is to be shipped. When more than one power cord is included, please use a power cord that matches the AC voltage of the power outlet and has been approved by and complies with the safety standard of your particular country.

* Remember to save your original box and packing material to transport or ship the monitor.

Options:

- Wall mount
- Tabletop Stand
- Remote Control Kit (Remote control and sensor)
- Over-frame Kit

Installation

This device cannot be used or installed without the Tabletop Stand or other mounting accessory for support. For proper installation it is strongly recommended to use a trained, NEC authorized service person. Failure to follow NEC standard mounting procedures could result in damage to the equipment or injury to the user or installer. Product warranty does not cover damage caused by improper installation. Failure to follow these recommendations could result in voiding the warranty.

Mounting

DO NOT mount the monitor yourself. Please ask dealer. For proper installation it is strongly recommended to use a trained, qualified technician. Please inspect the location where the unit is to be mounted. Mounting on wall or ceiling is the customer's responsibility. Not all walls or ceilings are capable of supporting the weight of the unit. Product warranty does not cover damage caused by improper installation, remodeling, or natural disasters. Failure to comply with these recommendations could result in voiding the warranty.

DO NOT block ventilated openings with mounting accessories or other accessories.

For NEC Qualified Personnel:

To insure safe installation, use two or more brackets to mount the unit. Mount the unit to at least two points on the installation location.

Please note the following when mounting on wall or ceiling

- When using mounting accessories other than those that are NEC approved, they must comply with the VESA-compatible (FDMLv1) mounting method.
- NEC strongly recommends using size M6 screws (11-12 mm + thickness of bracket and washer in length). If using screws longer than 11-12 mm, check the depth of the hole. (Recommended Fasten Force: 470 - 635N•cm) NEC recommends mounting interfaces that comply with UL1678 standard in North America.
- Prior to mounting, inspect the installation location to insure that it is strong enough to support the weight of the unit so that the unit will be safe from harm.
- Refer to the instructions included with the mounting equipment for detailed information.

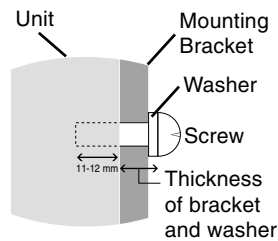

Screw length should equal depth of hole (11-12 mm) + the thickness of mounting bracket and washer.

Orientation

- When using the display in the portrait position, the monitor should be rotated clockwise so that the left side is moved to the top, right side is moved to the bottom. This will allow for proper ventilation and will extend the lifetime of the monitor. Improper ventilation may shorten the lifetime of the monitor.

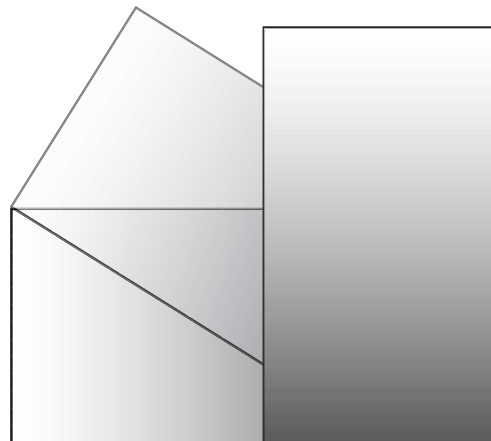

Mounting location

- The ceiling and wall must be strong enough to support the monitor and mounting accessories.
- DO NOT install in locations where a door or gate can hit the unit.
- DO NOT install in areas where the unit will be subjected to strong vibrations and dust.
- DO NOT install near where the main power supply enters the building.
- Do not install in where people can easily grab and hang onto the unit or the mounting apparatus.
- When mounting in a recessed area, as in a wall, leave at least 4 inches (10cm) of space between the monitor and the wall for proper ventilation.
- Allow adequate ventilation or provide air conditioning around the monitor, so that heat can properly dissipate away from the unit and mounting apparatus.

Mounting on ceiling

- Ensure that the ceiling is sturdy enough to support the weight of the unit and the mounting apparatus over time, against earthquakes, unexpected vibrations, and other external forces.
- Be sure the unit is mounted to a solid structure within the ceiling, such as a support beam. Secure the monitor using bolts, spring lock washers, washer and nut.
- DO NOT mount to areas that have no supporting internal structure. DO NOT use wood screws or anchor screws for mounting. DO NOT mount the unit to trim or to hanging fixtures.

Maintenance

- Periodically check for loose screws, gaps, distortions, or other problems that may occur with the mounting apparatus. If a problem is detected, please refer to qualified personnel for service.
- Regularly check the mounting location for signs of damage or weakness that may occur over time.

Attaching Mounting Accessories

The display is designed for use with the VESA mounting system.

1. Attach Mounting Accessories

Be careful to avoid tipping monitor when attaching accessories.

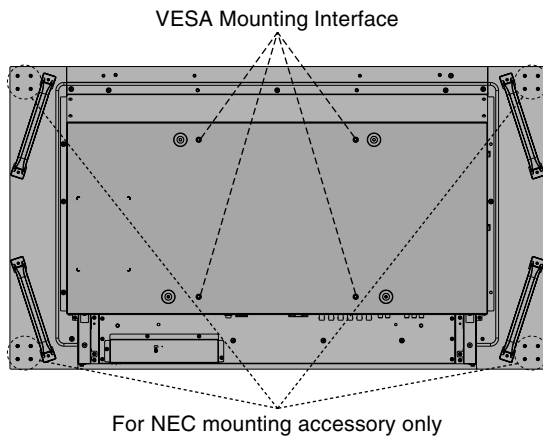

Mounting accessories can be attached with the monitor in the face down position. To avoid damaging the screen face, place the protective sheet on the table underneath the LCD. The protective sheet was wrapped around the LCD in the original packaging. Make sure there is nothing on the table that can damage the monitor.

When using mounting accessories other than NEC compliant and approved, they must comply with the VESA-compatible mounting method.

2. Installing and removing optional table top stand

CAUTION: Installing and removing the stand must be done by two or more people.

To install, follow those instructions included with the stand or mounting apparatus. Use only those devices recommended by the manufacturer.

Handle with care when mounting LCD monitor stand and avoid pinching your fingers.

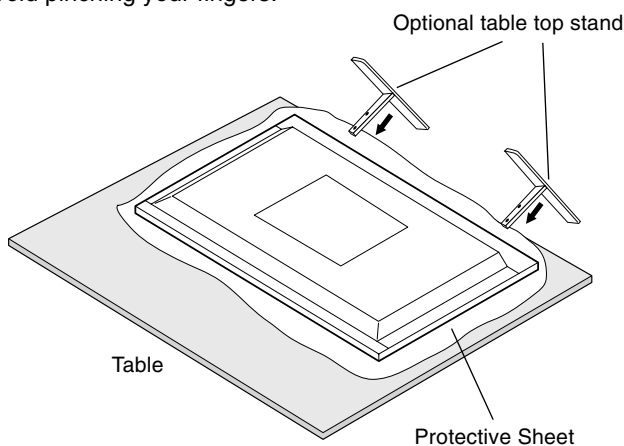

NOTE: Place stand onto monitor so that the long end of the feet are in the front.

3. Ventilation Requirements

When mounting in an enclosed space or recessed area, leave adequate room between the monitor and the enclosure to allow heat to disperse, as shown below.

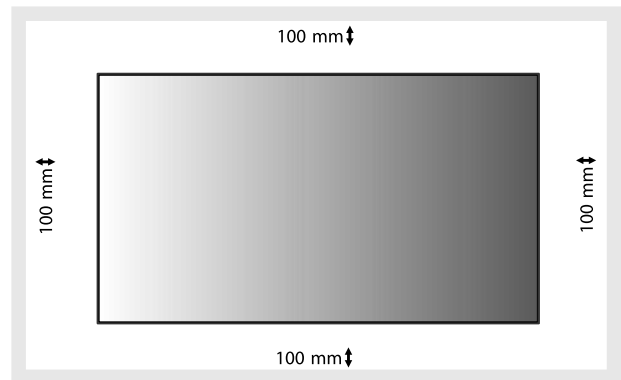

Allow adequate ventilation or provide air conditioning around the monitor, so that heat can properly dissipate away from the unit and mounting apparatus; especially when you use monitors in multiple screen.

4. Prevent Tipping

When using the display with the Tabletop Stand fasten the LCD to a wall using a cord or chain that can support the weight of the monitor in order to prevent the monitor from falling. Fasten the cord or chain to the monitor using the provided clamp and screw.

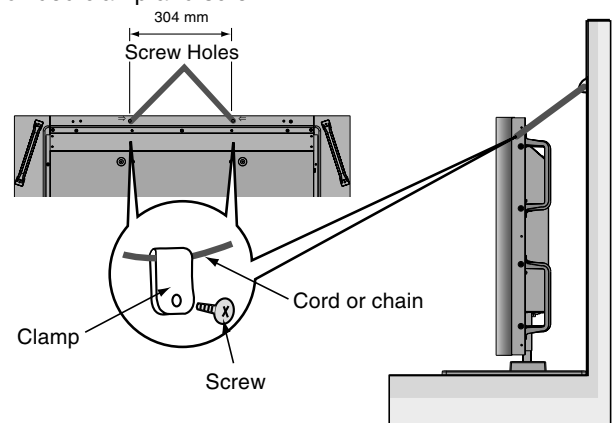

Before attaching the LCD monitor to the wall, make sure that the wall can support the weight of the monitor.

Be sure to remove the cord or chain from the wall before moving the LCD.

Parts Name and Functions

Control Panel

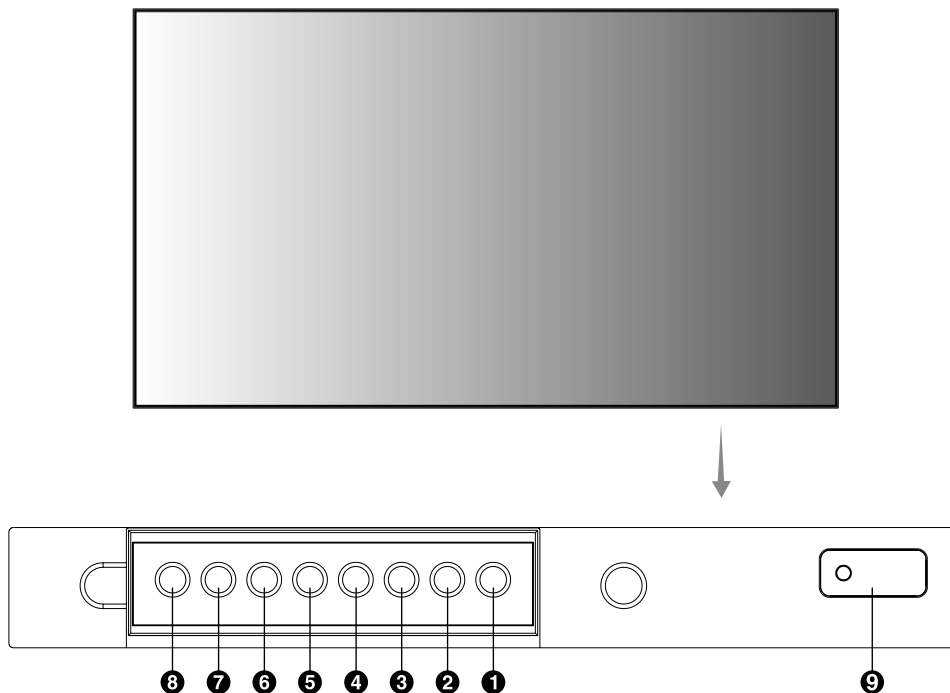

1 POWER button

Switches the power on/off. See also page 16.

2 MUTE button

Switches the audio mute ON/OFF.

3 INPUT button

Acts as SET button within OSD menu. (Toggle switches between [DVI], [VGA], [RGB/HV], [HDMI], [DVD/HD1], [DVD/HD2], [SCART], [VIDEO1], [VIDEO2], [S-VIDEO] or [TV]*). These are available input only, shown as their factory preset name.

4 PLUS button

Acts as (+) button to increase the adjustment with OSD menu. Increases the audio output level when the OSD menu is turned off.

5 MINUS button

Acts as (-) button to decrease the adjustment with OSD menu. Decreases the audio output level when the OSD menu is turned off.

6 UP button

Activates the OSD menu when the OSD menu is turned-off. Acts as ▲ button to move the highlighted area up to select adjustment items within OSD menu.

7 DOWN button

Activates the OSD menu when the OSD menu is turned-off. Acts as ▼ button to move the highlighted area down to select adjustment items within OSD menu.

8 EXIT button

Activates the OSD menu when the OSD menu is turned-off. Acts as EXIT button within the OSD to move to previous menu.

9 Remote control sensor and Power Indicator

Receives the signal from the remote control (when using the wireless remote control). See also page 11.

Glows green when the LCD monitor is in active mode*. Glows red when the LCD is in POWER OFF (ECO standby) mode. Glows amber when the LCD is in POWER OFF (standby) mode. Blinks amber when the monitor is in Power Save Mode. Green and Amber blink alternately while in Power Standby mode with the "SCHEDULE SETTINGS" function enabled. When a component failure is detected within the monitor, the indicator will blink red.

* If "OFF" is selected in "POWER INDICATOR" (see page 23), LED will not light when the LCD monitor is in active mode.

Control Key Lock Mode

This control completely locks out access to all Control Key functions. To activate the control key lock function, press both ▼ and ▲ and hold down simultaneously for more than 3 seconds. To resume user mode, press both ▼ and ▲ and hold simultaneously for more than 3 seconds.

*: The product you purchased may not have this feature.

Terminal Panel

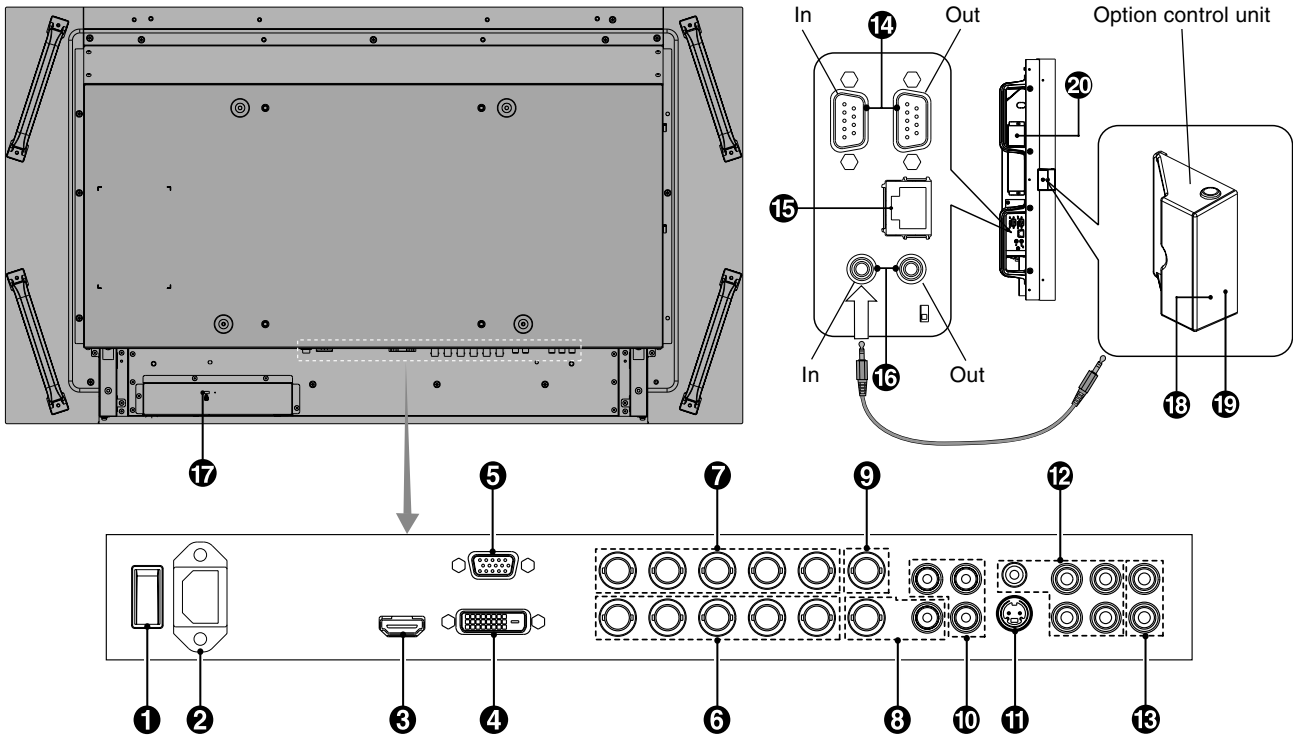

1 Main Power Switch

On/Off switch to turn main power ON/OFF.

2 AC IN connector

Connects with the supplied power cord.

3 HDMI connector

To input digital HDMI signals.

4 DVI IN (DVI-D)

To input digital RGB signals from a computer or HDTV device having a digital RGB output.

* This connector does not support analog input.

5 VGA IN (mini D-Sub 15 pin)

To input analog RGB signals from a personal computer or from other RGB equipment.

6 RGB/HV IN [R, G, B, H, V] (BNC)

To input analog RGB signals or signals from other RGB equipment.

This is also to connect equipment such as a DVD player, HDTV device and Set-Top-Box. A Sync-on-Green signal can be connected to the G connector.

This input can be used with an RGB, DVD/HD or Video source. Please select signal type in TERMINAL SETTING.

	R	G	B	H	V
RGB/HV	R	G	B	H	V
DVD/HD2	Pr	Y	Pb		
VIDEO2		VIDEO			

7 RGB/HV OUT (BNC)

To output the signal from the RGB/HV IN connector or VGA IN connector which is on screen to an input on a separate device. If both signals are not on screen, outputs the signal from RGB/HV IN connector.

8 VIDEO IN connector (BNC and RCA)

To input a composite video signal. BNC and RCA connectors are not available at the same time (Use only one input).

9 VIDEO OUT connector (BNC)

To output the composite video signal from the VIDEO IN connector.

10 DVD/HD connector (RCA)

Connecting equipment such as a DVD player, HDTV device, or Set-Top-Box.

11 S-VIDEO IN connector (Mini DIN 4 pin)

To input the S-video (Y/C separate signal).

12 AUDIO IN 1, 2, 3

To input audio signal from external equipment such as a computer, VCR or DVD player.

13 AUDIO OUT

To output the audio signal from the AUDIO IN 1, 2, 3, HDMI, and TV jack to an external device (stereo receiver, amplifier, etc.).

14 EXTERNAL CONTROL (D-Sub 9 pin)

IN connector: Connect RS-232C input from external equipment such as a PC in order to control RS-232C functions.

Out connector: Connect RS-232C output. To connect multiple MultiSync monitors via RS-232C daisy Chain.

15 LAN port (RJ-45)

LAN connection. See page 30.

16 REMOTE IN/OUT

Use the optional wired remote control by connecting it to your monitor.

NOTE: When you use Remote IN/OUT, IR CONTROL in OSD menu should be NORMAL.

17 Kensington Lock

For security and theft prevention.

18 Remote control sensor

Receives the signal from the remote control.

19 AMBIENT LIGHT SENSOR

Detects the level of ambient light, allowing the monitor to make adjustments to various settings, resulting in a more comfortable viewing experience. Do not cover this sensor. See page 18.

20 Option board slot

Slot for board accessories. Please contact your supplier for detail information.

Wireless Remote Control (Optional)

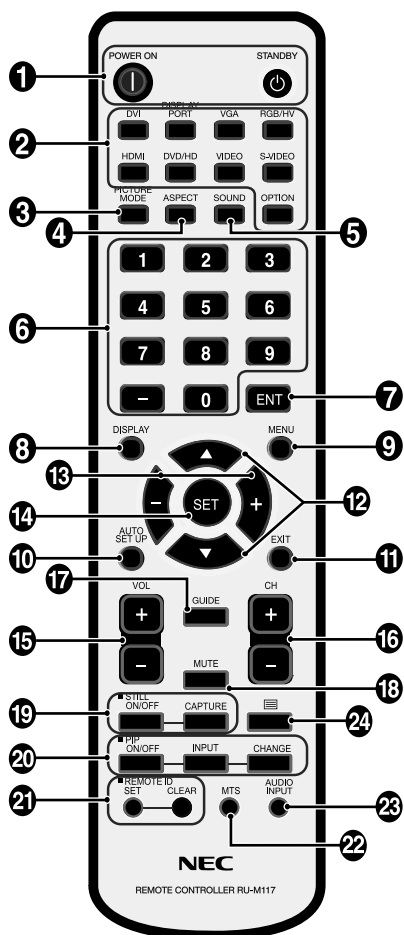

1 POWER button

Switches the power on/standby.

2 INPUT button

Selects input signal.

- DVI: DVI
- VGA: VGA
- RGB/HV: RGB/HV
- OPTION: Depend on your connection
- HDMI: HDMI
- DVD/HD: DVD/HD1, DVD/HD2, SCART
- VIDEO: VIDEO1, VIDEO2
- S-VIDEO: S-VIDEO

3 PICTURE MODE button

Selects picture mode, [HIGHBRIGHT], [STANDARD], [sRGB], [CINEMA], [AMBIENT1], [AMBIENT2]. See page 18.

- HIGHBRIGHT: for moving images such as DVD.
- STANDARD: for images.
- sRGB: for text based images.
- CINEMA: for movies.
- AMBIENT1 and AMBIENT2: activate auto dimming function. See page 18.

4 ASPECT button

Selects picture aspect, [FULL], [NORMAL], [WIDE] and [ZOOM]. See page 17.

5 SOUND button (not available)

6 KEYPAD

Press buttons to set and change passwords, change channel and set REMOTE ID.

7 ENT button*

Sets channels.

8 DISPLAY button

Turns on/off the information OSD. See page 17.

9 MENU button

Turns on/off the menu mode.

10 AUTO SETUP button

Enters auto setup menu. See page 20.

11 EXIT button

Returns to previous menu within OSD menu.

12 UP/DOWN button

Acts as ▲ ▼ button to move the highlighted area up or down to select adjustment items within OSD menu. Small screen which adjusted "PIP" mode moves up or down.

13 MINUS/PLUS (+/-) button

Increases or decreases the adjustment level within OSD menu settings. Small screen which adjusted "PIP" mode moves left or right.

14 SET button

Makes selection.

15 VOLUME UP/DOWN button

Increases or decreases audio output level.

16 CH +/- button*

Moves channel up or down (For U.S.).

17 GUIDE button*

Enters on screen program guide (For U.S.).

18 MUTE button

Turns on/off mute function.

19 STILL button

ON/OFF button: Activates/deactivates still picture mode.
STILL CAPTURE button: Captures still picture.

20 PIP (Picture In Picture) button

ON/OFF button: Toggle switches between PIP, POP, side-by-side (aspect) and side-by-side (full). See page 22.
INPUT button: Selects the "picture in picture" input signal.
CHANGE button: Replaces to the main picture and sub picture.

		Sub picture									
		DVI	VGA	RGB/HV	HDMI	DVD/HD1	DVD/HD2	SCART	VIDEO1	VIDEO2	S-VIDEO
Main picture	DVI	-	✓	✓	-	✓	✓	✓	✓	✓	✓
	VGA	✓	-	-	✓	✓	-	✓	✓	✓	✓
	RGB/HV	✓	-	-	✓	✓	-	✓	✓	-	✓
	HDMI	✓	✓	✓	-	✓	✓	✓	✓	✓	✓
	DVD/HD1	✓	✓	✓	✓	-	✓	-	✓	✓	✓
	DVD/HD2	✓	-	-	✓	✓	-	✓	✓	-	✓
	SCART	✓	✓	✓	✓	✓	-	-	-	-	-
	VIDEO1	✓	✓	✓	✓	✓	-	-	-	-	-
	VIDEO2	✓	-	-	✓	✓	-	-	-	-	-
	S-VIDEO	✓	✓	✓	✓	✓	✓	-	-	-	-

*: The product you purchased may not have this feature.

21 REMOTE ID button

Activates REMOTE ID function.

22 MTS button*

Multichannel television sound.

23 AUDIO INPUT button

Selects audio input source [IN1], [IN2], [IN3], [HDMI], [TV]*.

24  button*

Activates closed captioning (For U.S.).

*: The product you purchased may not have this feature.

Operating Range for the Option Remote Control

Point the top of the remote control toward the sensor unit's remote control sensor in optional control kit during button operation.

Use the remote control within a distance of about 7 m (23 ft.) from remote control sensor or at a horizontal and vertical angle of within 30° within a distance of about 3.5 m (10 ft.).

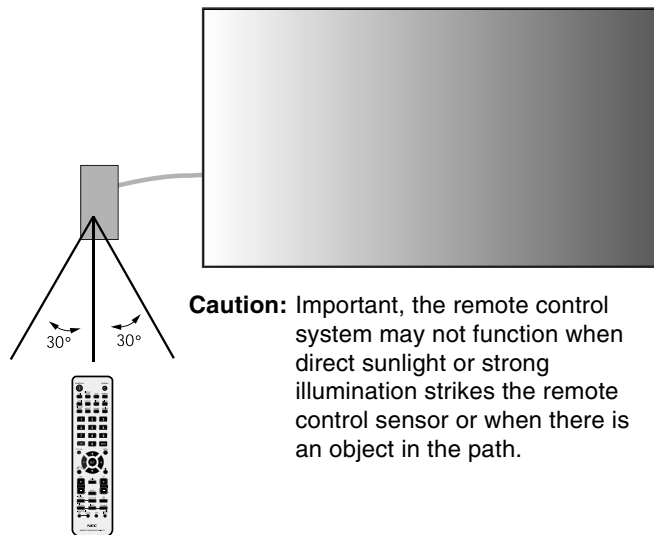

Handling the remote control

- Do not subject to strong shock.
- Do not allow water or other liquid to splash the remote control. If the remote control gets wet, wipe it dry immediately.
- Avoid exposure to heat and steam.
- Other than to install the batteries, do not open the remote control.

Setup

1. Determine the installation location

CAUTION: Installing your LCD display must be done by a qualified technician. Contact your dealer for more information.

CAUTION: MOVING OR INSTALLING THE LCD MONITOR MUST BE DONE BY TWO OR MORE PEOPLE. Failure to follow this caution may result in injury if the LCD monitor falls.

CAUTION: Do not mount or operate the display upside down, face up, or face down.

CAUTION: This LCD has a temperature sensor and cooling fan. If the LCD becomes too hot, the cooling fan will turn on automatically. If the LCD becomes overheated while the cooling fan is running, a "Caution" warning will appear. If the "Caution" warning appears, discontinue use and allow the unit to cool. Using the cooling fan will reduce the likelihood of early circuit failure and may help reduce image degradation and "Image Persistence".

If the LCD is used in an enclosed area or if the LCD panel is covered with a protective screen, please check the inside temperature of the monitor by using the "HEAT STATUS" control in the OSD (see page 24). If the temperature is higher than the normal operating temperature, please turn the cooling fan to ON within the FAN CONTROL menu within the OSD (see page 24).

IMPORTANT: Lay the protective sheet, which was wrapped around the LCD monitor when it was packaged, beneath the LCD monitor so as not to scratch the panel.

2. Install the remote control (Optional) batteries

The remote control is powered by two 1.5V AA batteries. To install or replace batteries:

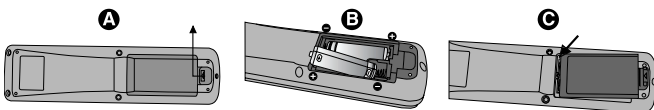

- Press and slide to open the cover.
- Align the batteries according to the (+) and (-) indications inside the case.
- Replace the cover.

CAUTION: Incorrect usage of batteries can result in leaks or bursting.

NEC recommends the following battery use:

- Place "AA" size batteries matching the (+) and (-) signs on each battery to the (+) and (-) signs of the battery compartment.
- Do not mix battery brands.
- Do not combine new and old batteries. This can shorten battery life or cause liquid leakage of batteries.
- Remove dead batteries immediately to prevent battery acid from leaking into the battery compartment.
- Do not touch exposed battery acid, it may injure skin.

NOTE: If you do not intend to use the Remote Control for a long period of time, remove the batteries.

3. Connect external equipment (See pages 14 and 15)

- To protect the external equipment; turn off the main power before making connections.
- Refer to your equipment user manual for further information.

4. Connect the supplied power cord

- The equipment should be installed close to an easily accessible power outlet.
- Please fasten power cord to the LCD monitor by attaching the screw (silver) and clamp.
- Fully insert the prongs into the power outlet socket. A loose connection may cause image degradation.

NOTE: Please refer to the "Safety Precautions and Maintenance" section of this manual for proper selection of AC power cord.

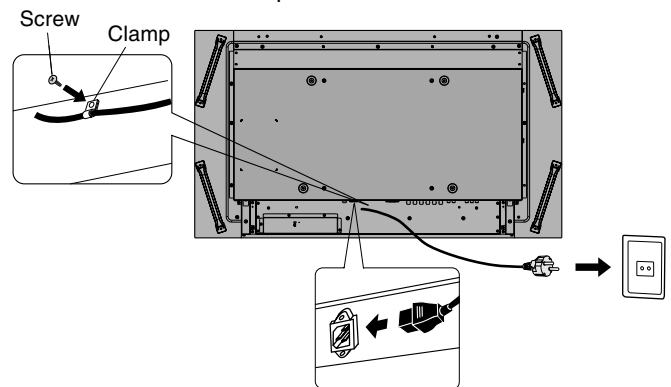

5. Attach the cable cover

- Use six of the M4 x 8 screws (black) (included) to attach the cable cover.

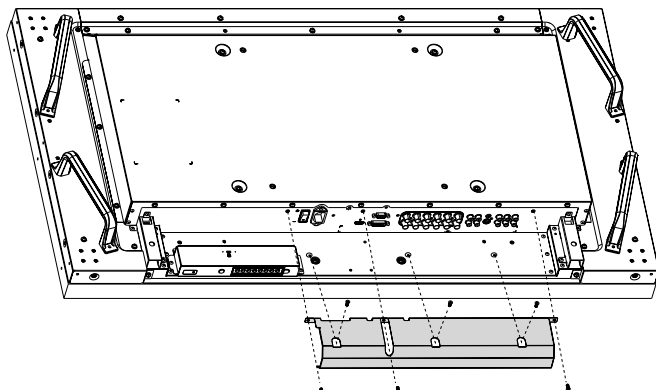

6. Switch on the power of all the attached external equipment

When connected with a computer, switch on the power of the computer first.

7. Operate the attached external equipment

Display the signal from the desired input source.

8. Adjust the sound

Make volume adjustments when required.

9. Adjust the screen (See pages 20 and 21)

Make adjustments of the screen display position when necessary.

10. Adjust the image (See page 20)

Make adjustments such as brightness or contrast when required.

11. Recommended Adjustments

To reduce the risk of the "Image Persistence", please adjust the following items based on the application being used: "SCREEN SAVER", "SIDE BORDER COLOR" (See page 24) "DATE & TIME", "SCHEDULE SETTINGS" (See page 21). It is recommended that the "FAN CONTROL" setting (See page 24) be turned to ON also.

Connections

Before making connections:

- * First turn off the power of all the attached equipment and make connections.
- * Refer to the user manual included with each separate piece of equipment.

Wiring Diagram

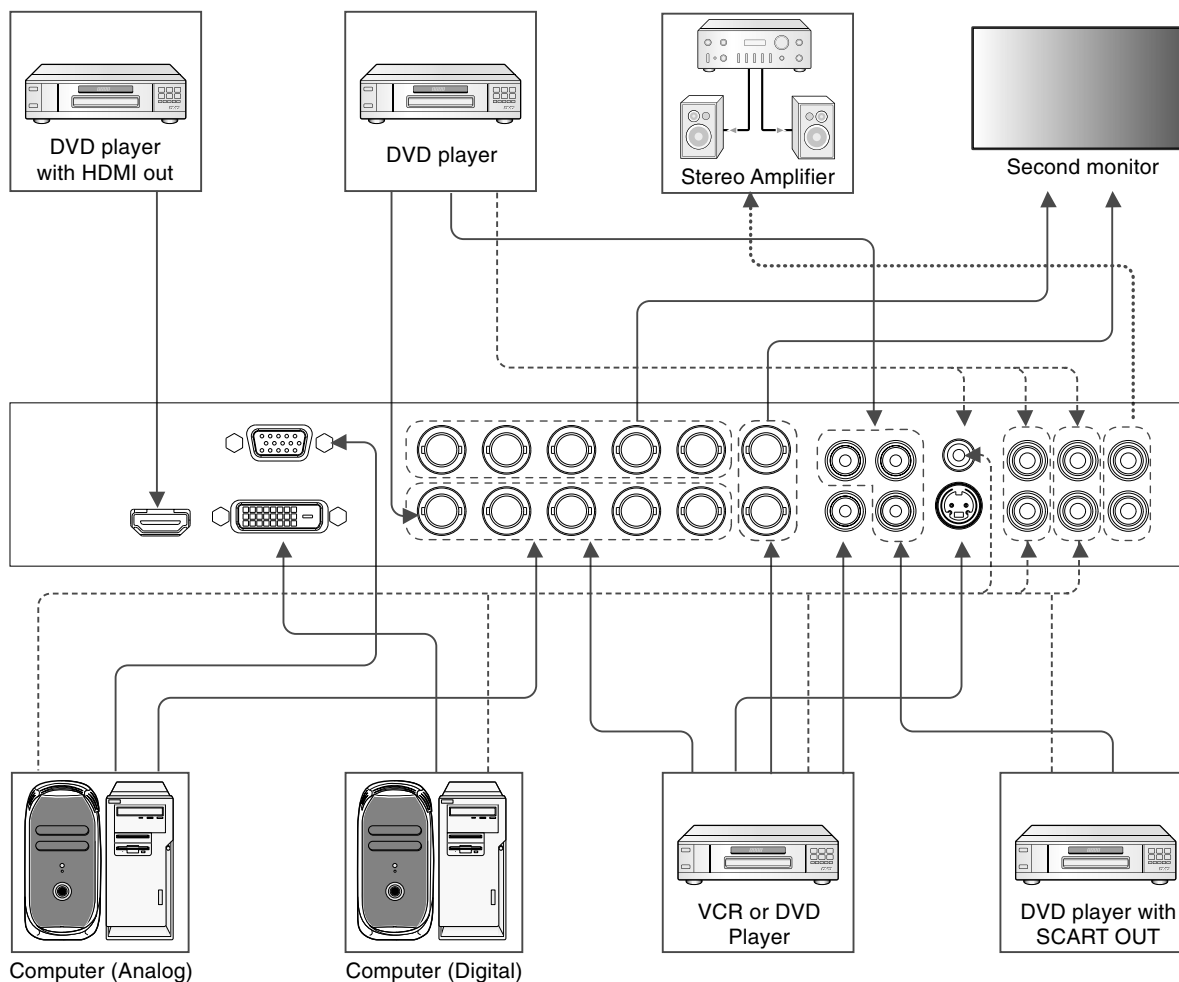

Connected equipment	Connecting terminal	Setting in Terminal Mode	Input signal name	Connecting Audio terminal	Input button in remote control
AV	DVD/HD1 (3RCA)	-	DVD/HD1	AUDIO IN1, IN2, IN3	DVD/HD
	DVI-D	DVI MODE: DVI-HD	DVI	AUDIO IN1, IN2, IN3	DVI
	HDMI	RAW/EXPAND*1	HDMI	HDMI	HDMI
	DVD/HD+VIDEO	SCART: ON	SCART	AUDIO IN1, IN2, IN3	DVD/HD
	VIDEO1 (BNC&RCA)	-	VIDEO1	AUDIO IN1, IN2, IN3	VIDEO
	S-VIDEO	-	S-VIDEO	AUDIO IN1, IN2, IN3	S-VIDEO
	VIDEO2 (5BNC)	BNC MODE: VIDEO	VIDEO2	AUDIO IN1, IN2, IN3	VIDEO
PC	DVD/HD2 (5BNC)	BNC MODE: COMPONENT	DVD/HD2	AUDIO IN1, IN2, IN3	DVD/HD
	VGA	-	VGA	AUDIO IN1, IN2, IN3	VGA
	DVI-D	DVI MODE: DVI-PC	DVI	AUDIO IN1, IN2, IN3	DVI
Media Player	BNC	BNC MODE: RGB	RGB/HV	AUDIO IN1, IN2, IN3	RGB/HV
	DVI-D	DVI MODE: DVI-PC	DVI	AUDIO IN1	DVI

*1: depend on signal type.

- AUDIO IN 1, 2 and 3 can be used for audio input. To select audio source [IN1], [IN2] or [IN3] in AUDIO INPUT in OSD menu or press the AUDIO INPUT button (optional remote control).

Connecting a Personal Computer

Connecting your computer to your LCD monitor will enable you to display your computer's screen image. Some video cards and a pixel clock over 162MHz may not display an image correctly. Your LCD monitor displays proper image by adjusting the factory preset timing signal automatically.

<Factory preset signal timing>

Resolution	Scanning frequency		Remarks
	Horizontal	Vertical	
640 x 480	31.5kHz	60Hz	
800 x 600	37.9kHz	60Hz	
1024 x 768	48.4kHz	60Hz	
1280 x 768	48kHz	60Hz	
1360 x 768	48kHz	60Hz	Recommended resolution
1280 x 1024	64kHz	60Hz	Compressed image
1600 x 1200	75kHz	60Hz	Compressed image
1920 x 1080	66.6kHz	60Hz	Compressed image

- If you use with a Macintosh PowerBook, set "Mirroring" to Off.
Refer to your Macintosh's owner's manual for more information about your computer's video output requirements and any special identification or configuring your monitor's image and monitor may require.
- Input TMDS signals conforming to DVI standards.
- To maintain display quality, use a cable that conforms to DVI standards.

Connecting a DVD Player with HDMI out

- Please use an HDMI cable with HDMI logo.
- It may take a moment for the signal to appear.
- PC-DVI signals are not supported.

Basic Operation

Power ON and OFF Modes

The LCD monitor power indicator will turn green while powered on and will turn red or amber while powered off.

NOTE: The Main Power Switch must be in the ON position in order to power up the monitor using the remote control or the Power Button on the front of the LCD.

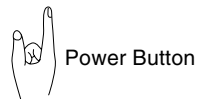
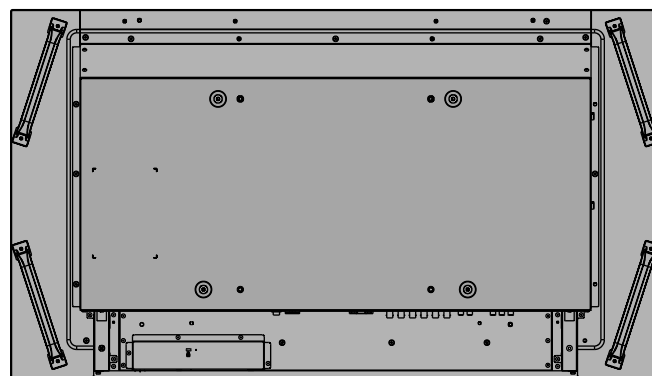
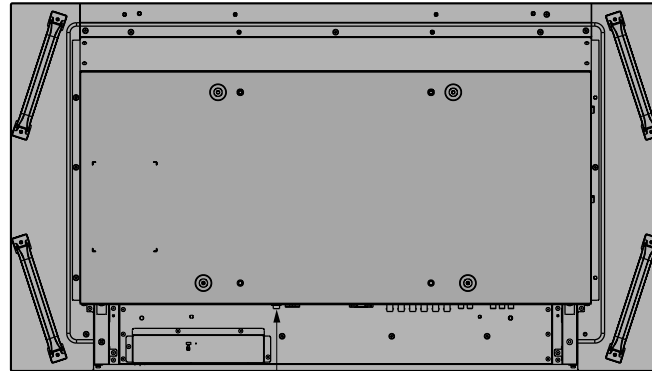

Using the optional remote control

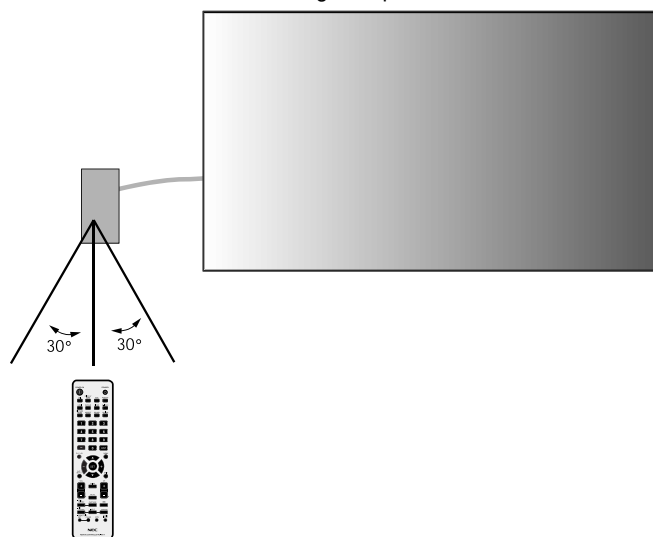

Power Indicator

Mode	Status Indicator Light
Power ON	Green*2
Power OFF (Eco Standby)*1 Power consumption under 0.5W*3	Red
Power OFF (Standby) Power consumption under 2W*3	Amber
Power Save Power consumption under 2W*3	Amber Blinking
Power Standby when "SCHEDULE SETTINGS" enabled	Green and Amber blink alternately
Diagnosis (Detecting failure)	Red Blinking (See Troubleshooting page 34)

*1 When in Eco Standby Mode RS-232C and LAN controls do not function.
*2 If "OFF" is selected in POWER INDICATOR (page 23), the LED will not light when the LCD monitor is in active mode.
*3 "RS-232C" is selected in EXTERNAL CONTROL.

Using Power Management

The LCD monitor follows the VESA approved DPM Power Management function.

The power management function is an energy saving function that automatically reduces the power consumption of the display when the keyboard or the mouse has not been used for a fixed period.

The power management feature on your new display has been set to the "ON" mode. This allows your display to enter a Power Saving Mode when no signal is applied. This could potentially increase the life and decrease the power consumption of the display.

STANDBY mode is used when the display is connected to an RS-232C cable or when using the INPUT DETECT function.

ECO STANDBY uses less power, but the RS-232C and INPUT DETECT functions are not available.

Selecting a video source

To view a video source:

Use the input button to set [VIDEO].

Use the COLOR SYSTEM menu to set [AUTO], [NTSC], [PAL], [SECAM], [PAL60], [4.43NTSC], according to your video format.

Picture Aspect

DVI, VGA, RGB/HV

FULL → ZOOM → NORMAL

HDMI, DVD/HD1, DVD/HD2, SCART, VIDEO1, VIDEO2, S-VIDEO, TV*

FULL → WIDE → ZOOM → NORMAL

Aspect ratio of image	Unchanged view*1	Recommended selection for picture aspect*1
4:3		NORMAL
		ZOOM (DYNAMIC)
Squeeze		FULL
Letterbox		WIDE

*1 Grey areas indicate unused portions of the screen.

NORMAL: Displays the aspect ratio the same as it is sent from the source.

FULL: Fills entire screen.

WIDE: Expands a 16:9 letter box signal to fill entire screen.

ZOOM (DYNAMIC): Expands a 4:3 pictures to fill the entire screen with non-linearity. Some of the outside image area will be cut off due to expansion.

ZOOM

The image can be expanded beyond the active display area. The image which is outside of active display area is not shown.

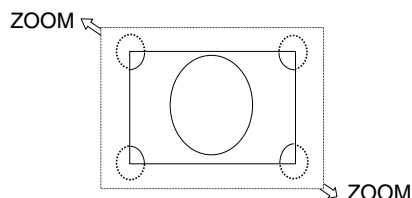

Information OSD

The Information OSD provides information such as: Monitor ID, Input Source, Picture Size, etc. Press the DISPLAY button on the remote to bring up the Information OSD.

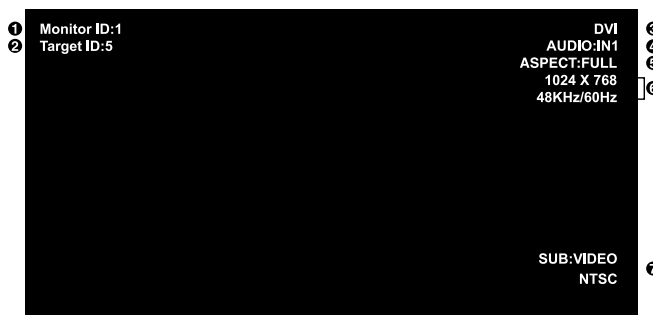

① ID number assigned to current monitor*3

② ID number assigned monitor to be controlled via RS-232C*4

③ Input Name

④ Audio input mode

⑤ Picture aspect

⑥ Input Signal Information

⑦ Sub picture information

*3: "IR CONTROL" should be set "Primary" or "Secondary".

*4: "IR CONTROL" should be set "Primary".

*: The product you purchased may not have this feature.

Picture Mode

DVI, VGA, RGB/HV

STANDARD → sRGB → AMBIENT1 → AMBIENT2 → HIGHBRIGHT

HDMI, DVD/HD1, DVD/HD2, SCART, VIDEO1, VIDEO2, S-VIDEO, TV*

STANDARD → CINEMA → AMBIENT1 → AMBIENT2 → HIGHBRIGHT

AMBIENT Mode

The brightness of the LCD screen can be set to increase or decrease depending on the amount of ambient light within the room. If the room is bright, the monitor becomes correspondingly bright. If the room is dim, then the monitor will dim accordingly. The purpose of this function is to make the viewing experience more comfortable to the eye in a variety of lighting conditions.

NOTE: When picture mode is set to AMBIENT1 or AMBIENT2, AUTO BRIGHTNESS function is disabled.
Do not cover ambient sensor when you use AMBIENT1 or AMBIENT2 in PICTURE MODE.

AMBIENT parameter setting

PICTURE MODE in OSD, select AMBIENT1 or AMBIENT2 and set IN BRIGHT and IN DARK.

IN BRIGHT: This is the brightness level that the monitor will go up to when the ambient light level is highest.

IN DARK: This is the level of brightness that the monitor will go down to when the ambient light level is low.

When the AMBIENT function is enabled the Brightness level of the screen changes automatically according to the lighting conditions of the room (Figure 1).

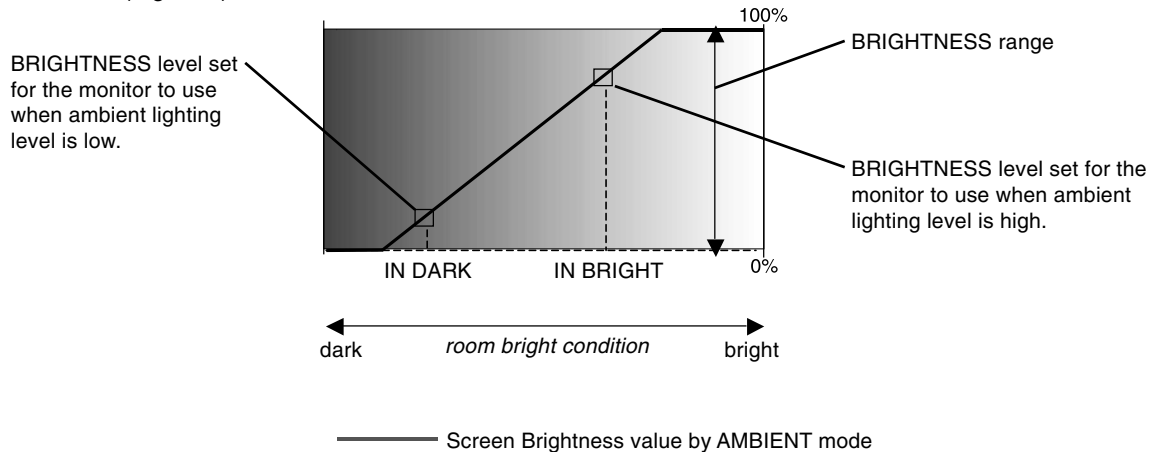
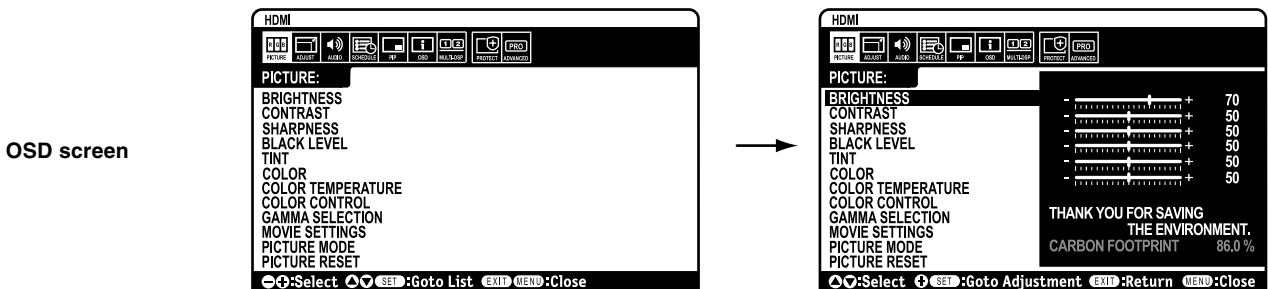
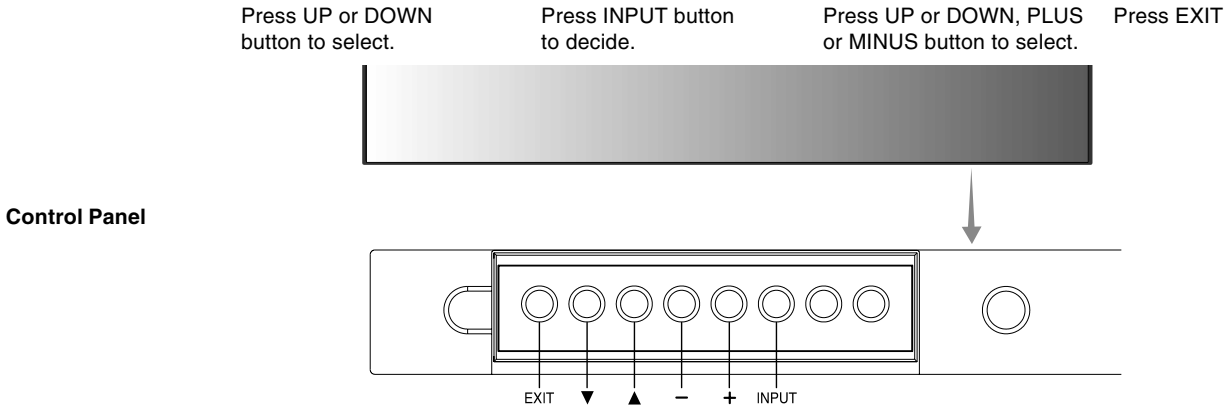
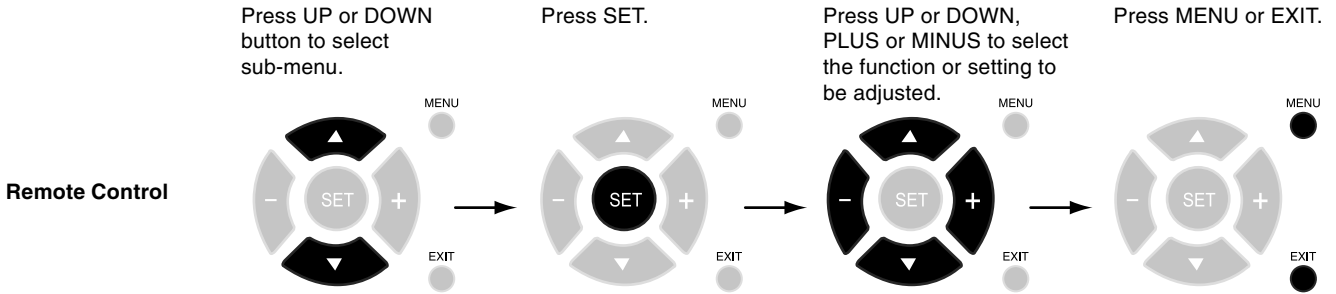
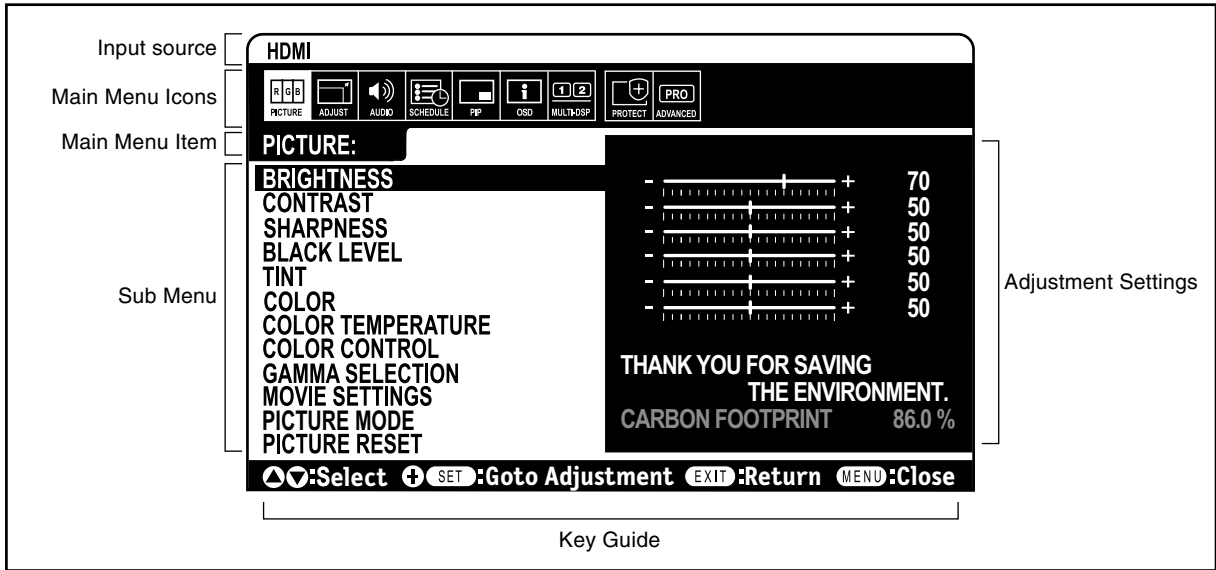

Figure 1

IN DARK: BRIGHTNESS level set for the monitor to use when ambient lighting level is high.
IN BRIGHT: BRIGHTNESS level set for the monitor to use when ambient lighting level is low.

OSD (On-Screen-Display) Controls

NOTE: Some functions may not be available depending on the model or optional equipment.



Setting		Default
PICTURE		
BRIGHTNESS	Adjusts the overall image and background brightness. Press + or - to adjust. Note: When AMBIENT1 or AMBIENT2 is selected in picture mode, this function cannot be changed.	70
CONTRAST	Adjusts the image brightness in relationship to the background. Press + or - to adjust. Note: The sRGB picture mode is standard and cannot be changed.	50
SHARPNESS	Adjusts the crispness of the image. Press + or - to adjust.	50*2
BLACK LEVEL	Adjusts the image brightness in relationship to the background. Press + or - to adjust. Note: The sRGB picture mode is standard and cannot be changed.	50
TINT	Adjusts the tint of the screen. Press + or - to adjust.	50
COLOR	Adjusts the color depth of the screen. Press + or - to adjust.	50*2
COLOR TEMPERATURE	Adjusts the color temperature of the entire screen. A low color temperature will make the screen reddish. A high color temperature will make the screen bluish. If TEMPERATURE needs further adjustment, the individual R/ G/ B/ levels of the white point can be adjusted. To adjust the R/G/B levels, CUSTOM must be showing as the COLOR TEMP selection. Note: The sRGB picture mode is set to a predefined 6500 K standard and cannot be changed.	10000K
COLOR CONTROL	Adjusts the levels of the Red, Yellow, Green, Cyan, Blue, Magenta and Saturation. Note: The sRGB picture mode is standard and cannot be changed.	0
GAMMA SELECTION	Select a display gamma for best picture quality. Note: The sRGB picture mode is standard and cannot be changed.	PROGRAMMABLE (except sRGB setting)
NATIVE	Gamma correction is handled by the LCD panel.	
2.2	Typical display gamma for use with a PC.	
2.4	Good for video (TV, DVD, etc.)	
S GAMMA	Special gamma for certain types of movies. Raises the dark parts and lowers the light parts of the image (S-Curve).	
DICOM SIM.	DICOM GSDF curve simulated for LCD type.	
PROGRAMMABLE	A programmable gamma curve can be loaded using NEC software.	
MOVIE SETTINGS		
NOISE REDUCTION <small>TV, VIDEO1, VIDEO2, S-VIDEO inputs only</small>	Adjusts the amount of noise reduction. Press + or - to adjust.	6*2
FILM MODE <small>HDMI, DVI/HD1, DVI/HD2, SCART, VIDEO1, VIDEO2, S-VIDEO, TV inputs only</small>	Selects Film mode.	AUTO*2
ADAPTIVE CONTRAST <small>HDMI, DVI/HD1, DVI/HD2, SCART, VIDEO1, VIDEO2, S-VIDEO, TV inputs only</small>	Sets the level of adjustment for dynamic contrast.	OFF
PICTURE MODE	Selects picture mode, [HIGHBRIGHT], [STANDARD], [sRGB], [CINEMA], [AMBIENT1] or [AMBIENT2]. See page 18.	STANDARD
PICTURE RESET	Resets the following settings within the PICTURE menu back to factory setting: BRIGHTNESS, CONTRAST, SHARPNESS, BLACK LEVEL, TINT, COLOR, COLOR TEMPERATURE, COLOR CONTROL, GAMMA SELECTION, MOVIE SETTINGS.	-
ADJUST		
AUTO SETUP <small>VGA, RGB/HV inputs only</small>	Automatically adjusts Screen Size, H position, V position, Clock, Clock Phase and White Level.	-
AUTO ADJUST <small>VGA, RGB/HV inputs only</small>	H Position, V Position and Clock Phase are adjusted automatically upon power on.	OFF
H POSITION	Controls the horizontal position of the image within the Display area of the LCD. Press + to move right. Press - to move left.	-
V POSITION	Controls the vertical position of the image within the Display area of the LCD. Press + to move up. Press - to move down.	-
CLOCK <small>VGA, RGB/HV inputs only</small>	Press + to expand the width of the image on the right of the screen. Press - to narrow the width of the image on the left.	-
CLOCK PHASE <small>VGA, RGB/HV, DVI/HD1, DVI/HD2, SCART inputs only</small>	Adjusts the visual "noise" on the image.	-

*: The product you purchased may not have this feature.

*2: depend on signal input

H RESOLUTION DVI, VGA, RGB/HV inputs only	Adjusts the horizontal size of the image.	-
V RESOLUTION DVI, VGA, RGB/HV inputs only	Adjusts the vertical size of the image.	-
INPUT RESOLUTION VGA, RGB/HV inputs only	If there is a problem with signal detection, this function forces the monitor to display the signal at the desired resolution. After selection, execute "AUTO SETUP" if required. If no problem is detected, the only available option will be "AUTO".	AUTO
ZOOM MODE All inputs except TV*	Select the aspect ratio of the screen image.	-
BASE ZOOM		CUSTOM
16:9 <small>HDMI, DVI(DH), DVI(DH2), SCART, VIDEO1, VIDEO2, S-VIDEO inputs only</small>	For input sources that have a 16:9 aspect ratio.	
14:9 <small>HDMI, DVI(DH), DVI(DH2), SCART, VIDEO1, VIDEO2, S-VIDEO inputs only</small>	For input sources that have a 14:9 aspect ratio.	
DYNAMIC <small>HDMI, DVI(DH), DVI(DH2), SCART, VIDEO1, VIDEO2, S-VIDEO inputs only</small>	Expands 4:3 picture to fill the screen. Some of the image is lost due to expansion.	
OFF All inputs, except TV*	Selecting "OFF" will display the image in a 1 by 1 pixel format. (If the input resolution is higher than a 1360 x 768 resolution, the image will be scaled down to fit the screen.)	
CUSTOM All inputs, except TV*	Displays an image as large as possible without changing the aspect ratio.	
ZOOM**	Maintains the aspect ratio while zooming.	1.00
H ZOOM**	Amount of horizontal zoom. Can be adjusted for each BASE ZOOM setting.	1.00
V ZOOM**	Amount of vertical zoom. Can be adjusted for each BASE ZOOM setting.	1.00
H POS**	Horizontal position. Can be adjusted for each BASE ZOOM setting.	0%
V POS**	Vertical position. Can be adjusted for each BASE ZOOM setting.	0%
ASPECT	Selects picture aspect, [FULL], [NORMAL], [WIDE] and [ZOOM]. See page 17.	FULL
ADJUST RESET	Resets the following settings within the ADJUST menu back to factory setting: AUTO ADJUST, H POSITION, V POSITION, CLOCK, CLOCK PHASE, H RESOLUTION, V RESOLUTION, ZOOM MODE, ASPECT.	-
AUDIO		
BALANCE (Not available)		-
TREBLE (Not available)		-
BASS (Not available)		-
PIP AUDIO	Selects source of PIP audio.	MAIN AUDIO
LINE OUT	Selecting "VARIABLE" will enable to control line out level with VOLUME button.	FIXED
SURROUND (Not available)	Artificial surround sound.	-
AUDIO INPUT	Selects audio input source [IN1], [IN2], [IN3], [HDMI], [TV]*.	Depend on signal input
AUDIO RESET	Resets "AUDIO" options back to factory settings.	-
SCHEDULE		
OFF TIMER	Sets the monitor to power off after a length of time. A time between 1 to 24 hours is available.	OFF
SCHEDULE SETTINGS	Creates a working schedule for the monitor to use.	-
SCHEDULE LIST	List of schedules.	-
DATE & TIME	Sets the date, time, and daylight saving region. Date & time must be set in order for the "SCHEDULE" function to operate.	
YEAR		-
MONTH		-
DAY		-
TIME		-
DAYLIGHT SAVING		OFF

*: The product you purchased may not have this feature.

**: 16:9, 14:9, CUSTOM only

SCHEDULE RESET	Resets the following settings within the SCHEDULE menu back to factory setting: OFF TIMER, SCHEDULE SETTINGS.	-
PIP		
KEEP PIP MODE	Allows the monitor to remain in "PIP" and "TEXT TICKER" mode after powering off. When Power is returned, PIP and TEXT TICKER appear without having to enter the OSD.	OFF
PIP MODE	Picture-in-Picture	OFF
OFF	OFF	
PIP	PIP	
POP	POP	
SIDE BY SIDE (ASPECT)	SIDE BY SIDE ASPECT	
SIDE BY SIDE (FULL)	SIDE BY SIDE FULL	
PIP SIZE	Selects the size of the sub-picture used in Picture-in-Picture (PIP) mode.	LARGE
SMALL		
MIDDLE		
LARGE		
PIP POSITION	Determines where the PIP appears on the screen.	X = 95, Y = 92
ASPECT	Selects sub picture aspect, [FULL], [NORMAL], [WIDE] and [ZOOM]. See page 17.	FULL
TEXT TICKER	Allow text insertion within main screen with the ability to adjust for direction, position, size, blend for transparency rate, detect and fade in. The TEXT TICKER and PIP functions cannot be used simultaneously. If the PIP function is on, it will be deactivated and vice versa if the TEXT TICKER is turned on.	OFF
SUB INPUT	Selects sub picture input signal.	Depend on signal input
PIP RESET	Resets PIP options back to factory settings except ASPECT and SUB INPUT.	-
OSD		
LANGUAGE	Select the language used by the OSD.	ENGLISH (Depend on destination)
ENGLISH		
DEUTSCH		
FRANÇAIS		
ITALIANO		
ESPAÑOL		
SVENSKA		
РУССКИЙ		
日本語		
OSD TURN OFF	Turns off the OSD after a period of inactivity. The preset choices are 10-240 seconds.	30 Sec.
OSD POSITION	Determines the location where the OSD appears on the screen.	X = 128, Y = 225
UP		
DOWN		
LEFT		
RIGHT		
INFORMATION OSD	Selects whether the information OSD is displayed or not. The information OSD will be displayed when the input signal or source changes. The information OSD will also give a warning when there is no-signal or the signal is out-of range. An interval between 3 to 10 seconds for the Information OSD to appear is available.	ON, 3 Sec.
MONITOR INFORMATION	Monitor Information. CARBON SAVINGS: Display the estimated carbon saving information in kg. The carbon footprint factor in the carbon saving calculation is based on the OECD (2008 Edition).	-

OSD TRANSPARENCY	Set the transparency level of the OSD.	TYPE2
OFF		
TYPE1		
TYPE2		
OSD ROTATION	Determines the OSD display direction between landscape and portrait.	LANDSCAPE
LANDSCAPE	Display the OSD with landscape mode.	
PORTRAIT	Display the OSD with portrait mode.	
INPUT NAME	You can set currently displayed INPUT name as you like. Max: 8 letters, you can use Space, A-Z, 0-9, and some symbols.	-
CLOSED CAPTION	Activates closed captioning (for U.S. only).	OFF
OSD RESET	Resets the following settings within the OSD menu back to factory setting: OSD TURN OFF, OSD POSITION, INFORMATION OSD, OSD TRANSPARENCY, CLOSED CAPTION.	-
MULTI DISPLAY		
MONITOR ID	Sets the monitor ID number from 1-100 and group ID from A-J. NOTE: Group ID is made of multiple selections.	1
IR CONTROL	Selects the mode of the monitor for use with the infra-red remote control when using the RS-232C daisy chain.	NORMAL
NORMAL	The monitor will be controlled normally by wireless remote controller.	
PRIMARY	Choose "PRIMARY" for the first monitor within an RS-232C daisy chain.	
SECONDARY	Choose "SECONDARY" for all subsequent monitors within an RS-232C daisy chain.	
LOCK	Prevents the monitor from being controlled by wireless remote controller. To return to normal operation, press the "DISPLAY" button on the remote controller for 5 seconds.	
TILE MATRIX	Allows one image to be expanded and displayed over multiple screens (up to 100) through a distribution amplifier. NOTE: Low resolution is not suitable for tiling to a large number of monitors.	
H MONITORS	Number of monitors arranged horizontally.	1
V MONITORS	Number of monitors arranged vertically.	1
POSITION	Select which section of the tiled image to be displayed on the monitor.	1
TILE COMP	Turns the TILE COMP feature on.	NO
ENABLE	Enables Tile Matrix.	NO
POWER ON DELAY	Adjusts the delay time between being in "standby" mode and entering "power on" mode. "POWER ON DELAY" can be set between 0 and 50 seconds.	0 Sec.
POWER INDICATOR	Turns ON or OFF the LED located at the front of the monitor. If "OFF" is selected, LED will not light when the LCD monitor is in active mode.	ON
EXTERNAL CONTROL		RS-232C
CONTROL	Selects the control interface, RS-232C or LAN.	
LAN RESET	Resets the LAN settings.	
SETTING COPY	In daisy chain condition, set the OSD menu categories which copy from current monitor to others. NOTE: When you use this function, EXTERNAL CONTROL should be "RS-232C". This function reset to default when power off. This function has limit up to about 5 monitors.	NO
COPY START	Select "YES" and press SET button to start copy.	
ALL INPUT	When you check this item, copy to all input terminals. Default is off.	
MULTI DISPLAY RESET	Resets "MULTI DISPLAY" options back to factory settings.	-

DISPLAY PROTECTION		
POWER SAVE <small>All inputs except for TV*</small>	Sets how long the monitor waits to go into power save mode after a lost signal. Note: When connecting DVI, video card might not stop sending digital data even if image has disappeared. In this case the monitor does not get to power management mode.	ON
STANDBY MODE	Lowers power consumption. Note: RS-232C and LAN Function are lost when in Eco Standby mode.	STANDBY
HEAT STATUS	Displays status of the FAN, BRIGHTNESS and TEMPERATURE.	-
FAN CONTROL	Cooling fan reduces the temperature of the display to protect from overheating. If "AUTO" is selected, you can adjust the start temperature of the cooling fan and fan speed.	AUTO
SCREEN SAVER	Use the SCREEN SAVER function to reduce the risk of Image Persistence.	
GAMMA	The display gamma is changed and fixed when "ON" is selected.	OFF
BRIGHTNESS	The brightness is decreased when "ON" is selected. NOTE: Do not select this function when picture model is AMBIENT1 or AMBIENT2.	OFF
MOTION	The screen image is slightly expanded and moves in 4 directions (UP, DOWN, RIGHT, LEFT) at user determined intervals. You can set interval time and zooming ratio.	OFF
SIDE BORDER COLOR	Adjusts the color of the side borders when a 4:3 image is displayed. Press + button, the bar will become lighter. Press - button, the bar will become darker.	15
AUTO BRIGHTNESS <small>DVI, VGA, RGB/HV inputs only</small>	Adjusts the brightness level according to the input signal. NOTE: Do not select this function when picture model is AMBIENT1 or AMBIENT2.	OFF
CHANGE SECURITY PASSWORD	Allows the security password to be changed. The factory preset password is 0000.	-
SECURITY LOCK	Locks the security password.	OFF
DDC/CI	ENABLE/DISABLE: Turns On or OFF the two way communication and control of the monitor.	ENABLE
DISPLAY PROTECTION RESET	Resets the following settings within the DISPLAY PROTECTION menu back to factory setting: POWER SAVE, STANDBY MODE, FAN CONTROL, SCREEN SAVER, SIDE BORDER COLOR, AUTO BRIGHTNESS, DDC/CI.	-
ADVANCED OPTION		
INPUT DETECT <small>All inputs except for TV*</small>	Selects the method of input detection the monitor uses when more than two input devices are connected.	FIRST DETECT
NONE	The Monitor will not search the other video input ports.	
FIRST DETECT	When the current video input signal is not present, then the monitor searches for a video signal from the other video input port. If the video signal is present in the other port, then the monitor switches the video source input port to the new found video source automatically. The monitor will not look for other video signals while the current video source is present.	
LAST DETECT	When the monitor is displaying a signal from the current source and a new secondary source is supplied to the monitor, the monitor will automatically switch to the new video source. When current video input signal is not present, the monitor searches for a video signal from the other video input port. If the video signal is present in the other port, then the monitor switches the video source input port to the new found video source automatically.	
VIDEO DETECT	DVD/HD1, DVD/HD2, SCART, VIDEO1, VIDEO2 or S-VIDEO inputs will have priority over DVI, VGA, RGB/HV. When DVD/HD1, DVD/HD2, SCART, VIDEO1, VIDEO2 or S-VIDEO input signal is present the monitor will change and keep to the DVD/HD1, DVD/HD2, SCART, VIDEO1, VIDEO2 or S-VIDEO input.	
CUSTOM DETECT	Set the priority of input signals. When CUSTOM DETECT is selected, monitor searches listed inputs only.	
INPUT CHANGE	Sets input change speed. NOTE: When "QUICK" is selected, picture may be distorted when signal input is changed.	NORMAL
LONG CABLE COMP	Manually compensates for image degradation caused from using a long cable.	
EQUALIZE <small>VGA, RGB/HV inputs only</small>		OFF
POLE	Adjusts frequency.	0
PEAK	Adjusts equalizing value.	0

*: The product you purchased may not have this feature.

	GAIN	Adjusts gain value.	0
	OFFSET	Adjusts slice level of synchronized signal.	0
	SYNC TERMINATE <small>RGB/HV inputs only</small>	Selects the terminate resistance for matching the cable impedance.	HIGH
TERMINAL SETTING			
	DVI MODE	Selects the kind of DVI-D equipment which is connected DVI. Select "DVI-PC" when PC or other computer equipment is connected. Select "DVI-HD" when DVD player, which has DVI-D output, is connected.	DVI-PC
	BNC MODE	Selects the kind of equipment which is connected BNC. RGB: Analog input COMPONENT: Component VIDEO:	RGB
	SCART MODE	Input mode for devices using SCART connectors.	OFF
	HDMI SIGNAL	RAW/EXPAND	EXPAND
SCAN CONVERSION <small>All inputs except VGA, RGB/HV</small>		Selects the IP (Interlace to Progressive) conversion function. Note: For DVI input "DVI-HD" need to be enabled in the DVI mode menu.	PROGRESSIVE
	PROGRESSIVE	Converts interlaced signals to progressive. This is the default setting.	
	INTERLACE	Disables IP conversion. This setting is best suited for motion pictures, but increases the risk of image retention.	
COLOR SYSTEM <small>VIDEO1, VIDEO2, S-VIDEO inputs only</small>		The selected Color System depends on the video format of the input signal.	AUTO
	AUTO	Automatically chooses Color System setting based on input signal.	
	NTSC		
	PAL		
	SECAM		
	4.43 NTSC		
	PAL-60		
SCAN MODE <small>HDMI, DVI(HD1, DVI(HD2, SCART, VIDEO1, VIDEO2, S-VIDEO, TV* inputs only</small>		Some video formats may require different scanning modes in order to best display the image.	OVER SCAN
	OVER SCAN	Image size is larger than what can be displayed. The image edge will appear cropped. Approximately 95% of the image will be shown on the screen.	
	UNDER SCAN	Image size stays within the display area. The whole image is displayed on the screen.	
ADVANCED OPTION RESET		Resets the following settings within the ADVANCED OPTION menu back to factory setting: INPUT DETECT, INPUT CHANGE, LONG CABLE COMP, TERMINAL SETTING, SCAN CONVERSION, COLOR SYSTEM, SCAN MODE.	-
FACTORY RESET		Resets OSD options back to factory settings EXCEPT FOR: DATE & TIME, LANGUAGE, OSD ROTATION, INPUT NAME, CHANGE SECURITY PASSWORD, SECURITY LOCK and SECURITY PASSWORD.	-

*: The product you purchased may not have this feature.

NOTE 1: CREATING A SCHEDULE

The schedule function allows the display to be set to power on and off at different times. Up to seven different schedules can be programmed.

To program the schedule:

1. Enter the SCHEDULE menu. Highlight SCHEDULE SETTINGS using the up and down buttons. Press the SET or the + button to enter the Settings menu. Highlight the desired schedule number and press set. The box next to the number will turn yellow. The schedule can now be programmed.
2. Use the down button to highlight the hours setting in the ON time slot. Use the + and - buttons to set the hour. Use the up and down buttons to highlight the minutes setting. Use the + and - buttons to set the minutes. Set the OFF time in the same manner.
3. Use the up and down arrows to highlight INPUT. Use the + and - buttons to choose the input source. Use the up and down arrows to highlight PIC. MODE. Use the + and - buttons to choose the picture mode.
4. Use the down button to select a day on which the schedule will be enabled. Push the set button to enable. If the schedule is to be ran every day, choose EVERY DAY and press the SET button. The circle next to EVERY DAY will turn yellow. If a weekly schedule is desired, choose the days of the week using the up and down buttons and pressing SET to select. Then highlight the EVERY WEEK option and press SET.
5. After a schedule is programmed the remaining schedules can then be set. Press MENU to leave the OSD or press EXIT to go back to the previous menu.

Note: If schedules are overlapping then the schedule with the highest number will have priority over the schedule with the lowest number. For example schedule #7 will have priority over schedule #1.

If selected input or picture mode is not available now, disable input or picture mode is shown in red.

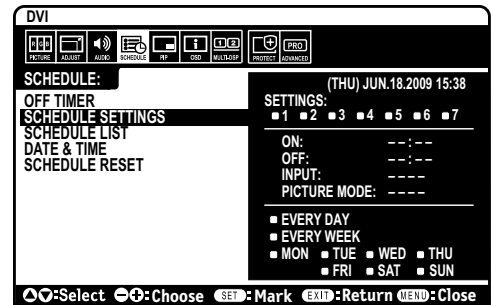

NOTE 2: IMAGE PERSISTENCE

Please be aware that LCD Technology may experience a phenomenon known as Image Persistence. Image Persistence occurs when a residual or “ghost” image of a previous image remains visible on the screen. Unlike CRT monitors, LCD monitors’ image persistence is not permanent, but constant images being displayed for a long period of time should be avoided.

To alleviate image persistence, turn off the monitor for as long as the previous image was displayed. For example, if an image was on the monitor for one hour and a residual image remains, the monitor should be turned off for one hour to erase the image.

As with all personal display devices, NEC DISPLAY SOLUTIONS recommends displaying moving images and using a moving screen saver at regular intervals whenever the screen is idle or turning off the monitor when not in use.

Please set “SCREEN SAVER”, “DATE & TIME” and “SCHEDULE SETTINGS” functions to further reduce the risk of Image persistence.

For long life use as Public Display

Image Sticking of LCD Panel

When an LCD panel is operated continuously for long hours, a trace of electric charge remains near the electrode inside LCD, and residual or “ghost” image of previous image may be observed. (Image Persistence)

Image Persistence is not permanent, but when fixed image is displayed for long period, ionic impurities inside LCD are accumulated along the displayed image, and may be permanent. (Image Sticking)

Recommendations

To prevent Image Sticking, and for longer life usage of LCD, the following are recommended.

1. Fixed image should not be displayed for long period. Change fixed images after short intervals.
2. When not in use, please turn off the monitor by remote control, or use Power Management or use Schedule Functions.
3. Lower environmental temperatures prolong the lifespan of the monitor.
When Protective surface (glass, acrylic) is installed over the LCD surface, the LCD surface is located in an enclosed space, the monitor are stacked, utilize the temperature sensors inside monitor.
To reduce the environmental temperature, use the Cooling Fan, Screen Saver and Low Brightness.
4. Please use “Screen Saver Mode” of monitor.

Remote Control Function

REMOTE CONTROL ID FUNCTION

REMOTE CONTROL ID

The optional remote control can be used to control up to 100 individual MultiSync monitors using what is called the REMOTE CONTROL ID mode. The REMOTE CONTROL ID mode works in conjunction with the Monitor ID, allowing control of up to 100 individual MultiSync monitors. For example: if there are many monitors being used in the same area, a remote control in normal mode would send signals to every monitor at the same time (see Figure 1). Using the remote in REMOTE CONTROL ID mode will only operate one specific monitor within the group (see Figure 2).

TO SET REMOTE CONTROL ID

While holding down the REMOTE ID SET button on the remote control, use the KEYPAD to input the Monitor ID (1-100) of the display to be controlled via remote. The remote can then be used to operate the monitor having that specific Monitor ID number.

When 0 is selected or when the remote control is in normal mode, all monitors will be operated.

TO SET/RESET REMOTE CONTROL MODE

ID Mode - To enter ID Mode press the REMOTE ID SET button and hold down for 2 seconds.

Normal Mode - To return to Normal Mode press the REMOTE ID CLEAR button and hold down for 2 seconds.

In order for this feature to work properly, the display must be assigned a Monitor ID number. The Monitor ID number can be assigned under the MULTI DISPLAY menu in the OSD (See page 23).

Point the remote control towards the remote sensor of the desired monitor and press the REMOTE ID SET button. The MONITOR ID number is shown on the display when your remote control is in ID mode.

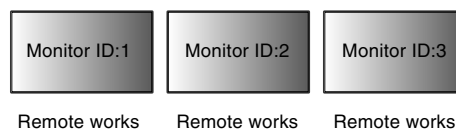

Figure 1
Remote in Normal mode or the REMOTE ID is set to 0

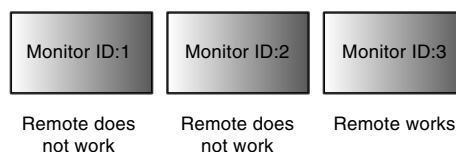

Figure 2
Remote set up to use REMOTE ID:3

You need an optional remote control for this function.

Use the remote control to operate a monitor that has a specific MONITOR ID number assigned to it.

1. Set the MONITOR ID number for the display (See page 23). The MONITOR ID number can range from 1-100. This MONITOR ID number allows the remote control to operate this specific monitor without affecting other monitors.
2. On the remote control, press and hold down the REMOTE ID SET button while using the keypad to input the REMOTE CONTROL ID number (1-100). The REMOTE ID NUMBER should match the MONITOR ID number of the display to be controlled. Choose "0" to simultaneously control all displays in range.
3. Point the remote control towards the remote sensor of the desired monitor and press the REMOTE ID SET button. The MONITOR ID number is shown in red on the display. If the REMOTE CONTROL ID is "0", then all displays in range will show their respective MONITOR ID number in red. If the MONITOR ID number is shown in white on the display, the MONITOR ID number and the REMOTE CONTROL ID are not the same.

This LCD monitor can be controlled via personal computer or wireless remote control using an RS-232C connection.

MONITOR ID and IR CONTROL

Using one PC or one infrared wireless controller, up to 100 individual LCD monitors can be controlled through a daisy chain via RS-232C connection.

1. Connect PC and LCD monitors.

Connect a PC's RS-232C control output to the LCD monitor RS-232C input. You can then connect the RS-232C output from the LCD monitor to another LCD monitor RS-232C input. Up to 100 monitors can be connected using RS-232C.

2. Set Monitor ID and IR Control mode.

For proper operation, the Monitor ID should be set in the OSD menu of each monitor that is in the chain. The Monitor ID can be set under the "MULTI DISPLAY" menu in the OSD. The Monitor ID number can be set within a range from 1 to 100. No two monitors should share the same Monitor ID number. It is recommended to number each monitor in a daisy chain sequentially from 1. The first monitor in the daisy chain is designated as the primary monitor. Subsequent monitors with the chain are secondary monitors.

In the "ADVANCED OPTION" menu on the first monitor in the RS-232C daisy chain set the "IR CONTROL" to "PRIMARY".

Set the "IR CONTROL" to "SECONDARY" on all other monitors.

3. Press the "DISPLAY" button on the remote control while aiming at the "PRIMARY" monitor. The Information OSD will be shown at top left side of the screen.

Monitor ID: Displays the ID number of the current monitor within the daisy chain.

Target ID: Displays the ID number of the monitor that to be controlled via daisy chain from the current monitor.

Press the "+" or "-" buttons to change the "Target ID" to show the ID number of the monitor to be controlled. To control the entire daisy chained monitors simultaneously, select "ALL" as the "Target ID."

4. Use the wireless remote controller to control the "SECONDARY" monitor while aiming at the "PRIMARY" monitor.

The "MENU OSD" will appear on the selected target monitor.

NOTE: If the "ID No." mode select OSD is showing, press the "DISPLAY" button on the remote control while pointing at the "PRIMARY" monitor to clear this OSD.

HINT: If you lost control due to the incorrect setting of "IR CONTROL", pressing the "DISPLAY" button on the remote control for 5 or more seconds will reset the "IR CONTROL" menu to "NORMAL" function.

WIRED REMOTE CONTROL FUNCTION

You can control this monitor by connecting REMOTE IN/OUT with Stereo Mini plug cable (3.5 Φ).

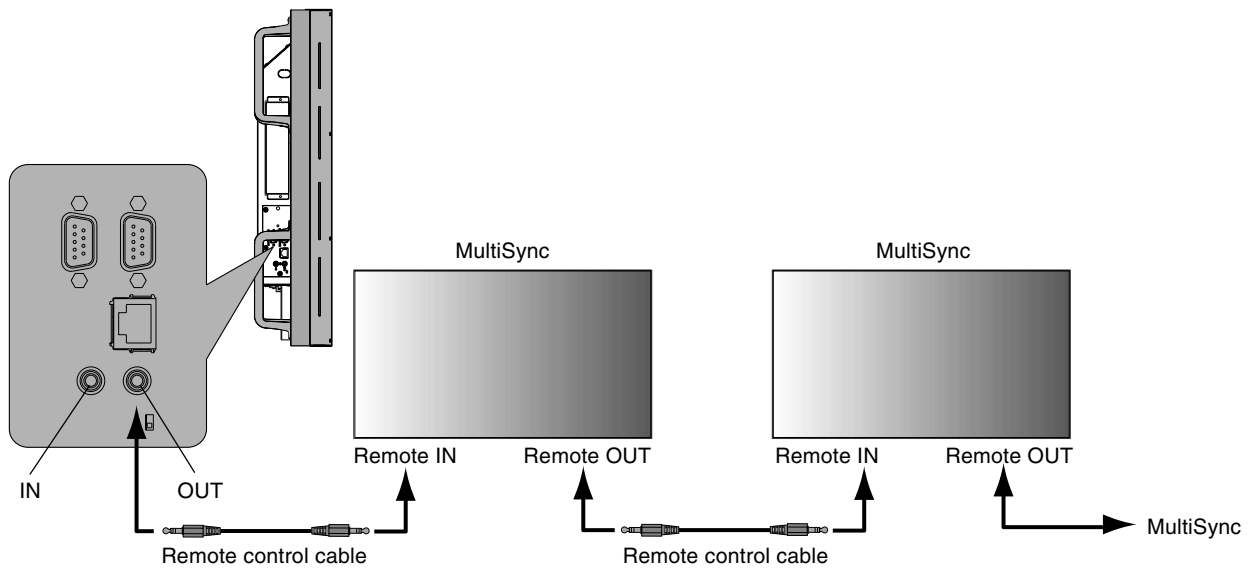

NOTE: Turn off the main power switch before connect/disconnect Stereo Mini plug cable.

Controlling the LCD monitor via RS-232C Remote Control

This LCD monitor can be controlled by connecting a personal computer with a RS-232C terminal.

NOTE: When you use this function, EXTERNAL CONTROL should be "RS-232C".

Functions that can be controlled by a personal computer are:

- Power ON or OFF
- Switching between input signals

Connection

LCD Monitor + PC

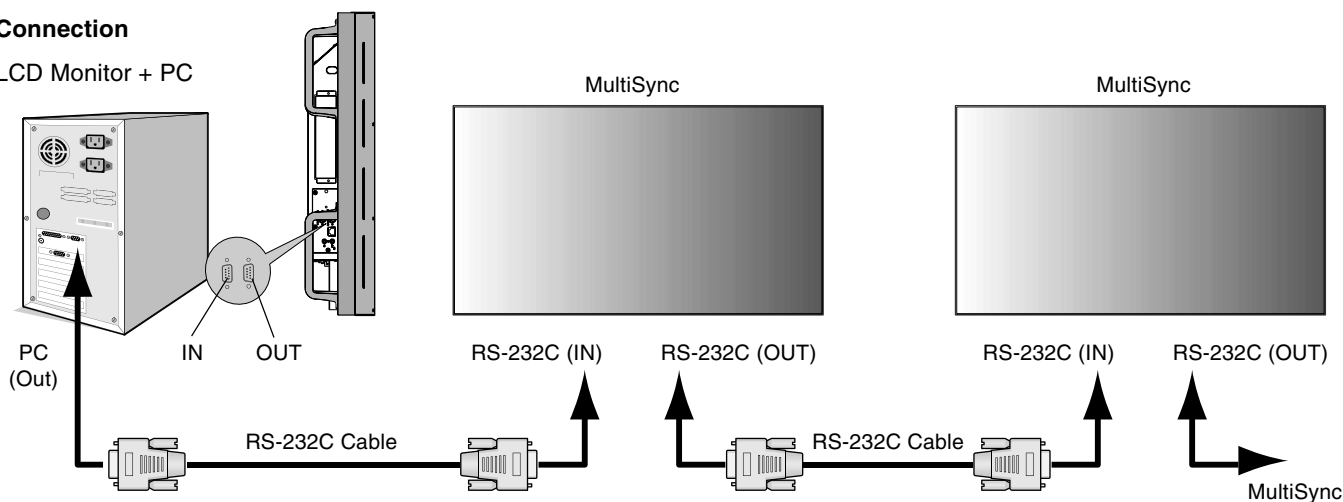

NOTE: If your PC (IBM or IBM compatible) is equipped only with a 25-pin serial port connector, a 25-pin serial port adapter is required. Contact your dealer for details.

* In order to function, the RS-232C OUT terminal can only be connected to another monitor of the same model. Do not connect to other types of equipment.

To control monitor or multiple monitors that are daisy-chained together please use the control command. Instructions for the control command can be found on the CD included with the display. The file is called "External_control.pdf".

1) Interface

PROTOCOL	RS-232C
BAUD RATE	9600 [bps]
DATA LENGTH	8 [bits]
PARITY BIT	NONE
STOP BIT	1 [bit]
FLOW CONTROL	NONE

This LCD monitor uses RXD, TXD and GND lines for RS-232C control.

2) Control command diagram

Please see file "External_Control.pdf" on the CD-ROM.

Controlling the LCD monitor via LAN Control

Connecting to a Network

Using a LAN cable allows you to specify the Network Settings and the Alert Mail Settings by using an HTTP server function.

NOTE: When you use this function, EXTERNAL CONTROL should be "LAN".

To use a LAN connection, you are required to assign an IP address.

Example of LAN connection:

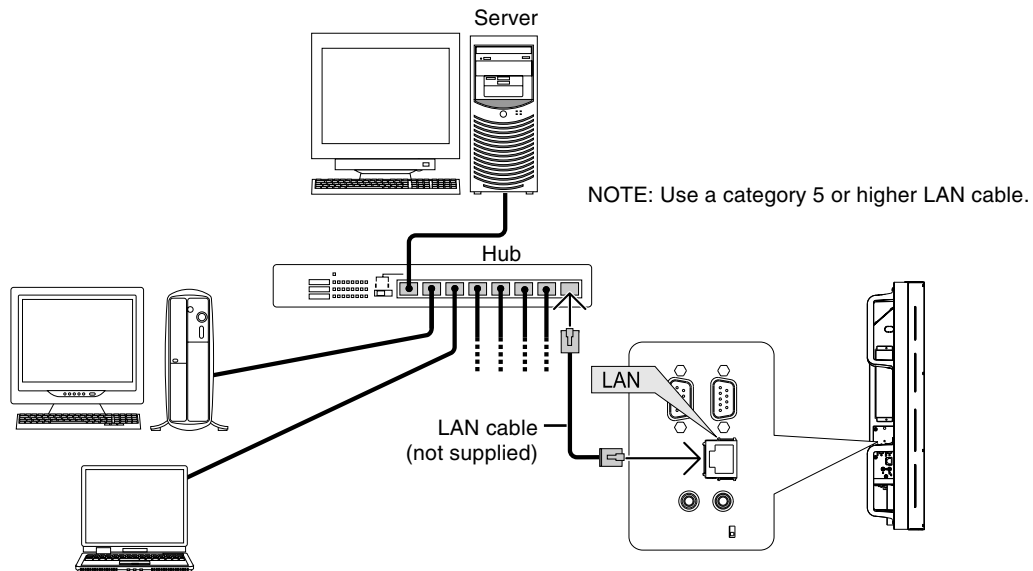

Network Setting by Using an HTTP Browser

Overview

Connecting the monitor to a network allows for monitor control from a computer via the network.

To perform the monitor control from a web browser, you must have an exclusive application installed on your computer.

The IP address and subnet mask of the monitor can be set on the Network Setting screen of the web browser by using an HTTP server function. Please be sure to use "Microsoft Internet Explorer 6.0" or a higher version for the web browser. (This device uses "JavaScript" and "Cookies" and the browser should be set to accept these functions. The setting method will vary depending on the version of browser. Please refer to the help files and the other information provided in your software.)

Access is gained to the HTTP server function by starting the Web browser on the computer via the network connected to the monitor and entering the following URL.

Network Setting

`http://<the Monitor's IP address>/index.html`

TIP: The default IP address is "192.168.0.10".

NOTE: If the MONITOR NETWORK SETTINGS screen does not appear in the web browser, press the Ctrl+F5 keys to refresh your web browser (or clear the cache).

The display or button's response can be slowed down or operation may not be accepted depending the settings of your network.

Should this happen, consult your network administrator.

The LCD monitor may not respond if its buttons are repeatedly pressed in rapid intervals. Should this happen, wait a moment and repeat.

If you still can't get a response, turn off and back on the monitor.

Alert Mail Setting

http://<the Monitor's IP address>/lanconfig.html

MONITOR NETWORK SETTINGS

ITEM	VALUE
DOMAIN	
HOST NAME	<input type="text"/>
DOMAIN NAME	<input type="text"/>
MAIL	
ALERT MAIL	<input type="radio"/> ENABLE <input checked="" type="radio"/> DISABLE
SENDER'S ADDRESS	<input type="text"/>
SMTP SERVER NAME	<input type="text"/>
RECIPIENT'S ADDRESS 1	<input type="text"/>
RECIPIENT'S ADDRESS 2	<input type="text"/>
RECIPIENT'S ADDRESS 3	<input type="text"/>
<input type="button" value="APPLY"/>	
TEST MAIL	
<input type="button" value="EXECUTE"/>	STATUS
<input type="text"/>	

Copyright (C) NEC Display Solutions, Ltd. 2008. All rights reserved.

This option notifies your computer of an error message via e-mail when using wired LAN. An error message notification will be sent when an error occurs in the monitor.

HOST NAME	Type in the hostname of the network connected to the monitor. Up to 60 alphanumeric characters can be used.
DOMAIN NAME	Type in the domain name of the network connected to the monitor. Up to 60 alphanumeric characters can be used.
ALERT MAIL	Checking [ENABLE] will turn on the Alert Mail feature. Checking [DISABLE] will turn off the Alert Mail feature.
SENDER'S ADDRESS	Type in the senders address. Up to 60 alphanumeric and symbols characters can be used.
SMTP SERVER NAME	Type in the SMTP server name to be connected to the monitor. Up to 60 alphanumeric characters can be used.
RECIPIENT'S ADDRESS 1 to 3	Type in your recipient's address. Up to 60 alphanumeric and symbols characters can be used.
APPLY	Click this button to reflect the above settings.
EXECUTE	Click this button to send a test mail to check if your settings are correct.
STATUS	A reply to a test mail will be displayed.

- NOTE:**
- If you execute a test, you may not receive an Alert mail.
Should this happen, check if the network settings are correct.
 - If you entered an incorrect address in a test, you may not receive an Alert mail.
Should this happen, check if the Recipient's Address is correct.

TIP: The Alert Mail settings will not be affected even when [RESET] is done from the menu.

Features

Ultra Narrow Bezel: Provides the optimum solution in a tiling environment.

Reduced Footprint: Provides the ideal solution for environments requiring superior image quality but with size and weight limitations.

Color Control Systems: Allows you to adjust the colors on your screen and customize the color accuracy of your monitor to a variety of standards.

OmniColor: Combines Six-axis color control and the sRGB standard. Six-axis color control permits color adjustments via six axes (R, G, B, C, M and Y) rather than through the three axes (R, G and B) previously available. The sRGB standard provides the monitor with a uniform color profile. This assures that the colors displayed on the monitor are exactly the same as on the color printout (with sRGB supporting operating system and sRGB printer). This allows you to adjust the colors on your screen and customise the color accuracy of your monitor to a variety of standards.

sRGB Color Control: A new optimized color management standard which allows for color matching on computer displays and other peripherals. The sRGB standard, which is based on a calibrated color space, allows for optimal color representation and backward compatibility with other common color standards.

OSD (On-Screen-Display) Controls: Allow you to quickly and easily adjust all elements of your screen image via simple to use on-screen menus.

Plug and Play: The Microsoft® solution with the Windows® operating system facilitates setup and installation by allowing the monitor to send its capabilities (such as screen size and resolutions supported) directly to your computer, automatically optimizing display performance.

IPM (Intelligent Power Manager) System: Provides innovative power-saving methods that allow the monitor to shift to a lower power consumption level when on but not in use, saving two-thirds of your monitor energy costs, reducing emissions and lowering the air conditioning costs of the workplace.

FullScan Capability: Allows you to use the entire screen area in most resolutions, significantly expanding image size.

VESA Standard (FDMLv1) Mounting Interface: Allows users to connect their LCD monitor to any VESA standard (FDMLv1) third party mounting arm or bracket. Allows for the monitor to be mounted on a wall or an arm using any third party compliant device. NEC recommends using mounting interface that comply with TÜV-GS and/or UL1678 standard in North America.

DVI-D: The digital-only subset of DVI ratified by the Digital Display Working Group (DDWG) for digital connections between computers and displays. As a digital-only connector, analog support is not provided for a DVI-D connector. As a DVI-based digital only connection, only a simple adapter is necessary for compatibility between DVI-D and other DVI-based digital connectors such as DFP and P&D. The DVI interface of this display supports HDCP.

TILE MATRIX, TILE COMP: Shows one image over multiple screens with accuracy while compensating for bezel width.

ZOOM: Expands image size for horizontal and vertical direction.

RS-232C daisy chain: You can control the multiple monitors by controller or wireless remote controller.

Self-diagnosis: If an internal error should occur, a failure state will be indicated.

Long cable capability: Automatic long cable compensation prevents image quality degradation (dull signals) caused by long cable lengths.

Troubleshooting

No picture

- The signal cable should be completely connected to the display card/computer.
- The display card should be completely seated in its slot.
- Front Power Switch and computer power switch should be in the ON position.
- Check to make sure that a supported mode has been selected on the display card or system being used. (Please consult display card or system manual to change graphics mode.)
- Check the monitor and your display card with respect to compatibility and recommended settings.
- Check the signal cable connector for bent or pushed-in pins.

Power Button does not respond

- Unplug the power cord of the monitor from the AC outlet to turn off and reset the monitor.

Image persistence

- Please be aware that LCD Technology may experience a phenomenon known as Image Persistence. Image Persistence occurs when a residual or “ghost” image of a previous image remains visible on the screen. Unlike CRT monitors, LCD monitors’ image persistence is not permanent, but constant images being displayed for a long period of time should be avoided. To alleviate image persistence, turn off the monitor for as long as the previous image was displayed. For example, if an image was on the monitor for one hour and a residual image remains, the monitor should be turned off for one hour to erase the image.

NOTE: As with all personal display devices, NEC DISPLAY SOLUTIONS recommends displaying moving images and using a moving screen saver at regular intervals whenever the screen is idle or turning off the monitor when not in use.

Image is unstable, unfocused or swimming is apparent

- Signal cable should be completely attached to the computer.
- Use the OSD Image Adjust controls to focus and adjust display by increasing or decreasing the fine adjustment. When the display mode is changed, the OSD Image Adjust settings may need to be re-adjusted.
- Check the monitor and your display card with respect to compatibility and recommended signal timings.
- If your text is garbled, change the video mode to non-interlace and use 60Hz refresh rate.

Image of component signal is greenish

- Check to see if the DVD/HD input connector is selected.

LED on monitor is not lit

(no green or red color can be seen)

- Power Switch should be in the ON position and power cord should be connected.
- Make certain the computer is not in a power-saving mode (touch the keyboard or mouse).

RED LED on monitor is blinking

- A certain failure might have occurred, please contact your nearest authorized NEC DISPLAY SOLUTIONS service facility.
- If the monitor is powered off by the inside temperature being higher than the normal operating temperature, a RED LED will blink six times. Power on the display again after confirming the inside temperature has been reduced to normal operation temperature.

Display image is not sized properly

- Use the OSD Image Adjust controls to increase or decrease the coarse adjustment.
- Check to make sure that a supported mode has been selected on the display card or system being used. (Please consult display card or system manual to change graphics mode.)

Selected resolution is not displayed properly

- Use OSD Display Mode to enter Information menu and confirm that the appropriate resolution has been selected. If not, select corresponding option.

No Sound

- Check to see if audio cable is properly connected.
- Check to see if mute is activated.
- Check to see if volume is set at minimum.

Remote Control is not available

- Check the Remote Control’s batteries status.
- Check if batteries are inserted correctly.
- Check if the Remote Control is pointing at the monitor’s remote sensor.
- Check the Remote Control Mode status.
- The remote control system may not function when direct sunlight or strong illumination strikes the remote control sensor of the LCD monitor, or when there is an object in the path.

“SCHEDULE”/“OFF TIMER” function is not working properly

- The “SCHEDULE” function will be disabled when the “OFF TIMER” is set.
- If the “OFF TIMER” function is enabled and the power to the LCD monitor is turned off when the power supply is interrupted unexpectedly, then the “OFF TIMER” will be reset.

Snowy Picture, Poor Sound in TV

- Check antenna/cable connection. Use new cable if necessary.

Interference in TV

- Check components for shielding, move away from monitor if necessary.

RS-232C or LAN control is not available

- Check RS-232C or LAN cable connection.
- Check “CONTROL” setting in “EXTERNAL CONTROL”.

Either light vertical or horizontal stripes may appear, depending on the specific display pattern. This is no product fault or degradation.

Specifications

Product Specifications

LCD Module		Pixel Pitch:	46" /116.8 cm diagonal
		Resolution:	0.746 mm
		Color:	1366 x 768 dots
		Brightness:	Over 16 million colors (depending on video card used)
		Contrast Ratio:	700 cd/m ² (Max.), 500 cd/m ² (Typ.)
		Viewing Angle:	3000:1
		Design View Distance:	89° (typ) @ CR>10
			1300 mm
Frequency		Horizontal:	15.625/15.734 kHz, 31.5 kHz - 91.1 kHz (Analog Input)
		Vertical:	31.5 kHz - 91.1 kHz (Digital Input)
			50.0 - 85.0 Hz
Pixel Clock		25.2 MHz - 162.0 MHz	
Viewable Size		1018.4 x 572.5 mm	
Input Signal			
DVI	DVI-D 24pin	Digital RGB	DVI (HDCP) VGA60, SVGA60, XGA60, WXGA60, SXGA60, UXGA60*1, 1920X1080*1 (60Hz)
VGA	15pin Mini D-sub	Analog RGB	0.7 Vp-p/75 ohm VGA60, SVGA60, XGA60, WXGA60, SXGA60, UXGA60*1, 1920X1080*1 (60Hz)
		Sync	Separate: TTL level (Pos./Neg.) Composite sync on Green Video: 0.3 Vp-p Neg.
RGB/HV	BNC (R,G,B,H,V)	Analog RGB	0.7 Vp-p/75 ohm VGA60, SVGA60, XGA60, WXGA60, SXGA60, UXGA60*1, 1920X1080*1 (60Hz)
		Sync	Separate: TTL level (Pos./Neg.) Composite sync on Green Video: 0.3 Vp-p Neg.
HDMI	HDMI Connector	Digital RGB	HDMI 1080p*1, 1080i*1, 720p@50Hz/60Hz, 576p@50Hz, 480p@60Hz
DVD/HD1 DVD/HD2	RCA (Y, Cb/Pb, Cr/Pr) BNC	Component	Y: 1.0 Vp-p/75ohm, Cb/Cr (Pb/Pr): 0.7 Vp-p/75 ohm HDTV/DVD:1080p*1, 1080i*1, 720p@50Hz/60Hz, 576p@50Hz, 480p@60Hz, 576i@50Hz, 480i@60Hz
VIDEO1 VIDEO2	BNC/RCA BNC	Composite	1.0 Vp-p/75 ohm NTSC/PAL/SECAM/4.43NTSC/PAL60
S-VIDEO	Mini DIN 4 pin	S-VIDEO	Y: 1.0 Vp-p/75 ohm C: 0.286 Vp-p/75 ohm (NTSC), 0.3 Vp-p/75 ohm (PAL/SECAM) NTSC/PAL/SECAM/4.43NTSC/PAL60
Output Signal			
RGB/HV	BNC (R,G,B,H,V)	Analog RGB	0.7 Vp-p with 75 ohm terminated Separate HV sync: TTL level (Posi / Nega)
DVD/HD2	BNC	Component	Y: 1.0 Vp-p/75ohm, Cb/Cr (Pb/Pr): 0.7 Vp-p/75 ohm
VIDEO1/VIDEO2	BNC	Composite	1.0 Vp-p with 75 ohm terminated
AUDIO			
AUDIO Input	RCA (L/R) X2 STEREO Mini Jack	Analog Audio	Stereo L/R 0.5 Vrms
	HDMI Connector	Digital Audio	PCM 32, 44.1, 48 KHz (16/20/24bit)
AUDIO Output	RCA (L/R)	Analog Audio	Stereo L/R 0.5 Vrms
Control		RS-232C In:	9 Pin D-sub
		RS-232C Out:	9 Pin D-sub (with daisy chain)
		LAN:	RJ-45 10/100 BASE-T
		Remote IN:	Stereo Mini jack 3.5 ϕ
		Remote OUT:	Stereo Mini jack 3.5 ϕ
TV*2		Antenna:	F-connector Impedance 75 ohm
		Channel Coverage:	VHF: 2 - 13 ch UHF: 14 - 69 ch CATV: 1 - 130 ch ATSC (8VSB): 2 - 69 ch 64/256 QAM : 1 - 135 ch
Power Supply		3.6 - 1.45 A @ 100-240VAC, 50/60Hz	
Operational Environment		Temperature:	5 - 40°C (Default brightness), 5 - 20°C (Max brightness)
		Humidity:	20 - 80% (without condensation)
		Altitude:	0 - 3000 m
Storage Environment		Temperature:	-20 - 60°C
		Humidity:	10 - 90% (without condensation)/ 90% - 3.5% x (Temp - 40°C) regarding over 40°C
Dimension		1025.7 (W) x 579.8 (H) x 128.1 (D) mm (without stand)	
Weight		29.3 Kg (without stand)	
VESA compatible arm mounting interface		300 mm x 300 mm (M6, 4 Holes)	
Complied Regulatory and Guidelines		UL60950-1/CSA C22.2 No.60950-1/ TUV-GS/EN60950-1 FCC-A/DOC-A/EN55022-A/EN55024/EN61000-3-2/EN61000-3-3/CE/GOST-R	
Power Management		VESA DPM	
Plug & Play		VESA DDC2B, DDC/CI	
Accessories		Setup manual, Power Cord, Video Signal cable, Stereo Mini plug cable (3.5 ϕ), Clamp x 3, Screw x 9, CD-ROM, Thumbscrew for stand x 2, Cable cover	

NOTE: Technical specifications are subject to change without notice. *1: Compressed image *2: The product you purchased may not have this feature.

Pin Assignment

1) Analog RGB input (MiniDsub15p): VGA

Pin No	Name	Pin No	Name
1	Video Signal Red	9	+5V (DDC)
2	Video Signal Green	10	SYNC-GND
3	Video Signal Blue	11	GND
4	GND	12	DDC-SDA
5	DDC-GND	13	H-SYNC
6	Red-GND	14	V-SYNC
7	Green-GND	15	DDC-SCL
8	Blue-GND		

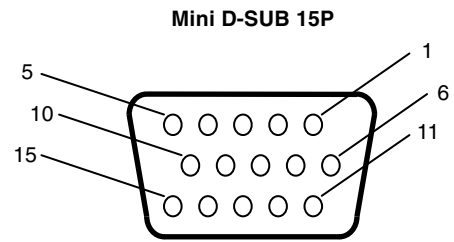

2) S-VIDEO input: VIDEO

Pin No	Name
1	GND
2	GND
3	Y (Luminance)
4	C (Chroma)

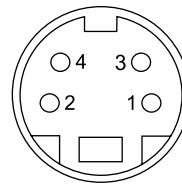

3) Digital RGB input (DVI-D): DVI

Pin - Assignment of DVI connector:					
1	TX2-	9	TX1-	17	TX0-
2	TX2+	10	TX1+	18	TX0+
3	Shield (TX2 / TX4)	11	Shield (TX1 / TX3)	19	Shield (TX0 / TX5)
4	NC	12	NC	20	NC
5	NC	13	NC	21	NC
6	DDC-Serial Clock	14	+5V power	22	Shield (TXC)
7	DDC-Serial Data	15	Ground	23	TXC+
8	NC	16	Hot plug detect	24	TXC-

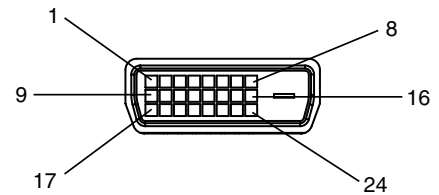

4) RS-232C input/output

Pin No	Name
1	connected to 7&8
2	RXD
3	TXD
4	connected to 6
5	GND
6	connected to 4
7	connected to 1&8
8	connected to 1&7
9	NC

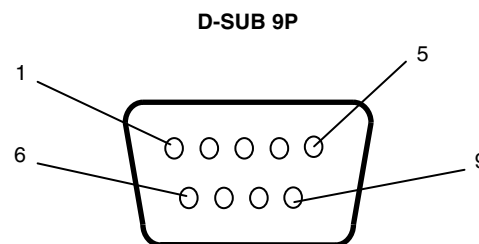

This LCD monitor uses RXD, TXD and GND lines for RS-232C control.

5) REMOTE IN

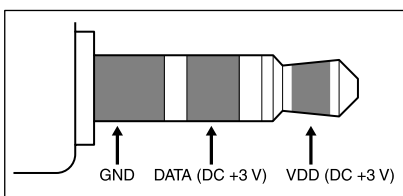

6) REMOTE OUT

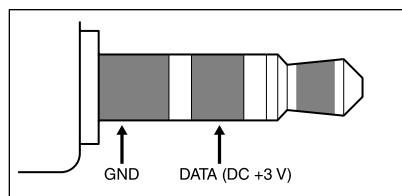

Manufacturer's Recycling and Energy Information

NEC DISPLAY SOLUTIONS is strongly committed to environmental protection and sees recycling as one of the company's top priorities in trying to minimize the burden placed on the environment. We are engaged in developing environmentally-friendly products, and always strive to help define and comply with the latest independent standards from agencies such as ISO (International Organisation for Standardization) and TCO (Swedish Trades Union).

Disposing of your old NEC product

The aim of recycling is to gain an environmental benefit by means of re-use, upgrading, reconditioning or reclamation of material. Dedicated recycling sites ensure that environmentally harmful components are properly handled and securely disposed. To ensure the best recycling of our products, **NEC DISPLAY SOLUTIONS offers a variety of recycling procedures** and gives advice on how to handle the product in an environmentally sensitive way, once it has reached the end of its life.

All required information concerning the disposal of the product and country-specific information on recycling facilities can be found on our following websites:

<http://www.nec-display-solutions.com/greencompany/> (in Europe),

<http://www.nec-display.com> (in Japan) or

<http://www.necdisplay.com> (in USA).

Energy Saving

This monitor features an advanced energy saving capability. When a VESA Display Power Management Signalling (DPMS) Standard signal is sent to the monitor, the Energy Saving mode is activated. The monitor enters a single Energy Saving mode.

Mode	Power consumption	LED colour
Normal Operation	Approx. 200 W	Green
Energy Saving Mode	Less than 2 W	Amber Blinking
Power Off (STANDBY)	Less than 2 W	Amber
Power Off (Eco standby)	Less than 0.5 W	Red

WEEE Mark (European Directive 2002/96/EC)



Within the European Union

EU-wide legislation, as implemented in each Member State, requires that waste electrical and electronic products carrying the mark (left) must be disposed of separately from normal household waste. This includes monitors and electrical accessories, such as signal cables or power cords. When you need to dispose of your NEC display products, please follow the guidance of your local authority, or ask the shop where you purchased the product, or if applicable, follow any agreements made between yourself and NEC.

The mark on electrical and electronic products only applies to the current European Union Member States.

Outside the European Union

If you wish to dispose of used electrical and electronic products outside the European Union, please contact your local authority so as to comply with the correct disposal method.

Free Manuals Download Website

<http://myh66.com>

<http://usermanuals.us>

<http://www.somanuals.com>

<http://www.4manuals.cc>

<http://www.manual-lib.com>

<http://www.404manual.com>

<http://www.luxmanual.com>

<http://aubethermostatmanual.com>

Golf course search by state

<http://golfingnear.com>

Email search by domain

<http://emailbydomain.com>

Auto manuals search

<http://auto.somanuals.com>

TV manuals search

<http://tv.somanuals.com>