

MITEL

3300 | IP Communications Platform

MITEL 5330 IP and 5340 IP Phones
User Guide

 MITEL | it's about **YOU**

NOTICE

The information contained in this document is believed to be accurate in all respects but is not warranted by Mitel Networks™ Corporation (MITEL®). The information is subject to change without notice and should not be construed in any way as a commitment by Mitel or any of its affiliates or subsidiaries. Mitel and its affiliates and subsidiaries assume no responsibility for any errors or omissions in this document. Revisions of this document or new editions of it may be issued to incorporate such changes.

No part of this document can be reproduced or transmitted in any form or by any means - electronic or mechanical - for any purpose without written permission from Mitel Networks Corporation.

TRADEMARKS

Mitel and Speak@Ease are trademarks of Mitel Networks Corporation.

Windows and Microsoft are trademarks of Microsoft Corporation.

Other product names mentioned in this document may be trademarks of their respective companies and are hereby acknowledged.

Mitel 5330 IP and 5340 IP Phones - User Guide

March 2008

®,™ Trademark of Mitel Networks Corporation

© Copyright 2008, Mitel Networks Corporation

All rights reserved

ABOUT YOUR PHONE	8
Elements of Your Phone	9
Ring/Message indicators	11
For Users on Resilient 3300 ICP Systems	11
Mitel Line Interface Module.....	11
TIPS FOR YOUR COMFORT AND SAFETY	12
Don't cradle the handset!.....	12
Protect your hearing	12
Adjust the viewing angle	12
USING YOUR DEFAULT PHONE WINDOW AND KEYS.....	13
Getting Started with Your Phone	13
ABOUT YOUR PHONE APPLICATIONS.....	15
Using the Settings Application	16
Using the Call History Application.....	17
Getting Help.....	19
Tips for Setting up your Phone	19
CUSTOMIZING YOUR PHONE	20
Using the Dial Pad to Enter Information	20
Using the On-Screen Keyboard to Enter Information	21
Specify User Information.....	21
Specify Language.....	22
Specify Display Brightness and Contrast	22
Specify Audio Feedback Options	23
Specify Text Size	23
Specify Call Notification Behavior.....	24
Adjust the Ringer	24
Enable a Screen Saver (5340 only).....	25
Program Receipt of External Messaging	26

Enable URL Displays on your Phone	26
Enable PC Connectivity	26
USING THE PC COMPANION APPLICATION	27
About the PC Companion Application	27
Configuring the PC Companion Application on Your Phone	27
Installing the PC Companion Application	27
Opening the PC Companion Application	28
Programming Feature Keys Using the PC Companion Application.....	29
Clearing, Editing or Copying Key Programming	30
PROGRAMING FEATURES ON YOUR KEYS.....	31
Tips on Programming Features	31
Program Feature Keys Using the Settings Application	34
Clear Programming from a Key.....	35
SETTING UP YOUR CONTACT LIST (5340 ONLY)	36
Adding names to your contact list	36
Editing information in your contact list	36
MAKING AND ANSWERING CALLS.....	37
Dial from your People Application (5340 IP Phone only).....	37
Phone Book.....	37
Answer a call.....	38
End a call.....	38
Redial	38
Redial - Saved Number	39
Handsfree Operation	39
Auto-Answer.....	40
Using the Analog line	40
CALL HANDLING.....	41
Hold.....	41

Mute	41
Transfer	42
Conference	42
Conference Split.....	42
Add Held.....	43
Swap.....	43
Call Forwarding	43
USING OTHER FEATURES.....	47
Account Codes	47
ACD	47
Attendant Call Hold - Remote Retrieve.....	48
Callback	48
Call Forward - Remote (I'm Here)	48
Call Forward - End Chaining.....	49
Call Forward - Forced.....	49
Call Forward - Override.....	50
Call Park.....	50
Call Pickup.....	51
Campon	51
Direct Paging	51
Do Not Disturb.....	55
Emergency Calls	55
Float Keys (5340 IP Phone).....	57
Group Listen	60
Group Paging / Meet Me Answer	60
Headset Operation.....	61
Hot Desking	62
Hot Desk Remote Logout	62

Hot Desk - PIN Change	63
Make Busy	63
Message Waiting Indicator	64
Messaging - Advisory	64
Messaging - Callback.....	64
Messaging - Cancel Callback.....	66
Messaging - Cancel All Callbacks	66
Music.....	66
Night Answer	66
Override (Intrude)	67
Paging	67
Record a Call.....	67
Reminder.....	68
Speak@Ease.....	69
Speed Call	69
Tag Call.....	69
Trunk Flash	70
VISUAL VOICE MAIL (5340 IP Phone Only)	71
Set up your mailbox	71
Enable Visual Voice Mail.....	71
Opening the Visual Voice Mail application.....	71
Log into your mailbox from your own extension	71
Log into your mailbox from another extension	72
Log out of your mailbox	72
About the Visual Voice Mail main window	73
Display message details	74
Play a voice message	75
Dial message sender.....	75

Save a message	76
Delete a message.....	76
Add a message sender to your contacts list.....	76
Forward a message to another mailbox.....	76
Forward a message to your email address	77
USING YOUR PHONE WITH THE 5310 IP CONFERENCE UNIT	78
Access the Conference Controller.....	78
Turn the conference unit on and off.....	78
Adjust the conference unit volume	78
Place the conference unit in Presentation mode.....	78
Exit the conference controller.....	78
Mute the conference unit.....	79
USING THE LINE INTERFACE MODULE	79
Making and Answering Calls Using the Analog key.....	79
Making and Answering Calls Using the Failover Mode.....	80
USING YOUR PHONE WITH THE CORDLESS MODULE AND ACCESSORIES	81
USING THE CORDLESS HANDSET	85
USING THE CORDLESS HEADSET.....	89
USING THE CORDLESS DEVICES APPLICATION.....	92

ABOUT YOUR PHONE

The Mitel® 5330 and 5340 IP Phones are full-feature, dual port, dual mode enterprise-class telephones that provide voice communication over an IP network. They both feature a large graphics display (160 x 320) and self-labeling keys. The 5330 IP Phone offers 24 programmable multi-function keys and the 5340 IP Phone offers 48 programmable multi-function keys for one-touch feature access. Both phones provide ten fixed feature keys for convenient access to features such as Conferencing, Redial, and many customizable user settings as well as navigational keys to access various screens and application layers. The 5330 and 5340 IP Phones also feature a PC Companion application, which is a PC-based desktop programming tool, that allows you to easily configure your phone from your Personal Computer (PC).

The 5330 and 5340 IP Phones support Mitel Call Control (MiNet) protocol and session initiated protocols (SIP). Both phones support the Line Interface Module and 5310 IP Conference Unit. Additionally, they support Hot Desking and Clustered Hot Desking as well as Resiliency. The 5330/5340 phones are ideal for executives and managers, and can be used as an ACD Agent or Supervisor Phone, as well as a Teleworker Phone.



NN0220

The 5330 IP Phone









NN0218

The 5340 IP Phone

Elements of Your Phone

Feature	Function
1) Display	Provides a large, high-resolution viewing area that assists you in selecting and using phone features.
2) Ring/Message Indicator	Flashes to signal an incoming call and to indicate a message waiting in your voice mailbox.
3) Volume, Speaker and Mute Controls	Provide the following audio control capability: <ul style="list-style-type: none"> ▲ (UP) and ▼ (DOWN) provide volume control for the ringer, handset, and handsfree speakers. 🔊 (SPEAKER) enables and disables Handsfree mode.

Elements of Your Phone

Feature	Function
	<ul style="list-style-type: none">•  (MUTE) enables Mute, which allows you to temporarily turn your phone's handset, headset or handsfree microphone off during a call.
4) Fixed Function Keys	<p>Give you access to the following phone functions:</p> <ul style="list-style-type: none">•  (APPLICATIONS): provides access to menus for your phone's applications and settings.•  (CANCEL): ends a call when pressed during the call, and, when you are programming the phone, eliminates any input and returns to the previous menu level.•  (REDIAL): calls the last number dialed.•  (HOLD): places the current call on hold.•  (TRANS/CONF): initiates a call transfer or establishes a three-party conference call.•  (MESSAGE): provides access to your voice mailbox and flashes to notify you of messages waiting in your voice mailbox. Note: The Ring/Message indicator also flashes when messages are waiting.
5) Keypad	Use to dial.
6) Navigation Page Keys	Use to display additional pages of information. The 5330 has two page navigation keys: Back and Next. The 5340 has three page navigation keys: Back, Next, and Home.
7) Programmable Feature Keys and Softkeys.	Provides 24 (on the 5330) and 48 (on the 5340) self-labeling keys that can be programmed as speed call keys, fixed function keys, hard keys, applications, or line appearance keys, according to your communication needs. On your home page, the bottom right feature key is always your Prime Line key on a 5340 IP Phone; and the bottom left feature key is always your Prime Line key on the 5330 IP Phone. The top three keys are softkeys.
8) Handsfree Speaker	Provides sound for Handsfree calls and background music.
9) Handset	Use for handset calls. If you are in headset or handsfree mode, you do not need to use the handset.

Ring/Message indicators

When indicator is it means that

Flashing rapidly	Your phone is ringing
Flashing slowly	A message or callback message is waiting at your phone
On	Your phone is ringing another phone
Off	Your phone is idle, or you are on a call

For Users on Resilient 3300 ICP Systems

If during a call, you hear a beep repeated every 20 seconds it means that your phone is switching to a secondary 3300 ICP system. The call continues and there is a change in the operation of some keys and features on your phone. Normal operation resumes when your phone switches back to the primary system. If your phone is idle and switched to the secondary system, you'll see a flashing rectangle on the display. The rectangle remains until the switch to the primary system is complete.

If the phone fails over to the secondary ICP, you have access to your mailbox on the secondary ICP only if your Administrator has programmed a mailbox for you.

Notes:

- The mailbox on the secondary ICP will not contain the same messages as the mailboxes on the primary ICP. Any preferences that are voice mail related are not carried from the primary ICP to the secondary ICP. These preferences must be set on both ICPs.
- The *People* and *Settings* applications do not support resiliency. Your logs, contact information and any Settings on the primary ICP will not be carried from the primary ICP to the secondary ICP.

Mitel Line Interface Module

The Line Interface module is an optional device that adds an analog phone line (POTS) capability to your phone. If Emergency Call Routing is not programmed on your 3300 ICP, you must use the Line Interface Module to dial emergency calls. For more information on emergency number dialing, refer to *Emergency Calls*. If you have a Line Interface Module connected to your phone, all programming of the Line Interface Module, except the Analog Key, is done by the Installer when your phone is installed. For more information, refer to [Programming Features on Your Keys](#) and [Using the Line Interface Module](#).

TIPS FOR YOUR COMFORT AND SAFETY

Don't cradle the handset!

Prolonged use of the handset can lead to neck, shoulder, or back discomfort, especially if you cradle the handset between your ear and shoulder. If you use your phone a lot, you may find it more comfortable to use a headset. See the section on headset usage elsewhere in this guide for more information.

Protect your hearing

Your phone has a control for adjusting the volume of the handset receiver or headset. Because continuous exposure to loud sounds can contribute to hearing loss, keep the volume at a moderate level.

Adjust the viewing angle

The stand built into your phone tilts to give you a better view of the keys.

To tilt your telephone for better viewing:

1. Turn the phone so that the front faces away from you.
2. Hold the base unit firmly and press the release tabs on the sides of the stand to detach the base unit.
3. Hinge the hooks of the base unit into the notches on the back of the phone and snap into place as follows:
 - a) For a high-angle mount, hinge the two lower hooks into the bottom set of notches and snap the two upper hooks into the middle set of notches.
 - b) For a low-angle mount, hinge the two lower hooks into the middle set of notches and snap the two upper hooks into the top set of notches.

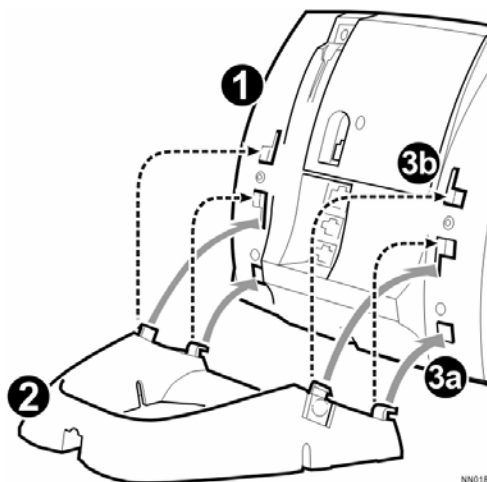

USING YOUR DEFAULT PHONE WINDOW AND KEYS

The 5340 and 5330 IP Phone default phone windows and keys are shown and described below. The Phone window provides access to programmable keys and the main phone interface.



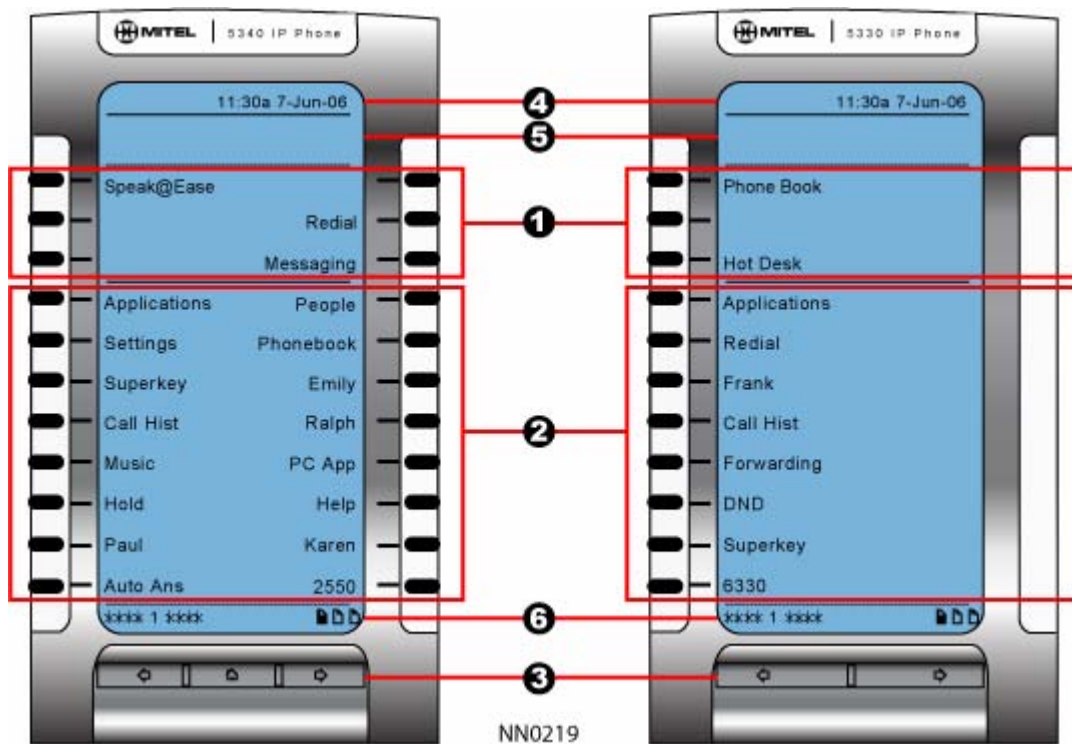

Getting Started with Your Phone

When you receive your phone, you need to program features and applications. Press the blue **Applications** key  to access your phone's applications. You can then program your phone's settings, your contact list using **People** (5340 IP Phone), Call Forwarding and so forth. See [Using Your Phone Applications](#).



5340 and 5330 IP Phone Window

5340 and 5330 IP Phone Default Window and Keys

Feature	Function
1) Softkeys	Allow you to access specific call control features, which are context sensitive. Non-programmable feature keys, which are specific to the application or state of the set. The 5330 provides three softkeys and the 5340 provides six softkeys.
2) Programmable Keys	Launch specific call control features. Use the <i>Settings</i> application or the PC Companion application to program these keys. The 5340 provides 16 programmable keys per page (a maximum of 47 programmable keys plus 1 prime line key). The 5330 provides 8 per page (a maximum of 23 programmable keys plus 1 prime line key). For instructions on programming the keys, see Programming Features on Your Keys .
3) Navigation Page Keys	Display additional pages of information The 5330 has two page navigation keys: Back and Next, while the 5340 has three page navigation keys: Back, Home, and Next.
4) Status Line	Displays time, date, and icons indicating feature states as follows: <ul style="list-style-type: none"> • Message Waiting () - Indicates new voice mail. • Headset () - Indicates that the phone is in headset mode. • DND () - Indicates DND (Do not disturb) mode. • Logged in as () - Indicates that a hot desk user is logged in. • Conference Unit () - Indicates that the Conference Unit is connected and turned on.
5) Information Area	Provides prompts in most phone applications. Content changes based on the application.
6) Footer	Shows context and summary information based on information in the Programmable Keys area, such as Page Indicators, numbers of items, and so forth.

ABOUT YOUR PHONE APPLICATIONS

Your 5330 and 5340 IP Phones provide applications that simplify the use of your phone.

To open the *Applications* window, press the blue **Applications**  key. The *Applications* home window gives the current status of your phone's applications.

To open an application, press the key beside the application name:

- **People (5340 IP Phone only):** Use the *People* application to add, delete and edit contact names and numbers. You can also dial anyone on your contact list from the *People* application. The *People* window displays up to eight contacts per page, ordered alphabetically by last name. For information on using the *People* application, refer to [Setting Up Your Contact List](#) and [Dial From Your People Application](#).
- **Call Forwarding:** Use the *Call Forwarding* application to quickly set Call Forward Always and to create Call Forward profiles that identify where to send your incoming calls. The Call Forwarding window shows a list of your Call Forwarding profiles and indicates which one is active. See [Call Forward](#) for more information on how to add, edit, delete, and activate Call Forwarding profiles.
- **Call History:** Use the Call History application to display lists of the calls that you have missed, made, and answered. This feature allows you to filter the call records and display information on each call on the list. See [Using the Call History Application](#) for more information.
- **Conference Unit:** Use the *Conference Unit* application to control the 5310 IP Conference Unit. Use this application to turn the conference unit off or on, to adjust the volume, or to put the conference unit into Presentation mode. You can only run one Conference Controller session at a time. The *Conference Unit* application is available only when your phone is connected to a 5310 Conference Unit. See [Using Your Phone with the 5310 Conference Unit](#) for more information.
- **Cordless Module and Accessories:** Use the Cordless Module application to configure and view status of cordless accessories. See [Using the Cordless Module](#) for more information.
- **Settings:** Use the *Settings* application to display and quickly change your phone's current communications settings. See [Using the Settings Application](#) for more information.
- **Launch PC Application:** Provides a launch point to the PC Companion Application. See *Using the PC Companion Application* for more information.
- **Help:** Provides access to Launch PC Help and Quick Help and displays a list of the key icons.
- **Call Info:** Use the *Call Info* application to display caller information on your phone's prime line. Call Info appears automatically on incoming calls if the Call Notification—Display Call Info Setting is enabled and Call Info is available

You can press the programmed application key from the default Phone Window. For information on programming keys, see [Programming Features On Your Keys](#).

Using the Settings Application

The *Settings* application provides a single location to access all your phone settings.

The *Settings* window provides access to the *Settings* application. Select any of the options below to access a window where you can view and configure settings for your phone. The Settings window provides the following:

- **User Information:** Use to specify your name and phone number.
- **Languages:** Allows you to select the language in which phone prompts and applications appear. Supported languages are English, French, Spanish, German, Dutch, Italian, and Portuguese. Note: The system can support up to three languages at one time. Language choices appearing in the phone display are controlled by ICP programming.
- **Text Size:** Allows you to specify the font size (large or small) for the 5340 IP Phone.
- **Programmable Keys:** Use to assign features to the Programmable Keys that are available in the *Phone* application.
- **Call Notification:** Use to specify that the *Phone* application behavior when incoming or outgoing calls occur.
- **Brightness and Contrast:** Allows you to adjust the display brightness and contrast of your phone.
- **Screen Saver:** Allows you to specify a specific time of inactivity on your phone that triggers the screen saver to display.
- **Audio Feedback:** This setting allows you to adjust the volume of the audio feedback as well as the error beeps and enable or disable the setting.
- **Message Key Configuration:** Allows you to configure the Message  key.
- **External Message:** Allows you to program your phone to launch the *Phone* application when it displays special messages in the Information Display area.
- **Go To URL:** Allows you to enable third party URLs to display in the *Web Browser* application.
- **PC Connectivity:** Allows you to enter a password that is used by the phone to establish communications with the PC-resident 5330/5340 Companion application.
- **About 5330/5340 IP Phone:** This screen displays the software release.

Using the Call History Application

Use this application to display logs of your most recent 50 calls. After the 50-call limit has been reached, the oldest log is replaced each time a new call is missed, made, or answered.

From this application, you can



- display logs by type
- display call information (if available) for the logs
- return missed calls by pressing a key (5340 IP only)
- delete or modify digits before saving or dialing a call
- delete logs

If you are a hot-desk user, you can view and maintain your call history logs when you are logged into another extension.



View Call Log Details

1. From the idle display, press the blue Applications  key and then press **Call History**. **(Missed Calls)** appears next to the key label if you have missed calls.
2. Press
 - **Missed** to view your missed calls (if any).
 - **All** to view a list of all logs (5340 IP only)
 - **Answered** to view logs of your incoming calls
 - **Made** to view logs of your outgoing calls.
3. Use the navigation keys at the bottom of the display to move to the previous, first, or next page of logs. The total number of logs in the current list is shown in the bottom left corner of the display. The bottom right corner shows the range of logs (for example 1 -7) that are currently displayed.
4. Press the key to the right of the log to call the contact (5340 IP Phone only)
or
Press the key to the left of the log to display the call details:
 - Name and number (if available)
 - Log type and number of attempts (for example 2x)
 - Type of call: Transfer (Tsf.) or Conference (Conf.)
 - Time and date of log
 - Duration of call in hours:minutes:seconds (for Made and Answered logs).

5. Do one of the following:

- If necessary, use the keypad, **Delete Digit**, and **Backspace** keys to modify the number. Press **Dial** to call the number or press **To Contacts** to save the contact details to the **People** application (5340 IP Phone only).
- Press  or  at the bottom of the set to display details for another log.
- Press **Close** to return to the previous list.

Review Call Log Icons

1. Press the blue **Applications**  key, press **Help**, and press **Key Icons**.
2. Press  or  to navigate to the list of Call History icons. Note that “New” logs are any logs that have been generated since the last time you accessed the Call History application.

Delete Logs



To delete an individual log press the key to the left of the log to display the call details and then press **Delete Log Entry**.

To delete all logs by type

1. From the idle display, press the blue **Applications**  key and then press **Call History**.
or
Press the **Call Hist** feature access key. (**Missed Calls**) appears next to the key label if you have missed calls.
2. Press
 - **Missed** to view your missed calls (if any)
 - **All** to view all logs (5340 IP only)
 - **Answered** to view logs of your incoming calls
 - **Made** to view logs of your outgoing calls.
3. Press **Delete List** to delete all logs from the currently displayed list.
4. You are prompted to confirm the delete. Press **Delete**.

Getting Help

To access the 5330/5340 IP Phone help and documentation:

1. Press the blue **Applications**  key.
2. Press **Help**. You have the following options:
 - Press **Launch PC Help** to display www.edocs.mitel.com.
 - Press **Key Icons** or **Quick Help**.
 - Press  or  at the bottom of the set to view items for the selected help option.
3. Press **Close**.

Tips for Setting up your Phone

After you receive your 5330/5340 IP Phone, use the options in the *Settings* application to customize your phone. After customizing your phone, press the blue **Applications**  key to verify the settings are correct. Now, you are ready to begin using your phone.

CUSTOMIZING YOUR PHONE

Use the *Settings* application to customize your phone.

Note: The System Administrator can invoke a Lock to Factory default option on a per-phone basis. When this is in effect, the system administrator sets the following settings and you cannot change them:

- Programmable Keys
- External Messaging
- Go to URL



Using the Dial Pad to Enter Information

You can use the standard dial pad keys 0-9, and * and # to enter a name and or number for applications and features. Using the dial pad is the default option. You can also use the on-screen keyboard by selecting **Keyboard** while entering text (see [Using the On-screen Keyboard](#)).

The following table illustrates the characters you can enter by pressing a key consecutively. For example, to enter the letter “e”, press the ‘3’ key twice.

Key	Characters									
1	1									
2	a	b	c	A	B	C	2			
3	d	e	f	D	E	F	3			
4	g	h	i	G	H	I	4			
5	j	k	l	J	K	L	5			
6	m	n	o	M	N	O	6			
7	p	q	r	s	P	Q	R	S	7	
8	t	u	v	T	U	V	8			
9	w	x	y	z	W	X	Y	Z	9	
0	0									
*	*	Space								
		‘	‘							
#	#	.	,	()	+				



Characters are automatically inserted after a one-second delay. If you make an error, use **Backspace** and **Clear** (5340 only) to make corrections.

Press  or  at the bottom of the set to move the cursor forwards or backwards without deleting characters.

Note: When a text entry window is open, you cannot use the dial pad for dialing.

Using the On-Screen Keyboard to Enter Information

The onscreen keyboard can be used to enter name and number information into applications and features.

1. When prompted to enter name/number information, press **Keyboard** to display the on-screen keyboard.
2. Press **Next Page** and **Previous Page** to navigate to the set of characters needed for your input.
3. Repeatedly press the key next to the character you want to enter until that character is highlighted. The character is automatically inserted after a one-second delay. If you make an error, press  or  at the bottom of the set to move the cursor backwards or forwards. This does not delete any characters. You can press **Backspace** or **Clear** (5340 only) to delete characters.
4. After you have entered all the characters, press **Save**.
5. Continue with text entry as required by the application or press **Close**.

Specify User Information

To specify the phone number displayed on your phone:

1. Press **Settings**.
2. Press **User Information**.
3. Press **Edit Name**.
4. Using the dial pad, press the appropriate letters to spell your name (see [Using the Dial Pad to Enter Information](#)).
5. Press **Save**.
6. Press **Edit Number**.
7. Using the dial pad, press the appropriate numbers for your line (see [Using the Dial Pad to Enter Information](#)).
8. Press **Save**.
9. Press **Save** again.

Note: Press **Cancel** at any time to exit this application without making any changes or press **Clear** to clear the entered name and number.

Specify Language

To specify the language in which prompts and applications display:

1. Press **Settings**.
2. Press the **Language** setting.

The phone displays the three language selections that are currently programmed in the ICP.

3. Select the appropriate language and press **Save**.

The phone displays your chosen language.

Note: Languages supported on the 5330/5340 may differ from those supported on the ICP. If the phone is configured for an unsupported language, the prompts may appear in your selected language but the Application language for the phone defaults to English. The Language window displays "(name of the selected language)(Unsupported)".

Specify Display Brightness and Contrast

You can adjust the brightness and display contrast either via the phone volume controls (when the phone is idle) or via the *Settings* application. (Brightness adjustment on a 5330 IP Phone is available on models with backlit displays only.)

To adjust the display contrast using the volume controls:

- Repeatedly press  (UP) or  (DOWN).

Note: You can use this method only when the phone is idle. If the phone is ringing, this action adjusts the ring volume. If the phone is in use, this action adjusts the handset, headset and speakerphone volume.

To adjust the display brightness and contrast using the *Settings* application:

1. Press **Settings**.
2. Press **Brightness and Contrast**.
3. Press the Brightness and Contrast keys to adjust the brightness and contrast of your screen.
4. Press **Save**.

Note: Press **Cancel** at any time to exit this application without making any changes.

Specify Audio Feedback Options

The error beep volume in the phone is related to the volume of the speaker. You can set the beep volume using this procedure; however, adjusting the speaker volume also affects the beep volume.

To adjust the volume of the audio feedback:

1. Press **Settings**.
2. Press **Audio Feedback**.
3. Set the options using the appropriate actions described below:

Option	Action
Turn audio feedback off for errors	Press Turn Off .
Adjust audio for error beeps	Press Volume + or Volume –
Turn audio feedback on for errors	Press Play Error Tone

4. Click **Save**.

Note: Press **Cancel** at any time to exit this application without making any changes.

Specify Text Size

To specify the text size that displays on the phone:

1. Press **Settings**.
2. Press **Text Size**.
3. Select **Large Text** or **Small Text**.
4. Press **Save**.

Note: This setting is available only on the 5340 since the 5330 always uses large text. Large is the default text size on the 5340 IP Phone.

Specify Call Notification Behavior

To specify that the *Phone* window automatically displays when you are making or receiving calls:



1. Press **Settings**.
2. Press **Call Notification**.
3. Press the appropriate options to identify when you want the *Phone* window to display. For example, if you select the *Made* option, each time the phone goes off hook to make a call, the *Phone* window is displayed.
4. Press **Save**.

Notes:

- When *To my prime line* is selected, select *Display Call Info* to display Call Information instead of the Phone window.
- Press **Cancel** at any time to exit this application without making any changes.
- When the *Conference Unit* application is displayed, the *Phone* application is not automatically displayed when making or receiving calls.

Adjust the Ringer

To adjust the Ringer Volume while the phone is idle:

1. Press **Superkey** (must be programmed to a key).
2. Press the **No** softkey until "Ringer Adjust?" appears.
3. Press "Ring Adjust".
4. Press **No**.
5. Press "Ringer Vol".
6. Press  (UP) or  (DOWN) .
7. Press **Superkey**.

Note: Adjusting ringer volume also adjusts cordless headset/handset ringer tone.



To adjust the Ringer Volume while the phone is ringing:

- Press  (UP) or  (DOWN).

Notes:

- If the phone is in talk state, this action adjusts the volume of the handset, headset or speaker.
- If the phone is idle, this action adjusts the contrast.

To adjust the Ringer Pitch while the phone is idle:

1. Press **Superkey** (must be programmed to a key).
2. Press the **No** softkey until "Ringer Adjust?" appears.
3. Press "Ring Adjust".
4. Press "Ringer Pitch".
5. Press  (UP) or  (DOWN).
6. Press **Superkey**.

Enable a Screen Saver (5340 only)

You can program your screen saver to turn on after a specific time period of inactivity on your phone.

To enable a screen saver:

1. Press **Settings**.
2. Press **Screen Saver**.
3. Select the inactivity time, which will activate the backlight switch to turn off.
4. Press the checkbox opposite **Display image** if you wish the screen saver to be displayed. If you do not press this checkbox, only the set backlight is turned on.
5. Use the **Brightness** options to adjust the Brightness of the screen saver, if necessary.
6. Press **Save**.

Program Receipt of External Messaging

You can program your phone to launch the *Phone* application when it receives messages (other than phone calls).

To program receipt of External message types:

1. Press **Settings**.
2. Press **External Messages**.
3. Press the checkbox **Enable**.
4. Press **Save**.

Enable URL Displays on your Phone

To enable third-party URLs to display in the *Web Browser* application:

1. Press **Settings**.
2. Press **Go to URL**.
3. Press the checkbox **Enable**.
4. Press **Save**.

Enable PC Connectivity

To enable a connection to be set up between your phone and the PC Companion Application:

1. Press **Settings**.
2. Press **PC Connectivity**.
3. Press the checkbox **Enable**.
4. Press **Save**.

For more information on setting up the PC Companion Application, [Configuring the PC Companion on Your Phone](#).

USING THE PC COMPANION APPLICATION

About the PC Companion Application

The PC Companion Application is a PC-based desktop programming tool that allows you to easily program your phone keys and label those keys using your PC. You can also use the PC Companion Application to program your feature keys to launch phone or PC applications, open PC documents like a Microsoft Word document, or navigate to a URL directly using your browser.

Configuring the PC Companion Application on Your Phone

Use this procedure to connect your phone to the PC. This procedure is normally required only once. When your PC and phone have successfully associated the first time, your settings are saved and reused for each subsequent connection.

1. Press **Settings**, and then select **PC Connectivity**.

The phone's IP Address appears on the display:

IP Address for PC: AAA.BBB.CCC.DDD

2. Record the IP address, if desired, or repeat Step 1 when you need to view the IP address.
3. Still in the PC Connectivity window, select **Enable**.
4. Select **Edit password** and enter the password that will be used to set up the association with the PC application. You can also choose to use the default password. Record this password as you will need it to configure the PC application.
5. Proceed to *Installing the PC Companion Application* below.

Installing the PC Companion Application

Use this procedure to install the PC Companion Application software.

1. Determine the installation directory from which to install the PC Companion Application. For example, this may be a CD-ROM or a network directory. Contact your System Administrator if you have any questions.
2. Shut down all other applications before installing the PC Companion Application.
3. From the installation directory, double-click Setup.exe.
4. If there is a previous installation of the PC Companion Application on your PC, the installer indicates that you should remove it first. Use the **Add or Remove Programs** in Control Panel, and scroll to **Mitel 5330 5340 PC Companion Application**, select it, and click on Remove. When this is completed, double click Setup.exe again.
5. Follow the instructions in the installation program.

6. To launch the PC Companion Application, click the Windows Start menu and navigate to **Mitel -> Mitel 5330 5340 PC Companion Application**.
7. In the PC Companion application, do the following:
 - a) Select PC Connectivity from the menu on the left.
 - b) Enter the IP Address field you recorded in Step 2 [in Configuring the PC Companion on Your Phone](#).) Enter the password you selected in Step 4 in [Configuring the PC Companion on Your Phone](#) or use the default password.
8. Click **Connect**.



The PC Companion Application connects with the 5330/5340 IP phone.

Notes:

- The PC Companion application is started every time you log in or your PC is restarted.
- If your PC Companion Application is not connecting to your phone (for example, if your programmed feature Keys are disabled or you receive an error message upon start-up), contact your administrator.
- To ensure that the PC Companion Application displays properly, verify that your screen meets the minimum VGA screen requirements documented in the Installation Guide.

Opening the PC Companion Application

You can open the PC Companion Application in one of the following ways:

- Double-click the Tool tray icon () or desktop shortcut icon ().
- Select your Windows **Start** menu, select **Programs**, then **Mitel**, then **PC Companion Application**.
- From your phone's default Phone window, press the blue **Applications**  key, and then press **Launch PC Application**.
- Press the **PC App** programmed feature key (if available) from your phone's default Phone window.

Programming Feature Keys Using the PC Companion Application

1. Select **Programmable Keys** from the menu, and then click the desired key.
2. Program a phone feature, phone applications, or PC application:

To program a Phone Feature:

- Select **Telephone Feature** from the **Feature** list.
- Select the desired feature and then enter the required information in the fields provided.

To program a Phone Application:

- Select the application from the **Feature** list.

To program a PC Application:

- Select the desired PC application from the **Feature** list and then enter the required information in the fields provided.

3. Click **Save**.

Notes:

- To program a Call Forwarding feature key, you must use the *Call Forwarding* application. See [Call Forward](#) for programming instructions.
- In the **Programmable Keys** dialog, select **Clear this Key** if you make a mistake or if you wish to start over (that is, clear all entered data) when programming a key.
- If your administrator has programmed the keys using an external program, then you may not be able to modify the key programming. If the **Clear** option is not available on the pop-up menu when you right-click a key, or if the **Save** button is disabled in the Programmable Keys dialog, contact your administrator to see if you have the option to program your keys.
- To ensure that the Open URL feature key launches in a new window (instead of launching in an already open window), you may need to configure your Internet browser settings not to reuse open browser windows. For example, in Microsoft Internet Explorer, you select **Tools** followed by **Internet Options**, click the **Advanced** tab, and then ensure that the **Reuse windows for launching shortcuts option** is not selected. Refer to your browser help files for detailed procedures.

Clearing, Editing or Copying Key Programming

1. Select **Programmable Keys** from the menu.
2. Right-click the key you want to clear, edit, or copy.
3. Do one of the following:
 - Select **Clear**. Re-program the key, if desired.
 - Select **Edit...**, reprogram the key as desired, and then click **Save**.
 - Select **Copy**, right-click the key you wish to paste programming information to, and then select **Paste**.

Note: You must enter a new label when changing key programming. If you do not enter a new label, the **Label** field displays the label that applied to the previous programmed key.

PROGRAMING FEATURES ON YOUR KEYS

Tips on Programming Features

You can program your phone's programmable keys to enable features. To program your keys, use:

- *Settings* application
- PC Companion application

You can assign the following to a programmable Key:

- Features and Fixed function keys: see [Program Feature Keys Using the Setting Application](#).
- Applications: *People, Settings, Call Forwarding, Conference Unit* (see [Program Phone Application](#))

Note:

- Only the System Administrator can program line select and line appearance keys. The user's Prime line by default is Key 1.

Features available for programming on programmable keys

Feature	Default Label
Speed Call	Speed Call
Music	Music
Night Answer	Night Ans
Account Code Verified	Acct Verified
Account Code Non-Verified	Acct Non-Ver
Hot Desking	Hot Desk
Phonebook	Phonebook
Speak@Ease™	Speak@Ease
Auto Answer	Auto Ans
Paging	Paging
Call Pickup	Call Pickup

Feature	Default Label
Call Back	Call Back
Headset ¹	Headset
Make Busy	Make Busy
Campon	Campon
Override	Override
Direct Page	Page
Do Not Disturb	DND
Single Flash	Flash
Double Flash	Dbl Flash
Meet Me Answer	Meet Me
Message Waiting Indicator	Msg Waiting
Emergency Call	Emergency
Tag Call	Tag Call
Privacy Release	Privacy Rls
Swap	Swap
Release	Release
Call History	Call Hist
Call Park	Call Park
Call Park Retrieve	Park Retrieve
Float Keys	Float Keys
Group Listen	Grp Listen
Superkey	Superkey
Redial	Redial
Speaker	Speaker
Message	Message
Hold	Hold

Feature	Default Label
Transfer/Conference	Trans/Conf
Cancel	Cancel
Analog Line	Analog Line

1. Turning on the Headset feature key has no effect on the Cordless Headset.

Applications available for programming on programmable keys

Application	Default Label
Applications List	Applications
Call History	Call Hist
People	People
Call Forwarding	Forwarding
Conference Unit	Conf Unit
Launch PC Application	PC App
Help	Help
Settings	Settings
Call Info	Call Info
Visual Voice Mail	Voice mail

Program Feature Keys Using the Settings Application

To program a Phone Feature or hard key:

1. Press **Settings**.
2. Press **Programmable Keys**.
3. Press the key you wish to program.
4. If applications are displayed, press **View Features**.
5. Use the Page Navigation keys to move through the features list.
6. Select the desired feature or fixed function key from the list. A default label is automatically assigned to the key.
7. Enter the required information in the fields provided, if necessary.
8. If you are programming any feature other than Speed Call, Message Waiting Indicator, Call Park and Call Park Retrieve, press **Save** and you are finished with this procedure. If you are programming Message Waiting Indicator and or Call Park, perform the following steps:
 - Press the **Edit Number** field.
 - Using the dial pad, enter the appropriate numbers that correspond to the phone whose messages you wish to be notified of (Message Waiting) or the directory number (Call Park).
 - Press **Save**.
9. Press **Close**.

To program a *Phone* Application:

1. Press **Settings**.
2. Press **Programmable Keys**.
3. Press the key you wish to program.
4. If Features are displayed, press **View Applications**.
5. Select the desired application.
6. Press **Save**.
7. Press **Close**.

To program Speed Call:

1. Press **Settings**.
2. Press **Programmable Keys**.
3. Press the key you wish to program. If it's already programmed, press **Clear Key**.
4. Press **Speed Call**.
5. Press **Edit Label** and enter the label for the Speed Call.
6. Press **Save**.
7. Press **Edit Number** and enter the phone number for the Speed Call:
 - The maximum length is 26 characters.
 - 0-9, # and *. Pause and Flash are not allowed.
 - You can use dial pad to enter the number.
8. Press **Save**, and then press **Save** again.
9. Press **Close**.

Notes:

- To return to the Feature or Applications list at any time, press **Cancel or View Applications**.
- You can also choose to Edit the Label, Clear Information, and Clear Key.

Clear Programming from a Key

You may wish to clear the programming from a key if you are no longer using it.

To clear the feature or application programming from a key:

1. Press **Settings**.
2. Press **Programmable Keys**.
3. Press the key you wish to clear.
4. Press **Clear Key**.
5. Press **Close**.

SETTING UP YOUR CONTACT LIST (5340 ONLY)

Use the *People* application to set up your contact list.

Adding names to your contact list

You can add a name to your contact list by entering it directly using the *People* application or by copying a number from the Call Info window. Since a contact's phone number is mandatory and its name is optional, you are prompted to enter the number first.

To add a name to your contact list using the *People* application:

1. Open the *People* application.
2. Press **New**.
3. Enter the number.
4. Press **Save**. The First Name window appears.
5. Press the appropriate letters to spell the first name of your contact.
6. Press **Save**.
7. Press **Close**.

Editing information in your contact list

1. Open the *People* application.
2. Press the name you wish to edit.
Note: If you wish to delete the name from your contact list, press **Delete**.
3. Press **Edit Name**.
4. In the on-screen keyboard, update the appropriate information (see [Using the Dial Pad to Enter Information](#)).
5. Press **Save**.
6. Press **Edit Number**.
7. In the on-screen keyboard, update the appropriate information.
8. Press **Save** followed by **Close**.

MAKING AND ANSWERING CALLS

You can make a call using one of the following methods:

- Dial a number from the *People* application (for the 5340 IP Phone only).
- Press the programmed key associated with the party you want to call. For more information about programming keys, see [Programming Features On Your Keys](#).
- Dial the number using the dialpad.
- Use **Phone Book** (see [Phone Book](#) below).

Dial from your People Application (5340 IP Phone only)

To dial a contact from your People list:

1. Open the *People* application.
2. Use the navigation keys to page through the contact list and select the name.
3. Dial the contact name using one of the following methods:
 - Select a contact name and press **Dial**.
 - Press the key to the right of the contact's dial icon in the main list. (The contact name does not need to be selected.)
4. Continue the call using the speakerphone or lift the handset.

Phone Book

To use Phone Book:

1. Press **Phone Book** (if available) or the key programmed as **Phone Book**.
2. Enter the name of the desired party, as follows:
 - For each letter in the name, press the appropriate key on the keypad until the letter is shown in the display. For example, if the letter C is required, press the digit 2 three times.
 - Use the <— softkey to correct errors.
 - If the next letter in the name is on the same digit key as the previous letter, press the —> softkey before proceeding.
 - If required, press —> softkey to add a space between the first and last name.
3. Press the **Lookup** softkey.
 - If the system option “Phonebook Lookup – Default to User Location” is enabled

for your phone, the search is limited to names that share your location; otherwise, the entire directory is searched.

- If the system option “Phonebook Lookup – Display User Location” is enabled, after the phonebook search function displays the matching name and directory number, the user’s location is displayed. The display alternates between the name/number and the location every 2 seconds.
4. If no match exists, edit the original entry.
or
If the system option “Phonebook with Location” is enabled, press **Backup**. **ALL LOCATIONS?** Is displayed. Press **Yes** to search the entire directory or press **No** to search for only names that share your location. Edit the name and press **Lookup**.
 5. If more than one match is found, press the **Next** softkey.
 6. Do one of the following:
 - To make the call, press the **Call** softkey.
 - To edit the entry, press the **Backup** softkey.
 - To exit, press **Cancel** or **Superkey**.



Answer a call

Do one of the following:

- Select the programmable line key or Float Key (see page 57) for the ringing line that is flashing.
- Lift the handset or press  (**SPEAKER**).

End a call

Do one of the following:

- Press **Hang Up** or **Cancel** (.
- Replace the handset.
- Press the key that you have programmed as Cancel.
- If you are in Handsfree mode, press  (**SPEAKER**).

Redial

To redial the last number that you manually dialed:

1. Lift the handset (optional).
2. Press  (**REDIAL**).

Redial - Saved Number

To save the last number that you manually dialed:

1. Lift the handset.
2. Dial the appropriate feature access code.

To Redial a saved number:

1. Lift the handset.
2. Dial the appropriate feature access code.

Handsfree Operation

To use Handsfree to make a call:

1. If you want to use a Non-Prime Line, press a Line Appearance key.
Note: Your administrator must program Line Appearances to your phone.
2. Dial the number.
3. Begin speaking when the called party answers. Your phone's Handsfree microphone and Handsfree speaker transmit and receive audio.

To use Handsfree operation to answer calls:

1. Press the flashing line key or Float Key (see page 57).
2. Begin speaking. Your phone's Handsfree microphone and Handsfree speaker transmit and receive audio.

To hang up while using Handsfree operation:

- Press  (**SPEAKER**).

To turn Mute on during Handsfree operation:

- Press  (**MUTE**). The Mute key light turns ON.

To turn Mute off and return to conversation:

- Press  (**MUTE**). The Mute key light turns OFF.

To disable Handsfree operation:

- Lift the handset.

To return to Handsfree operation:

1. Press  (**SPEAKER**).
2. Hang up the handset.

Auto-Answer

When the Auto-Answer feature is active, incoming calls ring briefly, and then the phone answers the call in Handsfree mode. You can continue the call handsfree or use the handset.

To enable or disable Auto-Answer:

- Press **Auto-Answer** key. (See [Programming Features on Your Keys](#) for instructions on programming features on your phone.) The key is highlighted and all incoming calls are answered in Handsfree mode.

To switch from Handsfree mode to handset mode:

1. Lift the handset

To end a call, do one of the following:

- Press  (**Cancel**)
- Press the **Hang Up** softkey.
- Wait for the caller to hang up.

Using the Analog line

The phone can support the Line Interface Module. See *Using the Line Interface Module* for more information.

CALL HANDLING

Hold

To place a call on Hold:

- Press  (**HOLD**).
- Press the key that you have programmed as Hold. The indicator flashes on the line that has the held call.

Note: You can only retrieve a call from hold when the phone is idle.

To retrieve a call from Hold, do one of the following:

- Lift the handset and press the flashing line key or Float Key (see page 57).
- Press the flashing indicator.
- Use the Add Held feature to conference into the held call.

To retrieve a call from Hold at another phone, do one of the following:

- Press the flashing line key.
- Dial the appropriate feature access code and the number of the station that placed the call on Hold.

Mute

Mute lets you temporarily turn your phone's handset, headset or handsfree microphone off during a call.

To turn Mute on during a call:

- Press  (**MUTE**). The  (**MUTE**) light turns ON.

To turn Mute off and return to the conversation:



- Press  (**MUTE**). The  (**MUTE**) light turns OFF.

Note: If you are on a Handsfree MUTED call and you lift the handset, the handset microphone is automatically enabled and the MUTE light turns OFF.

NOTE FOR USERS ON RESILIENT 3300 ICP SYSTEMS: If your phone switches to the secondary system while your speaker or handset is muted (that is, while the Mute key is lit) the call remains muted until you hang up.

Transfer

To Transfer an active call:



1. Press  (TRANSFER).
2. Dial the number of the third party.
3. Do one of the following:
 - To complete the Transfer, hang up.
 - To announce the Transfer, wait for an answer, consult, and hang up.
 - To cancel the Transfer, press  (CANCEL).

To transfer an active call during headset operation:

1. Press  (TRANSFER).
2. Dial the number of the third party.
3. To complete the Transfer, press the Release feature key.

Conference

To form a Conference when a two-party call is already in place, or to add another party to an existing Conference:

1. Press  (TRANSFER).
2. Dial the number of the next party.
3. Wait for an answer.
4. Press  (TRANSFER).

To leave a Conference:

- Hang up or press  (CANCEL).

Conference Split

To Split a Conference and speak privately with the original party:

- Press the **Split** softkey.

Add Held

To move a call on hold to another line appearance:

1. Press an available line key.
2. Press the **AddHeld** softkey.
3. Press the flashing line key.

To add a call on Hold to an existing conversation or conference:

1. Press the **AddHeld** softkey.
2. Press the flashing line key.

Swap

To call another party when you are in an established two-party call:

1. Press  (TRANS/CONF).
2. Dial the number.

To alternate between the two parties:

- Press the **Trade Calls** softkey.

Call Forwarding

Call Forward lets you redirect incoming calls to an alternate number when

- your phone is busy,
- when you're not answering, or
- all the time.

You can program, activate, and deactivate Call Forward Always quickly through the **Applications** screen while you have other types of Call Forwarding, such as Busy External, activated through your Call Forwarding profiles.

For example, you can enable profiles to forward calls to your voice mailbox when your phone is busy or unanswered. Then, if you must leave your desk, you can quickly enable Call Forward Always to another phone, such as your home phone or cell. After you return to your desk and deactivate Call Forwarding Always, your profiles for busy or unanswered conditions remain active.

USING QUICK CALL FORWARD ALWAYS

To program and enable Call Forward Always:

1. Launch *Applications* and press **Call Forwarding**
or
Press the **Forwarding** feature key.
2. If a number is already programmed, you can
 - Press **Activate** to enable forwarding to the current number
or
 - Enter a new destination number and then press **Activate**.

Note: Call Forward Always takes precedence over all other types of forwarding.

To deactivate Call Forward Always:

1. Launch *Applications* and press **Call Forwarding**
or
Press the **Forwarding** feature key
2. Press **Deactivate**.

PROGRAMMING CALL FORWARDING USING PROFILES

You can create Call Forward profiles that identify where to send your incoming calls. After you create and save a Call Forward profile in the [Call Forwarding](#) application, you can enable or disable the profile at any time.

Notes:

- The None Profile is a default profile provided by the system. It has no numbers programmed. Use the None Profile to turn off all Call Forwarding.
- The default profile appears when the Call Forwarding set up does not match any of your profiles.
- Only one call profile can be active at a time.
- The dotted radio button icon next to the profile shows the current active profile.

To create a Call Forward profile:

1. Launch *Applications* and press **Call Forwarding**
or
Press the **Forwarding** feature key.
2. Press **Profiles**.
3. Press **New Profile**.
4. Press **Edit Profile Name**. An on-screen keyboard displays.
5. Press the appropriate keys in the on-screen keyboard to enter the profile name and press **Save**. This profile name identifies where your phone calls will be forwarded to.
6. Select the check box opposite the desired type of Call Forwarding:
 - **Always**: forwards all your phone calls
 - **Busy Internal**: forwards internal phone calls after several rings if your line is busy
 - **Busy External**: forwards external phone calls after several rings if your line is busy
 - **No Answer Int**: forwards internal phone calls redirects your calls after several rings if you don't answer
 - **No Answer Ext**: forwards external phone calls redirects your calls after several rings if you don't answer
7. Press **Edit Number** to display the on-screen keyboard. In the on-screen keyboard, enter the appropriate number.
8. Press **Save**.
9. Press **Enable**.
10. Press **Save**.
11. Repeat Step 6 to Step 10 for each Call Forwarding type that you wish to program.
12. Press **Save**. This profile is saved but it is not activated. To activate this profile, see *Activate Call Forward* below.
13. Press **Close**.
14. Press **Close**.

Note: Press **Cancel** at any time to exit this application without making any changes.

ACTIVATE CALL FORWARD

To turn Call Forward on once it has been programmed:

1. Press the blue **Applications**  key.
2. Press **Call Forwarding**.
3. Press **Profiles**.
4. Press the appropriate Profile setting.
5. Press **Activate**.
6. Press **Close**.

CANCEL CALL FORWARD

To cancel Call Forward:

1. Press the blue **Applications**  key.
2. Press **Call Forwarding**.
3. Press **Profiles**.
4. Press **None** setting.
5. Press **Activate**.
6. Press **Close**.

USING OTHER FEATURES

Account Codes

An account code is a series of digits that you assign to your calls, usually for accounting purposes. The code identifies the account in the call records that your system generates. A forced account code is usually entered from another extension, enabling you to use features or make calls that the extension otherwise could not. If you want this feature enabled on your phone, ask your System Administrator.

To use Account Codes:

1. Lift the handset.
2. Dial the Account Code digits.
3. Press #.

To enter an Account Code during a call:

1. Press **Superkey** (must be programmed to a key).
2. Select **Account Code**.
3. Dial the Account Code digits.
4. Press the **Save** softkey.
5. Do one of the following:
 - For a verified account code, press the **Yes** key.
 - For a non-verified account code, press the **No** key.

ACD

If your phone is ACD-enabled, you can log in as an agent. When there is no agent logged onto an ACD-enabled set, *LOGGED OUT* is displayed.

To log in as an ACD agent:

1. Press **Superkey**.
2. Press **Yes**.
3. Enter your Agent ID, using the key pad.
4. Press **Enter**.

The text, *LOGGED OUT* disappears.

Attendant Call Hold - Remote Retrieve

To retrieve a call placed on Hold by the attendant:

1. Lift the handset.
2. Dial the appropriate feature access code.
3. Dial the digits announced by the attendant.

Callback

The Callback feature allows you to be notified when a busy phone becomes free or when a phone has been used after a no-answer condition was encountered.

To request a Callback when you reach a busy or unanswered station:

1. Press **Call Me Back**.
2. Hang up.

When the party is available, your phone starts ringing, and the display shows the Callback ringing indicator.

To answer a Callback:

- When you see the Callback ringing indicator, lift the handset, or press the Float Key (flashing with the calling party's name label; see page 57).

Call Forward - Remote (I'm Here)

To forward calls from a remote station to your current location:

1. Press **Superkey** (must be programmed to a key).
2. Press the **No** softkey until "Call Forwarding?" appears.
3. Press the **Forwarding** softkey.
4. Press the **Next** softkey until "I Am Here" appears.
5. Press the **To Me** softkey.
6. Dial the extension of the remote station.

If you make an error while dialing, use the <— softkey to backspace and correct the number.

7. Press  (**DOWN**) or the **Save** softkey.

To cancel Call Forward – Remote from the station that set the remote forwarding:

1. Lift the handset.
2. Dial the appropriate feature access code.
3. Dial the extension of the remote station.
4. Hang up.

To cancel Call Forward – Remote from the station that was forwarded:

1. Press **Superkey** (must be programmed to a key).
2. Press the **No** softkey until "Call Forwarding?" appears.
3. Press the **Forwarding** softkey.
4. Press the **Review** softkey.
5. Press the **Change Key** softkey.
6. Press the **Turn FWD Off** softkey.
7. Press **Superkey** (must be programmed to a key).

Call Forward - End Chaining

To ensure that calls do not get forwarded again by the destination number:

1. Lift the handset.
2. Dial 64.
3. Hang up.

To again allow calls to be forwarded by the destination number:

1. Lift the handset.
2. Dial the appropriate feature access code.
3. Hang up.

Call Forward - Forced

To force an incoming call to be forwarded:

- Press the Forward softkey.

Call Forward - Override

To override Call Forward and ring a station:

1. Lift the handset.
2. Dial the appropriate feature access code.
3. Dial the extension number.

Call Park

The Call Park feature allows you to place a call in a special hold state. You, or someone else, can then retrieve the call from any extension in the system.

After parking the call, the system can automatically connect you to paging equipment so that you can announce the call to the requested party.

To park an active call:

1. Do one of the following:
 - Press the **Call Park** feature key (must be programmed)
 - Press  (TRANS/CONF), and then dial the appropriate feature access code. The display shows PARKED@, followed by the park destination and parking spot index (if applicable). Example: PARKED@ 1234 @ 02.
2. Dial the directory number on which to park the call (not required if the number is programmed to the **Call Park** feature key).
3. To inform a user that a parked call is waiting, do one of the following:
 - If automatic paging is enabled, announce the call and the park retrieve digits shown on the display.
 - If automatic paging is disabled, press the programmed **Page** key, or dial the appropriate feature access code, followed by the Paging zone number (if required). Then, announce the call and park retrieve digits shown on the display.

Note: Paging over a loudspeaker is not permitted in handsfree mode; you must use the handset or headset.

To retrieve a parked call:

1. Do one of the following:
 - Dial the appropriate feature access code.
 - Press the **Call Park - Retrieve** feature key (must be programmed).

2. Dial the directory number on which the call is parked (not required if the number is programmed to the **Call Park** feature key).
3. If there are multiple calls parked on the number, dial the two-digit index number to retrieve a specific call, or # to retrieve the longest parked call.

Call Pickup

To answer a call that is ringing at another extension in your Pickup Group:

1. Lift the handset.
2. Press the key that you programmed as **Pickup**.

To answer a call that is ringing at another extension not in your Pickup Group:

1. Lift the handset.
2. Dial the appropriate feature access code.
3. Dial the number of the ringing station.

Campon

When you get a busy tone, you can use the Campon feature to be notified when the busy party becomes available.

To Campon to a busy station:

- Press the **I Will Wait** softkey.

To retrieve a call when you hear the Campon tone:

- You can use the Trade Call or Call Swap feature with the  (TRANS/CONF) hardkey or a programmable line key.

Direct Paging

Direct Paging allows you to page a party through the party's handsfree speaker. If the paged party has Off-Hook Voice Announce enabled, the page will be heard even when the party is on a handset or headset call. If the paged party has Handsfree Answerback enabled and turned on on the phone, your page automatically establishes a handsfree call with the paged party.

To page a party:

1. Lift the handset.
2. Press the Direct Paging feature key or dial the appropriate feature access code.
3. Dial the extension number.
4. Speak to the dialed party after the tone.

How you answer a Direct Page depends on whether Handsfree Answerback is enabled and turned on at your phone. See one of the following procedures in this guide:

- Direct Paging - Handsfree Answerback Enabled
- Direct Paging - Handsfree Answerback Disabled

Direct Paging - Handsfree Answerback Enabled

When you receive a Direct Page, Handsfree Answerback automatically establishes a Handsfree call on your phone after a single burst of tone.

Your administrator enables or disables Handsfree Answerback on your phone. After your administrator enables Handsfree Answerback, you can choose to turn it on or off directly from your phone.

To turn Handsfree Answerback on:

- When your phone is idle, press  (**MUTE**) once. The MUTE key light flashes to indicate that Handsfree Answerback is ON.
- When a Direct Page arrives, the MUTE key light turns OFF and a Handsfree call is automatically established.

To turn Handsfree Answerback off:

- Press the flashing  (**MUTE**) key once. The MUTE key light turns OFF.
- To respond to a Direct Page when Handsfree Answerback is OFF, see "Direct Page - Handsfree Answerback Disabled" elsewhere in this guide.

Note: By default, Handsfree Answerback is turned OFF at your phone. If the  (**MUTE**) key is OFF when your set is idle, Handsfree Answerback is OFF.

To answer a call using Handsfree Answerback:

Phone state before Page arrives To answer the Direct Page

Phone is idle and MUTE is flashing

1. Check that MUTE is OFF.
2. Listen for the paging party.
3. Begin speaking.
4. Lift the handset if you wish to switch from a Handsfree call to a handset call.

You are on a handset or headset call, and MUTE is OFF

1. Check that MUTE is flashing.
2. Press MUTE. The light turns ON solid, and you are now speaking to the paging party and have muted your handset/headset call.
3. Speak to the paging party. Press MUTE to alternate between handset/headset and handsfree calls.

You are on a MUTED handset/headset call, OR, you are on a Handsfree call

The party paging you receives a busy tone. Handsfree Answerback does not interrupt your call.

To end a Handsfree Answerback call:

- Press either  (**SPEAKER**) or  (**CANCEL**).

When the Handsfree Direct Page call ends, the MUTE key light returns to the state it was in before the call was established.

Direct Paging - Handsfree Answerback Disabled



Your administrator enables or disables Handsfree Answerback and you can also turn it on or off on your phone. To turn Handsfree Answerback off, see "Direct Paging - Handsfree Answerback Enabled" elsewhere in this guide. When Handsfree Answerback is disabled on your phone and you receive a Direct Page, the Direct Page is indicated by a single burst of tone.

To answer Direct Page calls when Handsfree Answerback is disabled:

Phone state before Page arrives: To answer the Direct Page (indicated by single burst of tone):

- | | |
|--|---|
| Phone is idle and MUTE is OFF. | <ol style="list-style-type: none">1. Check that MUTE is ON solid.2. Lift the handset OR press MUTE key to answer in Handsfree mode. (The light turns OFF.)3. Begin speaking. |
| You are on a handset call or headset call, and MUTE is OFF | <ol style="list-style-type: none">1. Check that MUTE is flashing.2. Press MUTE. The light turns ON solid and you are now speaking to the paging party and have MUTED your handset/headset call.3. Speak to the paging party. Press MUTE to alternate between handset and handsfree calls. |
| You are on a MUTED handset/headset call, OR, you are on a Handsfree call | The party paging you receives a busy tone. Handsfree Answerback does not interrupt your call. |

To end a Direct Page call, do one of the following:

- Hang up the handset to end a handset call.
- Press  (**SPEAKER**) to end a Handsfree call.
- Press  (**CANCEL**).

When the Handsfree Direct Page call ends, the (MUTE) key light returns to the state it was in before the call was established.

Do Not Disturb

When you enable Do Not Disturb, callers will get a busy tone, and an on-screen text message indicating that you do not wish to be disturbed.

To activate or deactivate Do Not Disturb:

- Press the Do Not Disturb key that you programmed. The key is highlighted when Do Not Disturb is activated and is not highlighted when Do Not Disturb is not activated. The phone status line shows the Do Not Disturb  icon.

To activate Do Not Disturb from a remote extension:

1. Lift handset.
2. Dial the number of the station to which **Do Not Disturb** is to apply.
3. Hang up.

To deactivate Do Not Disturb from a remote station:

1. Lift handset.
2. Dial the appropriate feature access code.
3. Dial the number of the station with **Do Not Disturb** activated.
4. Hang up.

Emergency Calls

Warning for emergency number dialing: Consult your local authorities for Emergency Numbers and 911 or equivalent service availability in your area.

There are two methods of dialing emergency numbers, based on the programming of your 3300 ICP:

- Emergency Call Routing NOT programmed
- Emergency Call Routing programmed

Caution: Verify with your System Administrator which type of emergency number dialing you can use.

EMERGENCY CALLS WHEN EMERGENCY CALL ROUTING NOT PROGRAMMED

If Emergency Call Routing is NOT programmed, Emergency Number dialing should only be performed by picking up the handset and selecting the Analog Line key you have programmed. If Privacy Mode is enabled and the Analog Line key local line is busy, dialing will not occur on the Line Interface Module line. Emergency dialing using an IP connection may not be supported due to ICP system configuration and country location. For more information, contact your System Administrator.

To make an Emergency Call using the Line Interface Module line:

1. Lift the handset.
2. Press the Analog Line key that you have programmed.

The set indicates *ANALOG CALL*

3. Dial your Local Emergency Number.

To make an Emergency Call using the Line Interface Module line, when the IP connection has failed:

1. Lift the handset.
2. Press the Analog Line key that you have programmed.

The set indicates *IP FAIL: ANALOG CALL*.

3. Dial your Local Emergency Number.

EMERGENCY CALLS WHEN EMERGENCY CALL ROUTING PROGRAMMED

Note: This procedure is in addition to the methods described above.

To make an Emergency Call if Emergency Call Routing is programmed:

1. Lift the handset.
2. Dial your Local Emergency Number (911 or equivalent).

For more information on using the Line Interface Module line, refer to Using the Line Interface Module.

Float Keys (5340 IP Phone)

The 5340 IP Phone offers 48 programmable multi-function keys for one-touch feature access. You can program three of these keys as float keys. Float keys are typically used to display unanswered ringing lines on designated keys where the ringing lines would otherwise be hidden on one of the phone's application pages. The location of the Float keys is shown in the following figure:



Up to three concurrent incoming calls with associated labels can appear on the Float keys. The labels are presented in reverse video (white on black background). Float keys can also be used to support ringing line queues – due to the number of ringing lines at any one time, you are able to view the queue of unanswered “floated” lines, and answer them as quickly as possible.

Only the following line types are supported for float keys on 5340:

- Single Line
- Key System
- Multicall

Programming Float Keys

You program the Float Keys using the Settings application on the 5340 phone. You are able to program the Float Keys essentially as a mirror of any of the lines programmed on the 48 programmable keys. The Float Keys reflect the state of those lines including indicators and labels, and allows you to access those lines without having to navigate to the pages where those keys may be displayed. Any answered floating line remains floating for the duration of the call, regardless of the manner in which it was answered.

To enable float keys:

1. Press **Applications**.
2. Press **Settings**.
3. Press **Float Keys**.
4. Press **Enable**.
5. Press **Save**.

To program Float Keys using the Settings Application:

1. Press **Applications**.
2. Press **Settings**.
3. Press **Programmable Keys**.
4. Press one of the line keys that you want to appear on a Float Key. Use the Page Navigator keys to move through the list of programmed lines if necessary. The Float Configuration display appears.
5. Press a key corresponding to your desired float configuration (see figure below):
 - Float Immediate** – configure the unanswered incoming call on the designated line to appear at the Float Key immediately
 - Float after. . .** – configure unanswered incoming calls to display on a Float Key after a delay of up to 60 seconds
 - Do Not Float** – configure unanswered incoming calls to never displayed on a Float Key (this is the default setting)



6. Repeat steps 3 – 5 for every line key that you want to appear on the float keys.
7. Press **Save**.
8. Press **Close**.

To disable float keys

1. Press **Applications**.
2. Press **Settings**.
3. Press **Float Keys**.
4. Press **Disable**.
5. Press **Save**.

Using Float Keys

You can set up more than three lines to float. As lines ring, they get placed into a queue which will display the first three in the float key area. If there are more than three lines configured to float, as Float Key positions are freed up, the next lines in the queue get displayed. Press the Float key of the ringing line to answer a call.

Group Listen

With Group Listen, you can carry on a conversation using the handset or headset while allowing others nearby to listen to the person at the far end over the handsfree speaker. The handsfree microphone is disabled in Group Listen mode.

To activate Group Listen while in a handset conversation:

- Press the **Group Listen** key.

Audio from the far-end party is now heard through both the handset/headset and the speaker.

To make the call a normal two-way speaker call:

- Press  (**SPEAKER**).

To exit Group Listen mode (and return to a normal handset/headset call):

- Press the **Group Listen** key.

To activate or deactivate Group Listen while in headset mode:

- Press the **Group Listen** key.

Group Paging / Meet Me Answer

Group Paging allows you to page a group of telephones through their built-in speakers. You can belong to as many as three paging groups with one group designated as your "prime" group.

When you need to respond to a Group Page but don't know the identity or extension number of the paging party, use the Meet Me Answer feature. You have up to 15 minutes after receiving the page to use Meet Me Answer.

To make a Group Page:

1. Lift the handset.
2. Press **Direct Page** or dial the appropriate feature access code.
3. Do one of the following:
 - To page your prime page group, press #.
 - To page a specific page group, dial the page group directory number.
4. Speak to the dialed party after the tone.

To respond to a Group Page by using Meet Me Answer:

1. Lift handset.
2. Press the key you have programmed to Meet Me Answer or dial the appropriate feature access code.

(See [Programming Features on Your Phone](#) for instructions on programming features to your phone.)

3. Do one of the following:
 - To respond to a page from your prime page group, press #.
 - To respond to a page from a specific page group, dial the page group directory number.

Headset Operation

Note: For information about the Cordless Headset, see “USING THE CORDLESS HEADSET” on page 89.

To enable Headset Operation:

- Press the **Headset** feature key.

To answer a call (when Auto Answer is disabled):

- Press the flashing line key or Float Key.

To answer call (when Call Notification is enabled)

- Select **Close** and then select the prime line.

To hang up:

- Press  (**CANCEL**).

To mute your headset microphone:

- Press the  (**MUTE**) key. The light turns ON.

To turn mute off and return to the conversation:

- Press the  (**MUTE**) key. The light turns OFF.

Hot Desking

Hot Desking allows you to log into the telephone system from any phone designated as a Hot Desk phone. When you log in at the phone using your assigned Hot Desk User Extension Number, the phone assumes all your speed dials, features keys, call forwarding setup, and line appearances - even your language preference for the display. Any changes you make to the phone while you are logged in--for example, adding a speed dial--are saved to your personal profile. Logging in activates your profile on any phone that supports Hot Desking.

When you log in as a hot desk user, Call History data is updated for you. You do not see any call logs for the phones registered DN; you only see your history data. When you log out, the registered DNs history data is displayed. To access your voice mail when you are logged in as a hot desk user, you must log in to your voice mail.

To log into a Hot Desking phone (the phone must be idle):

1. Press the key you have programmed to **HotDesking**.
2. Press the **Login** key.
3. Using the phone keys, enter your Hot Desk User Extension Number, and then press **OK**.
4. Enter your pin number and press **OK**.

While logged in as a hot desk user, the phone status line shows the Hot Desk  icon.

To log out of Hot Desking phone (the phone must be idle):

1. Press the key you have programmed to **HotDesking**.
2. Press the **Logout** command key.
3. Press the **Confirm** command key.

Note: Your profile can only be active on one phone at a time. If you log in from another phone without logging out from the first one, the system will automatically deactivate your profile on the first phone.

Hot Desk Remote Logout

A user who has forgotten to log out of a Hot Desking phone can be logged out from a phone that is configured to allow Hot Desk Remote Logout.

Note: This feature must be allowed by your System Administrator via the Class of Service.

To remotely log out a Hot Desking phone:

1. Dial 111.
2. Dial the Hot Desk User Extension Number that you want to log out.
3. Press the **Logout** command key.
4. Press the **Confirm** command key.

Hot Desk - PIN Change

To change your Hot Desk PIN:

1. Log into a Hot Desking phone.
2. Press **Superkey** (must be programmed to a key).
3. Press the **HotDesk PIN** softkey.
4. Press the **Yes** softkey.
5. Enter the current PIN or skip to step 6 if a PIN has not yet been assigned.
6. Press the **Enter** softkey.
7. Enter the new PIN.
The PIN can include digits from 0 to 9 only and can be from 0 to 8 characters in length.
8. Press the **Enter** softkey.
9. Re-enter the new PIN.
10. Press **Superkey**.

Make Busy

You can use the Make Busy feature to have your phone appear busy to other callers. If callers dial your phone number when Make Busy is enabled a message indicating that your line is busy is displayed on their phones.

To enable Make Busy:

- Press the key you programmed to **Make Busy**. The key illuminates when Make Busy is activated and *MAKE BUSY* is displayed.

To disable Make Busy:

- Press the key you programmed to **Make Busy**.

Message Waiting Indicator

The Message Waiting Indicator (MWI) feature allows you to be notified when messages have been left on another phone. Once you have programmed a key to MWI, this key is always enabled.

To use MWI to contact the extension that left a message:

- Press the key you have programmed to MWI.

Messaging - Advisory

Advisory Messaging enables you to select a notice that appears on your phone display to inform people visiting your desk of your whereabouts. Select from a variety of advisory messages, including "On vacation", "In a meeting", or "Out to Lunch".

To turn Messaging - Advisory on:

1. Press **Superkey** (must be programmed to a key).
2. If necessary, press the **No** softkey until "Advisory Msgs" appears.
3. Press the **Advisory** softkey.
4. Press the **Next** softkey until the desired message appears.
5. Press the **Turn Msg On** softkey.

To turn Messaging - Advisory off:

1. Press **Superkey** (must be programmed to a key).
2. If necessary, press the **No** softkey until "Advisory Msgs" appears. .
3. Press the **Yes** softkey when "Advisory appears.
4. Press the **Turn Msg Off** softkey .

Messaging - Callback

To leave a Callback Message when you hear busy or ringback tone:

- Press  (**MESSAGE**) or press the **Callback** softkey.

To respond to a message waiting condition on your phone:

1. Press  (**MESSAGE**).
2. If a password is required, dial your password (and press the **Enter** softkey if available).

3. Press the **Read Message** softkey, and do one or all of the following:
 - To display the time the message was sent, press the **More Msg** softkey.
 - To display the number of the caller, press the **More Msg** softkey twice.
 - To call the message sender, press the **Call** softkey.
 - To delete the message, press the **Erase Msg** softkey.
 - To view the next message, press  (**MESSAGE**).

You can check for messages from a remote station:

1. Press Superkey (must be programmed to a key).
2. Press the **No** softkey until "Remote Msging?" appears.
3. Press the **Yes** softkey.
4. Dial your extension number.
5. Press the **Enter** softkey.
6. If a password is required, enter your password and press the **Enter** softkey.
7. Press the **Yes** softkey.

You can set, change, or clear a password (up to 7 digits, not including 0):

1. Press **Superkey** (must be programmed to a key).
2. Press the **No** softkey until "Set Password?" appears.
3. Press the **Yes** softkey.
4. Do one of the following:
 - To enter a new password, enter your password.
 - To change or clear your password, enter your current password.
5. Press the **Enter** softkey.
6. To change or clear your password, do one of the following:
 - To change your password, enter your new password and press the **Enter** softkey.
 - To clear your password, enter 0.
7. Enter your new password again.
8. If you are setting up or changing a password, press the Enter softkey.
9. Press **Superkey** (must be programmed to a key).

Messaging - Cancel Callback

To cancel a Callback:

1. Lift the handset.
2. Dial the appropriate feature access code.
3. Dial the number of the called station.
4. Hang up.

Messaging - Cancel All Callbacks

To cancel all Callbacks:

1. Lift the handset.
2. Dial the appropriate feature access code.
3. Hang up.

Music

To turn Music on and off when the phone is idle, do one of the following:

- To turn the music on, press the key that you programmed to Music or the Music softkey.
- To turn the music off, press the key that you programmed to Music or the Music softkey.

When the Music is activated, the key you have programmed is highlighted.

Night Answer

The Night Answer feature allows you to route calls to an attendant or message at night.

To enable Night Answer:

- Press the key you programmed to Night Answer. When you have enabled Night Answer, this key is highlighted.

To disable Night Answer:

- Press the key you programmed to Night Answer

Override (Intrude)

When you dial a number whose owner has enabled Make Busy, your phone displays the message indicating that the line is busy. You have the option to override this setting.

To use Override when you encounter a busy tone:

1. Press the key you programmed as **Override**.
2. Wait for an answer.

Paging

To use Paging:

1. Lift handset.
2. Press the key that you have programmed to **Page**.
3. Dial the Paging zone number (if required).
4. Make the announcement.

Record a Call

This feature uses your voice mail system to record your telephone conversations.

Note: You may be required by law to inform the other party that you are recording the conversation. For specific instructions, consult your system administrator.

To start recording while on a 2-party call:

- Press the **Record Call** key. (See *Feature Keys* elsewhere in this guide for instructions on programming a **Record Call** key to your phone.)

Note: Your system may be programmed to automatically begin recording external calls when you or the other answers.

To control recording, do one or all of the following:

- To pause recording, press the **Pause** softkey.
- To resume recording after pausing, press the **Resume** softkey.
- To stop a recording without saving it, press the **Erase** softkey or  (**CANCEL**).
- To stop and save a recording, press the **Save** softkey.

Putting the call on hold saves the recording; taking the call off hold starts a new recording. Depending on system programming, hanging up, or pressing  (**TRANS/CONF**) or a **DSS** key, may also save the recording.

To listen to a recording:

1. Lift the handset.
2. Access your voice mailbox.
3. Follow the prompts to retrieve the recording.

Reminder

To program a Reminder:

1. Press **Superkey** (must be programmed to a key).
2. Press the **No** softkey until "Timed Reminder" appears.
3. Press the **Reminder** softkey.
4. Enter the time in 24-hour format.
5. Press the **Save** softkey.

To view, change, and/or cancel a pending Reminder:

1. Press **Superkey** (must be programmed to a key).
2. Press the **No** softkey until "Timed Reminder" appears.
3. Press the **Reminder** softkey.
4. Do one of the following:
 - To change the Reminder, press the **Change Key** softkey, enter the new time, and press the **Save** softkey.
 - To cancel the Reminder, press the **Cancel No.** softkey.
 - To exit without canceling the Reminder, press **Superkey** (must be programmed to a key).

To acknowledge a Reminder when your phone rings once:

- Press the **Confirm** softkey.

Speak@Ease

Users of the Speak@Ease softkey can place a call by speaking the name of the person they wish to dial. Speak@Ease enables you to have access to Mitel Speech Server. The Speech Server is a speech recognition application that routes incoming calls to a specific destination based on spoken commands.

To dial a call using Speak@Ease:

1. Press the key you have programmed to Speak@Ease.
2. Speak the name of the person you wish to call.

Speed Call

Speed Call is an application that allows you to dial a specific number with one key press. You must program Speed Call on a Programmable key. For more information on programming this key, see [Program Feature Keys Using the Settings Application](#).

To make a Speed Call:

- Press the key that you have programmed as your Speed Call key.

Tag Call

Tag Call allows you to signal that you are the victim of a threatening or malicious call. Using the tag, your system administrator or Telephone Company can identify the source of the call and provide this information to appropriate personnel or authorities.

CAUTION: Tagging a non-malicious call may result in fines or other penalties.

To tag a malicious call:

1. Press the programmed Tag Call key while the call is in progress. For information on how to program keys, see to [Programming Features On Your Keys](#)

-OR-

1. Press  (TRANS/CONF).
2. Dial the appropriate feature access code.

If the call was successfully tagged, *Thank You* is shown on the display; otherwise, *Not Allowed* is displayed.

Note: Tag Call can be used on active two-party calls only. Calls on hold and conference calls cannot be tagged.

Trunk Flash

The Trunk Flash feature allows you to access Centrex features (if available) while you are talking on an outside call.

To flash a trunk while talking on an outside call:

1. Press the key you have programmed to Flash.

Note: You can program a key to single flash or double flash.

2. Wait for dial tone.
3. Dial the Centrex feature access code.

VISUAL VOICE MAIL (5340 IP Phone Only)

Set up your mailbox

Before you can use voice mail, you must first set up your mailbox.

To set up your mailbox:

1. Dial the voice mail Hunt Group number provided by your system administrator.
2. Follow the verbal instructions to create your personal passcode and to record your name and greeting.
3. Set up [Call Forwarding](#) to direct your calls to the voice mail hunt group number.

Enable Visual Voice Mail

To enable Visual Voice Mail

1. Press **Applications**.
2. Press **Settings**.
3. Press **Message Key Configuration**.
4. Select **Open Voice Mail Application**.
5. Press **Save**.

Opening the Visual Voice Mail application

You can open the *Visual Voice Mail* application by selecting it in the *Application* list or by using the *Settings* application to program a key (either a feature key or the Message key,  to open it. See “[Program Feature Keys Using the Settings Application](#).”

Note: You must log out of Visual Voice Mail before you can access your voice mailbox from the dialpad.

Log into your mailbox from your own extension

To login to your mailbox from your extension:

1. Open the *Voice mail* application.

Note: The mailbox number assigned to the prime extension of this phone is displayed. From this window, only the mailbox assigned to this extension can be logged into. If this is not your mailbox number, see [Log into your mailbox from another extension](#). If there is no mailbox associated with the phone’s primary DN, the mailbox status is displayed as *No Mailbox*. In this case, see [Log into your mailbox from another extension](#).

2. Enter your passcode.
3. Press **OK**.
4. If you wish to have the system remember this passcode, press **Remember my passcode** to enable the check box ()
5. Press **Login**.

Note: While you are logged into your mailbox, no indication of any new messages arriving is provided until you log out and log in again.

Log into your mailbox from another extension

To login to your mailbox from another extension:

1. Open the *Voice mail* application.
2. Press **Connect as guest**.
3. Enter your mailbox number.
4. Press **Enter Passcode**.
5. Enter your passcode.
6. Press **Login**.

Note: If you wish to return to the owner login window, press **Connect as owner** at any time.

Log out of your mailbox

To logout of your mailbox:

- Press Logout. This closes the *Voice Mail* application.

Note: After five minutes of inactivity, you are automatically logged out of your mailbox and the *Voice Mail* application closes. When you close the *Voice Mail* application, you are **not** automatically logged out of your mailbox.

About the Visual Voice Mail main window

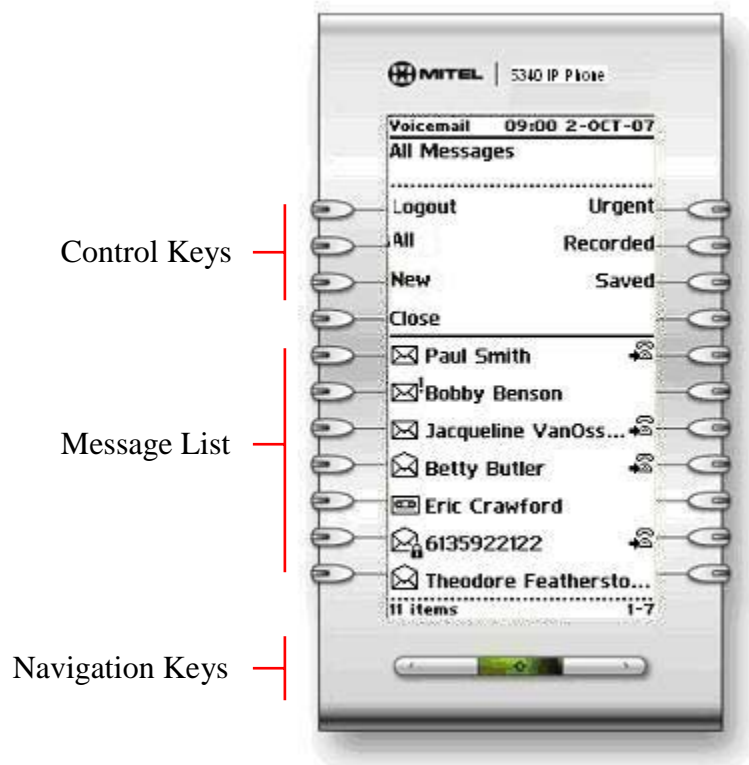

The Voice Mail Application Main Window

The Voice Mail application main window contains a chronological list of the voice messages in your mailbox, with the oldest message listed first. Use the Navigation keys to scroll through the messages. By default, only new messages are listed when the main screen opens. You sort the list by message type using the sorting keys (All, New, Urgent, Recorded, Saved) in Control keys area. Messages are marked in the following ways:

Icon	Type of Message
	New (never played)
	New Confidential
	New Urgent
	New Confidential Urgent
	Saved
	Saved Confidential
	Saved Urgent
	Saved Confidential Urgent
	Recorded calls recorded using the Record A Call feature

Note: Confidential messages cannot be forwarded.

Display message details

To display details about a message:

1. Open the *Voice mail* application.
2. Login to your mailbox.
3. Press on a message in your message list. The Message Details window displays showing the following information about your message:
 - Message sender name and number (if available)
 - Message type: new, saved, confidential, urgent or recorded, receipt confirmation
 - Date, time and duration of message



The Message Details Window

In this window, you can save (Keep), play, or delete (Discard) the message. You can send the voicemail to your email if the Forward to Email feature is enabled or forward it to another user. You can dial the message sender or add the message sender to your contact list in the *People* application.

4. To view other messages and their details, use the Navigation keys (◀, ▶) to move up or down through your message list.

Play a voice message

To play a voice message:

1. Open the *Voice mail* application.
2. Login to your mailbox.
3. Select a message in your message list.
4. Press **Play**.

Control the play of the message via the following command buttons:

- stop
- pause
- rewind the message by five seconds (⏮ Skip)
- fast forward the message by five seconds (Skip ⏭)
- go to the beginning of the message (⏮ To start)
- go to the end of the message (To end ⏭)

Note: The audio connection is terminated after 30 seconds of idle time.

Dial message sender

To dial the phone number of a message sender:

1. Open the *Voice mail* application.
2. Login to your mailbox.
3. Do one of the following:
 - In the main window Message List, press the Dial key to the right of the message.
 - Select a message in your message list to display the Message Details, and then press **Dial**.

If there is no known number, the Dial key is disabled (no icon appears next to the key).

If the number is external, enter the required prefix digit (for example “9”) to access an outside line before pressing **Dial**. When dialing from the window Message List, the number is dialed as displayed; no prefix entry is allowed.

Pressing **Dial** may display the *Phone* application depending on the Call Notification preference selected in the *Settings* application.

Save a message

To save a message:

1. Open the *Voice mail* application.
2. Login to your mailbox.
3. Press on a message in your message list.
4. Press **Keep**.

The saved message is removed from the new list and added to the saved list.

Delete a message

To delete a message:

1. Open the *Voice mail* application.
2. Login to your mailbox.
3. Press on a message in your message list.
4. Press **Discard**.

The next message in the message list is displayed. If the last message in the list was deleted, the Message Details window is closed.

Add a message sender to your contacts list

To add a sender to your contact list:

1. Open the *Voice mail* application.
2. Login to your mailbox.
3. Select a message in your message list.
4. Press **To contacts**.

The contact is added to your contacts list in the *People* application. If the contact already exists in your contact list, it is not added.

Forward a message to another mailbox

You can only forward messages to internal mailboxes. Confidential messages cannot be forwarded.

To forward a message to another mailbox:

1. Open the *Voice mail* application.

2. Login to your mailbox.
3. Select a message in your message list.
4. Press **Give**.
5. Enter the recipient's mailbox number.
6. Press **Send message**.

Forward a message to your email address

You can only forward a message to your email address if the Forward to Email feature is enabled on your system. You can tell that the feature is disabled by the absence of a **To Email** button on your phone.

To forward a message to your email address:

1. Open the *Voice mail* application.
2. Login to your mailbox.
3. Select a message in your message list.
4. Press **To Email**.

The message is forwarded to your email address. If you have set your preference in the Desktop User tool to delete messages when forwarding, the message is deleted (but remains in the list until you log out of your mailbox).

USING YOUR PHONE WITH THE 5310 IP CONFERENCE UNIT

Your phone uses the 5310 IP Conference Unit for conferencing. You use the Conference Controller to turn the conference unit off or on, to adjust the volume or to put the conference unit into Presentation mode. You can only run one Conference Controller session at a time. If the 5310 Conference Unit is not connected to your phone, the *Conference Controller* application is not available.

Access the Conference Controller

To access the Conference Controller:

1. Press the blue **Applications**  key and press **Conference Unit**, or
2. Press the key programmed to the *Conference Unit* application.

Turn the conference unit on and off

1. Verify that the conference unit is connected to your phone.
2. Access the Conference Controller. For more information, see [Access Conference Controller](#).
3. Press **Turn On/Turn Off**.

While the Conference Unit is on, the  icon shows in the phone status line.

Adjust the conference unit volume

- Press Volume Up or Volume Down.

Place the conference unit in Presentation mode

Presentation Mode is used when only one individual is speaking to a group. If another member in the group wishes to speak, you must disable Presentation Mode. Presentation Mode minimizes extraneous noise.

To place the conference unit in Presentation mode

- Press Presentation Mode.

Exit the conference controller

To exit the conference controller

- Press **Close**.

Mute the conference unit

To mute the conference unit so that conversation in the meeting room cannot be heard by individuals being conferenced:

- Press **Mute**.

USING THE LINE INTERFACE MODULE

Your phone supports the Mitel Line Interface Module. The Line Interface Module allows you to make and receive calls over an analog line (Line Interface Module line) connected to your phone. The Line Interface Module operates in either of the following two modes, as determined by your System Administrator:

- **Line Interface Module Mode:** your phone allows you to use the Line Interface Module line at any time
- **Failover Mode:** you can use the Line Interface Module line only when the IP connection has failed

Note: Handsfree and on-hook dialing are not supported on the Line Interface Module line.

For information on emergency number dialing using the Line Interface Module, refer to Emergency Calls.

Making and Answering Calls Using the Analog key

To make a call using the Analog line:

1. Lift the handset.
2. Press the key you programmed as **Analog Line**.

ANALOG CALL is displayed.

3. Dial the number.

Note: When you make an external call over the analog line, a prefix dialing number is not required. If your phone's Analog Line key has the Privacy option enabled, you cannot access the analog line when another phone is using the analog line (key is solid orange). To access the analog line, the user of the other phone must first hang up. To determine whether the Privacy option is enabled, contact your System Administrator.

To answer a Call using the analog line:

1. Lift the handset.
2. Press the **Analog Line** key that is highlighted.

To answer a waiting call on the analog line:

Note: If you have subscribed to an analog call waiting service, you may use the hookswitch or press **Cancel** (⊗) to answer a waiting analog call. When you are on an analog call and a waiting analog call arrives, you hear a beep. This feature may not be supported in all regions.

To answer a waiting analog call or return to the original analog call:

1. Do one of the following:
 - Press and release the hookswitch
 - Press **Cancel** (⊗)
2. Press the key you have programmed as **Analog Line**.

To put a current call on hold to answer an incoming analog call:

- Press the highlighted **Analog Line** key.

To switch between the current call and the held call when one of the calls is using the analog line, do one of the following:

- If your current call is using the analog line, press the flashing Line key of the held call. The analog call is automatically put on hold.
- If your current call is using an IP line, press the highlighted Analog Line key. The IP line is automatically put on hold.

To end a current call when an incoming analog call arrives:

- Press **Cancel** (⊗) and then press the highlighted Analog Line key. The current call ends and you are connected to the caller on the analog line.

To end the current analog call when an incoming call arrives:

- Press **Cancel** (⊗). The current analog call ends and you are connected to the new caller.

Making and Answering Calls Using the Failover Mode

To make a call using the analog line during an IP connection failure:

1. Lift the handset.
The phone displays *IP FAIL: ANALOG CALL*.
2. Dial the number.

To answer a call using the analog line during an IP connection failure:

- Lift the handset. The call is answered. The phone displays *IP FAIL: ANALOG CALL*.

USING YOUR PHONE WITH THE CORDLESS MODULE AND ACCESSORIES

The cordless handset and cordless headset provide users with the capability to move around within their own office or adjacent offices while using the telephone.

Both cordless devices connect to your IP telephone through the cordless module, which attaches to the back of the phone. The cordless headset rests and recharges in a headset cradle that attaches to the side of the telephone. The cordless handset recharges in the handset cradle.

The Cordless Devices Application (see page 92) provides access to the configuration settings and information screens that apply to the cordless module and accessories.

Note: Since only one module type can be attached to the phone at any given time, you can not use a Programmable Key Module (PKM) when the Cordless Module is attached.

CAUTION: Attempting to remove the back plate on the telephone to install the Cordless Module before disconnecting the telephone's power supply may damage the telephone. For information about installing the Cordless Module, see the *Cordless Module and Accessories Installation Guide for Mitel 5330/5340 IP Phones* available at Mitel OnLine.



Figure 1. Cordless Module and Accessories on 5300 Series Phone



Figure 2. Rear view

Elements of Your Cordless Module and Accessories

Feature	Function
1) Cordless Module	Attached to the back of the phone, the module contains a Light Emitting Diode (LED) indicating that a cordless device is in use; also indicates the state of pairing between the module and a cordless device.
2) Cordless Headset	Cordless hands free operation for calls. If you are using the cordless headset, you do not need to use the handset.
3) Cordless Headset Charging Cradle	Provides power to recharge the cordless headset battery.
4) Cordless Handset Charging Cover	Provides power to recharge the cordless handset battery. Replaces the cover supplied with the phone for corded handsets.
5) Cordless Handset	Cordless operation for handset calls. (You can transfer from the phone handset to the cordless headset at any time.)
(Figure 2)	
6) Cordless Module pairing button	Initiates pairing between the Cordless Module and a cordless accessory.
7) Cordless Headset Cradle cable	Connects to the Cordless Module to provide power to the charging cradle.

Handset/Headset Combinations

The following combinations of corded and cordless headset and handset are supported on the 5330/5340 IP Phone:

- Corded handset only
- Corded headset only
- Corded handset and corded headset
- Cordless handset only
- Cordless headset only
- Cordless handset and cordless headset
- Corded handset and cordless headset
- Corded headset and cordless handset

Pairing the Cordless Module and Accessories

The cordless headset and handset are optional accessories, ordered separately. Before use, each must establish communication with the Cordless Module using a procedure called pairing.

Notes:

- An IP telephone can have only one cordless handset and one cordless headset
- A cordless handset or headset can be paired with only one IP telephone at a time
- Pairing a new cordless handset or headset with the IP telephone overwrites the configuration of any previous handset or headset
- Pairing cannot be performed when the cordless device is already in use.

Pairing a Cordless Accessory with the Cordless Module

To pair a cordless accessory:

1. Ensure that the battery of the cordless device to be paired is at least partially charged.
2. Press and hold down the pairing button on the back of the Cordless Module (see Figure 2 on page 82) for 5 seconds to activate telephone pairing mode. The LED on the Cordless Module blinks. The Cordless Devices application opens on the telephone and prompts you to “Press the pairing button on the cordless device now.”
3. Press and hold down the hookswitch on the cordless handset or headset for 5 seconds to activate accessory pairing mode. The LED on the cordless accessory blinks. After a moment, the Cordless Devices application displays protocol, firmware, hardware, and IPEI information for the device to be paired.
4. Press **Yes** to confirm pairing. The Cordless Devices application confirms the pairing by displaying the paired device name and its battery level indicator.
5. Press **Close** to exit.

To unpair a cordless accessory:

9. Press the blue **Applications**  key and then press **Cordless Devs**.
10. Press the device name that you want to unpair. The information screen for the selected device appears.
11. Press **Unpair this Device**. If the accessory is in use, an error message is displays. Otherwise, the accessory is unpaired, removed from the display, and can no longer be used to interact with the phone.
12. Press **Close**.

For more information about the Cordless Devices Application, see page 92.

Cordless Module LED Indicators

The Cordless Module has a blue light-emitting diode (LED) that indicates the current status of the module (See Figure 1):

Blue LED	Function
Solid	Audio is active between the module and either the handset or headset.
Blinking	Pairing mode is active or a firmware upgrade is in progress.
Off	No audio is active.
Solid for 2 seconds	Pairing is successful.

Blinking: LED is On and Off for equal amount of time

Using a Cordless Device as a Remote Control

When not being used to talk, the cordless handset/headset buttons can act as a remote control device to change display contrast, volume, and mute settings on the host IP phone. For example, in a remote handsfree conference setting, the chairman can use the volume and mute buttons on a cordless device to adjust speaker levels and mute the microphone on an IP phone that is not within his reach. HTML applications may also make use of the cordless device buttons but functionality may differ among applications.

USING THE CORDLESS HANDSET

The cordless handset provides office mobility, allowing you to make and answer calls while away from your desk. Replacing the standard corded handset, the cordless handset contains a rechargeable battery that charges in the handset cradle when not in use.

To use the Cordless Handset, you must pair the handset with the phone. For more information, see “Pairing the Cordless Module and Accessories” on page 85.



LL0171

Figure 3. Cordless Handset on 5300 Series Phone

Elements of the Cordless Handset

Feature

1) Cordless Handset LED

Function

Blue: Light-emitting diode (LED) indicating the status of the handset.

Green: LED indicating the status of the handset battery.

For more information see Cordless Handset LEDs on page 90

2) Hookswitch Button

Lifting the handset from the cradle activates the handset. If the handset is already out of the cradle, pressing the hookswitch takes the handset off-hook. Pressing the hookswitch again returns it to on-hook.

Pressing the hookswitch while on a speakerphone call, moves the call to the cordless handset.

Feature	Function
3) Mute button	Mute allows you to turn the microphone off during a call.
4) Volume Up and 5) Volume Down buttons	Up and Down provide volume control for the ringer and handset/headset.

Note: The IP Phone deactivates the cordless handset when a corded handset is plugged in.

Answer a call

Do one of the following:

- Lift the cordless handset.
- If the handset is already out of the cradle, press the hookswitch button on the handset.

Note: A call on a Line Appearance key answered while a call is on hold on the Prime Line, is presented over the speaker.

Hang up

Do one of the following:

- Replace the cordless handset in the cradle.
- Press the hookswitch button on the handset.

Dialing – Auto Dial Disabled

To dial a number with Auto Dial disabled:

1. Lift the handset or press the hookswitch.
2. Make the call using the dial pad, or press a programmed speed dial key on the phone.

Dialing – Auto Dial Enabled

To dial with Auto Dial enabled:

- To dial the predefined Auto Dial number, press the hookswitch on the cordless handset or headset.

To program Auto Dial, refer to *Using the Cordless Devices Application* on page 94.

Alerting Tones and LEDs

The cordless accessories provide the following alerting tones:

Feature	Function
Mute key on cordless device ON/OFF	2-pitch tone occurs immediately. Reminder tone occurs 30 seconds after activation and then regularly until deactivated.
Mute key on Phone ON/OFF	No immediate tone. Reminder tone occurs 30 seconds after activation and then regularly until deactivated.
Low battery (within 10 minutes left)	3 beeps and 20 second pause repeated 3 times
Low battery (within 2 minutes left)	3 rapid beeps and 1.5 second pause repeated 3 times
Out of range	Repetitive 3-pitch tone until you are back in range. Note: If you are out of range for more than 10 seconds, any call that is in progress is dropped and not recovered.

Note: Audio indications are heard in the handset only when it is in use and may interrupt voice transmission.

Cordless Handset LEDs

The handset has two LEDs:

- Blue – indicates the operational status of the handset
- Green – indicates the status of the electrical charge of the battery

LED Color	LED State	Indicates
Blue	Solid	Handset is muted
	Blinking	Handset is in pairing mode
	Winking	Active audio path between Handset and Module
	Off	<ul style="list-style-type: none"> • No audio path between Handset and Module OR • Battery is dead
Green	Solid	Battery is fully charged
	Blinking	Battery is charging. Note: It is normal for the handset LED to cycle between blinking and solid as battery charge is maintained.
	Off	When handset is cradled and the LED does not flash or illuminate, this indicates an absence of battery power. During the first 30 – 60 minutes that the light is off, the battery may be trickle charging. If that is the case, the LED will resume normal behavior within that 60 minute period. If the LED remains off for more than 60 minutes, then either the battery is no longer chargeable or there is a problem in the charging circuit.

Blinking: LED is On and Off for equal amount of time

Winking: LED is On for a short period of time and Off for a longer period

USING THE CORDLESS HEADSET

The cordless headset offers the same capability as the cordless handset to make and answer telephone calls away from your desk while adding the convenience of hands-free operation.

When not in use, the cordless headset sits in the headset charging cradle.

To use the Cordless Headset, you must pair the headset with the phone. For more information, see “Pairing the Cordless Module and Accessories” on page 83.

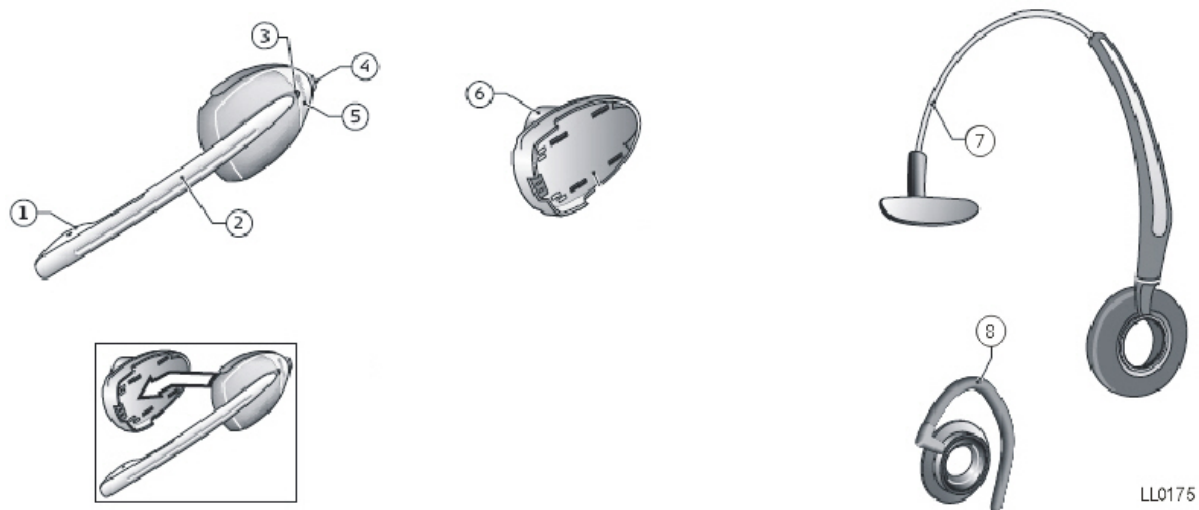

Elements of the Cordless Headset

Feature

- 1) Microphone
- 2) Boom arm
- 3) Link indicator (LED)
- 4) Volume control with mute switch
- 5) Hookswitch and pairing button (gray section with logo imprinted)
- 6) Speaker
- 7) Headband
- 8) Ear hook

Answer a call

Do one of the following:

- Lift the cordless headset from the cradle.
- If the headset is already out of the cradle, press the hookswitch button on the headset.

Hang up

Do one of the following:

- Replace the cordless headset in the cradle.
- If the headset is already out of the cradle, press the hookswitch button on the headset.

Dialing – Auto Dial Disabled

To dial a number with Auto Dial disabled:

1. Lift the headset or press the hookswitch.
2. Make the call using the dial pad, or press a programmed speed dial key on the phone.

Dialing – Auto Dial Enabled

To dial with Auto Dial enabled:

- To dial the predefined Auto Dial number, press the hookswitch on the cordless handset or headset.

To program Auto Dial, refer to *Using the Cordless Devices Application* on page 92.

Headset Alerting Tones and LEDs

The cordless accessories provide the following alerting tones:

Feature	Function
Mute ON/OFF	2-pitch tone occurs immediately. Reminder tone occurs 30 seconds after activation and then regularly until deactivated.
Mute key on Phone ON/OFF	No immediate tone. Reminder tone occurs 30 seconds after activation and then regularly until deactivated.
Low battery (within 10 minutes left)	3 beeps and 20 second pause
Low battery (within 2 minutes left)	3 rapid beeps and 1.5 second pause

Feature	Function
Out of range	Repetitive 3-pitch tone until you are back in range. Note: If you are out of range for more than 10 seconds, any call that is in progress is dropped and not recovered.

Cordless Headset LEDs

There are two LEDs associated with the cordless headset:

- A blue LED on the headset indicates the headset status
- A green LED in the headset charging cradle indicates battery status

LED Color	LED State	Indicates
Blue (on headset)	Solid	Headset mic is muted
	Blinking	Headset is in pairing mode
	Winking	Active audio path between Headset and Module
	Solid for 2 seconds	<ul style="list-style-type: none"> • Pairing successful OR • New battery installed
	Off	<ul style="list-style-type: none"> • No audio path between Headset and Module OR • Battery is dead
Green (on cradle)	Solid	Battery is fully charged
	Blinking	Battery is charging. Note: It is normal for the headset LED to cycle between blinking and solid as battery charge is maintained.
	Winking	Indicates low voltage when headset is uncradled
	Off	When headset is cradled, indicates battery is not charging.

Blinking: LED is On and Off for equal amount of time

Winking: LED is On for a short period of time and Off for a longer period

USING THE CORDLESS DEVICES APPLICATION

The Cordless Devices Application provides access to module information and pairing for hand- or headsets.

To access the Cordless Devices Application, do one of the following:

- Press the blue **Applications**  key and then press **Cordless Devices**
- Press a feature key you have programmed as the Cordless Devices Application key.

For information about programming feature keys, see page 29.

Note: When the pairing button on the Cordless Module is pressed, or when the battery level of a cordless accessory is critically low, the phone will automatically open the Cordless Devices Application.

Viewing Cordless Module Information

You can use the Cordless Module Application to view protocol, firmware, and hardware information about the module.

To view cordless module information

1. Access the Cordless Module Application.
2. Press **Cordless Module Info**. Device information appears on the screen.
3. Press **Close** to exit.

Low Battery Level

When the battery of a cordless device reaches a near-critical level, the phone displays a warning. Until the battery is recharged (or until it becomes fully discharged), the warning is repeated at each new call made using the Prime Line. To continue with a call while charging the cordless accessory, switch to speakerphone and then cradle the cordless accessory.

Auto Dial

When a Cordless Module is installed and at least one device is paired, the Auto Dial feature is available in the Settings menu. You can program a number that is automatically dialed when a cordless device hookswitch button is pressed.

To program an Auto Dial number:

1. Press **Settings**.
2. Press **Auto Dial**, and then press **Edit Number**.
3. In the on-screen keyboard, enter the autodial number ([see Using the Dial Pad to Enter Information](#)).
4. Press **Save**.
5. Press **Edit Label**.
6. In the on-screen keyboard, enter the appropriate information.
7. Press **Save** and then press **Close**.

To disable Auto Dial:

1. Press **Settings**.
2. Press **Auto Dial**.
3. Press **Disable Auto Dial**. The Auto Dial settings you have programmed are maintained when the feature is disabled.
4. Press **Save**.
 - To re-enable, repeat steps 1 and 2 and then press **Enable Auto Dial**.
 - To change Auto Dial information, press **Edit Number** and/or **Edit Label**.
 - Press **Save** to save all changes.

Free Manuals Download Website

<http://myh66.com>

<http://usermanuals.us>

<http://www.somanuals.com>

<http://www.4manuals.cc>

<http://www.manual-lib.com>

<http://www.404manual.com>

<http://www.luxmanual.com>

<http://aubethermostatmanual.com>

Golf course search by state

<http://golfingnear.com>

Email search by domain

<http://emailbydomain.com>

Auto manuals search

<http://auto.somanuals.com>

TV manuals search

<http://tv.somanuals.com>