

Best Value to Meet Basic Computing Needs

POWERMATE® VT 300 SERIES



U S E R ' S G U I D E

NEC

Proprietary Notice and Liability Disclaimer

The information disclosed in this document, including all designs and related materials, is the valuable property of NEC Computer Systems Division, Packard Bell NEC, Inc. (hereinafter "NEC CSD") and/or its licensors. NEC CSD and/or its licensors, as appropriate, reserve all patent, copyright and other proprietary rights to this document, including all design, manufacturing, reproduction, use, and sales rights thereto, except to the extent said rights are expressly granted to others.

The NEC CSD product(s) discussed in this document are warranted in accordance with the terms of the Warranty Statement accompanying each product. However, actual performance of each such product is dependent upon factors such as system configuration, customer data, and operator control. Since implementation by customers of each product may vary, the suitability of specific product configurations and applications must be determined by the customer and is not warranted by NEC CSD.

To allow for design and specification improvements, the information in this document is subject to change at any time, without notice. Reproduction of this document or portions thereof without prior written approval of NEC CSD is prohibited.

NEC and PowerMate are registered trademarks of NEC Corporation, used under license. All other product, brand, or trade names used in this publication are the trademarks or registered trademarks of their respective trademark owners.

First Printing — August 1999

Copyright 1999
NEC Computer Systems Division
6000 Florin-Perkins Road
Sacramento, CA 95828-1037
All Rights Reserved

Contents

Using This Guide

| | |
|-------------------------|-----|
| Text Conventions | xi |
| Related Documents | xii |

1 Reviewing System Features

| | |
|------------------------------------|------|
| Front Features | 1-2 |
| System Controls and Lamps | 1-3 |
| Diskette Drive A..... | 1-4 |
| Universal Serial Bus Port..... | 1-4 |
| CD-ROM Drive..... | 1-5 |
| DVD-ROM Drive..... | 1-5 |
| Tape Backup Unit..... | 1-5 |
| Zip Drive..... | 1-6 |
| PC Card Adapter | 1-6 |
| LS-120 SuperDisk Drive | 1-6 |
| Rear Features | 1-7 |
| External Connectors | 1-8 |
| Power Supply Features | 1-10 |
| Inside Features | 1-10 |
| System Board | 1-11 |
| Network Board..... | 1-12 |
| Modem Board | 1-12 |
| Storage Device Support | 1-12 |
| Chassis | 1-12 |
| Speakers | 1-13 |
| System Features | 1-13 |
| Hardware..... | 1-13 |
| Software..... | 1-14 |
| Preloaded Operating System | 1-14 |
| NEC OS Restore CD..... | 1-15 |
| NEC Application and Driver CD..... | 1-15 |
| Security | 1-16 |

| | | |
|----------|--|------|
| 2 | Setting Up the System | |
| | Cable Connections | 2-2 |
| | Startup | 2-3 |
| | Shutdown..... | 2-4 |
| | Power-Saving Operation | 2-5 |
| | System Care..... | 2-6 |
| | Protecting Your System From Damage..... | 2-6 |
| | Keeping Your System in Good Condition | 2-8 |
| | Moving or Shipping Your System..... | 2-9 |
| | More Information..... | 2-10 |
| | | |
| 3 | Configuring the System | |
| | Configuration Tools and Utilities | 3-2 |
| | BIOS Setup Utility | 3-5 |
| | How to Start BIOS Setup..... | 3-6 |
| | How to Use BIOS Setup | 3-7 |
| | Main Menu | 3-7 |
| | Advanced Menu | 3-11 |
| | Security Menu | 3-18 |
| | Exit Menu | 3-19 |
| | FLASH Utility | 3-20 |
| | NEC OS Restore CD..... | 3-21 |
| | Introducing OS Restore Options | 3-21 |
| | Choosing a Restore Program..... | 3-21 |
| | Launching the NEC OS Restore CD | 3-22 |
| | Auto Rebuild and Restore..... | 3-24 |
| | Custom Rebuild and Restore..... | 3-26 |
| | Fixing the Operating System..... | 3-29 |
| | NEC Application and Driver CD..... | 3-31 |
| | Launching the Application and Driver CD | 3-31 |
| | Installing Software | 3-32 |
| | NEC Help Center | 3-33 |
| | Installing the NEC Help Center | 3-33 |
| | Uninstalling the NEC Help Center..... | 3-34 |
| | Resolutions for NEC VistaScan USB Monitors | 3-34 |

| | |
|------------------------------------|------|
| System Board Jumper Settings | 3-35 |
| Processor Jumper Settings | 3-37 |
| Clear CMOS/Password..... | 3-38 |
| Power On Mode | 3-40 |

4 Installing Options

| | |
|--|------|
| General Rules | 4-2 |
| Safety Precautions..... | 4-3 |
| System Unit Covers | 4-4 |
| Removing the Left Side Cover..... | 4-5 |
| Replacing the Left Side Cover | 4-7 |
| Removing the Right Side Cover..... | 4-9 |
| Replacing the Right Side Cover | 4-11 |
| System Board Options..... | 4-12 |
| Memory Upgrade | 4-13 |
| Checking System Memory | 4-15 |
| Removing a DIMM..... | 4-16 |
| Installing a DIMM | 4-17 |
| Processor Upgrade..... | 4-19 |
| Removing a Celeron or Pentium III Processor | 4-20 |
| Installing a Celeron or Pentium III Upgrade Processor .. | 4-22 |
| Removing the Pentium II Processor..... | 4-24 |
| Installing the Pentium II Upgrade Processor | 4-26 |
| Expansion Boards | 4-29 |
| Locating Expansion Slots and Connectors | 4-30 |
| Installing an Expansion Board | 4-31 |
| Removing an Expansion Board..... | 4-33 |
| AGP Board | 4-33 |
| Removing the AGP Graphics Board | 4-33 |
| Installing the AGP Graphics Board..... | 4-34 |
| Data Storage Devices | 4-35 |
| Locating Device Bays..... | 4-35 |
| Preparing the Device | 4-37 |
| Connecting Device Cables..... | 4-37 |
| Diskette Drive Signal Cable | 4-40 |
| IDE Signal Cables..... | 4-41 |
| System Power Cables..... | 4-41 |

| | |
|---|------|
| Cabling Storage Devices..... | 4-41 |
| IDE Drive Cabling..... | 4-42 |
| Diskette Drive Cabling..... | 4-43 |
| PC Card Adapter Cabling..... | 4-43 |
| Network Board Wake-On LAN Cabling..... | 4-44 |
| Installing Storage Devices..... | 4-45 |
| Removing the Front Panel..... | 4-45 |
| Replacing the Front Panel..... | 4-48 |
| Installing a 3 1/2-Inch Hard Drive..... | 4-48 |
| Installing a 5 1/4-Inch Device..... | 4-51 |

5 Solving System Problems

| | |
|---|------|
| Solutions to Common Problems..... | 5-2 |
| System Problems..... | 5-2 |
| Diskette Drive Problems..... | 5-4 |
| Monitor Problems..... | 5-5 |
| Keyboard/Mouse Problems..... | 5-6 |
| CD-ROM Drive Problems..... | 5-7 |
| Speaker Problems..... | 5-8 |
| How to Clean the Mouse..... | 5-9 |
| Battery Replacement..... | 5-11 |
| How to Get Help..... | 5-14 |
| Help From Your Company..... | 5-14 |
| Help From Your NEC CSD Dealer..... | 5-14 |
| Help From NEC CSD Technical Support Center..... | 5-15 |
| NEC CSD Warranty/Non-Warranty Repair Service..... | 5-16 |

6 Getting Services and Support

| | |
|--|-----|
| NEC CSD Website..... | 6-2 |
| NEC CSD FTP Site..... | 6-3 |
| Email/Fax Technical Support Service..... | 6-3 |
| NEC CSD Bulletin Board System..... | 6-4 |
| NEC CSD Technical Support Services..... | 6-7 |

A Setting Up a Healthy Work Environment

| | |
|--|------|
| Making Your Computer Work for You..... | A-2 |
| Arrange Your Equipment | A-4 |
| Adjust Your Chair..... | A-5 |
| Adjust Your Input Devices | A-7 |
| Adjust Your Monitor..... | A-9 |
| Vary Your Workday..... | A-11 |
| Pre-existing Conditions and Psychosocial Factors | A-12 |
| Checking Your Comfort: How Do You Measure Up?..... | A-13 |
| Checking Your Chair..... | A-13 |
| Checking Your Keyboard | A-13 |
| Checking Your Mouse..... | A-13 |
| Checking Your Monitor..... | A-13 |
| Checking You | A-14 |

B System Specifications

| | |
|-----------------------------------|-----|
| System Processor | B-2 |
| Processor Support..... | B-2 |
| Secondary Cache | B-3 |
| Processor Socket | B-3 |
| Random Access Memory (RAM) | B-3 |
| Cache Memory | B-3 |
| Read Only Memory (ROM) | B-3 |
| Calendar Clock | B-4 |
| Input/Output (I/O) Features | B-4 |
| Video Memory..... | B-5 |
| Sound System | B-6 |
| Fax/Modem Board..... | B-6 |
| Peripherals | B-6 |
| Network Board..... | B-6 |
| AGP Graphics Board..... | B-7 |
| Diskette Drive | B-7 |
| Hard Drive | B-8 |

| | |
|----------------------------|------|
| CD-ROM Drive..... | B-8 |
| DVD-ROM Drive..... | B-8 |
| PC Card Adapter | B-9 |
| Zip Drive..... | B-9 |
| Tape Backup Unit..... | B-9 |
| Speakers..... | B-10 |
| Dimensions..... | B-10 |
| System Unit..... | B-10 |
| Keyboard..... | B-10 |
| Power | B-10 |
| Operating Environment..... | B-10 |
| Compliance..... | B-11 |

Index

Using This Guide

The *PowerMate VT 300 Series User's Guide* provides a comprehensive reference to information about your computer.

The guide contains the following information:

- Chapter 1, *Reviewing System Features*, provides a look at the front, rear, internal, and peripheral features of the system. It also gives a summary of the system's hardware, software, and security features.

The chapter includes a quick-reference chart for finding information described more fully later in the document.

- Chapter 2, *Setting Up the System*, explains how to set up, start up, and shut down the system. It also provides information on installing applications, and tips on caring for the system.
- Chapter 3, *Configuring the System*, describes how to use the software utilities shipped with your system, including the BIOS Setup Utility, the NEC OS Restore CD, and the NEC Application and Driver CD. It also provides information for setting system board jumpers.
- Chapter 4, *Installing Options*, provides detailed installation procedures for system upgrades and options.
- Chapter 5, *Solving System Problems*, contains troubleshooting tips for solving simple problems and describes how to find help when you cannot solve a problem yourself.

-
- Chapter 6, Getting Services and Support, describes the services available to you for information and help, and describes how to access the services.
 - Appendix A, Setting Up a Healthy Work Environment, contains guidelines to help you use your computer productively and safely. This appendix also instructs you on how to set up and use your computer to reduce your risk of developing nerve, muscle, or tendon disorders.

 **WARNING**

Prolonged or improper use of a computer workstation may pose a risk of serious injury. To reduce your risk of injury, set up and use your computer in the manner described in Appendix A, Setting Up a Healthy Work Environment.

- Appendix B, System Specifications, provides a technical description of your computer and its components.

Text Conventions

This guide uses the following text conventions.

- Warnings, cautions, and notes have the following meanings:

WARNING

Warnings alert you to situations that could result in serious personal injury or loss of life.

CAUTION

Cautions indicate situations that can damage the hardware or software.

 **Note:** Notes give important information about the material being described.

- Names of keyboard keys are printed as they appear on the keyboard, for example, **Ctrl**, **Alt**, or **Enter**.
- Text or keystrokes that you enter appear in boldface type. For example, type **abc123** and press **Enter**.
- File names are printed in uppercase letters. For example, AUTOEXEC.BAT.

Related Documents

In addition to this guide, the following printed documentation ships with your computer.

- ***NEC PowerMate VT 300i Series Quick Setup/Quick Reference***

The Quick Setup shows how to quickly get the system connected and powered on.

The Quick Reference briefly describes the documentation, NEC CSD tools and utilities, software applications, and services available with the NEC PowerMate® VT 300 Series computer.

- ***How Does Your Workplace Measure Up?***

This brochure provides information for setting up and using the computer productively and safely. Information includes guidelines to reduce the risk of injury associated with using a computer.

- ***NEC PowerMate VT 300 Series Release Notes***

Release Notes provide additional information about the computer that was not available at the time the user's guide was printed.

Your system comes with the following online documentation on the NEC Application and Driver CD.

- **NEC Help Center**

The NEC Help Center is an online guide to PowerMate computers. It provides information about your system under the following topics: System Tour, System Information, System Upgrades, Service and Support, and Reference.

- **Healthy Environment**

This is an online help file that complements the “How Does Your Workplace Measure Up?” brochure.

In addition, service and reference manuals are available on the Internet at the Service and Support area of the NEC CSD website (see Chapter 6 for access information).

1

Reviewing System Features

- Front Features
- Rear Features
- Inside Features
- Speakers
- System Features

WARNING

Prolonged or improper use of a computer workstation may pose a risk of serious injury. To reduce your risk of injury, set up and use the computer in the manner described in Appendix A, Setting Up a Healthy Work Environment.

This chapter highlights system hardware and software, and describes the security features of the system.

Front Features

The following figure shows the features on the front of the system. A brief description follows the figure.

Front features

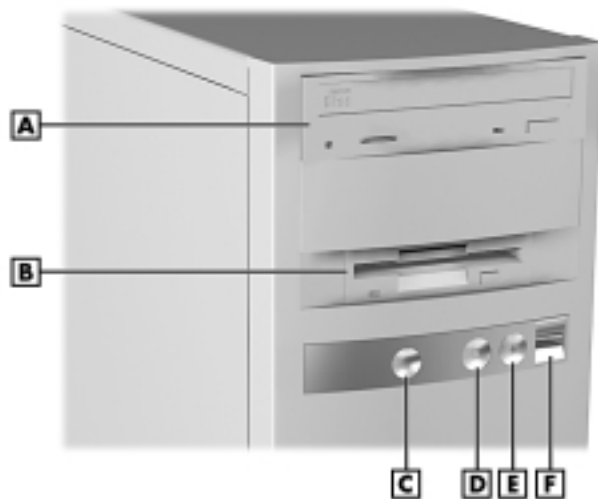

A – CD-ROM Drive
B – Diskette Drive
C – Power/Sleep Button

D – Power/Sleep Lamp
E – Hard Drive Lamp
F – USB Port

1-2 Reviewing System Features

System Controls and Lamps

System controls let you select specific system operations. Lamps let you know the status of system operation. The following describes the controls and lamps. The previous figure shows the controls and lamps on the front of the system.

- **Power/Sleep button**

Press this button to turn on system power. To turn off power, press the button and hold in place until the system powers down (approximately three to four seconds).

Press and immediately release the power/sleep button to suspend system operation when you plan to be away from your computer for a short time. This places the system in a power saving mode. If you have a VESA-compliant monitor, your monitor also goes into a power-saving mode.

Press any key or move your mouse to resume system operation at the point where you stopped it.

An amber system unit power lamp indicates that the system is in a power-saving mode.

- **Power/Sleep lamp**

The power/sleep lamp indicates whether system power is on or off. It also lets you know if the system is operating in a power-saving mode.

A steady green lamp indicates that the power is on to all system components. An amber lamp indicates that the system is in Sleep mode with full-power reduction.

- **Hard drive lamp**

A lit lamp indicates that the hard drive is active. The green lamp tells you that the hard drive is reading or writing data.



CAUTION

Do not turn off the system unless absolutely necessary while the hard drive lamp is lit. To do so can damage your hard drive or data.

Diskette Drive A

Use diskette drive A to copy data files to and from a diskette. You can also use it as a bootable drive for loading and starting programs from a diskette.



CAUTION

To prevent damage to your diskette drive and data, do not turn off the system or remove a diskette while the diskette drive busy lamp is lit.

Universal Serial Bus Port

The universal serial bus (USB) port on the front of the system allows you to easily and conveniently add plug and play USB devices without opening up the system. You simply plug the USB device into the port. You can connect up to 127 devices including a mouse, monitor, keyboard, printer, scanner, speakers, and more. A second USB port is on the rear of the system.

1-4 Reviewing System Features

CD-ROM Drive

Some models come with a 32X Max or 40X Max variable speed CD-ROM drive. Use the CD-ROM drive to load and start programs from a compact disc (CD). You can also use the CD-ROM drive to play your audio CDs.

The CD-ROM drive operates at different speeds depending on whether the CD you are using contains data or music. This allows you to get your data faster and to see smoother animation and video.

DVD-ROM Drive

Some models come with a 4X or 6X digital video disc (DVD)-ROM drive (Windows 98 systems only). The drive offers many improvements over the standard CD-ROM technology, including superior video and audio playback, faster data access, and greater storage capacities.

The DVD-ROM drive uses DVD technology to read DVD discs as well as standard audio and video CDs.

Tape Backup Unit

Some models come with a tape backup unit. If your system has a tape backup unit, you can use it to quickly back up all or part of your system's files to a high-capacity tape cartridge. Backup software helps you tailor the backup process to protect your files and applications. Files are compressed during the backup process to conserve space and to speed up the process.

Zip Drive

Some models come with a Zip[®] drive. Use the Zip drive to back up work, archive old files, and transport your work. Store up to 100 MB of data on a 3 1/2-inch Zip disk.

PC Card Adapter

If your model has a PC card adapter, you can add PC cards to the system. A PC card is inserted into a PC card slot similar to inserting a diskette in a diskette drive.

Each type of PC card has a different function. With your PC card adapter, you can add a number of functions to your system with a variety of PC cards.

LS-120 SuperDisk Drive

Some models come with an LS-120 MB SuperDisk[™] drive, in place of the 3 1/2-inch diskette drive. The drive offers high-capacity, removable data storage through use of SuperDisk diskettes that hold up to 120 MB of data. The SuperDisk drive is fully compatible with 1.44 MB diskettes and can read or write to the diskettes.

Rear Features

On the rear of your computer, you'll find external connectors, the power supply socket and voltage select switch, and expansion board slots. The following figure shows the features.

Rear features

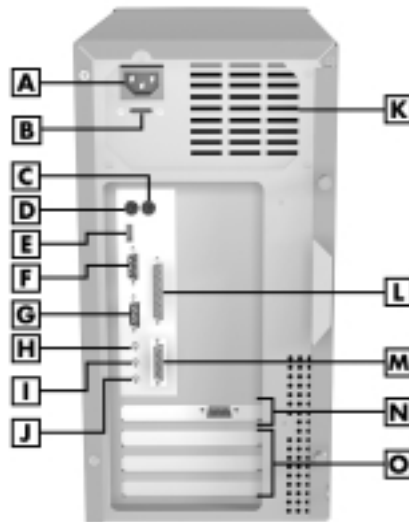

- | | |
|------------------------------------|----------------------------------|
| A – Power Socket | I – Line In Jack |
| B – Voltage Selector Switch | J – Microphone In Jack |
| C – Mouse Port | K – Fan |
| D – Keyboard Port | L – Printer Port |
| E – USB Port | M – MIDI Port |
| F – Serial Port 1 | N – VGA Monitor Connector |
| G – Serial Port 2 | O – Expansion Slots |
| H – Line Out Jack | |

External Connectors

External connectors let you attach peripheral devices, such as a monitor, keyboard, mouse, and printer to your system. Your system has the following external connectors.

- **Mouse port**
Attach the mouse that comes with your computer to this port. The mouse port supports a PS/2-compatible mouse.
- **Keyboard port**
Attach the keyboard that comes with your computer to the keyboard port.

The keyboard port supports a PS/2[®]-compatible (personal system/2-compatible) 101-key or 104-key keyboard (in the U.S. and Canada) or a 102-key keyboard (in the United Kingdom and Germany) with a 6-pin mini DIN connector.
- **VGA monitor connector**
The system comes with an accelerated graphics port (AGP) graphics board. The external video graphics array (VGA) connector on the AGP board supports an NEC MultiSync[®] monitor, NEC VistaScan[™] monitor, or other VGA-compatible monitor with a 15-pin connector. Attach the signal cable from your monitor to the VGA connector.
- **Printer port**
Use this port to connect a parallel printer with a 25-pin connector to the system.
- **Serial ports 1 and 2 (COM1 and COM2)**
Attach a serial device with a 9-pin connector to these serial ports. Serial devices include a pointing device, serial printer, or a modem.
- **Universal Serial Bus port**
This port adds a USB connector at the rear of the system (see “Universal Serial Bus Port” earlier in this chapter).

1-8 Reviewing System Features

- **Audio connectors**

The following connectors come integrated on the system board (see the preceding figure for jack locations).

- **Microphone in jack**

The microphone in jack lets you connect a microphone for recording audio information in your data system files.

- **Line in jack**

The line in jack lets you connect a stereo audio device such as a stereo amplifier or a cassette or minidisc player for playback or recording.

- **Line out jack**

The line out jack allows you to connect an amplified output device, such as powered speakers or headset, a stereo tape recorder, or an external amplifier for audio output.

- **MIDI/Joystick connector**

The MIDI/Joystick connector lets you attach a joystick to your system for use with games.

- **Fax/modem ports**

Some models come with a V.90 rated 56-kilobytes per second (Kbps) fax/modem board. The fax/modem board allows the connection of a phone line to the computer for fax and data communications functions.

Dual fax/modem ports let you use a telephone line for the fax/modem and your telephone.

- **LAN connector**

Some models come with a network board. Use the RJ-45 compatible port on the board for connecting the system to an Ethernet local-area network (LAN).

Power Supply Features

Your system has the following power supply features:

- Power socket
Connect your power cable to this socket.
- Voltage selector switch
Sets the voltage for your system to 115 volts or 220 volts.



CAUTION

Set the switch correctly for the voltage in your area. Most wall outlets in the United States and Canada are 115 volts. Outlets in Europe, Australia, and Asia (except Taiwan) are 230 volts. Taiwan uses 115-volt outlets.

- Power supply fan
The power supply fan cools the power supply and other system components to keep them from overheating. Keep the area near the fan clear for proper ventilation.

Inside Features

See the following figure for the location of features within the system. Feature descriptions follow.

Inside the system

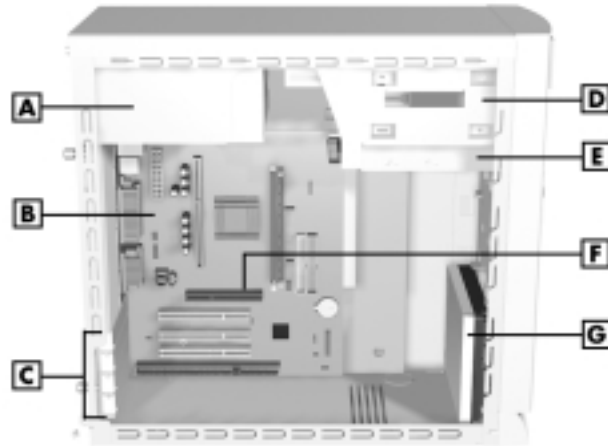

- | | |
|-----------------------------------|--------------------------------|
| A – Power Supply | E – Diskette Drive |
| B – System Board | F – AGP Board Connector |
| C – Expansion Slots | G – Hard Drive |
| D – Accessible Device Bays | |

System Board

The system processor, memory, audio subsystem, system battery, internal connectors, and external connectors are on the system board. For information on the external connectors, see “External Connectors” earlier in this chapter.

The system board supports a diskette drive and up to four IDE devices such as IDE hard drives, IDE CD-ROM drive, IDE DVD-ROM drive, and IDE Zip drive.

Internal connectors on the system board include:

- primary and secondary IDE connectors
- diskette drive connector
- front panel connectors for lamp, USB, and audio signals

-
- power connectors
 - AGP graphics board connector
 - three PCI connectors
 - one ISA connector
 - additional connectors include the CD Audio In, Modem In, Wake-On LAN, and fan.

Network Board

Some models come with a 3Com® 10/100Base-T Ethernet network board, an Intel® EtherExpress® Pro100 +10/100 Ethernet network board, or a GVC D110G 10/100 network board installed in a PCI slot.

Modem Board

Some models come with a Robotics® 56K Python V.90 ISA modem board or a Lucent V.90 Winmodem PCI board. Connect your telephone line to this board.

Storage Device Support

Five storage device bays accommodate up to three accessible devices and two internal hard drives.

Chassis

The NEC micro tower chassis conforms to the Intel ATX form factor specification. The chassis features the following:

- standardized chassis size and dimensions
- standardized system board size and dimensions
- standardized ATX 145 watt power supply.

1-12 Reviewing System Features

Speakers

If ordered, some systems come with two high-quality stereo speakers. One of the speakers connects to the line out jack at the rear of the system unit.

An AC adapter comes with the speakers. Install the AC adapter along with the speakers.

Adjust the speaker volume by using the volume control on the front of the system or on the right speaker. You can also use the Windows sound software. To bring up the Windows volume control, double click the speaker icon on the taskbar (next to the system clock). Use the software to balance the sound between the left and right speakers.

System Features

Your computer hardware and software deliver the performance and technologies you need for all your challenging tasks today and into the future.

Hardware

The PowerMate VT 300 Series includes the following hardware features:

- **PC98 Compliance**
All the hardware in the system has been certified by Microsoft® to be PC98 compliant.
- **Processor**
The system comes with a Celeron® processor, Pentium® II processor, or Pentium III processor. Processor speed depends on system model. The processors are fast, powerful processors that lend themselves to computational, graphical, and networking tasks.

-
- **Audio on the System Board**
The system board comes with an audio subsystem. The audio chipset gives you a surround sound system for three-dimensional sound effects — much like a live performance. It also provides wavetable synthesis. (Wavetable synthesis uses actual recordings of real sound effects and musical instruments for a dynamic audio experience.)
 - **Flashable ROM BIOS**
The system's ROM BIOS features system setup configuration, Plug and Play support, and flash support for easy and economical BIOS upgrades.
 - **System Memory**
Your computer comes with at least 32 MB of non-ECC synchronous dynamic random access memory (SDRAM) and supports up to 512 MB.
 - **AGP Graphics Board**
All models ship with an AGP graphics board. AGP enhances graphics performance, particularly for 3-D applications.
 - **Power Management Options**
Power management options conserve energy and reduce power costs.

Software

NEC CSD provides a variety of applications and hardware utilities with your system to let you take advantage of your hardware capabilities.

Preloaded Operating System

The Microsoft® Windows NT®, Windows® 95, or Windows 98 operating system comes loaded on your system.

1-14 Reviewing System Features

NEC OS Restore CD

In the event of operating system problems, you can restore your operating system using the NEC OS Restore CD. The NEC OS Restore Program on the CD provides a "Fix OS" Restore option for reinstalling the Windows 95 or Windows 98 operating system while leaving data files intact. This feature lets you back up your data files before performing a complete restore of the operating system.

The OS Restore program also provides options for reformatting and repartitioning the hard drive. In addition, the program automatically determines which drivers are needed for your original hardware configuration and installs them during the restore.

NEC Application and Driver CD

Your system comes with an NEC Application and Driver CD. Use this CD to install any or all of the software that comes with your system, including:

- Microsoft® Internet Explorer
Internet Explorer provides a top-notch browser with preloaded links for easy access to the world wide web. Also use Internet Explorer to access one of the many new browser-based utilities.
- Netscape® Browser
Netscape provides a top-notch browser with preloaded links for easy access to the world wide web. Also use Netscape to access one of the many new browser-based utilities.

-
- Adobe® Acrobat® Reader
Use the Adobe Acrobat Reader to read and print portable document format (PDF) files found on the Internet and PDF documents included with various software applications.
 - Network™ Associates VirusScan® Software
Protect the system from viruses by running VirusScan.
 - PartitionMagic™
Repartition your hard drive while leaving your data intact with PartitionMagic. Includes BootMagic™ software for easily managing multiple operating systems.
 - NEC Help Center
The NEC Help Center is an online guide with information about the PowerMate system.
 - Healthy Environment
This is an online version of the printed brochure, *Setting up a Healthy Environment*.

The NEC Application and Driver CD also contains a wide selection of drivers for hardware that is compatible with PowerMate series computers. These drivers are provided with the original manufacturer's installation wizards to ensure correct installation.

Security

The system has hardware, software, and mechanical security features that offer protection against unauthorized access to your system and data. The following security features are available with the system.

- Password security
The BIOS Setup utility includes a feature that lets you set up either a user or supervisor password, or both.

1-16 Reviewing System Features

The user password controls booting of the system and controls access to the Setup utility and the keyboard. (User access to the BIOS Setup utility is limited to a subset of all BIOS Setup parameters when a supervisor password has been set.)

The supervisor password allows full access to the system and the BIOS.

- Windows network security features

To learn more about the network security features available through the Windows operating system, refer to your Windows documentation or consult your system administrator.

- Locking tab

The system also has a locking tab on the rear of the chassis. The tab fits through a slot on the rear edge of the chassis cover when the cover is on. When a padlock is used in the tab, the system is physically protected from chassis intrusion.

2

Setting Up the System

- Cable Connections
- Startup
- Shutdown
- Power-Saving Operation
- System Care
- More Information

This chapter provides the information you need to set up and use your system. This includes cable connections, system startup procedures, system shutdown procedures, and system care. The chapter also includes a matrix showing where to find additional information about the computer.

Cable Connections

After unpacking the system and positioning the system unit in your work area, connect the system components using your Quick Setup poster and the following tips.

- Use the icons on the rear of the system unit to identify the keyboard, mouse, printer, USB, and monitor connectors.
- If the system comes with a fax/modem board, connect it to the telephone line as follows:
 - Unplug the telephone from the telephone jack on the wall.
 - Plug the telephone cable that comes with the system into the line jack on the rear of the system and into the telephone jack on the wall.
 - Plug the cable on the telephone into the phone jack on the rear of the system.
- If your system comes with the network board option, see your network administrator for guidelines on configuring the system for network access.

-
- Set the voltage switch correctly for your area. The correct setting for the U.S. and Canada is 115V.

 **WARNING**

Set the voltage switch correctly for your area.

- Connect system power cables to a surge protector (recommended) or a properly grounded wall outlet.

 **CAUTION**

NEC CSD recommends connecting the power cable to a surge protector.

Startup

Press the power button to start up your system. The power lamp lights green to indicate that the system is on. The system performs its Power-On Self-Test (POST) and several messages appear indicating that your system is checking its subsystems. To see the messages, press **Tab** during POST.

At the bottom of the NEC startup screen, the following message appears:

Press F2 to enter BIOS Setup

If you want to enter the BIOS Setup, immediately press **F2** while the startup screen displays.

One beep indicates that the system has successfully completed the power-on test. After a short delay, Windows starts up.

If a problem occurs, a series of beeps may sound. If this happens repeatedly after powering on, power off the system and turn to Chapter 5, "Solving System Problems." The chapter provides helpful hints for solving system problems.

 **Note:** If the system displays a message indicating that system settings have changed, run the BIOS Setup utility (see Chapter 3, "Configuring the System").

On systems loaded with the Windows NT[®] 4.0 operating system, press **Ctrl Alt Del** when prompted on-screen to do so. The log-on box appears for entering a password.

Shutdown

Follow these steps to power off your computer.

1. Save your work and exit all open application programs.
2. Make sure that the hard drive, diskette drive, and any other drives are not in use. A lit device lamp indicates that the device is in use.



CAUTION

Wait until a program is finished running before powering off the system.

Unless absolutely necessary, never power off the system when the system power lamp is amber or when either the hard drive lamp, diskette drive, or other device lamp is lit. Information on the device might be lost or damaged.

-
3. Click **Start** on the taskbar, then point to and click **Shut Down**. Selecting **Shut Down** gives you several choices in the pop-up submenu. Select **Shut down the computer**, then click **Yes** or press **Enter** for shut down.
 4. If your system is configured with Windows 98, the system shuts down automatically after a short interval.

 **Note:** You can also power off the system by pressing the power button and holding it in for several seconds before releasing. The system powers off after a short delay.

5. If your system is configured with Windows 95 or Windows NT, shut down the system by pressing and holding in the power button for several seconds before releasing.
6. Turn off power to your monitor.

Power-Saving Operation

If the system is running Windows 95 or Windows 98, you can put it in Sleep mode (a power-saving state) by lightly pressing and immediately releasing the power button on the front of your unit. The Sleep mode is a convenient way of conserving energy when you are going to be away from your system for a short period of time.

The system also goes into Sleep mode when it has been inactive, if the power management has been enabled in BIOS, and an inactivity timeout has been enabled. (See Chapter 3, “Configuring Your System” for information on setting power management functions.)



CAUTION

Take care to lightly press and immediately release the power button to enter the Sleep mode. Avoid pressing and holding in the power button or you may turn off power and lose data.

When the system goes into Sleep mode, it saves data and system status and then shuts off power to all possible components. Sleep mode lets you save power without first saving your work.

An amber power lamp indicates that the system is in Sleep mode. Press a key or move the mouse to resume system operation where you left off.

System Care

Your system is a durable, dependable computer built for heavy use. With protective measures and proper care, you can prevent problems and promote the successful operation and long life span of your computer.

Protecting Your System From Damage

There are several ways that you can protect your system from possible damage. NEC CSD strongly recommends the following protective measures.

- Connect a surge suppressor between your computer and a grounded wall outlet. A surge suppressor protects your system from sudden transient increases and decreases in electrical power.

Be sure to connect all peripherals, such as your monitor and printer, to the surge suppressor. The surge protector should be the only device that you plug into the wall outlet.

- Avoid repeated power-on cycles. These subject the system components to temperature variations and stress.
- Disconnect your system from telephone and power lines when an electrical storm threatens. If you have a fax/modem, lightning can travel in on the phone line and damage both the fax/modem and the system unit. Lightning can also travel in on power lines and damage your monitor and system unit.
- Be sure that system power is off before you connect or disconnect a cable. Never make cable changes when the system power is on. Doing so can damage the system and its peripherals.
- Use BIOS Setup utility options to protect against viruses (see “Security Menu” in Chapter 3). Use appropriate virus detection software regularly to protect your system from computer viruses.

If you plan to use software programs other than NEC CSD supplied software, NEC CSD strongly recommends that you take the necessary steps, such as virus checks, to protect your system.

- Position your computer away from direct sunlight and extreme hot and cold temperatures.

The recommended operating environment is from 50°F to 95°F (10°C to 35°C).

The recommended non-operating environment (shipping or storage) is from 14°F to 158°F (-10°C to 70°C).

-
- After turning off power, wait about five seconds for the hard drive to spin down before you power on again.
 - Be sure that nothing is placed on top of your system power cables.
 - Prevent dust from entering your system by covering it when it is not in use.

Keeping Your System in Good Condition

Maintain the condition of your system by periodically using the following procedures.

WARNING

For safety, power off and unplug your system, monitor, and any external devices before cleaning them.

- Clean the outside of the computer with a soft clean cloth.
You can remove stubborn stains with a cloth slightly dampened with a mild detergent. Never use a strong cleaner or solvent on any part of the system.
- Keep food and liquids away from your computer.
- Periodically clean the keyboard with a vacuum cleaner brush attachment. Do not use any liquid cleaners on the keyboard as they can damage the keyboard.
If an object, such as a paper clip, falls into the keyboard, turn the keyboard over and gently shake it.
- Clean the monitor screen with a glass cleaner and wipe it with a clean, lint-free cloth. You may use wet/dry cleaning pads manufactured for monitor screens.

2-8 Setting Up the System

Moving or Shipping Your System

Use these steps to prepare your system for moving or shipping.

- 1.** Back up the files on the hard drive to diskettes, Zip disks, tape cartridges, or other backup devices.

Take precautions for storing and transporting Zip disks, diskettes, or tape cartridges so that they are not exposed to magnetic fields or electrical impulses.

- 2.** Remove any diskette from the diskette drive. If you have a CD in the CD-ROM drive, remove the CD.
- 3.** Turn off the system unit and any external options connected to it.
- 4.** Unplug the system unit power cable from the wall outlet or surge suppressor, then from the unit itself.
- 5.** Unplug any external options from the wall outlets or surge suppressor, then disconnect them from the system unit.
- 6.** Pack the system components in the original shipping materials and cartons. If these are not available, be sure to use adequate packing materials to protect the components.

To set up your system, follow the steps on the *PowerMate VT 300i Series Quick Setup* poster that comes with the computer.

More Information

Once you have your system up and running, we suggest that you do the following:

- Install applications provided by NEC CSD on the NEC Application and Driver CD.
- See “Setting Up a Healthy Work Environment” in Appendix A.
- Install any of your own applications. See the documentation that comes with the application.

See the following quick reference chart to find information about using the computer.

Quick Reference to Information About the Computer

| Information | Where to Find It |
|---|---|
| Installing the applications provided by NEC CSD | “Installing Applications” in Chapter 3 |
| Installing the NEC Help Center online documentation | “Installing the NEC Help Center” in Chapter 3 |
| Uninstalling the NEC Help Center | “Uninstalling the NEC Help Center” in Chapter 3 |
| Setting a password | Chapter 3 |
| Adding options | Chapter 4 |
| Accessing the world wide web | Chapter 6 |
| Protecting the system from viruses | Chapter 1 |
| Using support services | Chapter 6 |
| Taking care of the system | “System Care” in Chapter 2 |
| Troubleshooting tips | Chapter 5 |

2-10 Setting Up the System

3

Configuring the System

- Configuration Tools and Utilities
- BIOS Setup Utility
- Flash Utility
- NEC OS Restore CD
- NEC Application and Driver CD
- NEC Help Center
- Resolutions for NEC VistaScan USB Monitors
- System Board Jumper Settings

This chapter provides information on configuring your computer. The chapter includes information on the

- American Megatrends, Inc. (AMI) BIOS Setup utility for configuring hardware and the system
- Flash utility for BIOS updates
- NEC OS Restore CD for rebuilding the hard drive and/or restoring the operating system
- NEC Applications and Driver CD for installing the NEC supplied applications and optional drivers
- jumper settings for physically configuring devices in the system.

See the following table for a quick guide to the utilities, tools, or procedures required in configuring the system. For detailed information about these and other tools, see the sections following the table.

Configuration Tools and Utilities

The following table lists ways you can configure the system, and the utility, tool, or procedure to use for the configuration.

Configuration Tools and Utilities

| Configuration | Method, Tool, or Utility |
|---|---|
| BIOS, updating | FLASH utility |
| Boot devices, determining | BIOS Setup (Advanced menu) |
| Boot order, changing | BIOS Setup (Advanced menu) |
| Clearing CMOS and password | Jumper Settings |
| Configuring processor jumpers on system board | Jumper Settings |
| DIMM memory, checking | BIOS Setup (Main menu) |
| Diskette drive, enabling | BIOS Setup (Main menu) |
| Drivers for NEC CSD hardware, installing | NEC Application and Driver CD |
| Hard drive, reformatting | NEC OS Restore CD |
| Hard drive, repartitioning | NEC OS Restore CD |
| Hard drive, setting a pre-delay | BIOS Setup (Advanced menu) |
| Hard drive, subjecting to power management | BIOS Setup (Advanced menu) |
| Healthy Environment (online document), installing | NEC Application and Driver CD |
| Inactivity timeout, setting | BIOS Setup (Advanced menu) |
| Keyboard options | BIOS Setup (Advanced menu) |
| Memory, checking | BIOS Setup (Main menu) |
| NEC Help Center, installing | NEC Application and Driver CD (see "Installing the NEC Help Center") |
| NEC Help Center, uninstalling | see "Uninstalling the NEC Help Center" |
| Operating system, restoring | NEC OS Restore CD |

Configuration Tools and Utilities

| Configuration | Method, Tool, or Utility |
|---|---|
| Parallel port, enabling, configuring | BIOS Setup (Advanced menu) |
| Password, setting or clearing (user, supervisor, or both) | BIOS Setup (Security menu) Jumper Settings |
| Plug and Play, enabling | BIOS Setup (Advanced menu) |
| Power management, enabling, configuring | BIOS Setup (Advanced menu) |
| Processor speed, changing | Jumpers |
| Serial ports, enabling | BIOS Setup (Advanced menu) |
| Software provided through NEC, installing | NEC Application and Driver CD |
| Sound, enabling | BIOS Setup (Advanced menu) |
| Time and date, setting | BIOS Setup (Main menu) |
| USB functions | BIOS Setup (Advanced menu) |
| Video device, subjecting to power management | BIOS Setup (Advanced menu) |
| Windows 95, Windows 98, or Windows NT, restoring | NEC OS Restore CD |

3-4 Configuring the System

BIOS Setup Utility

The AMI BIOS Setup utility program is used to configure the main components of your computer.

Your system ships from the factory with the correct system parameters for your configuration. Unless you add optional hardware, you do not need to run the BIOS Setup utility to operate your system. However, you might wish to run the Setup utility to set features that customize your system, such as security features.

System configuration information is stored in nonvolatile memory. A nonvolatile memory device retains its data when system power is turned off. Nonvolatile memory in your system is stored in a complementary metal-oxide semiconductor (CMOS) memory chip backed up by a battery on the system board. The battery supplies continuous power to CMOS memory and maintains configuration information when system power is off (see “Battery Replacement” in Chapter 5).

NEC CSD recommends that you print out or write down your current BIOS Setup parameters and store the information in a safe place. This lets you restore your system to the current parameters if you ever need to replace the battery.

How to Start BIOS Setup

To start the BIOS Setup utility, follow these steps.

1. Turn on or reboot the system.
2. Press **F2** as soon as you see the following message at the bottom of the NEC startup screen.

Press F2 to enter BIOS Setup

You have about five seconds to press **F2** before the system boot continues.

3. Setup's Main Menu appears and looks similar to the following.

Setup Main Menu

| Main Menu | |
|----------------------|------------------------|
| Main | Advanced Security Exit |
| BIOS Version | V1.xxxx |
| Processor Type | Pentium |
| Processor Speed | 450 MHz |
| Cache RAM | 512 KB |
| Total Memory | 32 Mb |
| DRAM Bank 0 | SDRAM |
| DRAM Bank 1 | None |
| System Date | Wed Aug 11 1999 |
| System Time | 10:17:59 |
| Floppy Drive A | 1.44 MB 3 1/2 |
| Floppy Drive B | Not Installed |
| Primary IDE Master | Auto |
| Primary IDE Slave | Auto |
| Secondary IDE Master | Auto |
| Secondary IDE Slave | Auto |
| ◀◀ Setup Help ▶▶ | |
| Month: Jan-Dec | |
| Day: 01-31 | |
| Year: 1901-2099 | |
| ↑ Previous Item | |
| ↓ Next Item | |
| ↔ Select Menu | |
| Esc: Exit | Enter: Select |
| F5: Setup Defaults | F6: Original Values |
| F10: Save & Exit | |

3-6 Configuring the System

How to Use BIOS Setup

Use the keys shown on the bottom of the Main Menu to make your selections or exit the current menu. The following table describes the navigation keys.

Navigation Keys

| Key | Function |
|--------------------------|---|
| Esc | Exits the menu. |
| Enter | Executes Command or brings up a submenu. |
| F5 | Loads the Default Configuration values for this menu. |
| F6 | Selects the Original Values for the field. |
| F10 | Saves changes and Exits the BIOS Setup utility. |
| Up or down arrow keys | Moves cursor up and down in the menu. |
| Left or right arrow keys | Selects next menu. |

Help Setup information displays on the right side of the Setup screen.

Main Menu

The BIOS Setup utility usually comes up displaying the Main Menu. If BIOS is displaying another menu, choose the Main Menu by selecting Main in the legend bar.

See “How to Start BIOS Setup” for a look at a typical Main Menu screen.

Main Menu options are available by selecting submenus. Use the arrow keys to select a Main Menu option. Press **Enter** to display the submenu. Explanations of typical Main Menu options and suboptions appear in the following tables. Actual explanations and settings may vary between systems.

Main Menu Items

| Menu Item | Settings (default is bold) |
|----------------------------|--|
| BIOS Version | This field is read-only and cannot be changed from the BIOS Setup utility. Example: V1.001 |
| Processor Type | This field is read-only and cannot be changed from the BIOS Setup utility. Example: Celeron |
| Processor Speed | This field is read-only and cannot be changed from the BIOS Setup utility. Example: 433 MHz |
| Cache RAM | This field is read-only and cannot be changed from the BIOS Setup utility. Example: 128 KB |
| Total Memory | This field is read-only and cannot be changed from the BIOS Setup utility. Example: 32 MB |
| DRAM Bank 0 DRAM Bank 1 | These fields are read-only and cannot be changed from the BIOS Setup utility. Example: DRAM Bank 0 32 MB SDRAM DRAM Bank 1 None |
| System Date | Set system date in this field. Press Tab or Enter to move between month, date, and year fields. Example: Aug 10 1999 |

3-8 Configuring the System

Main Menu Items

| Menu Item | Settings (default is bold) |
|--|--|
| System Time | Set system time in this field. Press Tab or Enter to move between hour, minute, and second fields. Example: 09:30:00 |
| Floppy Drive A: | Disabled 360 KB 5 1/4" 1.2 MB 5 1/4" 720 KB 3 1/2" 1.44/1.25 MB 3 1/2" 2.88 MB 3 1/2" |
| Floppy Drive B | Not Installed |
| Primary IDE Master Primary IDE Slave Secondary IDE Master Secondary IDE Slave | Device type, Auto Device type, Auto Device type, Auto Device type, Auto Each device menu item displays the Hard drive or CD-ROM identifier if a device is installed. If you install a hard drive that does not feature auto IDE type detection or your IDE hard drive was formatted on another system with parameters different from those reported by the drive, enter a parameter for each of the fields in the device submenu. Bring up a device submenu by pressing Enter . The submenus include Type, Cylinders, Heads, Sectors, LBA Mode, Block Mode, Fast Programmed I/O Modes, and 32-Bit Transfer Mode. Each mode is briefly described in the following. |

Main Menu Items

| Menu Item | Settings (default is bold) |
|-----------------------|---|
| Type | None, CD-ROM, IDE Removable, User, ATAPI Removable, Auto Defaults to Disabled and changes at boot time based on auto-detection. When set to Auto, the values for Cylinders, Heads, Sectors, and Maximum Capacity are displayed but are read only. When set to Auto, the BIOS detects what the drive is capable of, not the translation mechanism that was used to format the drive. If a drive is run in a mode other than the mode in which it was partitioned and formatted, unpredictable results may occur, including data loss. |
| Cylinders | When Type is Auto, value in the Cylinders field is auto-detected and field is read only. |
| Write Precompensation | When Type is Auto, value in Write Precompensation field is auto-detected and field is read only. |
| Heads | When Type is Auto, value in Heads field is auto-detected and field is read only. |
| Sectors | When Type is Auto, value in Sectors field is auto-detected and field is read only. |
| Maximum Capacity | xxxx MB |
| LBA Mode | On , Off When On is selected, it causes logical block addressing to be used in place of cylinders, heads, and sectors. When Type is set to Auto, the value in the LBA Mode field is auto-detected and the field is read only. |

3-10 Configuring the System

Main Menu Items

| Menu Item | Settings (default is bold) |
|---------------------------|--|
| Block Mode | On , Off When On is selected, it allows block mode data transfers. When Type is set to Auto, the value in the Block Mode field is auto-detected and the field is read only. |
| Fast Programmed I/O Modes | Auto, 1, 2, 3, 4 , 5. Sets the Advanced PIO mode. |
| 32 Bit Transfer Mode | ON , Off When On, allows 32 bit data transfers. |

Advanced Menu

The Advanced Menu is a top-level menu in the BIOS Setup utility. Choose the Advanced Menu by selecting Advanced in the legend bar.

Advanced Menu options are available by selecting submenus. Use the arrow keys to select an Advanced Menu option. Press **Enter** to display the submenu. Settings of the Advanced Menu options and suboptions are given in the following tables.



CAUTION

Setting items on this menu to incorrect values can cause your system to malfunction.

Advanced Menu - Advanced CMOS Setup

| Menu Item | Settings (default is bold) |
|-----------------------------|--|
| Event Log Capacity | Status only. Press Enter to view. |
| Event Log Validity | Status only. Press Enter to view. |
| View DMI Event Log | Status only. Press Enter to view. |
| Clear all DMI Events Logs | No , Yes Selecting No prevents clearing out the DMI events logs. |
| Event Logging | Enabled , Disabled Selecting Enabled permits event logging. |
| ECC Event Logging | Enabled , Disabled Selecting Enabled permits ECC event logging. |
| Quick Boot | Enabled , Disabled When Enabled, the BIOS does not test system memory above 1 MB or wait for ready signals, allowing a quick boot. |
| 1 st Boot Device | Disabled, IDE-0 , IDE-1, IDE-2, IDE-3, Floppy, LS-120, ATAPI Zip, CDROM, SCSI, Network Sets the hard drive as the first boot device. |
| 2 nd Boot Device | Disabled, IDE-0, IDE-1, IDE-2, IDE-3, Floppy, LS-120, ATAPI Zip, CDROM , SCSI, Network Sets the CD-ROM drive as the second boot device. |
| 3 rd Boot Device | Disabled, IDE-0, IDE-1, IDE-2, IDE-3, Floppy , LS-120, ATAPI Zip, CDROM, SCSI, Network Sets the diskette drive as the third boot device. |

3-12 Configuring the System

Advanced Menu - Advanced CMOS Setup

| Menu Item | Settings (default is bold) |
|---------------------------|---|
| Quiet Boot | Enabled , Disabled When Enabled, displays the NEC splash screen, with settings for displaying POST or entering BIOS setup. |
| S.M.A.R.T. for Hard Disks | Disabled , Enabled Select Enabled to use the Self Monitoring Analysis and Reporting Technology (S.M.A.R.T.) for reporting server system information over a network. |
| PS/2 Mouse Support | Enabled , Disabled Select Enabled to allow use of a PS/2 mouse. |
| CPU Serial Number | Disabled , Enabled |

Advanced Menu - Advanced Chipset Setup

| Menu Item | Settings (default is bold) |
|--------------------------------|---|
| Graphics Aperture Size | 4 MB, 8 MB, 16 MB, 32 MB, 64 MB , 128 MB, 256 MB Determines the effective size of the graphics aperture used in the particular PAC configuration. |
| USB Keybd/Mouse Legacy Support | Disabled, Enabled Select Enabled to enable the BIOS USB functions for legacy keyboards and mice. |

Advanced Menu - Power Management Setup

| Menu Item | Settings (default is bold) |
|----------------------------|--|
| Power Management/APM | Enabled , Disabled The Enabled setting enables Power Management and Advanced Power Management (APM). |
| Video Power Down Mode | Disabled, Standby, Suspend Specifies the power conserving state that the VESA VGA video subsystem enters after a specified period of display inactivity has expired. |
| Hard Disk Power Down Mode | Disabled, Standby , Suspend Specifies the power conserving state that the hard disk drive enters after a specified period of inactivity has expired. |
| Standby Time Out (Minutes) | Disabled , 1, 2, 4, 8, 10, 20, 30, 40, 50, 60 Specifies the length of time of system inactivity while in full power on state before entering Standby state. |
| Suspend Time Out (Minutes) | Disabled , 1, 2, 4, 8, 10, 20, 30, 40, 50, 60 Specifies the length of time of system inactivity while in Standby state before entering Suspend power state. |
| Power Button Function | Sleep/Suspend Sleep/Suspend sets the power switch for Suspend (Sleep) mode. With power on, pressing the switch once places the system in sleep mode. Pressing and holding the switch in for 4 seconds turns power off. |

3-14 Configuring the System

Advanced Menu - Power Management Setup

| Menu Item | Settings (default is bold) |
|--------------------------------|--|
| Restore on AC/Power Loss | Stay Off , Power On, Last State The Power On setting turns power on after a power loss. Jumper JP1 must be set for Power On (see "Setting System Board Jumpers" for procedures on setting JP1). |
| Ring Resume from Soft Off | Disabled , Enabled The Disabled setting causes the system to ignore any incoming call from a modem. Enabled allows the system to boot up on an incoming telephone call. Not supported on Windows 98 systems. |
| LAN Resume from Soft Off | Disabled , Enabled The Disabled setting causes the system to ignore any incoming signal from the LAN network board. Enabled allows the system to boot up on an incoming LAN signal from the network board. |
| RTC Alarm Resume from Soft Off | Disabled , Enabled When Enabled, you can choose the time the system boots up (see the following time settings). |
| RTC Alarm Date | Sets the day that the system boots up (when RTC Alarm Resume is Enabled). |
| RTC Alarm Hour | Sets real time clock alarm hour (when RTC Alarm Resume is Enabled). |
| RTC Alarm Minute | Sets real time clock alarm minute (when RTC Alarm Resume is Enabled). |
| RTC Alarm Second | Sets real time clock alarm second (when RTC Alarm Resume is Enabled). |

Advanced Menu - PCI/Plug and Play Setup

| Menu Item | Settings (default is bold) |
|--------------------------|---|
| Plug and Play Aware O/S | No for Win NT, Yes for Win 9x Select Yes if the system's operating system is Plug and Play compliant. |
| Primary Graphics Adapter | PCI, AGP Select AGP if your graphics board is AGP. Select PCI if your graphics board is PCI. |
| PCI VGA Palette Snoop | Disabled , Enabled Set to Enabled if an ISA adapter board requires VGA palette snooping. |
| PCI IDE Bus Master | Disabled, Enabled Set to Enabled to specify that the IDE controller on the PCI local bus includes a bus mastering device. |

Advanced Menu - Peripheral Setup

| Menu Item | Settings (default is bold) |
|----------------------------|---|
| Onboard Sound Chip | Disabled, Enabled The Enabled setting allows use of onboard sound. |
| Onboard FDC | Auto , Disabled, Enabled Select Auto to automatically detect FDC devices. |
| Onboard Serial Port A | Auto, Disabled, 3F8h, 2F8h , 3E8h, eE8h |
| Onboard Serial Port B | Auto, Disabled , 3F8h, 2F8h, 3E8h, eE8h |
| IR I/O Pin Location Select | SINB/SOUTB , IRRX/IRTX |

3-16 Configuring the System

Advanced Menu - Peripheral Setup

| Menu Item | Settings (default is bold) |
|---------------------------|---|
| Serial Port B Mode | Normal , IrDA, ASK IR Selecting Normal sets the port for normal use, not for IR use. |
| IR Duplex Mode | N/A |
| IrDa Protocol | N/A |
| Onboard Parallel Port | Auto, Disabled, 378 , 3BC Select Auto to allow the BIOS to automatically assign the parallel port to an available parallel port IRQ. |
| Parallel Port Mode | Normal, Bi-Dir , EPP, ECP Use this mode to choose the operating mode of the onboard parallel port. |
| EPP Version | Use this setting (1.7 or 1.9) to select the EPP version. |
| Parallel Port IRQ | Parallel port 7 Setting depends on setting of Parallel Port Mode. If not set at auto, you can select the interrupt line for the onboard parallel port. |
| Parallel Port DMA Channel | This option allows you to choose DMA channel 1 to 3 for the onboard parallel port in ECP mode. |
| Onboard IDE | Disabled, Primary, Secondary, Both The Both setting enables both the primary and secondary IDE controllers. |
| Hard Disk Delay Time | Disabled, 3 sec., 6 sec. , 9 sec., 12 sec., 15 sec., 21 sec., 30 sec. The hard disk delay time gives the hard disk time to spin up before the system boots. |

Advanced Menu - Change Language Setting

| Menu Item | Settings (default is bold) |
|------------------|-----------------------------------|
| Language | English |

Security Menu

The Security Menu is a top-level menu in the BIOS Setup utility. Choose the Security Menu by selecting Security in the legend bar.

Security Menu options are available by selecting submenus. Use the arrow keys to select a Security Menu option. Press **Enter** to display the submenu. Settings of the Security Menu options and suboptions appear in the following table.

Security Menu Items

| Menu Item | Settings (default is bold) |
|-------------------------|--|
| Password Check | Setup , Always |
| Set Supervisor Password | [Enter] Use this field to set or change the supervisor password. Press Enter to bring up a dialog box where the password can be entered and confirmed. |
| Set User Password | [Enter] Use this field to set or change the user password. Press Enter to bring up a dialog box where the password can be entered and confirmed. |

3-18 Configuring the System

Exit Menu

The Exit Menu is a top-level menu in the BIOS Setup utility. Choose the Exit Menu by selecting Exit in the legend bar.

Exit Menu options are available by selecting submenus. Use the arrow keys to select an Exit Menu option. Press **Enter** to display the submenu. Explanations of the Exit Menu options and suboptions appear in the following table.

Exit Menu Items

| Menu Item | Settings (default is bold) |
|-------------------------|---|
| Exit Saving Changes | Implements the changes just made, and exits BIOS. |
| Exit Discarding Changes | Reverts to the settings from before the BIOS session. |
| Load Optimal Settings | Reverts to the factory set optimal settings. |
| Load Fail Safe Settings | Reverts to the factory set fail safe settings. |
| Load Original Values | Reverts to the factory-shipped settings. |

FLASH Utility

The system BIOS resides on a flash read only memory (ROM) chip in your system. The flash ROM can be updated using the following procedure. Before starting the BIOS update, NEC recommends that you first contact NEC CSD for assistance (see Chapter 6 for contact information).

Update the Flash ROM with a BIOS flash diskette. The diskette contains the latest version of the BIOS code. You can get the diskette from NEC CSD or download the BIOS from the NEC CSD website or Bulletin Board System (BBS). See Chapter 6 for download, website, and bulletin board system information.

Update the BIOS from the BIOS flash diskette as follows.

1. Write down the BIOS Setup parameters currently set on your system.
2. Turn off the system.
3. Put the flash diskette in drive A, and turn on the system.
4. When the flash upgrade menu appears, choose **Update Flash Memory Area from a file**.
5. When the menu asks you to enter a path/filename, use the arrow keys to select the “.bio” file and press **Enter**.
6. The utility asks for a confirmation that you want to load the new flash into memory. Select **Continue with Programming**.
7. After the upgrade completes, remove the diskette.
8. Reboot the system and start the Setup program. Press **F5** to reset the BIOS defaults. Use the recorded Setup selections you made at the beginning of this procedure to set the parameters.

NEC OS Restore CD

The following procedures describe how to use the NEC OS Restore CD that ships with your system.

Please read the following sections in their entirety before using the NEC OS Restore CD to restore the Windows operating system or factory-installed drivers on your system.

Introducing OS Restore Options

The NEC OS Restore CD contains the Windows 95, Windows 98, or Windows NT operating system and device drivers for the hardware that was factory-installed in your system. Use this CD to restore your system to its working state if a problem occurs that causes data loss or corruption.

After restoring the operating system, use the NEC Application and Driver CD to install your applications, optional drivers, and online documents.

 **Note:** Use the NEC Application and Driver CD to install or restore applications, optional drivers, and online documents (see “NEC Application and Driver CD” later in this chapter).

Choosing a Restore Program

The OS Restore program allows you to reinstall your Windows 95, Windows 98, or Windows NT operating system. You can perform the restore in the following ways:

- **Auto**, which reformats and repartitions the hard drive before restoring the Windows OS and factory-shipped drivers (see “Auto Rebuild and Restore”)

-
- **Custom**, which reformats the hard drive with the option to repartition before restoring the Windows OS and factory-shipped drivers (see “Custom Rebuild and Restore”)
 - **Fix OS**, a Restore option on the NEC OS Restore CD for Windows 95 and Windows 98 systems. The Fix OS restore option reinstalls the Windows operating system while leaving data files intact. It allows you to restore your system to the point where you can back up your data files. This option is intended as a precursor to a full format and restore (see “Fixing the Operating System”).

The operating system and factory-shipped drivers are always restored regardless of which program you choose.

See “NEC Application and Driver CD” for instructions on installing any of the applications or online documents, or to install device drivers that did not come with your system.

Launching the NEC OS Restore CD

Follow these steps to launch the NEC OS Restore CD.



CAUTION

The OS Restore program deletes all the data on your hard drive. If possible, back up your data before performing an OS restore.

1. Power on or restart the system and immediately insert the NEC OS Restore CD into the CD-ROM drive. The Operating System Restore Welcome screen appears (see the following figure).

Welcome screen



2. Click **Continue** to continue (or **Exit** to exit the program). A License Agreement screen appears with three options: Back, Reject, and Accept.
3. Read the license agreement and click **Accept** to continue. The Restore Mode screen appears with four options: Back, Auto, Custom, and Fix OS.

See one of the following sections to continue with the restore.

- “Auto Rebuild and Restore”
- “Custom Rebuild and Restore”
- “Fixing the Operating System”

Auto Rebuild and Restore

Follow these steps to reformat and repartition your hard drive.



CAUTION

The OS Restore program deletes all the data on your hard drive. If possible, back up your data before performing an OS restore.

1. Launch the NEC OS Restore CD and follow the prompts to get to the Restore Mode screen (see “Launching the OS Restore CD”).
2. Click **Auto** to repartition and reformat your hard drive.
 - If you are running Windows NT 4.0, skip to **step 4**.
 - If you are running Windows 95 or Windows 98, the Partition Information screen appears.
3. The Partition Information screen that appears in Windows 95 or Windows 98 has three options (Back, FAT 16, and FAT 32) and lets you select the File Allocation Table (FAT) type you want to use for the operating system restore:
 - Click **Back** to return to the Operating Mode screen.
 - Click **FAT 16** to select the FAT 16 allocation table (current FAT type).
 - Click **FAT 32** to select the FAT 32 allocation table (available for Windows 95 or Windows 98 systems only).

 **Note:** Some older software may not work in a Windows 95 or Windows 98 system configured for FAT 32. In addition, select FAT16 if a dual-boot system (with Windows 95 or Windows 98 and Windows NT 4.0) is desired.

4. A FAT 16 or FAT 32 Partition warning screen appears indicating that the system is about to partition and format your hard drive using the FDISK program. This warning screen contains three options: Back, Exit, and Continue.
5. Click **Continue**. The following take place:
 - system performs FDISK
 - system reboots
 - partitions are formatted
 - OS and drivers load from the CD

The “Operating System Restore Completed” screen appears when all files have been restored.

6. Remove the CD from the CD tray.
7. Click **OK** to reboot.

This completes the Auto Rebuild and Restore procedure.

See “NEC Application and Driver CD” for instructions on installing any of the applications or online documents, or to install device drivers that did not come with your system.

Restore any application or driver that was not provided by NEC by using the vendor diskette(s) or CD-ROM(s) included in its original packaging.

Custom Rebuild and Restore

Follow these steps to format your hard drive with choices on repartitioning the drive:

1. Launch the NEC OS Restore CD and follow the prompts to get to the Restore Mode screen (see “Launching the OS Restore CD”).
2. Click **Custom** to repartition and/or reformat your hard drive before reinstalling the operating system. After you click **Custom**, the integrity of your system’s existing FAT table is verified.
 - If the table is functional, a Partitioning the Hard Drive screen appears with options allowing you to retain the present partition structure or partition the hard disk using FAT16 or FAT32.
 - If the existing partition table is not functional, the system performs an “Auto” restore as described in “Auto Rebuild and Restore.”
3. If you want to partition and reformat the hard drive, go to **step 6**. Otherwise, click **Skip** to retain the present partition structure on the hard drive. The Format Mode screen appears with four options: Back, Quick, Full, and Exit.
 - Click **Back** to return to the Partition Information screen.
 - Click **Quick** to do a quick hard drive format.
 - Click **Full** to do a full hard drive format.
 - Click **Exit** to terminate the restore process.

-
4. After you select the type of hard drive format you want to do (Quick or Full), the Formatting Drive(s) screen appears with a status bar showing the progress of the formatting.

After the drive is reformatted, the Installing Applications screen appears, indicating the status as the operating system loads from the CD.

The drivers and other software components required for the operating system are also loaded from the CD.

After the OS finishes loading, the “Operating System Restore Completed” screen appears. Go to **step 6**.

5. To partition the hard drive, click **Continue** on the Partitioning the Hard Drive screen. The Partition Information screen appears in Windows 95 and Windows 98 systems. In Windows NT 4.0 systems, the FAT16 Partition warning appears as described in **step 7**.
6. The Partition Information screen has three options and lets you select the File Allocation Table (FAT) type you want to use for the operating system restore.
- Click **Back** to return to the Operating Mode screen.
 - Click **FAT 16** to select the FAT16 allocation table (current FAT type).
 - Click **FAT 32** to select the FAT32 allocation table (available for Windows 95 and Windows 98 systems only).

 **Note:** Some older software may not work in a Windows 95 or Windows 98 system configured for FAT 32.

 **Note:** In Windows NT 4.0 systems, the Partition Information screen does not appear. Instead, the FAT16 Partition warning appears. This screen is described in the following paragraph.

7. After you select the FAT type, a FAT 16 or FAT 32 Partition warning screen appears indicating that the system is about to partition and format your hard drive using the FDISK program. This warning screen contains three options: Back, Exit, and Continue.
8. Click **Continue**. The following takes place:
 - system performs FDISK using the FAT type selected
 - system reboots
 - partitions are formatted
 - OS and drivers load from the CD.The “Operating System Restore Completed” screen appears when all files have been restored.
9. Remove the CD from the CD tray.
10. Click **OK** to reboot.

This completes the Custom Rebuild and Restore procedure.

See “NEC Application and Driver CD” for instructions on installing any of the applications or online documents, or to install device drivers that did not come with your system.

Restore any application or driver that was not provided by NEC by using the vendor diskette(s) or CD-ROM(s) included in its original packaging.

Fixing the Operating System

Use the following procedure to restore the operating system to a state for retrieving and backing up data without repartitioning or reformatting the hard drive. Once all data is backed up, perform another NEC OS Restore using the **Auto** or **Custom** mode.



CAUTION

The Auto and Custom OS Restore programs delete all the data on your hard drive. If possible, back up your data before performing an OS restore with these options.

1. Launch the NEC OS Restore CD and follow the prompts to get to the Restore Mode screen (see “Launching the OS Restore CD”).
2. Click **Fix OS** to do a basic operating system restore. The Fix OS screen appears and displays two options (Back and Continue).
3. Click **Continue**. The Installing Applications screen appears, showing the status of the restore. It also displays the version of Windows OS being installed. The installation can take from 5 to 10 minutes.

 **Note:** The drivers and other software components required for the operating system are also loaded from the CD.

After the OS finishes loading, the “Operating System Restore Completed” screen appears.

-
4. Remove the CD from the CD tray.
 5. Click **OK** to reboot.

This completes the OS Restore (or “Fix OS”) procedure. The system is now in a state where data can be backed up. System settings previously located in the C:\WINDOWS directory are now in a backup directory C:\WINDOWS.ORG.



CAUTION

Some or all applications might not exhibit full functionality after the Fix OS is performed. To restore the system to its factory-installed state, perform another OS Restore using the **Auto** or **Custom** option.



CAUTION

Using the **Fix OS** option repetitively without using the **Auto** or **Custom** option afterward might cause unpredictable results.

To restore the system to its factory-installed state, perform another NEC OS Restore using the **Auto** or **Custom** option (see “Launching the OS Restore CD”).

NEC Application and Driver CD

Your system comes with an NEC Application and Driver CD. Use this CD to install any or all of the software that comes with your system, including

- applications
- utilities device drivers
- the NEC Help Center (online documentation)
- the Healthy Environment online brochure.

 **Note:** If you restore the operating system, the drivers that were factory-shipped are automatically installed.

Should a problem occur that causes data loss or corruption, you can restore these files to your computer using one of the programs on the CD.

Launching the Application and Driver CD

Use the Application and Driver CD to install applications, drivers, utilities, Internet browsers, and the online NEC Help Center.



CAUTION

Do not select and install drivers for any hardware that is not currently installed on the system. Doing so can damage the operating system.

In Windows, launch the Application and Driver CD by inserting the CD into the CD-ROM drive.

The Application and Driver Installation Utility dialog box appears. See “Installing Software” for further instructions.

Installing Software

The Application and Driver Installation Utility dialog box consists of the following components.

- **Selection Tabs** — Located just below the title bar, each tab represents a software category. The selection tabs include applications, drivers, utilities, Internet browsers, and the online NEC Help Center.
- **Description** — Located in the bottom portion of the dialog box, the text describes the selected or highlighted software category or application, driver, etc.
- **Install** — Clicking the Install button installs the selected software.
- **Exit** — Clicking the Exit button closes the Application and Driver Installation Utility dialog box.

Once the Application and Driver Installation Utility dialog box appears, follow these steps to install the desired software.

1. Click the selection tab of your choice.
2. Click the desired application, driver, or utility.



CAUTION

Do not select and install drivers for any hardware that is not currently installed on the system. Doing so can damage the operating system.

-
3. Click **Install** to install your selection. Follow the on-screen instructions to install your selection.
 4. Click **Exit** to close the Application and Driver Installation Utility dialog box.
 5. Remove the CD from the CD-ROM drive when the installation is complete.

NEC Help Center

NEC CSD provides an online NEC Help Center. The Help Center comes on the NEC Application and Driver CD. It's easy to install and it provides an overview to your computer.

To install the NEC Help Center, see the following section "Installing the NEC Help Center."

To uninstall the NEC Help Center, follow the instructions in "Uninstalling the NEC Help Center."

Installing the NEC Help Center

The installation of the NEC Help Center requires Microsoft Internet Explorer 4.01, 5.0, or higher. If Internet Explorer is not already installed on your system, install it from the NEC Application and Driver CD before you install the Help Center. Install the Help Center from the NEC Application and Driver CD.

 **Note:** The NEC Help Center is designed to work with Internet Explorer versions 4.01 **or higher**. Internet Explorer 5.0 comes preinstalled on systems with the Windows 98 operating system.

Follow the instructions in the previous section, “Installing Applications,” to install the NEC Help Center online documentation. The NEC Help Center is in the list of applications that appear when the NEC Application and Driver CD is started. Install it in the same manner as the applications and drivers in the list.

Uninstalling the NEC Help Center

To uninstall the NEC Help Center, use these steps.

1. Access the C:\Program Files\nechlpct directory.
2. Double click the **Unwise.exe** icon to remove all files related to the NEC Help Center and the **C:\Program Files\nechlpct** directory.

To reinstall the NEC Help Center, use the NEC Application and Driver CD and follow the instructions in “Installing the NEC Help Center.”

Resolutions for NEC VistaScan USB Monitors

The following table lists the supported resolutions for NEC PowerMate Series systems with 15-inch and 17-inch NEC VistaScan™ USB monitors.



CAUTION

Setting resolutions other than the rates listed in the following table generates a “black” monitor screen.

Resolutions for 15- and 17-Inch NEC VistaScan USB Monitors

| Mode | Resolution | Horizontal Frequency (KHz) | Vertical Frequency (Hz) |
|-------------|-------------------|-----------------------------------|--------------------------------|
| 1 | 720 x 400 | 31.47 | 70 |
| 2 | 640 x 480 | 31.47 | 60 |
| 3 | 800 x 600 | 35.16 | 56 |
| 4 | 1024 x 768 | 35.52 | 87 |
| 5 | 640 x 480 | 37.50 | 75 |
| 6 | 800 x 600 | 37.88 | 60 |
| 7 | 640 x 480 | 43.3 | 85 |
| 8 | 800 x 600 | 46.88 | 75 |
| 9 | 1024 x 768 | 48.36 | 60 |
| 10 | 800 x 600 | 53.67 | 85 |
| 11 | 1024 x 768 | 60.02 | 75 |
| 12 | 1280 x 1024 | 63.98 | 60 |
| 13 | 1024 x 768 | 68.68 | 85 |

System Board Jumper Settings

System board jumpers enable you to configure your system for a particular system requirement. Conditions that require changing jumper settings include the following.

- You are upgrading your processor. You must set jumpers on the system board for the CPU/Bus speed.
- You need to configure the system to power on when the power cord is plugged in instead of when the power button is pressed. You must set a jumper on the system board to enable this function.

-
- You forgot your password and need to clear it.
 - You need to restore the CMOS settings to the factory state.
 - Your BIOS is corrupted and you must perform a BIOS Recovery. This is performed with a BIOS Recovery diskette and is seldom required. If it is, contact NEC CSD Technical Support for assistance (see Section 6 for information on contacting Technical Support).

You can obtain the BIOS Recovery program by downloading it to a diskette from the NEC CSD Bulletin Board System (BBS), the NEC CSD File Transfer Protocol (FTP) site, or the NEC CSD website. See Chapter 6 for information on downloading.

The following figure shows system board jumpers.

Locating system board jumpers

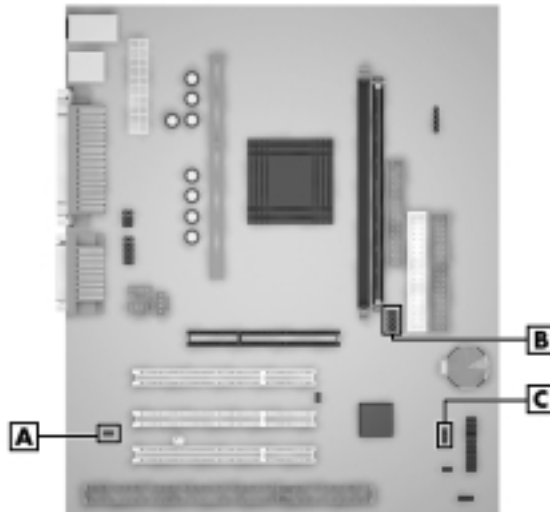

A – Power On Mode Jumper JP1
B – Processor/Bus Speed Jumpers SW1

C – Clear CMOS Jumper JBAT1

Processor Jumper Settings

To change the processor jumper settings on the system board, use the following steps. NEC CSD recommends using needle-nose pliers to move a jumper.



CAUTION

Jumpers are set correctly at the factory for your configuration. Only change (or check) the appropriate jumper setting if you are upgrading the processor. Otherwise, keep the jumpers at their factory settings.

1. Power off and unplug the system and any external options.
2. Remove the left side cover (see “Removing the Left Side Cover” in Chapter 4).



WARNING

System power must be off before changing a jumper setting.

3. Locate the processor/bus speed SW1 jumper block on the system board (see the figure “Locating system board jumpers” earlier in this chapter).
4. Move the jumpers according to the speed of the processor being installed and the settings shown on the following figure.

Processor Jumper Settings

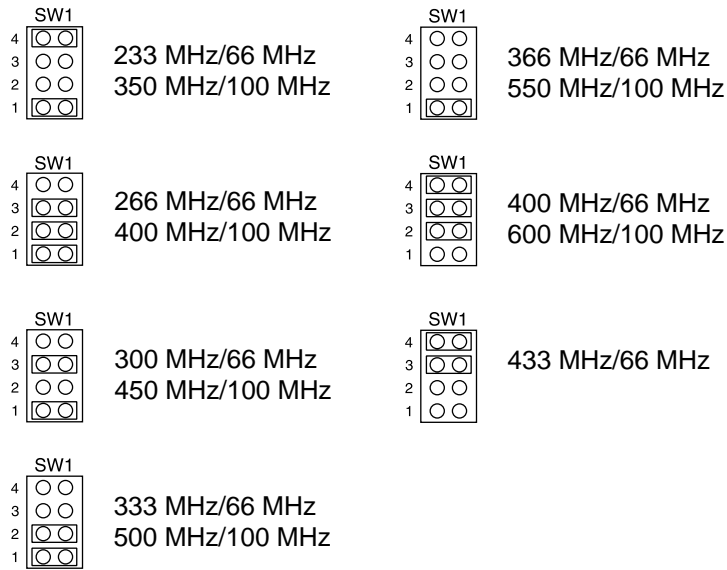

5. Replace the left side cover (see “Replacing the Left Side Cover” in Chapter 4).
6. Connect system power cables and external options.
7. Power on the system and run BIOS Setup utility to check the configuration of your system.

Clear CMOS/Password

If you need to clear your password or reset your CMOS settings to their factory state, set jumper block JBAT1 as follows.

**CAUTION**

Jumpers are set correctly at the factory for your configuration. Only change (or check) the appropriate jumper setting. Otherwise, keep the jumpers at their factory settings.

1. Power off and unplug the system and any external options.

**CAUTION**

To prevent damage to the system board, do not clear CMOS while power is on.

2. Remove the left side cover (see “Removing the Left Side Cover” in Chapter 4).
3. Locate jumper block JBAT1 on the system board (see the figure “Locating system board jumpers” earlier in this chapter).
4. Move the jumper from pins 1 and 2 to pins 2 and 3 to clear your password and reset the CMOS settings.
5. Move the jumper back to pins 1 and 2.
6. Replace the left side cover, plug in the power cord, and power up the system.
7. Run the BIOS Setup utility to check the configuration of your system.

Power On Mode

Your system can be jumpered to start up in one of the following two ways:

- when the power button is pressed
- when the power cord is connected (“Immediate Boot Up”).

To change the way your system starts up, change the jumper setting on jumper block JP1.

1. Power off the system and monitor and unplug any peripherals.

 **WARNING**

The system power must be off before removing the cover and changing a jumper setting.

2. Remove the left side cover (see “Removing the Left Side Cover” in Chapter 4).
3. Locate JP1 on the system board (see the figure “Locating system board jumpers” earlier in this chapter).
4. Set jumper JP1 as follows.
 - Set the jumper on pins 1 and 2 to allow system boot up when the power button is pressed.
 - Remove the jumper from pins 1 and 2 for immediate system boot up when the power cable is connected. To prevent loss of the jumper, “park” it on pin 1 only.

-
5. Replace the left side cover (see “Replacing the Left Side Cover” in Chapter 4). Connect system power cables and external options.
 6. Power on the system. Press **F2** to open the BIOS Setup utility.
 7. Set the BIOS for the power option you jumpered (see “Advanced Menu - Power Management Setup” in this chapter for the settings).

4

Installing Options

- General Rules
- Safety Precautions
- System Unit Covers
- System Board Options
- Expansion Boards
- Data Storage Devices

This chapter provides installation instructions for a variety of industry-standard and NEC CSD expansion options that you can add to your system.

Included in the chapter are procedures for

- memory module upgrade
- processor upgrade
- expansion board installation
- AGP board installation
- data storage device installation.

Most procedures require removal of the system's left side cover. Some procedures require removing the right side cover and the front panel. Procedures for removing the covers and front panel are included in this chapter.

General Rules

Follow these general rules when installing system options.

- Turn off system power and unplug the power cable.
- Turn off and disconnect all peripherals from the front or rear of the system.
- When handling boards or chips, touch the system metal frame to discharge static.
- Do not disassemble parts other than those specified in the procedure.
- All screws are Phillips-head unless otherwise specified.
- Label any cable connectors before disconnecting. Note where the connector goes and in what position it was installed.

4-2 Installing Options

Safety Precautions

Observe safety rules when working inside the system and when handling computer components. Avoid electric shock or personal injury by observing the following warning.

WARNING

Before removing system covers, turn off the power and unplug the system power cable. Power is removed only when the power cable is unplugged.

Static electricity and improper installation procedures can damage computer components. Protect computer components by following these safety instructions.

CAUTION

Electrostatic discharge can damage computer components. Discharge static electricity by touching a metal object before removing the system unit cover.

- Avoid carpets in cool, dry areas. Leave boards and chips in their anti-static packaging until ready to be installed.
- Dissipate static electricity before handling any system components (boards, chips, memory modules) by touching a grounded metal object, such as the system's unpainted metal chassis.

If possible, use antistatic devices, such as wrist straps and floor mats.

-
- Always hold a chip or board by its edges. Avoid touching the components on the chip or board.
 - Take care when connecting or disconnecting cables. A damaged cable can cause a short in the electrical circuit.
 - When installing a cable, route the cable so it is not pinched by other components and is out of the path of the system unit covers.
 - Prevent damage to the connectors by aligning connector pins before you connect the cable.

Misaligned connector pins can cause damage to system components at power-on.
 - When disconnecting a cable, always pull on the cable connector or strain-relief loop, not on the cable itself.

System Unit Covers

The following sections describe how to remove and replace the system unit left side cover, right side cover, and front panel. Remove the left side cover to access the interior of the system.

Less frequently, remove the right side cover to install/replace a 5 1/4-inch device and remove the front panel to install/replace a hard drive or a 5 1/4-inch device (see “Removing the Front Panel” later in this chapter).

4-4 Installing Options

Removing the Left Side Cover

Before installing optional hardware inside your system, you must first remove the left side cover from the system unit.

WARNING

Before removing the left side cover, turn off system power and unplug the system power cable. Power is removed only when the power cable is unplugged.

1. Turn off and unplug the system unit.
2. Disconnect any external options (such as a keyboard and monitor) from the front or rear of the system unit.

CAUTION

Electrostatic discharge can damage computer components. Discharge static electricity by touching a metal object before removing the left side cover.

3. If you have a padlock in the lock tab on the rear of the chassis, remove it.

-
4. Remove the two thumb screws holding the left side cover to the rear of the chassis.
 5. Grasp the handle on the left side cover and slide the cover towards the rear of the chassis about an inch.
 6. Pull the top of the side cover away from the chassis about one-half inch, then lift the cover off the system.

Removing the left side cover

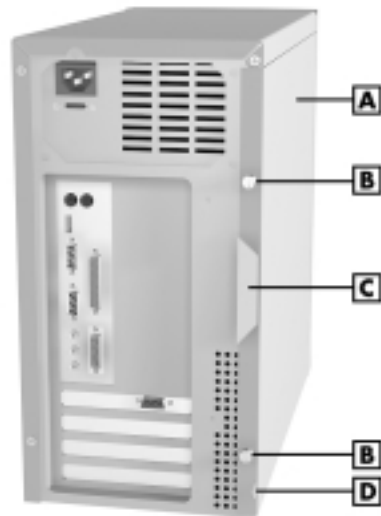

- | | |
|---------------------|--------------|
| A – Left Side Cover | C – Handle |
| B – Thumb Screws | D – Lock Tab |

4-6 Installing Options

Replacing the Left Side Cover

Replace the left side cover as follows.



CAUTION

Ensure that all cables are positioned to prevent crimping, abrasion, or cutting while installing the cover. Check that the ribbon cables are folded along their fold lines and out of the direct path of the cover.

1. Position the side cover over the side of the chassis so that the back edge of the cover is about an inch beyond the back edge of the chassis (see the following figure).
2. Fit the flange on the bottom of the cover over the rail along the bottom edge of the chassis.
3. Align the lock tab slot at the bottom rear of the cover with the lock tab.
4. Align the tabs on the top of the cover with the top slots on the chassis.
5. Firmly press the cover against the chassis and slide the cover towards the front of the chassis until it locks in place.

 **Note:** If the left side cover does not slide all the way to the front of the chassis, check that the cover tabs at the front of the cover are properly inserted into their slots in the chassis.

Replacing the left side cover



A – Tab Slots
B – Left Side Cover

C – Chassis Rail
D – Lock Tab

6. Replace the two previously removed thumb screws.
7. If you have a padlock for the locking tab on the rear edge of the chassis, install it.
8. Reconnect all external peripherals.
9. Plug in your power cables.

4-8 Installing Options

Removing the Right Side Cover

Before installing (or removing) 5 1/4-inch devices in your system, you must remove the right side cover from the system unit to access the device mounting screws.

WARNING

Before removing the right side cover, turn off system power and unplug the system power cable. Power is removed only when the power cable is unplugged.

1. Turn off and unplug the system unit.
2. Disconnect any external options (such as a keyboard and monitor) from the front or rear of the system unit.

CAUTION

Electrostatic discharge can damage computer components. Discharge static electricity by touching a metal object before removing the left side cover.

3. Remove the left side cover (see “Removing the Left Side Cover” earlier in this chapter).

-
4. Remove the three screws holding the right side cover to the rear of the chassis.

Removing the right side cover

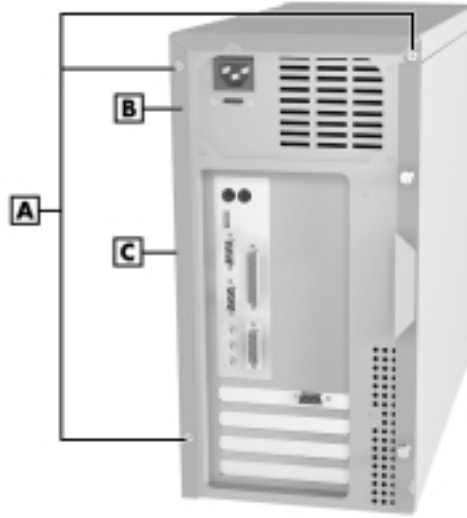

A – Screws
B – Handle

C – Right Side Cover

5. Grasp the handle on the right side cover and slide the cover towards the rear of the chassis about one-half inch.
6. Pull out the bottom of the cover and tilt the cover towards the left side of the chassis until it releases from the chassis.
7. Remove the cover from the chassis.

4-10 Installing Options

Replacing the Right Side Cover

Replace the right side cover as follows.

1. Position the right side cover over the chassis, about a half-inch from the front panel.

Replacing the right side cover



A – Right Side Cover
B – Flange
C – Rail

D – Tabs
E – Tab Slots

2. Align the tabs on the inside of the top of the cover with the tab slots on the left side of the chassis.
3. Fit the flange on the bottom of the cover over the rail along the bottom edge of the chassis.

-
4. Firmly press the cover against the chassis and slide the cover towards the front of the chassis until it locks in place.

 **Note:** If the right side cover does not slide all the way to the front of the chassis, check that the cover tabs at the left side of the cover are properly inserted into their slots in the chassis.

5. Replace the three previously removed screws.
6. Replace the left side cover (see “Replacing the Left Side Cover” earlier in this chapter).
7. Reconnect all external peripherals.
8. Plug in your power cables.

System Board Options

This section describes how to upgrade options on the system board. Procedures described in this section include:

- adding memory modules
- upgrading the processor.

The following figure shows the locations of the sockets and connectors on the system board.

System board sockets and connectors

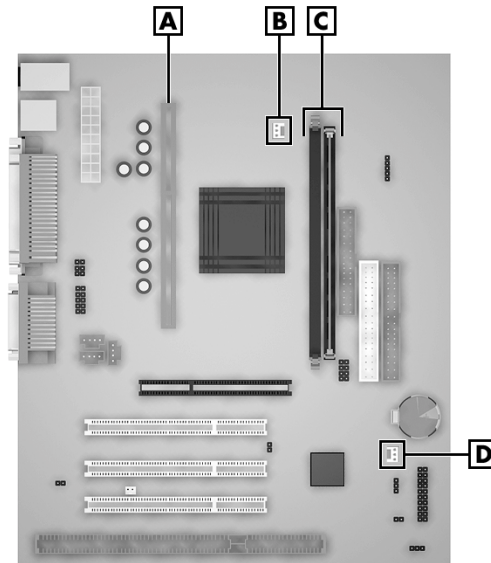

A – Processor Socket
B – Cooling Fan Connector

C – Memory Sockets 1 and 2
D – Wake-On LAN Connector

Memory Upgrade

Memory upgrades are installed into two memory module sockets on the system board. The sockets support up to 512 MB of high-speed memory. The system supports 168-pin, 100-MHz SDRAM modules in 32-, 64-, 128-, and 256-MB unbuffered memory configurations. Non-ECC dual inline memory modules (DIMMs) are supported.

Use the following guidelines in selecting DIMM types:

- memory can be installed in one or two sockets
- the size of the DIMMs can vary between sockets

-
- the speed of the DIMMs must match or exceed the processor bus speed
 - single- and double-sided DIMMs are supported.

To determine what configuration of DIMMs to use, see the table “Supported DIMMs.”

For sample memory configurations, see the table “Sample DIMM Upgrade Paths.”

To locate memory module sockets on the system board, see the previous figure, “System board sockets and connectors.”

To determine the memory you need to purchase for a memory upgrade, see “Checking System Memory.”

Supported DIMMs

| DIMM Size | Non-ECC Configuration |
|------------------|------------------------------|
| 32 MB | 4 Mbit x 64 |
| 64 MB | 8 Mbit x 64 |
| 128 MB | 16 Mbit x 64 |
| 256 MB | 32 Mbit x 64 |

4-14 Installing Options

Sample DIMM Upgrade Paths*

| Total Memory | DIMM 1 | DIMM 2 |
|--------------|--------|--------|
| 32 MB | 32 MB | — |
| 64 MB | 32 MB | 32 MB |
| 64 MB | 64 MB | — |
| 128 MB | 64 MB | 64 MB |
| 128 MB | 128 MB | — |
| 256 MB | 128 MB | 128 MB |
| 256 MB | 256 MB | — |
| 512 MB | 256 MB | 256 MB |

*The information in this table shows sample DIMM upgrade paths. It does not represent every combination of DIMMs supported in the system.

Checking System Memory

If you do not know how much memory is installed in your system, check the amount by using the following procedure.

1. On the Windows 95, Windows 98, or Windows NT 4.0 desktop, point to **My Computer**, and click the right mouse button.
2. With the left mouse button, click **Properties**. The **General** tab shows the random access memory (RAM). This is the amount of system memory in your computer.

In Windows 95 or Windows 98, you can also find the amount of memory by pointing to **My Computer**, clicking the right mouse button, and selecting the **Performance** tab.

Removing a DIMM

If your memory configuration requires the removal of a DIMM module, use the following steps.



CAUTION

Before opening the computer and before handling boards or memory modules, reduce static discharge by touching the chassis.

1. Remove the left side cover (see “Removing the Left Side Cover” earlier in this Chapter).
2. Locate the memory upgrade sockets on the system board (see the figure “System board sockets and connectors” earlier in this chapter).
3. Eject a DIMM by pressing the plastic clips at the outer edges of the socket away from the memory module.

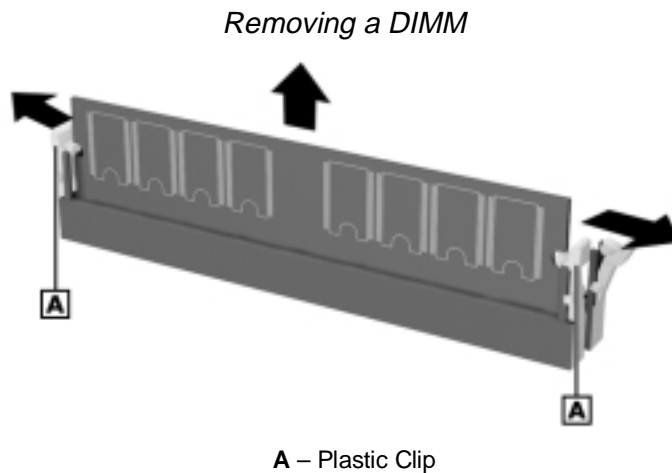

-
4. If you are installing a DIMM, see “Installing a DIMM” in the next section.
 5. Replace the left side cover (see “Replacing the Left Side Cover” earlier in this chapter).

Installing a DIMM

Use the following steps to install a memory module.

1. Remove the left side cover (see “Removing the Left Side Cover” earlier in this chapter).
2. If you need to remove a currently installed DIMM, see “Removing a DIMM” earlier in this chapter.



CAUTION

Before you install a DIMM, reduce static discharge by touching the chassis.

3. Align the notches on the new DIMM with the keys in an empty memory socket (see the following figure).

If your memory configuration requires only one DIMM, install it in DIMM socket 1 (next to the processor).
4. Press the DIMM firmly into the socket.
5. Make sure the locking clips at both ends of the DIMM click closed.

Inserting a DIMM

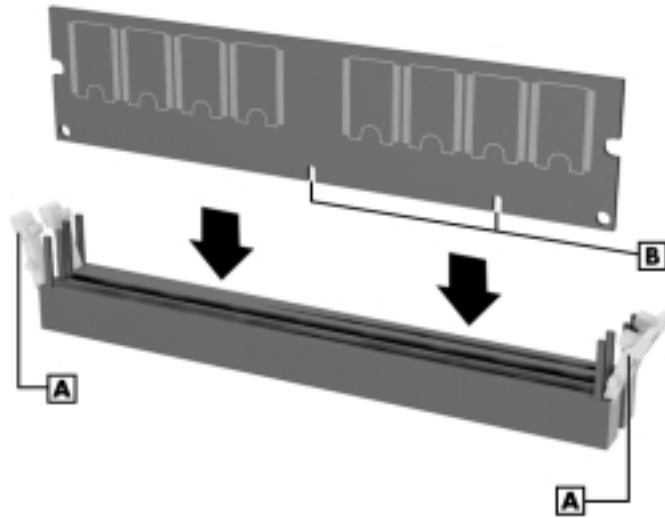

A – Plastic Clips

B – Notches

6. Replace the left side cover (see “Replacing the Left Side Cover” earlier in this chapter).

 **Note:** If you find a discrepancy in the amount of memory displayed at the Power-On Self-Test or in Windows with the amount of memory that you installed, check that you installed the memory modules correctly.

Processor Upgrade

The system board has a Slot 1 242-pin edge connector and a universal retention mechanism for securing in place a Celeron, Pentium II, or Pentium III processor cartridge (depending on your system model).

Before starting the processor upgrade, you must first determine the processor your system has, as the type of processor determines the installation procedure you use.

To identify a Pentium II or a Pentium III processor, check the top of the cartridge. To identify a Celeron processor, check the rear of the cartridge.

To remove the processor, see “Removing the Celeron or Pentium III Processor Cartridge” or see “Removing the Pentium II Processor Cartridge” in the following sections.

To install the upgrade processor, see “Installing the Celeron or Pentium III Processor Cartridge” or see “Installing the Pentium II Processor Cartridge” in the following sections.



CAUTION

NEC recommends that you contact your NEC dealer or NEC service center for assistance in upgrading your processor.

Incorrect installation of the processor cartridge and heat sink can damage the processor, system board, or both. Carefully follow the installation instructions provided with the upgrade processor and the procedures in the following sections.

Ensure that you have the correct heat sink for the processor being installed. The Celeron, Pentium II, and Pentium III each use a different heat sink. Do not use the heat sink from the removed processor.

 **Note:** After the processor cartridge is removed or replaced, the processor jumpers on the system board must be reset (see “Processor Jumper Settings” in Chapter 3).

Removing a Celeron or Pentium III Processor

Remove the Celeron or Pentium III processor cartridge from its Slot 1 socket and universal retention mechanism on the system board as follows.



CAUTION

Before handling components, reduce static discharge by touching the chassis.

1. Power off the system and remove the left side cover (see “Removing the Left Side Cover” earlier in this chapter).
2. Position the system on its right side for easier access to the system board and processor cartridge.



WARNING

If the system was just running, the processor cartridge and heat sink on the system board are hot. To avoid a burn, let the components cool for about 10 minutes before continuing.

3. Locate the processor cartridge on the system board (see the figure “System board sockets and connectors” earlier in this chapter).

-
4. If necessary, remove the AGP graphics board and any other expansion board(s) blocking access to the processor (see “Removing the AGP Graphics Board” or see “Removing an Expansion Board” later in this chapter).
 5. If the processor cartridge has an attached cooling fan, tag and unplug the fan cable from its connector on the system board.
 6. At one end of the processor cartridge (see the following figure), carefully pull the locking lever away from the cartridge approximately 1/4-inch. The lever requires a strong steady pull to release the cartridge.
 7. While holding the locking lever out, carefully pull up on the end of the cartridge to release the end from the retention mechanism.

Removing the Celeron or Pentium III processor cartridge

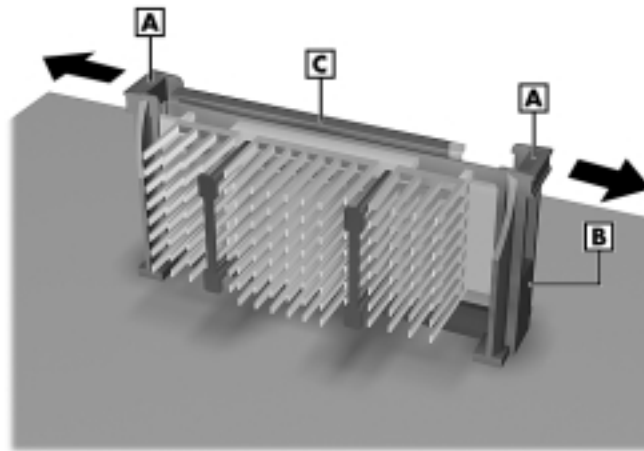

A – Locking Lever
B – Universal Retention Mechanism

C – Processor Cartridge

-
8. Repeat steps 6 and 7 for the locking lever on the opposite end of the cartridge.
 9. Pull the cartridge straight up and out of the socket and universal retention mechanism. Store the processor cartridge in an antistatic bag.
 10. Install the upgrade processor (see “Installing the Celeron or Pentium III Upgrade Processor” in the next section).

Installing a Celeron or Pentium III Upgrade Processor

Install the Celeron or Pentium III upgrade processor cartridge as follows.

1. Remove the processor currently in your system (see “Removing the Celeron or Pentium III Processor” in the previous section).



Before picking up the processor, reduce static discharge by touching the metal chassis.

2. Align the cartridge with the top of the retention mechanism so that the notch in the cartridge connector aligns with the key in the Slot 1 connector.
3. Insert the cartridge into the retention mechanism and evenly press down on the cartridge until it is fully seated in the Slot 1 connector.

Installing the Celeron or Pentium III processor

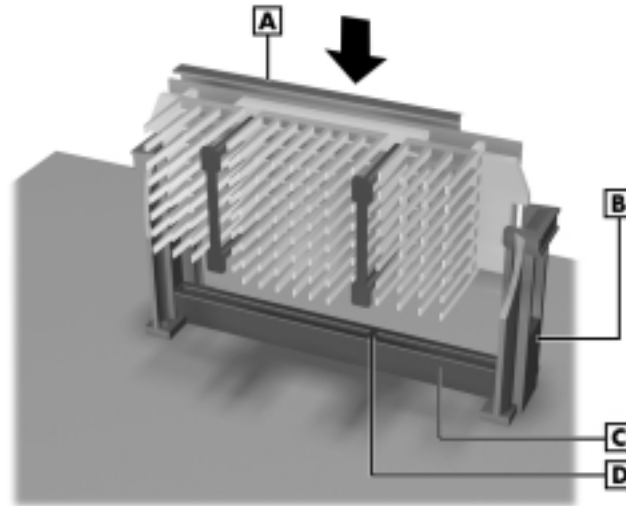

A – Processor Cartridge
B – Retention Mechanism

C – Slot 1 Connector
D – Key

4. If the processor cartridge has an attached cooling fan, plug the fan cable into its connector (CPUFAN) on the system board.
5. Set the processor jumpers on the system board for the processor type that you installed (see “Processor Jumper Settings” in Chapter 3).
6. Replace the AGP graphics board and any expansion boards you might have removed (see “Installing an Expansion Board” and “Installing the AGP Board” later in this chapter).
7. Set the processor jumpers on the system board for the processor type that you installed (see “Processor Jumper Settings” in Chapter 3).

-
8. Install the left side panel (see “Replacing the Left Side Panel” earlier in this chapter).
 9. Connect any peripherals and power cords, and power up the system.

Removing the Pentium II Processor

Remove the Pentium II processor cartridge from its Slot 1 socket and universal retention mechanism on the system board as follows.



CAUTION

Before handling components, reduce static discharge by touching the chassis.

1. Remove the left side cover (see “Removing the Left Side Cover” earlier in this chapter).
2. Position the system on its right side for easier access to the system board and processor cartridge.



WARNING

If the system was just running, the processor cartridge and heat sink on the system board are hot. To avoid a burn, let the components cool for about 10 minutes before continuing.

3. Locate the processor on the system board (see the figure “System board sockets and connectors” earlier in this chapter).

-
4. If necessary, remove the AGP graphics board and any other expansion board(s) blocking access to the processor (see “Removing the AGP Graphics Board” or see “Removing an Expansion Board” later in this chapter).
 5. If your system has a plastic top bar holding the processor and heat sink in place, remove the bar (see the following figure). If the system does not have the bar, go to step 6.
 - Remove the DIMM memory module from DIMM socket 1 and place it on an antistatic surface (see “Removing a DIMM” earlier in this chapter).
 - Squeeze each end of the top bar and pull it out of the processor heat sink and retention mechanism.
 - Continue to step 6 to remove the processor cartridge.
 6. Press the two locking tabs in as far as they go to release the processor cartridge from the retention mechanism.
 7. Carefully pull the cartridge straight up and out of the connector and retention mechanism.
 8. Store the processor cartridge in an antistatic bag.
 9. Install the Pentium II upgrade processor (see “Installing the Pentium II Upgrade Processor” in the next section).

Removing the Pentium II Processor

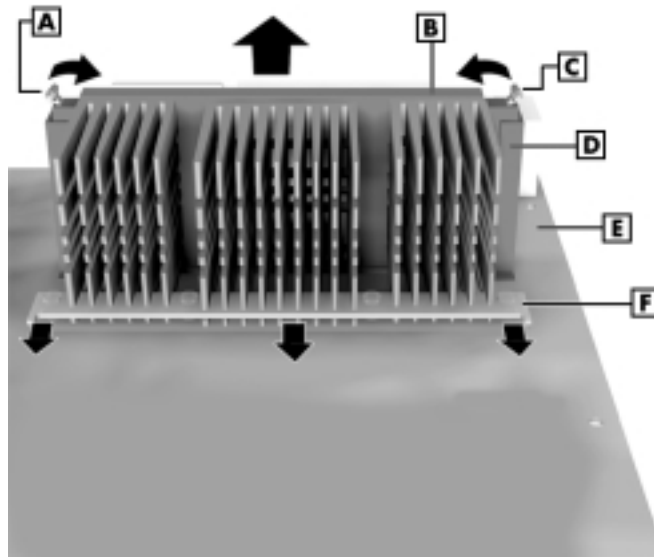

A – Locking Tab
B – Processor Cartridge
C – Locking Tab

D – Retention Mechanism
E – System Board
F – Top Bar

Installing the Pentium II Upgrade Processor

Install the Pentium II upgrade processor cartridge as follows.

1. Remove the Pentium II processor currently in your system (see “Removing the Pentium II Processor” in the previous section).



CAUTION

Before picking up the processor, reduce static discharge by touching the metal chassis.

-
2. Align the cartridge with the top of the retention mechanism so that the notch in the cartridge connector aligns with the key in the Slot 1 connector (see the following figure).
 3. Insert the cartridge into the retention mechanism and evenly press down on the cartridge until it is fully seated in the Slot 1 connector.
 4. Lock the cartridge in place by pressing out on the two locking tabs.
 5. For systems using the top bar, install it as follows.



CAUTION

Use caution when inserting the top bar to prevent damage to the plastic clips on the DIMM socket.

- Insert the bar into its pins on the retention mechanism and the heat sink. The flat side of the bar goes against the flat side of the bottom bar.
- Install the previously removed DIMM module (see “Installing DIMM Modules” earlier in this chapter).

Installing the Pentium II processor

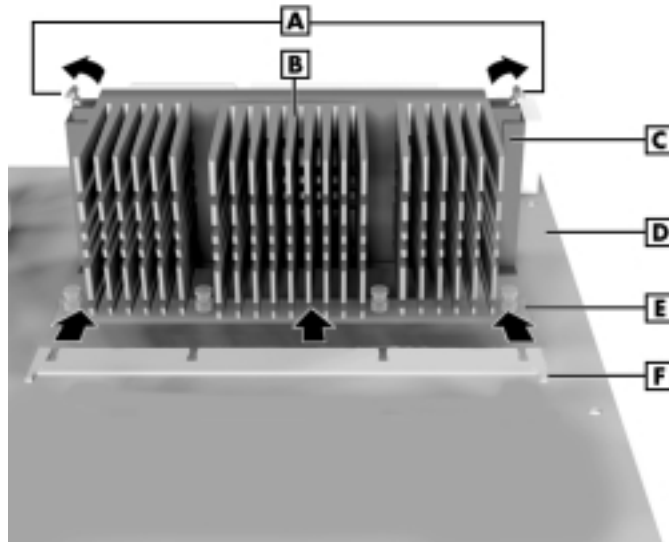

- | | |
|--------------------------------|-------------------------|
| A – Locking Tabs | D – System Board |
| B – Processor Cartridge | E – Bottom Bar |
| C – Retention Mechanism | F – Top Bar |

6. Set the processor jumpers on the system board for the processor type that you installed (see “Processor Jumper Settings” in Chapter 3).
7. Replace the AGP graphics board and any expansion boards that you might have removed (see “Installing an Expansion Board” and “Installing the AGP Board” later in this chapter).
8. Install the left side cover (see “Replacing the Left Side Cover” earlier in this chapter).

Expansion Boards

Your system supports 32-bit PCI Plug and Play expansion boards. Your system also supports industry standard architecture (ISA) 8- and 16-bit expansion boards (Plug and Play and non-Plug and Play).

With Plug and Play expansion boards, you can install a board without changing the hardware settings. There are no system resource conflicts to resolve. Plug and Play automatically configures the board for the system.

The PCI connectors support bus mastering and accept PCI expansion boards that run at half the system board's bus speed. The PCI bus handles 32 bits of data at a time, boosting system performance.

The following sections show PCI and ISA slot and connector locations and includes procedures for installing and removing expansion boards.

Locating Expansion Slots and Connectors

The following figure shows the locations of the expansion slots on the chassis and the expansion board connectors on the system board.

Locating expansion board slots and connectors

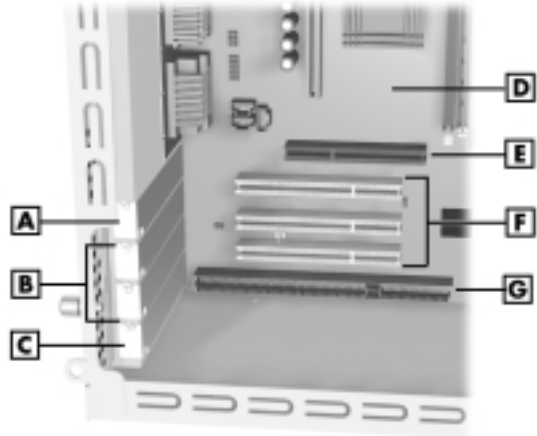

A – AGP Board Slot
B – PCI Slots
C – PCI/ISA Shared Slot
D – System Board

E – AGP Board Connector
F – PCI Connectors
G – ISA Connector

Installing an Expansion Board

To install an expansion board in the system, use the following steps.

1. Remove the left side cover (see “Removing the Left Side Cover” earlier in this chapter).
2. Follow any preinstallation instructions that come with the expansion board (such as setting jumpers on the board).
3. Remove and save the screw securing the expansion board slot cover.
4. Remove and save the slot cover.

Removing a slot cover

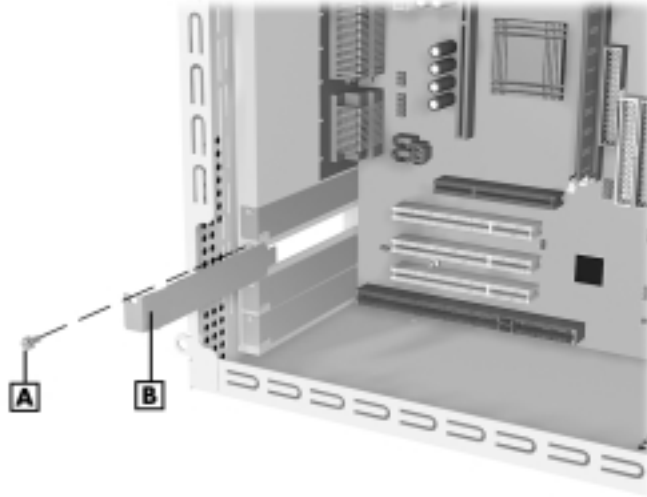

A – Slot Cover

B – Screw

-
5. Hold the expansion board by its edges or its bracket and insert the board into the expansion slot.
 6. Press the board firmly into the expansion slot connector on the system board.
 7. Secure the expansion board bracket in place with the previously removed screw.

Installing an expansion board

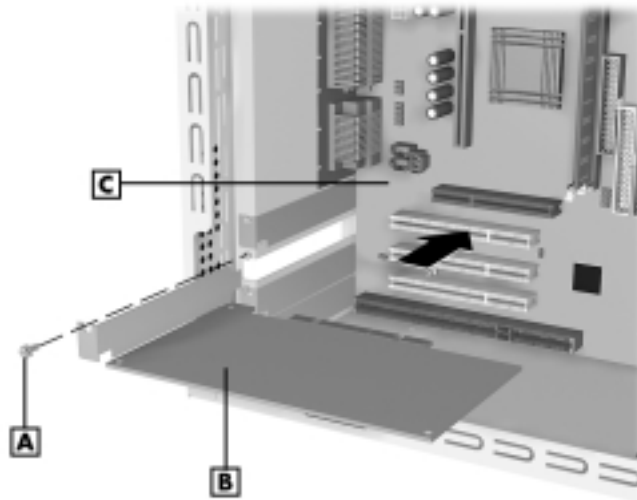

A – Screw

B – Expansion Board

C – System Board

8. Attach any signal cables required by the expansion board.
9. Replace the left side cover (see “Replacing the Left Side Cover” earlier in this chapter).

4-32 Installing Options

Removing an Expansion Board

To remove an expansion board, use the following steps.

1. Remove the left side cover (see “Removing the Left Side Cover” earlier in this chapter).
2. Label and unplug any cables connected to the board.
3. Remove the screw that secures the expansion board to the chassis. Save the screw.
4. Pull the board out of the connector and expansion slot. Set the board on an antistatic surface.
5. Install a new board or install the slot cover if you are not installing a board. Secure the board or slot cover with the previously removed screw (see “Installing an Expansion Board” in the previous section).
6. Replace the left side cover (see “Replacing the Left Side Cover” earlier in this chapter).

AGP Board

The system board has a dedicated AGP board connector for the AGP graphics board shipped with your system. If you need to remove the existing board and install another AGP board, use the following procedures.

Removing the AGP Graphics Board

Remove the AGP board as follows.

1. Remove the left side cover (see “Removing the Left Side Cover” earlier in this chapter).

-
2. Remove the screw holding the AGP board in its expansion slot (see the figure “Locating expansion board slots and connectors” for the location of the board and screw).
 3. Carefully pull the AGP board out of its connector on the system board.
 4. Set the AGP board on an antistatic surface or in an antistatic bag.
 5. Install an AGP board (see “Installing the AGP Graphics Board” in the next section).

Installing the AGP Graphics Board

Install an AGP graphics board as follows.

1. Remove the current AGP graphics board (see “Removing the AGP Graphics Board” earlier in this section).
2. Insert the new AGP board in the AGP connector on the system board.
3. Secure the board to the chassis with the previously removed screw.
4. Replace the left side cover (see “Replacing the Left Side Cover” earlier in this chapter).

Data Storage Devices

The system board in the computer supports the following storage devices:

- one diskette drive
- up to four IDE drives, such as an IDE hard drive, IDE CD-ROM drive, DVD-ROM drive, and an IDE Zip drive.

Other storage devices might require the installation of a compatible controller board. See your hardware dealer about the storage devices available for your system.

Locating Device Bays

The system has five bays (see the following figure):

- two 5 1/4-inch accessible device bays (1.6-inch high, half-height)
- one 3 1/2-inch accessible device bay containing the standard 1.44-MB diskette drive
- two 3 1/2-inch internal hard drive bays.

Locating device bays

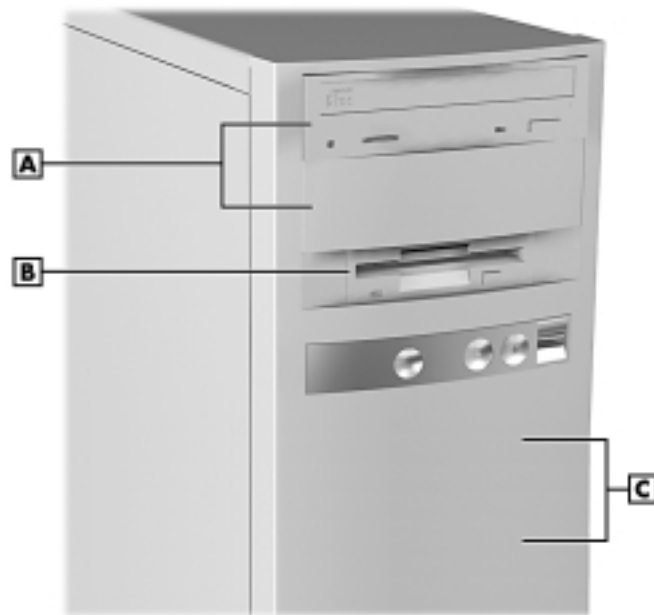

- A** – 5 1/4-Inch Accessible Bays **C** – 3 1/2-Inch Internal Bays
(behind front panel)
- B** – 3 1/2-Inch Accessible Bay

Depending on your configuration, one accessible device bay might contain a CD-ROM drive, DVD-ROM drive, or other storage device.

The other accessible bay supports devices with 5 1/4-inch form factors (frames):

- tape drive, CD-ROM drive, or DVD-ROM drive
- PC card adapter, LS-120 drive
- Zip drive.

The accessible bays are not limited to devices with removable media. For example, you can install a hard drive with a 5 1/4-inch frame in one of these bays.

A 5 1/4-inch bay can also accommodate a 3 1/2-inch device if the device is housed in a 5 1/4-inch frame.

Preparing the Device

Before installing a storage device in the system, follow any preinstallation instructions that come with the device. For example, check the following information:

- Diskette drive — remove any termination on an optional diskette drive. See the documentation that comes with the drive.
- IDE drive — check the jumper settings on the device before installing it. See the documentation that comes with the device for jumper setting information.
- CD-ROM drive must be set correctly as the first (master) or second (slave) device on the secondary IDE channel.

See “Connecting Device Cables” for more information.

Connecting Device Cables

The cables used for installing optional storage devices include:

- diskette drive signal cable
- IDE signal cables
- system power cables.

System board cable connectors

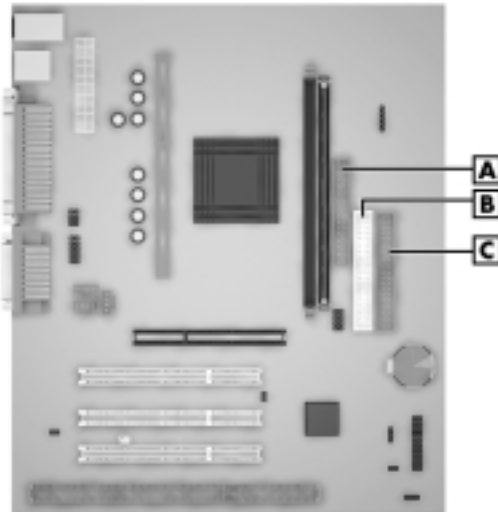

- A** – Diskette Drive Connector **C** – Primary IDE Connector
B – Secondary IDE Connector

Use the following table when configuring IDE drives on the primary and secondary IDE connectors on the system board.

If you are installing a DVD-ROM drive, substitute the DVD-ROM drive for the CD-ROM drive in the following table.

IDE Connector Configuration

| Configuration | Primary connector | Secondary connector |
|---|---|---|
| 1 device (hard drive) | Master - hard drive Slave - none | Master - none Slave - none |
| 2 devices (hard drive, CD-ROM) | Master - hard drive Slave - none | Master - CD-ROM Slave - none |
| 2 devices (hard drive, tape backup) | Master - hard drive Slave - none | Master - tape backup Slave - none |
| 2 devices (hard drive, Zip drive) | Master - hard drive Slave - none | Master - Zip drive Slave - none |
| 2 devices (hard drive, LS-120 drive) | Master - hard drive Slave - none | Master - LS-120 drive Slave - none |
| 3 devices (hard drive, CD-ROM, Zip drive) | Master - hard drive Slave - none | Master - CD-ROM Slave - Zip drive |
| 3 devices (hard drive, CD-ROM, tape backup) | Master - hard drive Slave - none | Master - CD-ROM Slave - tape backup |
| 3 devices (hard drive, CD-ROM, LS-120 drive) | Master - hard drive Slave - none | Master - CD-ROM Slave - LS-120 drive |
| 3 devices (hard drive, hard drive, CD-ROM) | Master - hard drive Slave - hard drive | Master - CD-ROM Slave - none |
| 3 devices (hard drive, hard drive, tape backup) | Master - hard drive Slave - hard drive | Master - tape backup Slave - none |
| 3 devices (hard drive, hard drive, Zip drive) | Master - hard drive Slave - hard drive | Master - Zip drive Slave - none |
| 3 devices (hard drive, hard drive, LS-120 drive) | Master - hard drive Slave - hard drive | Master - LS-120 drive Slave - none |
| 4 devices (hard drive, hard drive, CD-ROM, tape backup) | Master - hard drive Slave - hard drive | Master - CD-ROM Slave - tape backup |
| 4 devices (hard drive, hard drive, CD-ROM, Zip drive) | Master - hard drive Slave - hard drive | Master - CD-ROM Slave - Zip drive |

IDE Connector Configuration

| Configuration | Primary connector | Secondary connector |
|---|---|--|
| 4 devices (hard drive, hard drive, CD-ROM, LS-120 drive) | Master - hard drive Slave - hard drive | Master - CD-ROM Slave - LS-120 drive |
| 4 devices (hard drive, hard drive, Zip drive, tape backup) | Master - hard drive Slave - hard drive | Master - Zip drive Slave - tape backup |
| 4 devices (hard drive, hard drive, Zip drive, LS-120 drive) | Master - hard drive Slave - hard drive | Master - Zip drive Slave - LS-120 drive |
| 4 devices (hard drive, hard drive, tape backup, LS-120 drive) | Master - hard drive Slave - hard drive | Master - tape backup Slave - LS-120 drive |
| 4 devices* (hard drive, LS-120 drive, CD-ROM, Zip drive) | Master - hard drive Slave - CD-ROM | Master - Zip drive Slave - LS-120 drive |
| 4 devices* (hard drive, LS-120 drive, CD-ROM, tape backup) | Master - hard drive Slave - CD-ROM | Master - tape backup Slave - LS-120 drive |
| 4 devices* (hard drive, LS-120 drive, Zip drive, tape backup) | Master - hard drive Slave - LS-120 drive | Master - Zip drive Slave - tape backup |

* Hard drive must be mounted in top location

Diskette Drive Signal Cable

A diskette drive signal cable comes attached to the system board and to the standard 1.44-MB diskette drive.

The colored edge of the cable goes to pin 1 on the cable connector. Align the red edge of the cable with pin 1 (the notched end) on the drive connector.

4-40 Installing Options

IDE Signal Cables

Systems with an IDE hard drive come with a three-connector IDE interface cable attached to the primary IDE connector. Some systems come with a second three-connector IDE cable connected to the second IDE drive (such as the CD-ROM drive) and to the secondary IDE connector.

System Power Cables

Power cables come from the power supply and are attached to the standard storage devices. System power cables vary in length and provide connector sizes to accommodate a variety of supported storage configurations. Power cable connectors are keyed to fit only in the correct position.

Cabling Storage Devices

All storage devices require power and signal cable connections. Devices shipped with the system are already connected.

Your computer supports the following types of cabled storage devices:

- IDE drives — includes hard drive, Zip drive, tape backup unit, CD-ROM drive, and DVD-ROM drive
- diskette drive — 1.44-MB drive and 120-MB drive
- PC card adapter (with a PC adapter board).

IDE Drive Cabling

Use the following procedure to cable an IDE drive.

 **Note:** The appearance of your device may vary from the one shown.

1. Connect the signal cable connector to the connector on the IDE drive. Use care to prevent bending connector pins. Align the cable connector as shown in the following figure).
2. Locate an available power connector coming from the power supply.
3. Connect the appropriate power cable to the power connector on the IDE drive.

Connecting the IDE drive cable

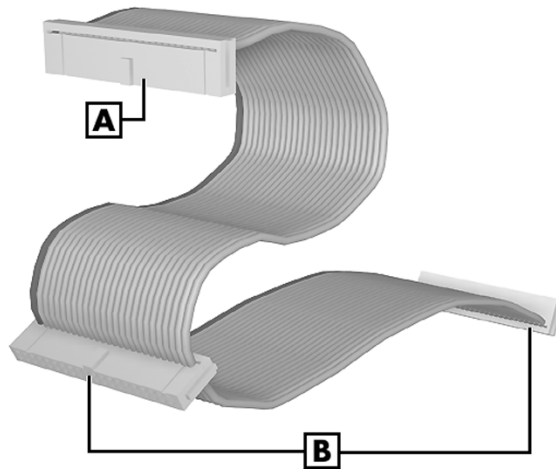

A – Connects to System Board IDE Connector **B** – Connects to IDE Devices

4-42 *Installing Options*

-
4. If you are installing a CD-ROM drive and your system has speakers, connect the audio cable to the CD In connector on the system board or an audio board (see the instructions that come with the drive).

Diskette Drive Cabling

Cable a diskette drive as follows.

1. Connect the diskette drive signal cable connector to the signal connector on the diskette drive.
2. Locate an available power connector coming from the power supply.
3. Connect the power cable to the power connector on the device.

PC Card Adapter Cabling

Cable a PC card adapter as follows.

1. Connect the connectors at one end of the card adapter cable set to the PC adapter board. The connectors are keyed to fit only one way.

The PC ISA adapter board installs in the ISA expansion slot. See “Installing an Expansion Board” if the board must be installed first.

2. Connect the connectors at the other end of the cable set to the connectors at the rear of the PC card adapter.

The PC card adapter installs in a 5 1/4-inch bay. If the adapter must be installed first, see “Installing a 5 1/4-inch Device” later in this chapter.

Network Board Wake-On LAN Cabling

If your computer has an optional 3COM Intel 10/100 MB network board, your system can be readied for “Wake-On LAN” by connecting the Wake-On LAN cable. Wake-On LAN allows your system to be powered up remotely by a server computer.

Cable the network board for Wake-On LAN as follows.

1. Remove the left side cover (see “Removing the Left Side Cover” earlier in this chapter).
2. Locate the LAN JWOL connector on the system board (see the figure “System board sockets and connectors” earlier in this chapter).
3. Remove the AGP graphics board and any expansion boards that may be in the way (see “Removing the AGP Graphics Board” and “Removing an Expansion Board” earlier in this chapter).
4. Connect one end of the LAN cable to the JWOL connector on the system board (see the figure “System board and sockets and connectors” earlier in this chapter).
5. Connect the other end of the LAN cable to the LAN board (see the documentation that comes with the option).
6. Replace the AGP graphics board and any expansion boards that were removed (see “Installing the AGP Graphics Board” and Installing an “Expansion Board” earlier in this chapter).
7. Replace the left side cover (see “Replacing the Left Side Cover” earlier in this chapter).
8. Enable Wake-On LAN through the BIOS (see Chapter 3 for information).

Installing Storage Devices

The following sections describe how to install 3 1/2-inch and 5 1/4-inch devices in the system. The installation procedures include:

- replacing or installing an 3 1/2-inch internal hard drive
- installing a 5 1/4-inch device.

Removing the Front Panel

Remove the front panel if you are installing an internal 3 1/2-inch hard drive or installing a device in one of the 5 1/4-inch accessible device bays. If you are going to install an accessible 5 1/4-inch device, you also need to remove the blank panel from the front panel (see “Removing the Blank Panel” later in this chapter).

The front panel is held in place on the chassis by six plugs, three to a side on the front panel.

To remove the front panel, proceed as follows.

- 1.** Remove the left side cover (see “Removing the Left Side Cover” earlier in this chapter).
- 2.** Remove the front panel from the chassis by grasping the edges at the bottom of the panel and evenly pulling out on the panel until the plugs release (see the following figure).

Removing the front panel

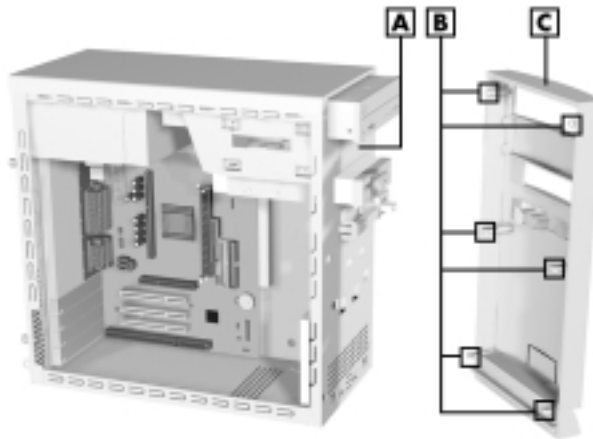

A – Metal Shield
B – Plugs

C – Front Panel

3. If you are removing or replacing a hard drive, go to “Installing a 3 1/2-Inch Hard Drive.”

If you are removing or replacing a 5 1/4-inch device, continue with this procedure.

4. Identify the bay on the front panel for the device being installed.

-
5. Remove the blank plastic panel from the bay by pressing the panel tabs from inside the front panel and pushing the blank panel out.

Save the panel for future use if you remove a device and don't replace it (see "Replacing the Front Panel" for procedures to reinstall the plastic panel).

Locating the blank panel tabs



A – Blank Panel Tabs

6. Remove the metal shield from the bay where you are installing the device (see the figure "Removing the front panel" for shield location).
 - Insert a screwdriver into one of the holes in the metal shield.
 - Twist the shield with the screwdriver until it comes loose.
7. Install the device (see "Installing a 5 1/4-Inch Device" later in this chapter).

Replacing the Front Panel

Replace the front panel as follows.

 **Note:** Before replacing the front panel, if you removed a 5 1/4-inch device from your system and didn't replace it, you need to cover the opening in the front panel with the previously removed plastic panel.

1. Replace the blank plastic panel in the front panel if necessary. Press the blank panel into the inside of the front panel (over the open slot). Press until the four tabs lock the blank panel in place.
2. Align the front panel plugs with the mounting holes in the front of the chassis.
3. Evenly press the front panel into position until the plugs lock the panel in place.
4. Replace the left side cover (see "Replacing the Left Side Cover" earlier in this chapter).

Installing a 3 1/2-Inch Hard Drive

You can upgrade your system by adding a second drive or replacing an existing hard drive. Each hard drive installs on internal drive brackets located at the front inside of the chassis.

 **Note:** You can also install a 3 1/2-inch hard drive in a 5 1/4-inch accessible device bay. Place the device in a 5 1/4-inch frame adapter and then follow the instructions in "Installing a 5 1/4-Inch Device."

Your system ships with one 3 1/2-inch hard drive installed on the bottom drive brackets. If you are adding a second hard drive or replacing the current hard drive, use the following procedure.

1. Follow the preinstallation instructions that come with your device, such as setting jumpers and switches.
2. Remove the left side cover (see “Removing the Left Side Cover” earlier in this chapter).
3. Remove the front panel (see “Removing the Front Panel” earlier in this chapter).
4. If you are replacing a hard drive,
 - unplug the hard drive power and signal cables
 - remove the four screws holding the old drive to the chassis (see the following figure for screw locations)
 - remove the old drive from the system
 - install a new drive as follows.
5. Connect the IDE drive signal and power cables to the hard drive you are installing in the system.
6. Attach the hard drive to the chassis:
 - Set the hard drive on the brackets inside the chassis (see the following figure for bracket locations).

Position the hard drive so that the connectors on the drive face out of the left side of the chassis and the component side of the drive is against the chassis.
 - Align the four screw holes in the drive with the four screw holes in the chassis (see the following figure).

-
- Secure the hard drive to the chassis with the four screws that come with the new device.

Installing a hard drive

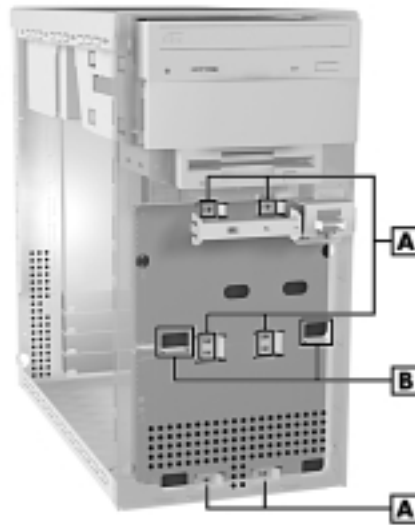

A – Screws

B – Top Bracket

7. Replace the front panel (see “Replacing the Front Panel” earlier in this chapter).
8. Replace the left side cover (see “Installing the Left Side Cover” earlier in this chapter).
9. Run the Setup program to set the new configuration (see “BIOS Setup Utility” in Chapter 3).

Installing a 5 1/4-Inch Device

Use the following procedure to install a 5 1/4-inch device in a 5 1/4-inch accessible device bay.

 **Note:** A 3 1/2-inch hard drive can also be installed in a 5 1/4-inch accessible device bay. Place the device in a 5 1/4-inch frame adapter and then follow the instructions in “Installing a 5 1/4-Inch Device.”

1. Follow the preinstallation instructions that come with your device, such as setting jumpers and switches.
2. Remove the left side cover (see “Removing the Left Side Cover” earlier in this chapter).
3. Remove the right side cover (see “Removing the Right Side Cover” earlier in this chapter).
4. Remove the front panel (see “Removing the Front Panel” earlier in this chapter).
5. From the front of the system, slide the device, connector end first, into the device bay (see the following figure). Slide it in far enough for access to the connectors at the rear of the device.
6. Connect the device cables (see “Connecting Device Cables” and “Cabling an IDE drive” earlier in this chapter).
7. Secure the device to the bay with two screws on the left side and one screw on the right side.

If replacing a device in the top bay, use four screws, two to a side.

Inserting a device

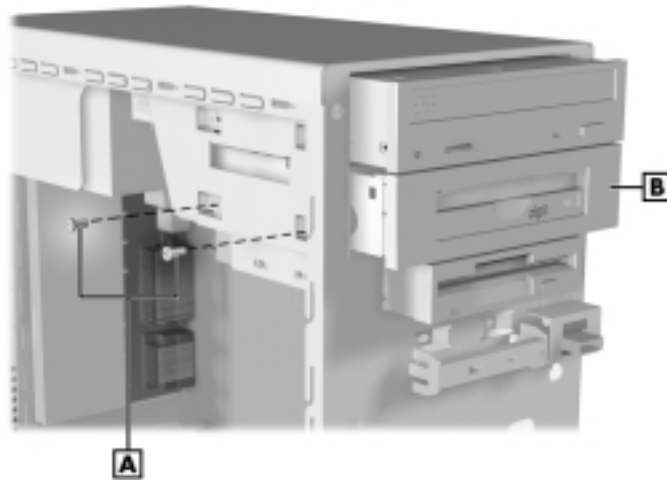

A – Screws

B – Device

8. Replace the front panel (see “Replacing the Front Panel” earlier in this chapter).
9. Replace the right side cover (see “Replacing the Right Side Cover” earlier in this chapter).
10. Replace the left side cover (see “Replacing the Left Side Cover” earlier in this chapter).
11. Connect the system and peripheral power cables and power up the system.
12. Run the Setup program to set the new configuration (see “BIOS Setup Utility” in Chapter 3).

5

Solving System Problems

- Solutions to Common Problems
- How to Clean the Mouse
- Battery Replacement
- How to Get Help

Occasionally, you may encounter a problem with your system. In most cases, the problem is one that you can solve yourself.

Your system has a built-in program that automatically checks its components when the system is powered on. If there is a problem, the system displays an error message. If this happens, follow any instructions on the screen.

If screen messages do not help or an error message does not appear, refer to the information in this chapter to determine and solve the problem.

Solutions to Common Problems

See the following sections to match your problem area and view the possible causes and solutions.

When trying to solve problems, you should note what the system was doing when the problem occurred and what you attempted to do to correct the problem. This information is useful if you request assistance.

System Problems

Check the following list to match your problem and see the possible cause and solution.

■ **No power and power lamp not lit.**

Check that all power switches are on.

Check that the power cable is plugged into the system power socket and that the other end is plugged into a live, properly grounded AC power outlet or surge protector.

Check the outlet or surge protector by plugging in a lamp.

5-2 Solving System Problems

- **Non-System Disk error message displays when the system is started.**

You have a diskette in the diskette drive, and the diskette drive is set before the hard drive in boot order. Remove the diskette from drive A and restart the system.

- **Operating system not found error message displays when the system is started.**

If you left a CD in the CD-ROM drive, your system may not be able to boot. Try removing the CD and rebooting.

Your hard drive might need more time to spin up before the system boots. Change the “Hard Disk Pre-Delay” to a higher setting (see BIOS Setup Advanced Menu in Chapter 3.)

- **System does not boot and error message displayed on screen.**

Run the Setup Utility (see Chapter 3). Check that the parameters are set correctly, particularly if you just installed an option.

- **System emits continuous beeps.**

Turn the system off, wait at least five seconds, and turn the system on. If the beeps continue, call your NEC CSD dealer or the NEC CSD Technical Support Center.

- **System does not maintain date, time, system configuration information.**

Change the battery (see “Battery Replacement” in this chapter). For assistance, call your NEC CSD dealer or the NEC CSD Technical Support Center.

- **System does not boot from hard drive.**

The system usually tries to start from the diskette drive before it starts from the hard drive. Remove the diskette from the diskette drive.

Run the Setup Utility (see Chapter 3) and set the initial Boot parameter to Hard Drive instead of Removable Device.

- **System does not boot immediately after hard drive spins up.**

The “Hard Disk Pre-Delay” in the BIOS Setup utility Advanced Menu can be changed to a lower setting. (If you get a message “operating system not found” after you change the setting, the delay is at too low a setting. Set the hard disk pre-delay slightly higher.)

- **System performance appears sluggish.**

Check that your system is set for optimal operation. See your operating system documentation.

Check the memory requirements of your software applications. If required, install additional DIMM memory (see Chapter 4).

If you added optional memory, check that you correctly installed the DIMM memory.

- **System password forgotten.**

Clear the password and reset it (see “Clear CMOS/Password” in Chapter 3).

Diskette Drive Problems

Check the following problems to see the possible cause and solution.

5-4 Solving System Problems

- **Diskette won't load.**

Check that the diskette is being loaded correctly.

Check that the system and monitor power lamps are on and the power-on screen appears.

Check that the diskette is formatted. If not, format it. See your operating system documentation.

Check that the diskette size is 1.44 MB (or 120 MB for the LS120 Super Disk drive).

If the diskette drive busy lamp does not light when you load the diskette, try a different diskette. If this loads, the problem is in the software.

- **Non-System Disk or Disk Error message displayed.**

If you are trying to boot from the diskette drive, insert a diskette with system files into drive A.

If a bootable diskette does not boot, use the BIOS Setup Utility to verify that the initial boot parameter is set to diskette drive A and not a hard drive.

Monitor Problems

Check the following problems to see the possible cause and solution.

- **Monitor screen is dark or the display is hard to read.**

Check that the monitor is on.

Check that the monitor power cable is connected to the monitor and a power outlet, the monitor signal cable is connected to the system, and the brightness and contrast controls are adjusted.

Press the space bar or move the mouse to take the system out of the power management mode.

- **Distorted image appears on your monitor screen.**

Adjust the monitor's video controls. If this does not help, turn the monitor off for several seconds, then back on.

- **There is constant movement on the screen.**

A magnetic field is affecting your monitor. Move any devices (fan, motor, another monitor) that generate magnetic fields away from your monitor.

- **The screen display is fuzzy or flickering; graphics characters or garbage appears on the screen.**

Check that your monitor is set up correctly and that all connections have been made.

Check that the video refresh rate and video driver are correct.

Click the right mouse button anywhere on the Windows desktop and a menu appears. Click on Properties and the Display Properties window appears.

Keyboard/Mouse Problems

Check the following problem to see the possible cause and solution.

- **Mouse or keyboard does not respond.**

You may have connected the mouse and keyboard after turning on your system. Turn the system off, make sure the mouse and keyboard are connected, and turn the system back on.

- **Image appears on screen but nothing happens when you use the mouse or keyboard.**

Make sure the keyboard or mouse cable is firmly connected to the rear of the system.

5-6 Solving System Problems

If this does not help, turn off the system, wait five or more seconds, and turn on the system.

CD-ROM Drive Problems

Check the following problems to see the possible cause and solution. The following is applicable to the CD-ROM drive.

- **The system does not see the drive.**

The drive designation is wrong and should be changed. The drive designation depends upon the storage device configuration in your system. To find out what drive designation letter is assigned to your drive, double click **My Computer** on the Windows 95 or Windows 98 or Windows NT 4.0 desktop. The drive designation is below the drive icon.

As an alternative, open Windows Explorer and scroll down the list of folders until you locate the drive icon. The drive designation is beside the icon.

- **The drive is not reading a disc.**

Check that the disc is inserted in the disc tray with the printed label side up.

Check that the disc is a data disc, not a music disc.

Try a different disc to see if the problem is limited to one disc.

- **The disc does not eject due to a power failure or software error.**

Turn off the system and use the emergency eject feature. Insert the end of a paper clip into the eject hole. Press inward on the clip to open the door.

-
- **The drive plays music CDs but the sound is not heard. However, .WAV and .MIDI sounds can be heard when played.**

Check that the cable connecting from the rear of the drive to the system board CD audio connector is in place and secure.

Check the CD Audio volume setting.

Speaker Problems

Check the following problems to see the possible cause and solution.

- **No sound from the speakers.**

Check that the speaker power is on. Verify that all speaker cable connections are correct and secure.

Check that the speaker's AC adapter is plugged into a properly grounded AC power outlet.

- **Speaker volume is too low.**

Adjust the volume control on the speaker. If the volume is still too low, adjust the volume through the system software. See your Windows Multimedia online help.

- **Sound is only coming from one speaker.**

Balance the speaker output by adjusting the balance in the sound software. See your Windows Multimedia online help.

How to Clean the Mouse

Under normal conditions, your mouse has a self-cleaning mechanism that prevents a buildup of dust or lint around the mouse ball and tracking mechanism. Periodically, however, you might need to clean the mouse ball.

Use these steps to clean your mouse.

1. Power off your computer and any peripherals attached to it.
2. Turn the mouse over. Locate the mouse ball cover.

Mouse ball cover

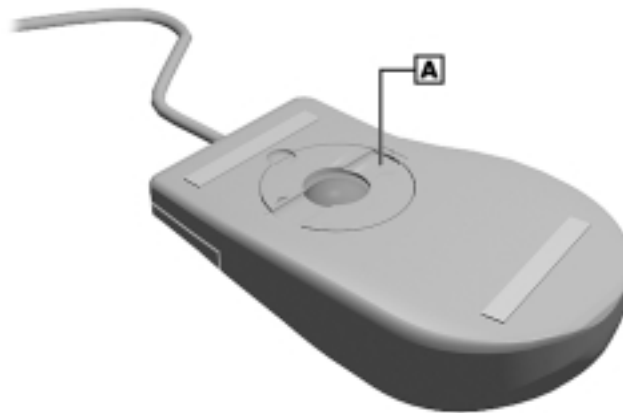

A – Mouse Ball Cover

3. Rotate the ball cover counterclockwise and remove the cover.

-
4. Turn the mouse over so that the cover and ball fall into your palm.
 5. Clean the mouse as follows.
 - Use tap water, or tap water and a mild detergent, to clean the mouse ball.
 - Use a clean, lint-free cloth to dry the ball.
 - Blow into the mouse socket to remove remaining dust or lint.
 6. Gently put the ball back into the mouse.
 7. Fit the ball cover back into the mouse and turn the cover clockwise until it locks in place.

5-10 Solving System Problems

Battery Replacement

The system board uses a battery to maintain system configuration information. The battery is a coin-cell battery mounted on the system board (see the following figure). If it fails to maintain system configuration information, replace it with an identically rated battery from the same manufacturer.

WARNING

The battery can explode if it is incorrectly replaced or improperly discarded. Use only the same type battery or an equivalent type recommended by the manufacturer when replacing the battery.

Lithium acts as a catalyst when exposed to water and causes spontaneous combustion on contact. Discard used batteries according to the manufacturer's instructions.

CAUTION

Removing the battery from the system board causes the computer to lose system configuration information. Prior to removing the battery, run the BIOS Setup utility (see Chapter 3) and print out or write down your system configuration settings. Then you can restore your system to its previous settings.

If you need to replace the battery, follow these steps.

1. Turn off and unplug the computer and any external components connected to it.

-
2. Remove the left side cover (see “Removing the Left Side Cover” in Chapter 4). Observe all safety precautions when removing the cover.
 3. Locate the battery socket on the system board (see the following figure). You may have to remove an expansion board to access the battery (see “Removing Expansion Boards” in Chapter 4).

Locating the battery socket on the system board

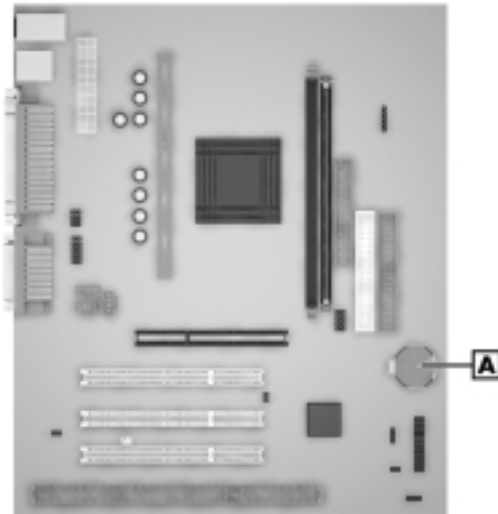

A – Battery

-
4. Press down on the battery clip to release the battery from its socket).



CAUTION

To maintain a tight battery contact with the socket, do not over-bend the battery clip.

5. Remove the battery and discard in accordance with the manufacturer's instructions.

Removing the battery

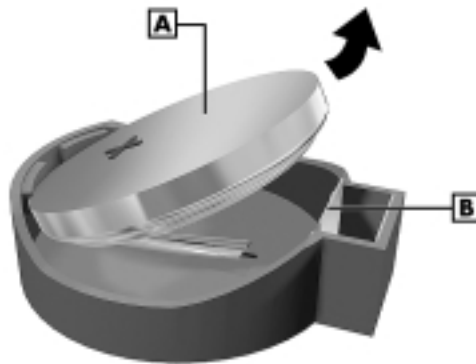

A – Battery

B – Clip

6. With the positive (+) side of the new battery facing up, press the battery into the socket.
7. Replace the left side cover (see “Replacing the Left Side Cover” in Chapter 4).
8. Connect external peripherals and power cables.
9. Run the Setup Utility to reconfigure your system parameters (see “BIOS Setup Utility” in Chapter 3).

How to Get Help

If you tried correcting problems yourself and were not successful, you may want to try one or more of the following 24-hour services for answers to your questions. (Some services require a modem or fax machine.)

- NEC CSD website and FTP site
- Email to NEC CSD Technical Support Services through a commercial online service or the Internet
- Fax Service to NEC CSD Technical Support Services
- NEC CSD Bulletin Board System
- NEC CSD Technical Support Services

See Chapter 6 for more information about the services listed above.

If you still need help, continue with the suggestions that follow.

Help From Your Company

If you are in a company, the best source of help may be internal. Your company may have designated central support personnel to whom you can go when you have problems.

Help From Your NEC CSD Dealer

The NEC CSD dealer from whom you purchased your system is a good source of help and should be contacted. The dealer is backed by complete support resources and programs within NEC CSD.

Help From NEC CSD Technical Support Center

Help is available to you through the NEC CSD Technical Support Center. (International customers should check with their sales provider.)

Direct assistance is available 24 hours a day, 7 days a week. Call the NEC CSD Technical Support Center, toll free, at **1-800-632-4525** (U.S. and Canada only) for the following support.

- System hardware — toll-free phone support is limited to the length of the standard warranty.

For hardware support after the standard warranty, get system hardware support for a fee.

- Preinstalled software — toll-free phone support for 90 days from the time of your first call to the NEC CSD Technical Support Center.

After the initial 90 days, get preinstalled software support for a fee.

Please have available your system's name, model number, serial number, and as much information as possible about your system's problem before calling.

If you are outside the U.S. and Canada, please contact your local NEC CSD sales provider.

NEC CSD Warranty/Non-Warranty Repair Service

NEC CSD repair service is designed to support your warranty and non-warranty service activity.

Before you call for repair service, see the previous sections in this chapter to determine if you can solve the problem yourself, within your company, through your dealer, or with the help of a technician from the NEC CSD Technical Support Center.

If your system requires repair service from NEC CSD, call **1-800-632-4525** (United States and Canada only).

If you are outside the U.S. and Canada, please contact your local NEC CSD sales provider.

6

Getting Services and Support

- NEC CSD Website
- NEC CSD FTP Site
- Email/Fax Technical Support Service
- NEC CSD Bulletin Board System
- NEC CSD Technical Support Services

NEC CSD makes it easy for you to get information and help when you need it with an array of services. These services provide general information about your system, and can also be used to answer your questions and help solve any problems you might have with your system.

With access to a telephone, modem, and/or fax machine, you can use these services to obtain information about your system on a 24-hour basis.

This chapter describes these services and how to access them.

NEC CSD Website

If you have a modem or a network board and Internet access, you can access the NEC CSD website. You can do this through a commercial online service or through your Internet account. The NEC CSD website contains general information about NEC CSD and its products, an online store, press releases, reviews, and service and support information.

Look in the Service and Support area for the following:

- technical documentation, including Frequently Asked Questions, reference manuals, and warranty information
- BIOS updates, drivers, and Setup Disk files to download
- contact information, including telephone numbers for Technical Support and links to vendor websites

-
- an automated email form for your technical support questions
 - a Reseller's area (password accessible).

To access the NEC CSD Home Page, enter the following Internet Uniform Resource Locator (URL) in your browser:

www.nec-computers.com

NEC CSD FTP Site

You can use the Internet to access the NEC CSD FTP (file transfer protocol) site to download various files (video drivers, printer drivers, BIOS updates, and Setup Disk files). The files are essentially the same files as on the NEC CSD website and the NEC CSD Bulletin Board System.

To access the NEC CSD FTP site, enter the following Internet ftp address through your service:

[ftp.neccsdeast.com](ftp://neccsdeast.com)

Once in the file menu, follow the prompts to choose and download the file(s) you want.

Email/Fax Technical Support Service

The NEC CSD Technical Support Center offers technical support by email over the Internet network if you have a modem. The Internet address is:

tech-support@neccsd.com

You can also fax technical questions to the NEC CSD Technical Support Center if you have access to a fax machine or fax/modem. The fax number is:

(801) 981-3133

When using the email or fax support service, you should include the following words in the subject field for prompt response from the appropriate technical person:

- Desktop
- Monitor
- CD-ROM
- Printer
- Notebook.

You should provide as much specific information about your questions as possible. Also, if you are sending a fax, please include your voice telephone number and your fax number with the question. You will receive a response to your questions within one business day.

NEC CSD Bulletin Board System

If you have access to a modem, you can use the NEC CSD Bulletin Board System (BBS) to get the latest information on hardware and software. The BBS allows you to download files (video drivers, printer drivers, BIOS updates, etc.) to a diskette for system enhancements and upgrades.



CAUTION

NEC CSD recommends that you download files from a Bulletin Board System to a diskette and not to your hard drive.

6-4 Getting Services and Support

Log onto the BBS as follows.

1. From the Windows desktop, click the **Start** button.
2. Point to **Programs**. Point to **Accessories** and then click **HyperTerminal**.
3. Double click the **Hypertrm.exe** icon. The HyperTerminal program appears.
4. Follow the instructions on the screen to set up your modem. Click the **HyperTerminal** help button for information about dialing the phone number.

If you need to check communications settings, check that the settings match the following BBS parameters.

- **Baud rate:** select any baud rate that matches your modem
 - **Parity:** none
 - **Data bits:** 8
 - **Stop bits:** 1
 - **Flow control:** Xon/Xoff (select Hardware if using 14.4 Kbps or higher).
5. Following the HyperTerminal instructions, enter the BBS phone number (**916-379-4499**). Your business phone system and/or location might require a **9 1** or **1** prefix.

 **Note:** The first time that you use the BBS, you are requested to provide information for a new user questionnaire.

6. Press **Enter** twice.

-
7. Enter your first name, last name, and password. Press **Enter** after each.
 8. Follow the screen prompts until the Main Menu is displayed.
 9. At the Main Menu, select **J** to join a conference. Select **Conference 1** for the desktop conference.
 10. From the Main Menu, press **F** and **Enter** for the File menu.
 11. At the File menu, select **F** for a list of downloadable files. Follow the prompts to select a file for downloading.



CAUTION

Executable files automatically format your diskette when you download files from the BBS. Formatting destroys any data on the diskette. Before you download files from the BBS, check that you do not have information on the diskette that you need.

After you complete downloading your file, log off the BBS as follows:

1. Press **Enter** (to continue).
2. Press **G** (command for Goodbye/Hangup).
3. Press **Enter**.

6-6 Getting Services and Support

NEC CSD Technical Support Services

NEC CSD also offers direct technical support through its Technical Support Center. (NEC CSD technical support is for U.S. and Canadian customers only; international customers should check with their sales provider.)

Direct assistance is available 24 hours a day, 7 days a week. Call the NEC CSD Technical Support Center, toll free, at **1-800-632-4525** (U.S. and Canada only) for the following support.

- System hardware — toll-free phone support is limited to the length of the standard warranty.

For hardware support after the standard warranty, get system hardware support for a fee.

- Preinstalled software — toll-free phone support for 90 days from the time of your first call to the NEC CSD Technical Support Center.

After the initial 90 days, get preinstalled software support for a fee.

Please have available your system's name, model number, serial number, and as much information as possible about your system's problem before calling.

For outside the U.S. and Canada, please contact your local NEC CSD sales provider.

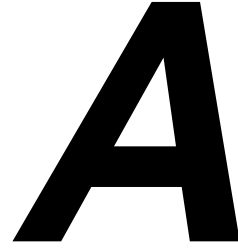

Setting Up a Healthy Work Environment

- Making Your Computer Work for You
- Arrange Your Equipment
- Adjust Your Chair
- Adjust Your Input Devices
- Adjust Your Monitor
- Vary Your Workday
- Pre-existing Conditions and Psychosocial Factors
- Checking Your Comfort: How Do You Measure Up?

 **WARNING**

Prolonged or improper use of a computer workstation may pose a risk of serious injury. To reduce your risk of injury, set up and use your computer in the manner described in this appendix.

Contact a doctor if you experience pain, tenderness, swelling, burning, cramping, stiffness, throbbing, weakness, soreness, tingling and/or numbness in the hands, wrists, arms, shoulders, neck, back, and/or legs.

Making Your Computer Work for You

Computers are everywhere. More and more people sit at computers for longer periods of time. This appendix explains how to set up your computer to fit your physical needs. This information is based on ergonomics — the science of making the workplace fit the needs of the worker.

Some nerve, tendon, and muscle disorders (musculoskeletal disorders) may be associated with repetitive activities, improper work environments, and incorrect work habits. Examples of musculoskeletal disorders that may be associated with certain forms of repetitive activities include: carpal tunnel syndrome, tendinitis, tenosynovitis, de Quervain's tenosynovitis, and trigger finger, as well as other nerve, tendon, and muscle disorders.

A-2 Setting Up a Healthy Work Environment

Although some studies have shown an association between increasing hours of keyboard use and the development of some musculoskeletal disorders, it is still unclear whether working at a computer causes such disorders. Some doctors believe that using the keyboard and mouse may aggravate existing musculoskeletal disorders.

Some people are more susceptible to developing these disorders due to preexisting conditions or psychosocial factors (see “Preexisting Conditions and Psychosocial Factors” later in the appendix).

To reduce your risk of developing these disorders, follow the instructions in this appendix. If you experience discomfort while working at your computer or afterwards, even at night, contact a doctor as soon as possible. Signs of discomfort might include pain, tenderness, swelling, burning, cramping, stiffness, throbbing, weakness, soreness, tingling and/or numbness in the hands, wrists, arms, shoulders, neck, back, and/or legs.

Arrange Your Equipment

Arrange your equipment so that you can work in a natural and relaxed position. Place items that you use frequently within easy reach. Adjust your workstation setup to the proper height (as described in this appendix) by lowering the table or stand that holds your computer equipment or raising the seat height of your chair. To create more desk space, you can put your computer base on the floor.

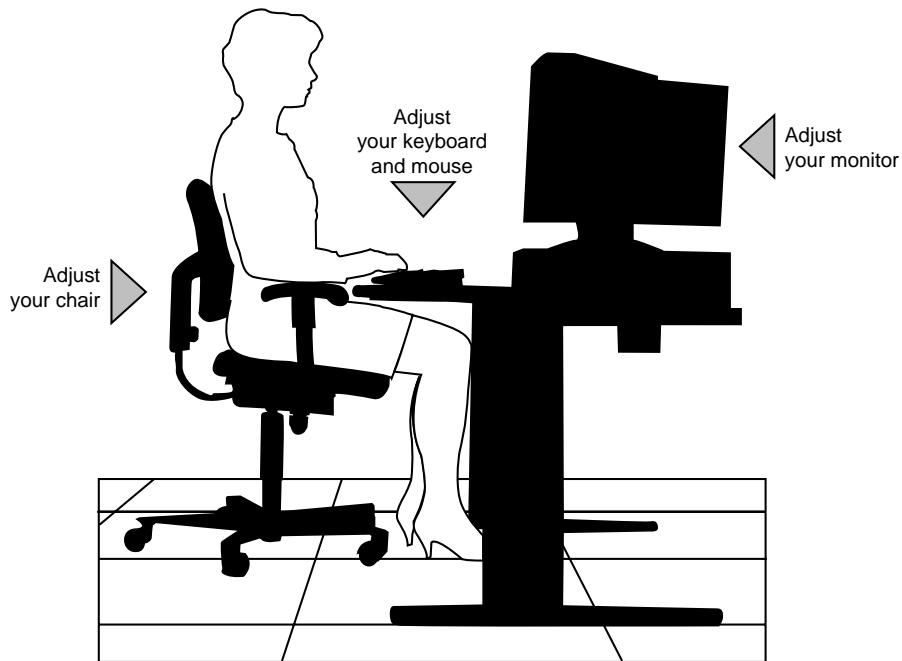

Adjust Your Chair

Your chair should be adjustable and stable. Vary your posture throughout the day.



Check the following:

- Keep your body in a relaxed yet upright position. The backrest of your chair should support the inward curve of your back.
- Use the entire seat and backrest to support your body. Tilt the backrest slightly backwards. The angle formed by your thighs and back should be 90° or more.

-
- Your seat depth should allow your lower back to comfortably contact the backrest. Make sure that the backs of your lower legs do not press against the front of the chair.
 - Extend your lower legs slightly so that the angle between your thighs and lower legs is 90° or more.
 - Place your feet flat on the floor. Only use a footrest when attempts to adjust your chair and workstation fail to keep your feet flat.
 - Be sure that you have adequate clearance between the top of your thighs and the underside of your workstation.
 - Use armrests or forearm supports to support your forearms. If adjustable, the armrests or forearm supports should initially be lowered while all the other adjustments discussed in this appendix are made. Once all these adjustments are completed, raise the armrests or adjust the forearm supports until they touch the forearms and allow the shoulder muscles to relax.

A-6 *Setting Up a Healthy Work Environment*

Adjust Your Input Devices

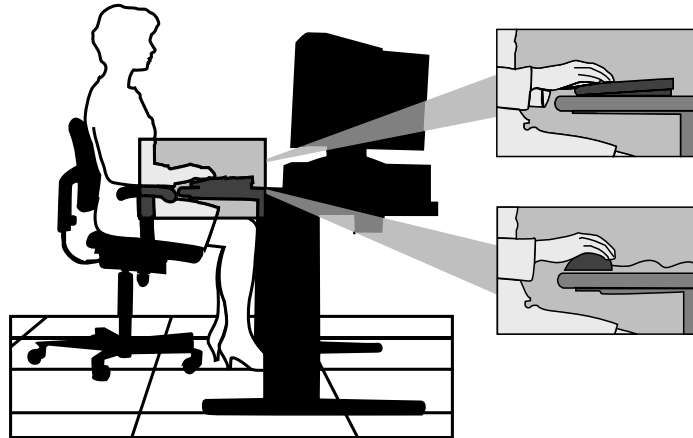

Follow these points in positioning your keyboard and mouse.

- Position your keyboard directly in front of you. Avoid reaching when using your keyboard or mouse.
- If you use a mouse, position it at the same height as the keyboard and next to the keyboard. Keep your wrists straight and use your entire arm when moving a mouse. Do not grasp the mouse tightly. Grasp the mouse lightly and loosely.
- Adjust the keyboard height so that your elbows are near your body and your forearms are parallel to the floor, with your forearms resting on either armrests or forearm supports, in the manner described previously. If you do not have armrests or forearm supports, your upper arms should hang comfortably at your sides.
- Adjust your keyboard slope so that your wrists are straight while you are typing.

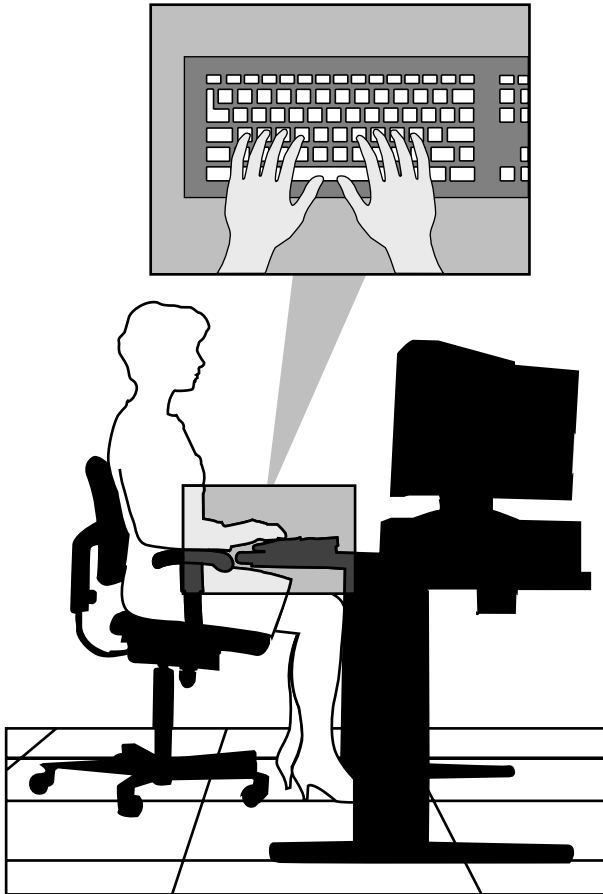

- Type with your hands and wrists floating above the keyboard. Use a wrist pad only to rest your wrists between typing. Avoid resting your wrists on sharp edges.
- Type with your wrists straight. Instead of twisting your wrists sideways to press hard-to-reach keys, move your whole arm. Keep from bending your wrists, hands, or fingers sideways.
- Press the keys gently; do not bang them. Keep your shoulders, arms, hands, and fingers relaxed.

A-8 *Setting Up a Healthy Work Environment*

Adjust Your Monitor

Correct placement and adjustment of the monitor can reduce eye, shoulder, and neck fatigue. Check the following when you position the monitor.

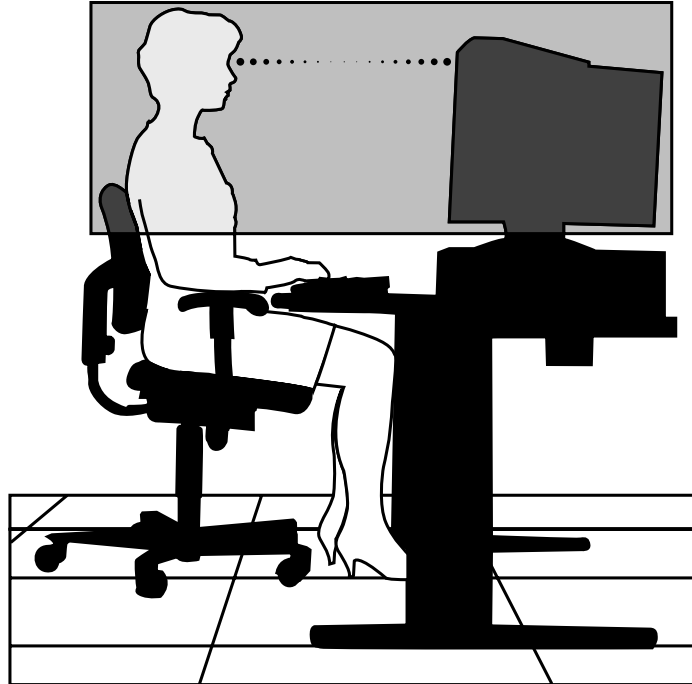

- Adjust the monitor height so that the top of the screen is at or slightly below eye level. Your eyes should look slightly downward when viewing the middle of the screen.
- Position your monitor no closer than 12 inches and no farther away than 28 inches from your eyes. The optimal distance is between 14 and 18 inches.
- Rest your eyes periodically by focusing on an object at least 20 feet away. Blink often.

-
- Position the monitor at a 90° angle to windows and other light sources to minimize glare and reflections. Adjust the monitor tilt so that ceiling lights do not reflect on your screen.
 - If reflected light makes it hard for you to see your screen, use an anti-glare filter.
 - Clean your monitor regularly. Use a lint-free, non-abrasive cloth and a non-alcohol, neutral, non-abrasive cleaning solution or glass cleaner to minimize dust.
 - Adjust the monitor's brightness and contrast controls to enhance readability.
 - Use a document holder placed close to the screen.
 - Position whatever you are looking at most of the time (the screen or reference material) directly in front of you to minimize turning your head while you are typing.
 - Get regular eye check-ups.

Vary Your Workday

If you use your computer for prolonged periods, follow these instructions.

- Vary your tasks throughout the day.
- Take frequent short breaks that involve walking, standing, and stretching. During these breaks, stretch muscles and joints that were in one position for an extended period of time. Relax muscles and joints that were active.
- Use a timer or reminder software to remind you to take breaks.

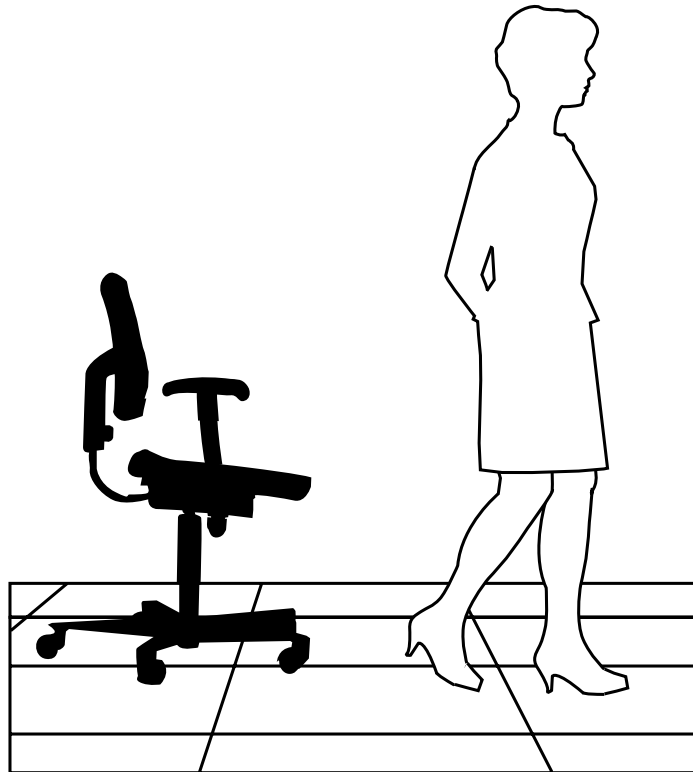

-
- To enhance blood circulation, alter your sitting posture periodically and keep your hands and wrists warm.

 **Note:** For more information on workstation setup, see the American National Standard for Human Factors Engineering of Visual Display Terminal Workstations. ANSI/HFS Standard No. 100-1988. The Human Factors Society, Inc., P.O. Box 1369, Santa Monica, California 90406.

Pre-existing Conditions and Psychosocial Factors

Pre-existing conditions that may cause or make some people more susceptible to musculoskeletal disorders include the following: hereditary factors, vascular disorders, obesity, nutritional deficiencies (e.g., Vitamin B deficiency), endocrine disorders (e.g., diabetes), hormonal imbalances, connective tissue disorders (e.g., arthritis), prior trauma (to the hands, wrists, arms, shoulders, neck, back, or legs), prior musculoskeletal disorders, aging, fluid retention due to pregnancy, poor physical conditioning and dietary habits, and other conditions.

Psychosocial factors associated with these disorders include: workplace stress, poor job satisfaction, lack of support by management, and/or lack of control over one's work.

Contact a doctor if you experience pain, tenderness, swelling, burning, cramping, stiffness, throbbing, weakness, soreness, tingling and/or numbness in the hands, wrists, arms, shoulders, neck, back, and/or legs.

Checking Your Comfort: How Do You Measure Up?

Use this checklist to see if you are setting up your work environment to fit your physical needs.

Checking Your Chair

- Do you sit in an upright position with the backrest supporting your lower back?
- When sitting, are your feet flat on the floor?
- Do you periodically adjust your chair and your posture?

Checking Your Keyboard

- Is your keyboard angled so your wrists are straight when you type?
- Is your keyboard directly in front of you?
- Do you avoid resting your wrists on sharp edges?
- Do you press the keys gently and not bang on them?

Checking Your Mouse

- Is your mouse at the same height as the keyboard and next to the keyboard?
- Are your wrists straight and your touch light when moving the mouse?

Checking Your Monitor

- Did you adjust your monitor so that the top of the screen is at or slightly below eye level?

-
- Do you periodically rest your eyes by blinking often or looking away from the screen?
 - Is your monitor no closer than 12 inches and no farther away than 28 inches from your eyes?
 - Do you use a document holder placed close to the screen?

Checking You

- Is your work area set up to promote a natural and relaxing working position with frequently used work items within close reach?
- Do you take frequent short breaks?
- Do you stretch and walk during your breaks?
- Do you vary your tasks during the day?
- Do you have regular eye checkups?
- Do you contact your doctor if you feel any sustained discomfort?

For more information on workstation setup, see the American National Standard for Human Factors Engineering of Visual Display Terminal Workstations. ANSI/HFS Standard No. 100-1988. The Human Factors Society, Inc., P.O. Box 1369, Santa Monica, California 90406

This appendix was prepared in consultation with Dr. David Rempel of the University of California/San Francisco Ergonomics Program and Mr. M.F. Schneider of HUMANTECH, Inc., Ann Arbor, Michigan.

B

System Specifications

- System Processor
- Memory (RAM, Cache, ROM)
- Calendar Clock
- Input/Output (I/O) Facilities
- Video Memory
- Sound System
- Fax/Modem Board
- Peripherals
- Dimensions
- Power
- Operating Environment
- Compliance

System Processor

System processor types and processor/front side bus (FSB) speeds:

Intel Celeron Processors

- 300 MHz/66 MHz FSB
- 333 MHz/66 MHz FSB
- 366 MHz/66 MHz FSB
- 400 MHz/66 MHz FSB
- 433 MHz/66 MHz FSB

Intel Pentium II Processors

- 350 MHz/100 MHz FSB
- 400 MHz/100 MHz FSB
- 450 MHz/100 MHz FSB

Intel Pentium III Processors

- 450 MHz/100 MHz FSB
- 500 MHz/100 MHz FSB
- 550 MHz/100 MHz FSB
- 600 MHz/100 MHz FSB

Processor Support

- 32-bit addressing
- 64-bit data

Secondary Cache

- Celeron Processor – 128 KB
- Pentium II and Pentium III – 512 KB

Processor Socket

- One 242-pin Slot 1 socket

Random Access Memory (RAM)

Standard RAM — minimum of 32 MB of SDRAM installed in one or two industry-standard DIMM sockets on system board.

- Total memory — support for up to 512 MB of high-speed SDRAM in two memory module sockets on system board
- DIMM speed must match or exceed processor bus speed
- Memory module type — gold-plated, non-parity, SDRAM modules
- Expansion — supports 32-MB, 64-MB, 128-MB, and 256-MB 100-MHz non-ECC DIMMs

Cache Memory

- pipelined 32-bit addressing
- 64-bit data

Read Only Memory (ROM)

Flash ROM — 2 Mbit

Calendar Clock

Year/month/day/hour/minute/second/.01 second; maintained by battery backup module

Battery type — Lithium coin cell

Input/Output (I/O) Features

Industry-standard interfaces integrated on system board:

- Parallel — bi-directional, ECP/EPP support; one 25-pin connector
- Serial — two high-speed RS-232C ports using 16550 UART, support transfer rates up to 115.2 KB per second; 9-pin connectors
- Universal Serial Bus (USB) — two USB ports support two USB peripherals directly to the system; with appropriate connector, each port supports up to 127 daisy-chained devices; supports 12 megabits (Mbs) per second
- Keyboard — PS/2-compatible, 6-pin connector (mini DIN)
- Mouse — PS/2-compatible, 6-pin connector (mini DIN)
- MIDI/Joystick — supports MIDI and joystick interfaces, 15-pin connector
- Microphone In — supports a microphone or other audio input device for recording audio information in data files, or broadcasting audio
- Line In — supports input from an external audio device
- Line Out — supports an amplified output device.

B-4 System Specifications

-
- IDE
 - dual IDE channels; each supporting two Ultra DMA IDE devices
 - CD-ROM drive and hard drive on separate channels
 - support for up to 33.3 MB/second 32-bit transfers on PCI bus
 - support for a total of four IDE devices; 40-pin connectors
 - support for PIO mode 3 and mode 4
 - Diskette drive — supports 1.44-MB diskette drive; 34-pin connector
 - CD Audio In connector
 - Modem In connector
 - Wake-On LAN
 - Four I/O bus expansion slots
 - Two dedicated 32-bit PCI slots
 - One shared PCI/ISA slot
 - One AGP dedicated slot

Video Memory

- Standard video memory — 4 MB
- Some models may come with up to 16 MB of video memory

Sound System

All systems come with audio integrated on the system board, based on Creative® ES1371/1373 audio.

- Compatible with Sound Blaster Pro™, Sound Blaster™ 2.0, MPU-401, and Microsoft® Windows Sound System™ for PC sound applications
- High quality SoundScape Wave Table Music Synthesizer
- Plug and Play PCI compatibility
- Stereo jacks — microphone in and line out
- ACPI compliant.

Fax/Modem Board

Systems might come with one of the following fax/modems.

- 3Com® USR Python V.90, 56 Kbps ISA Modem
- Winmodem V.90, 56 Kbps PCI Modem (MDM100)

Peripherals

Systems might come with one or more of the following peripherals.

Network Board

Some models may come with one of the following PCI network boards.

- 3Com Hurricane 10/100
- Intel Ethernet Pro 100
- GVC 10/100 network board

AGP Graphics Board

Systems might come with one of the following AGP graphics boards.

- ATI “Minden” RAGE IIC 4 MB AGP board
- ATI “XPERT 98” RAGE PRO 8-MB AGP board
- Diamond Viper V550 TnT 16-MB AGP board

Diskette Drive

All systems come with a Samsung Diskette Drive SFD-321B, 3 1/2-inch, 1.44 MB

- Recording capacity
 - High density mode:
 - Unformatted: 2.00/1.00 MB
 - Formatted: 1440 KB (512B 18 Sec)
720 KB (256B 18 Sec)
 - Normal density mode:
 - Unformatted: 1.00/0.50 MB
 - Formatted: 640 KB (256B 16 Sec)
20 KB (128B 16 Sec)
- Data transfer rate
 - High density mode: 500/250 Kbit/sec
 - Normal density mode: 250/125 Kbit/sec
- Disk speed — 300 rpm

Hard Drive

Hard drive types are subject to change. One of the following drives comes with the system.

- 4.3-GB Ultra DMA
- 8.4-GB Ultra DMA
- 12.9-GB Ultra DMA
- 17-GB Ultra DMA
- 20-GB Ultra DMA

CD-ROM Drive

CD-ROM drive types are subject to change. One of the following CD-ROM drives comes with the system.

- Lite-On LTN-301 32X CD-ROM drive
- NEC CDR-3000A 32X CD-ROM drive
- Lite-On LTN-382 40X CD-ROM drive (when available)

DVD-ROM Drive

Some systems may come with one of the following DVD-ROM drives.

- Hitachi GD-2500 4X DVD-ROM drive
- Hitachi 6X DVD-ROM drive (when available)

PC Card Adapter

Some models may come with the PC card adapter.

- Controller Chip VG469; Intel register, step B compatible
- Supports ISA Plug and Play
- Supports mixed voltage (3V) cards
- Vcc and Vpp Matrix: Micrel MTC2563

Zip Drive

Some models may come with an Iomega Zip 100 ATA Drive.

- Removable Zip disk capacity — 100 MB formatted
- Sustained data transfer rate up to 11.2 Mbits/sec
- Burst transfer rate up to 26.7 Mbits/sec
- Spindle speed — 2941 rpm

Tape Backup Unit

Some models may come with a Seagate CTT8000 ATAPI 8-GB mini cartridge drive.

- 900 Oe 740 Travan cartridge capacity
 - 4.0 GB (uncompressed)
 - 8.0 GB (compressed)
- Effective backup rate
 - 30 MB/min typical native
 - 45 MB/min typical compressed

Speakers

Some models may come with a Harman Kardon 10-watt speaker system.

Dimensions

System Unit

- Height — 14.04 in. (360 mm)
- Width — 7.02 in. (180 mm)
- Depth — 15.17 in. (389 mm)
- Weight — starting at 28 lb.

Keyboard

- Height — 1.6 in. (40.6 mm)
- Width — 19.0 in. (482.6 mm)
- Depth — 8.4 in. (213.3 mm)
- Weight — 3.5 to 4 lb.

Power

- Power supply — 145 Watt, 110/220 Volt switch selectable
- Power management — full-power reduction

Operating Environment

- Temperature — 50° F to 95° F (10° C to 35° C)
- Relative humidity — 20% to 80%

Compliance

Domestic: FCC CFR 47 Part 15, Subpart B
UL 1950 3rd edition

Canadian: C-UL C22.2 No.950-95
ICES-003 Issue 2, Revision 1

European: CE EMC Directive 89/336 EEC
EN55022:1993 Class B
EN50082-1:1997

CE LVD Directive 73/23 EEC
EN60950

Meets all requirements in European Waste Regulation
Ordinance for packaging and scrap.

Index

3

3 1/2-inch hard drive, installing,
4-48

5

5 1/4-inch device
installing, 4-45, 4-51

A

Adapter
PC card, 1-6
Advanced menu (BIOS), 3-11
AGP board, 1-12, 1-14
AGP graphics board
installing, 4-34
models, B-7
removing, 4-33
Application and Driver CD
using, 3-31
Audio, 1-11, 1-14, B-6
connectors, 1-9, B-4

B

Backing up
when shipping the system, 2-9
Battery
discarding, 5-13
locating, 5-12
problems, 5-3
removing, 5-13
replacing, 5-11
socket, 5-12

BIOS

flash ROM, 1-14

BIOS Setup utility

Advanced menu, 3-11
Exit menu, 3-19
Main menu, 3-6, 3-7
navigation keys, 3-7
Security menu, 3-18
starting, 3-6
uses, 3-2, 3-7

BIOS updates, 3-20

Boards

expansion, 4-29
fax/modem, B-6
modem, 1-12
network, 1-12, 4-44

Booting problems, 5-3, 5-4, 5-5

Buttons

power, 1-3
sleep, 1-3

C

Cables

CD-ROM drive, 4-37
diskette drive, 4-37, 4-40
IDE drive, 4-37, 4-41
PC card adapter, 4-37
power, 4-37, 4-41
tape backup unit, 4-37
Zip drive, 4-37

Cabling

CD-ROM drive, 4-41
diskette drive, 4-41, 4-43
IDE drive, 4-41, 4-42
PC card adapter, 4-41, 4-43
power, 4-41
storage devices, 4-41

- tape backup unit, 4-41
- Wake-On LAN, 4-44
- Zip drive, 4-41
- Cache memory specifications, B-3
- Calendar clock specifications, B-4
- CD-ROM drive, 1-5
 - cables, 4-37
 - cabling, 4-41
 - installing, 4-51
 - problems, 5-7
 - specifications, B-8
- Chair, adjusting, A-5, A-13
- Chart
 - quick reference, 2-10
- Chassis
 - features, 1-12
 - locking tab, 1-17, 4-6, 4-8
- Checking system memory, 4-15
- Cleaning
 - computer exterior, 2-8
 - keyboard, 2-8
 - monitor, 2-8
 - mouse, 5-9
- CMOS
 - clearing, 3-38
 - restoring settings, 3-36
- Compliance specifications, B-11
- Configuration
 - BIOS Setup utility, 3-5
 - FLASH utility, 3-20
- Connectors
 - audio, 1-9
 - external, 1-8
 - fax/modem, 1-9
 - keyboard port, 1-8
 - LAN, 1-9
 - line in, 1-9
 - line out, 1-9
 - microphone in, 1-9
 - MIDI/joystick, 1-9
 - mouse port, 1-8
 - network, 2-2
 - printer port, 1-8
 - RJ-45, 2-2
 - serial ports, 1-8
 - USB port, 1-8
- Controls, system unit, 1-3
- Cover removal
 - left side cover, 4-5
 - right side cover, 4-9
 - system unit, 4-4
- Cover replacement
 - left side cover, 4-7
 - right side cover, 4-11

D

- Data storage devices, 4-35
- Date
 - incorrect, 5-3
- Device bay, 4-51
- Devices
 - data storage, 4-35
- DIMMs
 - double sided, 4-14
 - installing, 4-17
 - removing, 4-16
 - single sided, 4-14
 - size, 4-14
 - speed, 4-14
 - type, 4-14
 - upgrading, 4-13, 4-16
- Disk error problems, 5-3, 5-5
- Disk lamp, 1-4
- Diskette
 - flash, 3-20
- Diskette drive, 1-4

Index-2

-
- cable, 4-37, 4-40
 - cabling, 4-41, 4-43
 - problems, 5-4
 - specifications, B-7
 - Documentation, online
 - Healthy Environment, 1-16
 - NEC Help Center, 1-16, 3-34
 - Drive bay, 4-51
 - Drives
 - CD-ROM, 1-5
 - diskette, 1-4
 - DVD-ROM, 1-5
 - installing, 4-48, 4-51
 - LS-120 SuperDisk, 1-6
 - tape backup, 1-5
 - Zip, 1-6
 - DVD-ROM drive, 1-5
 - installing, 4-51
 - E**
 - Ergonomics, A-1, A-12
 - chair adjustments, A-5, A-13
 - keyboard adjustments, A-7, A-13
 - monitor adjustments, A-9, A-13
 - mouse adjustments, A-7, A-13
 - workspace setup, A-4
 - Exit menu (BIOS), 3-19
 - Expansion boards
 - installing, 4-29, 4-31
 - removing, 4-33
 - Exterior, cleaning, 2-8
 - External connectors, 1-8
 - F**
 - Fan, 1-10
 - Fax/modem
 - board specifications, B-6
 - port, 1-9
 - setup, 2-2
 - Features
 - front, 1-2
 - hardware, 1-13
 - internal, 1-10
 - rear, 1-7
 - security, 1-16
 - software, 1-14
 - FLASH diskette, 3-20
 - Front cover
 - removing, 4-45
 - replacing, 4-48
 - replacing blank plastic panel, 4-48
 - H**
 - Hard drive
 - backing up, 2-9
 - specifications, B-8
 - upgrading, 4-48
 - Hardware, features, 1-13
 - Healthy Environment online
 - brochure, 1-16
 - Help
 - from NEC CSD dealer, 5-14
 - from your company, 5-14
 - NEC CSD repair service, 5-16
 - obtaining, 5-14
 - I**
 - IDE drive
 - cables, 4-37, 4-41
 - cabling, 4-41, 4-42
 - installing, 4-48
 - Installing
 - 3 1/2-inch hard drive, 4-48
 - 5 1/4-inch device, 4-45, 4-51
 - expansion boards, 4-29, 4-31
 - NEC Help Center, 3-34
-

J

Jumper settings
 processor speed, 3-35
 system board, 3-35

K

Keyboard
 adjusting, A-7, A-13
 cleaning, 2-8
 port, 1-8
 problems, 5-6
 setup, 2-2
 specifications, B-10

L

Lamps, 1-3
 disk, 1-4
 power, 1-3
LAN
 connector, 1-9
Line in, 1-9
Line out, 1-9
Location
 battery, 5-12
Locking tab, 1-17, 4-6, 4-8
LS-120 SuperDisk drive, 1-6

M

Main menu (BIOS), 3-6, 3-7
Master device, 4-38
Memory, 1-14
 checking, 4-15
 DIMMs, 4-13
 specifications, cache, B-3
 specifications, RAM, B-3
 specifications, ROM, B-3
 upgrade path, 4-14
 upgrading, 4-12, 4-13
Microphone in, 1-9

Microsoft Internet Explorer
 browser, 1-15

MIDI/joystick connector, 1-9

Modem board, 1-12

Monitor

 adjusting, A-9, A-13

 cleaning, 2-8

 problems, 5-5

 VGA connector, 1-8

Mouse

 adjusting, A-7, A-13

 cleaning, 5-9

 port, 1-8

 problems, 5-6

 setup, 2-2

Moving preparations, 2-9

N

NEC Application and Driver CD,
 1-15, 1-16

NEC CSD

 bulletin board system, 6-4

 email/fax service, 6-3

 FTP site, 6-3

 technical support services, 6-7

 website, 6-2

NEC CSD repair service, 5-16

NEC Help Center, 1-16, 3-33

 installing, 3-34

 uninstalling, 3-34

NEC OS Restore CD, 1-15

Netscape browser, 1-15

Network board, 1-12

 specifications, B-6

Network board cabling, 4-44

Network setup, 2-2

-
- O**
- Online documentation
 - Healthy Environment, 1-16
 - NEC Help Center, 1-16, 3-34
 - Operating environment
 - specifications, B-10
 - Operating system
 - Windows 95 or Windows 98, 1-14
 - Windows NT, 1-14
 - Options
 - general rules for installing, 4-2
 - removing left side cover, 4-5, 4-9
 - removing right side cover, 4-9
 - removing system covers, 4-4
 - replacing left side cover, 4-7
 - replacing right side cover, 4-11
 - safety precautions, 4-3
 - OS Restore CD, 3-21
- P**
- Password
 - problems, 5-4
 - PC card adapter, 1-6
 - cable, 4-37
 - cabling, 4-41, 4-43
 - installing, 4-51
 - specifications, B-9
 - PC98 compliance, 1-13
 - Performance problems, 5-4
 - Ports
 - USB, 1-4
 - Power
 - button, 1-3
 - cables, 4-37, 4-41
 - cabling, 4-41
 - lamp, 1-3
 - management, 1-14
 - problems, 5-2
 - saving mode, 2-5
 - setup, 2-3
 - Sleep mode, 2-6
 - socket, 1-10
 - specifications, B-10
 - Power mode
 - setting, 3-40
 - Power supply
 - fan, 1-10
 - voltage selector switch, 1-10
 - Preparing the system for shipment, 2-9
 - Primary device, 4-38
 - Printer port, 1-8
 - Problems, 5-2
 - booting, 5-3, 5-4, 5-5
 - CD-ROM drive, 5-7
 - common, 5-2
 - date, incorrect, 5-3
 - disk error, 5-3, 5-5
 - diskette drive, 5-4
 - keyboard/mouse, 5-6
 - low battery, 5-3
 - monitor, 5-5
 - password, 5-4
 - performance, 5-4
 - power, 5-2
 - speakers, 5-8
 - system, 5-2
 - time, incorrect, 5-3
 - Processor
 - upgrading, 4-12
 - Processor installation
 - Celeron, 4-22
 - Pentium II, 4-26
 - Pentium III, 4-22
 - Processor removal
 - Celeron, 4-20
-

-
- Pentium II, 4-24
 - Pentium III, 4-20
 - Processor speed
 - jumper settings, 3-35
 - Processors, 1-13
 - Q**
 - Quick reference chart, 2-10
 - R**
 - Random access memory
 - specifications, B-3
 - Read only memory
 - specifications, B-3
 - Removing
 - battery, 5-13
 - expansion board, 4-33
 - Repair service, 5-16
 - Replacing
 - 3 1/2-inch hard drive, 4-48
 - 5 1/4-inch device, 4-45, 4-51
 - battery, 5-11
 - hard drive, 4-48
 - RJ-45 connector, 2-2
 - S**
 - Safety precautions, 4-3
 - before shipping, 2-9
 - SCSI device
 - installing, 4-51
 - Secondary cache
 - specifications, B-3
 - Secondary device, 4-38
 - Security, 1-16
 - chassis locking tab, 1-17, 4-6, 4-8
 - password, 1-16
 - Windows, 1-17
 - Security menu (BIOS), 3-18
 - Serial ports, 1-8
 - Setup
 - fax/modem, 2-2
 - keyboard, 2-2
 - mouse, 2-2
 - network, 2-2
 - power, 2-3
 - shutdown, 2-4
 - voltage selector switch, 2-3
 - Setup utility. *See* BIOS Setup utility.
 - Shipping, 2-9
 - preparations, 2-9
 - Slave device, 4-38
 - Sleep button, 1-3
 - Software features, 1-14
 - Sound system specifications, B-6
 - Speakers, 1-13
 - AC adapter, 1-13
 - problems, 5-8
 - specifications, B-10
 - Specifications
 - cache memory, B-3
 - calendar clock, B-4
 - CD-ROM drive, B-8
 - compliance, B-11
 - diskette drive, B-7
 - DVD-ROM drive, B-8
 - fax/modem board, B-6
 - hard drive, B-8
 - keyboard, B-10
 - operating environment, B-10
 - PC card adapter, B-9
 - power, B-10
 - Random Access Memory (RAM), B-3
 - read only memory (ROM), B-3
 - secondary cache, B-3
 - sound system, B-6

-
- Speakers, B-10
 - system unit dimensions, B-10
 - tape backup unit, B-9
 - Zip drive, B-9
 - Speed
 - DIMM, 4-14
 - Starting BIOS Setup utility, 3-6
 - Startup
 - power on, 2-3
 - Storage device
 - support, 1-12
 - Storage device installation, 4-35
 - cables, 4-37
 - device bays, 4-35
 - device preparation, 4-37
 - Storage devices
 - installation, 4-45
 - System
 - problems, 5-2
 - specifications, B-10
 - System board
 - jumper settings, 3-35
 - locating jumpers, 3-36
 - locations of sockets and connectors, 4-12
 - options, 4-12
 - System care
 - maintaining condition, 2-8
 - protecting from damage, 2-6
 - System fan, 1-10
 - System memory, 1-14
 - checking, 4-15
 - System unit
 - cleaning, 2-8
 - T**
 - Tape backup unit, 1-5
 - cables, 4-37
 - cabling, 4-41
 - installing, 4-51
 - specifications, B-9
 - Time
 - incorrect, 5-3
 - Troubleshooting, 5-2
 - battery, 5-3
 - booting, 5-3, 5-4, 5-5
 - CD-ROM drive, 5-7
 - common problems, 5-2
 - date, incorrect, 5-3
 - disk error, 5-3, 5-5
 - diskette drive, 5-4
 - keyboard/mouse, 5-6
 - monitor, 5-5
 - password, 5-4
 - performance problems, 5-4
 - power, 5-2
 - speakers, 5-8
 - system problems, 5-2
 - time, incorrect, 5-3
 - U**
 - Uninstalling, NEC Help Center, 3-34
 - Upgrading
 - BIOS, 3-20
 - DIMMs, 4-13
 - hard drive, 4-48
 - memory, 4-12, 4-13
 - processor, 4-12
 - USB
 - ports, 1-4
 - USB port, 1-8
 - V**
 - VGA connector
 - monitor, 1-8
 - Voltage selector switch, 1-10
 - setup, 2-3

W

Wake-On LAN

cabling, 4-44

Windows 95 or Windows 98,
1-14

Windows NT, 1-14

Z

Zip drive, 1-6

cables, 4-37

cabling, 4-41

installing, 4-51

specifications, B-9

(For United States Use Only)

**Federal Communications Commission
Radio Frequency Interference Statement**

WARNING: Changes or modifications to this unit not expressly approved by the party responsible for compliance could void the user's authority to operate the equipment.

NOTE: This equipment has been tested and found to comply with the limits for a Class B digital device, pursuant to Part 15 of the FCC Rules. These limits are designed to provide reasonable protection against harmful interference in a residential installation. This equipment generates, uses and can radiate radio frequency energy and, if not installed and used in accordance with the instructions, may cause harmful interference to radio communications.

However, there is no guarantee that interference will not occur in a particular installation. If this equipment does cause harmful interference to radio or television reception, which can be determined by turning the equipment off and on, the user is encouraged to try to correct the interference by one or more of the following measures.

- Reorient or relocate the receiving antenna.
- Increase the separation between the equipment and receiver.
- Connect the equipment to an outlet on a circuit different from the one to which the receiver is connected.

Use shielded and properly grounded I/O cables and power cable to ensure compliance of this unit to the specified limits of the rules.

(For Canadian Use Only)

This Class B digital apparatus meets all requirements of the Canadian Interference-Causing Equipment Regulations. _____

Cet appareil numérique de la classe B respecte toutes les exigences du Règlement sur le matériel brouilleur du Canada.

Battery Replacement

A lithium battery in some computers maintains system configuration information. In the event that the battery fails to maintain system configuration information, NEC recommends that you replace the battery. For battery replacement information, see “Battery Replacement” in Chapter 5 of this guide or call your NEC CSD dealer or the NEC CSD Technical Support Center.

WARNING: There is a danger of explosion if the battery is incorrectly replaced. Replace only with the same or equivalent type recommended by the manufacturer. Discard used batteries according to the manufacturer’s instructions.

ADVERTISSEMENT: Il y a danger d’explosion s’il y a remplacement incorrect de la batterie. Remplacer uniquement avec une batterie du même type ou d’un type recommandé par le constructeur. Mettre au rebut les batteries usagées conformément aux instructions du fabricant.

Battery Disposal

Do not place used batteries in your regular trash.

The nickel-cadmium or nickel metal-hydrate batteries must be collected, recycled, or disposed of in an environmentally-approved manner.

The incineration, landfilling, or mixing of batteries with the municipal solid waste stream is **prohibited by law** in most areas.

Return batteries to a federal or state approved battery recycler. This may be where you purchased the battery or a local seller of automotive batteries.

Contact your local waste management officials for other information regarding the environmentally sound collection, recycling, and disposal of the batteries.

NEC Computer Systems Division,
A Division of Packard Bell NEC, Inc.

DECLARATION OF CONFORMITY

We, the Responsible Party

NEC Computer Systems Division
6000 Florin-Perkins Road
Sacramento, CA 95828-1037
(916) 388-0101

declare that the product

NEC

POWERMATE VT 300

is in conformity with part 15 of the FCC Rules.
Operation of this product is subject to the following
two conditions: (1) this device may not cause harmful
interference, and (2) this device must accept any
interference received, including interference that may
cause undesired operation.

Free Manuals Download Website

<http://myh66.com>

<http://usermanuals.us>

<http://www.somanuals.com>

<http://www.4manuals.cc>

<http://www.manual-lib.com>

<http://www.404manual.com>

<http://www.luxmanual.com>

<http://aubethermostatmanual.com>

Golf course search by state

<http://golfingnear.com>

Email search by domain

<http://emailbydomain.com>

Auto manuals search

<http://auto.somanuals.com>

TV manuals search

<http://tv.somanuals.com>