

# User's Manual

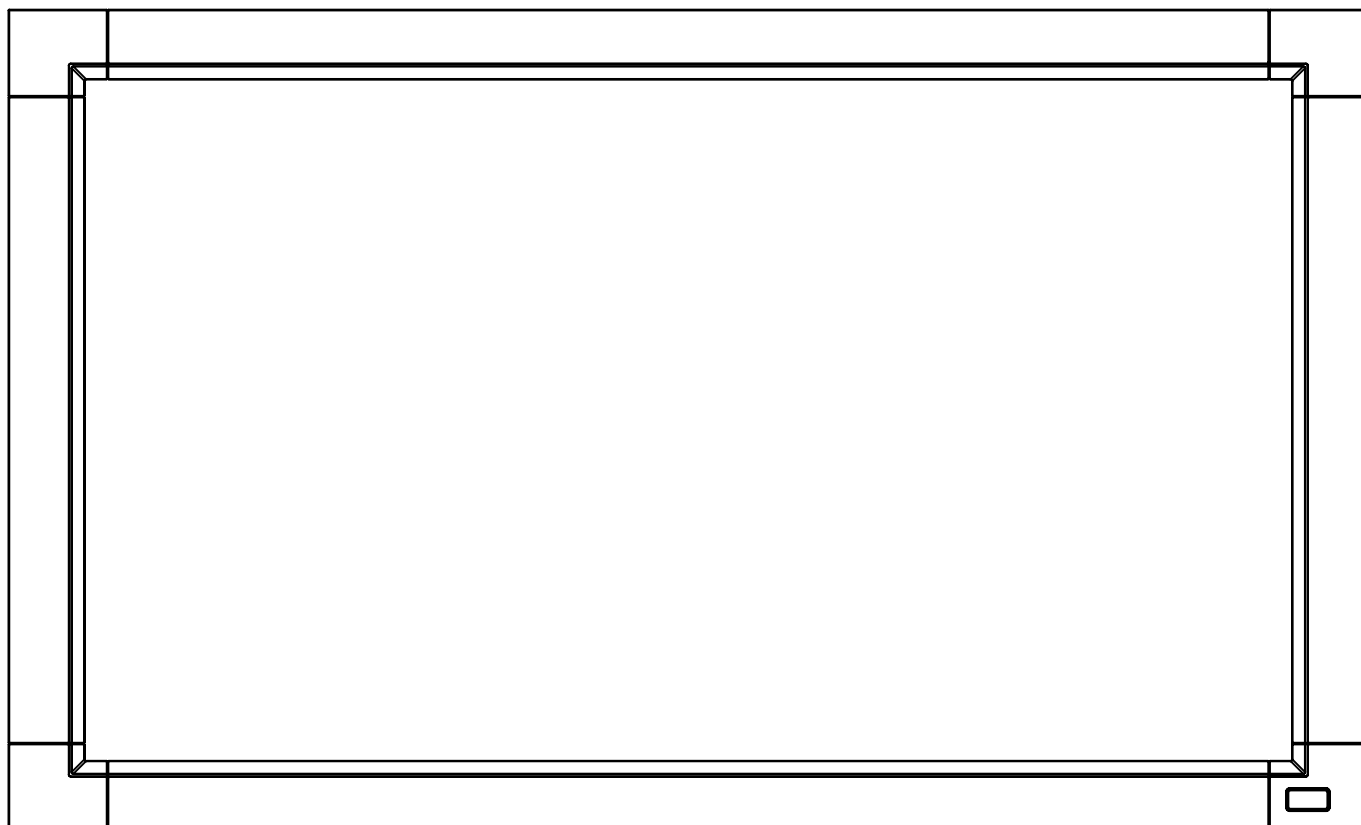

# MultiSync V321

# MultiSync V461

# MultiSync LCD4215<sup>(R)</sup>

# Index

---

Important Information .....	English-1
Warning, Caution .....	English-1
Registration Information .....	English-1
Safety Precautions, Maintenance & Recommended Use .....	English-3
Contents .....	English-4
Installation .....	English-5
Parts Name and Functions .....	English-8
Control Panel .....	English-8
Terminal Panel .....	English-9
Wireless Remote Control .....	English-10
Operating Range for the Remote Control .....	English-11
Handling the remote control .....	English-11
Setup .....	English-12
Connections .....	English-14
Wiring Diagram .....	English-14
Connecting a Personal Computer .....	English-14
Connecting a DVD Player with HDMI out .....	English-15
Basic Operation .....	English-16
Power ON and OFF Modes .....	English-16
Power Indicator .....	English-17
Using Power Management .....	English-17
Selecting a video source .....	English-17
Picture Size .....	English-17
Picture Mode .....	English-17
Information OSD .....	English-18
OSD (On-Screen-Display) Controls .....	English-18
PICTURE .....	English-19
ADJUST .....	English-19
AUDIO .....	English-20
SCHEDULE .....	English-20
PIP .....	English-20
OSD .....	English-20
MULTI DISPLAY .....	English-21
DISPLAY PROTECTION .....	English-21
ADVANCED OPTION .....	English-22
Controlling the LCD monitor via RS-232C Remote Control .....	English-24
Controlling the LCD monitor via LAN Control (V321 and V461 only) .....	English-25
Features .....	English-28
Troubleshooting .....	English-29
Specifications - V321 .....	English-30
Specifications - V461 .....	English-31
Specifications - LCD4215 <sup>(R)</sup> .....	English-32
Pin Assignment .....	English-33
Manufacturer's Recycling and Energy Information .....	English-34

# Important Information



## WARNING



TO PREVENT FIRE OR SHOCK HAZARDS, DO NOT EXPOSE THIS UNIT TO RAIN OR MOISTURE. ALSO, DO NOT USE THIS UNIT'S POLARIZED PLUG WITH AN EXTENSION CORD RECEPTACLE OR OTHER OUTLETS UNLESS THE PRONGS CAN BE FULLY INSERTED.

REFRAIN FROM OPENING THE CABINET AS THERE ARE HIGH VOLTAGE COMPONENTS INSIDE. REFER SERVICING TO QUALIFIED SERVICE PERSONNEL.



## CAUTION



**CAUTION:** TO REDUCE THE RISK OF ELECTRIC SHOCK, MAKE SURE POWER CORD IS UNPLUGGED FROM WALL SOCKET. TO FULLY DISENGAGE THE POWER TO THE UNIT, PLEASE DISCONNECT THE POWER CORD FROM THE AC OUTLET. DO NOT REMOVE COVER (OR BACK). NO USER SERVICEABLE PARTS INSIDE. REFER SERVICING TO QUALIFIED SERVICE PERSONNEL.



This symbol warns user that uninsulated voltage within the unit may have sufficient magnitude to cause electric shock. Therefore, it is dangerous to make any kind of contact with any part inside this unit.



This symbol alerts the user that important literature concerning the operation and maintenance of this unit has been included. Therefore, it should be read carefully in order to avoid any problems.

**CAUTION:** Please use the power cord provided with this display in accordance with the table below. If a power cord is not supplied with this equipment, please contact your supplier. For all other cases, please use a power cord that matches the AC voltage of the power outlet and has been approved by and complies with the safety standard of your particular country.

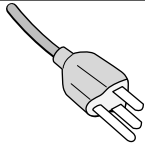
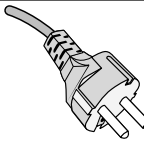
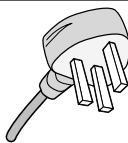
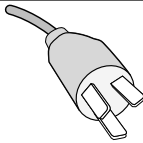
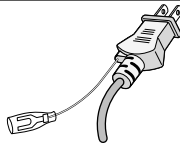
Plug Type	North America	European Continental	U.K.	Chinese	Japanese
Plug Shape					
Region	U.S.A./Canada	EU (except U.K.)	U.K.	China	Japan
Voltage	120*	230	230	220	100

\*When operating the MultiSync LCD monitor with its AC 125-240V power supply, use a power supply cord that matches the power supply voltage of the AC power outlet being used.

**NOTE:** This product can only be serviced in the country where it was purchased.

# Registration Information

## Declaration

### Declaration of the Manufacturer

We hereby certify that the color monitor MultiSync V321 (L329N8)/MultiSync V461 (L469NA)/MultiSync LCD4215 (L429N9) are in compliance with

Council Directive 2006/95/EC:  
– EN 60950-1

Council Directive 2004/108/EC:  
– EN 55022  
– EN 61000-3-2  
– EN 61000-3-3  
– EN 55024

and marked with



NEC Display Solutions, Ltd.  
4-13-23, Shibaura,  
Minato-Ku  
Tokyo 108-0023, Japan

# Canadian Department of Communications Compliance Statement

**DOC:** This Class B digital apparatus meets all requirements of the Canadian Interference-Causing Equipment Regulations.

**C-UL:** Bears the C-UL Mark and is in compliance with Canadian Safety Regulations according to CAN/CSA C22.2 No. 60950-1.

## FCC Information

1. Use the attached specified cables with the MultiSync V321 (L329N8)/MultiSync V461 (L469NA)/MultiSync LCD4215 (L429N9) color monitor so as not to interfere with radio and television reception.
  - (1) Please use the supplied power cord or equivalent to ensure FCC compliance.
  - (2) Please use the supplied shielded video signal cable, Mini D-SUB 15 pin to Mini D-SUB 15 pin.
2. This equipment has been tested and found to comply with the limits for a Class B digital device, pursuant to part 15 of the FCC Rules. These limits are designed to provide reasonable protection against harmful interference in a residential installation. This equipment generates, uses, and can radiate radio frequency energy, and, if not installed and used in accordance with the instructions, may cause harmful interference to radio communications. However, there is no guarantee that interference will not occur in a particular installation. If this equipment does cause harmful interference to radio or television reception, which can be determined by turning the equipment off and on, the user is encouraged to try to correct the interference by one or more of the following measures:
  - Reorient or relocate the receiving antenna.
  - Increase the separation between the equipment and receiver.
  - Connect the equipment into an outlet on a circuit different from that to which the receiver is connected.
  - Consult your dealer or an experienced radio/TV technician for help.

If necessary, the user should contact the dealer or an experienced radio/television technician for additional suggestions. The user may find the following booklet, prepared by the Federal Communications Commission, helpful: "How to Identify and Resolve Radio-TV Interference Problems." This booklet is available from the U.S. Government Printing Office, Washington, D.C., 20402, Stock No. 004-000-00345-4.

## Declaration of Conformity

This device complies with Part 15 of FCC Rules. Operation is subject to the following two conditions. (1) This device may not cause harmful interference, and (2) this device must accept any interference received, including interference that may cause undesired operation.

<b>U.S. Responsible Party:</b>	<b>NEC Display Solutions of America, Inc.</b>
<b>Address:</b>	<b>500 Park Boulevard, Suite 1100 Itasca, Illinois 60143</b>
<b>Tel. No.:</b>	<b>(630) 467-3000</b>

Type of Product:	Display Monitor
Equipment Classification:	Class B Peripheral
Model:	MultiSync V321 (L329N8) MultiSync V461 (L469NA) MultiSync LCD4215 (L429N9)



*We hereby declare that the equipment specified above conforms to the technical standards as specified in the FCC Rules.*

---

Windows is a registered trademark of Microsoft Corporation. NEC is a registered trademark of NEC Corporation. All other brands and product names are trademarks or registered trademarks of their respective owners.



HDMI, the HDMI logo and High-Definition Multimedia Interface are trademarks or registered trademarks of HDMI Licensing LLC.

# Safety Precautions, Maintenance & Recommended Use

FOR OPTIMUM PERFORMANCE, PLEASE NOTE THE FOLLOWING WHEN SETTING UP AND USING THE MULTI-FUNCTION MONITOR:

- **DO NOT OPEN THE MONITOR.** There are no user serviceable parts inside and opening or removing covers may expose you to dangerous shock hazards or other risks. Refer all servicing to qualified service personnel.
- Do not spill any liquids into the cabinet or use your monitor near water.
- Do not insert objects of any kind into the cabinet slots, as they may touch dangerous voltage points, which can be harmful or fatal or may cause electric shock, fire or equipment failure.
- Do not place any heavy objects on the power cord. Damage to the cord may cause shock or fire.
- Do not place this product on a sloping or unstable cart, stand or table, as the monitor may fall, causing serious damage to the monitor.
- The power supply cord you use must have been approved by and comply with the safety standards of your country. (Type H05VV-F 3G 1mm<sup>2</sup> should be used in Europe)
- In UK, use a BS-approved power cord with molded plug having a black (13A) fuse installed for use with this monitor.
- Do not place any objects onto the monitor and do not use the monitor outdoors.
- The lamps in this product contain mercury. Please dispose according to state, local or federal law.
- Do not bend, crimp or otherwise damage the power cord.
- If glass is broken, handle with care.
- Do not cover vent on monitor.
- Do not use monitor in high temperature, humid, dusty, or oily areas.
- If monitor or glass is broken, do not come in contact with the liquid crystal and handle with care.
- Allow adequate ventilation around the monitor, so that heat can properly dissipate. Do not block ventilated openings or place the monitor near a radiator or other heat sources. Do not put anything on top of the monitor.
- The power cable connector is the primary means of detaching the system from the power supply. The monitor should be installed close to a power outlet, which is easily accessible.
- Do not move or mount this product by hanging a rope or wire to the backside handle. Do not mount or secure this product by using the backside handle. It may fall and cause personal injury.
- Handle with care when transporting. Save packaging for transporting.
- Do not touch LCD panel surface while transporting, mounting and setting. Applying pressure on the LCD panel can cause serious damage.
- Please clean the holes of back cabinet to reject dirt and dust at least once a year because of set reliability.
- If using the cooling fan continuously, it's recommended to wipe holes a minimum of once a month.
- When using a LAN cable, do not connect to a peripheral device with wiring that might have excessive voltage.

Immediately unplug your monitor from the wall outlet and refer servicing to qualified service personnel under the following conditions:

- When the power supply cord or plug is damaged.
- If liquid has been spilled, or objects have fallen into the monitor.
- If the monitor has been exposed to rain or water.
- If the monitor has been dropped or the cabinet damaged.
- If you notice any structural damage such as cracks or unnatural wobbling.
- If the monitor does not operate normally by following operating instructions.

## Recommended Use

- For optimum performance, allow 20 minutes for warm-up.
- Rest your eyes periodically by focusing on an object at least 5 feet away. Blink often.
- Position the monitor at a 90° angle to windows and other light sources to minimize glare and reflections.
- Clean the LCD monitor surface with a lint-free, non-abrasive cloth. Avoid using any cleaning solution or glass cleaner!
- Adjust the monitor's brightness, contrast and sharpness controls to enhance readability.
- Avoid displaying fixed patterns on the monitor for long periods of time to avoid image persistence (after image effects).
- Get regular eye checkups.

## Ergonomics

To realize the maximum ergonomic benefits, we recommend the following:

- Use the preset Size and Position controls with standard signals.
- Use the preset Color Setting.
- Use non-interlaced signals.
- Do not use primary color blue on a dark background, as it is difficult to see and may produce eye fatigue due to insufficient contrast.

## Cleaning the LCD Panel

- When the liquid crystal panel is stained with dust or dirt, please wipe with soft cloth gently.
- Please do not rub the LCD panel with hard material.
- Please do not apply pressure to the LCD surface.
- Please do not use OA cleaner as it will cause deterioration or discolor on the LCD surface.

## Cleaning the Cabinet

- Unplug the power supply
- Gently wipe the cabinet with a soft cloth
- To clean the cabinet, dampen the cloth with a neutral detergent and water, wipe the cabinet and follow with a dry cloth.

**NOTE:** The surface of the cabinet is composed of many types of plastic. DO NOT clean with benzene thinner, alkaline detergent, alcoholic system detergent, glass cleaner, wax, polish cleaner, soap powder, or insecticide. Rubber or vinyl should not be in contact with the cabinet for an extended period of time. These types of fluids and materials can cause the paint to deteriorate, crack or peel.

# Contents

Your new MultiSync monitor box\* should contain the following:

- LCD monitor
- Power Cord\*<sup>1</sup>
- Video Signal Cable
- Setup Manual
- Wireless Remote Control and AAA Batteries
- Main switch cover
- Clamp x 2
- Screw for clamp (M4 x 8) x 2
- Screw for main switch cover (3 x 10) x 2
- CD-ROM

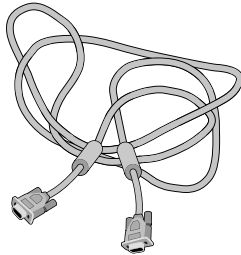

Video Signal Cable  
(Mini D-SUB 15 pin to  
Mini D-SUB 15 pin)

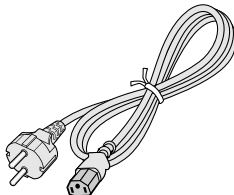

Power Cord\*<sup>1</sup>



Screw for clamp  
(M4 x 8) x 2



Screw for main switch  
cover (3 x 10) x 2



Clamp x 2

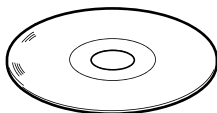

CD-ROM

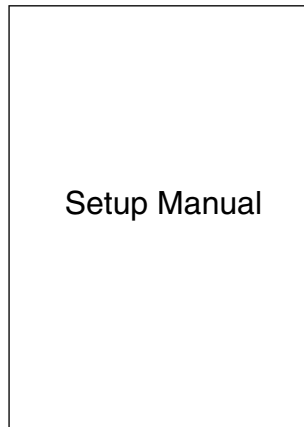

Setup Manual

Setup Manual

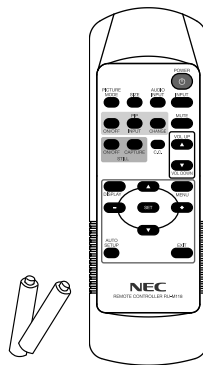

Wireless Remote Control  
and AAA Batteries

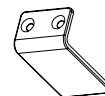

Main switch cover

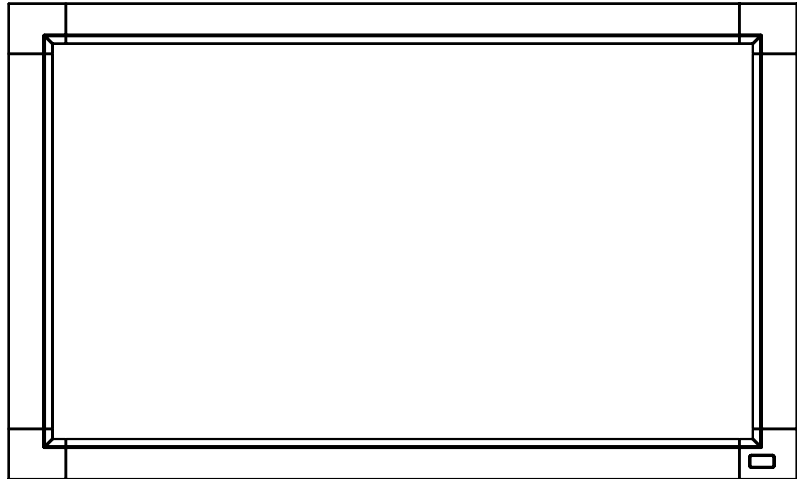

\*<sup>1</sup> Type and number of power cords included will depend on the where the LCD monitor is to be shipped. When more than one power cord is included, please use a power cord that matches the AC voltage of the power outlet and has been approved by and complies with the safety standard of your particular country.

\* Remember to save your original box and packing material to transport or ship the monitor.

# Installation

*This device cannot be used or installed without the Tabletop Stand or other mounting accessory for support. For proper installation it is strongly recommended to use a trained, NEC authorized service person. Failure to follow NEC standard mounting procedures could result in damage to the equipment or injury to the user or installer. Product warranty does not cover damage caused by improper installation. Failure to follow these recommendations could result in voiding the warranty.*

## Mounting

DO NOT mount the monitor yourself. Please ask dealer. For proper installation it is strongly recommended to use a trained, qualified technician. Please inspect the location where the unit is to be mounted. Mounting on wall or ceiling is the customer's responsibility. Not all walls or ceilings are capable of supporting the weight of the unit. Product warranty does not cover damage caused by improper installation, remodeling, or natural disasters. Failure to comply with these recommendations could result in voiding the warranty.

DO NOT block ventilated openings with mounting accessories or other accessories.

### For NEC Qualified Personnel:

To insure safe installation, use two or more brackets to mount the unit. Mount the unit to at least two points on the installation location.

## Please note the following when mounting on wall or ceiling

- When using mounting accessories other than those that are NEC approved, they must comply with the VESA-compatible (FDMLv1) mounting method.
- NEC strongly recommends using size M6 screws (9-10 mm + thickness of bracket in length). If using screws longer than 9-10 mm, check the depth of the hole. (Recommended Fasten Force: 310 - 410 N•cm) NEC recommends mounting interfaces that comply with UL1678 standard in North America.
- Prior to mounting, inspect the installation location to insure that it is strong enough to support the weight of the unit so that the unit will be safe from harm.
- Refer to the instructions included with the mounting equipment for detailed information.

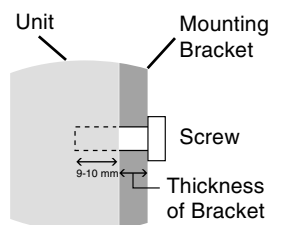

Screw length should equal depth of hole (9-10 mm) + the thickness of mounting bracket.

Weight of LCD assembly:

- MultiSync V321: 14.3 kg/31.5 lbs
- MultiSync V461: 24.0 kg/52.9 lbs
- MultiSync LCD4215<sup>(R)</sup>: 21.6 kg/47.6 lbs

## Orientation

- When using the display in the portrait position, the monitor should be rotated clockwise so that the left side is moved to the top and the LED indicator light is on the bottom. This will allow for proper ventilation and will extend the lifetime of the monitor. Improper ventilation may shorten the lifetime of the monitor.

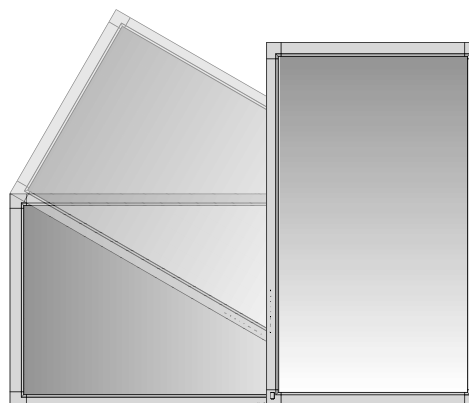

## Mounting location

- The ceiling and wall must be strong enough to support the monitor and mounting accessories.
- DO NOT install in locations where a door or gate can hit the unit.
- DO NOT install in areas where the unit will be subjected to strong vibrations and dust.
- DO NOT install near where the main power supply enters the building.
- Do not install where people can easily grab and hang onto the unit or the mounting apparatus.
- When mounting in a recessed area, as in a wall, leave at least 4 inches (10cm) of space between the monitor and the wall for proper ventilation.
- Allow adequate ventilation or provide air conditioning around the monitor, so that heat can properly dissipate away from the unit and mounting apparatus.

## Mounting on ceiling

- Ensure that the ceiling is sturdy enough to support the weight of the unit and the mounting apparatus over time, against earthquakes, unexpected vibrations, and other external forces.
- Be sure the unit is mounted to a solid structure within the ceiling, such as a support beam. Secure the monitor using bolts, spring lock washers, washer and nut.
- DO NOT mount to areas that have no supporting internal structure. DO NOT use wood screws or anchor screws for mounting. DO NOT mount the unit to trim or to hanging fixtures.

## Maintenance

- Periodically check for loose screws, gaps, distortions, or other problems that may occur with the mounting apparatus. If a problem is detected, please refer to qualified personnel for service.
- Regularly check the mounting location for signs of damage or weakness that may occur over time.

# Attaching Mounting Accessories

The display is designed for use with the VESA mounting system.

## 1. Attach Mounting Accessories

Be careful to avoid tipping monitor when attaching accessories.

### V321

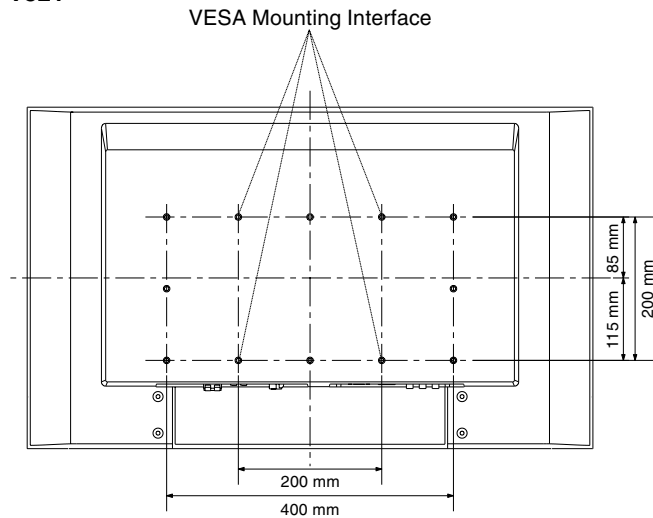

**NOTE:** Regarding VESA mounting interface patterns on V321, it is not centered over the Vertical Centerline of screen as the above figure.

### V461 and LCD4215<sup>(R)</sup>

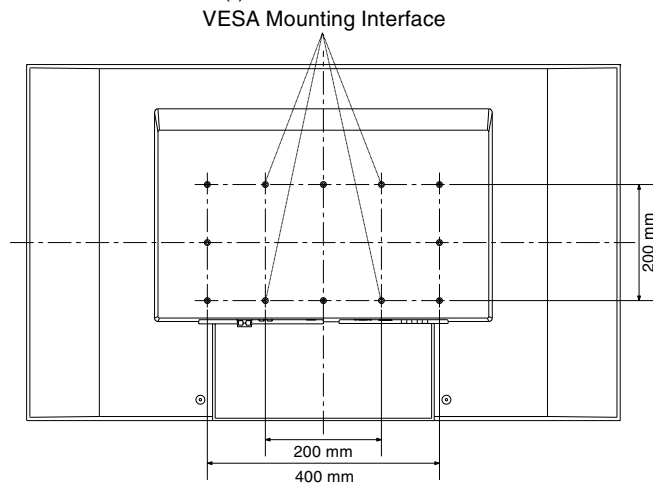

Mounting accessories can be attached with the monitor in the face down position. To avoid damaging the screen face, place the protective sheet on the table underneath the LCD. The protective sheet was wrapped around the LCD in the original packaging. Make sure there is nothing on the table that can damage the monitor.

When using mounting accessories other than NEC compliant and approved, they must comply with the VESA-compatible mounting method.

## 2. Using optional table top stand

**CAUTION:** Installing and removing the stand must be done by two or more people.

### Installing and removing optional table top stand

To install, follow those instructions included with the stand or mounting apparatus. Use only those devices recommended by the manufacturer.

Handle with care when mounting LCD monitor stand and avoid pinching your fingers.

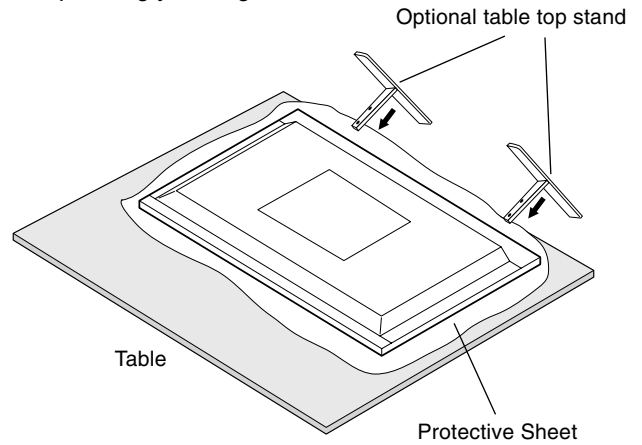

**NOTE:** ST-3215 is for V321. Use the Thumbscrews included with ST-3215. ST-4020 is for V461 and LCD4215<sup>(R)</sup>. (V461 and LCD4215<sup>(R)</sup> are not mentioned in ST-4020 manual). Before using optional table top stand, remove installed thumbscrews from the display first. Please use a screwdriver for removing thumbscrews as necessary.

## 3. Ventilation Requirements

When mounting in an enclosed space or recessed area, leave adequate room between the monitor and the enclosure to allow heat to disperse, as shown below.

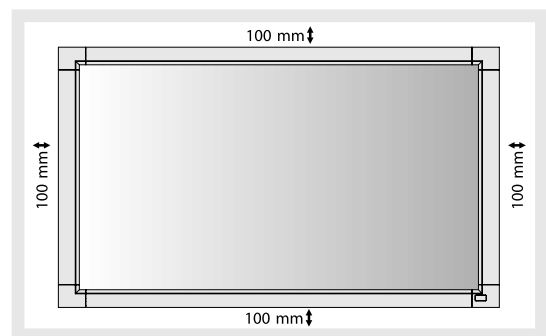

Allow adequate ventilation or provide air conditioning around the monitor, so that heat can properly dissipate away from the unit and mounting apparatus; especially when you use monitors in a multiple screen environment.



## 4. Prevent Tipping

When using the display with the Tabletop Stand fasten the LCD to a wall using a cord or chain that can support the weight of the monitor in order to prevent the monitor from falling. Fasten the cord or chain to the monitor using the provided clamp and screw.

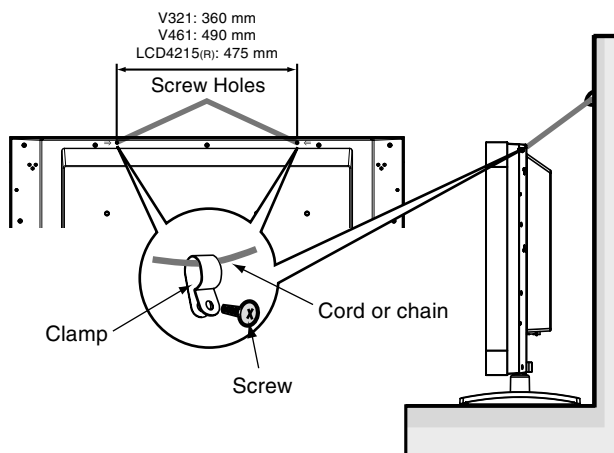

Before attaching the LCD monitor to the wall, make sure that the wall can support the weight of the monitor.

Be sure to remove the cord or chain from the wall before moving the LCD.

# Parts Name and Functions

## Control Panel

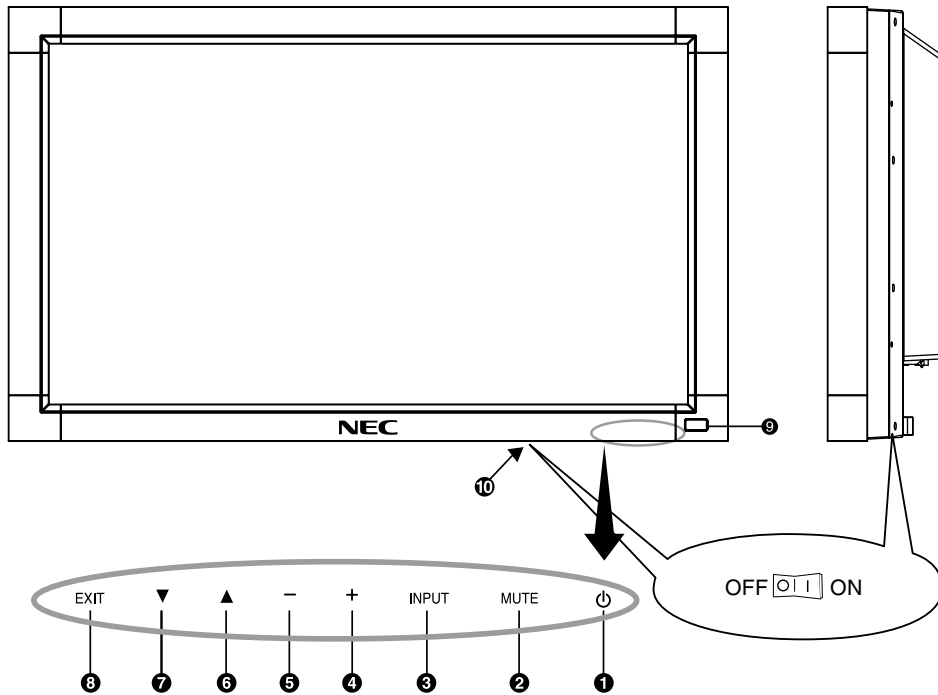

### 1 POWER button (⏻)

Switches the power on/off. See also page 16.

### 2 MUTE button

Switches the audio mute ON/OFF.

### 3 INPUT button

Acts as SET button within OSD menu. Shows Input select menu for [DVI], [VGA], [RGB/HV], [HDMI], [DVD/HD], [S-VIDEO], [VIDEO1], [VIDEO2].

### 4 PLUS (+) button

Acts as (+) button to increase the adjustment with OSD menu. Increases the audio output level when the OSD menu is turned off.

### 5 MINUS (-) button

Acts as (-) button to decrease the adjustment with OSD menu. Decreases the audio output level when the OSD menu is turned off.

### 6 UP (▲) button

Acts as ▲ button to move the highlighted area up to select adjustment items within OSD menu.

### 7 DOWN (▼) button

Acts as ▼ button to move the highlighted area down to select adjustment items within OSD menu.

### 8 EXIT button

Activates the OSD menu when the OSD menu is turned-off. Acts as EXIT button within the OSD to move to previous menu.

### 9 Remote control sensor and Power Indicator

Receives the signal from the remote control (when using the wireless remote control). See also page 10. Glows green when the LCD monitor is in active mode. Glows red when the LCD is in POWER OFF mode. When the LCD monitor is in POWER SAVE mode, it will glow both green and red. When SCHEDULE is enabled, it will blink green and glow red. See page 17. When a component failure is detected within the monitor, the indicator will blink red.

### 10 Main Power Switch

On/Off switch to turn main power ON/OFF. See also page 16.

### Control Key Lock Mode

This control completely locks out access to all Control Key functions. To activate the control key lock function, press both ▼ and ▲ and hold down simultaneously for more than 3 seconds. To resume user mode, press both ▼ and ▲ and hold simultaneously for more than 3 seconds.

## Terminal Panel

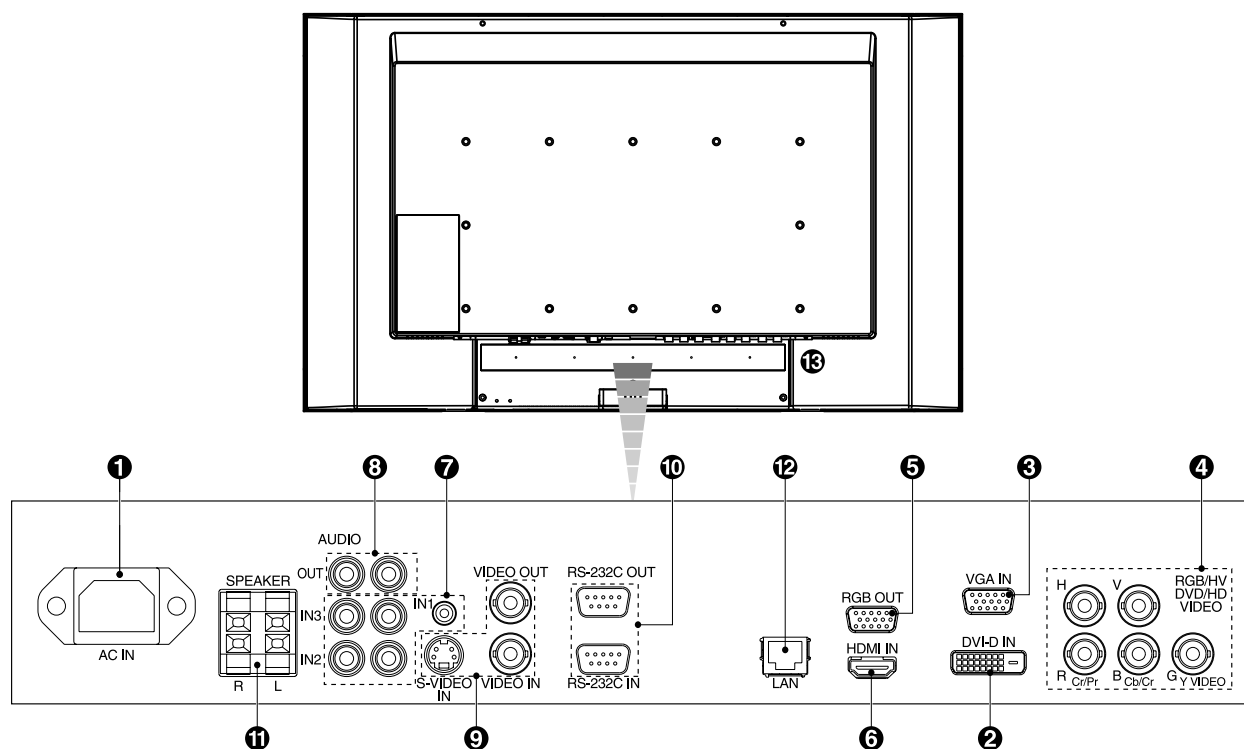

### 1 AC IN connector

Connects with the supplied power cord.

### 2 DVI IN (DVI-D)

To input digital RGB signals from a computer or HDTV device having a digital RGB output.

\* This connector does not support analog input.

### 3 VGA IN (mini D-Sub 15 pin)

To input analog RGB signals from a personal computer or from other RGB equipment.

### 4 RGB/HV IN [R, G, B, H, V] (BNC)

To input analog RGB signals or signals from other RGB equipment.

This is also to connect equipment such as a DVD player, HDTV device and Set-Top-Box.

This input can be used with an RGB, DVD/HD or Video source. Please select signal type in TERMINAL SETTING on ADVANCED MENU.

	R	G	B	H	V
RGB/HV	R	G	B	H	V
DVD/HD	Pr	Y	Pb		
VIDEO2		VIDEO			

### 5 RGB OUT (mini D-Sub 15 pin)

To output the signal from the VGA and RGB/HV IN connector to an input on a separate device.

### 6 HDMI Connector

To input digital HDMI signals.

### 7 AUDIO IN 1, 2, 3

To input audio signal from external equipment such as a computer, VCR or DVD player.

### 8 AUDIO OUT

To output the audio signal from the AUDIO IN 1, 2 and 3 jack to an external device (stereo receiver, amplifier, etc.).

### 9 VIDEO INPUT/OUTPUT Connector

**VIDEO IN connector (BNC):** To input a composite video signal.

**VIDEO OUT connector (BNC):** To output the composite video signal from the VIDEO IN connector.

**S-VIDEO IN connector (Mini DIN 4 pin):** To input the S-VIDEO (Y/C separate signal).

### 10 EXTERNAL CONTROL (D-Sub 9 pin)

**IN connector:** Connect RS-232C input from external equipment such as a PC in order to control RS-232C functions.

**OUT connector:** Connect RS-232C output. To connect multiple MultiSync monitors via RS-232C daisy Chain.

### 11 EXTERNAL SPEAKER TERMINAL

To output the audio signal from AUDIO 1, 2, 3.

**Note:** This speaker terminal is for optional speaker.

SP-3215 for MultiSync V321, SP4020-4620 for MultiSync LCD4215<sup>(R)</sup>, SP-4615 for MultiSync V461.

When you use SP4020-4620 for LCD4215<sup>(R)</sup>, please use SP4020-4620 with large extension blocks (included in speaker), as if being mounted on LCD4620. (LCD4215<sup>(R)</sup> is not mentioned in SP4020-4620 manual).

### 12 LAN port (RJ-45) (V321 and V461 only)

LAN connection. See page 25.

### 13 Kensington Lock (V461 and LCD4215<sup>(R)</sup> only)

For security and theft prevention.

# Wireless Remote Control

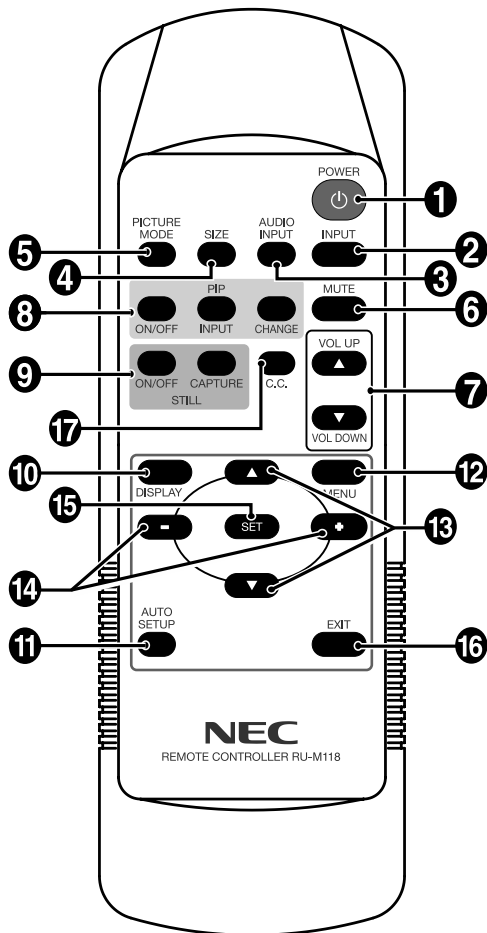

## 1 POWER button

Switches the power on/off.

## 2 INPUT button

Shows Input select menu for [DVI], [VGA], [RGB/HV], [HDMI], [DVD/HD], [S-VIDEO], [VIDEO1], [VIDEO2].

## 3 AUDIO INPUT button

Selects audio input source [AUDIO:1], [AUDIO:2], [AUDIO:3].

## 4 SIZE button

Selects picture size, [FULL], [NORMAL], [CUSTOM], [DYNAMIC] and [REAL]. See page 17.

## 5 PICTURE MODE button

Selects picture mode, [HIGHBRIGHT], [STANDARD], [sRGB], [CINEMA]. See page 17.

HIGHBRIGHT: for moving images such as DVD  
 STANDARD: for images  
 sRGB: for text based images  
 CINEMA: for movies.

## 6 MUTE button

Turns on/off mute function.

## 7 VOLUME UP/DOWN button

Increase/decrease audio output level.

## 8 PIP (Picture In Picture) button

**ON/OFF button:** Toggle switches between PIP and POP (Picture Out Picture). See page 20.

**INPUT button:** Selects the "picture in picture" input signal.

**CHANGE button:** Replaces to the main picture and sub picture.

NOTE: The "PIP" and "POP" modes do not function when the screen size is "CUSTOM" or "REAL".

		Sub picture							
		DVI	VGA	RGB/HV	HDMI	DVD/HD	VIDEO1	VIDEO2	S-VIDEO
Main picture	DVI	-	✓	✓	-	✓	✓	✓	✓
	VGA	✓	-	-	✓	✓	✓	-	✓
	RGB/HV	✓	-	-	✓	-	✓	-	✓
	HDMI	-	✓	✓	-	✓	✓	✓	✓
	DVD/HD	✓	✓	-	✓	-	✓	-	✓
	VIDEO1	✓	✓	✓	✓	✓	-	-	-
	VIDEO2	✓	-	-	✓	-	-	-	-
	S-VIDEO	✓	✓	✓	✓	✓	-	-	-

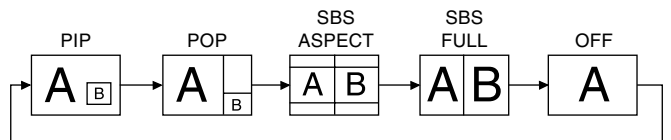

## 9 STILL button

**ON/OFF button:** Activates/deactivates still picture mode.

**STILL CAPTURE button:** Captures still picture.

## 10 DISPLAY button

Turns on/off the information OSD. See page 17.

## 11 AUTO SETUP button

Enters auto setup menu. See page 19.

## 12 MENU button

Turns on/off the menu mode.

## 13 UP/DOWN button

Acts as ▲ ▼ button to move the highlighted area up or down to select adjustment items within OSD menu.

Small screen which adjusted "PIP" mode moves up or down.

## 14 MINUS/PLUS (-/+) button

Increases or decreases the adjustment level within OSD menu settings.

Small screen which adjusted "PIP" mode moves left or right.

## 15 SET button

Makes selection.

## 16 EXIT button

Returns to previous menu within OSD menu.

## 17 C. C. button (V321 and V461 only)

Activates closed captioning.

Note: VIDEO1, VIDEO2, S-VIDEO inputs only.

## Operating Range for the Remote Control

Point the top of the remote control toward the LCD monitor's remote sensor during button operation.

Use the remote control within a distance of about 7 m (23 ft.) from the front of the LCD monitor's remote control sensor or at a horizontal and vertical angle of within 30° within a distance of about 3.5 m (10 ft.)

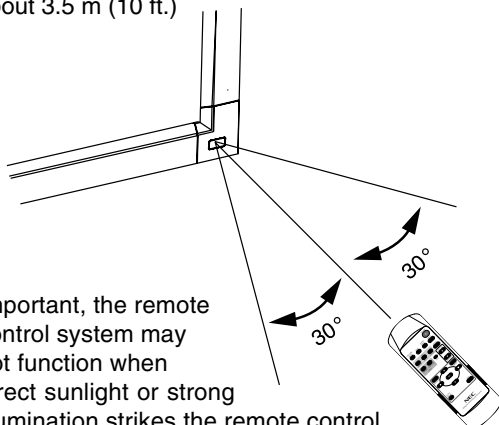

**Caution:** Important, the remote control system may not function when direct sunlight or strong illumination strikes the remote control sensor of the LCD monitor, or when there is an object in the path.

### Handling the remote control

- Do not subject to strong shock.
- Do not allow water or other liquid to splash the remote control. If the remote control gets wet, wipe it dry immediately.
- Avoid exposure to heat and steam.
- Other than to install the batteries, do not open the remote control.

# Setup

## 1. Determine the installation location

**CAUTION:** Installing your LCD display must be done by a qualified technician. Contact your dealer for more information.

**CAUTION:** MOVING OR INSTALLING THE LCD MONITOR MUST BE DONE BY TWO OR MORE PEOPLE. Failure to follow this caution may result in injury if the LCD monitor falls.

**CAUTION:** Do not mount or operate the display upside down, face up, or face down.

**CAUTION:** This LCD has a temperature sensor and cooling fan. If the LCD becomes too hot, the cooling fan will turn on automatically. If the LCD becomes overheated while the cooling fan is running, a "Caution" warning will appear. If the "Caution" warning appears, discontinue use and allow the unit to cool. Using the cooling fan will reduce the likelihood of early circuit failure and may help reduce image degradation and "Image Persistence".

If the LCD is used in an enclosed area or if the LCD panel is covered with a protective screen, please check the inside temperature of the monitor by using the "HEAT STATUS" control in the OSD (see page 21). If the temperature is higher than the normal operating temperature, please turn the cooling fan to ON within the SCREEN SAVER menu within the OSD (see page 21).

**IMPORTANT:** Lay the protective sheet, which was wrapped around the LCD monitor when it was packaged, beneath the LCD monitor so as not to scratch the panel.

## 2. Install the remote control batteries

The remote control is powered by two 1.5V AAA batteries. To install or replace batteries:

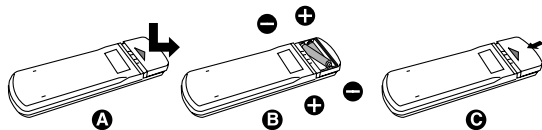

- Press and slide to open the cover.
- Align the batteries according to the (+) and (-) indications inside the case.
- Replace the cover.

**CAUTION:** Incorrect usage of batteries can result in leaks or bursting.

NEC recommends the following battery use:

- Place "AAA" size batteries matching the (+) and (-) signs on each battery to the (+) and (-) signs of the battery compartment.
- Do not mix battery brands.
- Do not combine new and old batteries. This can shorten battery life or cause liquid leakage of batteries.
- Remove dead batteries immediately to prevent battery acid from leaking into the battery compartment.
- Do not touch exposed battery acid as it may injure skin.

**NOTE:** Remove the batteries if you do not intend to use the remote control for a long period of time.

## 3. Connect external equipment (See pages 14-15)

- To protect the external equipment; turn off the main power before making connections.
- Refer to your equipment user manual for further information.

## 4. Connect the supplied power cord

- The equipment should be installed close to an easily accessible power outlet.
- Fully insert the prongs into the power outlet socket. A loose connection may cause image degradation.

**NOTE:** Please refer to the "Safety Precautions and Maintenance" section of this manual for proper selection of AC power cord.

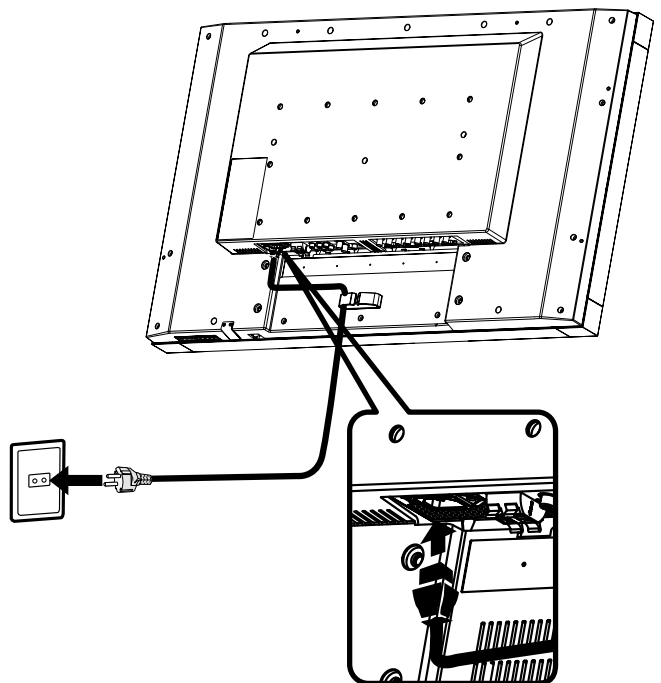

## 5. Switch on the power of all the attached external equipment

When connected with a computer, switch on the power of the computer first.

## 6. Operate the attached external equipment

Display the signal from the desired input source.

## 7. Adjust the sound

Make volume adjustments when required.

## 8. Adjust the screen (See pages 19 and 20)

Make adjustments to the screen display position when necessary.

## 9. Adjust the image (See page 19)

Make adjustments such as brightness or contrast when required.

## 10. Recommended Adjustments

To reduce the risk of the "Image Persistence", please adjust the following items based on the application being used: "POWER SAVE", "SCREEN SAVER" (See page 21), "SIDE BORDER COLOR" (See page 22), "DATE AND TIME", "SCHEDULE" (See page 20).

## 11. To prevent the main power switch from being changed

To prevent use of the main power switch, please attach the main switch cover, which is enclosed as an accessory.

**NOTE:** With the main power switch cover in place, the main power switch cannot be turned off. Remove main power switch cover in order to switch off the display.

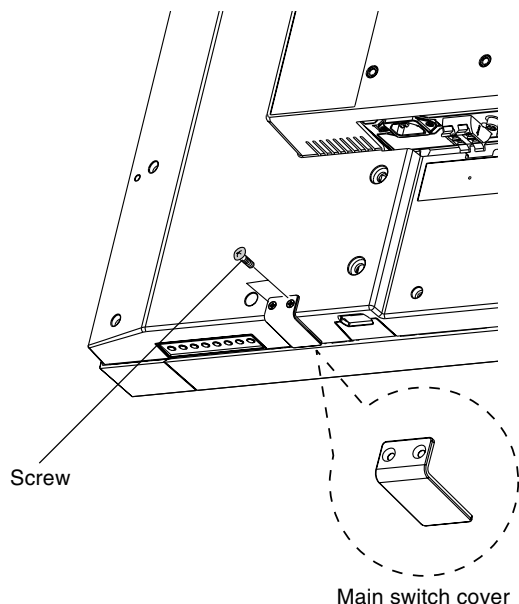

# Connections

**NOTE:** Do not connect/disconnect cables when turning on the monitor or other external equipment as this may result in a loss of the monitor image.

**NOTE:** Use an audio cable without a built-in resistor. Using an audio cable with a built-in resistor turns down the sound.

## Before making connections:

- \* First, turn off the power of all attached equipment and make connections.
- \* Refer to the user manual included with each separate piece of equipment.

## Wiring Diagram

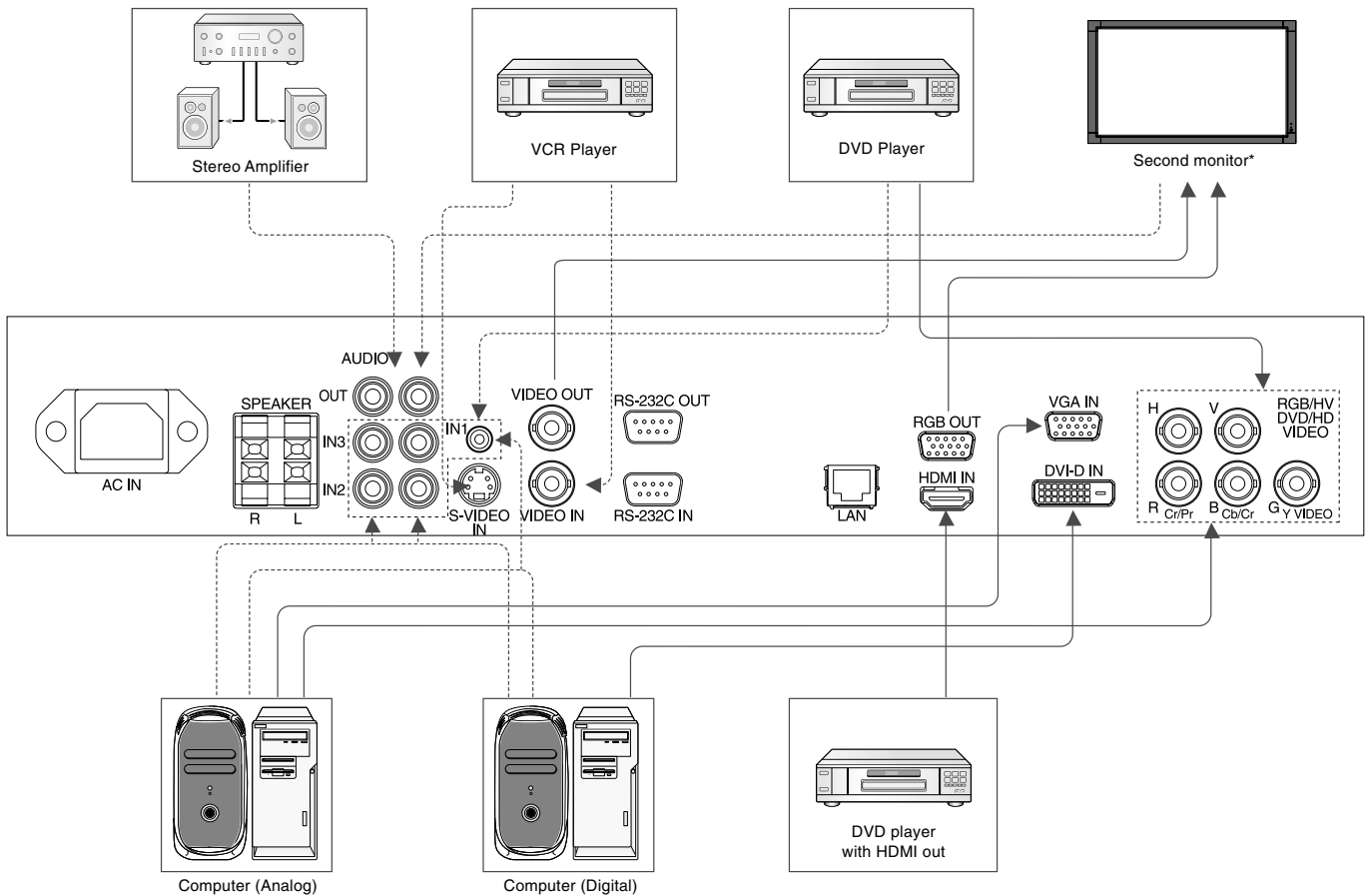

\*: Multiple monitors that are daisy-chained have a limit to the connectable monitors.

Connected equipment	Connecting terminal	Setting in Terminal Mode	Input signal name	Connecting Audio terminal
AV	DVI (DVI-D)	DVI MODE: DVI-HD	DVI	AUDIO IN1, IN2, IN3
	HDMI	RAW/EXPAND*1	HDMI	HDMI
	DVD/HD (5BNC)	BNC MODE: COMPONENT	DVD/HD	AUDIO IN1, IN2, IN3
	S-VIDEO	-	S-VIDEO	AUDIO IN1, IN2, IN3
	VIDEO1 (BNC)	-	VIDEO1	AUDIO IN1, IN2, IN3
PC	VIDEO2 (5BNC)	BNC MODE: VIDEO	VIDEO2	AUDIO IN1, IN2, IN3
	DVI (DVI-D)	DVI MODE: DVI-PC	DVI	AUDIO IN1, IN2, IN3
	VGA	-	VGA	AUDIO IN1, IN2, IN3
	RGB/HV (5BNC)	BNC MODE: RGB	RGB/HV	AUDIO IN1, IN2, IN3

\*1: depend on signal type.

- AUDIO IN 1, 2 and 3 can be used for audio input. To select audio source [IN1], [IN2] or [IN3] by pressing the AUDIO INPUT button (remote control).



## Connecting a Personal Computer

Connecting your computer to your LCD monitor will enable you to display your computer's screen image. Some video cards with a pixel clock over 165 MHz may not display an image correctly. Your LCD monitor displays proper image by adjusting the factory preset timing signal automatically.

<Factory preset signal timing>

Resolution	Scanning frequency		Remarks	
	Horizontal	Vertical	V321/LCD4215 <sub>(R)</sub>	V461
640 x 480	31.5 kHz	60 Hz		
800 x 600	37.9 kHz	60 Hz		
1024 x 768	48.4 kHz	60 Hz		
1280 x 768	48 kHz	60 Hz		
1360 x 768	48 kHz	60 Hz	Recommended resolution	
1280 x 1024	64 kHz	60 Hz	Compressed image	
1600 x 1200	75 kHz	60 Hz	Compressed image	Compressed image
1920 x 1080	66.6 kHz	60 Hz	Compressed image	Recommended resolution

- If you use with a Macintosh PowerBook, set "Mirroring" to Off on your PowerBook. Refer to your Macintosh's owner's manual for more information about your computer's video output requirements and any special identification or configuration your monitor's image and monitor may require.
- Input TMDS signals conforming to DVI standards.
- To maintain display quality, use a cable that conforms to DVI standards.

## Connecting a DVD Player with HDMI out

- Please use an HDMI cable with HDMI logo.
- It may take a moment for the signal to appear.
- PC-DVI signals are not supported.

# Basic Operation

---

## Power ON and OFF Modes

The LCD monitor power indicator will turn green while powered on and will turn red while powered off.

**NOTE:** The Main Power Switch must be in the ON position in order to power up the monitor using the remote control or the Power Button on the front of the LCD.

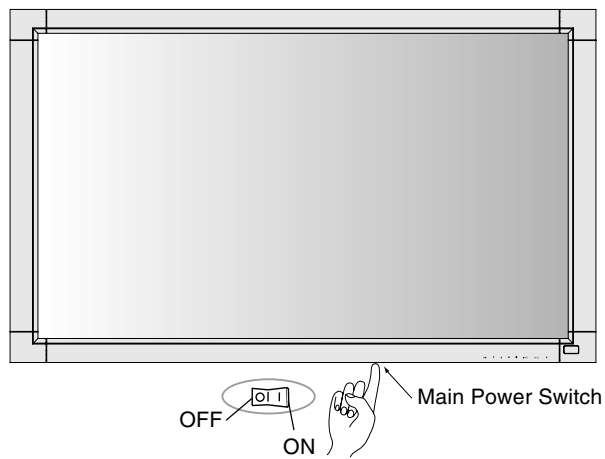
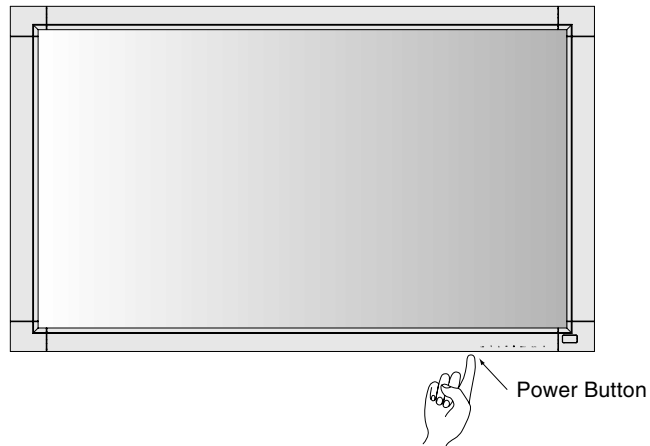

Using the remote control

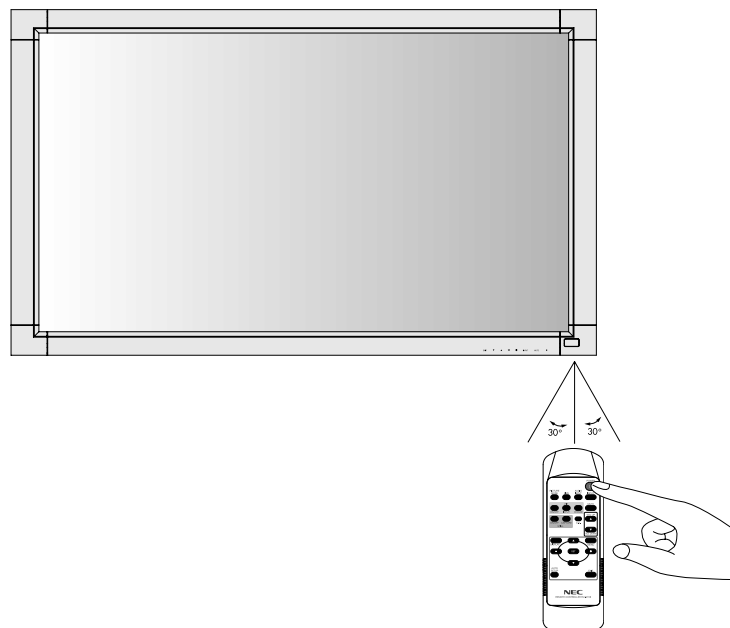

## Power Indicator

	Status
Power ON	Green
Power OFF	Red
Power Standby when "SCHEDULE" is enabled	Red On Green Blinking
Power Standby	Red, Green
Diagnosis (Detecting failure)	Red Blinking

\* See troubleshooting on page 29

## Using Power Management

The LCD monitor follows the VESA approved DPM Power Management function.

The power management function is an energy saving function that automatically reduces the power consumption of the display when the keyboard or the mouse has not been used for a fixed period.

The power management feature on your new display has been set to the "ON" mode. This allows your display to enter a Power Saving Mode when no signal is applied. This could potentially increase the life and decrease the power consumption of the display.

**NOTE:** Depending on the PC and video card used, this function may not operate.

## Selecting a video source

### To view a video source:

Use the input button to set [HDMI], [VIDEO1], [VIDEO2] or [S-VIDEO].

Use the COLOR SYSTEM menu to set [AUTO], [PAL], [NTSC], [PAL60], [4.43NTSC], [SECAM], according to your video format.

## Picture Size

DVI, VGA, RGB/HV

FULL → NORMAL → CUSTOM → REAL

HDMI, DVD/HD, S-VIDEO, VIDEO1, VIDEO2

FULL → NORMAL → DYNAMIC → CUSTOM → REAL

Aspect ratio of image	Unchanged view*1	Recommended selection for picture size*1
4:3		NORMAL
		DYNAMIC
Squeeze		FULL

\*1 Grey areas indicate unused portions of the screen.

**NORMAL:** Displays the aspect ratio the same as it is sent from the source.

**FULL:** Fills entire screen.

**DYNAMIC:** Expands a 4:3 pictures to fill the entire screen with non-linearity. Some of the outside image area will be cut off due to expansion.

### CUSTOM (ZOOM)

The image can be expanded beyond the active display area. The image which is outside of active display area is not shown.

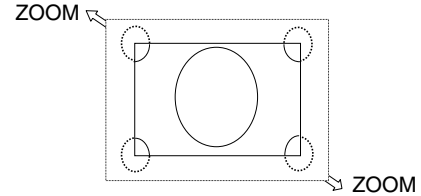

**REAL:** Image will be displayed 1 by 1 pixel.

## Picture Mode

DVI, VGA, RGB/HV

STANDARD → sRGB → HIGHBRIGHT  
 ↑  
 HDMI, DVD/HD, S-VIDEO, VIDEO1, VIDEO2

STANDARD → CINEMA → HIGHBRIGHT  
 ↑

## Information OSD

### DVI, VGA, RGB/HV

VGA	← Video Input mode
1024 x 768	) ← Input signal Information
48kHz 60Hz	
AUDIO : 1	← Audio input mode
SIZE : FULL	← Picture Size mode

### DVD/HD

DVD/HD	← Video Input mode
60HZ	) ← Input signal Information
AUDIO : 2	
SIZE : FULL	
	← Audio input mode
	← Picture Size mode

### VIDEO

S-VIDEO	← Video Input mode
60HZ	) ← Input Signal Colour System mode
NTSC	
AUDIO : 3	
SIZE : NORMAL	
	← Audio input mode
	← Picture Size mode

### PIP or POP

Main: VGA  
Sub: S-VIDEO

VGA	) ← Main picture information
1024 x 768	
48kHz 60Hz	
AUDIO : 1	
S-VIDEO	) ← Sub picture information
NTSC	
60HZ	
SIZE : FULL	← Main picture Size mode

# OSD (On-Screen-Display) Controls

## Remote Control

Press MENU button to open Main menu.

Press "+", "-" button to select Main menu, and press Up, Down button to enter Sub menu.

Press SET Button to enter next menu to adjust.

Press Up, Down or "+", "-" button to select function, or setting to be adjusted.

Press MENU or EXIT button to exit.

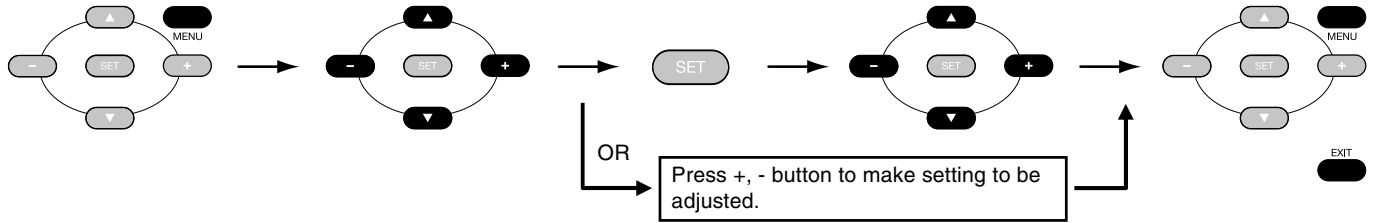

## Control Panel

Press EXIT button to open Main menu and press "+", "-" button to select Main menu. Then press Up, Down button to enter Sub menu.

Press INPUT button to enter next menu to adjust.

Press Up, Down or "+", "-" button to select function, or setting to be adjusted.

Press EXIT button to exit.

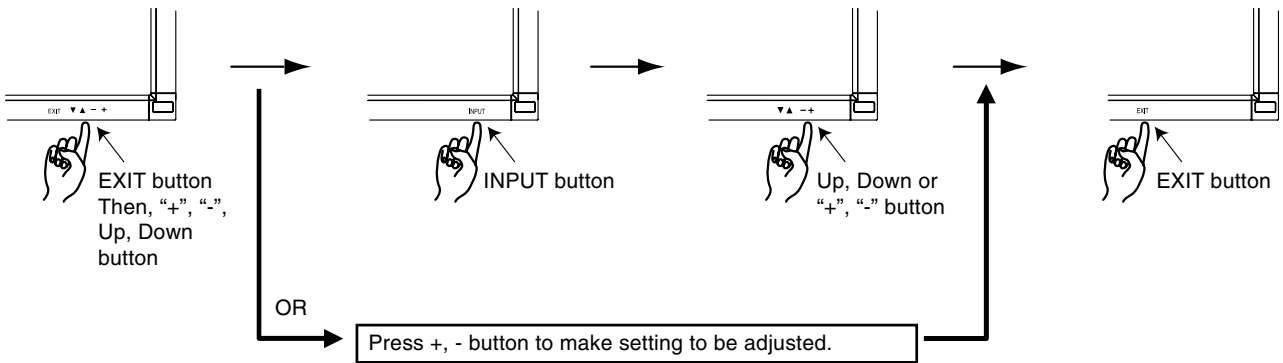

## OSD screen

Press MENU button to open Main menu.  
Press +, - button to select Main menu.  
Press down or up to enter Sub menu.

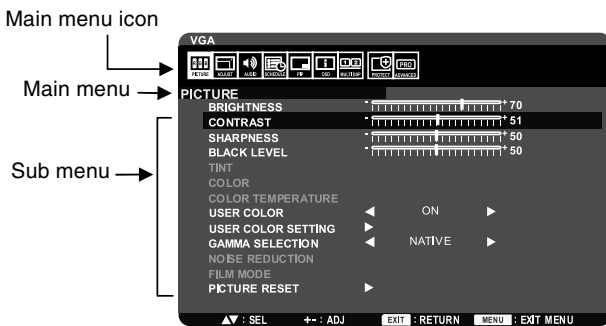

Press +, - button to make setting to be adjusted.

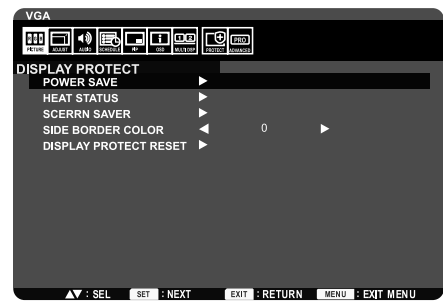

Press SET button to enter next menu to adjust.



Press Up, Down or "+", "-" button to select function or setting to be adjusted.

Press MENU or EXIT button to exit.

PICTURE	
BRIGHTNESS	Adjusts the overall image and background brightness.
CONTRAST	Adjusts the image brightness in relation to the input signal. NOTE: sRGB picture mode is standard and cannot be changed.
SHARPNESS	Adjusts the crispness of the image.
BLACK LEVEL	Adjusts the image brightness in relation to the background.
TINT <small>INPUT HDMI, DVD/HD, S-VIDEO, VIDEO1, VIDEO2 only</small>	Adjusts the tint of the screen.
COLOR <small>INPUT HDMI, DVD/HD, S-VIDEO, VIDEO1, VIDEO2 only</small>	Adjusts the color depth of the screen.
COLOR TEMPERATURE	Adjusts the color temperature of the entire screen. A low color temperature will make the screen reddish. A high color temperature will make the screen bluish.
USER COLOR	Select the USER COLOR SETTING feature ON/OFF.
USER COLOR SETTING	Adjusts the levels of the Red, Yellow, Green, Cyan, Blue and Magenta. Note: The sRGB picture mode is standard and cannot be changed. It can be adjusted only when USER COLOR is selected ON.
GAMMA SELECTION	Select a display gamma for best picture quality.
NATIVE	Gamma correction is handled by the LCD panel.
2.2	Typical display gamma for use with a PC.
2.4	Good for video (TV, DVD, etc.)
S GAMMA	Special gamma for certain types of movies. Raises the dark parts and lowers the light parts of the image. NOTE: sRGB picture is standard and cannot be changed.
NOISE REDUCTION <small>INPUT S-VIDEO, VIDEO1, VIDEO2 only</small>	Adjusts the amount of noise reduction.
FILM MODE <small>INPUT HDMI, DVD/HD, S-VIDEO, VIDEO1, VIDEO2 only</small>	Selects Film mode function. ( AUTO) This mode is better suited for movies, which is converted 24 Frames/sec source to DVD Video.
PICTURE RESET	Resets the all settings within the PICTURE menu back to factory setting.
ADJUST	
AUTO SETUP <small>INPUT VGA, RGB/HV only</small>	Press "SET" button to automatically adjust screen size, horizontal position, vertical position, clock, clock phase, white level and black level.
AUTO ADJUST <small>INPUT VGA, RGB/HV only</small>	Selecting ON when changing the timing, the horizontal position, vertical position and clock phase will adjust automatically.
H POSITION <small>ALL inputs except DVI, HDMI</small>	Controls the horizontal position of the image within the Display area of the LCD. Press + to move right. Press - to move left.
V POSITION <small>ALL inputs except DVI, HDMI</small>	Controls the vertical position of the image within the Display area of the LCD. Press + to move up. Press - to move down.
CLOCK <small>INPUT VGA, RGB/HV only</small>	Press + to expand the width of the image on the right of the screen. Press - to narrow the width of the image on the left.
CLOCK PHASE <small>INPUT VGA, RGB/HV only</small>	Adjusts the visual "noise" on the image.
ZOOM MODE	You can select "FULL", "NORMAL", "DYNAMIC", "CUSTOM" and "REAL". NOTE: DYNAMIC is INPUT HDMI, DVD/HD, S-VIDEO, VIDEO1, VIDEO2 only. Selecting DYNAMIC expands 4:3 picture to fill the screen. Some of the image is lost due to expansion. Selecting "REAL" image will be displayed 1 by 1pixel.
CUSTOM ZOOM	"CUSTOM ZOOM" will be selected when you select "CUSTOM" on the screen "ZOOM" mode.
ZOOM	Expands the horizontal and the vertical size simultaneously.
H ZOOM	Expands the horizontal size only.
V ZOOM	Expands the vertical size only.
H POSITION	Moves to the right with + button. Moves to the left with - button.
V POSITION	Moves up with + button. Moves down with - button.

H RESOLUTION INPUT VGA, RGB/HV only	Adjusts the horizontal size of the image. Press + button to expand, and press - button to narrow the width of the image on the screen.
V RESOLUTION INPUT VGA, RGB/HV only	Adjusts the vertical size of the image. Press + button to expand, and press - button to narrow the width of the image on the screen.
INPUT RESOLUTION INPUT VGA, RGB/HV only	Selects to decision of input signal timings 1024x768, 1280x768, 1360x768 and 1366x768 if there is a detection problem. If no problem is detected, the only available option will be "AUTO".
ADJUST RESET	Resets the all settings within the ADJUST menu back to factory setting.
<b>AUDIO</b>	
BALANCE	Adjust the balance of L/R volume.
TREBLE	To accentuate or reduce the high frequency sound. Press + to increase, press - to decrease.
BASS	To accentuate or reduce the low frequency sound. Press + to increase, press - to decrease.
AUDIO RESET	Resets the all settings within the AUDIO menu back to factory setting.
<b>SCHEDULE</b>	
OFF TIMER	Sets the monitor to power off after a length of time. A time between 1 to 24 hours is available.
SCHEDULE	Creates a working schedule for the monitor to use. (See "NOTE 1" on page 23 for further information).
DATE AND TIME	Sets the date, time, and daylight saving region. Setting item: YEAR/MONTH/DAY/HOUR/MINUTE/DAYLIGHT SAVING TIME Date & time must be set in order for the "SCHEDULE" function to operate.
SCHEDULE RESET	Resets the all settings within the SCHEDULE menu back to factory setting except DATE AND TIME setting.
<b>PIP</b>	
PIP MODE	Selects Picture-in-Picture mode. See page 10.
OFF	Normal mode.
PIP	Picture in Picture mode.
POP	Picture out picture mode.
SBS ASPECT	Side by side (split screen) mode, with keep aspect.
SBS FULL	Side by side (split screen) mode, with full screen.
PIP SIZE	Selects the size of sub-picture used in "Picture-in-Picture" (PIP) mode. "LARGE", "MIDDLE" and "SMALL" are available.
PIP AUDIO	Selects the sound source in PIP mode.
PIP H-POSITION	Determines where the PIP appears on the screen.
PIP V-POSITION	Determines where the PIP appears on the screen.
TEXT TICKER (V321 and V461 only)	
MODE	Enables Text Ticker and allows you to set Horizontal or Vertical direction.
POSITION-H	Selects the horizontal location of the Text Ticker on the screen.
POSITION-V	Selects the vertical location of the Text Ticker on the screen.
SIZE	Determines the size of the Text Ticker in relationship to the overall screen size.
BLEND	Sets the transparency of the Text Ticker (10: transparent, 100: opaque).
DETECT	Enables auto-detection of the Text Ticker.
FADE IN	Enables fade-in of the text ticker when DETECT is AUTO.
SUB INPUT	Selects sub picture input signal.
PIP RESET	Resets the all settings within the PIP menu back to factory setting.
<b>OSD</b>	
LANGUAGE	Selects the language used by the OSD from seven languages. ENGLISH/DEUTSCH/Français/ESPAÑOL/ITALIANO/SVENSKA/日本語
OSD TURN OFF	Turns off the OSD after a period of inactivity. The preset choices are 5 - 120 seconds.

OSD H-POSITION	Adjusts the horizontal position of the OSD menu.
OSD V-POSITION	Adjusts the vertical position of the OSD menu.
INFORMATION OSD	Selects the information OSD displays or not. The information OSD will display when input signal or source change or warning message like as no-signal or out-of range. A time between 1 to 10 seconds is available.
MONITOR INFORMATION	Indicates the model and serial number of your monitor.
CLOSED CAPTION* <small>INPUT DVD/HD, S-VIDEO, VIDEO1, VIDEO2 only</small>	Activates closed captioning.
OSD RESET	Resets the all settings within the OSD menu back to factory setting.
<b>MULTI DISPLAY</b>	
MONITOR ID	Sets the monitor ID number from 1-26. Monitor ID is used for RS-232C control only.
IR CONTROL	Selects the infrared wireless remote controller mode. The item in this menu will become effective by pressing "SET" button on the selected item.
NORMAL	The monitor will be controlled normally by wireless remote controller.
LOCK	Disables the monitor control by infrared wireless remote controller. Keep pressing "DISPLAY" button during 5 sec or more, this setting will return to "NORMAL".
TILE MATRIX	Allows one image to be expanded and displayed over multiple screens (up to 16) through a distribution amplifier. When screen size is "Real", this function does not operate.
H MONITORS	Selects number of monitors arranged vertically.
V MONITORS	Selects number of monitors arranged horizontally.
POSITION	Selects which section of the tiled image to be displayed on the monitor.
TILE COMP	Turns the TILE COMP feature on.
ENABLE	Enables the Tile Matrix. PIP and STILL will be disabled when "TILE MATRIX" is activated.
POWER ON DELAY	Adjusts the delay time between being in "standby" mode and entering "power on" mode. "POWER ON DELAY" time is selectable from OFF, 2, 4, 6, 8, 10, 20, 30, 40 and 50 sec.
EXTERNAL CONTROL*	
CONTROL	Selects the control interface, RS-232C or LAN.
LAN RESET	Resets the LAN settings.
MULTI DISPLAY RESET	Resets the all settings within the MULTI DISPLAY menu back to factory setting.
<b>DISPLAY PROTECTION</b>	
POWER SAVE	Sets how long the monitor waits to go into power save mode after a lost signal. Note: When connecting DVI, video card might not stop sending digital data even if image has disappeared. In this case the monitor does not get to power management mode.
RGB	Selecting "ON", the monitor will go to power management mode when DVI, VGA, RGB/HV sync is lost.
VIDEO	Selecting "ON", the monitor will go to power management mode after about 10 minutes when DVD/HD and HDMI, S-VIDEO, VIDEO1, VIDEO2 input signal is lost.
HEAT STATUS	Information of status for COOLING FAN, BRIGHTNESS and TEMPERATURE. COOLING FAN runs when inside temperature is over a guaranteed limit. In this case warning is displayed on the screen.
SCREEN SAVER	Use the SCREEN SAVER function to reduce the risk of Image Persistence. (See "NOTE 2" on page 23 for further information).
GAMMA	The display gamma is changed and fixed when "ON" is selected.
COOLING FAN	The built in cooling fan is always on when set "ON".
BRIGHTNESS	The brightness is decreased when "ON" is selected.
MOTION	Image is slightly expanded and moves 4 directions (UP, DOWN, RIGHT, LEFT) periodically (Need setting the time for movement). Movement area is approximately +/- 10 mm from original position; Please locate the important information such as text within 90% area of screen image. PIP and STILL will be disabled when "MOTION" is active.

\*: V321 and V461 only.

SIDE BORDER COLOR	Adjusts the color of the side borders when a 4:3 image is displayed. Press + button, the bar will become lighter. Press - button, the bar will become darker.
DISPLAY PROTECTION RESET	Resets the all settings within the DISPLAY PROTECTION menu back to factory setting.
<b>ADVANCED OPTION</b>	
INPUT CHANGE	Sets input change speed. NOTE: When "QUICK" is selected, picture may be distorted when signal input is changed. This function should be chosen after all adjustment options have been made for the input.
TERMINAL SETTING	
DVI MODE	Selects the kind of DVI-D equipment which is connected to the DVI input. Select "DVI-PC" when PC or other computer equipment is connected. Select "DVI-HD" when DVD player, which has DVI-D output, is connected.
BNC MODE	Selects the kind of equipment which is connected to the BNC input. RGB: Analog input (R, G, B, H, V) COMPONENT: Component (Cr/Pr, Cb/Pb, Y) VIDEO: Composite video (VIDEO2)
HDMI SIGNAL	RAW: Disable the expanded feature. EXPAND: Expand image contrast and increase detail in the dark and bright areas.
SCAN CONVERSION <small>INPUT HDMI, DVI/HD, S-VIDEO, VIDEO1, VIDEO2 only</small>	Selects IP (Interlace to Progressive) converter function.
PROGRESSIVE	Enables the IP function, to convert interlace signal to progressive. Normally use this.
INTERLACE	Disables the IP function. NOTE: This mode is better suited for motion pictures, but it is in danger of image retention.
COLOR SYSTEM <small>INPUT S-VIDEO, VIDEO1, VIDEO2 only</small>	Selects color system depend on your video format of the input signal. (AUTO/PAL/NTSC/PAL60/4.43NTSC/SECAM) AUTO: Selects color system setting automatically base on input signal.
SCAN MODE <small>INPUT DVI/HD, HDMI, S-VIDEO, VIDEO1, VIDEO2 only</small>	Changes the display area of the image.
OVER SCAN	Set to display area about 95%
UNDER SCAN	Set to display area about 100%
ADVANCED OPTION RESET	Resets the all settings within the ADVANCED OPTION menu back to factory setting.
FACTORY RESET	Selecting "YES" allows you to reset PICTURE, ADJUST, AUDIO, PIP, OSD, MULTI DISPLAY, DISPLAY PROTECTION and ADVANCED OPTION will be back to factory settings (except LANGUAGE and DATE AND TIME). Select "YES" and press "SET" button to restore the factory preset data. Press "EXIT" button to cancel and return the previous menu.



**NOTE 1: CREATING A SCHEDULE**

Using the "SCHEDULE" function allows you to set up to seven different scheduled time intervals when the LCD Monitor will be activated. You can select the time the monitor turns on and turns off, the day of week the monitor is activated, and which input source the monitor will use for each scheduled activation period. A check mark in the box next to the number of the schedule indicates that the selected schedule is in effect.

To select which schedule to set, use the up/down arrows to move the number (1 to 7) of the schedule.

Use the (+) and (-) buttons to move the cursor horizontally within the particular schedule. The "SET" button is used to make a selection.

If you create a schedule but do not want to use a power on time, select "--" in the "ON" time slot.

If you do not want to use a power off time select "--" in the OFF time slot.

If there is no input selected ("--" showing in the input spot) the input from the previous schedule will be used.

The selection of EVERY DAY within a schedule takes priority over other schedules that are set up to operate weekly.

After the schedule is programmed, press the "MENU" button to close the OSD and make the set schedule available.

When schedules are overlapping, scheduled Power ON time has priority over scheduled Power OFF time.

**Note:** If schedules are overlapping then the schedule with the highest number will have priority over the schedule with the lowest number.

For example schedule #7 will have priority over schedule #1.

ON time should be earlier than OFF time. If OFF time is earlier than ON time, schedule function is not working properly.

If you would like to set the monitor power on at 23:00 and power off at 6:00 next morning, you should set 2 settings. First setting is ON time is "23:00" and OFF time is "--", next setting is ON time is "--" and OFF time is "06:00".

**NOTE 2: IMAGE PERSISTENCE**

Please be aware that LCD Technology may experience a phenomenon known as Image Persistence. Image Persistence occurs when a residual or "ghost" image of a previous image remains visible on the screen. Unlike CRT monitors, LCD monitors' image persistence is not permanent, but constant images being displayed for a long period of time should be avoided.

To alleviate image persistence, turn off the monitor for as long as the previous image was displayed. For example, if an image was on the monitor for one hour and a residual image remains, the monitor should be turned off for one hour to erase the image.

As with all personal display devices, NEC DISPLAY SOLUTIONS recommends displaying moving images and using a moving screen saver at regular intervals whenever the screen is idle or turning off the monitor when not in use.

Please set "SCREEN SAVER", "DATE AND TIME" and "SCHEDULE" functions to further reduce the risk of Image persistence.

**For long life use as Public Display****< Image Sticking of LCD Panel >**

When an LCD panel is operated continuously for long hours, a trace of electric charge remains near the electrode inside LCD, and residual or "ghost" image of previous image may be observed. (Image Persistence)

Image Persistence is not permanent, but when fixed image is displayed for long period, ionic impurities inside LCD are accumulated along the displayed image, and may be permanent. (Image Sticking)

**< Recommendations >**

To prevent Image Sticking, and for longer life usage of LCD, the following are recommended.

1. Fixed image should not be displayed for long period. Change fixed images after short intervals.
2. When not in use, please turn off the monitor by remote control, or use Power Management or use Schedule Functions.
3. Lower environmental temperatures prolong the lifespan of the monitor.  
When Protective surface (glass, acrylic) is installed over the LCD surface, the LCD surface is located in an enclosed space, the monitor are stacked, utilize the temperature sensors inside monitor.  
To reduce the environmental temperature, use the Cooling Fan, Screen Saver and Low Brightness.
4. Please use "Screen Saver Mode" of monitor.

# Controlling the LCD monitor via RS-232C Remote Control

This LCD monitor can be controlled by connecting a personal computer with a RS-232C terminal.

Functions that can be controlled by a personal computer are:

- Power ON or OFF
- Switching between input signals

## Connection

LCD Monitor + PC

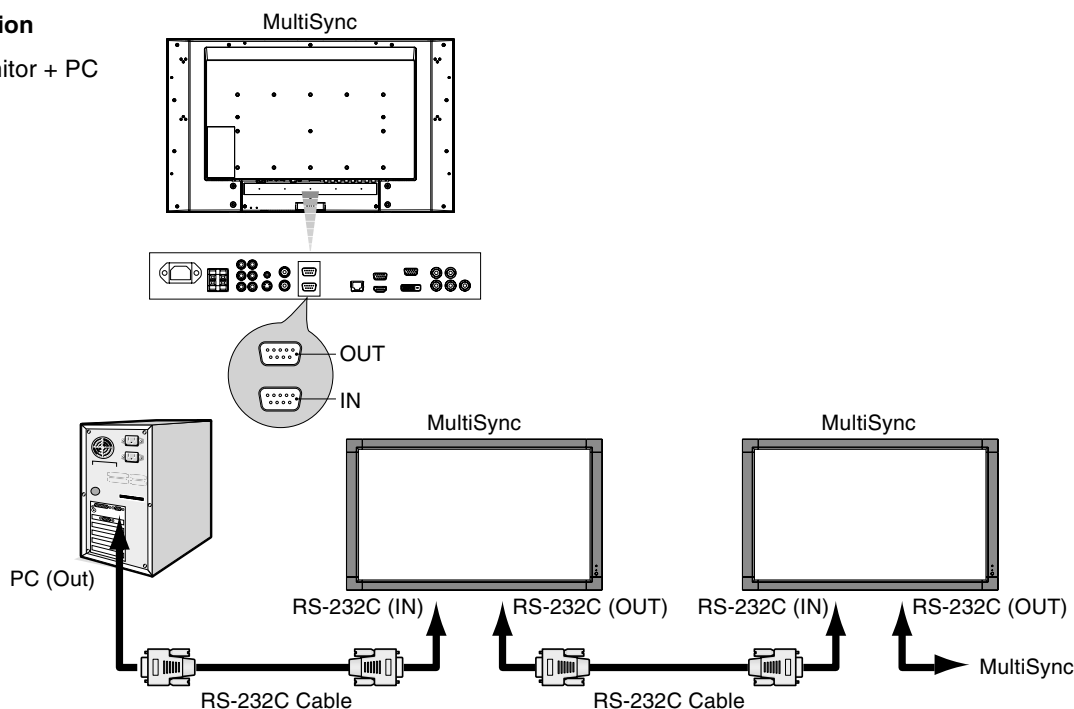

**NOTE:** If your PC is equipped only with a 25-pin serial port connector, a 25-pin serial port adapter is required. Contact your dealer for details.

\* In order to function, the RS-232C OUT terminal can only be connected to another monitor of the same model. Do not connect to other types of equipment.

To control monitor or multiple monitors that are daisy-chained together please use the control command. Instructions for the control command can be found on the CD included with the display. The file is called "External\_control\_\*\*\*\*.pdf".

## 1) Interface

PROTOCOL	RS-232C
BAUD RATE	9600 [bps]
DATA LENGTH	8 [bits]
PARITY BIT	NONE
STOP BIT	1 [bit]
FLOW CONTROL	NONE

This LCD monitor uses RXD, TXD and GND lines for RS-232C control.

The reverse type cable (null modem cable) (not include) should be used for RS-232C control.

## 2) Control command diagram

Please see file "External\_Control\_\*\*\*\*.pdf" on the CD-ROM.

# Controlling the LCD monitor via LAN Control (V321 and V461 only)

## Connecting to a Network

Using a LAN cable allows you to specify the Network Settings and the Alert Mail Settings by using an HTTP server function.

**NOTE:** When you use this function, EXTERNAL CONTROL should be "LAN" (See page 21).

To use a LAN connection, you are required to assign an IP address.

**Example of LAN connection:**

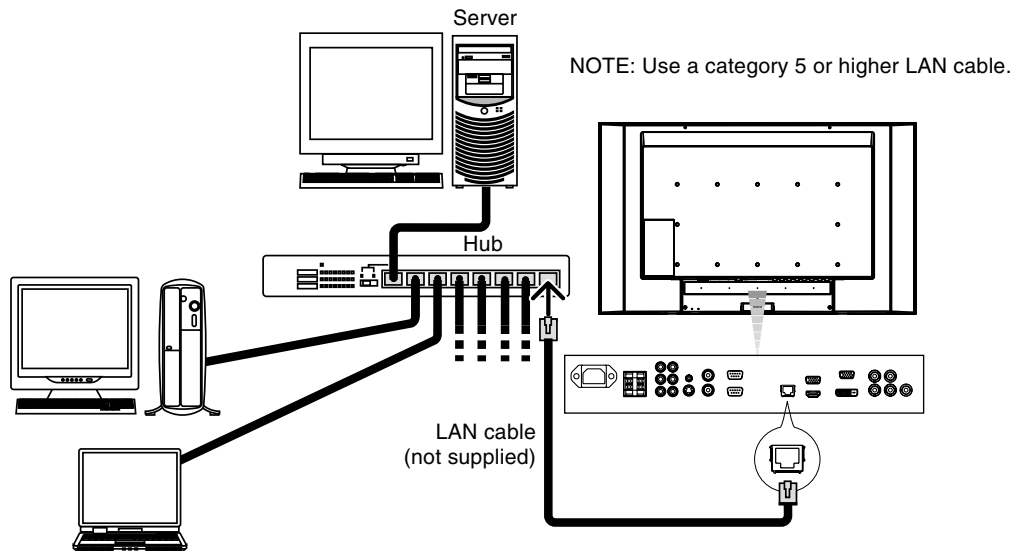

## Network Setting by Using an HTTP Browser

### Overview

Connecting the monitor to a network allows for monitor control from a computer via the network.

To perform the monitor control from a web browser, you must have an exclusive application installed on your computer.

The IP address and subnet mask of the monitor can be set on the Network Setting screen of the web browser by using an HTTP server function. Please be sure to use "Microsoft Internet Explorer 6.0" or a higher version for the web browser. (This device uses "JavaScript" and "Cookies" and the browser should be set to accept these functions. The setting method will vary depending on the version of browser. Please refer to the help files and the other information provided in your software.)

Access is gained to the HTTP server function by starting the Web browser on the computer via the network connected to the monitor and entering the following URL.

### Network Setting

`http://<the Monitor's IP address>/index.html`

**TIP:** The default IP address is "192.168.0.10".  
The exclusive application can be downloaded from our website.

**NOTE:** If the MONITOR NETWORK SETTINGS screen does not appear in the web browser, press the Ctrl+F5 keys to refresh your web browser (or clear the cache).

The display or button's response can be slowed down or operation may not be accepted depending the settings of your network.

Should this happen, consult your network administrator.

The LCD monitor may not respond if its buttons are repeatedly pressed in rapid intervals. Should this happen, wait a moment and repeat.

If you still can't get a response, turn off and back on the monitor.



## Alert Mail Setting

http://<the Monitor's IP address>/lanconfig.html

MONITOR NETWORK SETTINGS	
ITEM	VALUE
DOMAIN	
HOST NAME	<input type="text"/>
DOMAIN NAME	<input type="text"/>
MAIL	
ALERT MAIL	<input type="radio"/> ENABLE <input checked="" type="radio"/> DISABLE
SENDER'S ADDRESS	<input type="text"/>
SMTP SERVER NAME	<input type="text"/>
RECIPIENT'S ADDRESS 1	<input type="text"/>
RECIPIENT'S ADDRESS 2	<input type="text"/>
RECIPIENT'S ADDRESS 3	<input type="text"/>
<input type="button" value="APPLY"/>	
TEST MAIL	
<input type="button" value="EXECUTE"/>	<input type="text"/>
STATUS	
<input type="text"/>	

Copyright (C) NEC Display Solutions, Ltd. 2008. All rights reserved.

This option notifies your computer of an error message via e-mail when using wired LAN. An error message notification will be sent when an error occurs in the monitor.

HOST NAME	Type in the hostname of the network connected to the monitor. Up to 60 alphanumeric characters can be used.
DOMAIN NAME	Type in the domain name of the network connected to the monitor. Up to 60 alphanumeric characters can be used.
ALERT MAIL	Checking [ENABLE] will turn on the Alert Mail feature. Checking [DISABLE] will turn off the Alert Mail feature.
SENDER'S ADDRESS	Type in the senders address. Up to 60 alphanumeric and symbols characters can be used.
SMTP SERVER NAME	Type in the SMTP server name to be connected to the monitor. Up to 60 alphanumeric characters can be used.
RECIPIENT'S ADDRESS 1 to 3	Type in your recipient's address. Up to 60 alphanumeric and symbols characters can be used.
APPLY	Click this button to reflect the above settings.
EXECUTE	Click this button to send a test mail to check if your settings are correct.
STATUS	A reply to a test mail will be displayed.

- NOTE:**
- If you execute a test, you may not receive an Alert mail.  
Should this happen, check if the network settings are correct.
  - If you entered an incorrect address in a test, you may not receive an Alert mail.  
Should this happen, check if the Recipient's Address is correct.

**TIP:** The Alert Mail settings will not be affected even when [RESET] is done from the menu.  
For Control command diagram, please see file "External\_Control.pdf" on the CD-ROM.

# Features

---

**Reduced Footprint:** Provides the ideal solution for environments requiring superior image quality but with size and weight limitations.

**Color Control Systems:** Allows you to adjust the colors on your screen and customize the color accuracy of your monitor to a variety of standards.

**sRGB Color Control:** A new optimized color management standard which allows for color matching on computer displays and other peripherals. The sRGB standard, which is based on a calibrated color space, allows for optimal color representation and backward compatibility with other common color standards.

**OSD (On-Screen-Display) Controls:** Allow you to quickly and easily adjust all elements of your screen image via simple to use on-screen menus.

**Plug and Play:** The Microsoft® solution with the Windows® operating system facilitates setup and installation by allowing the monitor to send its capabilities (such as screen size and resolutions supported) directly to your computer, automatically optimizing display performance.

**IPM (Intelligent Power Manager) System:** Provides innovative power-saving methods that allow the monitor to shift to a lower power consumption level when on but not in use, saving two-thirds of your monitor energy costs, reducing emissions and lowering the air conditioning costs of the workplace.

**FullScan Capability:** Allows you to use the entire screen area in most resolutions, significantly expanding image size.

**VESA Standard (FDMLv1) Mounting Interface:** Allows users to connect their LCD monitor to any VESA standard (FDMLv1) third party mounting arm or bracket. Allows for the monitor to be mounted on a wall or an arm using any third party compliant device. NEC recommends using mounting interface that comply with TÜV-GS and/or UL1678 standard in North America.

**DVI-D:** The digital-only subset of DVI ratified by the Digital Display Working Group (DDWG) for digital connections between computers and displays. As a digital-only connector, analog support is not provided for a DVI-D connector. As a DVI-based digital only connection, only a simple adapter is necessary for compatibility between DVI-D and other DVI-based digital connectors such as DFP and P&D. The DVI interface of this display supports HDCP.

**TILE MATRIX, TILE COMP:** Shows one image over multiple screens with accuracy while compensating for bezel width.

**ZOOM:** Expands image size for horizontal and vertical direction.

**Self-diagnosis:** If an internal error should occur, a failure state will be indicated.

# Troubleshooting

## No picture

- The signal cable should be completely connected to the display card/computer.
- The display card should be completely seated in its slot.
- Front Power Switch and computer power switch should be in the ON position.
- Check to make sure that a supported mode has been selected on the display card or system being used. (Please consult display card or system manual to change graphics mode.)
- Check the monitor and your display card with respect to compatibility and recommended settings.
- Check the signal cable connector for bent or pushed-in pins.

## Power Button does not respond

- Unplug the power cord of the monitor from the AC outlet to turn off and reset the monitor.

## Image persistence

- Please be aware that LCD Technology may experience a phenomenon known as Image Persistence. Image Persistence occurs when a residual or "ghost" image of a previous image remains visible on the screen. Unlike CRT monitors, LCD monitors' image persistence is not permanent, but constant images being displayed for a long period of time should be avoided. To alleviate image persistence, turn off the monitor for as long as the previous image was displayed. For example, if an image was on the monitor for one hour and a residual image remains, the monitor should be turned off for one hour to erase the image.

**NOTE:** As with all personal display devices, NEC DISPLAY SOLUTIONS recommends displaying moving images and using a moving screen saver at regular intervals whenever the screen is idle or turning off the monitor when not in use.

## Image is unstable, unfocused or swimming is apparent

- Signal cable should be completely attached to the computer.
- Use the OSD Image Adjust controls to focus and adjust display by increasing or decreasing the fine adjustment. When the display mode is changed, the OSD Image Adjust settings may need to be re-adjusted.
- Check the monitor and your display card with respect to compatibility and recommended signal timings.
- If your text is garbled, change the video mode to non-interlace and use 60Hz refresh rate.

## Image of component signal is greenish

- Check to see if the DVD/HD input connector is selected.

## LED on monitor is not lit

### (no green or red color can be seen)

- Power Switch should be in the ON position and power cord should be connected.
- Make certain the computer is not in a power-saving mode (touch the keyboard or mouse).

## RED LED on monitor is blinking

- A certain failure might have occurred, please contact your nearest authorized NEC DISPLAY SOLUTIONS service facility.

## Display image is not sized properly

- Use the OSD Image Adjust controls to increase or decrease the coarse adjustment.
- Check to make sure that a supported mode has been selected on the display card or system being used. (Please consult display card or system manual to change graphics mode.)

## Selected resolution is not displayed properly

- Use OSD Display Mode to enter Information menu and confirm that the appropriate resolution has been selected. If not, select corresponding option.

## No Sound

- Check to see if speaker cable is properly connected.
- Check to see if mute is activated.
- Check to see if volume is set at minimum.

## Remote Control is not available

- Check the Remote Control's batteries status.
- Check if batteries are inserted correctly.
- Check if the Remote Control is pointing at the monitor's remote sensor.
- Check the Remote Control (IR Control) Mode status.
- The remote control system may not function when direct sunlight or strong illumination strikes the remote control sensor of the LCD monitor, or when there is an object in the path.

## "SCHEDULE"/"OFF TIMER" function is not working properly

- The "SCHEDULE" function will be disabled when the "OFF TIMER" is set.
- If the "OFF TIMER" function is enabled and the power to the LCD monitor is turned off when the power supply is interrupted unexpectedly, then the "OFF TIMER" will be reset.

## RS-232C or LAN control is not available

- Check RS-232C or LAN cable connection.
- Check "CONTROL" setting in "EXTERNAL CONTROL".

Either light vertical or horizontal stripes may appear, depending on the specific display pattern. This is no product fault or degradation.

# Specifications - V321

## Product Specifications

LCD Module		Pixel Pitch:	32"/80.0 cm diagonal
		Resolution:	0.511 mm
		Color:	1366 x 768 dots
		Brightness:	Over 16 million colors (depending on video card used)
		Contrast Ratio:	450 cd/m <sup>2</sup> (Typ.)
		Viewing Angle:	3000:1
		Design View Distance:	89° (typ) @ CR>10
			875 mm
Frequency		Horizontal:	15.625/15.734 kHz, 31.5 kHz - 91.1 kHz
		Vertical:	50.0 - 85.0 Hz
Pixel Clock		25.0 MHz - 165.0 MHz	
Viewable Size		697.7 x 392.3 mm	
Input Signal			
DVI	DVI-D 24pin	Digital RGB	DVI (HDCP) VGA60, SVGA60, XGA60, WXGA60, SXGA60*, UXGA60*, 1920 x 1080*1 (60Hz)
VGA	15pin Mini D-sub	Analog RGB	0.7 Vp-p/75 ohm VGA60, SVGA60, XGA60, WXGA60, SXGA60*, UXGA60*, 1920 x 1080*1 (60Hz)
		Sync	Separate: TTL level (Pos./Neg.)
RGB/HV*2	BNC (R,G,B,H,V)	Analog RGB	0.7 Vp-p/75 ohm VGA60, SVGA60, XGA60, WXGA60, SXGA60*, UXGA60*, 1920 x 1080*1 (60Hz)
		Sync	Separate: TTL level (Pos./Neg.)
HDMI	HDMI Connector	Digital RGB	HDMI 1080p, 1080i, 720p@50Hz/60Hz, 576p@50Hz, 480p@60Hz
DVD/HD*2	BNC (Y, Cb/Pb, Cr/Pr)	Component	Y: 1.0 Vp-p/75ohm, Cb/Cr (Pb/Pr): 0.7 Vp-p/75 ohm HDTV/DVD: 1080i@60Hz*1, 1080p@60Hz*1, 720p@50Hz/60Hz, 576p@50Hz, 480p@60Hz, 576i@50Hz, 480i@60Hz
S-VIDEO	Mini DIN 4 pin	S-VIDEO	Y: 1.0 Vp-p/75 ohm C: 0.286 Vp-p/75 ohm (NTSC), 0.3 Vp-p/75 ohm (PAL/SECAM) NTSC/PAL/SECAM/4.43NTSC/PAL60
VIDEO1 VIDEO2*2	BNC BNC	Composite	1.0 Vp-p/75 ohm NTSC/PAL/SECAM/4.43NTSC/PAL60
Output Signal			
RGB	15pin Mini D-sub	Analog RGB	0.7 Vp-p with 75 ohm terminated Separate HV sync: TTL level (Pos. / Neg.)
VIDEO	BNC	Composite	1.0 Vp-p with 75 ohm terminated
AUDIO			
AUDIO Input	RCA (L/R) X2 STEREO Mini Jack	Analog Audio	Stereo L/R 0.5 Vrms
AUDIO Output	RCA (L/R)	Analog Audio	Stereo L/R 0.5 Vrms
Speaker Output		External Speaker Jack 7 W + 7 W (8 ohm)	
Control		RS-232C In:	9 Pin D-sub
		RS-232C Out:	9 Pin D-sub (with daisy chain)
		LAN:	RJ-45 10/100 BASE-T
Power Supply		1.4 - 0.6 A @ 100-240VAC, 50/60Hz	
Operational Environment		Temperature:	5 - 40°C (landscape), 5 - 35°C (portrait)
		Humidity:	20 - 80% (without condensation)
		Altitude:	0 - 3000 m
Storage Environment		Temperature:	-20 - 60°C
		Humidity:	10 - 90% (without condensation)/ 90% - 3.5% x (Temp - 40°C) regarding over 40°C
Dimension		Net:	789 (W) x 476.3 (H) x 133 (D) mm
Weight		14.3 kg/31.5 lbs	
VESA compatible arm mounting interface		200 mm x 200 mm (4 Holes)	
Power Management		VESA DPM	
Plug & Play		VESA DDC2B, DDC/CI	
Accessories		Setup manual, Power Cord, Video Signal Cable, Remote Control, AAA Battery x 2, Clamp x 2, Screw for Main switch cover x 2, Screw for Clamp x 2, CD-ROM, Main switch cover	

**NOTE:** Technical specifications are subject to change without notice.

\*1: Compressed image  
\*2: Exclusive use



# Specifications - V461

## Product Specifications

LCD Module		Pixel Pitch:	46"/116.8 cm diagonal
		Resolution:	0.530 mm
		Color:	1920 x 1080 dots
		Brightness:	Over 16 million colors (depending on video card used)
		Contrast Ratio:	450 cd/m <sup>2</sup> (Typ.)
		Viewing Angle:	3000:1
		Design View Distance:	89° (typ) @ CR>10
			1300 mm
Frequency		Horizontal:	15.625/15.734 kHz, 31.5 kHz - 91.1 kHz
		Vertical:	50.0 - 85.0 Hz
Pixel Clock			25.0 MHz - 165.0 MHz
Viewable Size			1018.08 x 572.67 mm
Input Signal			
DVI	DVI-D 24pin	Digital RGB	DVI (HDCP) VGA60, SVGA60, XGA60, WXGA60, SXGA60, UXGA60*1, 1920 x 1080 (60Hz)
VGA	15pin Mini D-sub	Analog RGB	0.7 Vp-p/75 ohm VGA60, SVGA60, XGA60, WXGA60, SXGA60, UXGA60*1, 1920 x 1080 (60Hz)
		Sync	Separate: TTL level (Pos./Neg.)
RGB/HV*2	BNC (R,G,B,H,V)	Analog RGB	0.7 Vp-p/75 ohm VGA60, SVGA60, XGA60, WXGA60, SXGA60, UXGA60*1, 1920 x 1080 (60Hz)
		Sync	Separate: TTL level (Pos./Neg.)
HDMI	HDMI Connector	Digital RGB	HDMI 1080p, 1080i, 720p@50Hz/60Hz, 576p@50Hz, 480p@60Hz
DVD/HD*2	BNC (Y, Cb/Pb, Cr/Pr)	Component	Y: 1.0 Vp-p/75ohm, Cb/Cr (Pb/Pr): 0.7 Vp-p/75 ohm HDTV/DVD: 1080i@60Hz*1, 1080p@60Hz*1, 720p@50Hz/60Hz, 576p@50Hz, 480p@60Hz, 576i@50Hz, 480i@60Hz
S-VIDEO	Mini DIN 4 pin	S-VIDEO	Y: 1.0 Vp-p/75 ohm C: 0.286 Vp-p/75 ohm (NTSC), 0.3 Vp-p/75 ohm (PAL/SECAM) NTSC/PAL/SECAM/4.43NTSC/PAL60
VIDEO1	BNC	Composite	1.0 Vp-p/75 ohm NTSC/PAL/SECAM/4.43NTSC/PAL60
VIDEO2*2	BNC		
Output Signal			
RGB	15pin Mini D-sub	Analog RGB	0.7 Vp-p with 75 ohm terminated Separate HV sync: TTL level (Pos. / Neg.)
VIDEO	BNC	Composite	1.0 Vp-p with 75 ohm terminated
AUDIO			
AUDIO Input	RCA (L/R) X2 STEREO Mini Jack	Analog Audio	Stereo L/R 0.5 Vrms
AUDIO Output	RCA (L/R)	Analog Audio	Stereo L/R 0.5 Vrms
Speaker Output			External Speaker Jack 7 W + 7 W (8 ohm)
Control		RS-232C In:	9 Pin D-sub
		RS-232C Out:	9 Pin D-sub (with daisy chain)
		LAN:	RJ-45 10/100 BASE-T
Power Supply			2.4 - 1.0 A @ 100-240VAC, 50/60Hz
Operational Environment		Temperature:	5 - 40°C (landscape), 5 - 35°C (portrait)
		Humidity:	20 - 80% (without condensation)
		Altitude:	0 - 3000 m
Storage Environment		Temperature:	-20 - 60°C
		Humidity:	10 - 90% (without condensation)/ 90% - 3.5% x (Temp - 40°C) regarding over 40°C
Dimension		Net:	1121.5 (W) x 664.7 (H) x 129.8 (D) mm
Weight			24.0 kg/52.9 lbs
VESA compatible arm mounting interface			200 mm x 200 mm (4 Holes)
Power Management			VESA DPM
Plug & Play			VESA DDC2B, DDC/CI
Accessories			Setup manual, Power Cord, Video Signal Cable, Remote Control, AAA Battery x 2, Clamp x 2, Screw for Main switch cover x 2, Screw for Clamp x 2, CD-ROM, Main switch cover

**NOTE:** Technical specifications are subject to change without notice.

\*1: Compressed image

\*2: Exclusive use

# Specifications - LCD4215<sub>(R)</sub>

## Product Specifications

LCD Module		Pixel Pitch:	42"/106.7 cm diagonal
		Resolution:	0.681 mm
		Color:	1366 x 768 dots
		Brightness:	Over 16 million colors (depending on video card used)
		Contrast Ratio:	500 cd/m <sup>2</sup> (Typ.)
		Viewing Angle:	800:1
		Design View Distance:	89° (typ) @ CR>10
			1100 mm
Frequency		Horizontal:	15.625/15.734 kHz, 31.5 kHz - 91.1 kHz
		Vertical:	50.0 - 85.0 Hz
Pixel Clock		25.0 MHz - 165.0 MHz	
Viewable Size		930.25 x 523.01 mm	
Input Signal			
DVI	DVI-D 24pin	Digital RGB	DVI (HDCP) VGA60, SVGA60, XGA60, WXGA60, SXGA60 <sup>*1</sup> , UXGA60 <sup>*1</sup> , 1920 x 1080 <sup>*1</sup> (60Hz)
VGA	15pin Mini D-sub	Analog RGB	0.7 Vp-p/75 ohm VGA60, SVGA60, XGA60, WXGA60, SXGA60 <sup>*1</sup> , UXGA60 <sup>*1</sup> , 1920 x 1080 <sup>*1</sup> (60Hz)
		Sync	Separate: TTL level (Pos./Neg.)
RGB/HV <sup>*2</sup>	BNC (R,G,B,H,V)	Analog RGB	0.7 Vp-p/75 ohm VGA60, SVGA60, XGA60, WXGA60, SXGA60 <sup>*1</sup> , UXGA60 <sup>*1</sup> , 1920 x 1080 <sup>*1</sup> (60Hz)
		Sync	Separate: TTL level (Pos./Neg.)
HDMI	HDMI Connector	Digital RGB	HDMI 1080p, 1080i, 720p@50Hz/60Hz, 576p@50Hz, 480p@60Hz
DVD/HD <sup>*2</sup>	BNC (Y, Cb/Pb, Cr/Pr)	Component	Y: 1.0 Vp-p/75ohm, Cb/Cr (Pb/Pr): 0.7 Vp-p/75 ohm HDTV/DVD: 1080i@60Hz <sup>*1</sup> , 1080p@60Hz <sup>*1</sup> , 720p@50Hz/60Hz, 576p@50Hz, 480p@60Hz, 576i@50Hz, 480i@60Hz
S-VIDEO	Mini DIN 4 pin	S-VIDEO	Y: 1.0 Vp-p/75 ohm C: 0.286 Vp-p/75 ohm (NTSC), 0.3 Vp-p/75 ohm (PAL/SECAM) NTSC/PAL/SECAM/4.43NTSC/PAL60
VIDEO1 VIDEO2 <sup>*2</sup>	BNC BNC	Composite	1.0 Vp-p/75 ohm NTSC/PAL/SECAM/4.43NTSC/PAL60
Output Signal			
RGB	15pin Mini D-sub	Analog RGB	0.7 Vp-p with 75 ohm terminated Separate HV sync: TTL level (Pos. / Neg.)
VIDEO	BNC	Composite	1.0 Vp-p with 75 ohm terminated
AUDIO			
AUDIO Input	RCA (L/R) X2 STEREO Mini Jack	Analog Audio	Stereo L/R 0.5 Vrms
AUDIO Output	RCA (L/R)	Analog Audio	Stereo L/R 0.5 Vrms
Speaker Output		External Speaker Jack 7 W + 7 W (8 ohm)	
Control		RS-232C In:	9 Pin D-sub
		RS-232C Out:	9 Pin D-sub (with daisy chain)
Power Supply		2.1 - 0.85 A @ 100-240VAC, 50/60Hz	
Operational Environment		Temperature:	5 - 40°C (landscape), 5 - 35°C (portrait)
		Humidity:	20 - 80% (without condensation)
		Altitude:	0 - 3000 m
Storage Environment		Temperature:	-20 - 60°C
		Humidity:	10 - 90% (without condensation)/ 90% - 3.5% x (Temp - 40°C) regarding over 40°C
Dimension		Net:	1022.9 (W) x 613.5 (H) x 133 (D) mm
Weight		21.6 kg/47.6 lbs	
VESA compatible arm mounting interface		200 mm x 200 mm (4 Holes)	
Power Management		VESA DPM	
Plug & Play		VESA DDC2B, DDC/CI	
Accessories		Setup manual, Power Cord, Video Signal Cable, Remote Control, AAA Battery x 2, Clamp x 2, Screw for Main switch cover x 2, Screw for Clamp x 2, CD-ROM, Main switch cover	

**NOTE:** Technical specifications are subject to change without notice.

\*1: Compressed image  
\*2: Exclusive use

# Pin Assignment

RS-232C input

Pin No	Name
1	connected to 7&8
2	RXD
3	TXD
4	connected to 6
5	GND
6	connected to 4
7	connected to 1&8
8	connected to 1&7
9	NC

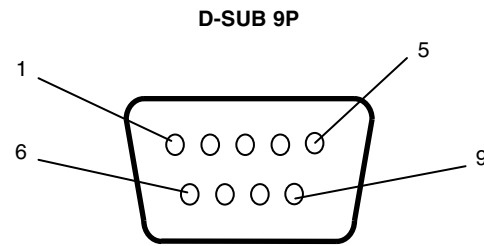

This LCD monitor uses RXD, TXD and GND lines for RS-232C control.

# Manufacturer's Recycling and Energy Information

NEC DISPLAY SOLUTIONS is strongly committed to environmental protection and sees recycling as one of the company's top priorities in trying to minimize the burden placed on the environment. We are engaged in developing environmentally-friendly products, and always strive to help define and comply with the latest independent standards from agencies such as ISO (International Organisation for Standardization) and TCO (Swedish Trades Union).

## Disposing of your old NEC product

The aim of recycling is to gain an environmental benefit by means of re-use, upgrading, reconditioning or reclamation of material. Dedicated recycling sites ensure that environmentally harmful components are properly handled and securely disposed. To ensure the best recycling of our products, **NEC DISPLAY SOLUTIONS offers a variety of recycling procedures** and gives advice on how to handle the product in an environmentally sensitive way, once it has reached the end of its life.

All required information concerning the disposal of the product and country-specific information on recycling facilities can be found on our following websites:

<http://www.nec-display-solutions.com/greencompany/> (in Europe),

<http://www.nec-display.com> (in Japan) or

<http://www.necdisplay.com> (in USA).

## Energy Saving

This monitor features an advanced energy saving capability. When a VESA Display Power Management Signalling (DPMS) Standard signal is sent to the monitor, the Energy Saving mode is activated. The monitor enters a single Energy Saving mode.

Power consumption		LED colour
Max (with optional speaker)	140 W (V321) 240 W (V461) 210 W (LCD4215 <sub>(R)</sub> )	Green
Normal Operation (without optional speaker, with factory settings)	100 W (V321) 185 W (V461) 160 W (LCD4215 <sub>(R)</sub> )	Green
Energy Saving Mode*	Less than 2 W	Red and Green
Off Mode	Less than 1 W	Red

\* "RS-232C" is selected in EXTERNAL CONTROL for V321/V461.

## WEEE Mark (European Directive 2002/96/EC)

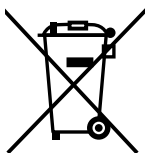

### Within the European Union

EU-wide legislation, as implemented in each Member State, requires that waste electrical and electronic products carrying the mark (left) must be disposed of separately from normal household waste. This includes monitors and electrical accessories, such as signal cables or power cords. When you need to dispose of your NEC display products, please follow the guidance of your local authority, or ask the shop where you purchased the product, or if applicable, follow any agreements made between yourself and NEC.

The mark on electrical and electronic products only applies to the current European Union Member States.

### Outside the European Union

If you wish to dispose of used electrical and electronic products outside the European Union, please contact your local authority so as to comply with the correct disposal method.

## Free Manuals Download Website

<http://myh66.com>

<http://usermanuals.us>

<http://www.somanuals.com>

<http://www.4manuals.cc>

<http://www.manual-lib.com>

<http://www.404manual.com>

<http://www.luxmanual.com>

<http://aubethermostatmanual.com>

Golf course search by state

<http://golfingnear.com>

Email search by domain

<http://emailbydomain.com>

Auto manuals search

<http://auto.somanuals.com>

TV manuals search

<http://tv.somanuals.com>